

2nd Edition

Neighborhood Cats

TNR Handbook

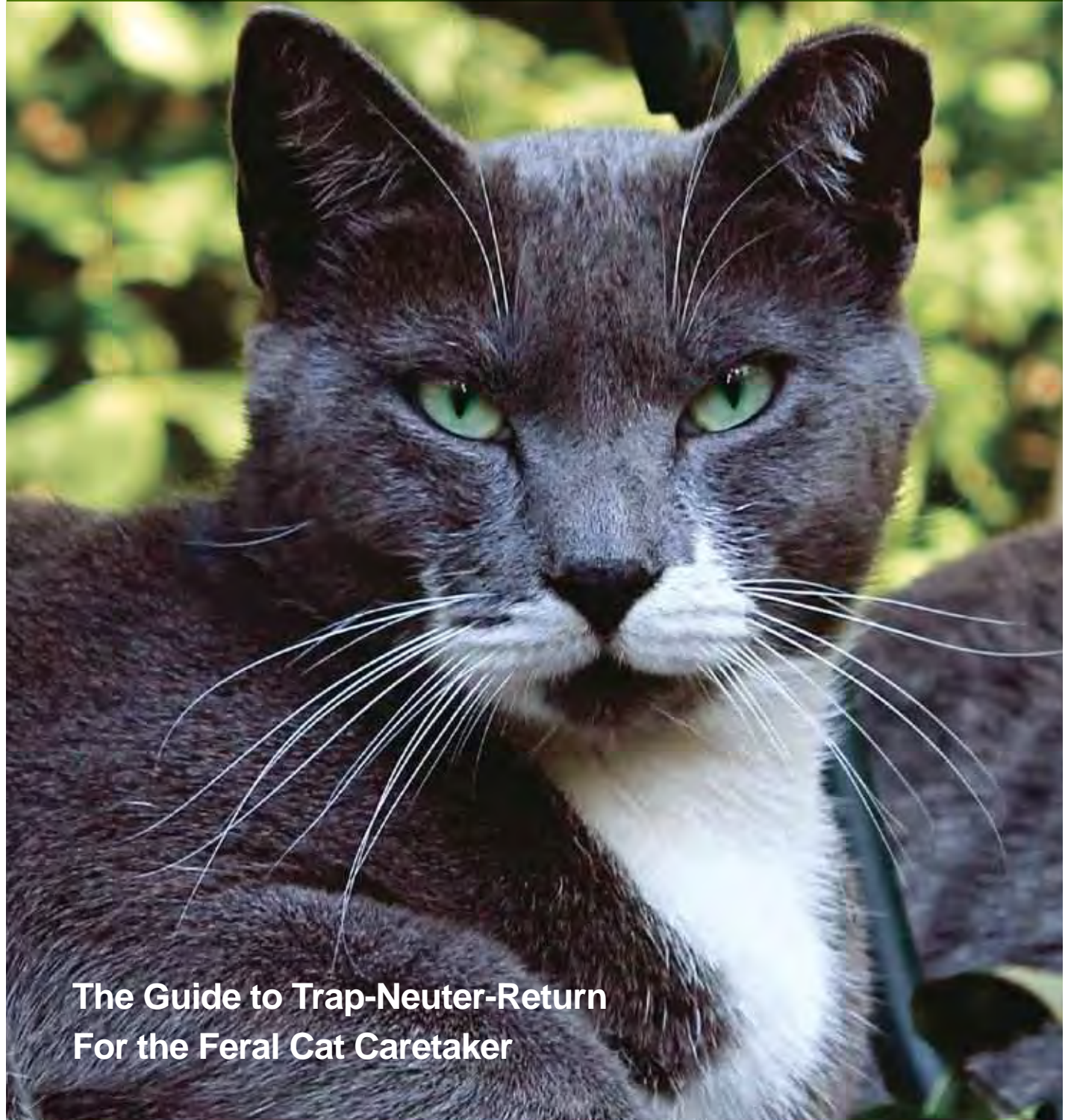

**The Guide to Trap-Neuter-Return
For the Feral Cat Caretaker**

Neighborhood Cats TNR Handbook

2nd edition

*The Guide to Trap-Neuter-Return
for the Feral Cat Caretaker*



www.neighborhoodcats.org

[find us on Facebook](#)

[@NbrhoodCats](#)

Text by: Bryan Kortis

Additional text by: Susan Richmond, Meredith Weiss, Anitra Frazier, joE. Needham,
Lois McClurg & Laura Gay Senk

Cover photo by: Petr Salidar

Photos by: Meredith Weiss, Bryan Kortis & feral cat caretakers (as credited)

Special thanks to: Nancy Peterson, Cat Programs Manager, The Humane Society of the
United States

Neighborhood Cats, Inc. © 2013

The contents of this book may be copied or distributed in whole or in part for educational purposes or personal use, except in the City of New York, NY. In the City of New York, NY, contents of this book may not be copied or distributed for any purpose without the express written consent of Neighborhood Cats, Inc. With respect to any organization or individual, permission to copy or distribute may be withdrawn at any time within the sole discretion of Neighborhood Cats, Inc. Please contact us for further information. Except as specified herein, all rights are reserved.

Table of Contents

Foreword <i>by Susan Richmond</i>	1
Introduction <i>by Anitra Frazier</i>	3
Chapter One: What is a Feral Cat?	4
Chapter Two: What is Trap-Neuter-Return?	6
The advantages of TNR – colony level	6
The advantages of TNR - community level	7
Failed alternatives to TNR	9
1. Trap and remove	9
2. Feeding bans	10
3. Rescue or relocation	11
4. Do nothing	12
Chapter Three: The TNR Process – An Overview	13
Chapter Four: Building Good Community Relations	16
Community development techniques	17
1. Walk and talk	17
2. Deal calmly with hostility and resistance	17
3. Hold community meetings	18
4. Send a community appeal letter	19
5. Post informational flyers	19
6. Change municipal laws and animal control policies	20
Poisoning threats	20
Fleas	21
Keeping cats out of gardens & yards	22
1. Deterrents	23
2. Containment systems	26
Chapter Five: Food & Water	28
Feeding stations	28
Feeding tricks	32
Preventing water from freezing	34
Preventing food from freezing	36
Nutrition	37
Vitamin C to the Rescue <i>by Anitra Frazier</i>	40
Preventing urinary tract disease	43

Chapter Six: Winter Shelter	44
Types of shelters	45
Doorway flaps	49
Insulating materials	49
Extreme cold	50
Placement	50
Chapter Seven: Preparations for Trapping – the Sequence	51
Chapter Eight: Recommended Equipment	57
Box traps	57
Drop traps	61
Trap dividers	62
Kitten screen	63
Feral cat dens	64
Transfer cages	65
Chapter Nine: Trapping	67
Mass trapping	67
Trapping supplies – the basics	68
Trapping supplies – optional	69
The trapping	70
1. Withhold food	70
2. Allow enough time for trapping	71
3. Check the traps	72
4. Prepare the traps	73
5. Place the traps in the territory	73
6. During the trapping	75
Winter trapping	78
Transfers from traps	79
Special cases	79
1. Friendly ferals	79
2. Kittens	80
3. Nursing mothers	82
4. Pregnant cats	87
Wildlife	88
Raccoons	89
Skunks	90
Opossums	90
Hard-to-catch cats	91
Drop trap	91
Train the cat to enter a box trap	92
Camouflage trap	93
Lure into a closed space	93
Picking one out from the crowd	94
Cats who avoid the trip plate	95
Cleaning traps & equipment	95

Chapter Ten: The Neighborhood Cats Drop Trap	97
Preparations	98
Setting up the trap	98
Dropping the trap	101
Transferring out of the drop trap	101
Disassembling the trap	103
Chapter Eleven: Caring for Cats in Traps	104
Materials needed	105
Preparing the holding space	105
Feeding and cleaning	106
What if a cat does escape?	108
Chapter Twelve: The Feral Cat Setup: Long-term Fosters	109
Materials needed	109
Placing the cat inside	110
Feeding and cleaning	111
Chapter Thirteen: Spay/Neuter & Veterinary Care	113
Preparing for surgery	113
Types of veterinary treatment	115
Eartipping	117
Post-surgery	119
FIV/FeLV testing	120
Chapter Fourteen: Recovery & Return	125
Length of recovery period	125
Lactating mother	126
Location of release	126
Chapter Fifteen: Relocation & Sanctuaries	127
Relocation	127
Sanctuaries	131
Chapter Sixteen: Adoptable Cats	133
Determining if a cat is adoptable	133
Lost or abandoned pet cats	133
Feral kittens	135
Friendly adult ferals	136
Veterinary care for adoptable cats	136
Socializing feral kittens	137
Socializing feral teenagers & adults	139
Finding good homes	142

Chapter Seventeen: Storm Preparation & Recovery	147
Before the storm	147
The aftermath	148
Chapter Eighteen: Feral Cat Resources	150
Books	150
Children’s books	150
Equipment & supplies	151
Feral cat organizations – lists	151
Funding for TNR	151
Handouts & flyers	152
Kitten care	153
Spay/neuter resources	153
TNR ordinances	153
Tool kits	154
Videos	154
Webinars	154
Appendices	
Stop poisoning poster	155
How to build the Neighborhood Cats Winter Shelter	156
TNR trapping log	160

Foreword



One of the first ferals I ever met was a cat named Apollo. Before that, working in a spay/neuter clinic, I'd seen multitudes of other feral cats but they were different. Those were quiet little figures huddled in traps, doing their best to make themselves invisible. Apollo, on his home turf, was a personality and a presence. He'd prowl his colony's territory, a rusty, overgrown lot in the heart of the city, slipping from patches of tall grass to the lot's lone twisted tree then back to leap easily onto the old brick wall bordering the end of the property. Sometimes he'd bask on the sun-warmed bricks. Thoroughly feral, Apollo never let humans come near but he went about his business in a purposeful, dignified way, leaving no doubt he knew he was in charge of his life and liked it that way.

Apollo was born in 1999, the year Neighborhood Cats started. In those days there were no services in New York City to manage free-roaming cat populations and little awareness, even among animal care professionals, of what defined a feral. If you were a cat born outdoors and wary of humans, you were pretty much on your own. Maybe you'd find a nice person to feed you but Trap-Neuter-Return (TNR) was still little known so your likely fate would be a constant struggle for survival and a lot of kittens left behind on the streets. If you were brought to the city shelter, your chances of coming out alive were near zero.

The introduction of Trap-Neuter-Return by Neighborhood Cats began to change all that. To many, the notion of catching cats, fixing them and then putting them *back* outside was puzzling, even startling, but results were dramatic. Within a few years, managed colonies like Apollo's dotted the city. Blocks and neighborhoods, where skinny, weepy-eyed kittens had been ever-present, had no more kittens. The cats were healthier. The 3:00 am screeching and fighting over mates, pungent tomcat urine and other nuisances that upset and angered residents were quietly gone.

TNR had arrived, but for all its advantages, several more years would pass before a strong citywide network was in place. Across the country, similar advances were underway. Communities, from tiny specks of towns to major metro areas, were exploring this new method that finally offered hope for forgotten animals. Neighborhood Cats led the way with programs and innovations that steadily fostered the growth of Trap-Neuter-Return in New York City and elsewhere. In 2002, we held our first workshop to teach NYC residents how to safely and effectively practice TNR; Neighborhood Cats TNR Workshops have now trained and certified more than 5,000 residents and each month that number continues to grow. Our website and award-winning materials, including the instructional video *How to Perform a Mass Trapping*, have aided countless caretakers in their efforts to help feral and stray cats. Among our "feral firsts": creation of a humane trap specifically for feral cats, design of a commercially available drop trap, authorship of

an online course on TNR for Humane Society University, development of an online database to track feral cat colonies and help return eartipped cats to their caretakers, and formulation of a model TNR ordinance to guide municipalities nationwide.

In 2006, The Humane Society of the United States, the nation's most influential animal welfare organization, officially endorsed Trap-Neuter-Return, affirming the power of TNR to impact lives for the better. Other national animal welfare groups are also now solidly in support of TNR, including the ASPCA, Best Friends Animal Society, Maddie's Fund and PetSmart Charities. In 2011, as numerous other municipalities have done, the New York City Council made TNR its official policy for managing free-roaming cats. Today, the discussion has shifted from whether TNR should be practiced to how it can be spread most widely and effectively.

These are promising days for community cats. None of this would be possible without the caretakers everywhere who fill the food bowls no matter the weather, bait traps, provide shelter, tame and carefully re-home kittens, and sacrifice their own time and money. A million small acts of kindness have led to the accomplishment of these milestones.

By the time Apollo and I crossed paths, he was a well-fed, well-sheltered, comfortably middle-aged ex-tomcat. He and his colony mates fully enjoyed their lives, in a way that could not have happened without TNR. There are no cats left in the lot now though sometimes when I walk past I can almost see a little black shape basking on sun-dappled bricks. This guide was written in memory of old friends and with hope for the future. It is dedicated to all feral cat caretakers, to help speed the way to a better tomorrow for community cats.

Susan Richmond
Executive Director, Neighborhood Cats
April, 2013

Introduction



photo: Petr Salidar

“If we keep ‘em in a cage, at least they’ll be safe.” This has been the reasoning of numerous well-meaning cat rescuers in the past. Surely the operative words here are “at least” for we would have to admit that, for an animal or a young child or any of us, a lot more than safety is required if anything resembling a normal, healthy life is our goal. Happily, there is a better way, a veritable win-win situation. For feral cats, TNR (Trap-Neuter-Return) is the answer.

My own concept of feral cats was limited by the glimpses I had caught of them over the years. Pitiful, thin creatures with runny eyes and weeping sores. Most of them were sick or lame, scurrying along the alleys or underneath cars parked at the curb. My heart broke but what could I do if the cats wouldn’t even let me come close.

It was Bryan Kortis who explained TNR to me and showed me my first managed feral cat colony. Late on a midwinter afternoon when the temperature was below freezing with ice underfoot and a promise of more snow tomorrow, Bryan led me through a maze of Upper West Side alleys and courtyards, around rows of garbage cans and under rusty fire escapes. I had steeled my mind and emotions for the pitiful sight I knew I was about to witness. Was I ever in for a surprise!

We rounded the last corner into a small courtyard. To my left the space was enclosed by a three-foot stone wall topped by an enormous chain link fence. I scarcely had time to turn to my right, where four large Styrofoam boxes were held up off the ground by stacks of bricks because one second after we rounded that corner, a series of furry bodies exploded out of those boxes, hit the pavement, streaked for the fence, flew up, cleared the top, hit the ground running on the other side and disappeared into the twilight of the alleys beyond. In the four or five seconds that they had been visible, I had seen bright eyes, rich, thick furs, rippling muscles and a feat of athletic prowess I had never imagined possible for a cat. My heart leapt for joy.

“They’re beautiful,” I cried. “They’re healthy and clean and strong.”

“They’re a managed colony,” Bryan replied. He led me over to the Styrofoam boxes. “These are insulated shelters. They cost about twenty-five dollars each. Stick your hand inside. Don’t worry, the cats have all gone.”

I peeled the glove off my icy fingers and reached through the little round door in the side. The box was like an oven!

Now, with this handbook, anyone can manage a feral colony. Everybody’s ferals can be strong and happy and proud. The book is beautifully organized; the instructions are crystal clear and logical.

May your path be as full of wonder and laughter as mine has been ever since that winter evening when I discovered the intriguing world of feral cats.

*Anitra Frazier (author, *The Natural Cat*)*

*October, 2004 [reprinted from the 1st edition of the *Neighborhood Cats TNR Handbook*]*

1. What is a Feral Cat?

A “feral” is a cat who is not socialized and exhibits some degree of wild behavior. Ferals tend to be fearful of people and keep their distance unless it is someone they have come to know and trust. This often makes them difficult to handle and place in adoptive homes. They may be lost or abandoned pets who once had a home but over time have reverted to a wild state or they may be the offspring of former pets, sometimes many generations removed. In contrast, a “stray” is a former pet who, though now without a home, is still socialized. When re-introduced to a domestic setting, a stray will usually quickly display his tame nature.



photo: Meredith Weiss

In recent years, cats who live outside typical household situations and are not considered anyone’s pet, have come to be referred to as “free-roaming cats” or “community cats.” These terms are useful because they focus on the circumstances in which the cats live rather than on individual characteristics like feral vs. stray. In the case of “community cats,” the term also implies there is a collective responsibility for their care.

Most free-roaming or community cats form groups called “colonies.” Most of the cats will tend to be feral, although the mixture of ferals and strays can vary widely. The cats in a colony share the same territory and a common food source. Often they are related, but not always. Colonies can form anywhere there is adequate food and shelter. In urban or suburban areas, they can be found in alleyways, vacant lots, abandoned buildings, warehouses, factories, parks, shopping centers and backyards, to name a few. In rural settings, colonies are often found in barns as well as the back streets of small towns. The vast majority of ferals in these colonies are not completely wild because they rely on people for their food source, whether it’s a dumpster behind a restaurant or a kind neighbor who comes by once a day. Relatively few subsist by hunting alone.

“Feral” is not a biological trait, but a behavioral one. As a result, the same cat can be feral at one point in her life and tame at another. A socialized pet cat, abandoned and left to fend for herself outdoors, may become feral. Likewise, a feral cat, given enough time and attention, may grow tame. Because “feral” describes behavior and socialization, it is not an all or nothing characteristic, but is present in different degrees in different cats. Just how wild a cat is will depend on a combination of four factors:

- **Age**

Age is the most influential factor. Kittens six weeks of age or younger are usually not yet developed enough to be highly feral and can be easily socialized, sometimes with the first touch of a hand. Seven to eight week old kittens may take a few days or more to socialize, but are still young enough in

most cases to tame relatively quickly. Beyond eight weeks, the feral imprint grows increasingly stronger with each passing day, requiring longer and more intensive socialization to reverse. By the age of four months, many kittens, even if they are eventually tamed, will exhibit some feral behavior for the rest of their lives, such as a profound attachment to one person and a fear of others. Beyond five to six months, in most instances a cat born feral will rarely become fully socialized.



photo: Kitty Katz

- **Number of generations feral**

Cats grow wilder with each succeeding feral generation. A colony cat who herself once lived as a pet in a home will tend to be less feral than her offspring while, as another example, a tenth generation feral cat will tend to be wilder than a second generation.

- **Amount of human contact**

The amount of contact a cat has with people on a regular basis is another important factor. A cat who lives in a community garden and has visitors coming every day to talk and play with him will be less feral than a cat who lives in the woods and rarely encounters people.

- **Personality**

Feral cats are individuals and their unique personalities must be taken into account. On occasion, a cat will be friendly towards people despite being beyond kitten age, born of a feral mother and living in a reclusive environment. But the naturally occurring “gregarious feral” is very much the exception, at least prior to spay/neuter. Many caretakers do report that after neutering, some of their feral wards gradually grow friendlier and more approachable, sometimes to the point of becoming adoptable.

Assessing whether a cat is feral and, if so, to what extent, can be helpful in determining the best situation for the feline. If the cat is friendly and can be handled, then adoption is likely the best option if there are foster or permanent homes available. If the cat is feral to a significant degree, then allowing him to live in his own territory with his colony mates could be the most compassionate choice. For further discussion on this question, see the section, “Determining if a cat is adoptable,” in Chapter 16.

2. What is Trap-Neuter-Return?

Trap-Neuter-Return, commonly known as TNR, is a method for humanely and effectively managing cat colonies and reducing free-roaming cat populations. The process involves trapping the cats in a colony, having them spayed and neutered, eartipped for identification and, where appropriate, vaccinated for rabies, then releasing them back into their territory. Whenever possible, friendly adults and kittens young enough to be easily socialized are removed and placed for adoption. A designated caretaker provides regular food and shelter to the returned cats, monitors the colony for newcomers, and mediates any conflicts between the cats and the surrounding community.



photo: Meredith Weiss

TNR offers a number of benefits on both the colony and community levels. As a TNR activist, it's wise to become knowledgeable about these advantages and be able to articulate them whenever necessary. TNR is still a relatively new concept and many people don't understand why it's a good idea to put the cats back where you found them. So let them know!

TNR offers a number of benefits on both the colony and community levels. As a TNR activist, it's wise to become knowledgeable about these advantages and be able to articulate them whenever necessary. TNR is still a relatively new concept and many people don't understand why it's a good idea to put the cats back where you found them. So let them know!

• The advantages of TNR – colony level

For a particular colony, getting the cats spayed and neutered has the following advantages for their neighborhood:

- 1. No more kittens and a gradually falling population.** If all the cats are fixed, or at least all the females, no more litters will be born. If newcomers to the colony are quickly trapped and altered or adopted out, the size of the colony should decline over time.
- 2. Noise is dramatically reduced.** Most of the noise from an unmanaged colony comes from activity related to mating, such as yowling and fighting – behaviors which are greatly reduced by spay/neuter.
- 3. Noxious odors are eliminated.** Unaltered males mark their territory by spraying urine tinged with testosterone, causing an especially foul odor. Neutering eliminates the testosterone and the pungent smell associated with it. In addition, most altered male cats will stop spraying or do so less frequently.

4. **Rodent control is maintained.** Cats provide a natural form of rodent control, primarily by their scent deterring possible prey. Returning the cats allows this to continue.
5. **A healthier and less visible colony.** Neutering, regular food and adequate shelter greatly improve the cats' health. As a result, they will be much less prone to infestation by parasites like fleas, a benefit to their human neighbors as well. In addition, neutered cats tend to roam much less and so become less visible.
6. **Removal of the pity/sadness factor.** Concerned neighborhood residents no longer have to observe hungry cats or dying kittens, sights commonly associated with an out-of-control free-roaming cat population.
7. **The presence of a caretaker.** With TNR, someone is there to take responsibility for the colony, watch over them and work out any problems with neighbors.
8. **Prevents a new, unaltered colony from forming.** Removing most or all of a colony leaves the territory vulnerable to re-colonization by new, unaltered cats and resumption of the same problems as before. This is commonly referred to as the "vacuum effect," a phenomenon discussed in more detail later in this chapter. Fixing the colony and leaving them in place breaks this cycle. The colony will usually guard its territory from newcomers if its food source is limited to an amount which can only support its members.

● **The advantages of TNR - community level**

The advantages of TNR when the method is practiced on a community-wide scale extend well beyond each individual colony:

- a) **Reduction of the community's free-roaming cat population.** If a substantial percentage of the colonies in a community are spay/neutered and managed properly, then the overall number of feral and stray cats in that community will decline over time. The rate of decline will increase as more and more colonies are TNR'ed.
- b) **Lower intake and euthanasia rates.** Feral cats and especially their offspring are flooding shelters throughout the United States, thereby raising cat intake rates, creating overcrowded conditions and draining limited shelter resources. Because adult ferals are unadoptable and the sheer quantity of kittens can be overwhelming, euthanasia is often the outcome for these cats. By reducing the number of feral cats in a community, TNR can lower intake rates and lessen the need for euthanasia. Funds saved can be used to further TNR efforts in the community.

- c) **Fewer nuisance complaints.** As mentioned, spay/neuter alone eliminates much of the nuisance behavior associated with unaltered feral cats, such as noise and noxious odors. This in turn reduces the burden on local animal control or public health authorities of investigating and acting upon complaint calls. An overall reduction of the number of feral cats in a community, achieved through TNR, will also lead to fewer complaint calls.
- d) **Rabies control.** In regions where rabies is present in the environment, rabies vaccinations are a part of the standard veterinary protocol for TNR. This reduces the number of unprotected cats and reduces the threat of people being exposed to the disease. While cases of rabid cats attacking a person are extremely rare, it is possible for young kittens carrying rabies to be unknowingly handled by people. When it is later learned these people were exposed, the required treatments are expensive and can strain the budgets of local health departments. By both vaccinating cats and reducing litters of kittens, TNR lowers the incidence of potential rabies exposures.
- e) **Ability to mobilize volunteers.** Because TNR is life affirming, it attracts large numbers of people who care about the cats and their well-being. Volunteers will contribute their time, labor and funds to trap the cats and get them fixed, knowing the cats will live. In contrast, efforts to trap and remove the cats usually result in their deaths and are not something many people will volunteer to do. With estimates on the number of free-roaming cats in the U.S. in the tens of millions, the ability to mobilize an army of volunteers is essential to put an end to their overpopulation.
- f) **Cost savings for shelters.** Every time a cat is impounded and euthanized, there are costs involved. There may have been the cost of sending an animal control officer out to capture the cat. There is staff time spent processing the intake and providing care during whatever mandatory holding period may be required. There is food and litter. The euthanasia procedure is a cost as is the disposal of the body. As a result, for every feral cat that is TNR'ed instead of being brought to a shelter, the shelter saves funds, especially if a private individual or another animal welfare group conducts the trapping and pays for the surgery.
- g) **Gaining caretaker cooperation.** Caretakers of colonies typically know their cats' numbers, whereabouts and habits. They can help trappings go well by sharing information and withholding food at the appropriate time, or they can thwart trappings by doing the opposite. Caretakers' cooperation is crucial for any successful attempt at feral cat population control and TNR gains this by ensuring the cats will not be harmed.
- h) **Improved public relations for animal control.** When animal control supports TNR instead of trapping and removing cats, their public image gets a major boost in a positive direction. This can lead to more volunteers, more people coming to municipal shelters to adopt cats and improved fundraising.

• Failed alternatives to TNR

One of the most persuasive reasons for doing Trap-Neuter-Return is that nothing else works! To achieve the goals of population reduction and lowered nuisance behavior, no other technique has a realistic chance of long-term success. An examination of the available alternatives to TNR makes this clear.

1. Trap and remove

“Trap and remove” is often referred to as “trap and euthanize” because euthanasia is the common outcome for the cats. We prefer the term “trap and remove” because it focuses on the attempt to eradicate the cats from the environment. It has been the predominant approach by animal control agencies in the U.S. towards feral cats for decades. The current proliferation of the cats in every nook and cranny of the country speaks eloquently to the utter failure of this method to achieve long-term reduction of their populations. There are several reasons why it doesn’t work:

▪ *The vacuum effect*

Cat colonies spring up and subsist in certain locations because the habitat provides adequate food and shelter. When a colony is removed from a site, but the habitat is left unchanged, cats who were recently abandoned or belong to neighboring colonies will move into the vacant territory to take advantage of the remaining food and shelter. The cycle of reproduction begins anew and the colony quickly returns to the size which available resources can support. This phenomenon, known as the “vacuum effect,” was first documented by wildlife biologist Roger Tabor in his studies of London street cats (Tabor, R., *The Wild Life of the Domestic Cat* (1983) Arrow Books.)

Altering the habitat to discourage immigration of new cats is difficult. All it takes to create an adequate food source is an unsealed dumpster, open garbage cans or one compassionate person leaving out cans of food when they spot a cat. One study found a quarter of the respondents in a random survey of adults in Ohio had recently fed a feral or stray cat. (Lord, L., *Attitudes toward and perceptions of free-roaming cats among individuals living in Ohio* (1983) Journal of the American Veterinary Medical Association Vol. 232: 1159-1167.)

▪ *Higher survival rates*

Trapping all the members of a colony can be done, and one of the purposes of this handbook is to explain how, but it requires close knowledge of the colony, training, patience and dedication. When local authorities attempt to trap and remove feral cats, they rarely have the information or time needed to do a thorough job and, inevitably, some cats are left behind. These cats and their offspring now have less competition for the food and shelter remaining at the site, resulting in a higher percentage of kittens surviving until the colony’s natural ceiling – the number of cats which the available food and shelter can support – is again reached.

- ***Lack of animal control resources***

At this point in time, there are so many feral cats in the environment that it is the rare animal control agency which has the manpower to try to trap and remove a significant number from its community. More urgent matters, such as dangerous dogs, take priority. Cat trapping usually occurs in response to complaints. An officer will go out to a location, put out a few traps for an unknown (to him) number of cats, take away whoever he happens to have caught when he comes back in a few hours, then move on to the next problem. Many communities, like New York City, have recognized the futility of this approach and the wastefulness and no longer send officers out to trap cats unless there is a significant public health issue involved.

- ***Caretaker resistance***

As discussed earlier, one of the advantages of TNR to the community is that caretakers of colonies will cooperate. On the flip side, if the approach instead is to trap and euthanize the cats, caretakers will resist, either actively or passively. Passive resistance may include withholding important information, such as the number of cats, and where and when they eat. Active resistance may include feeding the cats before trapping attempts to discourage them from entering baited traps, or setting off or damaging traps when they're left unguarded.

- ***Synergy***

Most situations involving trap and remove attempts have more than one and often all the relevant factors present at the same time – the vacuum effect, higher survival rates for untrapped cats, lack of animal control resources and caretaker resistance. They combine to render trap and euthanize completely ineffectual for long-term, community-wide population control. Municipalities that continue to utilize this method typically experience constant levels from year to year of seized cats, complaint calls and euthanasia rates. These unchanging numbers indicate all that is being accomplished is population turnover rather than reduction – new feline faces, but not fewer. The problem is not being solved.

2. Feeding bans

Feeding bans, at first glance, may have a simplistic appeal to authorities trying to reduce their community's free-roaming cat population – “stop feeding cats and there won't be any,” is basically the thinking. The first fault with this approach is it is inherently cruel and irresponsible. If a feeding ban was going to work, it would be because the cats would either starve to death or go somewhere else and become someone else's problem.

In reality, assuming a feeding ban can be enforced, the cats won't all die nor will they pack their kitty bags and board a bus to the next town over. Ferals are extremely territorial and will not wander far in search of food. However, they are quite resourceful

and as their hunger grows, they will encroach farther into inhabited spaces, including homes and workplaces, locate previously untapped food sources within their territory and raise their level of predation. Though it may well damage their health, cats can survive for weeks without food and continue to reproduce. If they become malnourished, their vulnerability to parasites like fleas increases. A common tale is a workplace where first feeding cats is prohibited, then hungry cats enter the factories or trailers looking for food, then flea infestations break out in these areas. What might have seemed like a simple solution ends up making the situation much worse.

The second reason feeding bans invariably fail is because they are almost impossible to enforce. Caretakers of colonies feel as much of a bond towards the cats as owners feel towards their pets and most will not just walk away when they know the cats are depending upon them. Caring people have repeatedly demonstrated they will risk their jobs, their homes, jail, fines and even bodily harm to prevent the animals from starving. Given the level and intensity of resistance that typically arises when a feeding ban is imposed, enforcement becomes impractical in areas of any significant size. People will simply put out food when no one is watching. Attempts to make free-roaming cats disappear by banning feeding usually result in suffering for the cats and increased conflict among local residents, pitting those who care for the cats against those who don't, but little else.

3. Rescue or relocation

Neighborhood Cats encourages the placement of adoptable cats and kittens into responsible homes whenever possible. This is both humane and one way in which TNR activists can help reduce the street cat population. However, the goal that all ferals should be rescued and placed in homes is not realistic. There are far too many cats and too few foster or permanent homes with the willingness and patience to socialize a feral. Perhaps one day this will change, but we are a long way from that time. Resources now are better spent neutering the feral population rather than going through the long and uncertain process of socializing and placing feral cats, especially when there are plenty of already tame cats dying in our shelters for lack of homes. For the cat's sake, too, allowing a feral to live out his life in his territory may be a more compassionate choice than having him spend fearful years in a cage or hiding under a bed.

In addition to rescue, bringing the cats to a sanctuary or relocating them to a safer site are other possible solutions people often jump to when they first come upon an unmanaged colony in distress. This is understandable – the cats appear to be in danger due to anger and hostility towards them from the community and the immediate urge is to remove them from these risks. But there are few reputable sanctuaries and little room in them, and relocation to a new site is a difficult and uncertain process. See Chapter 16 for an extended discussion of both sanctuaries and relocation projects

There is also the question of what happens at the old site when the cats are removed, whether to be adopted out, sent to a sanctuary or relocated elsewhere. Unless the food source is also removed, the vacuum effect may come into play and new cats may appear. In addition, survival rates may increase among any cats left behind, including their offspring. In the end, despite the rescue or relocation of some cats, the end result may be just as many cats living in the same area.

4. Do nothing

If nothing is done, then the number of cats in a colony or in the community at large will grow to the carrying capacity of the environment. In other words, however many cats the available food and shelter can support, that's how many cats there will be. At the point where capacity is exceeded, population control takes the form of disease, starvation or other natural means. Impacts on shelters, including higher intake, euthanasia and costs, are not reduced. Public health concerns such as rabies and noise, odor and other quality of life complaints are left unaddressed. If the human population in the area grows, so will the carrying capacity and the number of cats. Doing nothing may be an option, but it's hardly a solution.

In sum, trying to solve free-roaming cat overpopulation by removing feral cats – whether to euthanize, rescue or relocate – does not work. In nature's ongoing cycle, new cats replace the old ones and nothing much changes in terms of the numbers or nuisance behavior. Feeding bans, besides being cruel in concept, are ineffective in practice. Doing nothing means accepting the status quo and all the problems that come with it. Ultimately, targeting the cats' reproductive capacity through spay/neuter and returning them back to their territory is the best approach available for lowering their numbers, reducing their impact on the environment and improving their lives.



photo: Heather Letzkus

3. The TNR Process – An Overview



photo: Meredith Weiss

Every colony of feral cats is going to present its own challenges when it comes to TNR. In a dense urban area like New York City, finding a space to hold the cats during trapping and after surgery can be challenging, while practicing TNR in a rural area may involve more difficulty finding affordable spay/neuter. But the basic elements are the same in any location and the purpose of this chapter is to give a snapshot of the process. In following chapters, each step will be discussed in much more detail.

Note that trapping is not the first step in the process, but instead takes place after careful planning and preparation. The best way to avoid ending up with a household full of feral cats is to think things out first and have as much as possible set up and arranged beforehand, then trap. Not every problem that will arise can be anticipated and prepared for, but most can.

Nor is trapping the last step. TNR is also about creating as safe and healthy an environment as possible for the cats' to live in and providing for their long-term care. Practicing TNR properly includes setting up feeding stations, providing proper winter shelter and building good relations with the community.

Step one: Build good community relations

Most feral cat colonies are found within a community, not off by themselves in the woods. Whether it's a backyard, a parking lot, a factory, a barn or an alley behind an apartment building, the cats have human neighbors. The effectiveness of your TNR project and the long-term security of the cats will depend in large part on the cooperation and understanding of the people who live and work in the area. They need to be educated about your work and have their own concerns heard and taken into account.

Step two: Set up feeding stations and shelter, and establish a feeding pattern

Regular feeding will improve the cats' health and better prepare them for the stress of trapping and surgery. Health problems, such as ringworm, parasites and upper respiratory infections, can often be resolved through improved nutrition. Warm, dry shelter, especially during wintertime in northern climates, is also a key to good health and must be in place if spayed females with shaved stomachs are to be released in cold

weather. In addition, thoughtful location of feeding stations and shelters can help reduce tensions with neighbors.

Starting at least two weeks before the trapping, the cats should be fed at the same time and place as consistently as possible. Establishing a feeding pattern will let you get to know the colony. How many cats are there, what condition are they in, are any adoptable? Knowing all this ahead of time allows you to schedule an appropriate number of surgical slots, line up foster homes if needed, arrange extra veterinary care for any special cases and, in general, explore your options in a more relaxed way than will be the case if you wait until the cats are trapped before you figure things out.

A reliable feeding pattern will also make the trapping much easier because the cats will be trained where and when to show up. Feral cats are very habitual creatures. You won't have to go searching throughout the territory for them – they'll come to you instead at the appointed hour.

Train the cats to come eat at an hour that will work best for you when it comes time to trap. Also, cats are rarely on the prowl when the mercury climbs so summertime trapping works best if you train ferals to come for meals early in the morning or after sunset when the temperatures are cooler.

Step three: Secure a holding space

During the trapping and after the spay/neuter surgery, the cats will need to be confined. Except during the actual surgeries when they are sedated, the cats should remain in their traps at all times. This is for the safety of anyone working with the cats and to prevent escapes. Using the techniques described in this handbook, the traps effectively double as cages and the cats can be comfortably housed and fed in them.

The holding space where the cats are kept in their traps must be warm, dry and secure. It could be a garage, basement, warehouse, empty room in an apartment or enclosed porch in the summertime. Any space will work where the temperature can be kept warm, the cats can be protected from the elements and no threat of harm will be presented by other animals or people not associated with the project. Trapping will normally take place over two or three days, then post-surgical recovery time may also last two or three days, so the time the cats are held will usually run from four to six days.

Step four: Schedule spay/neuter and arrange needed equipment & transportation

Once you've educated the community on what you're doing, set up a feeding pattern and counted the cats, and found a suitable holding space, you can safely schedule your spay/neuter date. Whenever possible, mass trapping – the TNR of an entire colony at once - is recommended. Mass trapping is the most efficient approach to TNR and brings the quickest results. However, your ability to mass trap may be constrained by the cost and availability of spay/neuter, the availability of traps, your time limitations or the size of your holding space.

After you've determined how many cats you'll be after when you first trap, schedule that number of surgeries with your spay/neuter provider. If traps are available to borrow, reserve them right after you've set up your spay/neuter appointment – ask for one trap per cat plus a couple of extra if you're mass trapping. You may need to reduce the number of scheduled surgeries if you can't secure enough traps, or re-schedule your spay/neuter date to a time when enough equipment will be available. Also, make arrangements for transportation. The cats will need to be transported from their territory to the holding space, back and forth from the spay/neuter clinic and then back to their territory.

Step five: Trap

Now that everything is in place, the trapping can proceed. Food is withheld from the cats the entire day before trapping begins. How many days you allot for trapping will depend on the number of cats you're after. Always leaving at least two days is advisable, three if you're after more than a few cats. The extra time protects against poor weather, the cats not showing up for some unknown reason, your neighbor deciding to start a construction project right at that time, or any other unexpected condition which could impair the trapping. Waiting until the day before your surgery appointment, or the morning of, is risky and could damage your relationship with the clinic if you show up empty-handed.

Step six: Spay Day

Food and water are withheld the night before the spay/neuter date, except for young kittens who need to be fed closer to the time of surgery. The morning of the appointments, the cats are transported to the clinic where standard treatment includes spay/neuter, ear tipping and, where appropriate, rabies vaccination. Flea medication, ear mite treatment and other extra veterinary care are recommended on an "as needed" basis.

Step seven: Recovery & return

If everything goes normally, the cats will be confined from 24 to 72 hours post-surgery and then returned to their territory. It's important the cats are released in close proximity to where they were trapped and not at an unfamiliar location. Otherwise, without the proper relocation procedures being followed, they will likely run off in search of their old home. During the time they're held, both before and after surgery, the cats should be fed and their traps cleaned twice a day.

Step eight: Long-term care and monitoring

After the trapping and spay/neuter of the cats is complete, the long-term care of the colony begins. For TNR to be most successful at reducing numbers and providing humane care, a designated caretaker or caretakers should feed the cats regularly, make sure there is adequate shelter, watch out for and trap any newcomers, and act as an intermediary with the community.

4. Building Good Community Relations

For the most part, feral cats live among us, their territory overlapping our own. Many people will interact with the cats on a daily basis, whether it's leaving out food, playing with them or watching from a distance. There will be those who love the cats and enjoy their presence, while others may be angry at the noise and odor if the cats are not neutered. Few people are aware anything can be done to improve the situation for the cats and the community.

To ensure the long-term security of the colony and to facilitate your trapping and caretaking, the community and its attitudes towards the cats must be considered. Whenever possible, efforts need to be made to shape attitudes in a favorable way. To ignore this aspect of TNR and go about the work with no concern for the neighborhood in general is to potentially place the cats and your project in needless peril. With a little education about what you're doing and its advantages,



photo: Petr Salidar

understanding and support can be built. In this respect, TNR is not only about working with cats, but about community activism and working with people.

What "community" will be involved in your project will depend on the circumstances. The relevant community might be a factory and the people who work there, a municipal facility and the agency which runs it, a homeowner and his backyard, a condominium complex, a hospital, a neighborhood or even an entire town or city. No matter how broadly or narrowly the community is defined, the importance of developing good relations is paramount. It will be much easier to trap if you have permission to enter someone's property than if you trespass and try not to be spotted. Feeding and care, too, is easier and more reliable when you have the community's support as opposed to hoping no one throws away the food or challenges your right to provide care. Releasing cats back onto property where the residents know what you're doing and approve of TNR is much safer for the cats than putting them back into an uncertain situation where the reaction of the community is unknown.

By performing TNR, you're helping bring a problem under control that affects everyone who lives or works near the colony. In this respect, TNR is a community service. So let people know you're helping them! You may be surprised how many welcome and appreciate your efforts.

Before you can win over the neighborhood, you need to educate yourself about TNR and be able to speak persuasively about its many advantages. Review Chapter 2 closely

for this purpose. Once you can talk about TNR in a knowledgeable manner, you'll be able to effectively use the community development techniques described below.

- **Community development techniques**

- 1. Walk and talk**

One way to gauge the prevailing attitudes towards the cats in a neighborhood, as well as learn about the history of the colony, is by walking around and talking to people. Talk to doormen, superintendents, store owners, parking lot attendants, local residents whose front or backyards are part of the cats' territory, the closest veterinarian, people you notice stopping and watching the cats – anyone who might be acquainted with the felines. The idea is to gather as much information as possible: How many cats are there? Who feeds them? When? How often? How did the situation start? Has anyone tried to do anything about it before? How do people feel about the cats – welcoming, hostile, indifferent? If you come across someone friendly to your cause, get their contact information or give them yours – down the road you may need their help or they may have more information for you. Stay alert for people who might help feed or trap, or who want to donate food, money or holding space.

During this “get acquainted” phase, explain to people what TNR is and let them know you are organizing a TNR project. Keep repeating the mantra, “No more kittens, no more noise, no more odor.” Where relevant, emphasize the natural rodent control provided by the cats. Refer those who are interested to resources where they can learn more about TNR, such as the Neighborhood Cats website (www.neighborhoodcats.org). If you can, make up business cards – see Vistaprint.com (www.vistaprint.com) for a way to design and print cards inexpensively. Keep your appearance neat and clean. The more professional an image you convey, the more effectively your message will be delivered.

- 2. Deal calmly with hostility and resistance**

Often, a feral cat problem will come to your attention after a crisis situation has already developed – there are too many cats, people can't sleep at night because of the yowling, piles of unsightly empty cat food cans litter the block, backyards can't be used because of the smell. These are all typical signs of an out-of-control, unmanaged colony. Many people affected by these conditions will resent the cats and blame anyone who feeds them for their continued presence. Their attitude towards you, a cat-friendly person, may at first be hostile and even confrontational. Anticipating this kind of hostility and dealing with it well is essential, especially if the person or agency which is upset has the authority to decide whether a TNR project moves forward or not.

The key is not to take anything said personally and be hostile in return, as difficult as it may be to hold back a good retort. Instead, try to understand why someone might be frustrated and unhappy with the cats. Put yourself in the place of those who are complaining – if cats fighting woke you up every night at 2 a.m., if your garden had

become the neighborhood litter box or if the laundry room in your building stank from the spray of unaltered male cats, you might be resentful, too. Especially if no one took your grievances seriously or ever offered a solution.

Don't argue with those who voice these complaints, but listen carefully. Openly sympathize with what they've had to deal with and explain how TNR will help and why trying to permanently remove the cats from the area will just end up with new cats and the same old problems. Most people calm down and respond well when they see their side of the story is being heard. When they understand there's a way to keep the cats and lose the problems, most are willing to give it a try. The worst thing you can do is lose your temper and act angry and critical. All you'll accomplish is making the person, who you need to get on board with TNR, even more hostile and defensive. When the argument ends and you walk away, you'll have made the situation more precarious for the cats, not better. Stay in control at all times and, if you're new at this, consider doing some role-playing with friends before you start talking to people for real. Let your friends act out the part of the angry neighbor who hates the cats while you try to listen to, understand and defuse their hostility.

There will be times when someone in a position of authority won't agree to TNR no matter how well you perform your role as advocate. Don't give up easily. Try to get someone else to speak to the person whose word may carry more weight with him. A supportive animal control or public health official, for example, or a local councilman or minister may be able to make more progress. If you still don't get anywhere, you have to decide whether to keep the lines of communication open, in case the person or agency changes their mind in the future, or attempt to apply public pressure to get them to change their mind now. If you withdraw quietly and remain available, eventually, if other attempts at resolving the feral cat situation fail, the person or agency may become more open to trying TNR. Of course, cats may suffer in the meantime and definitely will if trapping and euthanizing takes place.

Trying to apply public pressure instead of waiting to see if minds change is not a simple task and you should be realistic about your capacity to launch an effective campaign. Are you acting alone or as part of an organization? Usually, the support of a group is needed. Does the organization have the media contacts, volunteers and resources necessary for sustaining a campaign that might include demonstrations, online advocacy, interviews, etc.? Sometimes these situations are resolved quickly, but other times they drag on for weeks or months. Has support for TNR already been built up in your community and you know public opinion will be on your side? Is the person or entity you're trying to persuade vulnerable to public pressure or can they easily ignore it? Sometimes there is value in putting up a fight even if you don't prevail in order to promote TNR in general, but then you still have to put up a good fight. Knowing your opponent, your own capacity to campaign and the value of a struggle are all important in deciding, when the answer to TNR is "no," whether to quietly move on or instead stand your ground.

3. Hold community meetings

Community meetings take primarily two forms – meetings with members of the community, such as residents in a neighborhood, and meetings with community leaders,

like the board of a homeowners association. Depending on the circumstances, you may hold one or the other or even both. If your work involves an apartment building, make an appointment to meet the landlord, co-op board or superintendent. Once you have their blessings, it might be wise to hold a general informational meeting for residents so as many people as possible are supportive of your work. If the cats are located at a government-owned facility or a private workplace, getting the consent of whoever is in charge is usually enough. If it's an entire neighborhood that you're targeting and there are no identifiable authorities, schedule a meeting at a local coffee shop and post flyers announcing it. Invite everyone interested in the cats, pro and con. If you can get people initially to the cats to attend, you'll have an opportunity to educate and change minds.

With neighborhoods, find out if there is a local Community Board. If so, call up and get on the agenda for the next meeting. Be prepared to speak for a few minutes and have both a list of suggested volunteer activities, such as providing holding space, assistance with trapping or fostering young kittens, and a signup sheet. The people who regularly attend these Board meetings are often the more active members of the community and the most willing to help out.

Churches, libraries or the offices of local elected officials could be asked to host a meeting. Getting the backing of recognized community leaders - like the mayor, a council member, a respected priest - is a plus, so try to meet with them, too, and ask for their support. Check with your local police precinct to see if they have a community affairs officer. These officers can be helpful in a variety of ways, from helping gain the cooperation of others to reserving parking space for a mobile spay/neuter clinic.

4. Send a community appeal letter

One technique for informing people of your work and gaining their support is a letter addressed to everyone in the building, apartment complex or neighborhood. Real estate brokers have the names and addresses of all residents in a particular area. If you know someone in the business, ask if you can use the list to do a mailing. Or else slip the letter under everyone's door. (But don't put anything in or on mailboxes - doing so violates federal law!) The letter should explain the current problems going on with the cats, what TNR is, and how you intend to use TNR to solve the situation. Include a contact number for yourself or the organization you're working with. Mention ways people can help, including donations if you're working with a nonprofit. Also consider announcing a meeting where any questions will be answered.

5. Post informational flyers

A one page flyer describing TNR and how you plan to implement it in your neighborhood is another way to build support. Keep it simple and easy to read (don't use small type) and list contact info. Post it on bulletin boards, permissible public areas, veterinarians' offices and local animal shelters. Include a solicitation for volunteers and, if you're affiliated with a nonprofit, for funds.

6. Change municipal laws and animal control policies

In some municipalities, there are laws which effectively outlaw TNR, such as bans on feeding any animal outdoors, laws prohibiting cats from roaming freely (“at large laws”) and limits on the number of animals a resident can own with “ownership” defined in a manner that includes feral cat caretakers. In other locales, animal control may have a policy of trying to trap and remove all free-roaming cats, neutered or not. To openly practice TNR in such communities, these kinds of hostile laws and policies must first be addressed and changed.

Effective advocacy of TNR on the government level requires careful planning, and experience in this realm is very helpful. If you’re new to TNR and political advocacy, consult with more experienced activists before meeting with the town council or the head of animal control. Again, study Chapter 2 so you can clearly explain to others the benefits of TNR. See if there is a feral cat organization or program nearby with the knowledge of how best to approach the issue. Consult the Neighborhood Cats website for ideas and materials, such as pro-TNR position statements from The Humane Society of the United States and the ASPCA. You can also contact us for advice at info@neighborhoodcats.org.

Government officials will make their decisions based on what they believe is best for their human constituents, not what’s best for the cats. So focus on topics like lowering the number of free-roaming cats, cost savings and public health benefits, not on how the cats’ health improves with TNR. Look the part by dressing professionally and leave the cat-themed T-shirt, cap and sweater at home!

• Poisoning threats

When a feral cat colony is unmanaged and in crisis, occasionally a threat to poison is made by a resident in the area. If this happens, the first thing to do is find out what the law is in your state or county. In many jurisdictions, poisoning is a form of animal cruelty and a crime, even a felony with a possible prison sentence in some states. To find out if poisoning is an offense where you reside and, if so, what the penalties are, call your local shelter or animal control agency, check the Internet or ask an attorney friend.

People who threaten or actually attempt to poison are usually unaware this is a serious offense. One way to deter them is to let them know. Make up a “Stop Poisoning” poster similar to the one in *Appendix A* of this handbook. The poster should include the maximum penalty for poisoning and offer a reward for information leading to arrest and conviction. Print out copies on bright pink paper and post them around the neighborhood in question, leaving a few extra copies in front of the suspect’s residence or place of employment.

Keep in mind the purpose of the poster is not to catch anyone, but to deter any would-be poisoner from acting. You can rest easy about having to pay the reward - it’s extremely unlikely anyone will ever be arrested, let alone convicted, as a result of

information provided because of the poster - although be reasonable about the amount you list so the poster appears credible. Despite the unlikelihood of finding and convicting anyone, the poster has two important effects – it alerts someone considering poisoning that he would be committing a crime and it also lets him know others are watching. Not many people will care enough about getting rid of the cats to risk going to jail. As a result, in our experience, the poster is an effective deterrent.

The Stop Poisoning poster should only be used if there is a *reasonable* suspicion of possible poisoning. It should not be used simply because you're afraid someone is so angry, he might try it. Something concrete like an articulated threat or the mysterious death of a cat should be the threshold. Otherwise, you could be needlessly stirring things up and planting the idea.

• Fleas

One reason someone may give for wanting to remove feral cats from an area is fleas. Flea infestations can become severe, especially if the cats shelter in a spot favorable to fleas, such as the crawl space beneath a building. Employees at a workplace or residents of an apartment complex may complain of flea bites and attempts to fumigate may fail. The thinking then becomes, “get rid of the cats and we'll get rid of the fleas.” As discussed in Chapter 2, removing feral cats is much easier said than done and there are better ways.

▪ *Improved living conditions*

It's not unusual for free-roaming cats to carry some fleas – more in warm weather, fewer in cold. When the fleas are so plentiful the condition reaches the level of an infestation, this can be a sign something is wrong with the animal's health. Situations where ferals are infested with fleas are often unmanaged ones where the cats are unneutered and/or poorly fed. A factory where feeding of cats has been banned would be typical. The cats, deprived of adequate nutrition and facing the demands of mating behavior, become weakened and more susceptible to fleas. They start coming in closer to where people are working because of hunger and their search for food. The result is a flea infestation of the workplace.

Neutering the cats and providing them with regular food and adequate shelter boosts their immune systems and usually eliminates the problem. While the cats are at the spay/neuter clinic, they can be given flea medication so everyone can start off clean and infested locations can be treated as long as no cats would be in danger. In addition, by managing the colony and deciding where the cats will eat and sleep, they can be drawn out of locations which fleas favor and away from the immediate areas where people live and work.

- ***Diatomaceous earth***

One tool for addressing fleas is an all-natural insecticide called diatomaceous earth, a fine powder made from the fossilized remains of tiny, hard-shelled types of algae called diatoms. While it feels like talcum powder to our touch, on a microscopic level, the fossilized remains are razor sharp and kill fleas upon contact. The product is often fed to cows and other farm animals to help clear their digestive systems of worms. It can be spread in locations where fleas are found, like cracks between walls and floors, under sinks, beneath trailers and other problem areas. It can also be sprinkled in locations where the cats spend time, like inside their shelters. Cats who can be handled can be dusted with it as a cheap form of flea control, although a topical flea medication is likely to be more effective.

Important note! There are many varieties of diatomaceous earth and it's essential, for purposes of safety and efficacy, to ***only use the "Food Grade" variety*** with and around animals. Do not, for example, use "pool grade" diatomaceous earth. The product is relatively inexpensive and can be purchased in bulk, up to 50 lbs. in a bag, at many agricultural feed stores. You can also buy it online or over the phone – one vendor is Dirt Works (www.dirtworks.net or call 1-877-213-3828).

- ***Beneficial nematodes***

Another natural product for flea control in natural outdoor settings like lawns or gardens is Beneficial Nematodes, microscopic worms which eat the larvae of fleas and other common insects. They are applied using a lawn sprayer to moist, shady areas where fleas thrive. Nematodes reproduce rapidly and within a matter of days, will significantly reduce the resident flea population. They are not parasites and will not harm the cats.

Nematodes are sensitive to light and temperature so should be applied either at dusk or early in the morning – neither fleas nor nematodes will survive in the hot sun. They mostly die off in cold winter weather, so may need to be re-applied in the spring. If there are no fleas or other suitable insects for them to eat, the worms will naturally die off. Different varieties suitable for different insects and soil types are now available. They can be purchased at many home garden stores, especially ones oriented towards organic gardening. One source is Arbico Organics (www.arbico-organics.com or call 1-800-827-2847.)

- **Keeping cats out of gardens & yards**

A common source of complaints about feral cats is people who don't want them in their yards or gardens or on other parts of their property. Trying to work with property owners to alleviate this problem is a better way to protect the cats than arguing the felines have a right to go wherever they want. Listed below are several products and methods for keeping the cats away from places they're not welcomed. There are deterrents, which

act to discourage cats from entering or remaining in a space, and confinement systems which restrict their movement to certain areas. In most situations involving free-roaming cats, a deterrent will likely be the most practical approach.

1. Deterrents

In our experience, the motion-activated sprinkler is by far the most effective deterrent when the area in question is well-defined, such as a garden or a backyard, and not too large. The other deterrents listed below have worked for others and may work for you, too.

▪ *Motion-activated sprinklers*

A motion-activated sprinkler works just as its name suggests. The device emits an infra-red field which covers the area you're trying to protect. When a cat enters the field, the sprinkler shoots off a loud and violent burst of water in her general direction that lasts a few seconds. Rarely will the cat be hit by the spray; rather, the cat becomes frightened and runs off. Before long, cats learn the boundaries of the infra-red field, avoid entering it and, eventually, the sprinkler is rarely triggered. Because water is needed, the device will not function in freezing temperatures. The trick is to start using it in warmer weather so the cats are trained to stay away by winter. Motion-activated sprinklers on the market include:

□ **The Scarecrow** by Contech

This product detects motion up to 45 feet away and covers a maximum area of 1300 square feet. The device must be connected to a water source via a hose and operates for six months on one 9 volt battery. Multiple units can be connected via hoses to one another, requiring only one water source. The distance of the spray and area covered are adjustable, as is the sensitivity of the device to detecting motion. Changing these variables can prevent cats from growing accustomed to the device. It can be purchased directly from the manufacturer at www.contech-inc.com or call 1-800-767-8658. If you do an online search for other retail outlets, you may find it at a lower price. Try Safe Pet Products (www.safepetproducts.com or call 1-888-977-7387) or search Amazon (www.amazon.com).

□ **Spray Away** by Havahart

This device's advertised coverage of 1000 square feet and range of motion detection of 35 feet are slightly less than those claimed by the Scarecrow. Similar to The Scarecrow, it operates on one 9 volt battery, has adjustable settings and can have multiple units linked to one water source. Available at www.havahart.com.

- ❑ **Spray Away Elite** by Havahart

This new product operates in a manner similar to other motion-activated sprinklers, but is hose-free. Because it contains its own 3.5 gallon reservoir, it does not need to be connected to another water source and has great mobility in terms of placement. Another innovative feature is its lifetime battery which is recharged by solar panels located on top of the unit. Its motion-detecting range is listed at 35 feet and coverage area is 1000 square feet. It is more expensive than models which require hose connections, so you might want to limit its use to situations where a hose is unavailable or impractical. Go to www.havahart.com.

- ***Ultrasonic devices***

An ultrasonic device, like a motion-activated sprinkler, emits an infra-red field. When a cat steps into the field, the device gives off a high frequency sound annoying to cats, but not perceptible by people. The key to their effectiveness is making sure the device or devices have the capacity to cover the size of the area you're trying to guard. Otherwise, they won't work. In our experience, ultrasonic devices have received mixed reviews. There are experienced feral cat groups which swear by them and use them in creative ways, such as mounting one on a garage, pointing down at a parking space to keep cats from jumping onto cars or placing two devices at opposite ends of a property line, facing one another, in order to keep cats from crossing the line. Other people, however, have reported the devices have no effect on the cats.

Part of the problem when the device doesn't have the desired effect may be that cats are smart. Because the device is motion-activated, it will turn off if the cat enters the territory and then stays still or hides behind a large object. As a result, it may take some trial and error and strategizing about placement of the device before the desired effect of keeping the cats away is achieved. If you're thinking of trying one, it might be wise to buy one or two first and test them out before making a larger investment. The devices work in all types of weather, though if you're using batteries, you may need to replace them more often in colder seasons. Models include:

- ❑ **CatStop** by Contech

This is the most popular brand. One device covers 280 square feet and operates on either a 9 volt battery or, for purchase at an additional cost, an AC adaptor. Go to www.contech-inc.com or call 1-800-767-8658. A search for other online retailers of the product on Amazon (www.amazon.com) may turn up a lower price.

- ❑ **Yard Gard Ultrasonic Animal Repeller** by Bird-X

The *Yard Gard* has an advertised range of 4,000 square feet, quite a bit larger than the *CatStop*. It can be set to be either motion-activated or produce sound continuously. We recommend using the motion-activated setting so the least amount of audio disturbance is created in the environment, which may contain other animals you don't want to

repel. It operates on four “C” batteries or an AC adaptor. Go to www.bird-x.com or call 1-800-662-5021. You may find lower prices for the product at other online outlets by searching Amazon (www.amazon.com).

▪ *Scent repellents*

Reports on the effectiveness of scent repellants are mixed, sometimes working quite well and at other times, not at all. Scent repellants should be sprayed or placed around the edges of the yard, the tops of fences and on any favorite digging areas or plants. Sprays will need to be replenished frequently and especially after rain. Chemically based repellents often contain the active ingredient methylnonylketone. Manufacturers claim this ingredient is safe, but also warn the chemical is poisonous and should not be applied to food crops. Because of the possible risks, we recommend using chemically-based scent repellants only if they will be used in a closed container. Otherwise, we recommend naturally-based products, including the following:

□ **Coleus Canina**

This plant, a weed originating in Europe, is known as the "Scaredy-Cat" or "Pee-off" plant because it emits an odor offensive to cats (but not to humans). They should be planted three feet apart around the area to be protected. To obtain them, you may need to order cuttings or seeds from a nursery or dealer. The order should be placed during the winter or early in the spring planting season before dealers run out of stock. **WARNING:** There are many varieties of Coleus plants, so be sure to buy the correct type – Coleus Canina. One online merchant specializing in Coleus plants is Rosy Dawn Gardens (www.rosydawngardens.com).

□ **Critter Ridder Animal Repellent** by Havahart

This all natural product can be purchased in either granular or spray form. It is advertised as compliant for use in organic gardening, safe for children and pets and effective for thirty days with one application. Go to www.havahart.com.

□ **Household items**

Anecdotal reports indicate some degree of success from sprinkling or dripping in gardens or flower beds one or more of the following items: orange, grapefruit or lemon rinds (cats dislike citrus smells), coffee grounds, pipe tobacco, lavender oil, lemon grass oil, peppermint oil, eucalyptus oil, and mustard oil.

- ***Barriers to digging***

Cats may be attracted to gardens and flower beds because they like digging in the soil and doing their business. Creating physical barriers to digging is one way to keep them away. Products or items include:

- ❑ **Cat Scat Mats** from Gardener's Supply
These are plastic mats with flexible spikes sticking up out of them. You press them into the soil, spikes facing upwards. While they're harmless to cats and other animals, they're irritating and discourage excavation. Go to Gardener's Supply (www.gardeners.com) or call 1-888-833-1412.
- ❑ **Rocks**
Cover exposed ground with rocks that have rough surfaces to deter a cat from touching or trying to move them.
- ❑ **Lattice**
Lay lattice fencing on the ground prior to planting, then plant flowers or seeds in the openings.

- ***Make an Outdoor Litter box***

One way to keep the cats from using the garden or the lawn to poop or pee is by giving them somewhere more attractive to go. A child's sandbox, strategically situated in a far corner of the yard, should do the trick. Regular sandbox sand is inexpensive. It should be scooped out regularly and, occasionally, completely replaced. A large pile of peat moss, approximately four feet square and eight inches deep, has also been reported to be effective. It too should be scooped out regularly and, once a month or so, entirely replaced.

If you want the outdoor litter box to be contained, you can make one out of a large 30 or 55 gallon Rubbermaid storage bin (also called a storage "tote"). Using a box-cutter, slice open a doorway in one of the narrower sides of the bin, making the bottom of the doorway several inches above the ground. An 8" x 8" opening will work. Then fill the bin up to the bottom of the doorway with regular sandbox sand or, if you prefer, cat litter. Cover the bin with its lid. If you can, put a couple of pieces of the cats' stool in the sand to help draw them over. Scoop occasionally and once a month or so, dump and replace the sand or litter.

You can also put a regular litter box with litter inside the storage bin after you've cut open a doorway. You'll likely then need to clean it out on a daily basis.

2. Containment systems

When possible, the best way to avoid problems with neighbors is to keep the cats confined to your own backyard or property. Special fencing is available to accomplish this.

- ***Free-standing fences***

- **Purrfect Fence**

- The *Purrfect Fence* is made up of metal posts and plastic grid fencing which blends in well with its surroundings. Inwardly arched tops prevent climbing over the fence and ground stakes every two feet prevent digging under. It can be installed around very large open spaces with your budget being the only real limitation. The product has been installed at the Hemingway House in Key West, Florida, keeping the famous six-toed cats from wandering off the grounds and into the neighborhood. Discounts are available for 501(c)(3) rescues and shelters. Go to www.purrfectfence.com or call 1-888-280-4066.

- ***Attachments to an existing fence***

Attachments can be added to the top of an existing fence to keep the cats from climbing over. These systems consist of inward leaning posts and special fencing material. Before ordering, make sure the product you want to purchase complies with any zoning requirements in your area, particularly height restrictions on fences. There are a few to choose from:

- **Purrfect Fence**

- The company makes a system which can be added to existing fences as well as the free-standing system previously mentioned. Discounts are available for 501(c)(3) rescues and shelters. Go to www.purrfectfence.com or call 1-888-280-4066.

- **Cat Fence-In**

- Go to www.catfencein.com or call 1-888-738-9099.

- **Affordable Cat Fence**

- Go to www.catfence.com or call 1-888-840-2287.

5. Food & Water

Food forms the basic connection between humans and feral cats. The cats reside at a specific location because there's a food source, almost always supplied by people in one manner or another. What kind of food is provided and how can go a long way in determining the health of the colony and the quality of relations with neighbors. That said, every colony is different and caretakers must adapt to the conditions at their site as well as balance their own time and budgetary constraints. As is so often the case with feral cats, you do the best you can.

- **Feeding stations**

- ***Placement***



photo: Meredith Weiss

Where to place the feeding station is the first thing to consider when setting one up. Ideally, the spot will be easily accessed by the caretaker, but out of sight and not accessible to the public. The privacy protects the cats and allows them to feel secure about using the feeding station. This is why, if you live in a house and the colony is often on your property, it would be much better to feed in the backyard where few people would see or have access than in the front driveway.

It is not always possible to feed out of sight and at a location other people can't reach, but aim for getting as close to this as you can. If your colony is in a lot that people walk by, feed as far away from the sidewalk as possible and hide the food and water behind a wall or pile of rocks. If the cats live behind a factory, pick a spot that's little traveled and shield it from view behind some old boards.

Many times, the visibility of a feeding station is directly related to how often cats are abandoned at a site. The more people see cats are being cared for at a certain location, the more likely someone will choose to abandon an animal there. It's another reason for being discrete.

If the location is secure, you can store food on site. For dry food, use a weatherproof storage container like a Vittles Vault, available at PetSmart and Petco stores and many online retailers. Store the container inside a Rubbermaid bin near the feeding station.

- ***Type of feeding station***

The perfect feeding station shields the food and water from the elements and has room for a cat or two to be inside while eating. The type of station you set up will depend on where it's located and what the property owner will permit. If you feed in a spot open to the public, you might not be able to put out equipment that could be easily damaged or removed. Or if the property owner won't allow you to use a structure of any kind, your options are also limited. On the other hand, if you're feeding in a private location that you own and have complete say over what goes where, you can be as elaborate as you'd like. The goal is to get as close to the ideal as circumstances allow.

- **Rubbermaid bin**

You can turn a Rubbermaid storage bin into a station by cutting out an opening in one of the longer sides of the bin with a box cutter, leaving a lip of about three inches off the ground to keep out any ground water from rain (*Figure 5-1*). A large opening like this is needed to prevent a dominant cat from going in and keeping everyone else out.



Figure 5-1

Rubbermaid brand bins are recommended because, in our experience, they are better made for the rigors of the outdoors, like freezing temperatures, and will last longer before cracking and needing to be replaced. If you use a box cutter to make an opening, start by tracing the doorway lightly with the edge of the blade, then keep re-tracing the same lines, cutting in a little deeper each time. Don't try to slice all the way through at once.



Figure 5-2

Instead of one large opening in the front, you can cut two smaller openings, one on each of the bin's narrower sides (*Figure 5-2*). Again, leave a lip of a few inches on the bottom. Having two doorways and not just one will help prevent one cat from taking over the whole cafeteria.

The bins in the photos are 55 gallons in size. If more suitable to the location, a smaller bin, such as a 30 gallon, can be used. If even a 30 gallon bin is too large and noticeable for your site, then try to use one that

will at least protect the food and water from the elements and allow the cats to stick their heads in to eat and drink. Feeding stations made from storage bins are easy to clean because they're plastic, have a removable top and are quick to assemble.

□ **Wood station**



Figure 5-3

If you or someone you know is handy, you can build a station with wood similar to the homemade one in Figure 5-3. Note how one side is completely open. The roof overhangs the front opening and is pitched towards the rear so rain will run off towards the back. The two by four “legs” on the bottom keep out rain and snow from the ground. To prevent rot, a wooden station should be coated with latex deck paint and the seams sealed with silicone glue.

Properly built wood stations will tend to last much longer than storage bins. You may be able to get scrap lumber from a home improvement store. You can also purchase a ready-made station (Figure 5-4) from **FeralVilla** (www.feralvilla.com), a company run by experienced TNR activists who also produce high quality winter shelters. Minimal assembly is required. Smaller version is available.

Keep your feeding station clean by lining the floor with an industrial-strength rubber or vinyl mat (known as “runners”). That way you can remove the mat and easily wash it down. The mats can be purchased at most floor stores or order online at Total Mats (www.totalmats.com).



Figure 5-4

▪ ***Automatic feeders and waterers***

If feeding the cats regularly is a problem, an automatic dry food dispenser and an automatic waterer can be put inside the station or at a spot protected from the elements. These gravity-driven devices are excellent when everyday access to the colony site is not available or when the caretaker will be away for a day or two. If you plan on putting these items inside a sheltered feeding station, be sure to check the station’s dimensions first so you buy equipment that will fit inside. Also, don’t buy too large a waterer if you’re going to have to carry jugs to the colony’s site in order to refill them. If wildlife frequents the site as well as the cats, avoid using automatic feeders unless the feeding station is built to deter other animals from joining in (see ***Don’t feed the wildlife***, below).

The Le Bistro line of automatic feeders and waterers is popular and well-made. The Le Bistro Feeder comes in sizes XS (holds 2 lbs of dry food), S (5 lbs.), M (10 lbs.) and L (20 lbs.) The Le Bistro Waterer also comes in XS (2 qts.), S (1 gal.), M (2.75 gals.) and L (5 gals.) Currently, they’re marketed under both the Petmate and Aspen Pet brands. You can find Aspen Pet Le Bistro products at Target (www.target.com). A search on

Amazon (www.amazon.com) for “Le Bistro” or “Petmate Le Bistro” will locate other retailers.

- ***Avoid overfeeding & attracting new cats***

One of the advantages of TNR is that a neutered colony of cats will guard their territory against intrusion by new cats, who will likely be unaltered, thereby preventing the reproductive cycle from starting up again at that location. The reason this occurs has to do largely with the amount of available food. If there is just enough available to provide for the colony cats, they are highly motivated not to allow newcomers to move in and share their meals. On the flip side, if more than enough food is always left out, what’s the harm in allowing a few guests to join in?

As a caretaker, you can control the quantity of food. The key is to feed your cats what they need to be well nourished, but not to be excessive and invite in the rest of the ferals in the neighborhood. Over time, as the size of the colony declines, the amount of food provided should be reduced accordingly.

- ***Clean up!***

One easy way to avoid friction with neighbors is to keep the area clean where you feed. Pick up and remove empty cans, plates, plastic spoons, etc., even if someone else left it there. Not only is a mess unsightly for residents, it could be considered unsanitary and result in a health code violation and fine for the property owner. If you can, help keep the general area clean and not only the feeding area. This will reinforce the impression your presence at the site is a benefit to the community.

- ***Don’t feed the wildlife***

If your colony is located in an area inhabited by wildlife, such as raccoons, skunks, coyotes or bears, you want to avoid attracting these other critters to your feeding station. The best way to do this is to not leave food out at night – most wildlife are nocturnal - and limit the time period in which the cats have food available. Alternatively, you can construct a feeding station which wildlife can’t access.

The ideal method of feeding in a wildlife-intensive location is to put the food out for a certain length of time, like half an hour, once or twice a day during daylight hours. Feral cats are very habitual creatures and will soon learn the routine. “The food comes out at 9 am and is gone by 9:30, so better show up on time,” is what they’ll learn. This avoids leaving any leftovers for other animals to scoop up. If putting out the food and waiting half an hour is not practical for you, then narrow the window of feeding as much as possible. For example, put out the food when you go to work in the morning, then pick up whatever’s uneaten when you come home. Whatever routine you develop, don’t leave food out overnight because that’s the surest way to train the wildlife when to come and dine.

With raccoons, skunks and opossum, it’s possible to build a feeding station which they can’t access, taking advantage of their inability to jump like a cat. Basically, you need to build a flat platform raised several feet above the ground which the critters can’t

climb. To accomplish this, the platform must be raised high enough that an animal like a raccoon can't stand up on his hind legs, grab hold of the edge of the platform and pull himself up. Next, the poles or legs supporting the platform must be covered with a smooth, hard surface which animals with claws, like raccoons, opossum and skunks, can't climb. Metal flashing will do the job. Attaching flashing around the edges of the raised platform will serve as a further deterrent.

To make it possible for the cats to jump up onto the platform, create a small "jump-off" structure close to the feeding station. It could be a couple of cinder blocks, one on top of the other. Put the jump-off structure close enough to the feeding station so the cats can easily climb it and leap up onto the platform, but not so close that wildlife could climb it, lean over and grab onto the platform.

For a description and photos of one wildlife-proof feeding station, see "Raccoons can't jump" at www.thewildones.net/raccoons.htm.

● Feeding tricks

▪ *Ants*

Ants can be kept out of food by building a small moat. Take a pan, tray or plastic container – anything flat, wide and with raised edges – and fill it with a quarter inch or so of water. Then place the cats' food in a bowl and place the bowl in the middle of the pan. The water will keep ants from reaching the food while the cats can easily lean over and eat, provided the moat isn't too wide.

If you want something fancier than a bowl in an aluminum tray, there are the Bugless Bowls at www.buglessbowls.com. They have a circular moat at the base which can be filled with water. There's also "The Mote" at www.antproofbowl.com, a waterless bowl whose shape – including a curved lip – prevents ants from climbing up and getting in the food. An online search for "ant free pet bowl" will locate any number of other inventive products.

Another trick for keeping ants out of the food is to draw a circle of "chalk powder" around the food bowls or feeding area. Chalk powder is composed of diatoms (fossilized marine microorganisms) and to an ant the edges of the diatoms are painfully sharp, so they won't attempt to cross the line. The product is used by gymnasts and in other sports and is available online. Before purchasing, check that it's real chalk and contains diatoms. You can also crush soft Crayola sidewalk chalk and use that.

▪ *Slugs*

Similar to ants, slugs will not cross a chalk powder line because the chalk *is* sharp for them as well. A circle with a thick line can be drawn around the food bowls or feeding station. Find chalk powder (made up of diatoms) or crush soft Crayola sidewalk chalk. You can also create a barrier to slugs by placing the food bowl on a large sheet of rough sandpaper.

Another way to keep slugs out of the food is to feed them separately. Sprinkle bits of dry food on the ground several inches away from the cats' bowls and dishes. The slugs

will be drawn to this easily reached food rather than go through the trouble of climbing up into the bowls.

- ***Flies***

Flies are mostly a problem when wet food is left out for an extended period of time in warm weather. They can be avoided by training the cats to eat at a specific hour each day, limiting the amount of time the food is available and removing any that's uneaten. Putting wet food out during the cooler parts of the day, like dusk, will also help. If you must, rely on dry food during warm weather. It will still attract flies, but not nearly as many as wet food.

If you want the deluxe solution to keeping flies out of the food, buy an automatic opening pet food bowl. Infra-red sensors detect when a cat is approaching and trigger the lid to open automatically. When the cat leaves, the lid closes. Operates on batteries. To find available models, search for "automatic opening pet food bowl" at Amazon (www.amazon.com).

- ***Rain***

If you can't place a covered feeding station on your site, you can still protect food from the rain on days when you expect wet weather. Take a round plastic container or take-out dish and fill it with dry food. Then take the lid of the container or dish, turn it upside down and place on top. Even upside down, the lid will keep the rain out. When the cats come by after the rain stops, they'll smell the food in the container and push the lid off to get at it.



- ***Fences***

If you feed through a fence and don't have easy access to the other side where the cats are, it's best to keep the food and water out of arm's reach of passersby. To do so, use an inexpensive device known as an "arm extender" or "extension grabber." These are the poles with clamps on the end that you see used in retail stores when an employee is reaching for an item on a high shelf out of arm's reach. They can be found in many hardware stores or online. When feeding, fill the food and water containers and place them under or through the fence. Then use your "grabber" to push the food and water as far back from the sidewalk as possible. It's even better if you can push the dishes behind a bush or pile of rocks and hide them at least partially from view.

- ***Pigeons***

Pigeons, like most birds, nest and sleep after the sun goes down. One way to avoid having them eat the cats' food is to feed at dusk or after dark. However, this can be

problematic if you're also faced with other wildlife which is nocturnal. In that case, you may want to train the cats to come eat during a limited window of time during daylight hours. When the time's up, remove any uneaten food.



Figure 5-5

entrance(s) to your feeding stations (*Figure 5-5*). Birds will be unwilling to push through the dangling strips but the cats will quickly learn to navigate past them.

Your feeding station can also help deter pigeons and other birds. Most pigeons will be reluctant to enter a confined space, so using a Rubbermaid bin as a feeding station with the openings cut in the narrow sides (*see Figure 5-2*) will deter them from going after the food. For an extra safeguard against pigeons entering the feeding station, use a piece of thick plastic a couple of inches larger than the doorway on all sides. Cut the plastic length-wise into inch-wide strips, leaving a two inch border uncut at the top. With duct tape, attach the plastic over the

• Preventing water from freezing

A common problem in cold weather climates is preventing the cats' water from freezing during the winter. While cats usually drink very little water, they do need some. This is especially true when they're being fed mostly dry food, as is often the case in wintertime when wet food can quickly freeze. There are a number of ways to keep the water unfrozen or at least slow down the freezing process. Which method you choose will greatly depend on the conditions at your colony's site. If you're feeding the cats in your own backyard, then an electrically heated water bowl is an option. But if you travel to a vacant lot and feed behind a pile of old tires, putting the water inside a Styrofoam cooler in a deep, thick plastic bowl may be your best choice.

One common myth is that it's better to put out hot water than cold because the hot water supposedly will take longer to freeze. The reverse is true. Warm water evaporates quickly in cold temperatures, leaving less water in the bowl. The lesser quantity will freeze faster than if colder water had initially been used. In other words, don't heat up the water!

Here are some ideas to keep the tap flowing:

▪ *Electrically heated water bowl*

This is the ideal solution when feasible. The bowl can be purchased in plastic or stainless steel, comes with a weather protected power cord and keeps the water heated at all times. The water will evaporate relatively fast, so the bowl should be able to hold at least a gallon of water and will need to be re-filled daily. Wet food can be placed in this type of bowl as well to prevent it from freezing, but will quickly dry up. KV Supply offers the plastic and stainless steel versions, both coming with 70 inch power cords – do

a search for “heated water bowl” (www.kvsupply.com or call 1-800-423-8211). A search on Amazon (www.amazon.com) will turn up other models and retailers.

- ***Solar heated water bowl***

Solar Sippers from the Happy Bird Corporation use the sun to keep water warm and prevents freezing at 20 degrees Fahrenheit and above. Go to www.solarsippers.com/main.html, click on “Solar Sipper Water Stations” in the left-hand menu and look for the “Pet Sipper” (Models 10011 and 10012).

- ***Immersion heaters***

For those locations where electricity and solar power are not available, the Happy Bird Corporation has designed a cordless, battery-powered heater than can be immersed in the water bowl. A smaller heater will prevent one quart of water from freezing at 20 degrees Fahrenheit for two hours, while the largest one prevents freezing at that temperature for eight hours. Go to www.solarsippers.com/main.html and click on “Solar Sipper Water Warmers.”

- ***“Snuggle Safe” heating pad***

The *Snuggle Safe* heating pad is a plastic disc that measures nine inches in diameter and is designed to keep pets’ bedding warm on chilly nights. Six minutes in an average microwave oven will heat the disc enough for it to provide as long as 12 hours of warmth in an indoor setting. For purposes of feral cat caretaking, the heated up disc can be placed under a water bowl to prevent freezing for two to three hours in frigid conditions. Having two disks on hand is convenient. That way you can leave a fresh warm one on site while you take the used one home to be reheated.

The disc can also be used to provide added warmth inside feral cat winter shelters (see Chapter 6.) Place the disc inside the Snuggle Safe cover or wrap it in thick cloth before placing it inside a shelter. The product is available at Entirely Pets (www.entirelypets.com). Other online retailers can be located by doing a search for “Snuggle Safe heating disc.”

- ***Styrofoam cooler***

Buy a medium sized Styrofoam picnic cooler – one of the white ones normally used for holding beverages or lunches on summer excursions. They measure approximately two feet long by one foot wide and are available during warmer weather, so you may need to think ahead. With a box cutter, cut out a six inch by six inch doorway in one of the narrower sides. Place the water bowl inside at the far end opposite the doorway and cover the cooler with its lid. The Styrofoam’s insulating quality will slow down the freezing process. Don’t use too large of a cooler or the cats might use it as a shelter. Winter shelters for ferals need to be dry at all times to safeguard their health, so you don’t want them sleeping in the water station and getting wet.

- ***Styrofoam vaccine shipping container***

Vaccines are typically shipped to veterinarians in small Styrofoam boxes measuring about 8 inches long by 4 inches wide. Line the inside of the box with a leak-proof plastic bag and cut a small circular hole in the top of the box just large enough for a cat to drink from. Fill the container with water. The Styrofoam will slow down the freezing.

- ***An old tire and rocks***

Find an old car tire that's been removed from its rim and stuff it full of rocks. In the center hole of the tire, wedge a container like a large bucket and fill it with water. Use more than one tire if necessary to completely surround the container. The tire absorbs sunlight and warms the rocks, which then radiate heat, slowing down the freezing process. This method is used to provide water to horses in pastures.

- ***Deep and thick plastic bowls***

The type of bowl you use can make a big difference. Bowls made of thick plastic provide more insulation. The best bowl will be thick, deep and have a narrow width (in order to slow freezing, the opening at the top should be small relative to the volume of water held). It also helps to place the bowl so it's exposed to sunlight and protected from the wind. Black or dark colored bowls will absorb heat from the sun better than light colored ones.

- ***Add water to wet food***

If the cats come when you're there and will eat right away, add a little extra water to their wet food to help them get the moisture they need.

- ***Place the water bowl near heating pipes inside building walls***

If you're feeding in an alleyway between buildings, try to put the water bowl next to where a heating pipe is located inside a wall. You can find the pipes by touch or observe whether the cats tend to gather in a particular spot near the wall. If they do, it may be because the spot is warmed by a heating pipe.

- **Preventing food from freezing**

Because of its high moisture content, wet food left sitting out in cold weather will freeze and become impossible for the cats to eat. This is why, in colder climates, dry food often becomes the staple for feral cats during the winter. Even if you do manage to feed some wet food, it's a good idea to leave dry food out as a backup.

Freezing can be avoided by placing a bowl of wet food inside an insulated winter shelter. While the cats are inside, the shelter will trap their body heat and keep the



photo: Meredith Weiss

interior warm enough to prevent or reverse freezing of food. Before you place wet food inside a shelter, check first to make sure there are no cats sleeping in there. If the coast is clear, place a small bowl of wet food in the corner of the shelter furthest from the door. Be sure to remove any uneaten food and replace it with fresh fare – you don't want the cats to eat food which has been frozen, thawed, then frozen again. That's a way for the food to become contaminated. To be safe, you could put a small bowl of dry food inside the shelter instead of wet.

Only place food in a shelter; *never* put water inside. For the cats to stay healthy over the winter, their shelter must be kept dry. A container of water could easily spill, dampening the interior and getting the cats wet. Also, discontinue putting any food in the shelter if you find it is attracting insects or wildlife.

Some of the products for preventing water from freezing may also assist with stopping wet food from becoming frozen, like the heated water bowl or the Snuggle Safe heated pad. The problem is that as the wet food is warmed, the moisture in the food evaporates and the food dries out. So these products will be helpful only if the cats come and eat the food quickly.

• **Nutrition**

We believe the guiding principle when it comes to colony caretaking is feral cats should be fed the highest quality food you can comfortably afford. This principle takes two important considerations into account. First, nutrition is important for ferals who often endure a physically demanding and stressful outdoor life. There is no better way to help boost their overall health than to feed them well. Second and equally important are your own financial circumstances. There's no glory in feeding the cats premium brand food if this means you can't pay your rent. Your well-being matters too, and you must be able to afford what you're spending on the cats. If you're managing a five cat colony and the extra cost for high quality canned food won't make much of a dent in your budget, then that's a good choice to make. On the other hand, if you're feeding 30 cats in multiple locations and buying the large bags of Kirkland dry food at Costco because that's what you can afford, then that's the best choice and no less of a sacrifice.

In order to choose which food within your budget is the best quality, you need to know a bit about cat nutrition. Here are some of the basics:

▪ ***Interpreting the ingredients label***

One quick way to evaluate the quality of cat food is to read the ingredients label. This won't tell you everything you need to know, but it's a good start. The ingredients are listed in the order of greatest quantity. If the first ingredient listed is "turkey," then

turkey is the largest ingredient. If the first ingredient is “corn meal” followed by “turkey,” then the food contains more corn meal than turkey.

It may not be readily apparent what some of the ingredients listed actually are. For example, many lower quality foods list “by-products” as an ingredient. The label might list “meat by-products,” “poultry by-products,” “fish by-products,” etc. Most people assume this is some part of the animal normally consumed by people, too. In fact, by-products are the waste parts of the slaughtered animal. They may include feathers, hair, hooves, eyeballs, moldy, diseased or rancid meat rejected for human consumption, fecal waste, or any other part of the animal you’d have thought would be tossed out.

If a food lists by-products on the ingredients label, especially if it is one of the first few ingredients listed, don’t be fooled by the tasty-looking sauces, neatly cut slices or artificial coloring. By-products are almost always less nutritious than their whole counterparts no matter how nicely they’re dressed up, meaning the ingredient “beef” will be healthier than “beef by-products.” Don’t assume either that a food full of by-products must be healthy because your cats love to eat it. Poorer quality foods often have added sweeteners and fish flavoring to hook your felines.

Pet food manufacturers use by-products because they’re cheap. This is why, with pet food, you usually get what you pay for. Many brands of food available in high-volume stores like supermarkets or large discount stores which are inexpensive often contain by-products as one of the first ingredients listed on their labels. But beware, there are some brands which trick people into believing they’re high quality simply because they cost more, but they too consist largely of by-products or other inferior ingredients. Always read the label and don’t go by price alone.

Another ingredient to watch out for is any kind of meat “meal,” such as chicken, fish or turkey meal. In the cheaper brands of food, meal is often the same waste parts of the carcass as by-products, just ground into an unrecognizable form. “Animal digest” is another ingredient that can be of questionable nutritional value.

What you want to see listed first on the ingredients label are whole meats, such as “chicken,” “beef,” or “turkey.” With few exceptions, the better brands will not contain any form of by-products or meat meal.

Another common ingredient used heavily in lower quality foods, especially dry food, is some form of corn. The label might read “corn meal,” “ground yellow corn” or something similar. Cats are carnivores and do not satisfy their basic nutritional needs from grains. If corn is the first ingredient on the label, then the largest part of the food consists of something that has little nutritional value for the cat and is basically only filler. It would be like having a meal yourself with the largest portion being potato chips. You’ll get full, but it’s hardly a healthy diet.

Also check the ingredients for unnecessary sweeteners like corn syrup, blueberries, brown rice syrup or beets. These all contain sugars meant to improve the taste. Any kind of chemical, such as artificial coloring, artificial flavors, scents and artificial preservatives, should be avoided, if possible. Artificial preservatives include BHA, BHT, propyl gallate, nitrates and benzoate of soda.

Knowing the real makeup of cat food empowers you as a caretaker to make educated choices. It doesn’t mean you’re doing something wrong if you decide to purchase foods containing by-products or corn meal. The reality is that the higher quality brands without these ingredients tend to be much more expensive. The bottom line is whatever choice of

food works best for your budget, the cats are better off because you care enough to donate your time and funds towards feeding them.

- ***Wet vs. dry food***

Generally speaking, a wet food containing a certain quality of ingredients will have more nutritional value than a dry food of the same quality. This is because the dry food goes through a baking process which dries out the meats and, in so doing, loses some of the ingredients' nutritional content. In many cheaper brands of dry food, vitamins and minerals are added *before* the baking process, with the result they are often destroyed in the oven. The better quality brands add the supplements after the baking, which is another reason why they cost more.

There are some common misconceptions about dry food. One is that it should be left out all day so a cat can eat whenever he wants. In fact, this practice, especially for pet cats, is potentially damaging to a feline's health. Cats in the wild are not "grazers" like cows, who are constantly eating. Instead, they are "feast and famine" animals. They kill their prey, gorge upon it and then might not eat again for several days. The digestive systems of the two types of animals are not the same. Feast and famine animals need time away from food for their systems to stop working and clean themselves out. If they are constantly eating or even constantly smelling food, their digestive systems never turn off. As the cat ages, this can result in kidney and liver disease.

With indoor cats, the optimal way to feed is to leave food out twice a day for no more than 20 to 30 minutes, then take what's left over away and don't put out more food until the next meal. With feral cats, that kind of routine is also optimal, but often not possible and a steady supply of dry food must be left out during at least some part of the day to ensure all the cats in the colony get fed. It's not as much of a problem though because outdoor cats tend to not be as obsessed with eating as their indoor counterparts and are less likely to hang out at the food bowl all day.

Another myth is dry food is good for cleaning a cat's teeth. Possibly dry food provides some minimal exercise for the jaw, but that's about it. Prolonged chewing and gnawing at something hard is required for a cat's teeth to be scraped clean. Raw bones, especially raw chicken necks, will achieve this. Cats can digest raw bones and in the wild they derive the calcium their bodies need from them. The bones and necks must be raw because cooked bones can splinter and cause injury. Cooked bones should never be fed to a cat. As with raw meat, it's important uncooked bones or necks be very fresh to avoid bacterial buildup and illness. With chicken bones, using organic only is recommended.

- ***Adding ground beef***

One way to substantially and inexpensively improve the nutritional content of low quality cat food is to supplement it with ground beef, preferably ground chuck because of its high fat content, which is good for cats. Unadulterated, 100% meat is great for cats. If you do add ground beef though, always remember you must also mix in the correct amount of calcium in order to balance the phosphate content of the meat. Otherwise, you could cause the cats to develop frail bones and other long-term health problems. The

correct proportions are one teaspoon of either calcium lactate or bone meal for each one pound of ground beef.

Ground beef with its calcium additive can be mixed into wet food or fed as an extra dish on the side. Mixing it with dry food creates a real mess so you want to avoid that. If you want to go the extra yard, add chopped-up and cooked broccoli, zucchini or carrots to the beef/calcium recipe. The vegetables need to be cooked, preferably steamed, or the cats won't be able to digest them. Dried barley is also nutritious. Never add onions in any form – they're potentially toxic for cats in even a small amount (like chocolate).

Fresh (emphasis on "fresh") ground beef, mixed with a calcium supplement, can be fed to the cats raw and uncooked. Raw meat is the most natural diet for cats who, after all, when they catch a mouse, don't cook it first before dining. But raw meat must be fresh, meaning it was put out that day at a reliable store and shows no outward signs of browning. If it concerns you to feed meat raw, then lightly cook it. It will still greatly improve the quality of the cats' diet. Chicken and turkey can also be used in place of the ground beef (adding calcium in the same proportions: one teaspoon per pound). However, because of its greater susceptibility to bacterial buildup, it's recommended you do cook poultry unless it's very fresh and organic.

Don't feed the cats only the ground beef mixture described here, but use it as a supplement. If you want to feed only a self-prepared raw or cooked meat diet, you need to learn more about cat nutrition, including what vitamins and minerals to add. These books are excellent resources for learning more about preparing your own cat food:

- ◆ "The Natural Cat," by Anitra Frazier (Penguin Books, 2008)
- ◆ "Dr. Pitcairn's New Complete Guide to Natural Health for Dogs & Cats," by Dr. Richard Pitcairn, DVM (Rodale Press, 2005)

If you're interested in learning more about what goes into manufactured cat food, Ann M. Martin has written excellent and highly informative books on the topic:

- ◆ "Food Pets Die For (2nd ed.)," by Ann N. Martin (NewSage Press, 2002)
- ◆ "Protect Your Pet: More Shocking Facts to Consider," by Ann N. Martin (NewSage Press, 2001)

● **Vitamin C to the Rescue**

by Anitra Frazier, author of "The Natural Cat"

It is certainly easier, cheaper and a lot more pleasant to prevent illness than it is to trap a sick cat, transport him to a vet and then try to diagnose and treat the frightened animal.

Vitamin C, the first vitamin discovered by humankind, is truly a friend to the caregiver of a feral colony. An efficient healer and powerful protector, it works like a nutritional knight in shining armor fighting against invasions of germs and viruses and battling stress of all kinds. Germs, viruses, dirt, x-rays and chemicals such as antibiotics,

steroids, tranquilizers, anesthetics, pesticides and the preservatives in commercial pet foods have all been shown to use up large quantities of Vitamin C.

In addition, this versatile vitamin is user friendly. It is water soluble and cannot be stored by the body so an overdose is, for all practical purposes, almost impossible. While 250 milligrams is the maximum dose that a cat can absorb and put to use at one time, if more is given, the excess will simply be excreted via the urine and none will linger behind in the body.

Healthy cats can make some Vitamin C in their intestine. The operative words here are "healthy" and "some." Cats can manufacture enough C only if the diet is rich in all the other nutrients they need and only if daily stresses do not become too numerous, too extreme or too prolonged. Stresses such as extreme heat or cold, fighting, being wounded or hurt, being trapped or caged, loud noises, strong, unpleasant smells or forced change of territory use up Vitamin C at an alarming rate. Even a healthy, well-nourished cat can use up more Vitamin C than he can produce if faced with a high level of stress. Depletion of this vitamin leaves a cat easy prey to every germ or virus that happens along.

Any trap-neuter-return project will include the cats being trapped, caged, undergoing surgery and anesthesia and having other medications administered. These are all potentially stressful to the cats and can result in upper respiratory and other diseases. What we need here is a knight in shining armor to bring the cats safely through all this. Enter Vitamin C. This inexpensive and easily obtainable supplement will greatly enhance any cat's chance for a full recovery.

There are three main types of Vitamin C in general use. Each has its own particular strengths and drawbacks, but all will provide Vitamin C to the cats:

- **Ascorbic Acid** is the cheapest and most popular form of Vitamin C. It is readily available in pill or powder form from health food stores and pharmacies. On the plus side, ascorbic acid helps keep the urine acidic, thereby preventing bacterial growth and inhibiting formation of crystals. Here's how it works: a cat's body can absorb only 250 mg and no more at one time. If more is administered, the body will dispose of the excess by sending it out in the urine. Ascorbic acid raises the acidity of the urine on the way out, which is why holistic caregivers use it in doses greater than 250 milligrams to help dissolve bladder stones and crystals. The only drawback to this form of Vitamin C is its acid or sour flavor – cats don't like it if too much is given. I counteract this by mixing it into a food with a strong flavor of its own. Petguard Savory Seafood or Fish, Chicken & Liver do the job nicely. For really finicky cats, I give only a half dose (125 mg) or even a quarter (62.5 mg).
- **Sodium Ascorbate** provides the same amount of Vitamin C as ascorbic acid and is almost as cheap. If more than 250 mg is given at one time, the

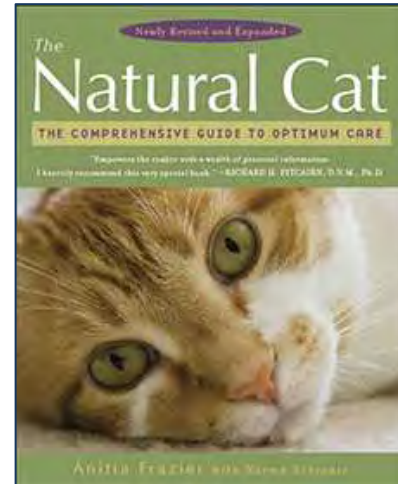

excess will also be excreted harmlessly, but will not acidify the urine because sodium ascorbate is alkaline. On the plus side, its flavor is milder and it is the most readily accepted by cats of the three types of Vitamin C, although as with ascorbic acid, it's a good idea to add some fish-flavored food to cover the sour taste. So if there is no reason to worry about the acidity of the urine and you simply want to give a Vitamin C supplement, sodium ascorbate is the one I would choose.

- ***Calcium Ascorbate*** is very popular for use in humans because it is very alkaline instead of acidic. It is used by people who suffer from ulcers or hyperacidity because it tends to neutralize stomach acid. Unlike with humans, the stomach of a healthy cat is supposed to be extremely acidic to facilitate the digestion of protein, so calcium ascorbate can upset this balance. Another drawback when it comes to cats is its very bitter taste. A person can pop it down as a pill, but for cats we have to use a powder form and mix it into the food. It makes the whole meal taste bitter. It's also a bit more expensive than the other two types. I don't use it at all.

When found in its natural state in foods like tomato sauce, Vitamin C is accompanied by bioflavonoids, rutin and hesperidin. Science has found that these nutritional sidekicks are provided by nature to help the body absorb the C and put it to work more efficiently. A cheap jar of ascorbic acid in powder form will certainly give wonderful support and protection and it will help keep the urine acid as it should be, but C complex (ascorbic acid with bioflavonoids, rutin and hesperidin) will do a lot more for only a little more money. Health food stores will have several choices available. I use Twin Lab Super C, yellow label.

Vitamin C does not need refrigeration but you must keep the contents of the bottle dry. Use a clean, dry measuring spoon. Because C cannot be stored by the body, it must be given every meal and can be continued indefinitely. A maximum dose of 250 milligrams equals about 1/8 teaspoon. Because the presence of moisture causes it to lose potency, mix it into the food right before you feed. If everything is going well for a colony, I recommend giving only 125 milligrams or 250 for each two cats. If the weather turns harsh or some other stress presents itself, try to increase the dose to 250 milligrams per cat. During trap-neuter-return projects when stress will skyrocket, give the full dose for two days before trapping. During confinement and treatment, feed three or four small meals a day in order to get the C into them more frequently. If a cat objects to the sour flavor, as happens occasionally, cut the dose down by half or use just a few grains. Any amount is better than zero. Remember to try adding a "bribe food," something they love that has a strong flavor. You can also sprinkle brewer's yeast on top.

Tomato sauce is a rich natural source of Vitamin C complex. If you know that a colony enjoys it as part of the food mix (most do), make sure to include it along with the supplement in times of stress. I prefer Muir Glen organic tomato sauce. Mix 1 or 2 tablespoons in a large 14 oz. can of cat food.

Remember, Vitamin C cannot be stored by the body so always giving a little with every meal is like a mini-insurance policy. Adding 2 tablespoons of tomato sauce to each large can of cat food is a delicious way to accomplish this. Then, if there is inclement

weather, loud construction work nearby, injury or any other stress, add up to 250 mg per cat per meal of Vitamin C powder to a strong flavored food until the disruption is past. After the stress is over, go back to adding the tomato sauce to each meal.

Because we are practicing prevention, caregivers may find it difficult at first to pinpoint a clear demonstration of results. The benefits are mostly about what does not happen. Cats do not die under anesthesia; wounds do not become infected; there is no outbreak of respiratory infections shortly after a new cat arrives in the colony. Resistance is high; the cats are more resilient.

I would not feel even half as secure about managing a feral colony if I didn't have the help of Vitamin C, my trusty knight in shining armor, to back me up.

• Preventing urinary tract disease

A colony's diet may include a relatively large amount of dry food, either for reasons of cost, convenience or weather conditions. The concern, especially with male cats, is that ash in the dry food can result in crystals forming in the bladder, leading to a condition known as Feline Lower Urinary Tract Disease. In the worst cases, where blockages occur in males, the condition can be fatal. Unlike with a pet cat, who is normally closely observed as a matter of normal routine, it can be difficult to detect urinary tract disease in a colony cat. Prevention is really a caretaker's best strategy and fortunately, an excellent preventative does exist – D-mannose.

As described by Dr. Michael Dym, VMD, a leading homeopathic and holistic veterinarian (www.doctordym.com), "Adding D-mannose to a colony's food may offer preventative benefits for cats with underlying urinary tract issues, and may help protect males at risk for urinary tract blockages. This natural glycolnutrient, which is naturally found in cranberries, binds to sites in the urinary tract where E coli bacteria attach, and therefore clears the lining of the bladder and urethra of these type of bacteria, as well as harmful substances including kidney and bladder crystals." It can also be used during flare-ups of urinary tract symptoms or preventatively in cats predisposed to urinary tract disease.

According to Dr. Dym, in acute situations, D-mannose can be given in dosages as high as one level teaspoon (2 grams) every hour for up to 4 doses. It can be easily dissolved in water or added to the food. In more chronic situations, he recommends dosing at 1/8 to 1/4 teaspoon (250 to 500 mg) daily. It can safely be added to the diet long term at this dose and is even safe to use in pregnant or nursing cats. Because it is not digested or metabolized in the cat's body, problems with toxicity associated with the use of D-mannose have not been observed.

At Neighborhood Cats, we've administered D-mannose to cats with symptoms of urinary tract disease and have seen the condition quickly clear up. Providing it in a colony's food on a regular basis can help keep crystals and blockages from occurring in the first place. D-mannose is relatively expensive, but even dosing once a week or during times of heavy reliance on dry food will be a big help in maintaining the cats' health.

6. Winter Shelter



photo: Meredith Weiss

Feral cats are adept at finding shelter and a place to sleep out of the rain and out of sight. In warm weather, shelter is usually not a problem for them although you still might provide them with a cozy place just to make sure. When the temperature drops and winter sets in, that's when they most need your help. Without a warm, dry place to bed down, the cats can fall seriously ill. In severe climates, cats can get frostbite on their ears, nose and paws. Providing adequate winter shelter is one of a caretaker's primary tasks.

There are probably as many ways to build adequate shelter as there are creative caretakers. All good designs share two elements: good insulation and limited air space. The insulation is needed to trap the cats' body heat, effectively turning the cats themselves into little radiators. The interior of the shelter should be just large enough to hold the cats and have as little empty space left over as possible to limit the air space that needs to be heated. Both good insulation and minimum air space are needed – one without the other won't work. A large, well-insulated dog house won't do because there will be too much empty space to warm above where the cats are lying. On the other hand, a tight-fitting space with thin plastic walls, like a carrier, won't do the trick either because the cats' body heat will pass right through the plastic.

Keeping these design factors in mind, it's better to build two smaller shelters which will hold three or four cats each, than one large shelter to house six to eight felines. That way, if only one or two cats enter one of the smaller shelters, enough heat should be generated to warm the interior. But with the larger shelter, if only a small number of the cats use it at the same time, there will be too much empty space and the temperature will remain cold.

The shelter designs described below incorporate these two key elements of adequate insulation and as little empty space as possible.

Your cats may not take to the shelter right away. Try leading them inside with trails of treats like Pounce, or enticing them by sprinkling dried catnip inside or with catnip spray applied around the entrance. Send the message "this place is OK" by placing objects with familiar scents, like favorite toys, in the interior. Door flaps or any other type of windbreaker over the doorway may initially be frightening so wait to add those until the cats are comfortable coming and going. And remember, patience is key.

- **Types of shelters**

- ***The Neighborhood Cats Winter Shelter***



Our favorite shelter was invented by Karen Hancock of Port Washington, NY. It's made from a single 8 ft. x 2 ft. sheet of hard, two-inch thick Styrofoam, which is pink or blue in color and available at most lumberyards and large home supplies stores like Home Depot or Lowe's (but call first!) It's lightweight and made for home or building insulation.

The exact, step-by-step instructions on how to build a shelter from the Styrofoam sheet are in ***Appendix B***. The first step - cutting the 8 foot sheet into smaller pieces - is the only one where you might need some help. In order to keep the edges straight so the pieces will fit together properly, a table saw should be used. It's difficult to get straight cuts by hand because of the thickness (2") of the material. Once the pieces are cut, all that's needed is to carve out a doorway, apply self-sticking linoleum tile to the floor, glue the pieces together, seal the seams and put on a couple of coats of paint.

When completed, the interior space of the shelter measures 18" W x 20" L x 12" H. Three or four cats can fit comfortably inside, but even with only two cats, there is relatively little air space and the two-inch Styrofoam is excellent insulation. In an experiment one cold winter night, a volunteer taped a thermometer to the interior roof of one of these shelters, which had a plastic flap over the doorway. The outdoor temperature was 11 degrees Fahrenheit. After two cats had been inside for an hour, the thermometer in the shelter's interior read 56 degrees Fahrenheit.

Out on the colony's site, the shelters should be weighed down – they are strong but light. A large rock or heavy board can be placed on top. If a pair of shelters is being used, place them about a foot or two apart with the front doors facing each other. Bridge the gap between them by resting a board two feet wide and at least a few feet long on the roofs of the two shelters. Then weigh down the board. This arrangement cuts down on wind getting inside the shelters and offers more protection from rain. The covered area between the shelters can be a good place to put food and water.



photo: Cecilia Pollak

The shelters should be coated with Latex deck paint, using a color like grey, green or brown, that will blend the shelters in with their surroundings. The paint will make the shelters less noticeable and longer lasting.

▪ ***Feralvilla Outdoor Cat Shelter***

Don't want to build a shelter from scratch? Feralvilla (www.feralvilla.com) makes a pre-fabricated wood shelter that you can assemble with a screwdriver. The two-level cat house comes painted and with a full shingle roof and insulated living area on the second floor. Assembly takes approximately fifteen to thirty minutes.



The overall size is 22" wide by 22" deep and about 22" tall at the peak of the roof. The upper, insulated "bedroom" is about 20" wide by 20" deep and the height varies from 10" to 12".

From Feralvilla, you can also buy a box of straw for further insulation in the interior. Also check out their feeding stations.

Trying to find a gift for the "Feral Who Has Everything"? Check out the ultra-luxury outdoor cat houses available at Stabobs Pet Houses (<http://store.stabobspethouses.net>).

▪ ***The CSM Stray Foundation Winter Shelter***

This shelter was designed by CSM Stray Foundation (USA), Inc., of Queens, NY (www.csmstray.org):

Materials & tools needed:

- Large Rubbermaid storage bin with removable lid (at least 30 gallons) – it's important to use the Rubbermaid brand or your bin may crack in freezing temperatures
- 8 ft. x 2 ft. sheet of one-inch thick hard Styrofoam
- Straw
- Yardstick
- Box cutter



photo: Carole S. Milker

To assemble:

1. Using the box cutter, cut a doorway 6 inches by 6 inches in one of the long sides of the bin towards the corner. To prevent flooding, cut the opening so that the bottom of the doorway is several inches above the ground. Don't try to slice all the way through the plastic at once, but keep re-tracing the outline of the doorway with the blade, cutting a little deeper each time around.



2. Line the floor of the bin with a piece of Styrofoam, using the yardstick and box cutter to cut out the piece. You don't need an exact fit, but as close as you can.
3. In similar fashion, line each of the four interior walls of the bin with a piece of the Styrofoam. Again, perfect cuts are not necessary. Leave a gap of three inches between the top of these "wall pieces" and the upper lip of the storage bin. There needs to be room for placing an interior Styrofoam roof.
4. Cut out a doorway in the Styrofoam interior wall in line with the placement of the doorway already cut out in the storage bin.
5. Stuff the bottom of the bin with straw, shredded newspaper or other insulating material to hold the Styrofoam wall pieces in place. You can also use scrap pieces of the Styrofoam to wedge between the walls of the bin and the inner Styrofoam walls to create a tighter fit.
6. Cut out a Styrofoam "roof" to rest on top of the Styrofoam wall pieces.
7. Cover the bin with its lid. Again, you can put scrap pieces of the Styrofoam on top of the inner Styrofoam roof to push the roof down when the lid is attached and create a tighter fit.

This shelter is easy to clean by taking off the lid and the Styrofoam roof. It's also lightweight and may need to be weighed down when placed on site. A flap of thick plastic over the doorway, attached with duct tape, is optional.

▪ *Styrofoam boxes*

Restaurants and grocery stores often receive meats and fish in Styrofoam boxes. Meat companies, like Omaha Steak, use them for shipping their products as well. The excellent insulation keeps the products cold or frozen and will also work to trap a cat's body heat. If you ask around, you'll likely find a place that will donate them to you. They come in all sizes – some will provide enough space for only one cat, others may hold up to three. To turn them into winter shelters like the one pictured here:



1. Glue the lid onto the top of the box, using silicone glue (preferably a variety that can be painted over; should say “paintable” on the label). Be generous with the glue because it will also act as a sealant to keep out rain and drafts.
2. Using a box cutter, cut a 6 inches x 6 inches doorway in the middle of one of the narrower sides. Make the bottom of the doorway several inches above the ground to prevent flooding.
3. With latex deck paint, paint the exterior to match the surroundings.
4. Stuff the interior with insulating material like straw.

▪ *Cardboard boxes*



In a pinch, a simple cardboard box will work as a temporary winter shelter because cardboard does provide some insulation. Using duct tape, tape the top and bottom of the box closed, sealing all seams. Then cut a 6 inches x 6 inches doorway in one side of the box, towards the corner and a few inches off the ground. Wrap a plastic trash bag or thick plastic drop cloth around the box, generously taping it in place by wrapping duct tape around the bag and box. Cut away the plastic around the doorway and tape the loose edges to the box. Stuff the box with straw or shredded newspaper. If possible, raise the box off the ground, place it underneath something that will shield it, such as a tree, and lay a wide board on top for added protection and to weigh the box down.

Whatever type of shelter you use, if the roof is flat and strong enough, place a piece of plywood on top for added protection from the elements. The board should extend 12 inches beyond the front of the shelter and be of equal or slightly greater width. The extended roof will help shield the doorway and create a protected “dining area” where the cats can be fed in poor weather. For maximum protection, position two shelters with their doorways facing one another and use one piece of plywood to cover both roofs and bridge the gap between them.

● Doorway flaps

Doorway flaps help keep cold air out and warm air in. Flaps should not be added, however, until after the cats are used to going in and out of the shelter. They can be cut from a rubber or vinyl mat or a thick piece of clear plastic – something thick enough to block the cold, but flexible enough for the cats to be able to pull it open on their way in or push it forward on their way out.

Attach the flap above the doorway either with duct tape or, for a more permanent solution, with plastic nuts and bolts like those used to attach toilet seats to the bowl. For plastic nuts and bolts, drill two holes in the shelter above the doorway and cut corresponding holes in the flap. Then push the bolts through the flap and shelter wall and screw on the nuts.

● Insulating materials

Putting insulating materials inside the shelter will increase comfort and warmth for the cats. But they should only be used if the shelters can be periodically checked to see if the materials have gotten damp or too dirty and need to be replaced. If regular checkups are not possible, leave the interiors bare.

Only insulating materials which the cats can burrow into should be used. Common household items which the cats will only lie on top of, like blankets, towels or flat newspaper, will do more harm than good. These items, when they are underneath a cat, draw body heat out and actually make the cat colder.

Straw is the best insulating material to use. Hay is not good because it is damp to start with, prone to mold or rot, and may cause an allergic reaction and nasal sores in some cats. Shredded newspaper will also work as long as it's shredded enough to allow the cats to burrow into it. Ellen Perry Berkeley's book, *Maverick Cats*, offers an innovative idea - loosely fill a cotton pillowcase with Styrofoam peanuts, the kind used to pack fragile items for shipping. Then put the stuffed pillowcase inside the shelter. The pillowcase will conform to the cat's body and wrap her in the heat-capturing peanuts. (Berkeley, E.P., *Maverick Cats* (2001) New England Press.)

One exception to the rule of not putting anything in the shelter that the cats can only lie on top of is the “Mysterious Purr Pad” by Fleximat. The polyester pad absorbs and retains body heat, so it warms a cat from below and can be safely placed on the floor of a winter shelter. The item is often available at PetSmart (www.petsmart.com) and Petco (www.petco.com). An online search will find other retailers as well.

Another option is the *Snuggle Safe* heating pad mentioned in Chapter 5 in the section, “Preventing Water from Freezing.” Be sure to use the cover that comes with the product or wrap the disc well in a thick towel or pillow case so the cats don’t directly touch the disc while it’s still at its hottest.

• **Extreme cold**

In environments where the winter is especially harsh, extra measures may be needed. One proven technique is to line the interior walls of the shelter with pieces cut from a Mylar blanket. The blanket is made of a thin plastic coated with a metallic reflecting agent. When wrapped around a person, it creates warmth by reflecting body heat back and is a standard part of an emergency kit for people who may become stranded in their cars during winter. When the walls and/or floor of a winter shelter are lined with Mylar, the cats’ body heat is reflected back at them, increasing the interior temperature.

A Mylar blanket is very thin and light. During the shelter-building process, pieces can be attached to the interior walls with freezer tape (such as Scotch Freezer Tape) which is designed to stick at extremely low temperatures. For a more permanent fix, use carpenter glue, being careful to keep all traces of the glue between the Mylar and the walls and unexposed to the cats. Be sure to tuck in or cut off any excess Mylar at the seams so none of the material is loose and inviting to a cat to tug at or chew on. If only one side of the Mylar blanket is shiny, that’s the side which reflects heat and should be facing in, towards the cats.

A search for “Mylar blanket” on Amazon (www.amazon.com) will turn up numerous retailers. The product is very inexpensive, usually costing no more than a dollar or two per blanket. The product can also often be found at camping stores, Wal-Mart or other retailers with outdoors departments.

• **Placement**

As with placement of feeding stations, the more discrete, the better when it comes to winter shelters. With shelters, you have more choices because you don’t need constant access to them. However, it’s nice for the cats if their shelters are close to their feeding station so they won’t have to travel far in bad weather to eat.

The primary concern is security and putting the shelters in a spot where few, if any, strangers will have access or even see them. This protects the cats plus, the more secluded the shelters, the more the cats are apt to use them. They can be camouflaged by painting them to blend into their environment and also by covering them with boards, branches or other objects. If you can, put them behind something like a wall or bush rather than in front. If they can’t be hidden from view, try to place them behind a fence or other enclosure closed to the public. If the shelters are in a location where they might get damaged or stolen, don’t invest in expensive ones which will be costly to replace.

The cats are likely to spend much of their time near their shelters and feeding station, especially in severe weather. The placement of these items can be used to “herd” the cats to a less visible location and one more acceptable to neighbors, thereby improving community relations.

7. Preparations for Trapping

1. Establish a feeding pattern

When you're ready to trap, it will be much easier if the cats come to you at a time and place of your choosing, than if you spread traps throughout their territory, wait all day or night and hope they show up. To get them to come to you, you need to establish a feeding pattern. At least two weeks before the trapping, put out the cats' food at the same time and place on a daily basis. Cats are very habitual creatures and will quickly learn the routine. If you can't feed at the same exact time every day, stick to the pattern as closely as you can. For example, always put the food out in the morning or when you come home from work.

After the feeding, which should last about half an hour, remove any excess food. Don't leave food out all day if you can help it. Your efforts to establish a pattern will be thwarted if the cats know they can come any time they want and find food.

If you can't limit the feeding time to half an hour and must leave food out longer, then establish a pattern of arriving at the site at the same time and place every day and putting out something tasty like a can of tuna. The cats will learn that when you show up, so does the good stuff and this will motivate them to arrive at the appointed hour.

In choosing the time of day for the feeding pattern, anticipate the trapping to come. Make the trapping easier by picking a time of day when the site will be quiet and less trafficked. Also consider your own schedule and when you'll be available to trap.

If the cats are already used to showing up at a certain hour that would be inconvenient for the trapping, then gradually shift the feeding time to one that's better. For example, if the cats are used to being fed at midnight, then start putting the food out at 11 p.m. When they are used to coming then, start putting it out at 10 p.m., etc. Re-training cats in this manner may take longer than two weeks depending on how big the shift will be. If you don't have enough time to slowly change the cats' habits, then just put the food out at the time you want them to come. Before long, they'll probably figure out things have changed and adapt their feeding pattern accordingly.

2. Count and assess the cats

While you're establishing the feeding pattern, get an accurate count of the number of cats in the colony. If necessary, take notes or photos to log the cats and help you tell them



photo: Meredith Weiss

apart. Knowing the correct number, or at least an estimate, is important for scheduling the right number of spay/neuter surgeries and for borrowing the right number of traps. There's nothing worse for a clinic (and your reputation with them) if you schedule twenty spay/neuter appointments, then during the trapping discover there are only ten cats. If that happens, a substantial amount of the clinic's resources on your appointment day may be wasted. Getting a reasonably accurate count ahead of time avoids this.

Don't take anyone's word for how many cats there are unless it's a colony you're personally familiar with or the caretaker has already gone through the process of carefully counting. Most people are not used to seeing more than one or two cats at a time. When they see many at once, they're prone to believe there are far more than are actually present. As a result, most untrained people overestimate the numbers, though sometimes they'll undercount. A reliable figure can be arrived at only by carefully observing the colony over a period of at least a week or two.

In addition to counting the cats, assess if any are adoptable – there may be kittens young enough to be quickly socialized or abandoned adults who are still friendly. If adoptable cats are present, try to line up suitable foster homes before the trapping. If foster resources exist, these cats should be removed from the colony. This is safer for them and advances TNR's goal of reducing free-roaming cat populations.

Also observe whether any of the cats look sick, whether it's from being too thin, having runny eyes or nose, coughing or having an unkempt appearance. Make arrangements beforehand for appropriate veterinary care and don't assume it will be provided by your clinic as part of the spay/neuter surgery. Anticipate the possibility that ill cats may require extra recuperation time, especially if they need a course of antibiotics or other similar treatment, and arrange for the necessary holding space.

Often, when a colony as a whole appears sickly and many of the cats have upper respiratory infections or ringworm, improving the quality of their food and adding Vitamin C for a few weeks will have a profound impact. Ensuring they have warm, dry shelter in cold weather will also greatly help. The improved nutrition and shelter should be introduced as far in advance of the spay/neuter date as possible, giving the cats a chance to regain their health prior to the stress of capture and surgery.

3. Secure a holding space

The cats will need to be confined during the course of the trapping and while they recuperate from their surgeries. As described in detail in Chapter 11 (“Caring for Cats in Traps”), the traps double as cages which the cats never leave except during surgery. In a mass trapping, a space to hold the cats in their traps will typically be required for between four to six days.

An adequate holding space is one that is warm, dry and secure. “Warm” means at least 65 to 70 degrees Fahrenheit. While confined, the cats can't move around, huddle together or sleep in insulated shelters, so if the space is cold, they can get sick. In addition, during the spay/neuter surgery, a cat's body temperature drops and does not return to normal until they have fully recovered from the anesthesia. If a cat is placed inside a cold space before the anesthesia has worn off and body temperature has returned to normal, he could die.

A “dry” space is protected from the elements, especially rain or snow, but also wind or direct sunlight (which could cause overheating inside the traps). A holding space is “secure” if it is only accessible by people associated with the project and not by strangers or other animals.



Examples of adequate holding spaces may include a garage, basement, ventilated shed, empty trailer, empty room in an apartment, empty retail or office space, part of a warehouse, a bathroom if there’s only a couple of cats involved, an empty adoption van, or a cargo van parked in a driveway. Indoor spaces are preferable because they’re better protected from the elements and usually are more secure. In a pinch, if the weather is warm and calm and the area secure, a canopy tent set up in a private backyard, an open porch or a terrace could serve as holding space.

Sometimes people worry about fleas infesting a holding space. If the cats are well fed and healthy, their immune systems will be strong enough to fight off most parasites and it’s unlikely they will suffer severe flea infestations. But they may still have some. In our experience, it’s rare for the presence of cats for a week to cause a flea infestation in a holding space. If the traps are kept covered with lightweight cotton sheets and the space is cleaned or vacuumed thoroughly after the project, you should be fine. If fleas do appear, flea bombing the space afterwards might be necessary. Remember to bomb once after the cats are out and then a second time two or three weeks later to kill any fleas which may have hatched from eggs not destroyed in the first round (see the instructions on the flea bomb product). If you want to try a more natural approach, spread diatomaceous earth in all the cracks and crevices of the space (see “Diatomaceous earth” under “Fleas” in Chapter 4). Another way to cut down on the risk of fleas, if you can afford it, is to have flea medication applied to the cats during the spay/neuter procedure.

One trick, if a cat is staying in your bathroom, is to place the trap in your bathtub on top of some bricks. Then fill your bathtub with an inch or so of water. Between the trap being covered with a sheet and the moat below, it would be very hard for fleas to spread.

Sometimes people are worried the cats will make a great deal of noise. Simply put, they won’t. Feral cats are very quiet in captivity and try to make themselves as unnoticeable as possible. Once in a while, you might get a colony where one cat meows softly and others join in for a couple of minutes. Most of the time, they remain still and silent. If you do get a cat who’s meowing a lot and appears to be crying out for attention, this is often the behavior of a former house cat, not a feral. Such a cat should be carefully evaluated as a possible candidate for adoption.

If you’re going to hold the cats in part of your home, segregate your own cats and don’t allow them in the holding space in order to minimize any risk of disease or parasite transmission.

During the project, the holding space can also act as your command center where you keep your equipment, supplies and records, and meet up with volunteers. See the section, “Preparing the holding space,” in Chapter 11.

4. Schedule the spay/neuter

After you've established a feeding pattern, have an accurate count of the cats and arranged for an adequate holding space, it's time to schedule an appointment for the spay/neuter surgeries. There may be a variety of resources available in your area and you may need to do some research to locate them. Once you've located a spay/neuter provider, be sure to check that they treat feral cats.

The past few years have seen the rapid growth of High Quality High Volume (HQHV) spay/neuter clinics which specialize in altering cats and dogs. Many clinics have been trained by an organization in Asheville, NC, the Humane Alliance (www.humanealliance.org), which has pioneered high volume spay/neuter and offers extensive training and support to groups seeking to open their own HQHV clinics. Because the focus of these clinics is almost exclusively spay/neuter, they are able to provide high quality care at low prices.

Low cost spay/neuter services in your community may also be offered by a shelter, another animal welfare organization or an animal care and control agency. In some areas, mobile clinics, which you bring cats to or which brings the clinic to the cats, are available. A mobile clinic may operate out of a specially outfitted van or trailer with surgeries performed inside. Or it may be a MASH-style surgical unit that can be set up from scratch at almost any location.

Another popular approach for delivering affordable surgeries is a Mass Spay Day – a large-scale clinic capable of handling 100 or more animals a day. Typically these clinics are held once a month at the same location for one or two days at a time.

Private veterinary clinics may be a resource, especially if they are willing to discount their normal fees when treating free-roaming cats. There may be an animal welfare organization or animal care and control agency in your area which sells low cost spay/neuter certificates that can be redeemed at local clinics. SpayUSA (www.spayusa.org or call 1-800-248-7729) has a national certificate program offering discount spay/neuter rates at participating veterinarians and clinics. For a list of providers in your county, click the “Find a Clinic” button on the home page and select your state in the drop-down menu. Then select your county from a drop-down menu that will appear. A similar certificate program is also offered by Friends of Animals (www.friendsofanimals.org).

A word of caution if you do make use of a local or national spay/neuter certificate program. The vast majority of veterinarians who participate in these programs understand the need for affordable spay/neuter and offer valuable services at a true discount. However, there are occasionally abuses, such as charging for items which a person would normally assume are included in the cost of the certificate, like anesthesia. Or requiring payment for services in addition to those covered by the certificate, such as testing or extra vaccinations. The best way to protect yourself against an unexpectedly large bill is by obtaining a complete estimate of all costs *before* the spay/neuter surgery. Try to get this estimate, in writing, when you make your appointments.

One way to start looking for a low cost provider is by using the Low Cost Spay/Neuter Locator, a joint project of PetSmart Charities and the ASPCA. It can be found on the websites of both organizations (www.asPCA.org/spay;

www.petsmartcharities.org). Type in your zip code and the tool will list low cost resources in your area.

The availability of low cost spay/neuter remains a significant issue in many communities, especially for feral cats. It is one of the most important factors in how quickly TNR can advance because it is difficult to alter large numbers of cats if costs are not affordable. If there is no low cost provider for ferals where you live, then advocating for these services may become a necessary part of your work. Study the advantages of TNR discussed in Chapter 2 and meet with leaders in your community, such as shelter directors, animal control officers, municipal officials and veterinarians. Especially in places with a severe free-roaming cat overpopulation problem, you might find a willing audience. Propose a pilot project to start, one small enough that it doesn't demand many resources but large enough to demonstrate TNR's effectiveness. A positive experience could go a long way towards building more support.

While you're laying the groundwork for a larger TNR program in the future, try not to wait to get your cats fixed. Speak to your own veterinarian and see if she'll give you a special rate for the free-roamers you're feeding. Contact local shelters and animal rescue groups and find out which veterinarians they use – they may offer you a good price as well. A veterinarian who recently opened her practice and hasn't built up a client base yet may be happy to have your business, even at a heavy discount. Even if you can only afford to fix one or two cats at a time, you can still make progress in getting the colony under control. If you do have to start out slowly, try to trap the females in the colony first – this will help reduce the colony's reproductive capacity faster.

When you schedule your appointments, find out the unique procedures for that clinic, including drop-off and pickup times and any paperwork you need to complete beforehand, and be sure to follow their instructions closely. If you're mass trapping, try to secure enough slots so all the colony cats can get fixed at the same time.

5. Arrange for transportation

Unless a mobile clinic will be parked outside your holding space or your spay/neuter clinic offers a transport service, you'll need to transport the cats back and forth for their surgeries. Plan ahead if the cats' territory is distant from the holding space and transportation will be needed during the trapping. If you're thinking of using your own vehicle, figure out how many traps will fit inside. You may need to rent a cargo van, at least for the day of the surgeries, in order to transport all the cats at once. If more than one person is volunteering their car, draw up a schedule and let everyone know in advance when they will be needed.

Before placing any trapped cats inside a vehicle, line the seats and floor with thick plastic to catch any urine or waste. A plastic drop cloth at least 3 millimeters thick is recommended. You should do this every time a trapped cat is placed in a vehicle, even if it's only to drive a short distance.

6. Reserve or secure traps and dividers

Once your spay/neuter date is scheduled, make sure you'll have all the equipment you'll need when the time comes to trap. If you're mass trapping, arrange to have two or

three more traps than the number of cats in the colony. This is advisable for two reasons. First, a cat you didn't know about may appear. Second, when you're down to trapping the last cat or two, it's much easier when you have a couple of extra traps. With three traps to catch the last cat instead of only one, you can cover more of the territory and give yourself more opportunities to catch her. The types of traps we recommend are listed in Chapter 8 ("Recommended Equipment").

In communities where TNR has taken hold, traps can often be borrowed at little or no cost from "trap banks" run by feral cat groups or shelters. In other places, there may not be a formal trap bank, but animal control or a cat rescue group may have some to lend. On its website, The Humane Society of the United States maintains a comprehensive list of feral cat organizations throughout the country, listed by state (www.humanesociety.org/assets/maps/feral-cats.html). You can use this resource to help find a TNR group near you.

If there are no traps available to borrow, you may have to buy one or more yourself. This may limit how many cats you can trap at a time and may preclude doing a mass trapping of the entire colony. Stick to what you can afford and proceed with the project at the pace you can.

In addition to traps, you'll want to have at least one pair of trap dividers on hand. As explained in Chapter 11 ("Caring for Cats in Traps"), dividers are essential tools and should always be used in pairs for safely feeding and cleaning traps in which cats are confined. If more than one person is going to help feed and clean at a time, you'll need that many pairs of dividers. A trap divider may also come in handy during the trapping itself, for example, when two cats get caught in the same trap and need to be quickly separated, or when a cat is acting frantic in the trap and the space he has to move about in needs to be quickly reduced. Some trap banks do not stock trap dividers. If you can't borrow them, consider purchasing a pair (see "Recommended equipment – trap dividers" in Chapter 8).

The availability of equipment may impact when you schedule your spay/neuter appointments. If you need twenty traps, but they won't be available for a month, you'll have to wait until then to schedule the surgeries. If securing needed equipment might be an issue, check the availability of traps and trap dividers before you schedule the surgeries. Reserve the equipment as soon as your spay/neuter appointments are made.



photo: Debbie Preto

8. Recommended Equipment

- **Box Traps**



photo: Meredith Weiss

The standard trap used for feral cats is a “humane box trap.” Shaped like a large rectangular box, a cat enters through the raised open door at the front in order to reach bait placed at the back. On his way to the bait, he steps on a “trip plate,” causing the front door to shut and lock behind him.

There are many different manufacturers and models of humane box traps available. For working with feral cats, two

features are essential: the trap should have a rear door that opens by sliding it up (a “guillotine-style” rear door) and be 30 to 36 inches in length. The sliding rear door makes it possible to use the trap as a cage after the cat is caught by facilitating feeding and cleaning (see Chapter 11: “Caring for Cats in Traps.”) It allows for transfers out of the trap and into a transfer cage, feral cat den or another trap. The rear door also makes it safer when releasing the cats or any inadvertently captured wildlife.

To double as a cage, the trap must be large enough or at least 30 inches in length. Preferred width is at least 10 inches. At Neighborhood Cats, we prefer the 36 inch length traps because of the extra room they provide during the cat’s confinement. However, many experienced TNR groups prefer 30 inch traps because they weigh less and are easier to transport and store. Traps larger than 36 inches in length are bulkier and heavier than needed.

When the first edition of this handbook was released, there were no traps on the market specifically designed for feral cats. Traps made for other animals, like raccoons, had to be used and adapted. Recently, Neighborhood Cats partnered with Tomahawk Live Trap (www.livetrap.com) to design a box trap, and other equipment, just for feral cats and TNR. The “Neighborhood Cats Trap” by Tomahawk, described below, is the model we now prefer. However, preferences vary among trappers, so we also list other traps we’ve worked with that are popular in the field.



photo: Meredith Weiss

□ **Tomahawk Live Trap**

- **Neighborhood Cats Trap**

Model 608NC (36”L x 10”W x 12”H; 11 lbs.)

Model 606NC (30” L x 10”W x 12”H; 10 lbs.)

Tomahawk Live Trap, www.livetraps.com or 1-800-272-8727



Manufactured by Tomahawk, a family-owned business known for its high quality work, this trap is made especially for Trap-Neuter-Return and feral cats. It comes in two lengths – 30 inches and 36 inches. Many of its features solve the problems we’ve faced in the past when using traps intended for other animals.

Traps made primarily for raccoons have a narrow trip plate. We’ve observed many a feral cat simply step over it as they neared the bait. To

fix this, the Neighborhood Cats Trap has a wide trip plate which can’t be easily stepped over or around (*Figure 8-1*).

Another common problem we encounter with other traps is locking the rear door. Some traps have no locking mechanism. Others can be locked, but the process is too complicated and not obvious to someone inexperienced and in a hurry. We often had cats returned to us in their traps after their surgeries, only to discover the back doors were not locked and could be opened by a cat determined to get out. On the Neighborhood Cats Trap, locking the back door is a simple one-step process - snap the clip through the loop and you're done. (*Figure 8-2*.)



Figure 8-1

Then there are the handles – on most traps suitable for TNR, they are either too small or there is only one, so if you’re carrying a trap with a cat who is shifting around, the trap will tip awkwardly back and forth. The Neighborhood Cats Trap has two extra-long and thick handles to solve this problem. We also made the top plate extra-large as well, offering more protection from an irate lodger and more space to place labels and instructions for your clinic or fellow trappers. (*Figure 8-3*.)



Figure 8-2

The trap has other features standard on all Tomahawk traps, including reinforced steel rods to secure the front door’s automatic locking mechanism and smaller wire mesh near the rear door so cats can’t reach in from outside the trap and grab a piece of bait. Setting the trap is easily done by placing a hook-shaped trigger near the front door under a crossbar with a small brass roller. Pricing is comparable to other traps its size and, in many cases, is lower. Whether you want one trap to keep



Figure 8-3

around the house or are stocking a trap bank and need large quantities, this trap is an excellent choice.

□ **Tru-Catch**

- **Large Raccoon Trap with Rear Door**
Model 36D (36" L x 12" W x 14" H; 14 lbs.)
- **Fat Cat Trap with Rear Door**
Model 30FCD (30"L x 12"W x 14"H; 13 lbs.)

Tru-Catch, www.trucatchtraps.com, 1-800-247-6132; *also check:*
Heart of the Earth Animal Equipment, www.animal-traps.com; 1-800-526-1644

Tru-Catch traps are solidly made and durable. They're strong, not easily damaged and the metal is coated with a brown paint to prevent rust. Some trappers prefer Tru-Catch traps because the front door is not spring-loaded like almost every other box trap. Unlike the front door of a spring-loaded trap, that slams shut when the trip plate is stepped on, a Tru-Catch closes quietly and gently. Some trappers believe this is less alarming to the cats. In addition, the risk is lower of a cat or kitten being injured if struck by the front door as it closes because the door shuts with less force.

Another advantage is the trip plate is large so cats can't get around it. Both models mentioned here are a couple of inches wider and higher than other traps of similar length. This makes for a roomier stay while the cats are confined.



The biggest disadvantage is the trigger mechanism, which can be tricky. The trigger is set by resting two bars against each other – one bar is connected to the trip plate, the other to the front door. For a cat, the bars need to rest against one another near their tips, especially with the 36 inch length model. If the bars rest against each other further up their lengths, a cat could be too light in weight to make the front door shut when stepping on the trip plate. Trappers experienced with Tru-Catch traps learn to avoid this mistake, but it can be an issue for people new to trapping.

Another potential negative is that when the trap is set, the front door sticks out its entire length from the rest of the trap, increasing the potential of a cat knocking into the door and accidentally shutting it before going in. The traps are also heavier and more expensive than comparable brands.

Tru-Catch also manufactures another 30 inch length trap besides the Fat Cat Trap which is a favorite of some trappers. The Model 30LTD, at only 9 lbs., is much lighter and costs less. The problem is it's also much smaller, being only 9 inches in width and

11 inches in height. In our opinion, it is too small to double as a cage after a cat is captured, so we don't recommend it.

□ **Safeguard**

- **Large Raccoon Trap with Rear Door**
Model SG52836 / SG-36D (36"L x 11"W x 12"H; 12 lbs.)
- **Raccoon Trap with Rear Door**
Model SG52830 / SG-30D (30"L x 11"W x 12"H; 10 lbs.)

Heart of the Earth Animal Equipment, www.animal-traps.com; 1-800-526-1644; also check: Animal Care Equipment & Services (ACES), www.animal-care.com; 1-800-338-2237

The Safeguard trap has the basic features needed for TNR – a sliding rear door and length of either 30 or 36 inches. It's economically priced, so cost is a big advantage, and it's easy to set by pushing a hook-shaped trigger under a crossbar near the front door. Some trappers also like the 11 inch width, one inch wider than the Neighborhood Cats Trap. This gives the cats a little more room when confined.



The trap suffers from two major flaws. First, the trip plate is too small and, left as is, many cats will either step or lean over it to reach the bait. You can get around this by taping a piece of cardboard to the middle of the trip plate, effectively extending its length (*Figure 8-4*). The cardboard piece should be a little less than the width of the trap (approximately 10 inches) by 7 inches long.



Figure 8-4

The second flaw is the rear door's locking mechanism. The rear door locks by pushing rotating hooks attached to the top of the door beneath the crossbars on top of the trap. The handle of the door is then held in place by a thin metal bar which you pull over the handle. The design is confusing and people who are inexperienced or in a rush – like clinic workers – often make the mistake of thinking the rear door is locked when the thin metal bar is pulled over the door's handle. They forget or don't realize the hooks on top of the door need to be pushed under the crossbars. This omission allows the rear door to be pushed up and open by a cat struggling to get out. If you use this trap, you must develop a habit of constantly double-checking that the rear door is properly locked, especially when the trap – with cat inside – is returned to you by your spay/neuter provider. Also check right after baiting a trap out in the field, before lifting a trap with a recently captured cat, and

after closing the rear door when you're finished feeding and cleaning a trap in your holding space.

- **Drop traps**



A drop trap is a fancier version of a box propped up on a stick with a string attached and some bait underneath. You wait until your target cat goes under and then, while she's eating, pull the string. Because of cat psychology, a drop trap is often an experienced trapper's best friend. A normal **box trap** requires a cat to overcome her natural fear of entering an enclosed space. This is why depriving her of food the day before trapping is so important – hunger will drive her to overcome her fear and go in after the bait. A **drop**

trap, on the other hand, is not an enclosed space the cat must enter, but an object she needs to go under. Very few cats are afraid to do this. As a result, they don't have to be that hungry before they'll go under a drop trap (just withhold food the day of the trapping) and normally trap-shy cats will march right over to the bait. Many a trapper has used a drop trap to catch that one cat who had otherwise eluded her for years.

Drop traps are also great for picking out and trapping a particular cat from the colony, such as a pregnant female, or a cat who got away during an earlier mass trapping. In Chapter 10, we describe in detail how to use a drop trap. They do require some study and a little bit of practice to use safely and effectively. In addition to catching the cat, you'll need to learn how to transfer her out of the drop trap and into a box trap, transfer cage or feral cat den.

- **Neighborhood Cats Drop Trap**

Model DT-1 (36"W x 36"W x 14"H – unfolded; 36"L x 4"W x 18"H – folded; 14 lbs.)

Tomahawk Live Trap, www.livetraps.com; 800-272-8727



In the past, trappers had to build their own drop traps or find someone handy who would build it for them. But now Neighborhood Cats and Tomahawk Live Trap have designed the first mass-manufactured drop trap ever! It collapses flat, weighs only 14 lbs. and is all metal and easy to clean.

The trap folds up in a suitcase style complete with handles, making transport and storage easy. A weight flap for keeping the trap in place and a prop "stick" for setting the

trap are attached. The transfer door has spring clips on the side which can be attached to the trap or transfer cage you're moving the cat into, helping prevent an escape. It can be set up and broken down in less than a couple of minutes. Bottom line - if you're going to be doing TNR on a regular basis, you're going to want to have this trap.

Also, check out Tomahawk's remote control attachment for the drop trap (code: RC-100). It replaces pulling a string for dropping the trap and has a few advantages over the string. There's no risk of the string getting caught up and stuck on any object or of the trapper not pulling hard or fast enough. Nor will cats be distracted by any movement of the string. Its greatest advantage is the ability it gives the trapper to watch from a location where it would be difficult or impossible to trail a string, such as the upper floor of a house when the drop trap is set up in the backyard.



• Trap dividers

- ❑ **Tru-Catch Trap Isolator for Large Raccoon Trap** by Tru-Catch
Model TD-2
Tru-Catch, www.trucatchtraps.com, 1-800-247-6132; also check: Heart of the Earth Animal Equipment, www.animal-traps.com; 1-800-526-1644
- ❑ **TNR Trap Divider** by Tomahawk
Model TD12NC
Tomahawk Live Trap, www.livetraps.com; 800-272-8727



One of the most useful pieces of equipment for safely working with feral cats is a trap divider, also called a trap isolator. This pitchfork-looking tool slides through the bars of the trap, either from above or through the side, and divides the trap in two. While caring for a cat confined in a trap, it allows you to section the cat off on one end while you open the door on the other to feed and clean (see Chapter 11.) Other uses include separating two cats who've been caught in the same trap, pinning a cat to one end of the trap before surgery so an anesthetic injection can be administered, lessening the space a frantic cat can move about in after being captured and during transport, and directing a cat's movement during a transfer out of the trap.

Many manufacturers of traps also make trap dividers. To our knowledge, only the ones made by Tru-Catch (*Figure 8-5*) and Tomahawk Live Trap (*Figure 8-6*) are strong enough for the uses described in this handbook. All the other brands we've tried are



Figure 8-5

either not wide enough or made from inferior and weaker materials, so they bend easily and can become difficult to insert with continued use. They are not safe for the methods we teach. By contrast, the Tomahawk and Tru-Catch dividers are strong, durable, the correct size and easy to use. In fact, we helped design the Tomahawk model. They fit not only Tomahawk and Tru-Catch traps, but any other trap of similar size and wire mesh construction.

Warning! If you are purchasing traps by a manufacturer other than Tomahawk or Tru-Catch, do not let

your vendor talk you out of buying the trap dividers we recommend and instead purchasing one “specially made for your trap by the trap manufacturer.” Just because it was “specially made” does not mean it is adequate for TNR purposes.

If you’re unable to borrow trap dividers from a local trap bank or shelter, consider buying a pair for yourself to always have them around. Two trap dividers should be used when feeding and cleaning inside a trap, so we recommend you order them by the pair.



Figure 8-6

• Kitten screen

- ❑ **Neighborhood Cats Kitten Screen** by Tomahawk Model K100
Tomahawk Live Trap, www.livetraps.com; 800-272-8727



Sometimes you may want to catch a litter of kittens before you trap any of the adults in a colony. Perhaps the kittens are young enough to be easily socialized and adopted out, so you want to catch them right away and not wait until you’re able to trap the whole colony. The problem is how do you keep the adults out of the traps and away from the bait and only let the kittens in? Some trappers try using very small traps designed for animals like squirrels or chipmunks, but an adult cat can still squeeze into most of them. Remember, on winter shelters, the recommended doorway is only 6 inches x 6 inches.

Problem solved with the Neighborhood Cats Kitten Screen, designed by us and manufactured by Tomahawk Live Trap. The screen is a steel mesh panel that installs easily into any wire mesh box trap measuring 10"W x 12"H, including Tomahawk models 108, 606NC, 608, 608NC and 608FN. Placed in front of the trip plate, its 3 inches by 3 inches opening only allows small kittens to pass through so only they can step on the trip plate.

See the section, “Kittens,” in Chapter 9 for tips on trapping kittens, including how to set the trigger so a kitten’s weight will trip the trap, how to close the trap door manually instead of using the trigger/trip plate mechanism, and how to build your own kitten screen if the Neighborhood Cats Kitten Screen won’t fit your trap. Also, see Chapter 10 for how to use a drop trap, another method for capturing young kittens.

- **Feral cat dens**

- **Neighborhood Cats Feral Cat Den**

- Models 711 (White) & 721 (Grey); 17”L x 12”W x 17”H
Tomahawk Live Trap, www.livetraps.com; 800-272-8727

A “feral cat den” is a rectangular carrier specially designed for feral cats. It comes with a sliding, guillotine-style plastic front door and a round porthole door on the side which opens by flipping it upwards. If the den is inside a regular cage, the side door can be opened and closed without having to open the cage door. Instead, you can reach in through the bars of the cage with a yardstick or similar long item and flip the door open or shut. This is a great safety feature when it comes to feral cats. It eliminates the chance of escape which is ever-present if the door of a cage is opened while a feral cat is loose inside.



As a rule, after being trapped as part of a TNR project, cats should remain in their traps until they are released back outside, except during the spay/neuter surgery. We discourage people from routinely transferring cats out of traps and into cages. Occasionally, however, there may be a cat who needs a longer than usual confinement and so will need to be housed in a normal cage. For example, a feral mom with a young litter of kittens may need to be caged for several weeks while she raises them. An injured or sick cat may need a longer stay inside a cage as well. In these cases, a feral cat den is needed.

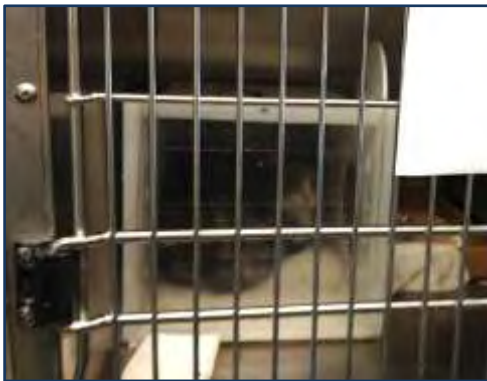

A feral cat den can come in handy in other situations as well. It may be easier to transport a cat inside a den instead of a larger trap. Or there may be a shortage of traps for a particular project and one can be freed up by temporarily transferring a cat from a trap into a den. This can be easily done because the sliding front door of the den will line up with the sliding rear door of the trap. (See the section, “Transfers from traps,” in Chapter 9.) If you use a drop trap, a captured cat will need to be transferred

out – a feral cat den can be used for this purpose as well because of its front door. A transfer cage, described in the next section, will also work for these other uses.

Regular cat carriers should not be used with feral cats! When inside a cage, it’s difficult to lock a regular carrier’s door shut without opening the cage door first, creating the potential for escape. In addition, a normal carrier’s front door swings open to the side and does not line up with the rear or transfer doors of traps. This makes transfers into and out of the carrier treacherous. Simply put, the risks of escape and injury are too high. Safety requires using the proper equipment which, in this case, is a feral cat den, not a regular cat carrier.

Neighborhood Cats has worked with Tomahawk Live Trap to design a den with added safety features. Most importantly, the side door can be locked closed (or open) with an attached spring clip (*Figure 8-7*). Without the side door lock, there is a risk a feral cat could work the den's side door open and escape during transport. Because, to our knowledge, no other model on the market offers a side door lock, this is the only feral cat den we recommend.



Figure 8-7

Other added features which we helped design are a more comfortable handle, a steel cable attaching the front door clip to the handle and rounded corners on the front sliding door to help prevent chipping if the door is accidentally dropped.

In addition to the choice between a grey or white den, Tomahawk also offers a tinted or clear front guillotine door. For feral cats, the clear door is usually the better choice, giving you more opportunity to observe the cat when he's inside.

Because the Neighborhood Cats Feral Cat Den is 17 inches high, higher than most traps, be careful when transferring a cat out of a trap not to pull the den's door up any higher than the trap itself. Otherwise you create a gap which a cat could try to squeeze through.

• **Transfer cages**

A transfer cage is designed specifically for moving a cat out of a trap. It has a guillotine-style front door which lines up with the rear door of a trap. Transfer cages can be used to free up traps or to transport cats. They're not large enough to confine the cats for more than a short period and, because they lack a side door like a feral cat den, they're not suitable for use in cages for long-term confinement. Because of their limited usefulness, it's not an item we keep on hand at Neighborhood Cats. However, there are many TNR groups which do use them frequently.

Generally, the best practice is to buy transfer cages made by the same manufacturer as your trap so the dimensions of the front door of the transfer cage exactly match those of the rear door of the trap. If you buy from different manufacturers, make sure the height and width of the transfer cage is close enough to the dimensions of your trap to prevent gaps which a cat can escape through during a transfer.

- **TNR Cat Transfer Cage** by Tomahawk
Model 306NC (20"L x 11"W x 12"H)
Tomahawk Live Trap, www.livetraps.com; 1-800-272-8727

This model matches the Neighborhood Cats Traps, Models 606NC and 608NC, and the Neighborhood Cats Drop Trap (Model DT-1). It can be purchased as a kit with the

drop trap (code: KITDT) – see *Figure 8-8*. It has a solid metal pan bottom, extra-large hand guard on top and extra-large handles.

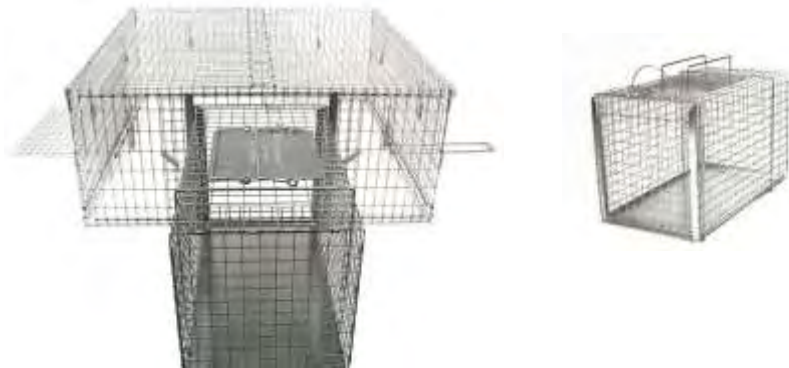

Figure 8-8

❑ **Tru-Catch Animal Carrier**

Model T24TE (24”L x 12”W x 14”H)

Tru-Catch, www.trucatchtraps.com, 1-800-247-6132; *also check*: Heart of the Earth Animal Equipment, www.animal-traps.com; 1-800-526-1644

The Model 24E goes with Tru-Catch trap Models 30FCD and 36D. It comes with both a top-loading door as well as a front guillotine door. Normally, it would be rare when working with feral cats to use the top-loading door, but it might come in handy for tame cats or kittens. The floor is wire mesh.

❑ **Safeguard Carrier/Transfer Cage**

Model SG53100 / SG20CTEL (20”L x 11”W x 12”H)

Heart of the Earth Animal Equipment, www.animal-traps.com; 1-800-526-1644; *also check*: Animal Care Equipment & Services (ACES), www.animal-care.com; 1-800-338-2237

This transfer cage matches traps SG52836 / SG-36D and SG52830 / SG-30D. It too, is made with both a top-loading door and a guillotine front door. A galvanized pan with a 1 inch lip covers the entire floor.

9. Trapping

You've educated the community about TNR, established a feeding pattern for your colony, counted the cats, made plans for any who are adoptable or sick, arranged for holding space, scheduled your spay/neuter date, borrowed traps and lined up transportation. Now it's time to trap! While you can never predict exactly what will happen once the trapping begins, your preparations will help keep surprises to a minimum and make the project go as smoothly as possible. This chapter will go over all the tricks and techniques you'll need to get your cats into the traps and to the clinic.

- **Mass trapping**

“Mass trapping” refers to the TNR of an entire colony at once. This approach is far preferable to a gradual “one-cat-at-a-time” approach for several reasons. First, by the time you come upon the colony and decide to get the cats fixed, the situation is often in crisis. There are too many cats and kittens, neighbors are complaining and threats to call animal control or worse are being made. Spay/neutering all the cats quickly results in an immediate and dramatic decrease in the kinds of nuisance behaviors which provoke these reactions. Noise from mating and odor from the spraying of unaltered males abate, no more kittens are born and the cats tend to roam less and so become less visible. What started as a very hostile situation calms down, almost overnight.

Another advantage to mass trapping is it makes it easier to catch every cat in the colony.

When you get down to the last few cats during a mass trapping, they're the only ones left in the territory. You can keep withholding all food and, with each passing day, they're getting hungrier and more likely to go into a trap. Compare that to catching and fixing one cat at a time. When you're down to the last cats, they're not the only ones out there. All the other cats you trapped previously are also at the site. You have to pick the ones left out of the crowd, which can be difficult.

Mass trapping is also a more efficient method. You only have to find a holding space once, take care of the cats while they're confined once, transport the cats back and forth from the clinic once, etc. If you alter the colony gradually over time, these efforts have to be continually repeated and in the meantime reproduction and nuisance behaviors continue. While it's more intensive, mass trapping takes less time in the end.



photo: Meredith Weiss

That said, not every community offers low cost spay/neuter for ferals, which is essential for mass trapping, and not everyone has access to a large number of traps or a holding space big enough for an entire colony. When it's not possible to TNR the whole colony at the same time, the goal instead should be to catch and neuter as many of the cats at once as you can. Fixing even one or two cats at a time is still making important progress if eventually the whole colony is done.

The entire mass trapping process, from pre-trapping preparations through the release of the cats back outside, is demonstrated with live footage in the Neighborhood Cats instructional video, "How to Perform a Mass Trapping." The approximately 30 minute video is available for free viewing on the Neighborhood Cats website (www.neighborhoodcats.org). See either the home page or the Mass Trapping page. A DVD copy can be ordered by emailing info@neighborhoodcats.org.

• **Trapping supplies – the basics**

Here is a list of basic items you should always have with you when you trap:

- Traps (2 or 3 more than the number of cats)
- Trap divider (at least one)
- Bait (two kinds)
- Can opener
- Plastic forks or spoons
- Small paper or plastic plates
- Pounce or a similar cat treat which can be easily crumbled
- Sheets (one per trap)
- (If needed) cardboard extenders for the trip plates of the traps & duct tape
- First aid kit

Having a few more traps than cats makes it easier when you are after the last member or two of the colony. You'll be able to spread out three or four traps to catch the last cat instead of only one. Extra traps are also insurance against any unfamiliar felines making an unexpected appearance. A trap divider is important to have on hand in case you need to separate two cats caught in the same trap, reduce the space in a trap that a frantic cat can thrash around in or transfer a cat out of a trap. (See the section, "Transfers from traps" later in this chapter.)

Two kinds of bait should be placed on each plate because some cats may prefer one over the other. There are as many favorite types of bait as there are trappers. Usually, cheap tuna cat food does the trick, but also add a smelly wet food for those occasional cats who dislike tuna. Other tried and true delectables include roast beef, grilled chicken, human quality tuna, sardines, mackerel, fast-food hamburgers, white bread dipped in clam sauce, valerian root and freshly cooked fish of any sort. Fresh catnip is another favorite, but only put it inside the trap and on or behind the trip plate. If you try to entice kitty over by sprinkling it outside the trap, you may end up with a very happy feral who rolls around on the ground by the front door, then gets up and walks away.

Plastic or paper plates are recommended. Don't use anything with a sharp or hard edge, like a cat food can or ceramic saucer that could cause an injury if a trapped cat panics and starts dashing back and forth. Buy plastic forks or spoons so, if needed, you have plenty of them for placing bait on the plates.

Pounce or a similar cat treat that easily crumbles is perfect for making a trail leading up to the trap.

The sheets are for covering traps after a cat is caught. Covering usually calms the cat quickly by making him feel less exposed, helping prevent injury. From the time of capture until the cat is released at the end of the project, the trap should be kept covered at all times. This is very important for ferals who feel more secure in dark, enclosed spaces when confined.

If you're using traps with narrow trip plates, you'll need cardboard extenders to make them wider or else cats may simply step over them. The width of the cardboard extender should be a little less than the width of the trap and seven inches long. Use duct tape to attach the cardboard to the middle of the trip plate (see *Figure 8-4* in Chapter 8).

A basic first aid kit is a must just in case of a bite or scratch or some other injury. An injury caused by a cat shouldn't happen if the techniques outlined in this handbook are followed, but if it does, it's important to be prepared. Quickly cleaning a wound inflicted by a cat can stop a more serious infection from developing later. The kit should at a minimum include hydrogen peroxide and cotton balls for cleaning a wound and band aids. If you are bitten or scratched by a cat, be sure to seek medical attention promptly. A seemingly innocent wound can become serious if left untreated.

• **Trapping supplies - optional**

The following list of items may or may not be needed, depending on the circumstances of your project. Some you might want to bring along just in case.

- Newspaper
- Clothespins
- Blankets
- Plastic drop cloth (at least 3 millimeters thick)
- Flashlight
- Needle-nose pliers
- Vegetable oil spray
- Pens or pencils
- Color labels & Sharpie pens (if trapping at multiple sites)
- Logging sheet & pen (if trapping at multiple sites)
- Another person or two

Once in a while, a cat won't like the feel of the wire floor of a box trap and will hesitate to enter. One way to overcome this is to cover the floor of the trap with a few sheets of folded newspaper. Be aware that even the slightest breeze can cause the newspaper to rustle and frighten a cat away, so attach the newspaper to the floor of the trap with clothespins. Some trappers will put newspaper in all their traps as a standard

practice. In our experience, there are not that many cats who are deterred by the feel of a wire floor. We don't usually bother with the newspaper until we're down to the last cats who may be more trap-shy and need extra coaxing.

Blankets are useful if you're trapping in cold weather and trapped cats cannot be quickly moved into a warm space. Wrapping a blanket around the trap after a cat has been caught, while leaving some openings for ventilation, will buy you a little time depending on how cold it is.

A plastic drop cloth should be used to line the seats or floor or any other surface which will need protection of any vehicle used to transport the cats.

Bring a flashlight if you're trapping at night or in a dark space like a basement. You'll need it not only to see your way around, but to check the ears of trapped cats to see if they're already tipped. Needle-nose pliers are handy if a trap's trigger mechanism needs adjustment though it takes some experience to do it properly - a fraction of an inch can be the difference between an adjustment that works and one that doesn't. Vegetable oil spray is good for traps whose moving parts need a little lubrication.

If you're trapping at multiple sites simultaneously, as soon as a cat is caught, the trap should be labeled to avoid future mix-ups. A good idea is to use a different color label for each colony. Write down the location of the colony and the number of the trap (give each trap its own unique number). Then enter the trap number, the colony name and a description of the cat into your trapping log (see *Appendix C* for a sample log).

Finally, having someone help you is highly advisable, especially when trapping multiple cats. Attention to more than one cat or trap at a time may be needed. Also, if an item was forgotten or a phone call needs to be quickly made in the heat of the action, having another person there can make a huge difference. At the same time, don't have more helpers than you need. Too many people standing around talking can make the cats more wary. For smaller colonies, two or three people will do just fine. As you approach 20 or more cats, three or four is a good number.

Trapping at night? Consider using a headlamp instead of a flashlight. That way you'll have both hands free to dish out bait, cover traps, etc. Sold as camping equipment at sporting goods stores, there are many models available which vary in brightness, beam distance, battery life and weight. Search Amazon (www.amazon.com) for "headlamp flashlight" or check Paragon stores (www.paragonsports.com).

• The trapping

1. Withhold food

Most feral cats are naturally wary of entering an unfamiliar, enclosed space like a humane box trap. Hunger is the key for getting them to overcome this fear and is the single most important factor when trapping. You could prepare everything else perfectly, but if the cats are not hungry, many or even most of them will not go in a box trap no matter how tempting the bait.

Food should be withheld the entire day before the trapping begins. For example, if the trapping begins on a Friday, then the cats should be fed at their regular time on Wednesday and then not at all on Thursday. The only exceptions are young kittens, nursing mothers, and cats who are clearly ill. If you can feed them separately and not let the other cats get any of the food, then they can eat the day before the trapping though not the day of. If you can't feed them separately, then withhold the food.

Withholding food is often harder on the caretaker than it is on the cats. You feel guilty, knowing they're counting on you and wondering what happened. For sure, they won't like skipping their daily meal, but healthy adult cats can easily go a day or two without food and not suffer any ill consequences. You have to remind yourself that a day's discomfort is a small price for the life-long benefit the cats will gain by being spayed and neutered. Even if you're sure everyone is on board with not feeding the cats, it's a good idea to check the feeding station and site at least once the day before the trapping begins to make sure there's no food lying around.

While the trapping proceeds, continue to withhold all food. Cats who you don't catch the first day will be hungrier the next. As long as there are loose cats remaining and the rest of the colony is confined, continue to hold back food and keep setting traps. At all times during the trapping, do leave out fresh water.

The importance of withholding food points to the need for locating and coordinating with any other feeders. On occasion, you may run up against someone who will not cooperate, no matter how articulately you explain it's for the good of the cats. If this happens, you need to try to work around that person as best you can. Find out when they put food out, then show up soon afterwards and remove it. Or start trapping well before the person usually comes to feed. A drop trap can be very handy in these situations because the cats do not need to be as hungry before they'll go under one. Most times, if they have not eaten yet that day, they'll venture under a drop trap.

2. Allow enough time for the trapping

Typically, if the cats are hungry and everything is in place, the first day of trapping will net most of the cats in the colony. However, even with the best laid plans, some cats may not enter the traps and others may not show up the first day. The second day often results in these remaining cats getting caught, but it is possible there will still be one or two stubborn ones who refuse to enter a trap. It can take a third day of being deprived of food to make them hungry enough to go in. This is why we recommend budgeting at least two days for trapping and, for larger colonies of ten or more, at least three days.

There are other good reasons for leaving at least two days and not waiting until the day or night before your spay/neuter date. For one thing, there's the weather. What if it rains the day before the surgeries are scheduled? Then your project is literally washed out. It's possible you may show up to trap and discover a large bowl of dry food which someone unwittingly (or not) put out. A neighbor may have picked the exact time and day you show up with your traps to start a new and loud construction project. By planning on at least two days to trap, you give yourself a safety net for these kinds of unexpected developments which could interfere with the trapping. After all the preparations you've made, it's not worth risking everything going wrong for the sake of

saving one day. Also remember, you're not going to make any friends at your veterinary clinic if you show up empty-handed or with far fewer cats than planned. Most clinics will have already incurred expenses which they can't recoup, like scheduling staff, based on the planned number.

If it's absolutely unavoidable and one day of trapping is all you can manage, then be extra careful to make sure the cats are very hungry and start out early, leaving yourself as much time as possible.

A drop trap can also help if you find yourself with less than the ideal amount of time to trap. As mentioned, cats don't have to be as hungry to go under one as they need to be to enter a box trap. What you can do, if you've only got one day, is first set out your box traps and catch as many of the colony members as you can. Then, instead of packing up and coming back the next day when the holdouts are hungrier – because you don't have a “next day” - break out a drop trap and try to catch them that way. See Chapter 10 to learn how to use a drop trap.

3. Check the traps

Check that the traps are working properly before transporting them to the colony site. Ideally, you'll have done this when you first borrowed or purchased the traps, but if you didn't, do it before heading out into the field. To test one, first set the trigger mechanism. On most traps, except the Tru-Catch, this will mean lifting the front door all the way up, then pulling the trigger hook forward until it rests under one of the crossbars on top of the trap. When the trigger is set, it should cause the back of the trip plate to rise up. Reach through the side of the trap with your finger or a pen and press down on the raised trip plate. The trip plate should go down without too much pressure – imagine a cat's paw stepping on it - and cause the front door to quickly close. After the front door has shut, check to make sure its automatic lock mechanism – usually a clip on top of the trap – has engaged and the door can't be opened by just tugging it forward without lifting the lock. If it can, it means a cat inside the trap could push the door up and get out. Finally, do a quick check of the rear door to make sure its locking mechanism is also functioning.

If you discover at the last minute that a trap is broken and can't fix it, all is not lost. Mark it as broken and bring it to the trapping, anyway. Once you've caught a cat in a trap that is working, you can transfer the cat into the broken one and free up the functional trap. How to perform a transfer from a trap is explained later in this chapter.

If a trap's moving parts are sticky and not operating smoothly, a little lubrication might fix the problem. An excellent lubricant which is safe for the cats and easy to apply is non-stick vegetable oil spray. Find it in the bakery aisle of your supermarket and try butter-flavored to help attract cats with the scent.

4. Prepare the traps

After you've transported your equipment and supplies to the colony site, unload the traps and line them up in a row, rear doors all facing the same way. Put the traps down a comfortable distance from where the cats are normally fed and, if possible, just around the corner and out of sight. This will reduce the chance of alarming the cats with what to them will appear to be new and unusual activity.

Remove the rear doors, placing each on top of its trap. At this point, if you're using traps with small trip plates, tape the cardboard extenders on, making sure the edge of the cardboard, and not simply the tape, reaches the middle of the plate (see *Figure 8-4* in Chapter 8). Next, open the bait and place generous portions on small paper or plastic plates. Use mostly your favorite bait but also add at least a bit of a second kind. Then place the bait behind the trip plate – right up against the rear door is good. Shut the rear doors, double-checking that they're locked properly.

One exception to using a fair amount of bait is if you know a cat is going to be operated on within hours, for example, if the trap is set early in the morning of your spay/neuter date. In that case, only use a small amount of very smelly bait. Ideally, when a cat goes for surgery, her stomach is empty to avoid possible complications caused by anesthesia, such as vomiting then choking and gagging. If the cat did eat within hours of surgery, even a small amount, be sure to inform your veterinarian.

As mentioned earlier, at Neighborhood Cats, we don't usually line the floors of all the traps with newspaper, but only do so later in the trapping if there are cats reluctant to go in. Some trappers prefer to start out with newspaper on the bottom of all traps. If that's what you want to do, too, then after you've locked the rear doors, go to the front of each trap, open the front door and line the floor with newspaper, using clothespins to attach it to the sides of the trap.

Finally, roll up a sheet and tuck it between the handles on top of each trap. That way, when a cat is caught and you need to cover him quickly, you won't have to go running back and forth, looking for a sheet.



photo: Bryan Kortis



photo: Meredith Weiss

5. Place the traps in the territory

Once all the traps are ready, place them all in the territory at the same time. Don't put only some out, thinking you'll put out the rest after you've caught some cats. The fewer

intrusions you and others make into the territory, the fewer chances a cat will be frightened off and not return.

Place the traps to cover as much of the area around where the cats are fed as possible. Also put them along paths the cats are known to travel and any other spots they frequent. How much of the cats' territory you cover will depend on how many cats there are, how large the territory is, what sections of the site you have access to and how many traps you have on hand. Most traps should be concentrated around the feeding area or along routes they travel to get there. Remember, if you prepared properly, the cats will be on a feeding schedule and will come to you at the usual time, so you don't have to go searching for them.



Figure 9-1

When placing the traps, don't rest them on the ground out in the open. Instead, rest them, length-wise, alongside an object or structure which is familiar to the cats, like a fence, wall, feeding station curb, front bumper of a car, dumpster, bush, tree, etc. (See *Figure 9-1*). The trap then appears to the cat to be part of another known structure and is less threatening than when it's off by itself and free-standing.

Make sure the trap sits on level ground. Sacrifice having the trap butt right up against a wall or other structure if moving it out a foot or two will mean it's resting on the ground more steadily. Don't put traps right next to each other, but separate them by at least a few feet.

Once a trap is in position, open the front door and set the trigger. Remove any debris or branches which might block the front door from completely closing when it comes down. If necessary, blend the bottom of the trap into the landscape by sprinkling some dirt, pebbles or leaves on the floor in front of the trip plate.

If the trap will be sitting in direct sunlight on a hot day, take the sheet from between the handles and, after partly unfolding it, cover the rear of the trap, shading the bait so it won't quickly dry out. Place a rock or some small heavy object on top of the sheet to keep it from blowing off. If it's too windy outside, you may need to forgo shading the bait.

If it might rain during the trapping, place each trap in a heavy duty garbage or contractor bag. Cut away any part of the bag covering the front and/or rear doors, then wrap duct tape around the trap to secure the bag in place.

Some trappers always cover the top and both long sides of the trap with a sheet, leaving only the front and rear doors uncovered. They believe this makes the interior of the trap more inviting to the cats. At Neighborhood Cats, we do this only when the trap is in a remote spot and can't be checked as frequently as usual. If a cat gets trapped, the partial covering will help keep him calm. We don't do this with every trap from the

outset because, in our experience, most cats will go in whether the trap is covered or not and the sheet tends to blow around in the wind. If you do cover the trap, make sure the rear door as well as the front door is not covered. The cat should be able to see all the way through in order to minimize the sensation she is entering a confined space with only one way out.

One way to make a cat less wary of going in is to trick her into thinking she can exit the trap through the rear doorway. Do this by replacing the wire mesh rear door with Plexiglass cut the same size. Drill a small hole towards the center top in the Plexiglass door so when your transparent new door is in place, you can run a cable tie through and secure it to the top of the trap. Later, after a cat is captured, section her off towards the front of the trap with trap dividers and replace the Plexiglass door with the regular one.

As a last step, take a piece or two of Pounce, crumble it up and sprinkle a trail starting a few feet away from the front door of the trap and leading into the trap and all the way to the bait. This same technique can be done with the juice from tuna or little bits of the bait – don't use too much and risk the cat being satisfied before she follows the trail to the main dish.

Cats often love catnip spray - it's highly concentrated and very pungent. Plus it's got staying power since it won't blow away like dried flakes do. Try spritzing a small amount directly onto the trip plate. Use a quality spray like Kong Naturals to make sure the scent is irresistible! (Find Kong Naturals at PetSmart, Petco or online at www.amazon.com/pets.)

6. During the trapping

Once the traps are all in place and set, exit the territory. Tempting though it may be to keep a close eye on the action, the cats will be aware you're watching them. Stay out of sight and don't stare, especially when one is right in front of the trap and thinking about going in. If you start looking at them intently and silently urging them to take the plunge, they may pick up on this and it could be enough to dissuade them. If you're trapping in your own backyard, go inside the house and watch from there. If you're at another location, wait inside your car or stand just around the corner. The less visible you are and the less tension and anxiety you exude, the better.

While you don't want to watch too closely, you or another trapper should be present at the site at all times. Traps should never be left unattended. The cats are completely vulnerable once they're trapped and dependent on you for their safety. If you're not around, bad things can happen such as two panicked cats getting caught in the same trap, wildlife attacking a captured cat or a stranger passing by who releases a cat or worse. Ideally, check the traps every half hour, but don't let more than two hours pass without

doing so. Don't check too frequently because each time you approach the traps, you might scare a cat away.

If you see a cat trapped or hear a trap door shut, don't immediately go running into the territory to cover the cat up. Observe how the cat reacts. Most will become frantic and start dashing back and forth. If that's happening, go over and cover the trap with its sheet, then stand back for a minute and give the cat a chance to calm down. But if the cat is eating or sitting quietly, then stay back and wait. Remember, you want to keep entries into the territory to a minimum.

When a cat does panic, never release the cat out of fear she'll hurt herself if you don't. First cover her with the sheet. Usually she'll be fine in a moment. In the rare case a cat does not calm down and continues to thrash about, insert a trap divider through the top of the trap and reduce the amount of space the cat can move around in. Then cover the trap again. Bloody noses or torn claws will sometimes occur, but are not cause for serious concern. Don't give in to your fear and let the cat go! If she is acting that frightened, you may never get her into a trap again, which means she'll never have the benefit of being spayed, you'll have to keep finding homes for her kittens, etc. Eventually, she will calm down and everyone will be better off in the end.

After the cat has been covered and has quieted down, pick up the trap, move it a few feet away and place another trap in the same exact spot where the cat was just caught. You'll often find there are "hot spots" where, for whatever reason, one cat after another keeps going in. Carry trapped cats out of the territory to a secure spot where someone can keep a constant eye on them or transport them to the holding space. If the cat starts moving back and forth while you're carrying her, tilt the trap forward at about a 45 degree angle, forcing the cat to expend her energy hanging on to the floor or sides instead of moving around.

If you're trapping at multiple sites, place a label on the top plate of the trap and write on the label the location, the trap number (you can number the traps sequentially as cats are caught)

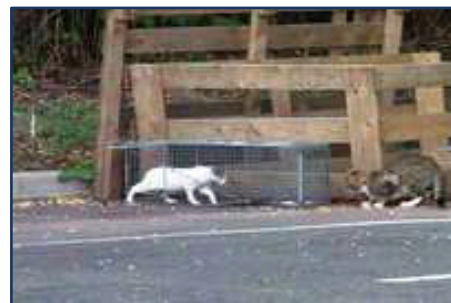

photos: Emma Cobb



photos: Emma Cobb

and a brief description of the cat. For extra safety, use a different color label for each colony. At the site or later in the holding space, also record the trap number, location, description of the cat and any other special notes on a logging sheet (see *Appendix C*). Use a separate logging sheet for each colony, noting on each sheet the color of the label associated with that colony. A good practice is to tear off a little piece of the correct color label and press it onto the corresponding logging sheet. These precautions will help prevent confusion and the later release of a cat at the wrong location.

If the temperature is cold, after the cat is trapped and you've moved him out of the trapping area, drape or wrap the trap with a blanket, leaving openings for ventilation. This should only be done as a temporary measure. Cats in traps should be brought to a warm space as soon as possible. If you have enough help, one or two people can start taking the cats to the holding space while the others continue trapping. Or you could place the cats inside a vehicle with the heat and vent turned on.

If you can, continue to trap as long as there are any cats in the area who look like they might go in. If the colony is large, it's common on the

first day of trapping for there to be a few who either don't show up or simply will not be enticed into a box trap. If it's clear you're down to the last cats and they're just not interested, either set up a drop trap and give that a try (see Chapter 10 for how to use a drop trap) or shut down for the day, gather everything up and try again tomorrow. Continue to withhold all food and bring your empty traps and any trapped cats still at the site to your holding space.

Subsequent days of trapping follow the same pattern as the first except there are fewer cats to catch. The traps should be set up and placed in the territory as previously, although you could try a different kind of bait in case it's more attractive than the first day's offering. If the same cats show up and still won't go in, try one or more of the techniques described later in this chapter in the section, "Hard-to-catch cats".

Keep in mind your best chance of catching those last one or two difficult cats is when the rest of the colony has already been removed from the site. You don't have to try to pick them out of a crowd because they're the only ones out there, plus they're growing hungrier with each succeeding day and more likely to go in a trap. Because you may never get a better opportunity to catch them, we recommend continuing to try to trap any holdout cats for as long as the rest of the colony is confined - even after your spay/neuter date has passed. The hassle of having to make special arrangements to get the last cat or two to a veterinarian will probably be much less than the trouble involved in catching those cats later when the rest of the colony is back out in the territory.

• Winter trapping



photo: Bryan Kortis

Some trappers in northern climates don't like to trap during the winter because the females have their stomachs shaved for the spay/neuter surgery and lose some protection against the cold. They also believe, in general, that frigid temperatures and conditions are too hard on the cats for them to be TNR'ed in those conditions. Neighborhood Cats is based in New York City with its northeastern climate and we actually prefer trapping in the wintertime. The cats' coats thicken up in the autumn and they're prepared to handle the cold. There are far fewer pregnancies, almost no kittens or nursing mothers to deal with, and fixing the cats over

the winter gets you a big step ahead of the spring kitten season. However, we will only trap during the cold season if we know the cats have warm, dry shelter. As long as they have a good place to bed down in, our experience is they do perfectly fine after being fixed and released. If we're not sure they have adequate housing, we'll place shelters out into the cats' territory before any trapping begins. Only if we can't place shelters out and are unsure whether the cats have a good place to stay warm, will we hold back from trapping.

Other winter preparations include making sure there is plenty of fresh straw stuffed into the shelters and, if possible, placing the shelters close to the feeding station so the cats won't have to travel far in the cold. It also helps to ask your veterinarian to minimize the amount of fur shaved off a female's belly.

During the trapping, ensure both trapped cats and yourself have quick access to a warm space at all times, even if it's your car. You may need to use dry food in addition to, or instead of, your favorite bait because any kind of moist food will quickly freeze in low temperatures. Likewise, you may need to replenish your bait more frequently than in warmer conditions. After the surgeries, if there may be a sudden snowstorm or unexpected snap of bitter cold, be prepared to delay the release of the cats back outside for a couple of days.

One other advantage if you're trapping in the snow is the cats' paw prints become visible. You can literally see the paths they travel and place your traps accordingly.

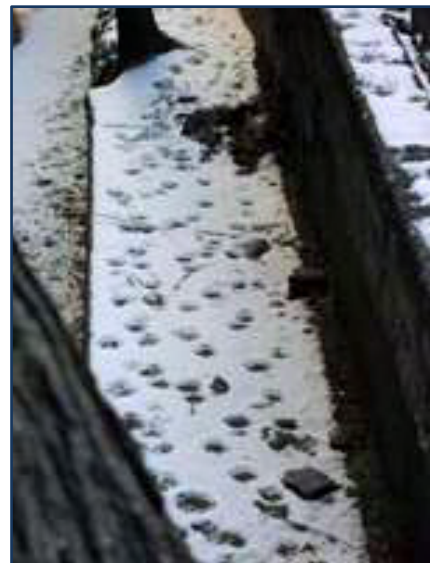

photo: Bryan Kortis

- **Transfers from traps**



During the trapping, you may want to transfer a cat from one trap into another or into a transfer cage or feral cat den. If two cats are caught in the same trap, you should separate them immediately with a trap divider then transfer the cat closest to the rear door. Or you may have a broken trap which a trapped cat can be transferred into, freeing up a good one.

The first step is to line up the rear door of the trap holding the cat with the rear door of the trap you're transferring into (or the front door if you're transferring into a transfer cage or feral cat den). The two doors should be pushed right up against each other. To be extra safe, attach the first trap to the second trap, cage or den with bungee cords so one can't shift and create an opening the cat can escape through. Another way to help prevent a sudden gap from forming is to back the receiving container up against an immovable object like a wall. Using two people is also a good idea, one to hold down the trap with the cat, the other to hold down what the cat's going into.

Completely cover the receiving trap, cage or den with a sheet and remove the sheet covering the cat's trap. Then lift up the two doors, being careful not to create a gap if there is a difference in height between the trap holding the cat and the receiving container. Feral cats tend to move naturally from bright, exposed spaces into dark, covered ones and most will move without further prompting. If he doesn't, insert a trap divider from above and give a gentle push in the right direction. Be patient and don't do anything that could cause the trap or receiving container to shift. After the cat has moved into his new lodging, lower its door and check that it's secure before pulling the first trap away.

- **Special cases**

- 1. Friendly ferals**

Never try to pick up a feral cat and place her inside a trap or carrier no matter how friendly she normally acts towards you. She may routinely rub up against your leg or let you pet her or even pick her up. Ferals get to know and trust their caretaker and some will show these signs of affection. This does not mean you can handle one like a tame, fully socialized cat. Most ferals will become terrified at being grabbed and forced towards an enclosed space. Faster than you can react, a feral in your hands can twist

around and inflict a severe bite or scratch in an attempt to escape. This can result in serious injury. Err on the side of safety and go through the trapping process with every cat in the colony unless you are certain a particular feline is a recently abandoned, friendly house cat. Even then, you are taking your chances because some tame cats don't take well to being placed in a carrier and also will defend themselves. If you are sure the cat is friendly and placing him in a carrier is appropriate, instead of picking him up, first put some tuna or something tasty on a paper or plastic plate in the back of the carrier and let the cat walk in on his own. Then quickly shut and lock the door behind him.

Any injury caused by a feral or stray cat should be treated in consultation with a medical doctor. Serious bacterial infections and other diseases could result from a seemingly minor wound that is left untreated.

2. Kittens

Never try to catch a feral kitten with your bare hands. Yes, their teeth and claws are small, but picture tiny razor blades cutting into your fingers – they can do some damage. If you're going to try to pick them up, use gloves made of a special protective material like Kevlar. A safer approach would be to use one of the methods described below.

- ***Setting the trigger lightly***

The same traps used to capture adults can be used to catch young kittens, even five or six weeks old. Unless the trap is creaky and needs some oil, a kitten's weight pressing down on the trip plate should be enough to shut the front door if you use a technique known as "setting the trigger lightly." On the Neighborhood Cats traps by Tomahawk, as well as most other models, the trigger is hook-shaped. The trap is set by pushing the trigger forward so it rests under a cross bar above the front door. On the Tomahawk traps, there's a small brass cylinder to mark the spot. When the cat steps on the trip plate, the trigger is pulled back, causing the front door to fall down. Normally, you push the trigger forward as far as you can so the elbow of the hook rests against the cross bar or brass cylinder. If you don't push the trigger all the way forward and instead rest the tip of the hook against the cross bar or cylinder (*Figure 9-2*), it will take less weight pressing down on the trip plate to make the trigger pull back and the front door shut.

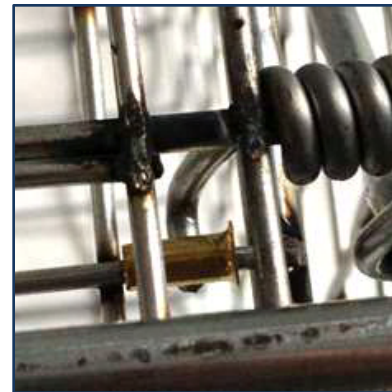

Figure 9-2

The same principle applies to Tru-Catch traps, although the trigger mechanism is different. With Tru-Catch traps, the trigger is set by resting two bars bent at right angles against each other – one bar is connected to the trip plate, the other to the front door. To set this trigger mechanism lightly, the two bars should rest against one another at their very tips.

▪ *The bottle-and-string trick*

There may be times when you only want to trap kittens and not any adults. Perhaps you're not ready to trap the whole colony, but want to catch a new litter of kittens while they're still young enough to easily socialize. One "kittens only" trapping technique is the bottle-and-string trick. It allows you to manually shut the front door instead of having it close automatically when whoever first comes along steps on the trip plate.

Take a plastic one-liter soda or water bottle (it should be a little less than the height of the trap) and fill it with water. Next, tie a string tightly around the base. Open the front door of the trap and prop a corner of the door on top of the bottle (*Figure 9-3*). Unwind the string until you're a comfortable distance away and draw the string taut. Wait until the kitten or kittens are well into the trap and then yank the string, pulling away the bottle and closing the front door.



Figure 9-3

One kitten will often follow another into a trap. If you set the trap using the trigger, it is possible one kitten will step on the trip plate and set off the trap while another is right below the front door. The force of the door shutting could cause serious injury to a small kitten. While a concern, in our experience this is a very rare occurrence. Nonetheless, if you want to eliminate this risk and also increase the chances of trapping multiple kittens at once, use the bottle-and-string method and don't set the trap in the normal way.

Some trappers prefer tying the string more towards the top of the bottle, believing the bottle will move away faster and more easily when yanked. Practice both techniques before you actually trap and see which you're more comfortable with.

When this method, always put a large bowl or plate of bait in the back of the trap, in case an adult or two come along before the kittens arrive and you're not able to shoo them away. You want there to be plenty of bait remaining for the kittens after the adults have a bite or two. You could also bring along a water gun or plant sprayer to try to discourage the adults from entering the trap and dining on the kittens' meal.

It's tempting, when using this technique, to try and wait until all the kittens you're after go into the trap at the same time. The danger is if you wait too long, a kitten or two already in the trap might dash out faster than you can react and pull the string, leaving you empty-handed. If one or two are in the trap and no one else is hovering close by, go ahead and pull the string, then set a new trap or transfer the kittens and re-set the old one. Another word of warning is to practice pulling the string and shutting the door at least once before you attempt it live. It's important to yank the bottle in one swift, smooth motion without any hesitation. Get to know the feel of it and how much force you need to pull with before you attempt the trick live. Otherwise, if you don't have the feel of it already, it's easy to do it wrong and startle the kittens away before you can recover.

The bottle-and-string method is useful not only for catching kittens, but for targeting any particular cat for trapping, like a pregnant female, a cat you missed during an earlier mass trapping and a cat who appears ill or injured. The best way to pick cats out of the crowd is by using a drop trap, as described in Chapter 10, but the bottle-and-string trick can work, too.

- ***“Kittens only” admission***

Another way to trap only kittens is to transform a regular box trap into a “kittens only” trap by use of a kitten screen. As discussed in the “Kitten screen” section of Chapter 8, Tomahawk Live Trap manufactures a screen designed by Neighborhood Cats which fits its traps that are 10 inches wide and 12 inches in height. It should work with any wire mesh trap with the same dimensions. The screen creates a 3 inch by 3 inch doorway in front of the trip plate which only young kittens can pass through. When using a screen, the trigger should be set lightly as described earlier in this section.

If you’re using traps which are not 10 inches wide and 12 inches high, you can make your own screen. Cut out a rectangular piece of cardboard the height and width of your trap. In one bottom corner, cut an opening of 3 inches x 3 inches. Place the cardboard inside the trap a few inches in front of the trip plate, positioning it so it blocks further access except for the doorway in the lower corner (*Figure 9-4*). To hold the screen in place and stop an adult cat from simply pushing it out of the way, poke holes in the three intact corners of the screen, next to the upper, outer corner of the doorway and next to the lower corner of the doorway as well. (see *Figure 9-4*). Attach the cardboard to the trap with twist ties or cable ties.



Figure 9-4

3. Nursing mothers

Free-roaming female cats can give birth at any time of year, especially in warmer climates. In all regions, births peak during the spring and again, to a lesser extent, in the early fall. Some TNR groups stop trapping during the peak seasons to avoid dealing with nursing mothers and baby kittens. Most, including Neighborhood Cats, work straight through. Whatever time of year it is, it’s important to decide ahead of time what you will do if you capture a lactating mom. That way you can make any necessary preparations and not have to make snap decisions in the heat of the action.

How to proceed with a nursing mother depends largely on three factors: (1) the age of the kittens, (2) the location of the kittens, and (3) how much information, if any, you have about their age and location.

One way to tell if a female cat may be nursing is to look at her belly. Lift up the trap and look at her abdomen from underneath. If her nipples are noticeably distended, this could be a sign of current or recent nursing.



▪ *Litters of unknown age and unknown location*

If you catch a nursing mom and have no idea how old the kittens are or where they're located, you have a difficult choice to make. You can let the cat go, knowing you may never catch her again and she may go on to have numerous more litters. Or you could get her spayed and release her as quickly as possible, hoping if there are any kittens waiting for her, they survive in her absence.

When making this decision, there are several things to consider. Feral kittens typically suffer a high mortality rate, often 50 percent or more. Even if you do release the mom immediately, there's still a significant risk some of the kittens, if they're alive, will soon die, anyway. Another fact to weigh is that kittens more than two weeks old will likely survive a day without nursing, while those younger probably will not. So if you can get the mom spayed and released within 24 hours, there's a reasonable chance the kittens will survive unless they are less than two weeks old.

Some caretakers believe it is wrong to ever take the risk there are kittens who will die in the absence of their mother. Others believe you should always get the mom spayed while you can. If you do not firmly hold to one extreme or the other, then the context of the particular TNR project you're working on may guide your decision.

Imagine, for example, you're TNR'ing a large colony of cats, say 50 or more, in a remote industrial park. The cats are fed sporadically by employees and forage scraps from garbage cans and dumpsters. There is no single caretaker who knows all the cats well and, after the trapping is completed, no one on-site will keep close track of the colony and help re-capture a nursing mother in several weeks. In these circumstances, if you immediately release nursing mothers, there's a good chance you'll never see them again and never have an opportunity to re-trap them. This could lead to the failure of the project to bring the cat population in the park under control. In this context, getting the nursing moms spayed and releasing them back as soon as possible makes a lot of sense.

By contrast, let's say you're TNR'ing a small colony of six cats who are fed daily and sheltered in the caretaker's backyard. As the trapping proceeds, the caretaker is surprised to learn one of the trapped females may be nursing. The caretaker is confident the nursing mom will continue to frequent the backyard and eventually bring any surviving kittens with her when they're old enough to eat on their own. In these circumstances, if

you let her go right away, there is a decent chance you'll be able to re-trap the mom later and prevent future births.

At Neighborhood Cats, we favor fixing the nursing mom, holding her overnight and then releasing her the next morning if all appears well. Our policy is to make decisions based on what we do know, not on what we don't. We don't know if there are any young kittens whose lives depend on the mother being released immediately. We do know we have a fertile female in the trap and the opportunity to get her spayed.

If you know ahead of time that you'll spay a nursing mom if you catch one, try to make contingency plans to get her to surgery as quickly as possible. This may mean asking the veterinarian to spay her before your other cats or getting her to the clinic sooner than the scheduled spay/neuter date.

A spayed mom cat can still nurse her kittens – the surgery does not affect her ability to produce milk. If you don't discover a female is nursing until she's already on the surgery table, you should always go ahead and have her fixed.

Before releasing a nursing mom who was just spayed, lift her trap and, from below, examine her carefully for any complications, like bleeding or swelling at the site of the incision. If you see anything of concern or if the cat appears unusually lethargic, consult your veterinarian about the best course of action.

▪ ***Litters of known age, but unknown location***

A caretaker may have observed one of her cats was pregnant and be able to approximate, based on the shrinkage of her belly, when she gave birth and thus the age of the kittens. If you do know how old the kittens are, even if you don't know where they are, it will make it simpler to decide what to do if you trap their mom.

If you know the kittens are less than two weeks old, you should release the mother right away. It's one thing if you have no idea how old the kittens are and whether they would perish if you hold onto their mom for at least a day. It's an entirely different matter when you do know the kittens are too young to survive without her. The compassionate choice in this case is to release the mother and try to catch the family at a later time. The sooner you let the mom out of the trap, the less traumatic the experience for her and the better your chance of trapping her again later.

If the kittens are older than two weeks, the risk of harm if their mom is gone temporarily decreases the older they are. Again, there is no single right answer. Some trappers will always let the mom go until the kittens show up and can be caught, too; others will always spay the mom first before releasing. If you're more flexible, context may be the key – given the colony's environment and dedication of the caretaker, how likely is it you'll be able to re-trap the mother if you let her go immediately? If you judge it unlikely, you might decide spaying the mom is worth the risk to the kittens. If re-capture seems likely, then releasing her at once could be a reasonable decision.

If you know you would release the mom right away, the best thing would be not to trap her in the first place. It can be hard though, even for a skilled trapper, to avoid catching any one particular cat when mass trapping a colony. Using a drop trap (see Chapter 10) or the bottle-and-string technique discussed earlier in this chapter, would allow you to decide which cats to trap and which not.

- ***Litters of known age and known location***

Knowing the kittens' age and their location gives you more options if you end up trapping their mother. Much will depend on whether you want to foster, socialize and adopt out the kittens, or leave them to grow up outside as ferals. Taking friendly cats and young kittens off the streets and placing them in good homes is always preferable, but resources do not always allow.

- (a) **No foster resources available**



photo: Meredith Weiss

If there is no one to foster the kittens while you look for homes, the best course of action is to delay the trapping until the kittens are old enough to be fixed. Generally, the rule of thumb for pediatric spay/neuter is two pounds, two months. Not all veterinarians, however, are trained in early age spay/neuter, so consult your veterinarian to find out the minimum age she is comfortable sterilizing.

If the trapping can't be put off and the mom ends up in a trap, you can go ahead and get her spayed while you care for the kittens in her absence. What kind of care is needed will depend on the kittens' age. If they are less than five weeks of age and unweaned, they will need to be brought inside, kept in a warm place, bottle-fed and possibly stimulated to pass urine and feces by gently rubbing their genital areas. It's a big job and your life will be easier if you can wait until they are weaned before trapping their mother.

If the kittens are weaned and eating on their own, you'll need to provide them with food and try to keep them in as safe a location as possible, preferably somewhere enclosed like a garage or shed so they can't go wandering off on their own. If necessary, consider bringing them inside and caging them for the short time their mom is away.

Here are some guideposts for aging baby kittens by sight: their eyes and ear canals start to open at 7 to 10 days old. Teeth come in at two weeks. At three to four weeks old, they become ambulatory and can start walking and even running. At five weeks, their normally blue eyes start to change color.

If you might have to care for unweaned kittens, have bottle-feeding formula on hand. “Kitten Milk Replacement,” also known as KMR, is available at many pet supply stores. For an alternative holistic nursing formula, see “The Natural Cat,” by Anitra Frazier (page 88).

If you’re caring for kittens less than five weeks of age (“bottle babies”), check out the highly informative, “Kitten Care Handbook” by Los Angeles-based Kitten Rescue (www.kitten-rescue.com). It’s important, for example, to hold the kittens in the proper position when feeding (tummy down as though nursing from the mother) and to use a special bottle designed for neonates, not an eyedropper, so the kitten can control the flow of milk.

(b) Foster resources available

If the kittens are going to be fostered and placed for adoption, then there are three ways you can proceed, depending on your situation:

- Trap the whole family and keep them together in a cage, using the Feral Cat Setup described in Chapter 12, until the kittens are eight weeks old, then start finding homes for the little ones. At that point the mom can be spayed and released. The great advantage to this approach is mom does all the work for you when it comes to caring for the kittens. You should handle the kittens as much as possible so they are well socialized and, if you brought the kittens in at an early age, gradually introduce kitten food when they’re five weeks old so they’re weaned by the time they’re ready for adoption.
- Leave the family outside and take the kittens from their mother when they are five to six weeks old and can eat on their own. This is the riskiest approach because the mortality rate for kittens living outdoors is high. You’ll want to gather the kittens as soon as they’re weaned because of the dangers of outdoor life and the need to begin the socialization process at as early an age as possible. Keep the litter together and don’t adopt them out until eight weeks of age so they have a chance to learn from one another about appropriate cat behavior, like not biting too hard.
- Leave the mom outside and take the kittens in when they are less than five weeks old and unweaned. This means you’ll need to bottle-feed and provide neonatal kitten care. This approach is much more work than bringing the mom inside, too.

There is a slight risk when you confine a feral family that the mother will attack her kittens. This is rare, but happens once in a while with a female cat who is extremely feral and greatly stressed by captivity. One way to assess this risk is to transfer the mom into a cage inside a feral cat den. While she is locked inside the den, place her kittens in the

cage and close the cage door. Observe how she reacts. If she appears calm, open the den's side door with a broomstick handle. Again, closely observe her behavior. If she growls at the kittens or appears at all aggressive, shut the side door of the den and re-evaluate, perhaps trying again a little later.

You can do the same kind of assessment in a trap. Transfer mom into a trap, then section her off on one end with trap dividers. Introduce the kittens through the opposite end. They will naturally move toward their mother. Observe her reactions. If all appears calm, remove the divider and see how mom interacts with her kittens. If there's any sign of trouble, insert the divider again and separate her from the kittens.

▪ *Trapping the family*

If you decide to trap the whole family, it's best to catch the kittens before the mother. That way, if you miss any, they won't be left alone without their mom. If you do get the mother before the entire litter, then keep trapping until you have them all, only taking a long break if absolutely necessary.

Assuming you do get all the kittens first, if you're then having trouble catching the mom, you can try using the kittens as bait. Put the kittens in a small carrier, then place the carrier behind a trap, its front door right up against the trap's rear door.



photo: Meredith Weiss

Drape a sheet over the carrier and both sides of the trap, leaving only the front of the trap uncovered. Set the trap. To reach her kittens, mom will have to enter the trap and walk towards the back, hopefully tripping the trap on the way. When using this technique, never leave the little ones unattended and don't use this method for more than an hour at a time to avoid fatiguing the kittens.

4. Pregnant cats

Gestation for a cat averages 63 days. During the early part of a pregnancy, there is no way to tell visually that a cat is carrying kittens. Towards the later stages, the female's belly is usually noticeably round and protruding below her. In the last one to two weeks of pregnancy, the nipples become distended and lactating actually begins shortly before birth.

If a cat is known to be pregnant, there are three options: (1) trap and spay her and abort the pregnancy, (2) trap her and let her give birth in a cage or other confined space where she can then raise the kittens or (3) don't trap her and allow her to give birth outdoors, trapping her and any surviving kittens at a future date.

Unless a caretaker objects on religious or other deeply personal grounds, Neighborhood Cats recommends trapping a pregnant cat and aborting the kittens whenever possible. This is because of the harsh realities of cat overpopulation. If the kittens are born and you find homes for them, it could mean other cats already in the shelter system will not be adopted and will be euthanized instead. If the kittens are born and not adopted, but live outdoors as ferals, their mortality rate is likely to be high and most of their lives short. Right now, with so many cats dying in shelters and on the streets, more kittens only make the situation worse. If your veterinarian is very experienced with spay/neuter, cats can be safely spayed right up until the last days of a pregnancy. Discuss with your clinic or veterinarian to find out what their policies are.

If the decision is not to abort, whether for ethical reasons or concerns for the health of the pregnant female, then what happens to the kittens becomes the focus. Should you trap the mom-to-be and let her raise the kittens in a cage, or leave her be to give birth outdoors? Certainly, having her give birth indoors in a secure environment will be much safer for the kittens. Outdoors, they face numerous threats - anemia induced by fleas, disease from other cats which their undeveloped immune systems can't fight off, predators, traffic, and more. In addition, if the goal is to eventually adopt out the kittens, it will be much easier and faster to socialize them if they are born indoors and handled by people from birth.

If the mom and her kittens are kept indoors, use the Feral Cat Setup (see Chapter 12), then when the litter is eight weeks or older, spay and release the mom and spay/neuter the kittens before adopting them out.

• **Wildlife**

If you're working in an area with wildlife, sometimes you may discover an uninvited visitor waiting inside one of your traps. They also like cat food and will wander in to check it out. You should release any wildlife immediately at the same location – remember, it's their territory, too. Proceeding carefully and with the proper technique will prevent injury to the animal and yourself.

Avoid having to release raccoons, skunks and opossum by offering them food outside the traps which they like and cats don't. In the traps' general vicinity, set out a few servings of the foods they like best. For raccoons, they love sweet foods like sweet corn, white bread and marshmallows. For skunks offer nuts, seeds, eggs, fruits and berries. Opossum adore fruits, tomatoes, acorns, persimmons, nuts and seeds. Remember, one nut or a couple of berries won't get the job done. Be sure to leave ample food or your furry dinner guests will finish the appetizers you've thoughtfully provided, then go in a trap and eat the cat food too.

▪ *Raccoons*

Raccoons are usually very docile and will not put up a fight when you approach them in a trap. It may be tempting to just open the rear door and wait for the raccoon to exit and be on his way. The danger lies in their adroit paws, which act almost like hands, and have very long claws. Raccoons are a vector species for rabies, meaning they are common carriers of the disease, and if you get too close and are scratched, even lightly, you will be exposed to a possible infection. This could mean either the animal has to be killed in order to test his brain for the presence of rabies or you have to undergo an expensive prophylactic treatment, or both. Same thing if you're bitten. It's far preferable to handle the situation carefully and avoid these consequences.



If you are bitten or scratched by a raccoon, skunk or other vector species for rabies, always consult a medical doctor for treatment!

If you're working in an area with raccoons, you'll need to plan ahead and have the right equipment – a broomstick, heavy blanket and Kevlar gloves.

When a raccoon is in a trap, throw the blanket completely over the trap from a short distance away to help protect you from the raccoon's claws. Then pull the blanket back from the very rear of the trap only, lift and remove the rear door and quickly move away. If you're with someone, first pull the blanket back from the very front of the trap. Have your partner bend down and face the front door from a safe distance and distract the raccoon while you open the rear door. For added safety, wear a pair of Kevlar gloves. Elbow-length, bite-proof Kevlar gloves are the safest, but they are more expensive. If cost is an issue, get a pair of short, cut and puncture resistant Kevlar gloves. You can find these products at BiteBuster (www.bitebuster.com) or search Amazon (www.amazon.com).

If you need to transport the trap a short distance before releasing the raccoon, do not lift the trap by the handles. At all times, you want to remain out of arm's reach of the raccoon who may be able to fit his paw or claws through the wire mesh of the trap. Instead, slide a broomstick or similar long object through the trap's handles. Two people, one on each end of the broomstick, can then carry the trap. When you reach the release spot, cover the trap with the blanket and proceed. If you're alone, consider using the "Trap



Figure 9-5

Caddie” by Tomahawk (see *Figure 9-5*), but be very careful attaching it to the trap. Throw the heavy blanket over the trap first, before attaching the Caddie (go to www.livetrap.com for this product).

After releasing the raccoon, clean the trap thoroughly, wearing protective gloves, before using it again. Be extra cautious if you see blood or saliva in the trap and don't touch any with your bare hands. In warm conditions, the rabies virus can live for a matter of seconds or minutes outside the host's body. In much colder temperatures, the life span of the virus may be considerably longer. The virus can also survive for a matter of days in an animal that is deceased.

▪ *Skunks*

Like raccoons, skunks are vector species and may be carrying rabies and every precaution must be made to avoid a scratch or bite. The more immediate danger though is the extremely noxious spray that frightened skunks emit from their anal glands. Fortunately, they're not as trigger-happy as many people fear and rarely spray something they can't see. To avoid getting sprayed, you'll need to cover the trap with a heavy blanket before releasing the skunk (it's important the blanket is heavy, so it can be thrown more easily). Calmly approach



the trap and throw the blanket over it from as far a distance as you can. Then step back and wait a moment. If all appears well, quickly open the rear door and move away.

Keep in mind that skunks don't see very well so if you act quickly, you should be okay. If the skunk starts stamping his feet, run for the hills! He's warning you he's about to spray if you don't back off.

▪ *Opossums*

Opossums are very gentle, almost entirely nocturnal animals and pose little threat. They have very poor eyesight, especially in daylight, so when releasing them, carry the trap first to a nearby tree or wooded area. That way they can find a place to climb and hide quickly and not become frightened and search around blindly. Cover the trap with a heavy blanket before lifting and avoid rubbing up against the side of the trap as you carry it. Step back after opening the rear door.



photo: Keith Vyse

- **Hard-to-catch cats**

The goal for every caretaker is to have 100 percent of the cats in the colony spayed and neutered. This alone ensures no more kittens. But many colonies have one or two cats who just won't go in a normal box trap, no matter how long you deprive them of food or how many different types of bait you try. For these stubborn holdouts, there are a variety of battle-tested special techniques you can try. Be persistent and eventually one of these methods will work for you.



photo: Meredith Weiss

Do not, out of desperation, try using a net or graspers to catch a feral cat. The danger lies in having to handle the cat after you've grabbed him, assuming you succeed in doing so. Transferring a cat out of a net or graspers and into a trap or transfer cage requires special training and only animal care professionals should ever attempt it. Always keep in mind that a frightened cat can inflict severe injury, which is why this handbook only teaches trapping and care techniques which avoid physical contact between the cat and yourself.

Tranquilizers also should never be used. First, the delivery method could risk injury to yourself or the cat. If you use a syringe, your arms and hands will be at least momentarily exposed to a bite or scratch. If you use a dart gun, assuming that's even legal, you could easily misfire – for example, if the cat suddenly moves – and hit the cat in the eye or other vulnerable spot. If you put drugs in the cat's food, the wrong cat or another animal might ingest it. However a tranquilizer is delivered, the cat could run off before the drug takes full effect and harm himself. Try one of these approaches instead:

- ***Drop trap***

In most cases, a drop trap will be the fastest and most effective way to capture your hard-to-catch cat. It originated as a grassroots invention designed by creative trappers, most notably Laura Burns. The trap is propped up on a stick or similar object to which a string is attached. When a cat goes under to eat the bait, the trapper pulls the string and the trap falls down over the cat. The cat is then transferred out of the drop trap and into a regular box trap or transfer cage.

As mentioned earlier in Chapter 8 (“Recommended Equipment”), a drop trap works so well because a cat usually has no natural fear of going under it and the wariness displayed with a box trap is absent. Because cats are much less afraid, they do not have to be deprived of food for a long period before the trapping. Withholding food the same day will be sufficient to get them interested enough in the bait. Because a drop trap is so

effective, some experienced trappers will use it instead of box traps to catch all the cats in a colony, not just the more difficult ones.

When the first edition of this handbook was published, we included instructions on how to build a drop trap because none were commercially available on a large scale. Since then, Neighborhood Cats has teamed up with Tomahawk Live Trap to design a mass-produced model and now all you need to do is place your order. The trap does require a little training and practice. Chapter 10 describes in detail how to use one.

For the do-it-yourself trapper who wants to build her own drop trap, check out the Drop Trap Design Bank (<http://droptrapdesign.blogspot.com/>). Trap designs, demonstration videos and more are available.

▪ ***Train the cat to enter a box trap***

If a box trap can be safely left out for one to two weeks, a cat can be trained to enter it to eat. Begin by securing the front door of the trap in an open position. Use a cable tie or run a stick or rod through both sides of the trap just below the open front door, blocking it from falling. Place the trap near the normal feeding station or spot.

The first day, put a plate of food on the ground a foot or so away from the front of the trap. Keep placing the food at this spot until you see it's being eaten. Then, next time you feed, move the plate so it's still outside the trap but right below the open front door. Again, wait until you see the cat is eating from the plate, and then move it a few inches inside the trap. Continue this process until the plate is at the back of the trap and the cat is going all the way in. Then set the trap.

This method works well with lone cats, but can be problematic if the hard-to-catch cat is part of a larger colony. In that case, you might not be able to tell whether the target cat is eating the food and being trained to go in the trap as opposed to other cats in the colony. If the colony is a small one, say six cats or less, you could try training all of them by putting all of their food on the plate or in a big bowl. Then when you're confident your target cat is among those entering the trap to eat, use the bottle-and-string trick to single him out (see "Bottle-and-string trick" in the "Kittens" section earlier in this chapter).

Training a cat this way assumes it's safe to leave a trap out unattended for an extended period of time. A private setting, like a caretaker's backyard, is best. If the location is accessible to the public, precautions to protect both the cat and the equipment should be taken. The trap should be locked with a chain to an immovable object, like a fence post or stairwell rail. The rear door should be removed and taken away, rendering the trap useless if anyone wanted to try setting or taking it. In this situation, where the cat can enter either the front or rear door, the goal is to train the cat to go to the middle of the trap's interior to eat.

Even with these precautions, if the trap is too visible and foot traffic is too high, this method should not be used. Only try it in a publicly accessible place with light traffic. Even then, find a spot that is at least somewhat hidden, like behind a concrete barrier or some bushes.

A variation of this method can be used before you even find out whether you have a hard-to-catch cat on your hands. If the site is private and secure, like a residential backyard, then a couple of weeks before the trapping date, put out as many traps as there are cats and start training the entire colony to eat out of them. When the big day arrives, you may be surprised how quickly they're all caught.

- ***Camouflage trap***



Blending the trap in with its surroundings or disguising it in some manner may lure a cat in. If you're trapping in a setting with grass, trees or bushes, drape burlap over the sides of the trap and on the trap floor. Cover the burlap with leaves and branches, making sure not to create an obstruction which would prevent the front door from closing. Also, don't cover the rear door – you want the cat to be able to see all the way through to reduce his fear of entering.

There are many other ways to disguise a trap. Put it inside a large cardboard box, again leaving the rear door uncovered so the cat has a line of vision all the way through. Lean a large board against a wall and put the trap behind it. Rest objects, such as debris, a wooden plank or a trash bag on top and against the sides of the trap to make it appear more like part of its environment. The more the trap appears like a natural part of the environment, the less hesitant the cat will be going inside.

- ***Lure into a closed space***

If you can lure a cat into an indoor space like a shed, garage or room and securely shut him inside, there are a couple ways to then get him into a box trap, though avoid using a room with ceiling tiles or a drop ceiling which would allow a cat to hide in the ceiling. Before luring the cat inside, you'll need to set things up.

The simplest kind of "indoor trapping" is to place a baited trap in the room before the cat arrives and set it in the normal manner. Once the cat is shut into the indoor space, you wait it out. If the cat is trap shy, it might take two or three days before he'll enter the trap. In the meantime, make sure fresh water is always available and a full litter pan. Put out a pile of newspaper as well in case the cat doesn't understand what a litter pan is. The only food available should be the bait in the trap. Be very careful when entering and exiting the space to avoid an escape. If the cat does not go in after two or three days, start using food to train him to go into the trap (see "Train the cat to enter a box trap" earlier in this chapter.) Don't withhold food indefinitely and risk damaging his health.

A faster technique takes a bit more work. Before the cat is lured into the room, remove or seal off any hiding places – anything the cat might go behind, into or under. If the cat is already in the space, leave his hiding place alone and remove or seal off all the rest. Then take a large board or piece of cardboard, approximately five feet high and four

feet long, and lean it up against a wall at an angle. Place a set trap behind it without any bait (*Figure 9-6*). Towards the back of the trap, drape a sheet over the board so it visibly blocks any open space above and to the side of the trap. Leave the rear door uncovered (*Figure 9-7*).

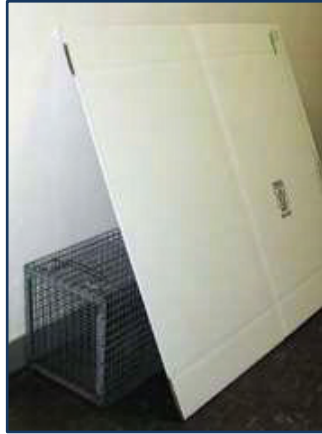

Figure 9-6



Figure 9-7

Once everything is ready, lure the cat into the room and shut the door, or gently shoo him out from his hiding spot if he's already inside. Once he enters the room for the first time or is flushed out from his spot, he'll look for somewhere to hide. The only place he'll see is behind the board and he'll naturally go running behind it. The sheet will make it appear that he'll be blocked in if he goes over or around the trap, so in most cases, he'll go right in and step on the trip plate. He won't realize, in the heat of the moment, that he could easily push the sheet aside.

If the cat doesn't go all the way into the trap or stops just in front of it, walk slowly towards him, causing him to run away from you and into the trap. You could also slowly move a long object, like a broom stick, towards him. Be careful not to get too close and within his striking range. If he still doesn't go into the trap, exit the room, give the cat time to calm down, then come and try again to get him to run behind the board.

Another approach, if there is a closet in the room, is to set a trap inside it. Leave the closet door open a crack - just enough so the cat can run in. Make the interior of the closet dark and the rest of the room as brightly lit as possible. Block or remove any other hiding places. When the cat enters the room or is shoed out from behind wherever in the room he's hiding, his natural tendency will be to run from the bright open space to the dark enclosed one and, hopefully, into the trap. This method is less reliable than the "trap behind the board" technique because there is more of a chance the cat will enter the closet but not the trap.

If all else fails, bait the trap, withdraw and wait it out.

▪ ***Picking one out from the crowd***

A cat may be hard to catch because there are lots of other cats around who you're not after. This situation is typical when a colony is trapped and neutered gradually and you

get down to the last few unaltered felines. You might also want to trap a particular cat who is pregnant, recently abandoned or sick or injured.

A drop trap is the most effective way to selectively trap (see earlier in this chapter and Chapter 10). In lieu of a drop trap, another way to pick a cat out of the crowd is to use the bottle-and-string method described earlier in the “Kittens” section of this chapter (see also *Figure 9-3*). Be sure, before the trapping, to practice setting the front door on the bottle, then yanking the string from a distance. It sounds easy enough, but it’s important to get the feel of it before you go live and have a cat in the trap.

Whether you use a drop trap or the bottle-and-string approach, put an extra-large amount of bait in the trap. This will allow a number of cats to go in and eat while you’re waiting for the one you want.

- ***Cats who avoid the trip plate***

On occasion, you may encounter a feline who won’t step on the trip plate. She may step over it, tiptoe around or even lean and stretch her neck far enough to grab a bite of the bait. If you see a cat in a trap who has avoided the trip plate and is calmly eating, don’t hurry over and cause the cat to rush out in a panic, because then she may be too frightened to ever return. Instead, walk towards the trap slowly and casually, giving her plenty of time to stop eating and exit when she becomes concerned about your approach. Sometimes on her way out, the cat will step on the trip plate.

If the cat does exit, then when she’s a comfortable distance away, cover the trip plate and the rest of the trap floor with a sheet of newspaper, using clothes pins to attach the paper to the sides of the trap. Now she won’t be able to see where the trip plate is next time she goes in. You can also take a stick and push it through the sides of the trap a few inches above the ground and just in front of the trip plate (*Figure 9-8*). Now, to reach the bait, the cat will have to step over the stick and onto the hidden trip plate.



Figure 9-8

- **Cleaning traps & equipment**

At the end of each trapping project, it’s important to thoroughly clean the traps and any other equipment used, such as trap dividers or cages, in order to prevent the spread of disease. First, any loose materials should be scrubbed off. Then the equipment should be dipped in a bleach solution. The scrubbing should be done first in order for the bleach solution to effectively sterilize all surfaces.

A diluted solution of 1 part bleach to 32 parts water (1:32) will kill most common feline viruses, including feline distemper. The bleach needs to contain at least 5.25% sodium hypochlorite, which is the active ingredient. You can find the percentage of

sodium hypochlorite on the label of the bleach container. Most “ultra” bleaches will have the necessary amount, but do check. Most of the time, you shouldn’t use more than a 1:32 solution because bleach is corrosive to metal and repeated cleanings with too strong a solution will ruin your traps and other equipment. If ringworm may be present, then you’ll need a stronger solution to kill any spores. Several cleanings with 1:10 bleach to water solution will kill ringworm spores or one cleaning with undiluted bleach.

To dip the traps in what is close enough to a diluted 1:32 bleach solution, use a 30 gallon Rubbermaid or similar garbage can. Fill the can a few inches from the top with water and then pour in a gallon of bleach. Be sure to use rubber gloves and eye protection, like safety goggles, to prevent burns from splashing. Wearing pants and a long-sleeve shirt will give you added protection. Dip one end of the trap into the can, then lift it up, turn it over and dip the other end.

Remove the trap from the can as soon as it’s been fully dipped, place it on the ground and let it air dry with the bleach solution on it. Once the traps are dry, thoroughly rinse them off with a hose, removing all bleach residue. At all times, move the traps slowly and carefully to avoid getting the bleach solution on yourself, but if you accidentally do get some on your skin, wash it off immediately and apply Aloe Vera gel to mitigate any burns.



photo: Meredith Weiss

10. The Neighborhood Cats Drop Trap

A drop trap can be an essential tool for anyone doing TNR on a regular basis. Cats too afraid to enter the narrow, confined space of a box trap often show no fear of walking under a drop trap. It can be used to catch the holdouts during or after a mass trapping and to pick out kittens or any injured, ill or pregnant cats from the rest of the colony. For some trappers, drop trapping is the preferred approach for capturing all the cats they're after, not only special cases.



Until recently, there was no mass-produced drop trap and most caretakers had to build their own. At Neighborhood Cats, we recognized how important this piece of equipment is for TNR, so we teamed up with Tomahawk Live Trap to design the Neighborhood Cats Drop Trap, a model which is affordable, durable and easy to set up and transport. The trap folds up like a suitcase and can be set up in a few minutes or less. Being all metal, it's easy to clean and sanitize, unlike most home-made drop traps. For more specifics and information on how to order, see "Drop traps" in Chapter 8.



A drop trap is a more complicated tool to use than a regular box trap – there's much more involved than setting the trigger, standing back and waiting for a cat to step on the trip plate.

The purpose of this chapter is to describe how to use the Neighborhood Cats Drop Trap. Most of what is said will apply equally to home-made drop traps as well. Before going into much more detail, here is a quick overview of the process: First, the trap is placed on a level surface near the cats' usual eating spot. The front of the trap is then raised up on its prop bar and a bowl of bait is placed in the back. The trapper stands a distance away, holding a string or cord attached to the prop bar. When the desired cat is under the trap and eating out of the bowl, the string is yanked, pulling back the prop bar and dropping the trap down over the cat. The cat is then transferred into a box trap through the guillotine door on the side.

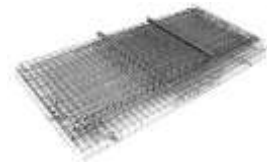

Never try to use a drop trap for the first time on that elusive cat you've been after for the last five years! It takes a little practice to get used to the process, so first time out, use it on a cat or two who are already fixed. You can either let them go after transferring them into box traps (it's important to practice that part, too) or getting their rabies vaccinations updated. After you've given yourself a chance to make mistakes and learn, you'll be ready for Grandma!

• Preparations

As with any trapping, it helps to get the cats on a routine so they show up daily at the same time and place to eat. That way you know where and when to show up to trap. One of the big advantages to using a drop trap is that you don't have to withhold food the day before the trapping. Because the cats are less fearful of a drop trap, they don't need to be as hungry before they'll go under. Just don't feed the day of the trapping. Then they should be interested enough to check out the bait.

Here's a list of materials you'll need, in addition to the drop trap itself:

- ❑ Box traps with guillotine-style rear doors or transfer cages (as many as the number of cats you plan to trap)
- ❑ Trap dividers
- ❑ String or cord (should be strong, at least 50 feet in length and wrapped around a stick or similar object)
- ❑ Heavy object, like a large rock or bucket of rocks (for weighing down the drop trap)
- ❑ Large blanket (to cover the drop trap)
- ❑ Sheets (to cover the box traps or transfer cages)
- ❑ Large plastic bowl or equivalent
- ❑ Bait (lots of it!)
- ❑ Binoculars (*optional* - for spotting eartipped cats or if you're going to watch the trap from a far distance)

• Setting up the trap

▪ *Choose a location*

The first decision is where to place the trap. Four factors should be considered in choosing the optimal spot:

(a) **Good visibility.** You'll need to see the trap clearly from a distance so you can tell when to pull the string.

(b) **Flat surface.** Choose a place where the ground is flat. If there are any gaps between the trap and the ground after it drops, a determined cat can insert a paw and push the trap up just enough to escape.

(c) **Location near the usual feeding site.** Ideally, the trap will be set up where the cats are used to coming to eat.

(d) **Adequate space for a box trap.** Remember, you're going to have to transfer cats out of the drop trap through its sliding side door and into a box trap or transfer cage. Make sure there's enough room on the side of the drop trap for a box trap or transfer cage to fit.

- **Assemble the trap**

(For a video demonstration of how to set up and disassemble the drop trap, go to the TNR Drop Trap page at www.livetrapping.com.)

1. First steps. Separate the main frame of the trap from the top (Figure 10-1). Unfold the main frame so it stands up and forms a square, and then unhook the weight flap, laying it flat (Figure 10-2). Remove the sliding door and temporarily put it aside (Figure 10-3).



Figure 10-1



Figure 10-2



Figure 10-3

2. Attach the top. Unfold the top then place it over the main frame of the drop trap (Figure 10-4). Attach all the spring clips to the top (Figure 10-5), except the two clips right next to the frame of the sliding side door, one on either side. These two clips are used to attach a box trap or transfer cage during a transfer of a cat out of the drop trap (Figure 10-9). Except for these two, all other spring clips should be fastened so no gaps can form if a captured cat pushes up against the top.



Figure 10-4

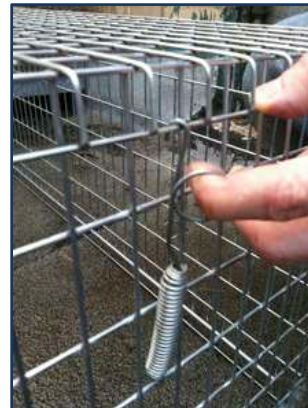

Figure 10-5

3. Re-insert the sliding door. Secure the roll hooks at the top of the sliding door to the top of the drop trap, locking the door in place.

4. Anchor the trap. Place a heavy object, like a large rock or bucket of rocks, on top of the weight flap. This will help keep the trap from moving around once a cat is caught.

5. Raise the prop bar. Raise the front of the trap off the ground so it's resting steadily on the prop bar (*Figure 10-6*). Tie your string or cord at the bottom of the prop bar, below the cross-bar.



Figure 10-6

▪ ***Bait the Trap***

Fill the bowl or other unbreakable container with a generous amount of bait. You can use the cats' normal food, but canned mackerel, tuna or something extra tasty is a good idea to help attract any reluctant cats. The trick is to have a big enough bowl and put lots of bait in it, especially if you're after a particular cat or cats. You want other cats to be able to go under the trap, have a bite and leave plenty of bait behind. What you don't want to do is keep walking over and replenishing the bowl and potentially scare your target cat away.

Place the filled bowl at the very back of the trap – the side with the weight flap - and in the center (*Figure 10-7*). This forces a cat to go as far into the trap as possible before settling in to eat.

To encourage skittish cats or kittens to enter the trap and find the bowl, make a trail of bait leading under the trap from a few feet away. Crumbled cat treats, juice from canned mackerel or small bits of chicken usually work well.



Figure 10-7

▪ ***Final Setup***

Place a box trap or transfer cage, and a sheet for covering it, within arm's length of the drop trap. We recommend also placing nearby the blanket you'll use to cover the drop trap once you've caught someone. Having these items within easy reach of the drop trap will save you from running around trying to find them in the heat of the moment.

Finally, position yourself. Unwind the cord and move far enough away so that the cats will not be uneasy with your presence. Ideally, you should be directly facing the front of the trap and not be off to the side. This will ensure a smoother and faster yank of the cord at the moment of truth. If you're off to the side, it's possible the prop bar could jam or hesitate, giving the cat just the split second she needs to get out before the trap completely drops. If you're trapping at night, you can use a flashlight or the headlights from your car to illuminate the drop trap – the beams shouldn't bother the cats.

- **Dropping the trap**

Be patient! That's the number one rule of drop trapping. Wait until the cat or cats you're after are crouched over the food bowl and fully engaged in eating before you pull the string. Preferably, they will not be looking in your direction. It is amazing, but if a cat is not distracted enough by eating and sees you pull the string, he can get out of the trap before it hits the ground. So don't get over-anxious and yank the cord as soon as a cat steps under the trap. Likewise, if the cat appears nervous and furtive as he starts to go under, wait. Even if he darts out, chances are he'll be back when he sees everything is okay. The worst thing you could do is pull the cord too soon and not only have the cat escape, but become too frightened to return.

When you do pull the string, don't hesitate at all, but give it a good, hard yank. Hesitating could cause the string to move, alerting the cat and giving him a chance to get out before you recover. This is why it's important to practice pulling a few times before you try it live.

Be aware there is a risk of injury if a cat is hit by a falling trap, one more reason to be patient and wait until she's enjoying the bait. Don't pull the string if there's a cat sitting or standing by the edge of the trap while another is eating. Also, be cautious when trapping kittens or cats who are sick or injured and may have trouble moving. Be sure they're all eating and clear of the trap's edges before pulling.

If your top priority is to catch a particular feline, like a pregnant cat or a wily, hard-to-catch feral, avoid dropping the trap on any other cats until you've caught that one. If the one you're after sees her mates going under, having a bite and coming back out with no problem, she may be reassured about going under herself. If you were to drop the trap before you caught her and she was close by, most likely she would scatter along with any other nearby cats. Most of the time, the cats return soon afterwards, but you don't want to take that chance and give her any reason to be suspicious of the trap.

Sometimes you'll be able to catch more than one cat or kitten at the same time. You may see a mom and her litter all coming to eat together. It's fine to drop the trap on more than one cat provided they're all engrossed in eating.

- **Transferring out of the drop trap**

1. Cover the drop trap. Once the trap is dropped and a cat is captured, he's going to frantically try to find a way out. You need to cover the entire drop trap with the blanket as quickly as possible to help him calm down and reduce the risk of injury. Use a blanket rather than a sheet; it will block out more light and be easier to throw over the entire trap. Wait for the cat to settle down before attempting the transfer.

2. Line up and secure the box trap or transfer cage. Align the rear door of the box trap with the sliding side door of the drop trap, making sure there are no gaps between them (*Figure 10-8*). Drape the sheet over the top and sides of the box trap or transfer cage, being sure to leave the end opposite the drop trap uncovered. During the transfer, you want to trick the cat into thinking the only way out is through the box trap or

transfer cage, so the far end needs to be uncovered and looking like an exit. If you're transferring into a box trap, double-check that its front door is shut.

3. Attach the spring clips. Find the extra spring clips next to the frame of the drop trap's sliding door, one on either side, and attach them to the box trap or transfer cage (*Figure 10-9*). This will help keep both traps in place and prevent gaps from forming during the transfer. Be careful not to pull the clips too far and tight or the door of the box trap or transfer cage will press too hard against the drop trap's sliding door, making it difficult to open and close. Once you've secured the clips, test opening and closing the drop trap's sliding door. If there's too much resistance, loosen the spring clips and don't pull them out as far before re-attaching.



Figure 10-8



Figure 10-9



Figure 10-10

4. Position yourself. Place one foot on top of the box trap to further keep it in place. Make sure both the drop trap and box trap or transfer cage are fully covered so the cat won't be able to see you when he approaches the doorway.

5. Open the doors. Release the roll hooks at the top of the drop trap's sliding door. Then, at the same time, lift up both the sliding door of the drop trap and the rear door of the box trap or front door of the transfer cage. Don't completely remove the doors from their frames, but hold them up (*Figure 10-10*). Wait quietly for the cat to make the next move. Within a minute or two, most cats will see light coming from the far end of the box trap or transfer cage and head in that direction. Through the sliver of space created between the sheet and blanket when you lift the doors, you should be able to see the cat pass out of the drop trap. If not, pull back the sheet an inch or two from the doors so there's a little opening you can watch through. Once the cat fully enters the box trap or cage, close its door. If you've caught more than one cat, also shut the door of the drop trap. Completely cover the box trap and carry it away.

6. Repeat transfer for any remaining cats. If there are any cats remaining in the drop trap, completely cover the drop trap, bring over another box trap and repeat the transfer procedure.

7. Problem cats. Most cats will run into the box trap or transfer cage as soon as you open both doors. Sometimes though, you'll run into a problem kitty who won't cooperate and stays in the drop trap. The first thing to try, especially if you're alone, is to slowly pull the blanket on top of the drop trap towards you, exposing more and more of the space beneath. Frightened ferals prefer to be covered and in the dark. As you pull the blanket off, the only place which will fit that description is inside the still covered box trap or transfer cage and that's where the cat is likely to go.

If you have someone helping you, have him to walk to the opposite side of the drop trap from you. He should then lift the blanket from that side, kneel down to the cat's eye level and stare right at him, being careful to remain far enough back to avoid getting scratched. The cat will usually respond by running in the other direction, towards the doorway. If the cat still won't go, your partner can try gently poking a long, thin rod or stick towards the cat to encourage him to run away, hopefully into the box trap or transfer cage.

If all else fails, be patient and wait quietly. Eventually, the cat will start exploring and looking for a way out.

8. Two cats enter the box trap. If you caught more than one cat with the drop trap and two go into the box trap or transfer cage at the same time, shut the doors and immediately separate them with a trap divider. Then transfer one into another box trap or cage (see "Transfers from traps" in Chapter 9).

If you forgot to bring a trap divider, cover the box trap or transfer cage completely and see if the cats remain calm. If they do, wait until you have a divider or have transported them to a secure indoor space before doing a transfer. If they are not calm and you fear an injury, you may have to attempt a transfer out at the trapping site without a divider. One possibility, as an absolute last resort, is to transfer one or more of them back under the drop trap and then try again to get one at a time out. They might not be so quick to come out of the drop trap, though, the second time around.

9. Escapes. If a cat escapes by getting out from under the drop trap before it hits the ground or during the transfer – don't give up! He may return later and go under the drop trap again. It may help if there are other cats in the colony who the escaped cat can observe going under and eating without incident. Don't drop the trap again until your escapee has been caught.

• **Disassembling the trap**

Disconnect the top by pulling the spring clips loose. Important! – re-attach the spring clips onto the top of the main frame. Don't let the clips hang loose or they'll become tangled with other parts of the trap and may break. Also attach the two clips by the sliding door onto the main frame. (If you need extra or replacement spring clips, you can order them from Tomahawk Live Trap – www.livetrapped.com.)

Untie the cord from the prop stick and wind it up. Next, raise the weight flap and re-attach it to the main frame with the roll hooks. Insert the sliding door if it's been removed. Then fold the main frame flat. The main frame will then fit inside the top, which folds in half like a suitcase.

11. Caring for Cats in Traps



photo: Bryan Kortis

While the colony is being trapped, which can take two or three days, and for at least 24 hours after the spay/neuter surgeries, captured cats need to be kept confined. The safest and most cost-effective way to do this is to keep the cats in their traps at all times rather than transfer them into cages or other enclosures.

Using traps as cages has many advantages. Much less space is required for housing the cats than if all of them were put in separate cages, plus the expense of buying the cages is saved. Most importantly, keeping the cats in their traps is much safer. No transfers of cats into and out of cages have to be performed, greatly reducing the risks of injury and escape.

Often when people first hear of this method, they jump to the conclusion it's inhumane to keep a cat in that small of a space for days at a time. This belief reflects a basic misunderstanding of a feral cat's temperament. No matter how large a cage you put a feral cat in, if there's a space in the cage where he can hide, like a carrier, feral cat den or box, he'll spend almost his entire confinement inside it. When they're under stress, ferals greatly prefer spaces that are tight, dark and covered because they feel more hidden and protected. They do not want to be in a large, wide-open space. This is why feral cats who are kept in a normal cage should always be provided with a den or the equivalent where they can hide.

As long as the traps are at least 30 inches long (preferably 36 inches) and kept covered and clean, the cats are absolutely fine. They quickly get used to the feeding and cleaning routine and most of them soon become relaxed. They'll spend their time crouching or lying down in their traps, resting quietly. It can be surprising at first just how quiet a room full of confined feral cats can be.



photo: Meredith Weiss

• **Materials needed**

- ❑ Traps with rear doors (at least 30” in length; 36” is preferable)
- ❑ Trap dividers (at least one pair)
- ❑ Cotton sheets for covers (one per trap)
- ❑ Newspaper (lots of it!)
- ❑ Water dishes (with flat bottoms)
- ❑ Food dishes (paper or plastic)
- ❑ Plastic drop cloth (at least 3 millimeters thick)
- ❑ Latex gloves
- ❑ Garbage bags
- ❑ Tables (optional)
- ❑ Small towels (optional)

• **Preparing the holding space**

Start to prepare the holding space by spreading a plastic drop cloth at least 3mm thick over the floor. The plastic will catch any waste that escapes from the traps and make it easier to keep the space clean. When the project is over, the plastic can be rolled up and thrown out. You can also replace the plastic when the cats all go for their surgeries, which will help with cleanliness and reduce any odors.

If they're available, set up tables to place the traps on. Six-foot long craft tables are ideal and can comfortably fit five traps each. While tables are not essential, the feeding and cleaning goes faster when the traps are raised that high. If you do use tables, also cover them with plastic. If possible, leave room for you to access both ends of the traps. If that's not possible and there's only space for you to access one end, you'll need to lift each trap and turn it around during the feeding and cleaning.

When the cats are brought in, line up the traps in rows, the rear doors all facing the same direction, and leave a few inches between traps if you can. Every trap should be covered with a sheet during the entire stay. For ventilation, if it doesn't alarm the cats, leave the front and rear doors of the traps uncovered. If you know two particular cats are close friends or mother and kitten, press their traps up against one another length-wise and use one sheet to cover both traps. This way they can see and comfort one another.

The holding space must be warm (at least 65 degrees Fahrenheit). Keeping confined cats in too cold of a space could result in illness and even death if they are placed inside a cold room too soon after surgery. In hot weather, fans can be helpful to keep the temperature down. Be sure all electrical cords and appliances are safely installed.



• Feeding and cleaning

The traps should be cleaned and the cats provided with fresh food and water twice a day. This section provides a step-by-step guide for doing this safely and efficiently. A video of the process, performed live on a feral cat, is part of our “How to Perform a Mass Trapping” video which can be viewed at www.neighborhoodcats.org. We’ve also excerpted the feeding and cleaning segment so you can view that alone on the “Caring for Cats in Traps” page of the website. We recommend you wear latex gloves while doing this work to help keep the process sanitary.

1. Move the cat to the rear of the trap

Start at the front door end of the trap. Get the cat to move to the other end by folding back the sheet so only the rear of the trap is covered while the front is exposed (*Figure 11-1*). Ferals tend to move from light to dark and will usually retreat when the sheet is folded back. If this doesn’t work, insert one of the dividers from above and give a gentle push towards the rear.



Figure 11-1

2. Section the cat off



Figure 11-2

Once the cat has moved to the rear, insert two trap dividers in the middle of the trap, one right behind the other as shown in Figure 11-2. You can insert the dividers right in front of the top plate or just in back of it. The cat is now sectioned off and cannot escape when you open the front door. You should *always* use two trap dividers when coming through the top of the trap. Don’t become complacent and only use one, thinking you’ll save a little time. The occasional cat will be strong enough to bend an outer tong of the divider inwards and squeeze through the slight opening created or push the divider up towards you and crawl out underneath. This can’t happen if you insert two dividers from above, back to back.

If you do find yourself with only one divider available, then insert it horizontally through both sides of the trap instead of vertically from above (*Figure 11-3*). Make sure the divider has gone all the way through and is sticking out the opposite side. The bottom tong should be resting on the trap floor. Going through the side of the trap with one divider is also very secure, but can be more time-consuming, especially if you’re working with multiple traps lined up in a row without much space between them.



Figure 11-3

3. Insert fresh newspaper

While the cat is isolated on the rear end of the trap, open the front door, remove any dirty newspaper and line the bottom with fresh, thick newspaper. The newspaper makes the trap more comfortable for the cats and they will eliminate on it. Don't try putting in a small litter pan or you're liable to end up with a real, impossible-to-clean-up mess. Remember, these cats typically are not trained to use a litter pan and will often knock it over and get the litter all over the place. The newspaper works fine and some of the cats will even shred it to cover their waste. If you'd like, place a small towel inside the trap at the front door end. The cats do enjoy sitting on the towel, though it tends to quickly get dirty or soiled.



photo: Meredith Weiss

4. Secure the front door

Once you've finished cleaning the front half of the trap and putting in fresh newspaper, shut the front door and double-check that it's locked. Remove the dividers, then cover the front of the trap completely with the sheet.

5. Move the cat to the front end, section off and insert newspaper

Go to the rear end of the trap, pull back the sheet and move the cat to the front end, using the same approach as before. Towards the middle of the trap, insert two dividers from above, back to back. Once the cat is safely sectioned off, open the rear door and, if it's a type that lifts out completely, place it on top of the trap. Remove any dirty newspaper and replace it with fresh, thick newspaper.

6. Place food and water inside

Inside the trap and close to the rear door, place food and water. The food should be on a plastic or paper plate and water in a low container with a flat bottom, like a disposable snack container, which is available at grocery stores. Don't use empty cat food cans for holding the water – they have sharp edges which can cause cuts.

The best piece of equipment for holding water in a trap is a "coop cup." This stainless steel cup is made for holding food and water in bird cages and has hooks which will attach to the side of the trap. Be sure to buy coop cups with hooks and not ones that use a more complex mechanism for attaching. They can be found online at Amazon.com or purchased at pet supply stores which sell products for birds.

7. Secure the rear door

After you've placed clean newspaper, food and water inside, shut the rear door and check that it's securely locked by tugging up on it. Remove the dividers and cover the rear of the trap with the sheet. For ventilation, leave the front and rear doors partially uncovered.

When working with large numbers of cats, it can be helpful to proceed in an assembly-line manner. First, put newspaper on top of each trap. Then make your way down the row of traps, doing all the front ends first. Next, prepare all the food plates and water dishes and put one of each on top of each trap. Finally, do all the rear ends, placing food and water in as the last step for each trap. The reason the food and water should be put in as the last step and not the first is so the cat doesn't sit in it or knock it over while you're cleaning.

• What if a cat does escape?

If you follow the procedures outlined here, including always using two dividers and double-checking that the doors are locked after you close them, cats will not escape. But if for some reason there's a mishap and a cat does get out, the most important thing to remember is never try to grab a feral with your bare hands. The cat will be very frightened and will believe you're trying to harm him. He'll fight to break loose from your grip and, in a split second, can inflict an injury serious enough to send you to the emergency room for treatment. Don't try to throw a blanket over him and grab him. That's just as dangerous. What you will need to do is re-trap him.

Anticipate the possibility of an escape, even if it's highly unlikely, by shutting the door and blocking any other way out of the holding space when you first enter it. Obviously you can't do this if your holding space is outdoors or in a large, wide open interior like a warehouse, giving you all the more reason to be extra-careful when feeding and cleaning.

If an escaped cat cannot get out of the holding space, there are a few ways to re-trap him. One is the "lure into a closed space" method described in the "Hard-to-catch cats" section of Chapter 9. Your escapee will already be in a closed space, so no need to lure him in. The rest of the method, however, would apply. Briefly, you would eliminate places the cat could hide and get him to run behind a board or into a closet where a trap is set. Review the full procedure in Chapter 9.

If this method doesn't work or is impractical in the particular space, set and bait a trap or two, cover the sides of the trap with a sheet (but not the front and rear doors) and wait it out. It can take a few days before hunger drives the cat back in, though usually overnight will do the trick.

Worst case scenario would involve asking a veterinarian or veterinary technician to come and use a fast-acting sedative on the cat. This is possible only if the cat is holed up somewhere where he can be easily reached and has little room to move. It should only be attempted by a veterinary professional experienced in working with ferals.

12. The Feral Cat Setup: Long-term Fosters



The “Feral Cat Setup” is for confining a feral cat over an extended period, beyond the several days typically required for a TNR project. A cat may need to recuperate from a serious injury like a bite wound or broken limb or be treated for an illness that requires a course of antibiotics. Or you may need to hold a mom raising a litter of newborn kittens. The Feral Cat Setup is also useful when a feral cat is being adopted and introduced into someone’s home (see “Socialization techniques for feral teenagers & adults” in Chapter 16.)

Whether to use the Feral Cat Setup instead of a trap depends largely on how long the confinement will last. If the cat needs to be confined for more than two weeks, the Feral Cat Setup should be used. For less than two weeks, much depends on the particular cat’s disposition. If he remains calm and appears relaxed, a trap should work fine. If he starts acting restless and stressed after being in a trap for a few days, the Feral Cat Setup is a better choice.

One of the worst things you can do in a long-term foster situation is let a feral cat loose into a room or open space, even a bathroom. The cat will either go find a place to hide, often a spot you never knew existed, and stay there the entire time, or literally start climbing the walls trying to escape. You lose almost all control over the situation and when the time comes to transport the cat out of the room, it could be difficult and possibly dangerous to re-capture him. The Feral Cat Setup, with its den inside a cage, is a much safer way to go and will provide a more secure, comforting environment for the cat once he learns the cage is “his” space.

• Materials needed

- Cage, approximately 36" L x 21" W x 24" H
- Feral cat den
- Small litter pan
- Litter or shredded newspaper
- Broomstick handle (or similar long, narrow device which can reach through the bars of the cage to open and shut the side door of the feral cat den)
- Cotton sheet
- Newspaper
- Food and water dishes
- Small towel

Figure 12-1 shows the Setup fully assembled. The bottom of the cage is lined with newspaper. The den with a small towel inside sits in the rear corner to your left as you're facing the front of the cage. This leaves the round side door accessible from the side. Towards the front of the cage, the litter pan sits to the left and the food and water bowls are to the right. A sheet covers the back half of the cage at all times and can be pulled over the front half when you want to make the cat's environment as calm as possible.



Figure 12-1

For the litter pan, you can use a smaller one, measuring approximately 10 inches in width and 14 inches in length. Or a small plastic dish pan with similar dimensions will work. Using shredded newspaper instead of regular litter may help keep the cage cleaner.

● Placing the cat inside

Don't try to transfer a cat directly out of a trap and into a cage. This type of transfer carries a high risk of injury or escape because both the trap door and cage door have to be open at the same time. Because the door of the trap is much smaller than the door of the cage, a large gap above the trap is created. All the cat has to do is exit the trap, twist around, jump over the trap and take off. You won't be able to pull back the trap and shut the cage door fast enough to stop him. A much safer technique is to transfer the cat from the trap into the feral cat den, then put the den inside the cage. (See "Transfers from traps" in Chapter 9.)

If the cat will go directly into the Setup after a visit to the veterinarian or spay/neuter clinic, give the den (with a towel inside) to the staff and ask them to put the cat in while he's still sedated. That way, when you pick him up, he'll already be inside. Make sure



Figure 12-2: closed & locked

the side door is locked before you carry him home (Figure 12-2). It's difficult for a cat to open the side door even if it's unlocked, but things can shift and move around during transport and you want to be as safe as possible. If you're using an older model den without a side door lock, use a piece of duct tape to secure the side door. Also check that the front door is locked.

Once the cat has been transferred or is otherwise inside the den, place the den, still locked, into the Setup cage. Next, put in the litter

pan, food and water. When everything is in place, unlock the den's side door, **but do not open it** (Figure 12-3). Shut and secure the cage door, reach through the bars with a broomstick and then, pushing up from its lower left, lift the side door of the den into its open position (Figure 12-4). While it's possible with the Tomahawk feral cat den to lock the side door into an open position, do not attempt to do this. You need the side door unlocked so you can open and close it from outside the cage. The side door should stay open on its own anyway without being locked into that position.

Finally, cover the entire cage with the sheet to calm the cat. Once he's gotten used to his new space, you can pull back the sheet, but always leave at least the back half covered.



Figure 12-3: closed & unlocked



Figure 12-4: open & unlocked

• Feeding and cleaning

Once the cat is inside the Setup and the side door of the den is open, he's free to move about, eat, poop, scatter the litter, shred the newspaper, tip over the water dish, etc. Usually, your guest won't behave that badly, but you will need to regularly feed and do some housekeeping. **Before you open the cage door to get to work, the cat must be inside the den with the side door shut.** Normally, this is not a problem because most feral cats will spend almost all their time in the den and all you'll need to do is reach through the bars of the cage with the broomstick and tilt the side door closed. If the cat happens to be out when you want to get in the cage, she'll usually head straight back inside the den as soon as she sees you approaching.

If she starts to get comfortable outside the den and doesn't go back in when you approach, then you may have to coax her. Pulling back the sheet all the way and leaving the entire cage uncovered might do the trick. Other methods include making a loud noise, tapping the side of the cage, poking very gently with the broomstick or spritzing with a light spray of water. If these don't work and the cat just won't go in the den, wait and try again later. Under no circumstances should you open the cage door while the cat is out.

Once the cat is inside the den with the side door closed, you can safely open the cage door. The first thing you should do is lock the side door of the den. As mentioned, it's

unlikely the cat would be able to open the door, anyway, but locking it gives added security. Now you can go about cleaning the cage and putting in fresh food and water. You might find it easier to lift the den out of the cage first.

When you're finished straightening up and providing fresh food and water, put the den back inside, unlock the side door and close and lock the cage door. Then reach through the bars with the broomstick and raise the side door of the den to its open position.



photo: Glenda Sparnroft

13. Spay/Neuter & Veterinary Care

Getting the cats spayed and neutered is what the hard work of trapping is all about. When the big Spay Day arrives, you want to be as ready as possible. This means educating yourself ahead of time on your clinic's protocols, getting the cats ready and knowing what choices you will make for the cats' care.

- **Preparing for surgery**

- ***Withhold food & water***

For adult cats, all food should be removed from their traps by 10 p.m. the night before the surgery. It's important for a cat's stomach to be empty while under anesthesia. Otherwise, there is a chance the cat will vomit while unconscious and the regurgitated food could cause him to choke or gag, a potentially fatal complication. Water should be withheld, too, although veterinarians differ on when to withdraw it. To be conservative, remove the water at the same time you remove the food.

In order to maintain a healthy energy level, food and water should not be withheld from kittens for as long as adults. Exactly when food and water should be taken away depends in large part on their age. The younger they are, the closer in time to the surgery they should be fed. Consult your veterinarian for the precise timing, keeping in mind that whatever age the kittens are, there is some period before the surgery that food and water should be withdrawn.

- ***Traps and covers***

Feral cats should always be brought to the clinic in traps or transfer cages, one cat per trap or cage. When a cat is in a trap or transfer cage, veterinary staff can use a trap divider to pin the cat against one end and then sedate him through the bars with a long-needled syringe. In contrast, if the cat is in a carrier or even a feral cat den, staff may need to open the door and reach in to get at the cat. This can be very dangerous, exposing staff and the cat to injury. This is why many clinics now require that feral cats be brought in traps or transfer cages or they will not be treated.

Each trap should be covered with a sheet to keep the cat calm. Cotton sheets, like those used to cover the cat during the trapping, will do the trick. Write your name or your group's on the sheets with indelible ink if you want to be sure to get the same ones back.

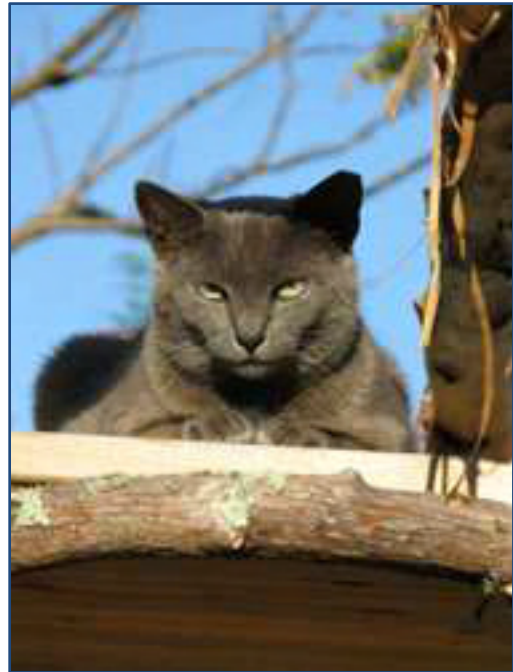

photo: Meredith Weiss

- ***Special instructions***

Any special instructions for the veterinary staff should be written on a label affixed to the top plate of the trap. Examples include the cat is limping and you want the left front leg examined, you'd like the teeth looked at, there's a wound that needs cleaning or you know the cat is pregnant. Any veterinary care you'd like beyond the clinic's standard treatment should be noted. Also find out ahead of time what, if any, extra charges will be involved.

It's especially important to write down in big bold letters if you do not want the cat eartipped because you plan to adopt him out rather than return him to his colony. Keep in mind, however, that many clinics require eartipping in order for you to qualify for a discount feral rate. Otherwise, normal rates apply. Check your clinic's policies beforehand. If eartipping is required for a lower rate, then pay the higher price for adoptables but still, if the cat is in a trap or transfer cage, make it very clear on the label that you don't want the cat tipped. If a mistake happens and a cat is accidentally tipped, don't be overly concerned – eartipped cats are no less adoptable in our experience.

In addition to writing special instructions on a label, also put them on the clinic's intake form. If there is no intake form, don't rely only on giving verbal instructions. Something you only say can easily be forgotten or misunderstood. Print or write your own simple intake form if necessary, listing your name, the cat's name and description, the date, and your instructions, then hand it to the clinic staff when you bring in the cat. That way there should be no confusion about what you're asking to have done.

- ***Educating the veterinary staff***

TNR and the veterinary services available for feral cats continue to grow at a rapid pace. Nonetheless, working with feral cats is something many veterinarians and clinics remain unfamiliar with. They are set up and trained to work with pet cats who are used to being handled, not semi-wild animals who have to be treated with much more caution. As an experienced caretaker and trapper, it's possible that at first you'll know more about the safe handling of ferals than your veterinarian or clinic. If that's the case, it's important for you to educate them. Bring your cats in traps, covered with sheets, even if the clinic does not tell you to do so and explain why to the staff. Also bring a pair of trap dividers and demonstrate how to section the cat off on one end and feed and clean in the trap. Many veterinarians new to ferals make the mistake of transferring them out of traps and into cages. Explain how this increases the risk of escape and injury and how much safer it is to keep the cats in their traps before and after surgery. If a cat does need to be caged at the clinic for some reason, bring a feral cat den and show how to use it, including transferring the cat into the den before placing him in a cage.

If your veterinarian or clinic is new to TNR, give them a photo of an eartipped cat and copy the part of this chapter which explains how to perform the procedure. Do this whenever you're working with a veterinarian who is relatively inexperienced with ferals, even if she says she knows what an "eartip" is. In veterinary school, students are taught to perform "ear notches," the V-shaped mark cut out of the side of the ear of livestock. This mark doesn't work well with ferals because from a distance, it can look like a fight wound, making it hard to tell if the cat is neutered. When first working with ferals, a

veterinarian may believe an ear notch is the same thing as an eartip. Even if they do know the difference, an inexperienced veterinarian may take too much or too little off the tip of the ear. Don't take chances when a simple photograph or drawing will prevent a mishap.

- ***Arrange for emergency post-surgery veterinary care***

With veterinarians experienced in spay/neuter, the incidence of post-surgical complications is very low. Still, it's best to plan what you would do in the rare event something does go wrong after the cat has been returned to your care. You want to make these plans before the cats are returned to you, not afterwards when you're in the middle of a crisis. First, see if your spay/neuter provider will be available at all times after the surgeries. If not, locate any 24 hour or other emergency care veterinary facilities in your area. You can also try to arrange for another veterinarian, even if he didn't perform the spay/neuter surgery, to be available in an emergency.

Two situations which could require post-surgical emergency care are pools of blood or prolonged unconsciousness. Drops of blood around the scrotum for males or the spay incision for females are normal, as is urine tinged with blood for the first day or two after the procedure. A pool of blood, even 1/8th of a cup, is not normal and requires immediate attention. Likewise, if a cat is not fully conscious a couple of hours after the surgery, this is cause for immediate action. Usually, a clinic will not return the cats to you until they are fully conscious, but sometimes it isn't possible for them to hold or observe them for that long. In particular, some mobile spay/neuter clinics – van or MASH-style - may need to return the cats to you earlier than is ideal.

- **Types of veterinary treatment**

The standard treatment for feral cats being returned to their colonies includes (1) spay/neuter, (2) eartipping and (3) rabies vaccination when required by law or when it's known rabies is present in the local environment. Some clinics may also include in their standard feral cat package an FVRCP vaccine, flea treatment, ear mite medication and/or worm medication. A few will also do dental work. Normally, however, these additional treatments are considered optional and will cost extra.

Parasite medication (fleas, ear mites and worms) is not usually part of the standard treatment because it's normal for a healthy cat living outdoors to have a certain, tolerable level of parasites present. If medication is applied, the parasites will return when it wears off. This makes investing limited funds in these treatments of questionable utility. If an infestation is severe, treatment should be sought and the extra cost incurred. In these extreme cases, the parasites could cause serious health issues, such as fleas causing anemia, worms causing weight loss or ear mites resulting in wounds from the cat scratching behind his ears. Be aware that when parasites rise to this level, it can be a sign of another underlying health issue such as a weakened immune system. Often, if efforts are made to upgrade the cat's shelter and nutrition, a recurrence of the infestation can be avoided.

The FVRCP vaccine, also known as the “three-in-one” shot or the “feline distemper” vaccine, protects against three diseases - panleukopenia (feline distemper), calici virus and rhinotracheitis. Distemper is the most feared of the three because of its swift and often deadly consequences, but the other two can be serious and even fatal as well. There are good reasons though for why FVRCP is not usually part of a standard treatment for ferals. First, there is the cost. With TNR, judgments must constantly be made on the best use of scarce resources. In our experience at Neighborhood Cats, it is the kittens who are most susceptible to distemper and other diseases because their immune systems are not fully developed. Healthy adults, when well fed and sheltered, are rarely at risk. We would rather invest in the cats’ ongoing care than more vaccines. Another concern for caretakers who are holistically minded is the stress to the cat’s immune system of receiving anesthesia, a rabies vaccine, three more vaccines contained in the FVRCP shot and possibly other medications, all at the same time. Finally, there is the question of how effective an FVRCP vaccine is without a booster. Manufacturer’s instructions say a follow-up shot is required in three to four weeks, but one research study found a single dose was still effective ten weeks later and could potentially confer years of immunity.¹

One possible compromise, followed by some TNR groups, is to only administer FVRCP to younger cats, those less than a year old. The cost is justified, according to this view, because these cats do not yet have fully developed immune systems and need the extra protection.

Other vaccines, such as feline leukemia, FIV, “five-in-one,” or “seven-in-one” shots, are rarely given to feral cats, largely due to concerns about costs. Efficacy is also a concern with some of the vaccines, like feline leukemia.

If dental services are available and affordable, it’s an excellent idea to have the cat’s teeth examined and treated at the time of the spay/neuter surgery. This might be the only opportunity to provide dental care which, by preventing gum disease and oral infections, could prolong the cat’s life by many years. Dental care may not be practical if the clinic is only set up for spay/neuter and it may not be affordable if you’re dealing with a large number of cats.

The spay/neuter surgery itself can be performed on kittens who are at least two months of age and two lbs. in weight, if your veterinarian is trained in early age spay/neuter. If your veterinarian is not trained, you’ll need to defer to her on how young a cat she’s willing to perform surgery upon. Experience and training are also key when dealing with a female who is pregnant. If your veterinarian is experienced with spay/neuter and comfortable doing so, a pregnant cat can be aborted up until just before giving birth. Lactating females or females in heat also can be safely spayed by a veterinarian familiar with working on these cases. In these situations, including early age spay/neuter, late-term pregnancies or in heat or lactating females, there are added risks, which is why we emphasize the need for your veterinarian to be trained or experienced in these types of procedures. Otherwise, it’s best to wait.

Testing feral cats for feline leukemia (FeLV) or feline immuno-deficiency virus (FIV) is not part of the standard veterinary protocol for feral cats. Whether to test used to be a much more controversial issue, but most TNR programs have decided against it as a standard procedure for every cat. Instead, testing is performed only when a cat is a

¹ Fischer, S., et.al, *Response of feral cats to vaccination at the time of neutering*, (2007) Journal of the American Veterinary Association Vol 230, No. 1.

candidate for adoption or is symptomatic and ill and the results would assist the veterinarian in diagnosis and treatment. The issue still comes up from time to time, especially when veterinarians or caretakers are new to TNR and are trying to decide on the best approach. Because of the importance of the question, a later section of this chapter discusses FIV and FeLV testing and why it is not part of the routine treatment for TNR.

• Eartipping



photo: Bryan Kortis

The universal sign of a neutered feral cat is a $\frac{1}{4}$ inch straight line cut off the tip of the left ear. In a few regions, like the West Coast of the United States, the right ear is tipped instead. Find out what the standard practice is in your area and follow it. It's important for everyone doing TNR in the same area to be consistent so shelters, animal control staff, caretakers and others working with ferals know what to look for.

Eartipping is performed when the cat is under anesthesia for the spay/neuter surgery. The procedure takes less than a couple of minutes and does not cause any lasting discomfort or pain. See the end of this section for a detailed protocol authored by Dr. Laura Gay Senk, DVM, a veterinarian experienced with working with feral cats.

Eartipping serves several important functions. It provides a way to quickly determine from a distance, without having to trap the cat, whether he is neutered. This allows colony caretakers to identify any cats missed during prior trappings or newcomers who need to be caught and fixed. During a trapping, if an already altered cat is captured, he can be released right away after a visual check of his ears. If a neutered colony cat ends up at a local shelter or in the custody of animal control, the tipped ear will let staff know the cat is part of a managed colony. Attempts can then be made to locate the caretaker or the cat can simply be returned to his original location. Eartipping in general lets animal control officers know a particular colony is being managed.

Sometimes caretakers new to working with feral cats initially take a negative view of eartipping, regarding it as a kind of mutilation. This attitude is understandable because eartipping is a new concept to caretakers just starting out and, ideally, feral cats would not need to have part of their ear removed. The problem is that a permanent mark identifying the cat as neutered is essential and there is no other better way to do it. Without such a mark, cats may be mistakenly recaptured and subjected to needless surgery. Shelters and animal control would have no way of knowing anyone was caring for a cat if he or she came into their facilities. Colony management could be very

difficult without the ability to tell quickly from a distance which cats were fixed and which were not.

Recognizing a permanent mark is necessary, some new caretakers look for a less invasive approach. Alternatives attempted have included ear-tagging, tattooing, photographs and relying on the caretaker's memory. All these methods suffer serious flaws and are inadequate substitutes for an eartip.

Ear-tagging involves insertion of a metal clip into the side of the ear. The method was designed for certain farm animals and is not suitable for free-roaming cats. The tags are small and hard to observe at a distance. They can get caught in thin branches or the like and cause the ear to tear and become infected. Despite their "permanent" design, sometimes the tags fall off and then no mark is left to identify the cat as neutered.



photo: Nancy SantoPietro

Tattooing the inner ear has also been tried. The problem is you can't see the tattoo from a distance. The cat has to be trapped and even then, sedation might be necessary before the inner ear can be examined. To be effective and prevent unnecessary trapping, a mark showing spay/neuter status must be visible while the cat is loose.

Photos which record neutered cats are impractical because they're only useful to whoever has a copy of them. If anyone besides the caretaker, like an animal control officer or another resident in the area, wants to know if the cats are fixed, there will be no way for them to tell. Even the caretaker in some colonies will not find photos that useful if many of the cats have similar appearances, like if most are black or tabby. Photos can also be lost or misplaced, leaving no record for future caretakers of the same colony.

Relying on the caretaker's memory is risky, even when the caretaker knows the cats extremely well. If the caretaker changes, there's no record at all. Also, as with photos, there's no visual cue for others.

In the end, eartipping is the most efficient and effective method for marking sterilized feral cats. If the procedure is done properly and care is taken not to remove more than 1/4 inch of the tip, the cat's appearance is not altered in a way that makes them look unattractive. Cats with eartips who are found to be friendly after the procedure is performed do not have trouble being placed in adoptive homes. Some owners even brag about their new pet's feral pedigree!

It's easier to see an eartip out in the field when you're looking at the cat from behind. Binoculars are very useful for this purpose.

- ***Detailed Protocol for Eartipping***
by Dr. Laura Gay Senk, DVM
<http://www.myvetonline.com/drsenk>



Procedure:

1. The ears are examined for ear mites, cleaned and treated (milbemite; milbemycin - novartis , acarexx; ivermectin - idexx, or 0.1 ml equalan; L.A. ivermectin injectable solution into each ear)
2. The tip of the left ear is given a sterile scrub after placing cotton at the entrance of the canal so that no excess prep solution runs down into the ear canal.
3. A straight hemostat is held across the top 1/4 inch of the left ear, applying gentle pressure. Do not clamp the hemostat closed or crushing tissue damage may result beneath the ear tip.
4. The top 1/4 inch of the left ear is cut off straight across the top using a straight edge sharp scissors (there is less bleeding when a pair of scissors, rather than a scalpel blade, is used). Proportionately less than 1/4 inch is removed for kittens. It is the straight edge on the top of the ear that is identifying, not the amount removed. Therefore, only 1/4 inch of ear tip need be removed.
5. A hemostatic paste (Kwik Stop) is prepared ahead of time with lidocaine and epinephrine. It's applied across the cut surface with a Q-tip. This will lessen the pain and resultant head shaking after recovery.
6. This paste will immediately stop the bleeding once the gentle pressure of the hemostat is removed. If bleeding does occur, apply more Kwik Stop and if needed, reapply pressure for a short time.

- **Post-surgery**

- ***Anesthetic withdrawal***

After their surgeries, most cats will remain at the clinic until they have fully regained consciousness. There may be times though when the cats are returned to your care prior to their full recovery from anesthesia. For example, a small mobile clinic may not have space to hold the cats after surgery and may give them to you to recover. If that happens, it's important to recognize the typical stages of anesthetic withdrawal so you can properly assess whether everything is going well.

In the first stage, the cat is unconscious. Everything is normal if the cat is breathing regularly, her gums are pink and not white, and her eyes are wide open and reflexively blink when tapped at the corner. Care must be taken to ensure the unconscious cat does not lie in a position, such as an awkward twisting of the neck, that would constrict her

windpipe and cut off her breathing. Because making sure she is lying in a good position may require handling the cat, it's always best if cats in the unconscious stage are not returned to the caretaker unless veterinary staff is present. Ideally, only an experienced veterinarian or veterinary technician would decide whether it is safe to touch a sedated feral cat. However, if veterinary staff is not present and you're concerned, first make extra sure the cat is actually unconscious and then gently straighten her out so she's lying on her side with her neck unbent.

In the second stage of withdrawal, depending on the type of anesthetic used, the cat may shake or twitch a fair amount, as though violently shivering or in a mild seizure. This is nothing to be alarmed about. Anesthesia causes the cat to lose control over the regulation of her body temperature, which drops. As the drugs wear off, the cat shivers to regain warmth. Because of this drop in body temperature, it's vital that a cat coming out of surgery be placed in a warm space for recovery (at least 65 degrees Fahrenheit). During the shivering stage and thereafter, the cat should be kept confined in her trap with all doors shut and locked.

In the third stage, the cat has regained consciousness, but not full control over bodily movements. The cat may struggle to move about and fall over or swoon, appearing in a drunken state. She may bang up against the sides of the trap, trying to get out. The trap should be covered with a sheet at this point to provide a sense of security.

Finally, upon full withdrawal from anesthesia, the cat will lie or sit quietly, appearing perhaps a little tired but otherwise alert.

If the cats are returned to you before they've reached the final stage, be sure to ask the veterinarian how long it should take before they get there. Generally speaking, if it takes more than a couple of hours for a cat to go from unconscious to sitting or lying on his belly, that is cause for concern and veterinary staff should be consulted.

- ***Food***

Adult cats can be fed three or four hours after full anesthetic withdrawal. If the cats are being transported from the clinic, wait until they've arrived at the holding space before feeding. Start out providing about half the size of a normal meal in case their stomachs are upset from the anesthesia. The next morning, full portions can be given. Water should be provided as soon as the cats are fully awake. Sometimes the cats' mouths become dry from the anesthesia and at first they'll drink more than usual. Kittens may need to eat sooner than three or four hours after becoming fully alert, depending on their age. Ask your veterinarian how long you should wait before feeding them.

- **FIV/FeLV testing**

The vast majority of TNR programs do not perform FIV/FeLV testing on every feral cat, but only for those showing serious illness or for those being offered for adoption. There are several good reasons for this policy:

1. With limited resources available, spay/neuter takes priority

One study found the prevalence of FIV (feline immunodeficiency virus) and FeLV (feline leukemia virus) in the unowned, free-roaming cat population – approximately 8% tested positive for one or the other virus² - is similar to that in the pet cat population. On average then, based on this study, testing 1000 feral cats will result in the identification of 80 cats testing positive for either FIV or FeLV. Even assuming a low cost of \$12 per test, that would mean spending \$12,000 to identify 80 cats with positive test results. That same \$12,000, at an average spay/neuter cost of \$50, could be put instead towards neutering 240 ferals. Because funds are limited and the primary goal of TNR is not disease control but to stem overpopulation, neutering 240 more cats should take priority over identifying 80 positive test results.

In addition, as explained in detail below, correct veterinary protocol requires retesting at a later date to confirm the initial diagnosis. Retesting isn't practical with feral cats and is rarely done. Instead, a feral cat's fate is determined on the basis of only one test, a questionable practice, especially if the cat is showing no signs of illness.

2. Spay/neuter can be a more effective means of disease prevention

Even if disease prevention is considered an important objective for a TNR program, investing in spay/neuter may have more benefits than trying to identify and cull positive cats. With respect to FIV, the primary mode of transmission is deep bite wounds. This type of injury is most often inflicted by male cats during fights provoked by mating behavior. Neutering males thus eliminates the most prevalent form of FIV transmission. With respect to FeLV, experience and research has shown that kittens are the greatest “at risk” population among feral cats,³ probably because their immature immune systems are not capable of fighting off infection. Spay/neuter, of course, prevents the birth of kittens and hence the spread of the virus. Spay/neuter eliminates sexual activity, another route of FeLV transmission.

3. The kinds of tests normally used on ferals are unreliable

The FIV/FeLV “test” is a misnomer. Each virus is actually tested for separately, although the tests may be combined into one kit. There are also different kinds of tests available for each virus. Depending on which virus is being tested for and which type of test is being used, the results may be unreliable.

- ***Feline Immunodeficiency Virus (FIV)***

When it comes to testing feral cats for the FIV virus, most veterinarians and clinics use the ELISA (Enzyme-Linked Immunosorbent Assay) test. Commonly referred to as a

² Lee IT, Levy JK, Gorman SP, Crawford PC, Slater MR, *Prevalence of feline leukemia virus infection and serum antibodies against feline immunodeficiency virus in unowned free-roaming cats* (2002) Journal of the American Veterinary Medical Association, Vol. 220:620-622.

³ Ibid.

“snap” test, it produces a result within minutes. It detects whether antibodies to the FIV virus are present in the blood, not whether the virus itself is present. As a result, a positive test result does not necessarily mean the cat is infected. For cats less than six months of age, FIV antibodies may have been passed on to them from their lactating mother, but not the virus. To confirm infection, these cats must be re-tested when they are older than six months. Another complication arises from the advent of the FIV vaccine. Cats who have received the vaccine will test positive for FIV because their immune system was stimulated by the vaccine to form antibodies, not because they are infected. A test that can discriminate between a positive result caused by the FIV virus and one caused by the FIV vaccine has been developed but is not currently available in the United States.

Even putting aside the problems of kittens with their mother’s antibodies and cats vaccinated against FIV, a positive ELISA test is not a definitive diagnosis. According to The Merck Veterinary Manual, “With ELISA tests, the incidence of false positives is relatively high. Positive results, especially in asymptomatic cats, should be confirmed by another test such as Western blot.”⁴ A Western blot or similar test must be performed in a laboratory and is usually considerably more expensive than the ELISA snap test. Because of the added time and expense involved, follow-up lab tests are rarely performed on feral cats.

- ***Feline Leukemia Virus (FeLV)***

For testing feline leukemia infection in ferals, the FeLV version of the ELISA snap test is also the most commonly administered. It detects whether FeLV antigen, a product of the virus, is present in the blood. A positive result indicates the cat was exposed to the virus, but does not necessarily mean he is permanently infected. He may have fought off the virus, leaving bits of antigen behind, or he might be in the process of fighting it off at the time of testing. Infection is not permanent until the virus enters the cat’s white blood cells where it can replicate and spread. The ELISA test does not indicate whether this has occurred. Only a second test, such as the IFA (Immunofluorescence Assay), can determine whether the virus has entered the white blood cells.

In addition, the ELISA test for FeLV is sensitive and prone to false positives from mishandling. A classic example is when the result is labeled a “weak positive.” There is no such thing. Either the antigen is present in the blood or it’s not. A “weak positive” finding almost always indicates some type of testing error.

Follow-up tests for FeLV, similar to FIV, must be performed in a laboratory and are rarely pursued in the context of TNR because it takes time to get results and they’re more expensive than the ELISA test. The failure to have an IFA or similar laboratory test performed prior to euthanizing a supposedly FeLV positive cat can literally be a fatal mistake. In an article published in 2006, the National Veterinary Laboratory – a privately owned diagnostic lab founded by the inventor of the IFA test – found that over the course of three years, 32% of FeLV positive results from ELISA tests submitted to it for review

⁴ The Merck Veterinary Manual, *Feline Immunodeficiency Virus*, (2012) www.merckvetmanual.com/mvm/index.jsp?cfile=htm/bc/150225.htm (click on “Feline Immunodeficiency Virus.”)

were not confirmed by subsequent IFA tests.⁵ In other words, almost one of three positive ELISA results turned out to be potentially mistaken. The frequency of false positives with FeLV ELISA tests is why The Merck Veterinary Manual states, “Confirmation of positive results, especially in asymptomatic cats, should be pursued by testing for cell-associated antigen, e.g., with an immunofluorescent antibody assay [IFA test].”⁶

To summarize, the common practice when feral cats are tested is to use the ELISA snap tests and then euthanize when results are positive for FIV or FeLV. This protocol is highly flawed because the ELISA tests are prone to false positives and, in accordance with best practices, require more precise follow-up laboratory tests to confirm a positive result, especially with asymptomatic cats. A TNR program that tests all cats and euthanizes based only on ELISA test results is not only incurring added expense, but may euthanize cats who are not infected.

4. FIV positive cats can lead relatively long lives

Cats infected with FIV have commonly been known to live for many years and some never get sick. While their immune systems are compromised, proper care and nutrition can compensate to at least some degree. Even in outdoor colony settings, FIV cats can live long lives. The caretaker does need to be alert for any symptoms of illness, which may require re-trapping and a visit to the veterinarian. By contrast, research shows that FeLV positive cats have a much higher mortality rate, 83% within 3.5 years of full-blown infection.⁷ Still, while they are alive, they can often live symptom-free until near the end if properly fed and sheltered.

5. Euthanizing positive cats is ineffective colony management

Advocates of testing all cats argue that positive ferals need to be identified so they can be removed from the colony and the remaining cats can be protected from the disease. In truth, removing the positive cat makes little difference. By the time you catch and identify the positive cat, it's most likely the other cats in the colony have already been exposed to the virus and will have become infected or not. Furthermore, no matter how many ferals are removed because of positive test results, FIV and FeLV will remain in the environment and be an ongoing threat. New cats passing through or entering the colony could carry the diseases and even colony members who test negative might be harboring one of the viruses. While false negatives occur less frequently than false positives with the ELISA tests, they are known to happen. Exposure may have occurred too soon before the test for antigen (FeLV) or antibodies (FIV) to appear in the blood. Or, in the case of FeLV, the virus might be absent from the blood but hiding in the bone marrow.

⁵ National Veterinary Laboratory Newsletter, *Current Feline Leukemia Virus Research Supports: Confirm All In-Hospital FeLV ELISA Positive Tests by IFA* (2006), Vol. 5, No. 4.

⁶ The Merck Veterinary Manual, *Feline Leukemia Virus* (2012), <http://www.merckvetmanual.com/mvm/index.jsp?cfile=htm/bc/150225.htm> (click on Feline Leukemia Virus.”)

⁷ Beatty, J., *Markers of Feline Leukaemia Virus Infection or Exposure in Cats from a Region of Low Seroprevalence* (2011) *Journal of Feline Medicine and Surgery* 13: 927.

In our experience, the primary cause of illness in ferals, including FIV and FeLV, has more to do with proper colony management than the presence of any virus. Colonies with lots of sick cats are invariably ones that receive poor or insufficient nutrition, have inadequate shelter from cold, rain, wind, snow, etc., and are unneutered and reproducing. These conditions lead to weakened immune systems and susceptibility to disease. The best way to prevent the spread of disease is not by testing and removing individual cats, but by improving the quality of food, making sure the cats have warm, dry shelter and getting them sterilized.

6. The life of a FIV or FeLV positive cat has value, too

At Neighborhood Cats, we euthanize cats only if they are actively ill, suffering and terminal. We believe all lives, including positive cats, have value. If a feral cat was to test FIV or FeLV positive, but showed no signs of illness, we would return him to his colony. As a result, there's no point in our testing as a matter of routine. We only test if the cat will be placed for adoption or is sick and the results are needed for diagnosis and treatment, including determining whether euthanasia is appropriate.

There have been a few instances when we knowingly returned FIV or FeLV positive but asymptomatic cats back to their colonies. These colonies were neutered and well managed. We have yet to observe other cats falling ill as a consequence. Cats who are known to be positive do need to be closely observed for signs of the terminal stage of the illness, such as weight loss, persistent upper respiratory infections, drooling or difficulty eating. Cats exhibiting any of these signs should be re-trapped and examined by a veterinarian.

If your veterinarian insists on testing, anyway....

Despite these reasons for not testing every cat, some veterinarians and clinics may insist upon testing as a condition for using their services or giving you a discount rate. If that's the case, then find out *before* you bring in any cats what their policy is for treating cats who do test positive. Most of the time, they will not follow up with a more definitive laboratory test and will euthanize the cat based on the ELISA results alone. If this is the policy, we recommend you do not work with that particular veterinarian or clinic if you have any other spay/neuter alternatives. As the caretaker of the colony, the one who watches over, worries about and feeds the cats on a daily basis, it is your right to decide their fate. The veterinarian or clinic is there to help you care for the cats, not make life-or-death decisions for you. Feral cats are not second-class animals and should receive the same consideration as a pet. No veterinary professional would presume to decide for the guardian of a pet cat that the animal should be euthanized, nor should they do so for one of your feral wards.

14. Recovery & Return

People often say TNR stands for “trap-neuter-release,” but the better and more accurate definition is “trap-neuter-*return*.” The cats are not simply being released randomly. They’re being returned back to their own territory – their home. The difference is important because TNR is not about letting cats go to fend for themselves or create new colonies. It’s about improving the lives of cats who are already out there and making them better neighbors.



photo: Bryan Kortis

- **Length of recovery period**

Cats should be given time after their surgeries to recuperate before returning them to their colony. Not only do the cats need time to recover, but also a period of observation is needed to ensure there are no post-surgical complications, such as excessive bleeding, lethargy or infection.

Among experienced TNR programs, the normal hold time varies from a minimum of 24 hours to a maximum of 72 hours. Anything less than 24 hours falls below any generally accepted standard of humane care.

At Neighborhood Cats, we recommend 48 hours for males and 48 to 72 hours for females, provided they are doing well. For a routine spay, 72 hours is preferred, if resources permit, because spay surgery is more invasive than a neuter and the additional time can ensure they’re making an optimal recovery. When a mid- to late-term abortion has been performed as part of the spay surgery, we recommend holding the cat four to five days. Follow these guidelines for recovery times unless a cat is visibly ill or is being treated for an injury. In those cases, seek appropriate veterinary care and continue to hold the cat until the condition is resolved.

On occasion, a cat will not eat for the first 24 hours after surgery. If this occurs, offer a few other tempting food choices such as Fancy Feast, cooked chicken or tuna. If the cat is still not eating after another day or so, but otherwise appears fully alert and asymptomatic, he may not be eating simply because of the stress of confinement and it could be better to let him go rather than continue to hold him. If the cat is symptomatic, consult a veterinarian prior to release.

Before releasing a spayed female, remove any newspaper from the floor of the trap and have someone lift the trap up in the air while you crouch down and look at the cat's belly from underneath. Use a flashlight if necessary and examine the site of the spay incision. A little redness is normal, but if you see oozing, bleeding, swelling or excessive redness (inflammation), consult a veterinarian before releasing the cat.

- **Lactating mother**

It's possible to learn for the first time during the spay surgery that a female cat is lactating and may have a litter of kittens out in her territory. In this situation, our policy at Neighborhood Cats is to hold the mom overnight and then release her the next morning if she's alert and appears well. We'll let her go sooner than we would otherwise because the kittens need their mother, who can still nurse them after being spayed. If you learn before the surgery that the cat is lactating, see "Nursing mothers" in the "Special cases" section of Chapter 9.

- **Location of release**

The cats should always be released in their original territory. After their release, some of the cats may stay out of sight for a few days or even as long as a week or two. But they will soon re-adjust to their normal routine and learn to trust you again in their own feral way.

If it's not possible to release cats in their original territory – because they would be in imminent danger, for example, the building they've been living in is scheduled to be demolished - a proper relocation process must be followed (see "Relocation" in Chapter 15). Ferals are extremely territorial and cannot be safely released otherwise. If a cat is let go somewhere new without a proper acclimation and confinement period, his instinct will be to run off and try to find his old territory. The cat could end up terrified in a place with no caretaker, no colony mates, no known food source and unknown dangers. Simply letting a feral cat loose at a new location without a relocation process amounts to abandonment, in our view, and should not be done.



photo: Linda Mazzurco

15. Relocation & Sanctuaries

- Relocation

- *When is relocation appropriate?*



photo: Doris Burtner

When a colony is unmanaged, a crisis situation will often evolve. The cats' unchecked reproduction and the typical nuisance behavior of unaltered cats can lead to intense hostility from local residents towards the cats and anyone associated with their care. Often when caring, but inexperienced people first encounter this kind of situation, their initial thought is to move the cats to a safer place. They don't understand how difficult it is to find a safer place, how arduous and uncertain the process of moving the cats can be, how important it is to the cats to be able to stay right where they are and how quickly the problems can be brought under control by spaying and neutering.

The cats in a feral colony cherish their territory. They know their home intimately with all its pitfalls, shortcuts and hidden passages.

Next to food, their surroundings are the factor most important to their survival. Their home – inhospitable as the back alley, empty lot or abandoned building may seem to us – is truly their castle and defines their very existence.

Because their territory and their bonds to one another are so important to the cats, relocation should be considered only when their location is under clear, imminent threat and all other alternatives have been considered and exhausted. Most problems can be solved through TNR. A community's initial hostility because of noise, odor and endless litters of kittens is ended by neutering; encroachment in a garden can be easily deterred with a motion-activated sprinkler; a property owner's complaint might be addressed by moving a feeding station further away.

Relocation is hard work with no guarantees of success. First, a suitable new site has to be found with a new caretaker. Then, to reduce the chance of the cats running away, they have to be taught their food source has changed and the only way to do this is to confine them in their new territory for two to three weeks. Otherwise, they're likely to go in search of their old stomping grounds. Even with a proper confinement and everything done by the book, some of the cats may still run away after they're released.

Another consideration is what will happen in the old territory if the cats are removed. If food and shelter are still available, sooner or later new cats will move in to take advantage of these resources and the cycle will begin again. Put simply, a vacuum

has been created and one set of cats has been traded for another set of cats who aren't spayed and neutered.

For these reasons, every possible avenue towards allowing the cats to stay should be thoroughly explored and relocation should be considered only as an absolute last resort. If the colony lives in an abandoned building that is about to be demolished, first try to find a nearby location where a new feeding station and shelters can be set up and train the cats to eat and sleep there. If a cat dies mysteriously and you're concerned about poisoning, make sure all the cats are fixed in order to reduce nuisance behavior and post a "Stop Poisoning" poster around the neighborhood (see *Appendix A*). If a caretaker passes away, try to locate a new one in the same area before seeking to move the cats. Remember that relocation bears its own risks and only when these are clearly outweighed by the risks of keeping the cats where they are should it be attempted.

- *Choosing a new site*

If you decide relocation is necessary after exploring all the alternatives, the first step is to find a new site. You don't have to duplicate the original territory – cats in a warehouse can be moved to a backyard or from an abandoned building to a barn, etc. What the new territory does need are: (1) a reliable new caretaker who will strictly follow the guidelines for relocation and fully accept responsibility for the cats' long-term care, (2) a structure of some sort (barn, shed, garage) that will provide shelter and protection from the elements during the confinement period, and (3) a location away from a construction site or heavy traffic.

Cats can be relocated into a territory where there is already a colony, but it makes the process harder for the new cats and should be avoided if possible. Also investigate other factors, including potential danger from predatory wildlife like coyotes, wolves or dogs, hostility from nearby neighbors or businesses, proximity to land designated for hunting or wildlife and any other potential environmental hazard or issue. It's likely you won't find the perfect site and will have to make some compromises, but it's always good to aim for the ideal.

Don't move the cats until you have personally inspected the new location – things are not always as you might imagine. Not all barns are idyllic, cozy places filled with soft, warm hay. A nice country home may sound perfect, but if it turns out the caretaker only goes up on weekends, that won't work because newly relocated cats need supervision and food and water on a daily basis for two to three weeks. So spend the extra time and effort to see the prospective new place and meet the caretaker in person *before* you bring the cats. Don't risk receiving an unpleasant surprise and having to make a terribly difficult decision on the spot after you've driven for hours with trapped and frightened cats in tow.

Along the same lines, *never* hand the cats over to anyone without inspecting the new site yourself. No matter how nice the new place may sound and how desperate you are to move the cats, you are placing them in great danger if you blindly trust that someone else will take care of everything for you. There are unscrupulous people who take advantage of others' concern for the cats and promise they will have a wonderful new life in their new home when nothing of the sort is true. Sometimes they charge a fee per cat, which they pocket, and then simply let the cat out the back door of wherever. Others will even kill the animals out of a pathological belief they are doing a good thing for them, whether

a fee is paid or not. The only way you can protect the cats from these evils is if you yourself inspect the new location and personally meet the new caretaker.

▪ ***Doing the relocation***

Whenever possible, relocate the entire colony together in order not to break up their strong bonds. If that's not feasible, then at the very least, relocate two members who you know are close together. A familiar and loved face in a strange new place can be comforting and an important factor in making the transition successful. Spay/neuter the cats before relocating them so they can get over the stress of the surgery before having to adjust to a new location, and nurse sick or injured cats back to health first.



photo: Meredith Weiss

The process is going to be a little stressful for everyone, so you want to keep it as smooth, fast and uneventful as possible. Trap the cats, get them sterilized if necessary and allow a few days for recovery. Also, be sure to tell the new caretaker-to-be the details of the cats' past routine. If they're used to eating a certain type of food, continue with it. Each change they have to make will add to their stress.

Before you transport the cats to the new site, have everything set up at your destination. The interior space where the cats will be confined should allow them, once released, to directly access the new territory on their own. It won't do much good if after the cats are confined in a basement for three weeks, they have to be carried upstairs to the backyard in their traps to be released. If they can't get there on their own from the basement, they won't learn the backyard is part of the same place.



Figure 15-1

In the space where the cats will be confined, set up large playpens or cages in a quiet area, preferably close to a spot where they can hide after they're eventually released. Typically, when they are released after the two to three week confinement period, they will be frightened and need somewhere close by to hide for a day or two while they adjust. So, for example, in a large barn, the cages could be placed near bales of hay. Or in a garage, cardboard boxes with small

openings for the cats could be set up near the cages. Cages or pens should always be used unless there is no way for the cats to escape from the confinement space and the new caretaker can come in and out of the space easily without cats darting past her. The playpens or cages should contain a feral cat den the cats can hide in, a litter box and food

and water bowls – see the Feral Cat Setup described in Chapter 12. If dens are too expensive and you must use carriers, be sure the cat is inside the carrier and the carrier door is barred shut before opening the cage door. To bar the door, slide a yardstick, broomstick or the like through both sides of the cage right in front of the carrier door (*Figure 15-1*).

The temperature ideally should be moderate, neither too hot nor too cold. In colder climates, avoid relocating to an unheated space during the severest months of winter – cats in cages can't move around much or huddle together, so the cold can pose a risk to their health. If you must do it during the cold season, place small insulated shelters inside the cages, such as Styrofoam coolers, that are stuffed with straw and cover the cages with blankets. If insulated shelters are used instead of feral cat dens or carriers, the caretaker must be very careful when opening the cage door and should wait until the cat is inside his shelter and shows no signs of coming out.

No matter what the weather, the cats may try to escape, especially during the first few days. Be certain the caretaker knows how to care for feral cats in cages and demonstrate the procedure live. The cats need fresh food and water twice a day and clean litter, so the cage door will be opened often, giving them lots of opportunities to make a run for it if they're not shut into their dens or carriers. In case of escape, have the caretaker set out food and water near the cage or playpen and, in a barn or similar setting where it's possible, sprinkle used litter and old feces around the area to create a familiar scent. Most likely an escaped cat inside a structure like a barn or stable will stay inside and hide rather than seek the outdoors, especially if sufficient food is available close by.

Encourage the caretaker to talk to the cats and try to bond with them. They need to adjust to a new voice or voices as well as everything else that's new. If the cats form a degree of trust and bond with the caretaker, the relocation process has a good chance of success. Keeping their feeding times on a schedule is helpful, as is feeding wet food during the period of confinement and for a few additional weeks after they're released. The wet food is consumed faster than the dry and helps habituate the cats to a new routine. Gradually, a few weeks after the release, the wet food can be replaced or supplemented with dry, if that's preferable. At all times, fresh water should be provided.

Three weeks of confinement is optimal to acclimate the cats to their new surroundings so they won't panic upon release. Keeping the cats confined for longer periods is not recommended. Once acclimation is accomplished, continued confinement is unnecessary as well as stressful and can cause the cat to want to flee the area.

Stay in touch with the new caretaker. You'll want to know how the cats are doing and be available to offer any help or advice based on your experience with them. If at any time the relocation space becomes unsafe or unsuitable for the cats, make sure the caretaker alerts you to the situation and knows you are willing to give support and assistance. Whenever possible, have a backup plan – another site where the cats may go, even temporarily – in case of unsolvable problems.

Remember to try to remove all evidence of feral life from the colony's old location, primarily any food sources. Even if construction or renovation in the area is imminent, it's possible for new cats to move into the vacuum created by the removal of the original cats. You don't want to go through this process all over again!

• Sanctuaries

Finding a good sanctuary to accept your cats is a difficult task. The problem is plain: there are millions of feral cats and only a handful of well-run, trustworthy sanctuaries. There is rarely space available in one for even a single feral cat, let alone an entire colony.

To place an animal in anything less than a stable, reputable sanctuary would be irresponsible. Unfortunately, poorly run “sanctuaries” are abundant. They may be run by people with good motivations, but usually lack sufficient staff, space or funds to sustain a resource-intensive, long-term commitment like a sanctuary. These places can and often do turn into hoarding situations where far too many animals are taken in, then neglected and subjected to horrible conditions. If you hear about a place which keeps taking in large numbers of feral cats, seemingly saying yes to anyone who asks, that’s a red flag indicating something is probably very wrong. There are also, sadly, a few groups and individuals who pretend to have sanctuaries and lie to people desperate to find a place for ferals. They take donations for the cats and then either have them put down or warehouse them in poor conditions.

Similar to relocation, the only way you can ensure your cats are going to a good place and not a horror show is to investigate the sanctuary yourself. As the person responsible for the lives of the cats, it’s up to you to exercise your own independent judgment.

Most importantly, you should personally visit the facility to make an on-site inspection, preferably before you bring the cats. If the place is well run, they’ll be happy to take you on a tour of the entire sanctuary. If they won’t let you past the front door, that’s another red flag. While you’re there, ask lots of questions – again, if a place is well run, the people in charge will be happy to tell you anything you want to know. If they resent your questions or give less than complete answers, take this as a strong sign it’s not going to be a good home for your cats.

To be a long-term, stable situation, a sanctuary must have a strong legal and financial foundation. Here’s what you need to find out about these conditions:

- 1) **Is the facility operating legally?** Is a license required by the town, county or state for running a shelter or sanctuary? If so, do they have one and is it current? Ask to see it and call the licensing authority to verify information you’re given. Also important is whether the property is zoned for sheltering large numbers of animals. If zoning is a problem or if a license is needed but missing, reject the place.
- 2) **What kind of right does the sanctuary have to the land?** Do they own or lease it? If it’s owned, is there an outstanding mortgage and if so, for how much? If it’s leased, how long is the term? Does the lease allow for a sanctuary? Again, don’t be afraid to ask to see the documentation. Cats can live to twenty years, and you need to know the sanctuary is going to be around for that long. If the lease runs out soon or the mortgage payments can’t be made and the place shuts down, what do the owners plan to do with the animals?
- 3) **Is the sanctuary in good standing with local authorities?** Call the local health department to see if there have been violations. The local animal control or law

enforcement agency will tell you if any complaints for cruelty or neglect have been filed. A call to the Better Business Bureau or Chamber of Commerce may be informative as well. Most states have some type of charity bureau that provides oversight for nonprofits. It's often part of the Attorney General's Office.

- 4) **How is the sanctuary funded?** It takes a great deal of money to run a good sanctuary, between mortgage or lease payments, staff, veterinary bills, property upkeep and food. This is why almost all well-run sanctuaries will require a substantial donation per cat from you. If they don't, this could be a red flag and you need to thoroughly investigate how they are funded. Preferably, the facility will be a nonprofit registered with the state and the IRS. If so, request a recent financial statement. You can always look up the organization, if it's a 501c3 nonprofit, on Guidestar (www.guidestar.org) to see their latest tax forms (form 990's). The 990 form will list the organization's revenue, expenses, assets and liabilities. If the sanctuary is not run by an IRS approved nonprofit, find out who pays the bills and how long have they been doing so. Remember it's much harder for someone to raise funds if they are not part of a nonprofit.

If you determine that on balance, the sanctuary is on sound legal and financial footing, you'll still need to inspect the actual physical facility. Pay close attention to your first impression. Does the place appear to be friendly and adequately staffed for the number of cats being housed? Is there literature describing the facility? Walk around the whole place – not just the part where the feral cats live – and see if the living conditions for the animals are clean and spacious as opposed to crowded and unsanitary. Are the facilities warm and dry? Are sick cats kept separated? How are new cats added – is there a transition period and separate enclosure within the larger space (as there should be) or do they just toss them right in (as they shouldn't)? A transition period of at least two weeks in a confined space is critical if the ferals will have access to outdoor grounds that are not enclosed.

Find out if the sanctuary staff is sensitive to the special needs of ferals and understands they're not just "scaredy-cats." Look to see that there are lots of places for the ferals to hide and all the cats have plenty of scratching posts, toys and comfortable napping places. Ask what kind of food is used and how often the cats are fed. Make sure the animals look bright-eyed and healthy. Other questions to ask include: How do they handle sick cats – are there veterinary services available on site? What is their euthanasia policy? Do they have a cap on the number of cats they'll take in? Do they have a relocation program for ferals where they will send a number of them to a barn or the like? If so, what are the guidelines and will your cats possibly be included?

Once you've inspected the grounds and gotten the answers to all your questions, you can now make a well-informed decision on whether this is going to be a responsible, healthy place where your cats will live safely and have a good chance of leading a happy life. If you're not satisfied, don't settle but keep looking for other alternatives. As the cats' sole guardian, you'll be at peace knowing you've done all you can to ensure their future well-being.

16. Adoptable Cats

Whenever possible, adoptable cats and kittens should be removed from a feral colony for placement in good homes. This helps reduce the free-roaming cat population and gives these particular cats their best chance at long, healthy lives free from the dangers of the streets.



photo: Ernest Brandt

A cat is “adoptable” if she has the qualities most people seek in a typical pet. This means she is healthy, can be picked up, enjoys being touched, has no significant behavioral issues and will readily adapt to a new home. It’s

important to understand an adoptable cat is not simply any cat who can adapt to living in a human home. Most cats, even those that are quite feral, can learn to live indoors, but if they spend much of their time hiding and do not want to be touched, the pool of potential homes is very small, effectively making the cat unadoptable.

There are three types of cats found in feral colonies who are or can easily become adoptable: (1) lost or abandoned pet cats who are still friendly to people, (2) young kittens who can be easily socialized, and (3) the rare case of a friendly adult feral. These are the kinds of colony cats you want to bring in if you’re able. However, if the resources don’t exist to allow you to do this, whether it’s because you have no room in your home to foster, the local shelter has no space or you can’t afford the veterinary bills, then getting the cats neutered and caring for them as best you can in their territory is still a compassionate choice.

• Determining if a cat is adoptable

▪ *Lost or abandoned pet cats*

There is no easy way to tell right away whether a cat you just trapped is feral or a former pet who will turn out to be friendly. One popular myth is that a cat is feral if she acts frantic and thrashes about wildly after being trapped, especially as you approach. It’s not true. Almost every cat, feral or not, will panic when they realize they are suddenly confined, have no way to escape and are at a stranger’s mercy. It’s only later, after they’ve had enough time to calm down, that you can begin to make a correct evaluation.

How long it takes for a former pet to become comfortable enough to show his true nature will vary from cat to cat. Some may reveal themselves almost immediately, while others may require days. In general, a cat who has not been living on his own for very

long will show signs of being socialized sooner than one who has been outdoors for a considerable period of time and reverted to a semi-feral state. Here are some tips on how to distinguish a former pet from a feral:

- **Eye contact** - A friendly cat may make eye contact with you in a way that's a clear effort to communicate and connect with you (*Figure 16-1*). A true feral, on the other hand, is more likely to avert his gaze or appear to be looking right through you if you do make eye contact (*Figure 16-2*).



Figure 16-1



Figure 16-2

- **Vocalizing** - Friendly cats, after they've calmed down from the shock of being trapped, are often more vocal, attempting to "talk" to you. Ferals are usually very quiet.
- **Posture** – Feral cats, when you approach their trap or cage, will back away and hunch up at the end opposite you. Tame former pets, once they become used to you, will tend to assume more relaxed positions, like sitting at the front of the cage or trap.
- **Reaction to touch** – Through the bars of the trap or cage, slowly move a long, thin object, like a ruler or back scratcher, towards the cat's face and see how she reacts. If she hisses and lashes out at the object, she would likely do the same if it was your hand. A former pet is less likely to feel threatened or react hostilely.
- **Play** – Former pets are more likely to play with you. Try playing with the cat through the bars of the trap or cage using a string, feather tied to a stick or similar toy. If he never engages with you after trying on a few occasions, but just stares or looks away, that would point towards the cat being feral.

These are all general guidelines and should be considered in combination when trying to evaluate a cat's temperament – there is no one litmus test. Keep in mind cats are individuals and will express themselves in unique ways.

You can also begin to evaluate whether a cat is a former pet before you start trapping by knowing the colony well and observing his behavior. Is the cat in question a recent arrival, indicating he may be abandoned or lost? Does he trust you soon after he's met you? There are friendly ferals who will rub up against your leg or allow you to pet them, but it usually takes a fair amount of time before they'll trust you enough to let this happen. Tame cats tend to be less wary than ferals and seek affection from people much sooner. Does the cat remain separate from the rest of the cats, indicating he may not belong to their clan? Again, no single factor is determinative, but taken together your observations can give you a good sense of whether the cat is a feral or former pet.

Veterinarians experienced with ferals often develop a good feel for distinguishing them from pets, so ask their opinion as well after they've had a chance to spend some time with the cat.

After you've made an honest and thorough evaluation over a reasonable period of time, if the cat is really not adoptable, it may be the kindest thing to return him to his colony. Keeping a feral or semi-feral cat in a cage with the vague hope that one day you'll find him a suitable home, despite the odds, may make you feel better because you know he's safe. But being physically safe and living the best life the cat can according to his own nature are not always compatible. Ferals don't belong in cages. In addition, the longer you keep him from his own environment, away from his colony mates and territory, the harder it will be for him to return.

If it turns out you do have a former pet on your hands, be prepared that at first the cat may act out a bit, especially if he has spent a lot of time already on his own outdoors. When cats are abandoned and must struggle to survive, it can be very traumatic for them. After they're trapped and placed in a safe location, they may feel and express a certain amount of post-traumatic stress, such as prolonged meowing, aggressive behavior or lethargic withdrawal. They need to be given the time and space to get past the trauma, a process which moves along much faster in cats than humans. How long this period lasts depends on the cat, but is usually no more than a few days. Only then can you begin to see the cat's true personality.

Before adopting out a tame cat, have the cat scanned for a microchip to see if he can be reunited with his former home. If the original owner cannot be located, take steps to ensure a new owner will have full legal rights to possession of the cat. Contact local authorities and find out what to do. In many places, you'll need to file a "found animal" report with your local animal control agency or shelter. If the original owner does not claim the cat within a certain amount of time (usually three to ten days), you can freely place the cat in the home of your choice.

▪ ***Feral kittens***

Age is the key factor in determining whether feral kittens can be quickly socialized and made adoptable. While there are occasional exceptions, kittens under eight weeks are usually easily socialized, often becoming tame within a few days of capture if they receive a great deal of attention and handling. Kittens under six weeks old may not be

feral at all yet and may tame immediately. Over eight weeks old, the amount of effort required for socialization and the uncertainty of the outcome rises significantly with each passing week. When the kitten reaches the twelve to sixteen week age range, it becomes increasingly likely she will bond only to the person who socializes her and hide and be wary of others, making her harder to adopt. Beyond sixteen weeks, most cats will remain feral at least to some degree, perhaps for the remainder of their lives.

See the section in this chapter below on “Socializing feral kittens” for how to tame the little ones. For instructions on raising orphan kittens less than five weeks old, so-called “bottle babies,” see the *Kitten Care Handbook* by Kitten Rescue (www.kittenrescue.org – click on “Cat Care”).



photo: Bryan Kortis

- ***Friendly adult ferals***

There are many feral cats who come to know and trust their caretaker and will show them affection, such as rubbing against their legs or even allowing themselves to be pet or picked up. It’s hard to know, however, whether the cat will behave the same way in a new home, especially if someone unfamiliar would be adopting her. A gregarious nature is certainly a hopeful sign, but most likely she would need to go through a transition period of confinement before her friendly outdoor ways resumed indoors (see the section on “Socializing feral teenagers & adults” later in this chapter).

Many caretakers have observed how cats, after they’ve been spay/neutered, start to take more of a liking towards people. One indication a sterilized cat may have become adoptable is if he starts acting friendly towards strangers or does not run away or stand out of arm’s reach when they approach. Bringing him indoors is probably a good idea at that point, if it’s possible, because it can be dangerous for a cat living outdoors to be too trusting of strangers.

- **Veterinary care for adoptable cats**

The standard veterinary care for a cat being placed as a pet in an indoor home differs from that of a feral who is going to be released. An adoptable cat should be thoroughly examined by a veterinarian and scanned for a microchip to identify a possible owner who is frantic to find her missing pet. If no owner is found, the cat should be tested for FIV and FeLV and treated as needed for fleas, worms, ear mites, upper respiratory infections, ringworm or any other conditions he may have before being introduced to a foster or permanent home, especially if there are other cats in the household. Even if the cat gets a clean bill of health, he should not have contact with other cats in the household right away. Ask the veterinarian how long the new cat should be isolated from the others and what other precautions you should take.

• Socializing feral kittens

Some feral kittens socialize the moment you pick them up and hold them in your hands. Most take a little more work. As always in dealing with feral cats, you must be mindful of your own safety. Their parents have taught them to fear humans so remember that before sticking your hand in the carrier to grab one. A six week old kitten's sharp teeth can injure you and, if frightened enough, he may bite. You have to let feral kittens get to know you a bit before you try to handle them. When they're a more used to you, then you can carefully try touching them, using the techniques described here. A good idea is to leave them alone and just talk to them for a day or two before attempting any physical contact.

When introducing them to your home or shelter, place feral kittens in a confined space, like a large playpen or your bathroom (making sure first to locate and block off any holes in the wall or other spots inaccessible to you where they could hide). At first, they need to be kept in a confined, controlled space so they'll be forced to deal with you when you want them to. Otherwise, if you just let them run loose in your home, they'll



photo: Bryan Kortis

run away whenever you approach and avoid interacting with you, defeating any attempt to socialize them.

For the first two days, leave a carrier in their space so they can go run into it and feel safe when you enter their space. Talk to them when they hide in there, but don't try to force them out. After a couple of days, if they're still running and hiding whenever you show up and won't come out, replace the carrier with a cardboard box open on top. That way they still feel somewhat protected, but can see you and begin to interact.

A major goal of the socialization process is to get the kittens comfortable with being held and touched. But before you try to touch them,

get them to start touching you. One way to do this is by playing with them. A popular toy called a Cat Dancer, which is a wire with a piece of cardboard at the end, or a long wand with a string and feather are perfect. Kittens love chasing these. Sit down and begin playing with them. Once they're engrossed in the chase, run the feather or Cat Dancer haphazardly over your feet or legs and get the kittens to run over and touch you while they're playing. They may romp on top of you right away or it may take a few days. Be patient if it does take time – they're learning to trust you and need to move at their own pace. Eventually, they'll learn you're safe to touch. All the while you're playing, talk to them constantly so they get used to your voice.

Once the kittens are at ease and used to touching your feet and legs, as demonstrated by their quickly wanting to play and showing no fear of your presence, reach down during the play and stroke them once or twice on the back, but no more. Don't let the touching interrupt the play. Gradually, increase the amount of touching, avoiding letting it get to the point where they act all disturbed.

When they're very comfortable with your petting them, which again can take a few days, you can start to pick them up. Once again, increase the contact slowly. At first, only lift them up slightly off the ground for a second or two. When they're ok with that, hold them a bit longer. Eventually, place them on your lap, but don't force them to stay there if they want to jump off. Continue increasing contact until



photo: Meredith Weiss

they're lying in your lap and purring as you stroke them. The length of this process – from physical contact during play to petting to holding at length – will depend on the temperament and age of the kitten. It's an excellent strategy, if you're able, to involve more than one person in the process so the kittens don't socialize only to yourself. Once others can hold them and they enjoy it, the socialization is complete.

Another technique besides play for teaching feral kittens to touch and be touched is bribing them with food. Start off putting some very smelly and tasty food, like tuna, on a plate and let them eat it undisturbed while you remain at a distance. Next time, place your hand a foot or so away. Let the kittens come and eat the tuna without moving your hand. Each time you put the food down, move your hand a little closer. After the kittens are eating with your hand only inches away, start putting the tuna on a plastic spoon, hold it out and let them lick it off. Once they're doing that, then sit on the floor and put the spoon on your knee (while wearing pants). After they've gotten comfortable eating while touching you, put the food on a plate in your lap. When they're fearlessly standing on your leg and eating off a plate in your lap, you can start touching them. Just as with the play method, start slowly with a brief stroke or two and gradually increase the amount of contact until you're able to hold and lift them.

If you have a litter of kittens who are especially wild, try working with them one-on-one instead of letting all the kittens out at once to play with each other. This way you'll grab each one's full attention as they play or eat tasty treats.

With a particularly fearful kitten who resists these methods, try wrapping him in a towel (to immobilize him), then put him in your lap and pet him on the head and over the towel. Start off doing this briefly and, over the course of several days, slowly increase the time period he's held. When he's comfortable and appears to enjoy the touching, then you can try doing it without the towel.

Another method for very wild kittens is to start them off in a smaller cage (like 36" L x 21" W x 24" H) instead of a larger space like a big play pen or bathroom. Put a litter box and a small, open cardboard box inside the cage and some toys. Once the kitten is used to his surroundings, which may take a day or two, use a back scratcher or a long, soft-haired paint brush to reach through the bars and touch him. He may hiss and react poorly at first, but eventually he'll realize it feels good and start to purr. At this point, you can try using your fingers through the bars, though be on the alert in case he tries to scratch you. Play with the kitten through the bars, too, with a Cat Dancer or similar toy

and give him lots of little treats – anything that gives him a positive association with you is good. Eventually, when trust has been built up, move the kitten into a confined space like the bathroom and start using the play and food techniques described earlier.

The more contact feral kittens have with you, the faster they will socialize. This is very important at the beginning of the socialization process when the kittens, especially the younger ones, may identify you as their surrogate parent. So play, feed and talk with them as often as you can. Interacting with them for short periods several times a day is better than being with them for one long period and then leaving them alone the rest of the time. As mentioned, it's helpful with feral kittens to have multiple people handle them. This way, you avoid the risk of having them only socialize to you and not become adoptable to others. This risk is higher with feral kittens older than eight weeks so it's especially important with that age group to have more than one person involved in the socialization process.

Even young kittens who quickly learn to become house cats will usually still retain some feral characteristics. They may be extra sensitive to changes in their environment or have more than the usual fear of leaving their territory, like going to the veterinarian. If you move and their territory changes, they may at first revert to feral behavior. It's best to anticipate these reactions and take steps to lessen the cat's stress. For example, if you move, don't let your former feral loose right away into the whole house, but start him off in one room and give him a nice quiet place to hide. When he's gotten used to things and acts comfortable in the confined space, then gradually introduce him to other rooms one at a time, until he's comfortable in your entire house.

For more ideas, see the step-by-step guide on taming feral kittens by the Feral Cat Coalition of San Diego, CA: www.feralcat.com/taming.html

• **Socializing feral teenagers & adults**

▪ *Should you try?*

Socializing a feral cat over sixteen weeks old can be a time-consuming, difficult task with uncertain results. The older the cat, past the age of sixteen weeks, the more likely he will socialize only to a certain degree and then only to the person taming him. This of course can make him difficult to adopt. If a potential adopter has a choice between an eight week old kitten who curls up in her lap purring the first time they meet or a four month old feral kitten who you know is a lovely creature but who hides when the adopter comes over or scrambles to get out of her grasp, you can see the problem.

Even if you decide you're up for the challenge, there are several other factors to consider before you attempt to socialize a feral teenager or adult.

The first question is what is your plan for placement of the cat? If you personally are going to adopt her and can accept she may or may not ever become a pet in the traditional sense – one you can pick up, hold, etc. – then bringing her indoors will likely work out just fine. On the other hand, if your goal is to totally tame the cat so someone as yet unknown will want to adopt her, that's much more difficult to achieve. If the cat does not

socialize enough, which is very likely, you may end up with another cat in your own household.

Before removing a cat from a colony, you also need to assess the colony's social structure. Feral cats have complex relationships with each other. Friendships may form and last a lifetime. There are also hierarchies with dominant and submissive cats. Removing a cat from the colony can upset this balance, plus you may be depriving the cat of her closest ties. It's important to try to get to know the colony well before making a decision.

Another factor is whether the colony is relatively safe or facing impending danger. Will their site be destroyed by new construction? Have there been incidents of violence towards the cats, even after they've been spay/neutered? There are almost always some risks present in an outdoor setting, so you need to be realistic about whether the situation warrants trying to re-home at least some of the cats. A secure situation might tend towards leaving well enough alone while the presence of undue danger would weigh in favor of introducing a feral to the indoor life or, perhaps even better, relocating him to someone's property to live in an outdoor cat enclosure or cat-proof fenced yard.

Finally, what about the cat himself? Is he old? Alone? Handicapped? Sometimes a feral cat does well in his territory for many years, but as he gets on in age, can't handle the rigors of living freely outdoors like he used to. A comfortable retirement in a secure enclosure or yard or in someone's warm home could be just what's needed.

If none of these factors point towards bringing in a feral, it may be best to allow the cat to remain in a setting that suits his nature and which he already considers his home.

▪ *Socialization techniques for feral teenagers & adults*

There are experts at socializing ferals sixteen weeks and older who will work with them intensively for however long it takes, even a year or more, in order to completely tame them and make them fully adoptable. These people tend to have years of experience, work in shelter settings and are extremely dedicated.

For the caretaker who does not have the same kind of time or expertise, the objective in socializing a feral, especially if she is well beyond four or five months old, is more limited. The goal usually is not to transform the cat into a traditional pet who can be picked up, stroked and enjoys being around most people. Instead, a more realistic aim is to teach her how to adjust and feel comfortable in a human home and not hide and be in fear for years to come. Beyond this, how far the cat progresses towards being a normal house cat will largely be up to her, not you or whoever takes her in. One day she may decide you're okay and come and sit next to you on the couch, letting you pet her. But this may take years, if ever. This uncertainty must be accepted at the outset or the experience can be a frustrating one - for you because the cat is not acting like you want and for the cat because she'll sense your frustration and not feel at ease. More than anything, socializing an adult feral means learning to appreciate and love her for who she is, and allowing her to develop as she chooses.

The key to a successful socialization is how the feral is introduced into her new home. All too often, people let the cat loose right away with the predictable result that she finds some obscure, unreachable place to hide, then only comes out late at night to eat. If not addressed, this pattern can go unchanged for years. The way to prevent this is to start the

cat off in a cage for a period of two to four weeks, using the Feral Cat Setup described in Chapter 12.

The Feral Cat Setup gives the cat a place where she feels safe, which is essential. In unfamiliar settings, feral cats prefer to be in a covered, enclosed space rather than a wide-open one. That's why if you just let them loose straight off, they'll go run under the bed or into the closet and stay there. By starting the cat off in a cage, you choose the hiding spot, not the cat. This gives you control over the situation and the socialization process, which includes establishing a regular feeding pattern and training the cat to use a litter box. It also gives the cat a sense of security because she'll soon learn she's safe when she's in the cage and, in her mind, protected from you by the bars. Keeping the back half of the cage covered at all times with a sheet will increase her sense of comfort.

The cage should be placed in a part of the home neither too isolated nor too busy. This gives the cat an opportunity to learn the new sights and sounds of a human home without becoming overwhelmed. Remember, she has never heard a phone ring or smelled dinner being prepared. By being in a well-situated cage, she'll also be able to watch you and learn your patterns – such as the fact that you won't attack her when you walk by. Learning all these little things are crucial to the socialization process and won't necessarily happen if you simply let the cat run and hide anywhere she wants.

You and any others in the household should talk to the cat often so she learns to know and trust your voices. This period in the cage also allows the feral to get to know and become comfortable with any other resident cats, who can interact with her through the bars of the cage after she's been treated by a veterinarian for any problems and cleared to be introduced to the rest of the cats.

The cat should be kept in the cage until she grows visibly comfortable in your presence, but no less than two weeks. The desired comfort level is evidenced by the cat no longer darting into the feral cat den whenever you walk into the room. Instead, she'll remain perched on top of the den or lying on the cage floor. She'll also, when you put food in the cage, come out to eat while you're still in the room rather than waiting until you're gone. A minimum of two weeks may seem like a long time to confine a cat in a cage, but considering this early process will shape the cat's relationship with you for years to come, it's well worth it.

Once the cat is comfortable in your presence, leave the door of the cage open one night before you go to sleep, but don't change anything else. Above all, don't try to coax or force the cat out of the cage. Just casually leave the door open and let her come and go as she pleases. Do this at night before you go to bed because she'll feel safer venturing out for the first time when it's quiet and dark. Introduce her gradually to the rest of the house, preferably one room at a time, waiting until she appears comfortable before giving her access to new parts of the household. If you discover the next day that she's out and about, do not take the cage away but leave it just as it's always been. This is her safe spot and often the cat will continue to use the cage for some time to sleep and for using the litter box. You should continue to feed in the cage as well.

If four weeks have passed since the cat was first confined in the cage and she is not acting at ease, open the door anyway as described. Past a month, the stress of confinement can take away from whatever progress towards socialization the cat has made. It's better at that point to let her out and gradually introduce her to the household, one room at a time.

When the cat no longer uses the cage as a refuge and can be easily fed elsewhere, the transition into your home is complete. That's not to say the cat is going to jump into your arms when you approach. Instead, for a while, she'll probably head the other way. She has to learn to adapt to the entire home which will take time and may cause her to temporarily regress a bit in her behavior. But many of her initial fears have been assuaged and the chances of her finding her own comfort zone and living without constant fear in your home are greatly increased.

Once the cat is able to be fed outside the cage, you can take down the Feral Cat Setup, if you choose. Some feral cat owners will keep the cage in place and continue to feed inside. This makes it easier to confine the cat when necessary, like when you need to get her into the den for a trip to the veterinarian or when a contractor is coming over to do some work in the house. Remember, she isn't a normal pet you can pick up and place in a carrier. If you do take the cage down, then anticipate in advance when you'll need to confine her. A week or two ahead of that date, set up the cage again with the den inside and start feeding her in there. That way you can get her into the cage and the den at the opportune time. If you're unable to do this, another technique is to start feeding her inside a trap a week before you need to confine her and then set the trap when the day arrives or the night before. Being trapped could be traumatic for the cat, so feeding her in a cage with a den inside is far preferable.

If you move to another house or apartment, you should repeat the socialization process with the Feral Cat Setup again, though it will likely be a much shorter period of time before the cat appears at ease and can be released.

• Finding good homes

▪ *Adoption procedures*

Finding a cat a *good* home, as opposed to just any home, takes work. Not everyone is mature or responsible enough to take on the life-long care of an animal companion. You will need to make judgments about who will give the cat a loving, secure home, and who may not. There are plenty of caring, responsible people out there. There are also people who get an animal on an impulse that won't last, give the animal away as a gift without asking if the recipient wants one, want the cat only to keep away mice or are unable to adequately care for themselves or the dependents they already have, let alone a new cat. It's also important to be aware there are people known as "bunchers" who gather animals, sometimes under the guise of adopting them, and then sell them to laboratories for purposes of experimentation.

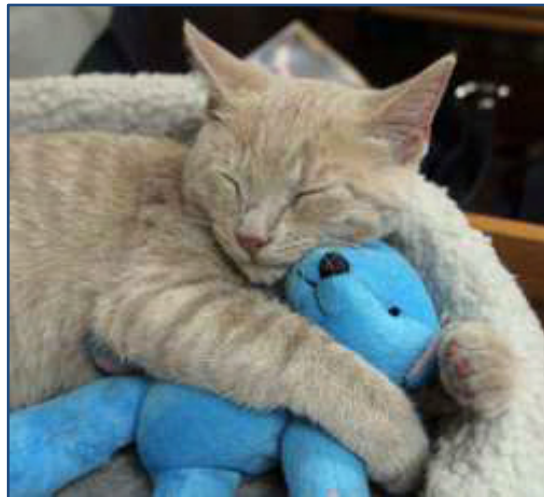

photo: Margie Rivera

In recent years, “open adoptions” have become a growing trend in the animal welfare field. This approach bases adoption decisions more on conversations with potential adopters and an assessment of individual needs rather than a standard set of criteria. Other new trends include “same day” adoptions where decisions are made by screening the adopter but without home visits or checking references. “No fee” adoptions, where adopters are screened but no adoption fee is charged, are also becoming more common. The primary rationale for these approaches, which are more flexible than traditional methods, is it’s more important to get the cats out of shelters where the risk of euthanasia is high than to find perfect homes.

While these approaches may have great value for the animal welfare field as a whole, in our view they are best implemented by shelters and experienced rescue groups who handle large volumes of cats and dogs. We do not believe they are appropriate for individual caretakers who may only ever adopt out a handful of cats or kittens and lack experience making the kind of judgments required with these more liberal approaches. Instead, in order to protect the cat, we recommend caretakers follow certain pre-determined procedures before doing adoptions on their own.

First, when someone expresses a serious interest in adopting a cat in your care, ask lots of questions and don’t be afraid to get personal. The right person will understand you’re trying to help the cat and appreciate it, not be put off. Here’s a checklist of questions you can use:

1. ***Is the cat for you or a gift for someone else?*** If a gift, this is not necessarily a bad thing, but you’ll want to speak directly to whoever would receive the cat, to make sure they want him and will provide a good home.
2. ***Do you have a cat now?*** If yes, ask about his/her health, age, personality and diet. Is the cat fixed? How the potential adopter treats his current cat is likely how he’ll treat yours. Also, is your foster cat a good fit? A rambunctious young male may not be a good companion for an older female used to being alone. Be sure to get a veterinary reference and call.
3. ***Have you had cats in the past?*** If so, how were they cared for and what happened to them? Again, get a veterinary reference and check on it. If the person does not have a cat now and never had one, ask about how they plan on caring for the cat – what kind of food they’ll use, have they lined up a veterinarian, what toys will be in the home? What research have they done on caring for cats?
4. ***What would you do if your cat scratches the furniture?*** This question is designed to see if a person would immediately think to declaw the cat. At Neighborhood Cats, we strongly oppose declawing. The procedure involves amputating bones and cutting ligaments and tendons, and can cause permanent physical and psychological damage. Often people don’t realize how extensive the surgery is, so if someone mentions declawing, explain the procedure and its risks and see how they react. Also explain

alternatives, like scratching posts and regularly clipping the nails. If they still seem inclined to declaw, keep looking or, if they otherwise appear okay, perhaps help them find a cat who is already declawed and needs a home.

5. ***What is your living situation?*** Own a house, apartment? Are you a renter? If so, how long is your lease? How long have you lived at your current location? Any plans to move?
6. ***Who else resides in your home?*** Are there roommates? Children? Is anyone allergic to cats? If there are roommates, who will have ultimate responsibility for the cat? Avoid shared ownership of the cat unless the adopters are in a long-term relationship. Otherwise, trouble inevitably looms down the road when roommates part ways. If there are other household members, you'll want to meet them.
7. ***What safety features will there be in the home?*** Are there screens on all the windows? Will the cats have access to an unscreened terrace or balcony? Many people don't realize cats lose their sense of height above a certain number of stories and may inadvertently jump out the window of a high-rise building. Will the cat be allowed on the fire escape? (Correct answer: No!)
8. ***Will the cat be allowed outside?*** Neighborhood Cats believes pet cats, for their protection, should live primarily indoors and always be confined with proper fencing or on a harness if outdoors. They should not be allowed to roam freely. See "Containment systems" in Chapter 4.
9. ***Are you prepared to care for the cat his entire life?*** Pets are a lifetime commitment. Cats can live to be 20 years old! Are you prepared to care for the cat for her lifetime? What if your situation changes (a baby, boyfriend/girlfriend, move, etc.)?
10. ***What is your employment situation?*** Occupation? How long?

You can also find good examples of adoption applications online which contain questions similar to these. One form we like can be found on the website of Tabby's Place, a respected cat organization in New Jersey (www.tabbysplace.org).

Remember there is no perfect home and so you're not going to hear perfect answers to all your questions. The goal is not to go down the list and check off requirements, but to get a sense of who the person is, how stable is their situation and how they will treat the cat. It's also an opportunity to educate the potential adopter. If you're satisfied with the answers, we recommend you follow these steps: get references (personal, job and/or veterinary) and check them; have the potential adopter come over and meet the cat if they haven't already; and if all goes well, pay a visit to the new potential home. For your safety, don't go to the home alone, but bring along a friend or co-worker. You can bring

the cat with you unless you feel that will put you under too much pressure, in which case go without the cat.

Having the person come see the cat gives you an opportunity to see how they interact and if there is potential for a lasting bond. Going to see the new home before finalizing the adoption lets you confirm that your evaluation of the person as a good placement is correct. There is little more revealing than a person's home. Is it pleasant and clean, are there screens on the windows like they said, etc.? If you go and get a bad feeling – things don't look right or were not as described - don't give them the cat, but say you need more time to think about it.



photo: Kathryn Walton

If you decide you've found a good home, have the adopter sign an adoption contract and pay a fee of at least \$50 to \$75 per cat. This will give you legal rights to reclaim the cat if, down the road, something goes wrong and a new placement is needed. You can readily find examples of adoption contracts online by doing a Google search (www.google.com) for "adoption contract for pets," "adoption contract for cats," or "pet adoption agreement." Borrow another group's form and adapt it for your purposes. Be sure the contract you use includes clauses which (a) require appropriate care for the cat (food, water, shelter), (b) give you the right to demand return of the cat in the event any material parts of the contract are breached, (c) prohibit declawing, (d) require your consent before ownership is transferred to anyone besides the original adopter, and (e) release you from liability for any injury or harm caused by the cat.

Charging a fee is important. It helps protect against someone who really wants to sell the cat by removing most or all of any potential profit. Also, owning a cat is an expense and an adopter should be able to afford a modest fee. If they can't, how will they pay the next veterinary bill?

After the adoption, follow up with a call a week later to see how things are going, then a month later, too. If all is well, your job is done. Be sure to let the adopter know you are available if they should ever need any help.

All this may seem like a long process, but most people who will provide a good home will appreciate your thoroughness and understand you're doing it because you deeply care for the cat. If someone objects and says you're making it too hard, that might be a sign they're not a good match for your purposes.

Whenever possible, especially with feral cats and kittens, try to place them in a home with another feline. Ferals are cats' cats. They usually get along with other cats extremely well, but can languish if left alone. If you have multiple kittens and want to adopt them out in pairs, which is always ideal for them, then ask right away before going into the other questions whether the potential adopter is willing to take two. Some people won't be willing or able, but in the end, if you stick to adopting the kittens in pairs, you'll only need to find half as many placements.

- *Where to look*

In order to attract a great home, post flyers in veterinarians' offices, pet supply stores, your gym and your workplace. Include a good color photo of the cat on the flyer – pictures make all the difference. The photo should clearly show the cat's face, be in focus, and be appealing. Talk to local rescue groups who show their cats in stores or at adoption events and see if you can borrow a cage for a weekend. You can post your cat on Craig's List (www.craigslist.com) as long as you'll only be charging a small adoption fee (sales of animals are not allowed). For Craig's List, after you select your location, the best place to list your ad is under "Pets" in the "Community" section.

The largest online adoption service is Petfinder (www.petfinder.com). Only animal welfare groups registered with Petfinder can post, so you'll want to team up with a shelter, TNR or rescue group in your area and ask if they'll post your kitty on their page. Or help them get a page if they don't already have one. Also check out Adopt-a-Pet.com (www.adoptapet.com), another resource where shelters and rescue groups can post available pets.



photo: Denise Szalaiko

17. Storm Preparation & Recovery

Feral and stray cats are especially vulnerable when severe storms like hurricanes or blizzards strike. High winds, torrential rains, floods or other hazardous conditions can put your cats' lives at risk. To reduce the dangers, you'll need to prepare beforehand and then also take action immediately after the storm has passed.

- **Before the storm**

Well before any bad weather arrives, the first step is to catalogue your cats. Compile a list, including descriptions and photos, even if you're already very familiar with the colony. After the storm, this could help determine if any cats are missing and, if there are, assist in preparing alerts or flyers to help find them.

At the colony site, what can be most important is protecting the cats' shelter so they can safely ride out the storm. If the shelters and feeding station are located in a low-lying area prone to flooding, relocate them to higher ground within the cats' territory, if at all possible. Also raise both shelters and feeding stations off the ground, whether you relocate them or not. Wooden shipping pallets are ideal for this purpose. Cinder blocks will work as well. Raise them high enough to prevent ground water or snow from reaching up to the doorways.



photo: Marialuz Menacho
(Staten Island, NY, after Hurricane Sandy)

If the cats are sheltered and fed inside a permanent structure, like a shed or garage, make sure there are secure, elevated places inside the structure where they can climb and perch, like shelves or heavy furniture. In case of extreme flooding inside the structure or any other emergency condition that might develop, leave the cats a way to get outside besides their normal ground-level entryway, like a slightly open window.

High winds present another potential hazard. Tie shelters and feeding stations to permanent structures, like a fence, to anchor them or else wedge them tightly into a secure place. Feral cat shelters are often light and need to be weighed down. But in high winds, heavy objects can be dislodged and create a danger, so be careful about placing anything on top of the shelters. Tying the shelters and feeding stations down is safer. Likewise, check the general area for loose objects which could become airborne and remove them.

To keep rain or snow from driving in, position shelters so their doorways are facing a wall or similar solid structure and not open space. One idea, if not already implemented, is to face the entrances of two shelters towards one another, no more than a foot apart. Flaps over the doorways, if the cats are already used to them, will also keep precipitation out (see "Doorway flaps" in Chapter 6).

In case you're unable to return to the colony site right away, put out an extra supply of dry food – enough to last a few days - before the storm arrives and leave a plentiful supply of water. Gravity feeders and automatic waterers are perfect for ensuring an adequate supply of food and water (see “Automatic feeders and waterers” in Chapter 5). Be sure the feeding station is protected in the same manner as the shelters – raised off the ground with the doorway shielded and located in close proximity to the shelters. Also, fill plastic containers or bowls with dry food and put them inside the shelters, placing them in the back inner corners as far as possible from the door. This will make the food accessible to the cats during the storm. However, do not put any water inside the shelter – it would likely spill and create a health risk for the cats by getting them wet or making the interior of the shelter damp.

• The aftermath



photo: Marialuz Menacho
(Staten Island, NY, after Hurricane Sandy)

When you arrive at the colony site after a severe weather event, the first thing to take care of is yourself. Strong winds and heavy snow or rain can cause overhanging branches to weaken and fall for several days after the storm. Other debris overhead can also pose a danger. Downed power lines can turn puddles into electrical hazards. So be aware and cautious as you move about.

Be on the lookout for broken glass, nails or other sharp objects and remove them promptly. Any broken lumber should also be promptly removed.

Scratches from pieces of treated lumber will become infected rapidly. Any wet items inside the cats' shelters should be discarded or cleaned. That includes bedding, straw or newspaper. When moist, these items offer no protection and will build up bacteria which could be harmful to the cats. Thoroughly bleach shelters, feeding stations and dishes if they were exposed to flood waters, which may contain toxins from sewage or other sources of contamination. For the same reason, after a flood, remove as much standing water from the colony site as possible and provide clean water to drink, putting out extra water bowls.

If any cats are missing, be aware they may be close by, but too frightened to return to the site. Also look high – cats may have climbed to escape flood waters and may still be up in trees or on rooftops. You can coax missing cats back by re-establishing a normal environment and regular feeding routine. Give them their favorite foods to comfort them, like tuna or grilled chicken, something tempting to make them feel better and lure frightened cats back. Add treats to their meals, continuing for several days after all the cats are accounted for. If possible, stop by twice a day to offer reassurance and keep calling for any missing cats. Most will come back within a week, but some stragglers may take a few weeks to return.

Check the cats for any injuries. Contaminated flood waters can infect wounds so if injuries are seen, trap and seek veterinary care immediately. The stress of the events can cause an outbreak of upper respiratory infections. To ward off illness, add extra Vitamin C to the cats' food (see "Vitamin C to the Rescue" in Chapter 5.) If you do see evidence of upper respiratory infections, consult a veterinarian about getting antibiotics into their food before their conditions worsen. Remember, getting the colony's routine back to normal as soon as possible is the best way to combat stress.

If your colony is located in an area that is closed off because of storm damage, contact your local police precinct and speak to the officer in charge of Community Affairs. Explain why you need to gain access and find out what you need to do to get permission to go in.

For more information on disaster preparedness for you and the animals in your care, see the extensive list of resource links on the website of Hoosier Kitties (www.hoosierkitties.com/care/disaster.htm).



photo: Marialuz Menacho
(Staten Island, NY, after Hurricane Sandy)

18. Feral Cat Resources

Books

- ***Implementing a Community Trap-Neuter-Return Program*** by Bryan Kortis (The Humane Society of the United States, 2007).
Part 1: www.humanesociety.org/assets/pdfs/pets/implementing_community_tnr_pt1.pdf
Part 2: www.humanesociety.org/assets/pdfs/pets/implementing_community_tnr_pt2.pdf
(Note: Available for free download. 2nd edition due out by end of 2013)
- ***Shelter Medicine for Veterinarians & Staff, 2nd edition; Chapter 41: "Management of Stray and Feral Community Cats"*** by Julie K. Levy & Christine L. Wilford (Wiley-Blackwell Publishers, 2013).
www.wiley.com/WileyCDA/WileyTitle/productCd-EHEP002626.html
- ***Community Approaches to Feral Cats: Problems, Alternatives and Recommendations*** by Margaret R. Slater (Humane Society Press, 2002).
http://marketplace.animalsheltering.org/product/community_approached_to_feral_cats/for_the_animal_care_community
- ***Maverick Cats: Encounters with Feral Cats*** by Ellen Perry Berkeley (The New England Press, 2001).
www.amazon.com (search for title)
- ***The Wild Life of the Domestic Cat*** by Roger Tabor (Arrow Books, 1987) /
www.amazon.com (search for title)
- ***Shadow Cats: Tales from New York City's Animal Underground*** by Janet Jensen (Adams Media Corp., 2002) / www.amazon.com (search for title)

Children's books

- ***Fairminded Fran and the Three Small Black Community Cats*** by Linda Elder (Foundation for Critical Thinking, 2012).
www.criticalthinking.org/store/products/fairminded-fran-and-the-three-small-black-community-cats/454
- ***Cat, Cat, Feral Cat*** by Clarissa Wolf (Avid Readers Publishing Group, 2009)
www.amazon.com (search for title)

Equipment & supplies

- *Arbico Organics* (www.arbico-organics.com) Beneficial nematodes for organic flea control
- *Cats-On-Line.com* (www.cats-on-line.com) / Modular cat cages and containment systems
- *Contech* (www.contech-inc.com) / “Scarecrow” motion-activated sprinklers & “CatStop” ultrasonic devices
- *Doctors Foster and Smith* (www.drsfostersmith.com) / Pet supplies
- *Entirely Pets* (www.entirelypets.com) / Pet supplies
- *Feralvilla* (www.feralvilla.com) / Outdoor shelters and feeders
- *Gamma2* (www.gamma2.net) / Vittles Vault food storage units
- *Happy Bird Corporation* (www.solarsippers.com) / Solar-powered, freeze-resistant water bowls
- *Jeffers* (www.jefferspet.com) / Pet supplies
- *KV Supply* (www.kvsupply.com) / Pet supplies
- *PurrFect Fence* (www.PurrfectFence.com) / Free-standing cat containment system
- *Tomahawk Live Trap* (www.livetraps.com) / Feral cat traps and accessories
- *Tru-Catch* (www.trucatchtraps.com) / Feral cat traps and accessories

Feral cat organizations – lists

The Humane Society of the United States

www.humanesociety.org/assets/maps/feral-cats.html

Castaway Critters

www.castawaycritters.org/info/display?PageID=158

Funding for TNR

- *ASPCA (American Society for the Prevention of Cruelty to Animals)*
www.aspcapro.org/grants-for-animal-shelter-animal-control.php
- *Best Friends Animal Society* (Life Saving Grants)
<http://nmhpnetwork.bestfriends.org/apply/LifesavingGrants.aspx>
- *Local Independent Charities of America (LIC)* represents non-profits in communities across the country. Visit their site to see if your organization is eligible to receive donations through LIC’s extensive giving network.
www.lic.org/

- **Petco Foundation** (4Rs Project Support Grant Program)
www.petco.com/petco_Page_PC_petcofoundationhome.aspx
- **PetSmart Charities** (Free-Roaming Cat Spay/Neuter Grants)
www.petsmartcharities.org
(Note: before applying, view the webinar *PetSmart Charities' High Impact Spay/Neuter Grants: What are We Looking For?* Link to webinar available at:
www.petsmartcharities.org/grants/types/free-roaming-cat-neuter-program.html)
- **The Foundation Center** is the leading source of information about U.S. and global philanthropy. Access their vast grantmaker database online or through their network of regional library/learning centers and funding information centers.
<http://foundationcenter.org>

For a list of the top 50 animal-grantmaking foundations compiled by The Foundation Center (*the list does not include 501c3 organizations, such as PetSmart Charities or ASPCA*):

www.animalsheltering.org/resources/sample/the-foundation-center-top-50-us-foundations-awarding-grants.html

Handouts & flyers

Neighborhood Cats

[Basic Flyer - English](#) (doc)

[Basic Flyer - Spanish](#) (doc)

Or go to: www.neighborhoodcats.org/RESOURCES_ADVOCACY_MATERIALS
(scroll down to “Flyers”)

Koret Shelter Health Portal

This resource from the Koret Shelter Medicine Program at UC Davis School of Veterinary Medicine provides information sheets on a variety of animal-related topics. For feral cat info enter keywords “feral” or “TNR” in the search field.

www.sheltermedicine.com/shelter-health-portal/information-sheets

PetSmart Charities

[TNR Infograph – English](#) (pdf)

[TNR Infograph - Spanish](#) (pdf)

Or go to: www.neighborhoodcats.org/RESOURCES_ADVOCACY_MATERIALS
(scroll down to “Flyers”)

Kitten care

- ***Behavior Department: Kitty in Their Hands*** by Nancy Peterson, Animal Sheltering Magazine (The Humane Society of the United States)
http://www.animalsheltering.org/resources/magazine/jul_aug_2011/kitty_in_their_hands.html
- ***Guide for Determining Kitten Age*** by Petfinder
<http://members.petfinder.org/~PA16/kittenage.html>
- ***Kitten Care Handbook*** by Kitten Rescue
www.kittenrescue.org/pages.php?pageid=15
- ***Taming Feral Kittens*** by Feral Cat Coalition
www.feralcat.com/taming.html

Spay/neuter resources

Map of Feral Cat Groups in the U.S. and Canada from The Humane Society of the United States

www.humanesociety.org/assets/maps/feral-cats.html

Neuter/Spay Nationwide - spay/neuter assistance and information.

<http://neuterspaynationwide.blogspot.com/>

Spay/Neuter Program Locator from PetSmart Charities and ASPCA

www.aspca.org/spay

www.petsmartcharities.org/spay-neuter/locator/

Spay/Neuter Program Locator from North Shore Animal League America's Spay USA

www.spayusa.org/search.php

TNR ordinances

Neighborhood Cats (list of ordinances in U.S. by state & municipality, articles on TNR ordinances and model TNR ordinances)

www.neighborhoodcats.org/resources_ordinances

Toolkits

- **Action Kit: Advocating for TNR in Your Community** from Best Friends Animal Society

Contains resources to help you implement a TNR program in your area. The Action Kit includes *What to Do Before Approaching Your Local Government About TNR* (Word doc, 6 pp.), *Frequently Asked Questions About TNR* (Word doc, 7 pp.) and *Community Cats and Trap/Neuter/Return: A Presentation to Local Government Officials About TNR* (PowerPoint, 4 MB)

www.bestfriends.org/Resources/No-Kill-Resources/Cat-initiatives/Helping-Community-Cats/Action-Kit--Advocating-for-TNR-in-Your-Community/

- **Pets for Life** from The Humane Society of the United States & PetSmart Charities

Designed to help organizations develop and implement a community outreach program for promoting spay/neuter in underserved areas.

www.animalsheltering.org/how-we-help/work-for-change/pets-for-life/pets-for-life-toolkit.html

www.petsmartcharities.org/resources/pets-for-life-toolkit.html

Videos

- **How to Perform a Mass Trapping (32 min.)** by Neighborhood Cats
To view online: vimeo.com/43420504#
To order DVD copy: info@neighborhoodcats.org
- **Trap-Neuter-Return: Fixing Feral Cat Overpopulation (16 min.)** by The Humane Society
To view online: www.youtube.com/watch?v=fTCTuJRkvng
- **San Antonio Community Cat Program (5 min.)** by Best Friends Animal Society
To view online: www.youtube.com/watch?v=Z2Km0IqwZnQ&feature=youtu.be

Webinars

Note: Information archived by the sources below may be updated periodically. Click on the links to search for currently available feral cat webinars

- **ASPCApro.org** / www.aspcapro.org (click on “Webinars on menu bar)
- **CatChannel.com** / www.catchannel.com/webinar/trap-neuter-return.aspx
- **PetSmart Charities** / www.petsmartcharities.org

**POISONING CATS
IN NEW YORK STATE IS A FELONY**

**\$2500
REWARD**

**For information leading to the arrest
and conviction of the person or
persons responsible for the
POISONING OF CATS
in this neighborhood.**

***Punishment for this crime is up to
two years in prison and/or a \$5000 fine***

**To file a report:
Humane Law Enforcement Division of the ASPCA
(212) 876-7700 x4450**

**To claim reward:
Neighborhood Cats, Inc.
(212) 662-5761**

HOW TO BUILD THE NEIGHBORHOOD CATS WINTER SHELTER

Materials

- hard Styrofoam sheet, 2 ft. wide, 8 ft. long, 2 in. thick
- one tube that fits a caulk gun of paintable or clear silicone sealant (such as GE Window & Door Sealant) *or* two smaller hand-squeezable tubes of paintable or clear silicone sealant. Paintable sealant is preferred.
- vinyl remnant (18" x 20") *or* three 1 ft. square pieces of thin linoleum tile with adhesive backing
- Latex deck paint (approx. 1 quart)

Tools

- table saw
- utility knife (with extendable blade) or jigsaw
- caulk gun
- painting equipment: brush/roller, paint tray, ground cloth
- felt tip marker
- yardstick
- scissors (if you're using the thin linoleum tiles)

Instructions

1. Using a table saw, cut the Styrofoam sheet into the following pieces:

- two of 24" x 24" (pieces A & B)
- two of 12" x 24" (pieces C & D)
- two of 12" x 20" (pieces E & F)
- four of 4" x 6" (pieces G1, G2, G3 & G4)

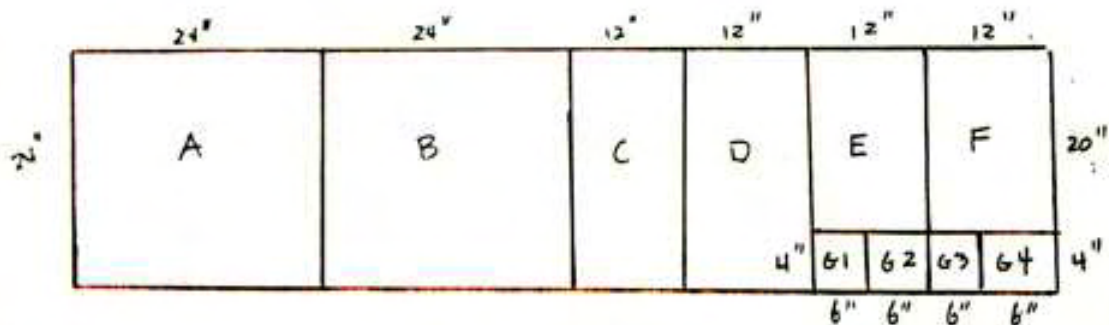

2. Cut out the front door of the shelter from piece E (12" x 20"). Using the yardstick and felt pen, draw a rectangle measuring 5 1/2" high and 6" wide, located 2" from the left vertical edge of piece E and 2" from the horizontal bottom edge. Use the utility knife (or preferably a jig saw) to cut out the rectangle.

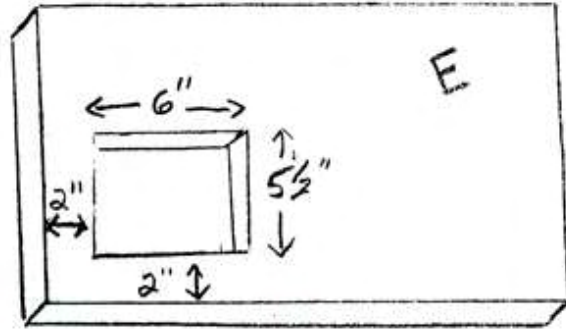

3. Line up the long sides of the shelter on the shelter floor by placing pieces C & D (the two 12" x 24" pieces) on the right and left outer edges of piece A (24" x 24").

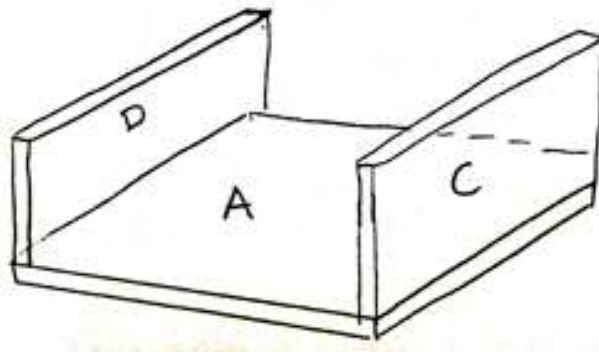

4. Place piece F (12" x 20") onto the back edge of piece A.

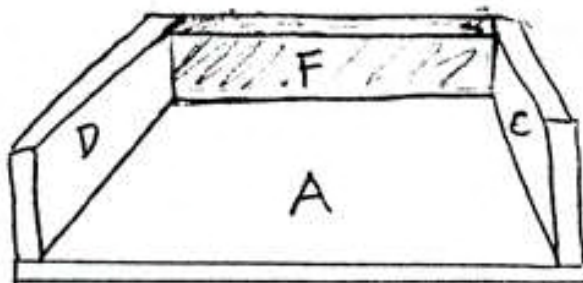

- Place piece E **two inches back** from the front edge of piece A, making sure the door is in the correct position:

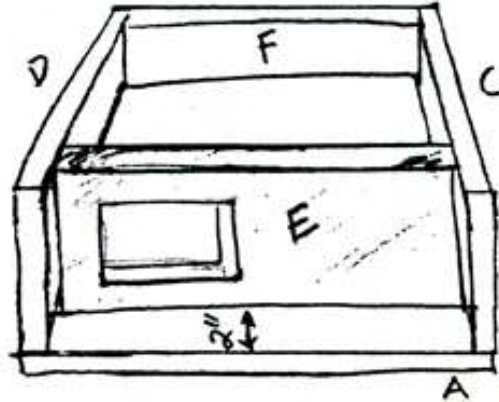

- Once all four sides are lined up, apply the silicone sealant to the bottom of pieces C, D, E & F, one at a time, and put each piece back in place, gluing them to the floor. Let the sealant dry for a few minutes.
- Take the 18" x 20" piece of vinyl remnant and attach it to the floor of the shelter with a small amount of the silicone sealant *or* use the three linoleum tiles with adhesive backing.

If you use the tiles, you'll need to cut up two of them to create a total surface measuring 18" x 20". Put one of the tiles aside and from the 2nd tile, cut out a piece measuring 8" x 12"; from the 3rd tile, cut out two pieces – one 6" x 12" and the other 6" x 8". Use the yardstick and felt pen to trace the correct dimensions onto the full tiles and then use the scissors to cut out the correct size pieces. Next, arrange the full tile and the three cut-out pieces so they cover the entire floor and one at a time remove their wax paper backings and apply.

- Next, attach the roof. Using the sealant, glue piece B onto the top of pieces C, D, E & F. Let it dry for a few minutes.

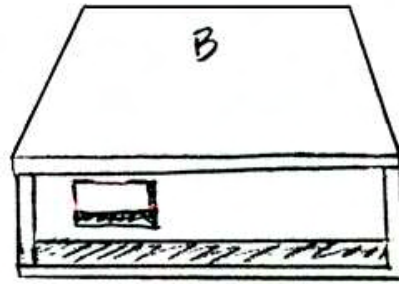

- Then attach the legs. Apply silicone sealant to the top sides and press pieces G1, G2, G3 & G4 onto the corners of the bottom of piece A.

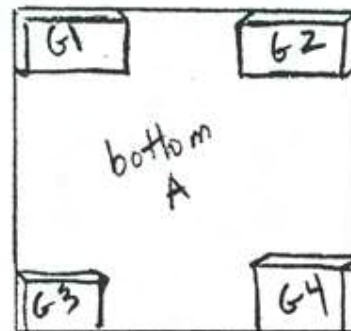

10. Seal all seams and cracks of the shelter with the silicone sealant. This is very important! It keeps drafts out. Seal where the roof touches the side walls, where each side wall meets another side wall and where the walls meet the floor. If necessary, purchase and apply an extra tube of silicone sealant.

11. After the silicone glue has completely dried (usually 24 hours), paint the shelter with one or two coats of latex deck paint, matching the color to the surroundings where the shelter will be placed. (NOTE: the paint will not adhere to areas covered with the sealant unless you're using a paintable silicone. If you're using a non-paintable, clear sealant, you can choose to paint all the outer surfaces of the shelter BEFORE gluing them together to avoid leaving unpainted areas.)

12. [*Optional*]: You may eventually want to add a flap to the front door that the cats can easily pull open, such as a piece of a vinyl mat. You can glue or duct tape it on above the front door, or drill holes and use plastic nuts and bolts like the kind used to attach toilet seats. It's recommended you wait until the cats are familiar with going in and out of the shelter before adding a flap.

TIPS:

- The shelters are very light, so weigh them down with a large rock, board, a few bricks, etc. The roof is strong enough to hold a reasonable amount of weight.
- To break the wind and protect from rain, place two shelters with their front doors facing each other and then place a board on top of both, spanning the two roofs.
- Straw is the best insulation for the interior. Shredded newspaper will also work. Don't use hay which is moist and can become moldy. Don't put towels or blankets on the floor – they will draw out body heat and make the cats colder.
- NEVER PUT WATER INSIDE!! Small bowls of dry food are ok.
- Draw the cats inside the shelter by scattering tasty treats or catnip near and inside.

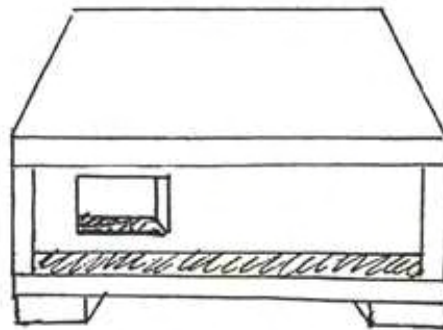

COMPLETED SHELTER

In memory of
Bobby Kergis
1952 - 2011



**Caretaker, Fresh Kills Colony
Staten Island, NY**