



# **ADINATH FORGING PVT. LTD.**

**FORGING THE BONDS THROUGH MANUFACTURING EXCELLENCE**



# VISION & MISSION

## VISION

- BECOME A LEADING MANUFACTURING COMPANY KNOWN FOR ITS PRODUCT QUALITY AND SERVICE

## MISSION

- DELIVER CUSTOMER SATISFACTION THROUGH PRODUCT QUALITY EXCELLENCE
- IMPROVE AND EXPAND OUR MANUFACTURING CAPABILITIES THROUGH USE OF TECHNOLOGY AND PROFESSIONAL MANAGEMENT





# COMPANY PROFILE

**"DELIVERING CUSTOMER SATISFACTION THROUGH PRODUCT QUALITY EXCELLENCE"**

- **SUPPLIER OF FASTENERS, SHEET METAL & MACHINED COMPONENTS**
- **CATERS TO ALL SEGMENTS OF AUTOMOBILE OEM'S & THEIR ALLIES (2 WHEELER, PASSENGER & COMMERCIAL VEHICLES)**
- **3 MANUFACTURING FACILITIES – ROHTAK (2) & PANTNAGAR (1)**
- **MORE THAN 25 YEARS OF EXCELLENCE**





# UNITS

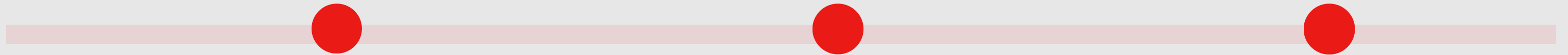

## **PLANT - 1**

ADINATH FORGING PVT. LTD.  
7.7 KM STONE, V.P.O- TITOLI,  
JIND ROAD, ROHTAK-124001  
(HARYANA)  
PH: +91-9996029154

## **PLANT - 2**

PLOT NO. 57 IDC ,  
HISSAR ROAD, ROHTAK-  
124001 (HARYANA)  
PH: +91-9996029133

## **PLANT -3**

PLOT NO. 8, SEC - 6, SIDCUL,  
I.I.E, PANTNAGAR, DISTT.  
U. S. NAGAR,  
UTTARAKHAND  
PH: +91-7895920123

# CUSTOMERS

“Everything revolves around the customer”

## OEM'S



**Mahindra**

2 Wheeler, 4 Wheeler  
Farm Division, SPD,  
Heavy Engine,  
Construction



**ASHOK LEYLAND**



SPD Division

**Mahindra**  
ELECTRIC

## OEM'S through Tier-1 Suppliers



**TATA**



**TOYOTA**

**GM** General Motors

# CUSTOMERS

“Everything revolves around the customer”

## Tier-1 Suppliers



Gurgaon, Manesar,  
Nasik, Sanand,  
Pune, Pithampur,  
Nalagarh, Pantnagar

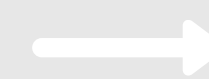

Gurgaon, Bawal,  
Halol, Dhar





# CUSTOMER BASE

- KAPURTHALA
- LUDHIANA
- HARIDWAR
- RUDRAPUR
- SANAND
- VITHLAPUR
- PITHAMPURA
- NASIK
- NAGPUR
- PUNE
- ZAHEERABAD
- BANGALORE

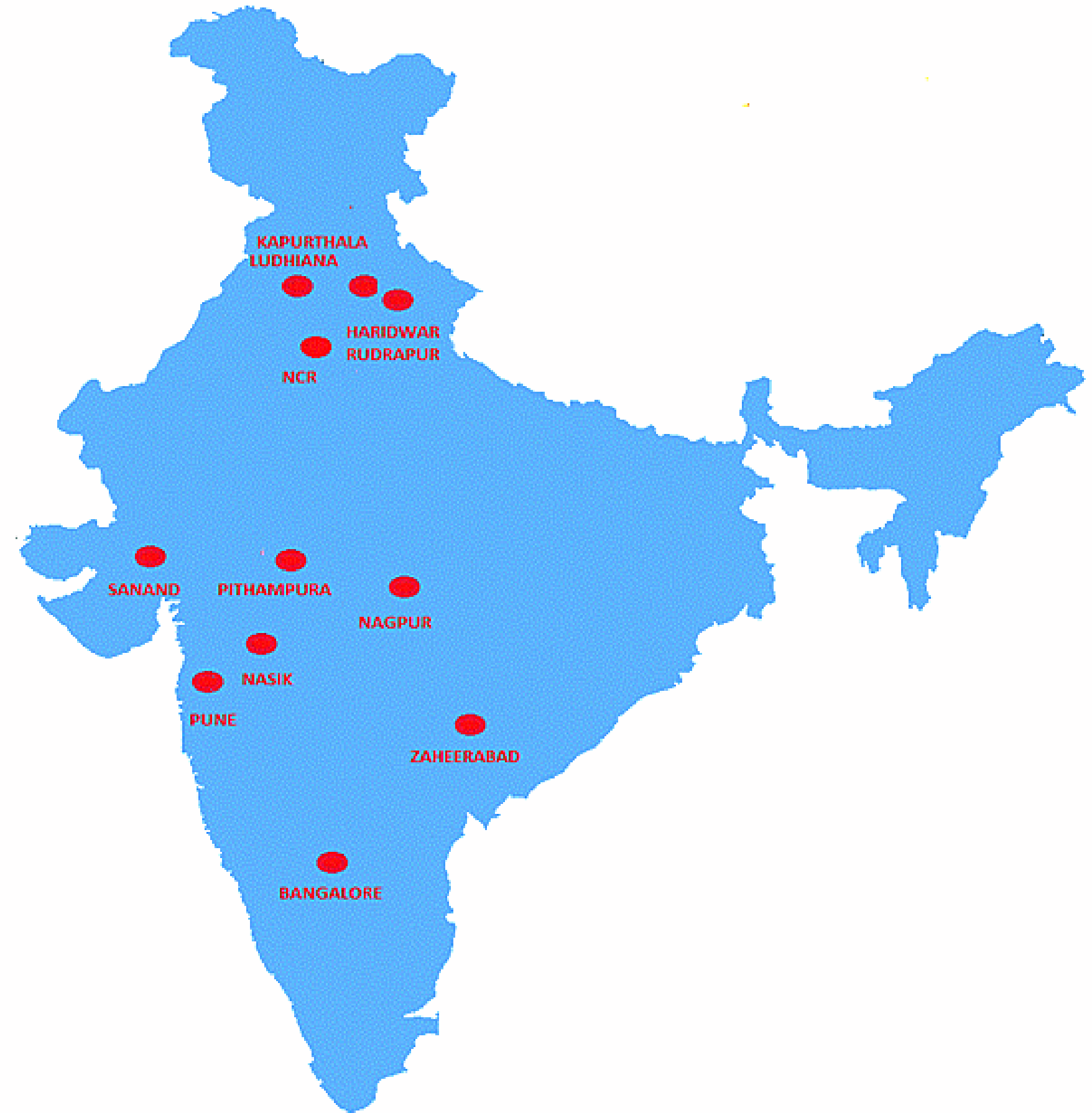



# GROWTH TRAJECTORY

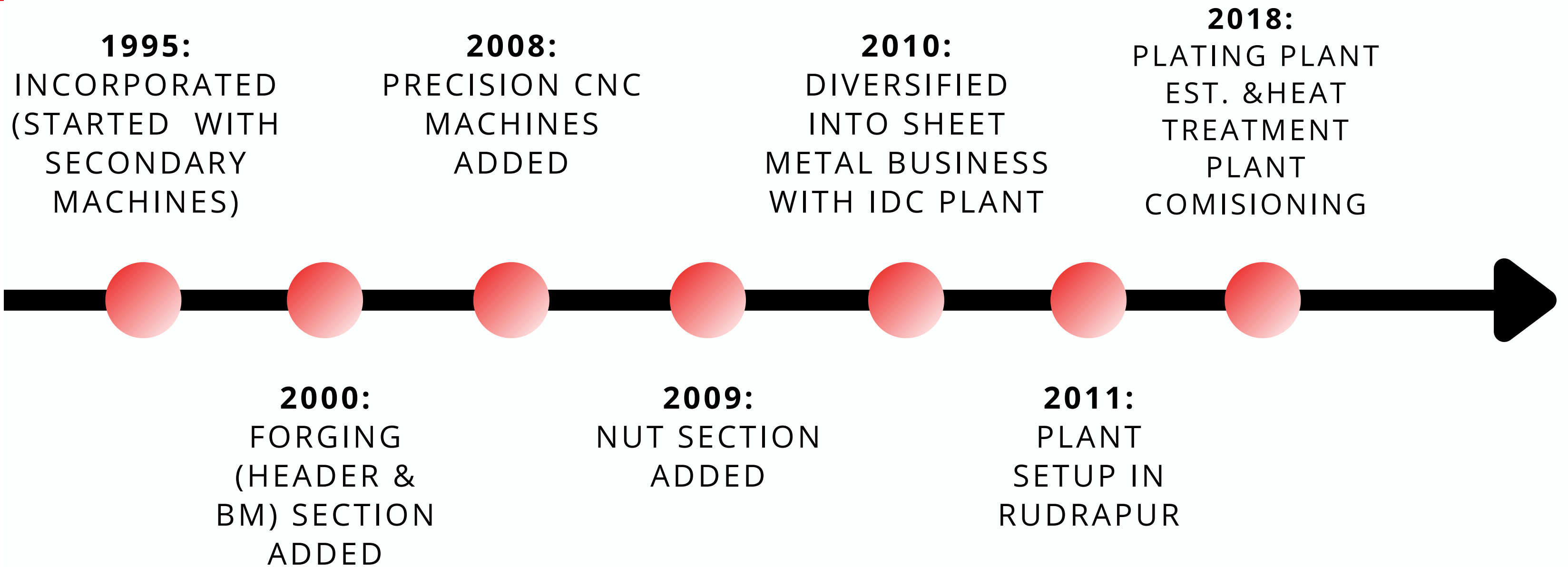



# ENGINEERING EXCELLENCE



**CAMBER BOLT -FIRST COMPANY  
TO DEVELOP CAMBER GROOVE  
THROUGH FORGING ROUTE**

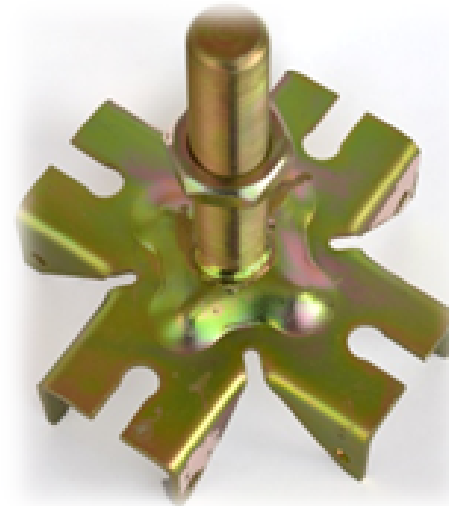

**LOCALIZED TUBE NUT**



**INDIGINISED D - NUT FOR  
MARUTI**

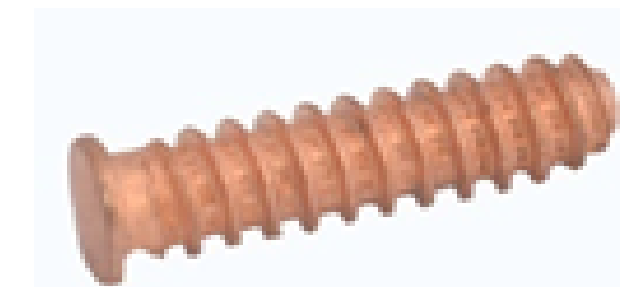

**INDIGINISED SELF TAPPING  
SCREW FOR MARUTI**



# QUALITY FOCUS

Adinath Forging Pvt. Ltd.

- ADINATH - A SYNONYM OF QUALITY
- IATF 16949:2016 CERTIFIED
- ISO 9001:2015 CERTIFIED
- MARUTI CERTIFIED GREEN VENDOR
- OUR PRODUCTS CONFIRM TO BIS, BS, ISO, DIN, & JIS STANDARDS QUALITY



## CERTIFICATE



This is to certify that

**Adinath Forging Private Limited**  
 7.7 KM Stone, Rohtak-Jind Road  
 VPO-T804, Rohtak - 124 001  
 Haryana  
 INDIA

has implemented and maintains a **Quality Management System**.

Scope:  
 Manufacture of Fasteners, Pressed and Machined Components.

An audit, conducted and documented in a report, has verified that this quality management system fulfills the requirements of the following International Automotive Standard:

**IATF 16949:2016**  
 (without product design)

Certificate registration no.	00202629 IATF 16
Main certificate registration no.	00202629 IATF 16
Issuing date	2019-07-01
This certificate is valid until	2022-06-30
IATF No.	0398394



For and on behalf of DQS

Nurettin S. Verbeekhuizen  
Corporate Program Manager Automotive, DQS Holding GmbH

Michael Drechsel  
Managing Director, DQS Holding GmbH

IATF Contact Office: DQS Holding GmbH, Konrad-Adenauer-Allee 6-10, 61118 Bad Vilbel, Germany

# QUALITY FOCUS



# LAB & TESTING FACILITY

"We have state of art testing facilities & equipments"



- EDDY CURRENT SORTER
- UTM
- MICROSCOPE
- SALT SPRAY TESTING CHAMBER
- DIGITAL VERNIER CALIPER
- MICRO VICKERS HARDNESS TESTER
- ROCKWELL HARDNESS TESTER
- PROFILE PROJECTOR WITH DRO
- TORQUE WRENCH
- BLADE MICROMETER
- PITCH MICROMETER
- VERNIER CALIPER
- DIAL INDICATOR
- ANGLE PROTECTOR
- BORE GAUGE
- HEIGHT GAUGE
- LEVER DIAL INDICATOR
- AIR RING GAUGE





# CUSTOMER FEEDBACK

Adinath Forging Pvt. Ltd.



## CERTIFICATE OF APPRECIATION

This Certificate is awarded to

**ADINATH FORGING P LIMITED**

**(UTTARAKHAND)**

We congratulate and appreciate your persistent efforts in maintaining higher levels of capability and performance and being in **QUAD A** for the period **Q1** of **FY20**. We look forward to your continued efforts to achieve benchmark levels of quality performance.

  
Mr C Rajendran  
Head - Supplier Quality

  
Mr Vivek Agrawal  
Head - Procurement

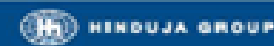



# CUSTOMER FEEDBACK

Month-JUNE-2019									SUPPLIER SCORECARD	
	PPM at MCE	Customer Complaint in Nos. at M & M	Warranty, Dealer return, field actions, recalls in Nos.	On Time Delivery	Line loss due to BOP at MCE (Yard Hold/Ship Hold) in Hrs	Premium Freight (Occurrences)	No. of days without defect at MCE			
Target	< 25	0	0	100%	0	0	>120			Rating Criteria (Total Score)
Actual level of Performance	3	3	3	3	3	3	3			<b>EXCELLENT</b>
level of performance Criteria	Level 1	>50	>1	>1	96%-97%	>5	>1	<100		EXCELLENT > 240
	Level 2	26-50	1	1	99%-98%	1-5	1	> 100		GOOD BUT SCOPE FOR IMPROVEMENT 240-210
	Level 3	<25	0	0	100%	0	0	> 120		POOR / MUST IMPROVE < 210
Weightage	20	20	5	20	15	10	10			
Score	60	60	15	60	45	30	30			
Unit	PPM	Nos.	Nos.	%	Hrs	Nos.	No. of day's			
Act Performance	24	0	0	100%	0	0	121			<b>TOTAL SCORE 300</b>

## Supplier Performance Evaluation

Mahindra Heavy Engines



Supplier Name:	ADINATH FORGING PVT LTD			Supplier Code:	DA204			
Assessment Year	F18	Quarter	Q1	Period	April 17 - June 17			
Buyer Name	Amit Kharche			SQA	N Rajendran			
Purchase Manager	Santosh Rajale			SQA Manager	Mohan Ram			
SCORE SHEET								
Criteria	Quality	Delivery & Flexibility	ASN %	Responsiveness / Communication	Logistics PPM	Initiatives	Premium Freight	Overall
Scale 1 to 4	4.0	4.0	4.0	4.0	3.0	3.0	4	3.9
Weightage	30%	25%	10%	15%	5%	5%	10%	100%
Score	1.20	1.00	0.40	0.60	0.15	0.15	0.40	3.9
Rating	Excellent	Excellent	Excellent	Excellent	Good	Good	Excellent	Excellent

Note:- Kindly refer next leaflet for rating definition

Remarks :



# PROCESSES

**HOT FORGING**

**COLD FORGING**

**HEAT  
TREATMENT**

**NUT FORGING**

**PLATING**

**THREAD  
TAPPING**

**THREAD  
ROLLING**

**SURFACE  
TREATMENT**

**PRESS SHOP**



# PRODUCTS



## SPECIAL NUTS

- T NUTS
- TUBE NUTS
- PROJECTION WELD NUTS
- FLANGE NUTS
- CONICAL HEX NUTS
- LOCK NUT & CAP NUT

## STANDARD NUTS

- HEX NUTS
- HEX WELD NUTS
- SQUARE NUTS
- SQUARE WELD NUTS
- STYLE 2 NUTS

## SPECIAL BOLTS

- CAMBER BOLT
- PROJECTION WELD BOLTS
- SOCKET HEAD BOLTS & STUDS
- EYE BOLTS & CAP BOLT
- WHEEL BOLTS
- SCREWS

## STANDARD BOLTS

- HEX BOLTS
- COMBI BOLTS
- WELD BOLTS
- FLANGE BOLT /SCREW

## • HUB STUDS

## • DOWELS

## • COLLAR

## • TOWING HOOK

## • ADAPTORS

## • BANJO BOLTS

## • PLUGS

## • MACHINED COMPONENTS





# BOLTS & SCREWS

## STANDARD BOLTS

- HEX HEAD BOLT
- SOCKET HEAD BOLTS
- WELD BOLT
- FLANGE BOLT
- BUTTON HEAD BOLTS
- SCREWS



## SPECIAL BOLTS

- CAMBER BOLT
- ENGINE BOLTS
- CARRIAGE BOLTS
- COMBI BOLTS
- CAP BOLT

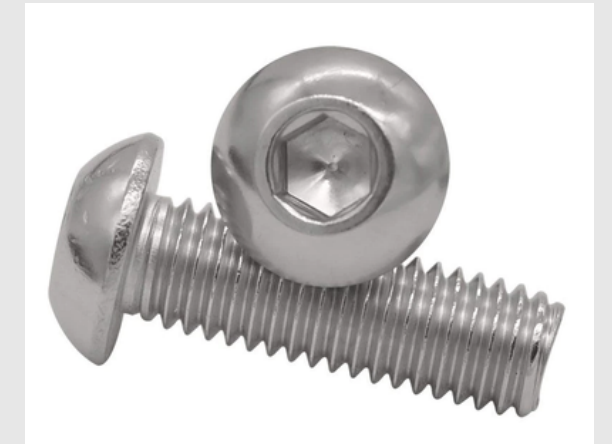



# NUTS

## STANDARD NUTS

- HEX NUT
- HEX WELD NUT
- SQ. WELD NUT
- CAP NUT
- FLANGE NUT
- STYLE-2 NUTS



## SPECIAL NUTS

- FLANGE NUTS
- CONICAL HEX NUTS
- MUSHROOM NUTS
- TUBE NUTS
- LOCK NUTS
- CAP NUTS

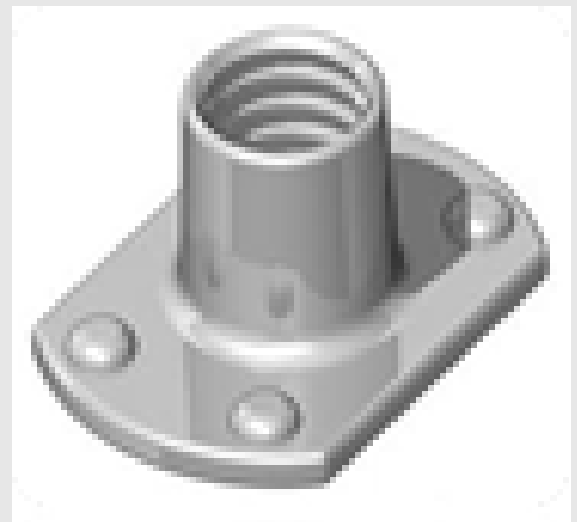



# SPECIAL COMPONENTS

Adinath Forging Pvt. Ltd.

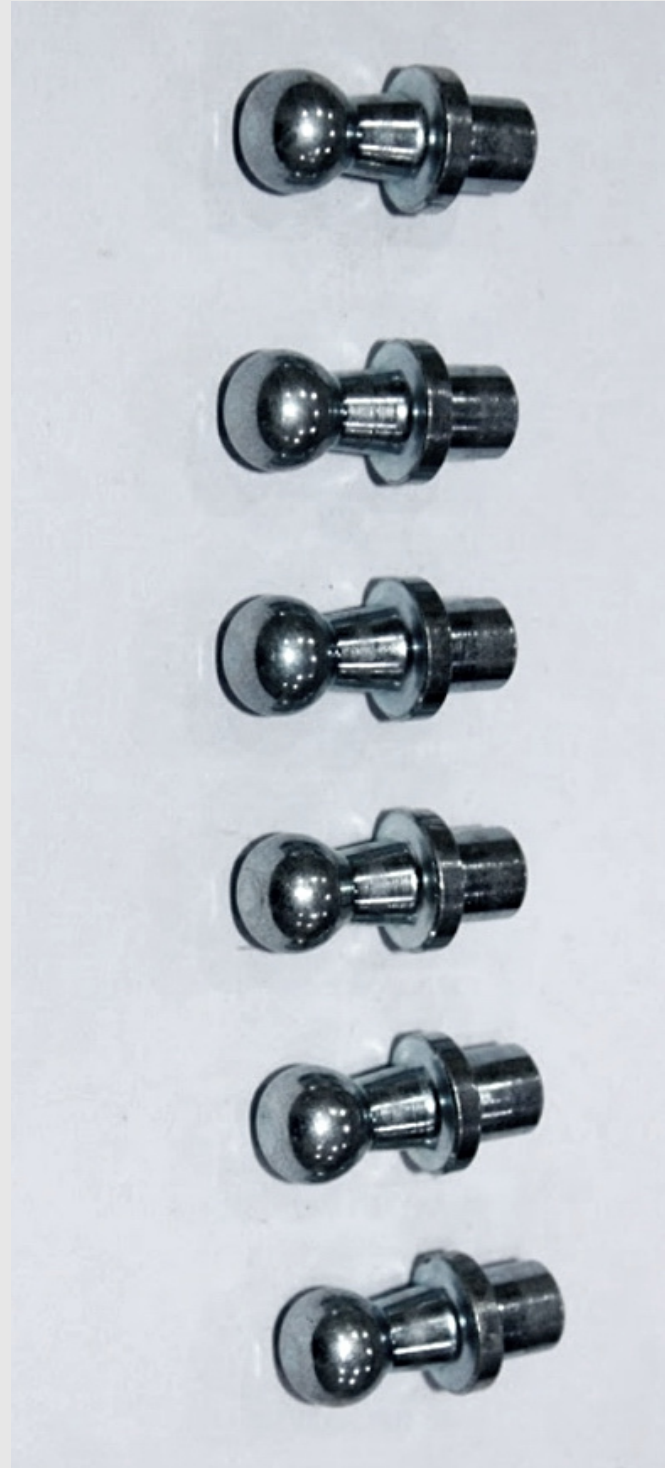



Adinath Forging Pvt. Ltd.

# SPECIAL COMPONENTS





# SHEET METAL PRODUCTS

- WASHERS
- WELDED/TUBULAR ASSEMBLIES
- PRESSED COMPONENTS
- CLIP HARNESS
- RAISED FLOOR
- OVER 25 SUB ASSEMBLIES
- OVER 50 CHILD PARTS

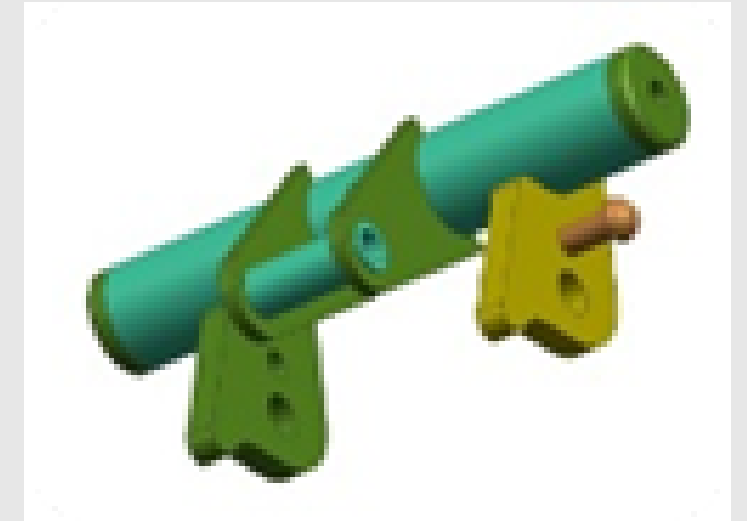
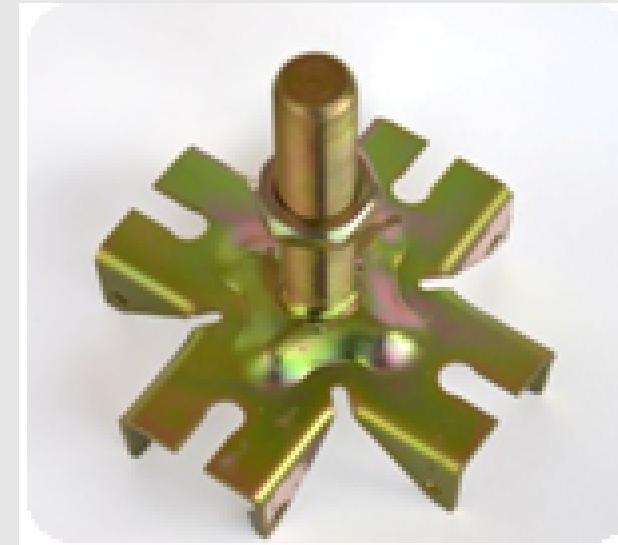



# EMPLOYEE TRAINING

Adinath Forging Pvt. Ltd.





# MEDICAL CAMPS



# FESTIVAL CELEBRATION





# PHOTO GALLERY

Adinath Forging Pvt. Ltd.

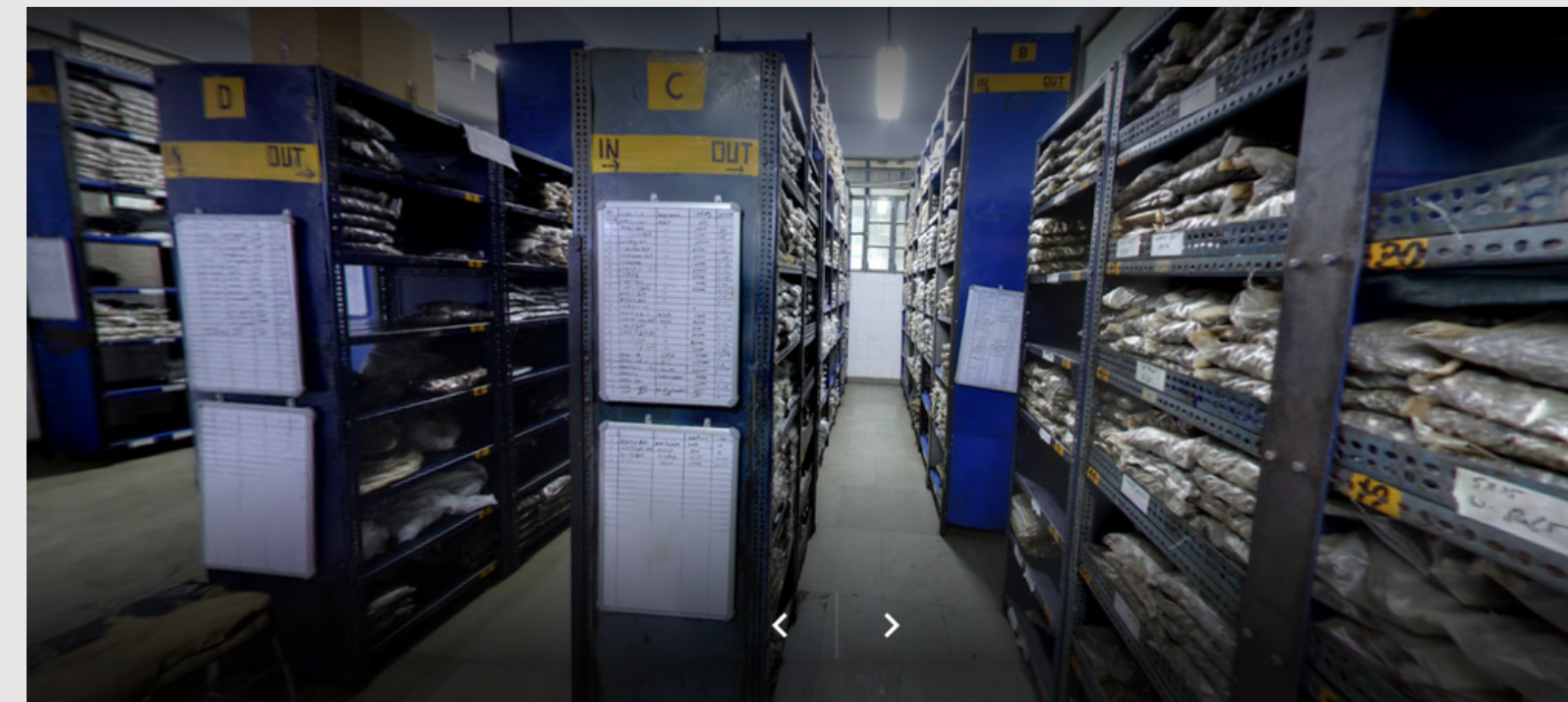
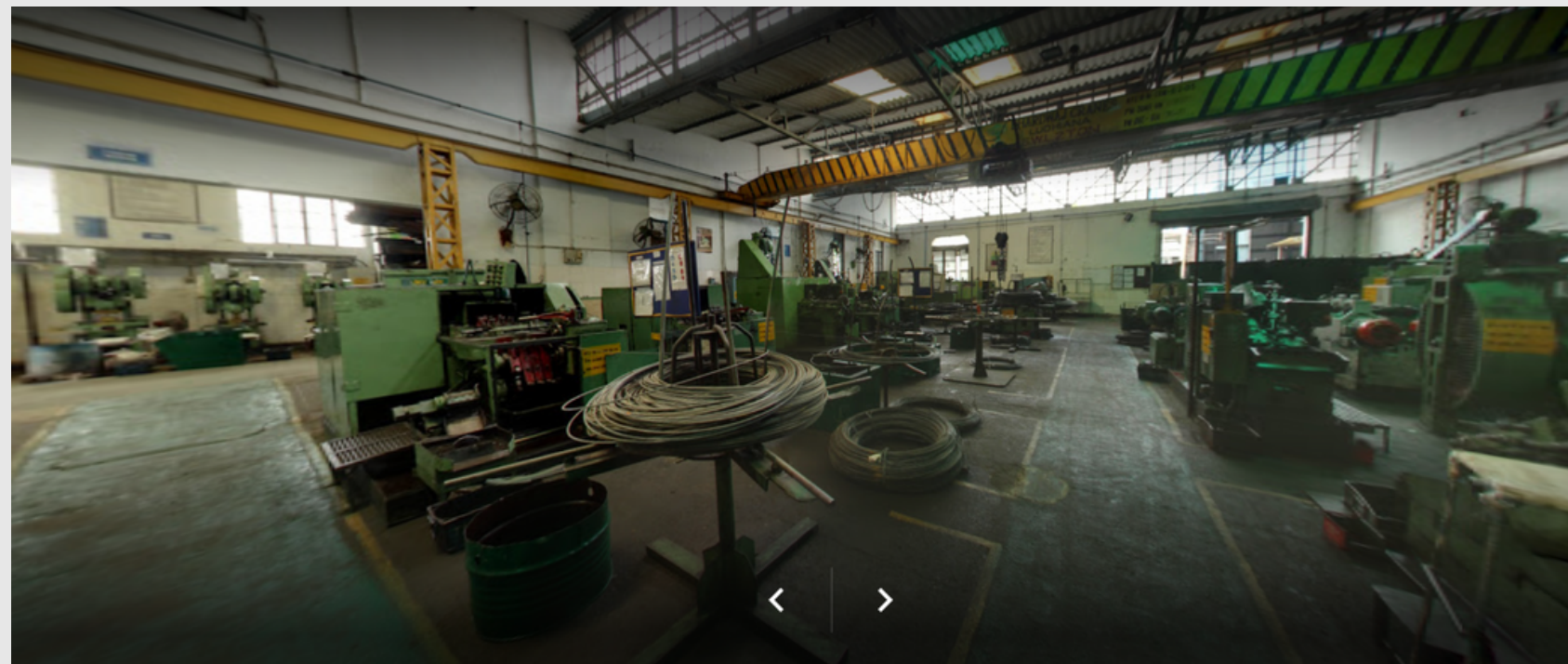
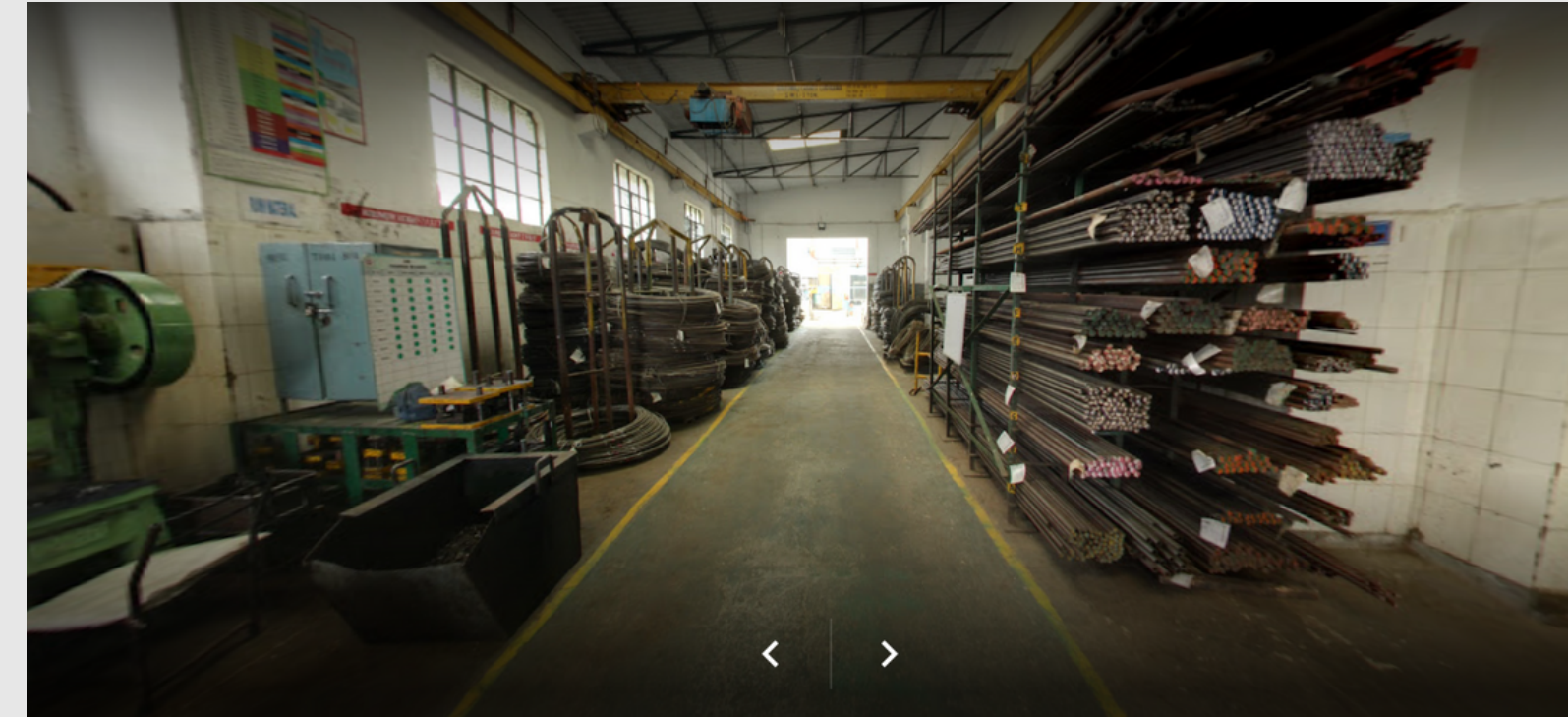





# PHOTO GALLERY

Adinath Forging Pvt. Ltd.

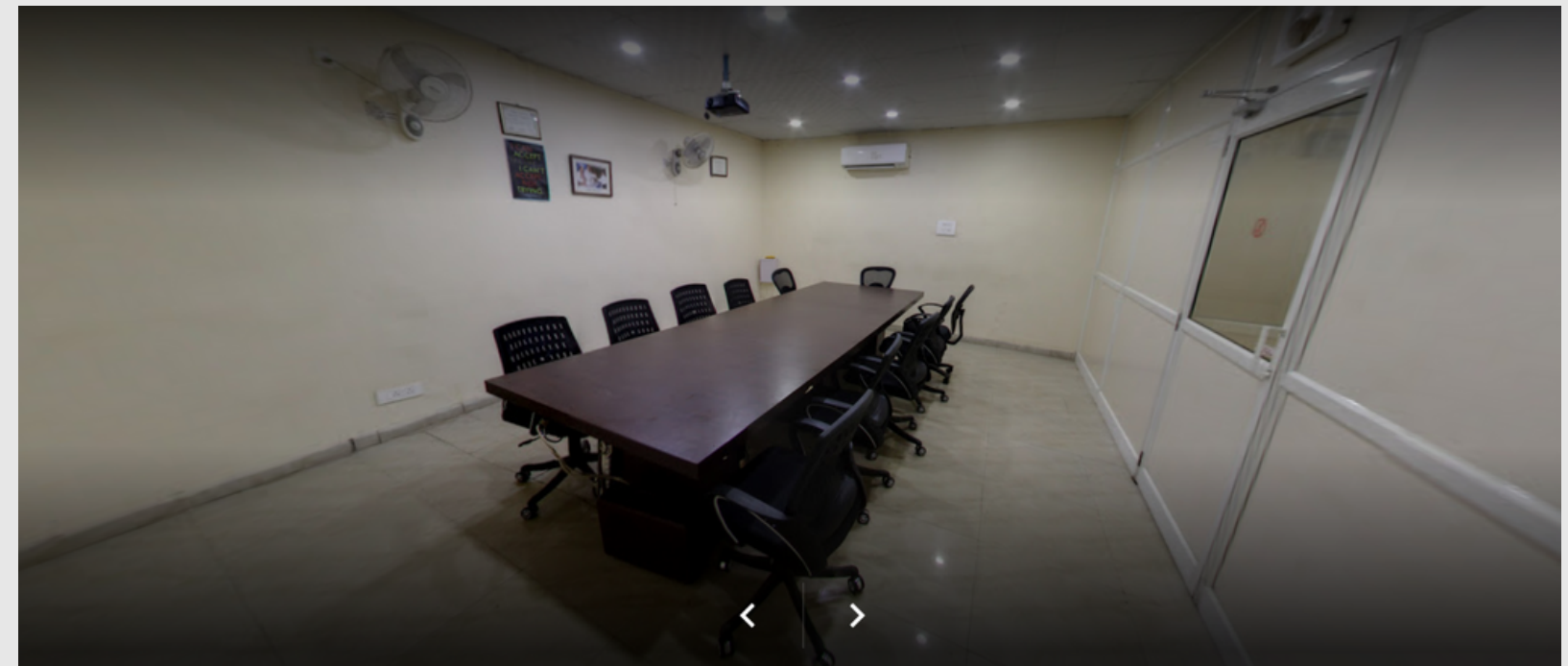
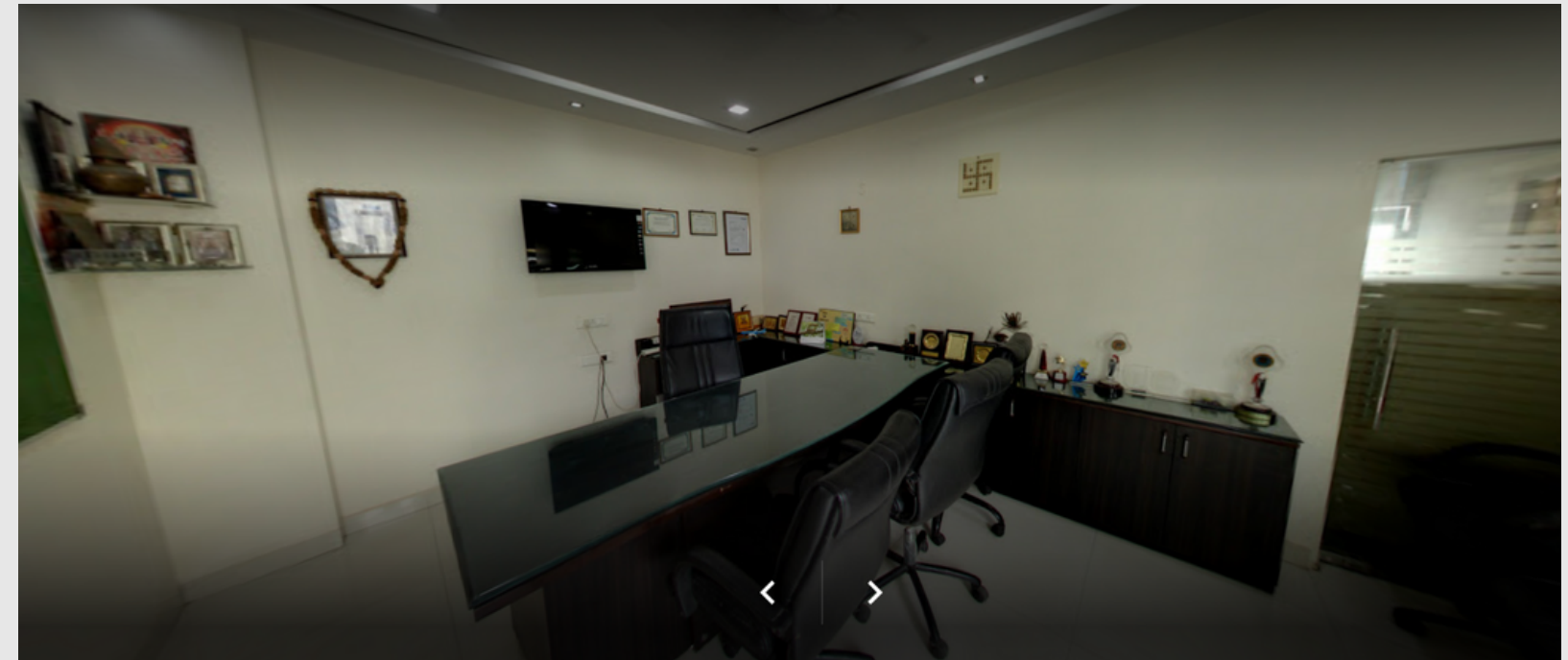
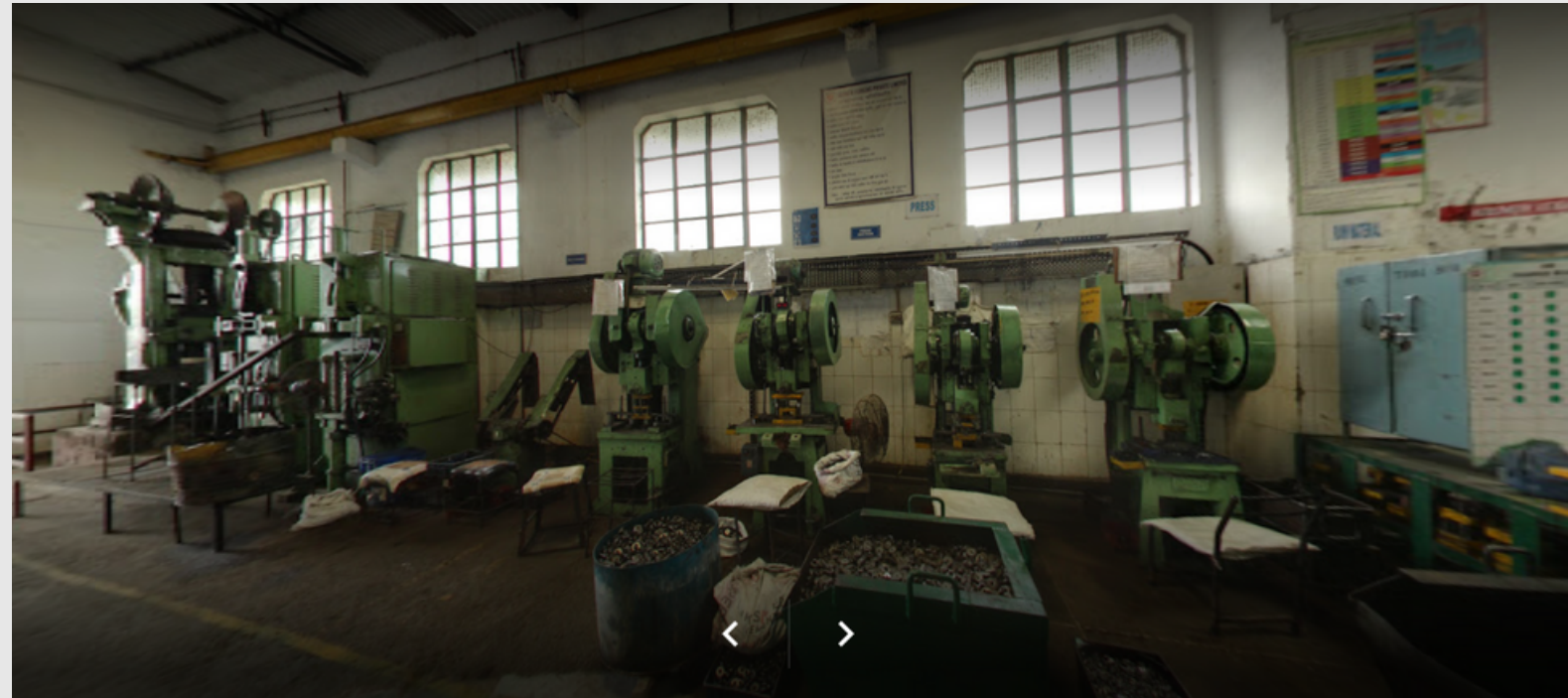

# **ADINATH** **ADVANTAGE**

- **QUALITY ASSURANCE**
- **SUPPLY TO ALL MAJOR AUTOMOBILE OEM'S**
- **SKILLED & EXPERIENCED TEAM**
- **ONE STOP SHOP - SHEET METAL, FASTENER, NUTS, SPECIAL COLD, HOT FORGED & MACHINED COMPONENTS**
- **VAST PRODUCT RANGE UNDER ONE ROOF**
- **ABILITY TO DESIGN & MANUFACTURE PRODUCT AS PER CUSTOMER REQUIREMENT**



**LOOKING FORWARD  
TO SERVE YOU**

**TEAM ADINATH**