

**Fabric of The Universe:  
The Origins, Implications, and  
Applications of Vastu Science and  
Vaastu Science and Technology**

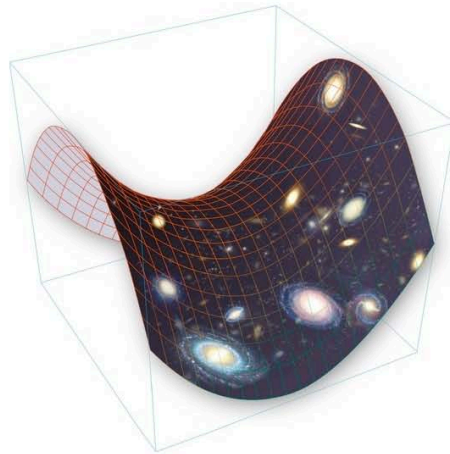

By

Jessie J. Mercay, PhD, PhD mst



**Fabric of The Universe:  
The Origins, Implications, and Applications of Vastu  
Science and Vaastu Science and Technology**

By

Jessie J. Mercay, PhD, PhD mst

Published in India by  
**Dakshinaa Publishing House**  
Number 46, First Avenue  
Vettuvankeni, Chennai – 41  
India, (Tamilnadu)  
Phone: (044) 24491384; 24492651

Published in US By AUM Science Publishing  
Box 1195 W Frontage Rd # A-36  
Rio Rico, AZ 85648  
[aumcourses@aumscience.com](mailto:aumcourses@aumscience.com)

Publisher in India: Dr. V. Ganapati Sthapati  
Publisher in US: Dr. Jessie J. Mercay

First Edition: December 2005  
Second Edition: May 2006  
Third Edition: June 2007  
Fourth Edition: March 2008  
Fifth Edition: September 2008  
Sixth Edition March 2009  
Seventh Edition: March 2010  
Eighth Edition: December 2010  
Ninth Edition: January 6, 2012  
Price:  
India and Asia: Rs. 250  
Europe and the Americas: \$19.95 US  
Vishwakarmans, Nuns or Monks: Free or donation

Purchase:  
[drjmercay@gmail.com](mailto:drjmercay@gmail.com)  
[www.aumscience.com](http://www.aumscience.com)

Copyright 2005-present, Dr. Jessie J. Mercay, USA [drjmercay@gmail.com](mailto:drjmercay@gmail.com). No part of this document, including drawings, concepts, and written material may be copied, paraphrased, or transmitted without the explicit permission of the author. This document contains original intellectual material and concepts available nowhere else, and it is the explicit intellectual property of the author.

## Acknowledgments

I would like to take this opportunity to thank several people for their help and support. Their contributions are numerous and their love and support were most welcomed. First and foremost, I want to offer my deepest honor and respect to Mamuni Mayan who, through deep introspection, revealed to humankind the knowledge that we call Mayonic Science and Technology/Vaastu Shastras. Second, I would like to thank Dr. V. Ganapati Sthapati and his entire family tradition of Sthapatis and Shilpis who, for thousands of years, have been agents for passing down this ancient knowledge in its purest form. Dr. Sthapati's deep insights, willingness to share, and continued support were instrumental in inspiring me to delve deeply into my inner Nataraja to comprehend aspects of this knowledge that have not been written for thousands of years. His guidance, mentorship, intelligence, blessings, and warmth made it possible for me to produce this document.

I would also like to thank Dr. Chao Li for his ongoing support in delving into the ancient science and technology of built space. I want to thank Arch. Krithika Karuppiah, Sthapati Santhana Krishnan, Ponni Selvanathan and, Gayathri Sayam for their suggestions and help with Pranava Veda translations and many other topics through the years. My dear longtime friend Karen Kelly helped proof prior editions. Gretchen Leary graciously redrew many of the illustrations. Laura Miller skillfully edited this edition – many thanks.

The life and teachings of various sages through the ages have influenced me in innumerable ways. Among many other things, I learned is the necessity of keeping ancient knowledge pure. I also learned to go beyond this mundane world into my Inner Being where the Riks find and illuminate me.

I would like to thank the students of The American University of Mayonic Science and Technology for their enthusiasm, commitment, and love for this deep knowledge. Their fire feeds my own cosmic flame. We have had many graduations, and now we have more than 100 properly trained, qualified Vaastu consultants and architects ready and willing to help bring peace to the world one house at a time.

Anyone wishing to learn this knowledge in its true form is advised to email [aumcourses@aumscience.com](mailto:aumcourses@aumscience.com) and visit the website at [www.aumscience.com](http://www.aumscience.com).

The American University of Mayonic Science and Technology is the only institution in the world (other than Vaastu Vedic Research Foundation) that is authorized by a Shilpi Guru to teach this sacred knowledge at the certification level.

Finally, it is through my research and studies of Pranava Veda, Aintiram, Vaastu Shastras, pre-Vedic and Vedic knowledge as well as studies in Kashiri Shaivism, Buddhism, Christianity and many Western philosophies since before 1968 that I have derived knowledge for developing Self Recognition Meditation SRM™ ([selfrecognitionmeditation.org](http://selfrecognitionmeditation.org)) – a powerful, easy mindful transcending mantra meditation based on principles behind Vaastu Shastras.

I have attempted to acknowledge my sources for quotes and diagrams. In some cases, I might have failed at the task and ask for forgiveness if this is the case. Upon notification, I will immediately include acknowledgement in the next edition.

## Dedication

I dedicate this book to my parents, Lorance Mercay and Jessie Jardine Patty Mercay. The attributes that they passed on to me supported the insights that I have had in this text. My mother was an educator and understood the importance of gaining knowledge. She came from a long line of Scottish architects who designed and built for centuries (on her father's side). They were members of the Scottish Rites Temple, which I believe has its roots in Mayonic Science and Technology – the umbrella name for Vaastu Science. On her mother's side, she came from a lineage of *masons*. Dr. Sthapati has said that mason's were originally *Mayans*. My father (who passed in February 2010 at the age of 95 ½ – still vital until the last few days of his passing) was a farmer and carpenter – his father was a draftsman and plumber until he married my grandmother who owned a dairy farm in NY state. My paternal grandmother was a college graduate in the early 1900s – a pioneering feat for a woman. My parents each maintained their own spiritual nature and ultimately understood that I have my own path.

It was during my early years as a child growing up in the silence of nature that I had an authentic awakening and experienced a deep understanding regarding the oneness of all creation – manifest and unmanifest, the seen and unseen. While I had no name for it at the time, I now know it was an experience of the essence of Brahman permeating all of Its creation. This happened in bits and pieces when I was five or six years old and culminated in a profound and tangible experience when I was around 12. Those experiences gave me my first glimpse of Vastu – the source of all life – and Vaastu – the vibrant consciousness in material existence. I am grateful that my parents provided me with the environment for those experiences. I left home at the age of 14, after my mother's death, and began a quest that eventually brought me to Mayan.

I would also like to dedicate this to the father of Dr. V. Ganapati Sthapati: Sri Vaidyanatha Sthapati, a renowned Sthapati and Sanskrit scholar. The priceless knowledge that he so carefully passed on to his son and preserved in the forms that he built and fashioned, large and small, has contributed immeasurably to the preservation and revelation of Mayonic Science and Technology. The Sthapatis and Shilpis who are members of the creative indigenous clan of India have maintained this body of knowledge through their divine art – I also dedicate this text to them – and, of course, include Sri Dr. V. Ganapati Sthapati, Vaastu Vyan, my beloved Guru who dropped his mortal coil in September 2011.

**Note:** This document began as an inner cognition of the manifestation process, which I experienced in 2004, with bits and pieces of it being experienced since childhood. In 2025, I presented these ideas to Dr. Sthapati at my first workshop with him in Kauai, HI, shortly after the cognition. He verified my inner experience as the unfolding of the manifestation process within my Atman as described by Mayan. At the time I presented this information to him, he asked me who taught me this. I said that no one had. He asked where I got it. I pointed to my chest and told him “Here, inside.” He said to me, “Madam, no one has written this knowledge in many centuries.” In December 2005, I wrote the first edition of this text and presented it as a thesis to the Vedic Research Foundation, Chennai, directed by Dr. V. Ganapati Sthapati, for which I was awarded a Doctorate in Mayonic Science and Technology (Ph.D.mst). When I presented it to him upon my arrival in Chennai, he spent the night reading it several times over. The next morning he said to me, “Madam. I wept with tears of joy to see this knowledge put in print” (the knowledge of the transformation of energy (Vastu Brahman) into matter (Vaastu Brahman)).

Dr. Sthapati likes to give his major students a special name. He calls me Jessie Maya. Maya is a name that is often used in Vedic literature to refer to Mamuni Mayan, the progenitor of Vaastu Shastras and many other texts.

This present edition is expanded and contains new information. As mentioned previously, some of the information herein has never been published in modern times and was developed from my own introspection. It has been carefully reviewed, verified, and found to be accurate by Dr. V. Ganapati Sthapati prior to publication. The physics of Mayonic Science, the Mayonic Code, the broader and deeper than usual definitions of Vastu and Vaastu, the finer details of Mayan's use of the word Kaalam, the details of the additive process of manifestation, and other revelations are some of the topics uncovered by me and verified by Dr. V. Ganapati Sthapati. This book is used as one of the texts for the American University of Mayonic Science and Technology: [www.aumscience.com](http://www.aumscience.com).

It is with great humility that I say it is my deepest pleasure and joy to present this to you. If you are inspired to email me with your comments, please do: [jmercay@vastu2vaastu.com](mailto:jmercay@vastu2vaastu.com)

*For as long as Space endures  
And for as long as living beings remain  
Until then may I too abide  
To dispel the misery of the world  
Shanti Deva*

Jessie Maya Jardine Mercay, PhD, PhDmst  
Arizona, USA, January 6, 2012; May 16, 2024

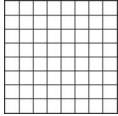

## TABLE OF CONTENTS

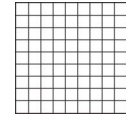

<i>Foreword</i>	<i>iv</i>
<i>Second Letter</i>	<i>x</i>
<i>Preface</i>	<i>xi</i>
<b>Chapter 1. Introduction</b>	<b>1</b>
<b>Chapter 2. The Force that Lives Eternally</b>	<b>5</b>
What is Vastu Science?	6
A Lost Science	8
Our Link to the Ancient Past	11
The Big Thaw	14
<b>Chapter 3. The Progenitor of Vastu</b>	<b>19</b>
The Pranava Veda and Other Works by Mayan	25
The Discovery	29
<b>Chapter 4. The Manifestation Process Called Vastureva Vaastu: The Physics of The Divine</b>	<b>35</b>
The Source of Vaastu Energy	35
The Absolute Theory of Manifestation	39
The Growth Dynamics of the Unmanifest	41
Time or Kaalam as a Process	53
<b>Chapter 5. Eight Equals Nine: The Relative Theory of Manifestation</b>	<b>63</b>
<b>Chapter 6. What Is Vaastu Science and Technology?</b>	<b>79</b>
<b>Chapter 7. The Application of Vaastu Science</b>	<b>83</b>
Essential Components of Vaastu Technology	85
Basic Elements of Vaastu Technology	89
Rectifying Existing Structures	114
Shastric Evidence for Proper Building	118
Learning to Practice Vaastu	120
<b>Chapter 8. Our Inspiration</b>	<b>123</b>
<b>Chapter 9. Epilogue: The Swelling of Brahman: Vaastu Through the Arts</b>	<b>125</b>
<b>The Cosmological View of Mamuni Mayan in His Mayonic Science</b>	<b>129</b>
<b>Appendix A</b>	<b>139</b>
Manifestation and the Square Wave: What the Blip Is Going On?	
<b>Appendix B</b>	<b>143</b>
The Mayonic Code: The Physics of Wave Forms and Vastureva Vaastu	
<b>Appendix C</b>	<b>157</b>
More on the Formation of Square Waves and Sine Waves	





## Foreword

By Dr. V. Ganapati Sthapati, Shilpi Guru

I take immense pride and satisfaction in writing this introduction for this Publication by Dr. Jessie Mercay, which captures the essence of “Vaastu Science” and presents this great Science and its Technology in a succinct package to the global community.

The contents of this publication attest to the subtle but potent truth about the origin and continuing growth of Indian Culture. The fabric of Indian Culture is interwoven within the threads of Vaastu Science.

A key to understanding Indian Culture is to comprehend that it is this Vaastu Science that gives rise to the resultant Technology. On the contrary, in the case of Modern Science, it is the tenets of Technology, which give rise to the Science.

Vaastu Science embodies the onward universal journey from the Inner Subtle Nature to the Outer Gross Nature. In other words, the marked difference is that Vaastu Science is Spirit-centric and Modern Science, Matter-centric.

This Science, in its entirety and simplicity, when applied, enables us to live in harmony with the innate rhythm of Nature.

Dr. Jessie Mercay has thoroughly explained the origins of Universal Life and the Science behind it. Going one step further, her immense grasp of this Science has enabled her to expound very ably its applications in Building Architecture and its implications on human life.

As Shilpa Guru, I bless Dr. Jessie for her inimitable contribution to the essence of Indian Culture.

Dr. V. Ganapati Sthapati, B.A., F.I.I.A.

Chennai, India

## Second Letter

(for revised edition of text)

Most Respected Madam Jessie,

I am really happy that you have thrown your heart and soul into the revised presentation of the thesis "Fabric of the Universe."

As you say, some new items have been included for the scholars acquainted with sine waves, which appears to be appropriate in the context you have introduced. I thank you for introducing a very apt term for flexion of the spirit when we do certain work concerning sculpture and perform dance. The illustrations prove apt in seeing and understanding this knowledge?

Though readers will be new to the subject, they will be able to internalize and comprehend the sacred material.

With Regards,  
Yours Ever,

Dr. V. Ganapati Sthapati

April 29, 2006

Vaastu Vedic Research Foundation and

International Institute of Mayonic Science and Technology

July 2006: Dr. V. Ganapati Sthapati conferring blessings onto Dr. Jessie Maya Jardine Mercay for her efforts in establishing and continuing AUM S&T.



## Preface

*Salutations to Brahman, who is beyond speech and thought, who is with manifest form, who is free from attributes, who is the very nature of qualities, who is manifest as the basic support of all the worlds. (Mayan in Surya Siddhanta)*

This book defines Vastu Science and Vaastu Technology and traces its origins and history. It reveals and illuminates the mechanisms of creation from intangible Absolute Space through the weaving of the fabric of creation to the emergence of the material world. This book answers fundamental questions that arise in the minds of most people, ancient and modern. The body of knowledge discussed herein provides a solution to man's yearning for peace, prosperity, wellbeing, and spiritual growth.

The word Brahman as used in this text is both scientific and spiritual. It is an ancient name for the Quantum field – the source of all life. This book answers fundamental questions about that source of life.

How does unmanifest, potential energy become manifest, material form?  
How do the buildings we live and work in influence our emotional and physical health and spiritual and material prosperity?

*It is the Inner space that becomes the Primal source and source of creation. It becomes the conscious form. It is the creative urge; it is consciousness itself; it reveals the creative way and process; it illuminates, shedding light everywhere; it affects the completion and fulfillment. Observe the fundamental order of inner space. (Dr. V. Ganapati Sthapati, Who Created God, p 35-36, quoting Brahmarishi Mayan)*

The fundamental crux of Vastu Science and Vaastu Science and Technology (the reason for the difference in spelling will become clear) is that Mayan, an ancient architect and Rishi, perceived that there is one force, one fundamental First Principle, from which all life emerges, in which all life resides, and which ultimately returns to its Primal state of pure energy. He named this principle Brahman. He saw that Brahman (Absolute Space, Consciousness, Potential Energy), by its own initiative, goes through a specific process to transform and manifest itself as the material world and its objects: Kinetic Energy. Mayan perceived that that process was accomplished through a mathematical order and that that order could be replicated by humans to unfold specific qualities of Brahman that would vibrate in a form that brought health, happiness, and spiritual bliss to those who partook in that form. That form could be dance, poetry, music, sculpture, or architecture. Not shown but implied is the 8x8 grid behind the octagon and circle. Octagon and circle are simply transformations of the 8x8 grid.

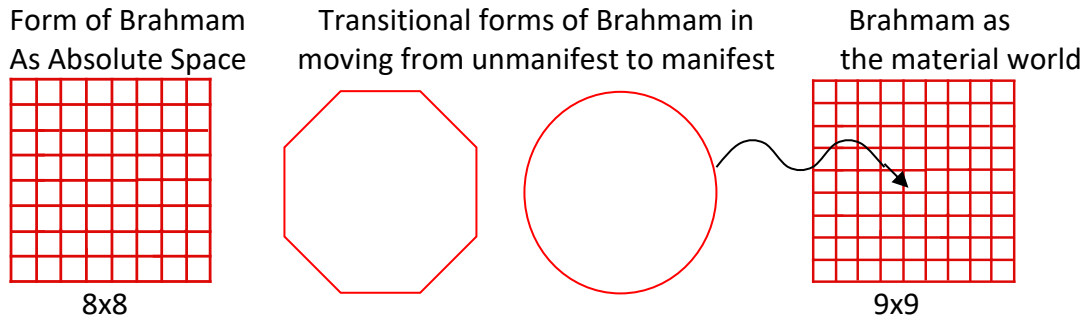

Unmanifest Absolute Space – Consciousness – Brahman transforms itself into manifest Consciousness – Brahman in forms such as trees, rocks, people, etc.

Science ~ Religion

Tamas Guna - Rudra

Rajas Guna - Vishnu

Sattwa Guna - Brahma

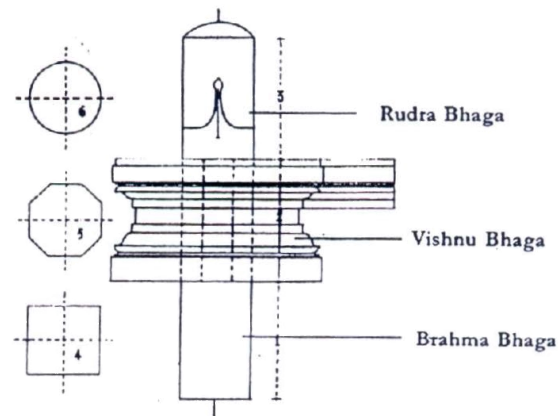

*These three “gunas” or qualities are examples of the intermediary forms of Brahman as it transforms itself from unmanifest to manifest. They are both forms and frequencies aroused within consciousness as it moves within itself to contain itself in material form (These forms of Brahman or First Principle are discussed in depth in The Science of Mamuni Mayan’s Vaastu Temple Architecture: Savoring Your Own Beauty, by Dr. Jessie Mercay).*

The universal laws and building codes of authentic Vaastu Shastra (Mayonic Science) reveal, in profound detail, how to create built space using the precise mathematical formulas, inherent in all creative activities, which take place in nature. A Vaastu structure is a vibrant, self-contained living organism, which serves to enhance positive qualities of life for its inhabitants.

This book is not a technical manual on building architecture. However, it will provide an in-depth analysis of the autocatalytic dynamic process of Vastureva Vaastu and its application to modern residential and business building architecture. Yet, the study of this body of knowledge is vital for anyone wishing to engage in the building architecture of Sthapatya Veda/ Vaastu architecture.

Brahmarishi Mayan said very succinctly in his Aintiram: *“Through the power of inner consciousness, the knower of Vastu should know about light aspects and sound aspects of OM pertaining to both inner and outer space. Those who do not realize the creative dynamism of inner space cannot know the dynamism of outer space.”* (195,831)

In this text, there will be unusual and new terms that you will encounter as well as mind- and consciousness-expanding concepts. Through many readings and deep study, if you choose this path of Mayonic Science and Technology, you will ultimately learn that health, wellbeing, and spiritual bliss can be found right at your own doorstep.





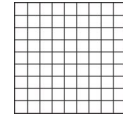
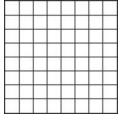

**Fabric of The Universe:  
The Origins, Implications, and Applications of Vastu Science and  
Vaastu Science and Technology**



*By this scripture is established the wellbeing and  
happiness of all the worlds; the attainment of all the  
four goals of human life is possible through the study  
and application of this work.*

Vishwakarma Vaastu Shastra 2:30

**Chapter 1  
Introduction**

In a small and obscure red-rock canyon in southern AZ called Aztec Canyon, you can find a little metal-roofed square building, which measures about 10'. x/32" by 10'. x/32 " by 10'. x/32" in size, sitting amongst a forest of old black oak trees that are native to that land. (The mathematics are precise but not offered here because they are part of the ancient Vaastu Rahasya – secret of Vaastu – and can only be given by a Sthapati or his or her direct representative.) The meditation room or Dhyana Garbha, as it is called, was built in the summer of 2010 by students from around the world who were studying an ancient building science called Mayonic Science and Technology, Sthapatya Veda, or, more popularly, Vaastu. Its construction was part of a 2 year program to become a certified Vaastu Consultant through the American University of Mayonic Science and Technology [www.aumscience.com](http://www.aumscience.com).

People who visit this building notice that it is simple, elegant, and precisely built to 1/16<sup>th</sup> of an inch or better. More than that, they notice that there is an inexplicable *feel* to it that immediately brings a sense of peace, happiness, and what some have called spiritual bliss. No matter what your mood might be upon entering this special building, you will feel elevated and at peace. It is an unmistakable feeling that has been scientifically verified through research conducted in this and similar buildings using state-of-the-art equipment that measures something called heart coherence [www.heartmath.com](http://www.heartmath.com).

Heart coherence (the relative stability of the heartbeat with more or less variability) has been demonstrated to indicate the level of stress in an individual and the subsequent state of his or her body, brain, emotions, and consciousness. High heart coherence (low



heart rate variability) indicates a peaceful, blissful, connected state, and low coherence indicates a restless stressed state with all of the biochemistry associated with that state. There are indications that heart coherence may be a more profound indicator of higher states of consciousness than research in brain-wave patterns. Put simply, scientists are finding that the brain is not the commander – the mind of the heart is in fact the one who runs the show.

When one *expects* to feel something often they do – real or not. Science helps eliminate the collusion that happens so often in this age of crystals, chanting, and tarot cards. We now know that buildings such as these have an authentic and unmistakable positive affect on people. In the research that was conducted (Mercaj and Hoffman, January and July 2010), individuals were measured before and during exposure to such a building (including this one). The results were clear – the subjects demonstrated a significant increase in heart coherence while being in these buildings. Their heart coherence doubled in every case. Subjectively, they noted an increase in happiness, wellbeing, peacefulness, and that subtle illuminating experience called spiritual bliss.

I remember taking an unsuspecting electrician into one of these small buildings a few years ago when I was building such a house and Dhyana Garbha for a family in New Mexico. He knew nothing about what I was doing. When he entered the Dhyana Garbha he said, “Wow I almost feel dizzy – it feels really good in here.” His words faded off as he stood blissfully in the Temple of Space Science, as Dr. V. Ganapati Sthapati calls them.

On the same site, the county building inspector who came to inspect the much larger house being built on the same property using the same ancient principles turned around one day and said, “I don’t know what it is about this house – it looks like any other house – but there is something special going on here.”

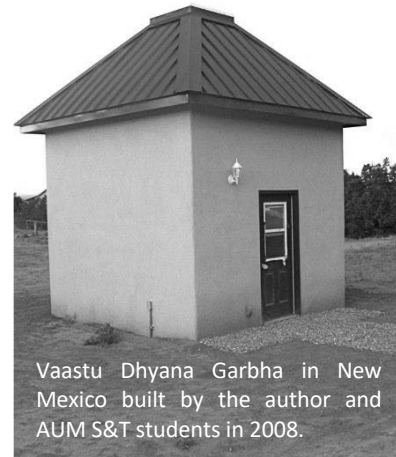

The affect of these buildings built using principles from ancient texts called Vaastu Shastras and Agamas is so great that the eighteen enlightened Siddhas (18 Siddhars) of India are known to have become enlightened at various buildings such as these in South India. For example, the great seer Pantanjali, who wrote *The Yoga Sutras*, became enlightened at Rameswara Temple and was also influenced by Chidambaram – both Vaastu temples in Tamil Nadu, India. Thirumular, the enlightened sage and author of *Thirumaintiram*, became enlightened at Chidambaram. The modern saint Maharishi Ramana spent days and nights for months at Thiruvanamallai temple prior to his enlightenment. And, in India, when people are so ill that the doctors cannot treat them, they are sent to one of these buildings to stay until they get well – and they do for the most part.

How is it that a building can create an identifiable change in the physiology and experience of an individual? We know that there are buildings that make us feel good and buildings that we can't wait to get out of, but how is it that these particular buildings have a repeatable and testable effect on people? There is an answer to these questions, and that is what this book is about.



This is a Vaastu house and garage built with precision by Dr. Jessie Mercay in New Mexico. It is a modified New Mexico Territorial style. Vaastu Architect Betsy Pierce (AUM S&T student at the time) drafted the plans under the supervision of the author. Most styles of architecture can be adapted to Vaastu. Vaastu homes range from very simple forms (above) to complex mansions.



Aztec Canyon Dhyana Garbha mentioned in this introduction. Wall material is made of an eco board called Comfort Board. It is a fireproof and breathable material made of magnesium oxide (Mgo) and hemp fibers. The inside walls and ceiling are also Comfort Board with a pyramidal interior ceiling. This form in one's backyard will serve to bring pure Vaastu energy to one's home setting. The feeling is almost indescribably peaceful and fulfilling. Most traditional building materials may be used to enclose space for Vaastu Architecture. This is the fundamental form and size of the magnificent Temples of India. Every home would benefit from one of these – even smaller than this would be an amazing addition to any family home site.



This is a more traditional-looking home Dhyana Garbha built (summer and fall 2011) by AUM S&T students, which was supervised by Dr. Jessie Mercay and built with former AUM S&T student, Certified Vaastu Builder, Ken Hoffman in Patagonia, AZ. (Sponsored by Jackie and Ed Fleeder.) The vibrancy of these buildings is significant and rivals any other existing Vaastu buildings. These are also available for homeowners who have space on their plot.



Vaastu house and Dhayana Garbha at my family ranch in Alamos, Sonora, MX

## Chapter 2 The Force that Lives Eternally

*The spiritual culture of the land of India owes its origin to the traditional Indian science of Vaastu Shastra found abundantly reflected in the architectural and sculptural expressions of temples, forts, palaces, town and city layout of ancient India. Today it is re-emerging spectacularly and the benefits of this spiritual science are availed throughout the world, by its application in the design and construction of public, residential and religious buildings. This science deals with the eternal process of the subtle energy manifesting into material space or material form. In short, it is the science of manifestation of energy into matter or material form. (Dr. V. Ganapati Sthapati, www.vastuved.com)*

*Vastu* and *Vaastu* are terms that are enjoying world-wide notoriety; however, there are many misconceptions and distortions about the real meaning *Vastu* and *Vaastu* and the bona fide practice of *Vaastu* and *Sthapatya Veda*. *Vaastu* is erroneously thought of as a kind of East Indian Feng Shui. *Sthapatya Veda* is often misunderstood due to improper translation of texts and misunderstanding of technical language. Well-meaning *Vastu* or *Vaastu consultants* are attempting to help improve living spaces by moving furniture and using yantras, mandalas, crystals, mirrors, and any number of so-called *Vastu correction devices*. In some cases, people are told to place what is called the *Vastu Purusha Mandala* on their wall, and they will feel much better in their home. While they may be attractive and aesthetically pleasing, none of these "remedies" are in fact legitimate corrections for "faulty" *Vastu*. The fact is, the all-too-frequent misuse of the word *Vastu* is indicative of a fundamental lack of understanding of the actual and unadulterated science and its meaning and execution as *Vaastu Technology*.

Authentic *Vastu*, as presented by Dr. V. Ganapati Sthapati – the preeminent world figure in *Vastu Science* and *Vaastu Science and Technology*, is a highly complex science that requires thoughtful study and precise execution as *Vaastu Technology*. It is a science born of knowledge of physics, mathematics, and other sciences. It involves comprehension of Space, Time, Light, Sound, the five elements, and an understanding of the dynamics of manifestation of energy from potential energy (Primal) to kinetic energy (matter or form). Finally, it requires the ability to apply this scientific knowledge to architecture, sculpture, poetry, dance, and music. Despite these essentials, anyone willing to put in a bit of effort can understand the basics of *Vastu Science* and its application in *Vaastu Science and Technology*.

This book defines *Vastu Science* and traces its origins and history. Rather than being a *how to* technical manual, it reveals and illuminates the mechanics of creation from intangible Absolute Space through the weaving of the fabric of creation to the emergence of the material world. There is a discussion of what is called *Vaastu Science* and

Technology that is the product of *Vastu* transforming itself into *Vaastu*. This discussion describes selected practical applications to building architecture.

### **What is Vastu Science?**

Yaskacarya wrote the oldest known Indian treatise on etymology, philology, and semantics sometime during 500 or 600 BCE. According to Yaskacarya, “Meaning is the fruit of the flower (which is) word.” Yaskacarya said, “[...] to really understand the meaning of a word you must understand its root components. Then and only then can you have a glimmer of the truth of a word.” Mayan, the first of the great Siddha lineage and first author of the *Vaastu Shastras*, said that the Tamil letters contain both OM Light and OM Sound – name and form. I have taken the liberty to analyze the words *Vastu* and *Vaastu* using these ideas in a way that has not been done before, at least in modern times. This analysis will provide not only the meaning of the words but also an experience of the essence of this amazing science and technology – a glimpse of the name and form.

The term *Vastu* (*Vastu Brahman* or *Vastu Purusha*) refers to primal, unmanifest, potential energy – Consciousness as energy. It is the energy through which and within which material forms manifest. Throughout history and among many cultures, this primal energy has been given many names. The names range from religious (God, Brahman) and artistic (Creative Intelligence) to scientific (the Unified Field). *Vastu* is that unmanifest, subtle or unseen, energy field that lives eternally. It is the Field within which the manifest world exists as particles and is ultimately governed.

*The Field is the sole governing agency of the particle.* Albert Einstein

*The free Space is the unified field of energy and matter and source of all forms that we see in material world.* Mayan in his *Aintiram*

An examination of the various Sanskrit and Tamil words, along with the meaning associated with the root “*vas*” and the combined word *Vastu* and *Vaastu*, sheds light on the comprehension of the true meaning of *Vastu Science* and *Vaastu Science and Technology*.

*Vas*: to shine; to grow bright, to bestow by shining upon, to cause to shine; to enter into, to dwell, becoming light, dawning, the seat or place of, an abiding substance or essence, the pith or substance of something, to cohabit with.

*Vaas*: to make fragrant or to perfume, an intoxicant, to be or make firm, dwelling place, to assume the appearance of, matter. (Cologne Lexicon)

*The word Vastu is formed of the root “vas.” “Vas” means to live or to exist. The precise meaning of Vastu is “to live eternally.”* (Dr. V. Ganapati, Sthapati, p.52 *Temples of Space-Science*, *Vaastu Vedic Research Foundation*, 1996.) Thus, *Vastu* is that energy of force that lives eternally. It is never ending and omnipresent.

In examining these definitions, we can see that *Vastu* is the seat of an abiding, shining, luminous substance or essence (the essence of life). It has a quality of growing brightness and is the pith or substance that enters into and cohabits with that in which it dwells and that which dwells within it. It is the source of the material world yet it cohabits with the material world as *Vaastu*. It does not separate itself from the material world. In fact, the material world (*Vaastu*) exists within the body of *Vastu*.

*Vaastu* is that which assumes the appearance of matter. It makes firm or gives concrete shape to the place where *it* dwells. It makes fragrant that in which it dwells. That fragrance is the intoxicating spiritual bliss experienced by people who live in or visit a *Vaastu* structure, listen to *Vaastu* music or poetry, or view *Vaastu* sculpture and dance. Here we are speaking of authentically created and executed forms of these arts based on the ancient Shastras.

*Vastu* Science is an ancient science that describes the process through which *Vastu* (unmanifest or subtle energy) turns itself into *Vaastu* (manifest forms and material). *Vastu* written with one “a” refers to unmanifest Absolute Space or Pure Consciousness. *Vastu* written with two “a’s” (*Vaastu*) refers to the unmanifest Absolute Space having taken on its material form – *Vaastu* Brahman. *Vastu* Science then is the science of unmanifest Pure Consciousness and *Vaastu* Science is the science of manifest Pure Consciousness (*Vastu* as the material world).

*Vastu* Science gives rise to *Vaastu* Science and Technology. That is, an understanding of *Vastu* Science – the manifestation process – provides the basis for understanding the use of *Vaastu* technology in the relative material world in what are called the five arts. In order to correctly apply the technological principles of *Vaastu*, one must understand *Vastu* Science before one can understand and execute *Vaastu* technology properly (the technology of applying certain laws of nature to building architecture, sculpture, dance, music, and poetry).

*This science deals with the eternal process of the subtle energy manifesting into material space or material form. In short, it is the science of manifestation of energy into matter or material form. (Dr. V. Ganapati Sthapati)*

In understanding the full meaning of this, we must first gain a perspective on the history and science of *Vastu* as it relates to its origin and processes. Only then can we understand the science and technology (application) of *Vaastu*.

There are many permutations of *Vastu* being practiced today. From the definition we have given, it can be seen that one does not practice *Vastu* – it is not something to be practiced, but rather it is a field of study to be understood. What is actually practicable is *Vaastu* – that is, the technology based on the process of *Vastureva Vaastu* – energy transforming itself into matter. Thus, the use of the word *Vastu* as a practice or



consultancy is incorrect – it is evidence of a misunderstanding of the word and the science. Throughout the world many individuals have undertaken the study and practice of *Vaastu* through use of incomplete, mistranslated, and partially correct books and teachings. Unfortunately, modern *Vaastu* has been diminished to the level of superstition. An authentic practitioner is a *Vaastu* practitioner and not a *Vastu* practitioner. What is practiced and applied in the material world is *Vaastu* not *Vastu*. The authentic *Vaastu* consultant does not use yantras, crystals, incense, mirrors, or any other devices to allegedly correct deficiencies in a home or office or any other building. While being completely sincere, most practitioners simply don't know *Vastu* or *Vaastu* in their purity, nor are they aware of the very simple aspects that render *Vastu* and *Vaastu* the most powerful sciences in the entire world. These two sciences are far more than mere smoke and mirrors.

*The depth of wisdom contained within the ancient science of Vaastu addresses the heart of the human experience: How do we live in harmony with our deepest Selves and express this harmony in the outer world? It is both deeply personal and profoundly universal. This knowledge is a journey into the heart of the Universal One and also satisfies even the most discerning logical mind. Truth is simple, needs no further explanation, and is never discovered, only remembered. It is time that each of us remembers the timeless path of Vaastu. There is nothing to loose but confusion. (Ivri Krzyz, Certified Vaastu Consultant, graduate of The American University of Mayonic Science and Technology.)*

In November 2003, the president of India, DR. A.P. J. Abdul Kaalam, became aware that the media and society in general had polluted the term *Vaastu*. He also became aware that ultimately this pollution would be harmful to society and individuals. He asked Dr. V. Ganapati Sthapati, the renowned traditional *Vaastu* architect, scientist, and artist, to change the name of *Vaastu*. Dr. Sthapati replied by saying that he would change the understanding. He did in fact change the name to Mayonic Science and Technology, although, he still refers to the terms *Vastu* and *Vaastu* in their correct context. To this day, he works tirelessly to educate the world about the truth of this great science. He even began a University in the Americas ([www.aumscience.com](http://www.aumscience.com)) to carry out his task of bringing the truth to light. He sanctioned the author to take on this task and promote this amazing science and art in the western world.

### **A Lost Science**

Authentic *Vastu* has been a lost science for centuries. *Vastu* is a deep and profound science that requires in-depth study under an individual authorized to teach by a Shilpi Guru. Over the past centuries, scribes and scholars did not (nor do they now) understand the detailed scientific texts or *Shastras* that are written in technical terms. These *Shastras* include knowledge and language of quantum physics, astrophysics, astronomy, nuclear physics, mathematics, building science, musicology, and more. Translation and comprehension have been attempted using *literary* Sanskrit and *literary* Tamil. The Rishi who cognized this science originally wrote the texts in technical Tamil. The original Sanskrit texts on *Vaastu Shastras* were also written in Technical Tamil and pre-Vedic or

Ancient Sanskrit – a language form replete with technical knowledge. Beyond that, there existed a language that is called Vedic language from which Sanskrit is derived.

The majority of the ancient texts of south India were actually written in ancient Technical Tamil - the forerunner of modern Tamil. Technical Sanskrit (Ancient Sanskrit) and Technical Tamil contained in the original texts were and are unknown to most translators; hence, the crucial scientific and mathematical aspects of Vastu and Vaastu were left out of the Vedic texts. In fact, much has been left out of more modern translations of Vaastu Shastras for the same reason.

For example, when Panini and others altered Ancient Sanskrit, several very important linguistic aspects were left out of what is called literary or Classical Sanskrit. One aspect of language left out is *pitch accent*. Ancient Sanskrit had a *pitch accent* that could change the meaning of the words and was still in use in Panini's time, as we can infer by his use of devices to indicate the pitch accent's position. At some later time, this was replaced by a stress accent limited to the second to fourth syllables from the end. This changed the frequency of words.

A second important change is that the vowels **e** and **o** were actually realized in Ancient Sanskrit as *diphthongs* /ai/ and /au/, but they became pure *monophthongs* /e:/ and /o:/ in Classical Sanskrit. This change altered the way that a word was pronounced and sounded – thus the frequency. A *diphthong* is a unitary vowel that changes *quality* during its pronunciation. It "glides" with a smooth movement of the tongue from one articulation to another, as in the English words *eye*, *boy*, and *cow*. This contrasts with "pure" vowels, or *monophthongs*, where the tongue is held still, as in the English word *papa*. (<http://wikipedia.org>)

A third and important factor is that in Classical Sanskrit texts such as the Rig Veda, the meter of the text is not in its original state. Recent scholars have re-metered the Rig Veda. This changes the quality and rhythm of the sound as it is being pronounced, which returns it to its original meter, resulting in a deeper experience for the listener. (*Rig Veda. A Metrically Restored Text with an Introduction and Notes*. Edited by Barend A. Van Nooten and Gary B. Holland. Harvard University Press, 1994.)

An advanced study of Mayonic Science reveals that meter, tone, and pitch are very important in bringing about a vibrational experience of the language causing an arousal of spiritual bliss in the listener. This effect is missing from Classical Sanskrit to a great extent. This concept has to do, in part, with something called *Sruti*. *Sruti* refers to revealed Cosmic or Divine Knowledge. In Vaastu music (ancient traditional Indian music), there are 22 points along the octave scale that are called *srutis*. These are points between the notes of the scale that, when held by the musician or sung by the vocalist, create a frequency that promotes the experience of Divine or Cosmic Knowledge – in simple words, spiritual bliss and happiness. They are very subtle and refined positions along the scale and can only be properly located by a conscious and experienced musician or well-



trained vocalist – a Rishi musician. For example, these points are often reached by the musician sliding his or her finger along the space between the frets of the sitar or by a vocalist sliding his or her voice along the scale in a facile manner, striking very subtle and precise points. In a similar way, we could say that there are *linguistic srutis* – that is, inflections in the voice, the gliding of a word over the tongue, certain kinds of rhythms and meters that promote spiritual bliss in the listener. These *srutis* have been lost due to the change from Ancient to Classical Sanskrit.

Unfortunately, the Sthapatis and Shilpis who knew the technical language were not asked to assist with translations; rather, literary scholars attempted to understand the literature in this field with no understanding of the scientific and technical terminology. Interestingly enough, in ancient times when the first Veda poured forth from the mouth of an ancient Rishi, it was understood that an architect must be trained in music and other arts; a musician must be trained in mathematics and several of the five arts discussed later. It was accepted that there must be a full understanding of this science throughout the arts, and each artist must be cross-trained to be effective in his or her own art. The way to truly understand the arts was to understand several arts and the science behind all of the arts – the science behind life itself.

Traditional Sthapatis (architects) and Shilpis (sculptors) who come from the ancient traditions become proficient in several of the arts. In addition, they study Sanskrit and Tamil. The Tamil language of South India has recently been accepted nationally as a classical language as ancient as Sanskrit.



Because of the efforts of Dr. V. Ganapati Sthapati, the eminent architect, sculptor, writer, and teacher, the ancient science and art of Vastu and Vaastu are being revived in their completeness. Without the scientific and mathematical technologies contained in the original texts and the practical applications used by the Sthapatis and Shilpis, all that remained was superstition and partial truth.

Photo above by Michael Borden: Dr. V. Ganapati Sthapati and Perumal Sthapati marking the stone carving of the head of Thiruvalluvar (an ancient Tamil poet), a statue that stands 133 feet high off the coast of Tamil Nadu on the southernmost tip of India where the Bay of Bengal meets the Arabian Sea.

### **Our Link to the Ancient Past**

Dr. V. Ganapati Sthapati is our direct link to the ancient past. He was a practicing traditional architect/designer, builder, sculptor, writer, and teacher born of the aboriginal creative tribe of India – Vishwakarma. He was a Vishwabrahmin, and his genealogy can

be traced as far back as 1050 years with an understanding that his ancient ancestors beyond that time were also Sthapatis (an honored title for a person who is all-inclusively an architect, builder, sculptor, and scholar). Excellence and fame has followed his family through the ages. He has been given numerous awards from State to National levels. His most recent award was a designation of Padma Bushan by the government of India. Among his many other distinctions, he is designated as Shilpi Guru of India – highly esteemed teacher of this body of knowledge. He was the only living Shilpi Guru in the 20<sup>th</sup> and 21<sup>st</sup> centuries. This tribe, Vishwakarmas or Vishwabrahmins, has owned a unique body of technical literature called Vaastu Shastras, Sthapatya Veda, Pranava Veda, and Aintiram for about 12,000 years. Within these texts are enshrined a science and technology that reveals two substances known as Vastu and Vaastu. Vastu is unmanifest subtle energy and Vaastu is gross energy as seen as the material world. These are depicted in Einstein's equation  $E=mc^2$ .

This entire body of knowledge is recognized as Mayonic Science and Technology, Vaastu Veda or Sthapatya Veda. Also rooted in this knowledge base is the Agamic literature. In his Srimat Bhagavatam Veda Vyasa, the compiler of the Vedas mentions Sthapatya Veda. Vyasa mentions that Sthapatya Veda is to be held as one of the Vedas *apart from* Rig (Rik), Yajur, Sama, and Atharva Veda.

“ऋग्यजुः सामाथर्वारव्यान् वेदान् पूर्वादिभिर्मुखैः ।  
शास्त्रमिज्यां स्तुतिस्तोमं प्रायाश्चित्तं व्यधात्क्रमात् ॥  
आयुर्वेदं धनुर्वेदं गान्धर्व वेदमात्मनः ।  
स्थापत्यं चासृजद् वेदं क्रमात्पूर्वादिभिर्मुखैः ॥  
इतिहास पुराणानि पञ्चमं वेदमीश्वरः ।  
सर्वेभ्य एव वक्त्रेभ्यः ससृजे सर्वदर्शनः ॥” - (Yelopakhyanam)

*This Sthapatya Veda has been in force from very ancient times in the name of Vaastu Shastras.*

While at one time the Shilpis of Bharat had regional names for their clans, today they are united under a national association called *Akhila Bharata Vishwakarma Mahajanasabha*. In past centuries these clan members thrived, as the entire culture depended on the products of these artisans. They too created everything from cities to jewelry, pots and pans, and even home furnishings – all done in a specific mathematical order designed to bring peace to the owner. Today, many of their functions have been taken over by pseudo Vaastu consultants who know little of the authentic tradition.

In addition to the traditional building and manufacturing arts, under the umbrella of Vaastu Science falls the Five-Fold Science: Poetry, Music, Dance, Sculpture, and Architecture, which correspond with the traditional science of Iyal, Isai, Natam, Kattidam, and Sirpam in the Tamil tradition. In Sanskrit, they are called Sabda Veda, Gandharve Veda, Natya Veda, Sthapatya Veda, and Pranava Veda. They are all governed by a unique grammar of the science of Energy and Matter, Space and Time, and Rhythm and Form.

The fundamental nature of these elements is revealed in the ancient text, the Pranava Veda. This is none other than the science of manifestation. That is, the science of how the Infinite Energy (Vastu) transforms itself into matter or form (Vaastu).

Veda Vyasa in his Bhagvatam mentions the Pranava Veda:

“एक एव पुरा वेदो प्रणवः सर्ववाङ्मयः । देवो नारायणो  
नान्य एकोऽभिर्वर्ण एव च ॥”.

This is paraphrased as: *In the ancient past there existed only one Veda, and it was called the Pranava Veda.*

During the time of the Pranava Veda, India was united as one great country whose borders spanned to Persia, Afghanistan, Nepal, and into Cambodia and the Far East. There was no caste or division by religion or color. This Unity also reached to Kumari Continent, which once existed in the South Ocean below India but was deluged by water from the melting icecaps (circa 10,000 BCE). This fact has been revealed in the Bhagavatam, Sankalpa, Saivagama, and other sources.

The literature that supports the body of knowledge in the Vishwakarma tradition is vast. In India, there were more than 70 Shastras held by the Shilpis. In addition, there are over 15 Shastras written by the ancient Rishi Mayan, who was the progenitor of this entire body of knowledge, including the previously mentioned Pranava Veda, Aintiram, Suryasidhantam, and Mayamatam.

The technical material found in this vast body of literature can also be found in epics, puranas, and throughout the body of literature called the Vedas. References to the scientific, technical, and spiritual aspects of this knowledge can be found throughout the Vedas. Once the foundational knowledge from the Pranava Veda and Aintiram is understood, then the normally difficult-to-understand Rig (Rik) Veda becomes well-understood and profoundly significant.

Chapter 17 in Dr. V. Ganapati Sthapatis' text, *Building Architecture of Sthapatya Veda*, discusses the Upanishads that are left out of the usual list of Upanishads: *Apart from the 108 Upanishads, there are non-listed ones that reveal the most basic and subtle principles of cosmic science and cosmic structure, principles not revealed in other Upanishads.*

*Shilpa Vidya Rahasyopanishad (one of the non-listed Upanishads) brings out the potency of the cosmic science known as Shilpa. Vaastu Sutropanishad refers to the metaphysical question of the origin of form and its importance for the attainment of spiritual realization or "moksha." This Upanishad throws light on the basic conceptions and practice underlying sacred art.*

These Upanishads, if studied and understood, provide a deepened understanding of the other Vedas. According to Dr. S. P. Sabharathnam, the Vedas are to be studied and properly understood by those whose minds have first been illumined and perfected by the systematic study of Agamas and Vaastu scriptures.

He mentions that while an Agamic or Vastu scholar could easily understand that the first Mantra of the Rig Veda speaks of the five concentric belts of cosmic structure, no existing commentaries and translations of the Rig Veda offer any reference to the implication of the five belts of cosmic structure (as described in this text).

This knowledge is revitalized through the Grace of God by the efforts of Dr. V. Ganapati Sthapati. He is our root – our moolam.

### The Big Thaw and the Dispersion of Humanity

In 15,000 BCE, the earth was a cold planet – an ice-making machine. The planet was in its fifth ice age. The glacial maximum (coldest period with maximum icecaps and lowest sea level) had occurred 2000 – 3000 years earlier. The world was colder and dryer and far less hospitable than today. The enormous ice sheets held massive amounts of water, lowering sea levels. The world's oceans were more than 460-feet lower than what they are today. This resulted in exposure of continental shelves, joined landmasses, and extensive coastal plains. (Fleming, et. al. 1998) "Refining the eustatic sea-level curve since the Last Glacial Maximum using far- and intermediate-field sites." (*Earth and Planetary Science Letters* **163** (1-4): 327-342)

The geography of the earth was significantly different from the present day, and humanity lived primarily in a small, concentrated area of the earth called the equatorial belt. The map below shows the earth as it may have looked in 15,000 BCE. The land area between the two grey horizontal lines represents the equatorial belt, and the grey area in the center (circled) is a landmass that existed 17,000 years ago.

This continent was the most suitable landmass to support human civilization because it possessed tropical rain forest and an abundance of resources and wildlife, making it the Eden of the ancient world. Some call this lost continent Oceania, but it was called Kumari Continent or Kumaria according to the ancient literature of Tamil Nadu, South India. It is said, in the ancient literature, that it was here that the earth's climate was conducive to support large, agricultural-based populations. This is where some scholars believe that the cradle of human civilization flourished, and it is here that humanity developed a highly sophisticated society, perhaps comparable to our own in many ways.

The areas of the uppermost and lower parts of the map in dark grey represent enormous glaciers that were as high as the Rocky Mountains and covered large portions of the world's landmasses. The areas in light grey were tundra, which supported very little vegetation and sparse life. The earth was a cold, dry planet, and these areas lacked warmth, rainfall, and moisture.

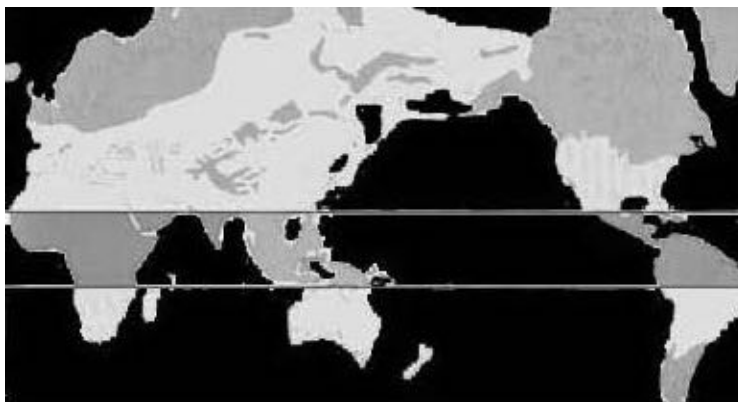

The darkest grey color within the equatorial belt (what is now Central Africa and Central America and Northern South America) represents areas of the earth that supported plant and animal life. Some of these areas were desert and these large land masses were colder in temperature than

Oceania, due to warmer ocean currents. Humans most likely lived in these areas, but most

of these areas were not conducive to support large populations that could develop agriculture and civilizations.

Around 15,000 BCE, the ice sheets stopped advancing, and the earth began to warm slowly. Around 12,000 BCE, an unknown geological or cosmic event triggered a sudden spectacular thawing of the earth – a mass global warming. The enormous glaciers that covered most of the earth quickly melted, filling the oceans with water and causing ocean encroachment into the low-lying coastal areas where much of human population existed. Within a relatively short span of time, the melting waters from the glaciers rapidly elevated the sea levels and submerged enormous landmasses, including much of Kumari Continent, reshaping the geography and the living space of humanity.

The rapid thawing of the earth and the receding Ice Age were cataclysmic. Tidal waves of massive proportions swept the shorelines of ancient earth and consumed them beneath the rapidly rising oceans. Along with these events, the global warming caused extensive evaporation, which then caused extended monsoons that inundated the land with flooding. Entire continents of land submerged beneath the rising oceans and gigantic, long-lasting, super-hurricane-force storms and monsoons swept the planet's surface.

Because of the gigantic loss of landmass, groups of inhabitants from Kumari Continent migrated from their homelands to other habitable places on the earth. These groups may have been the legendary, 12 lost tribes. Some researchers believe that the native language of these people was an ancient form of Tamil.

The map to your right is a close-up of what Kumari Continent might have looked like before the global warming. The grey colors are what is now the shoreline of Indonesia, Philippines, India - the countries that currently exist as islands and continents. They are the Asian continent, and countries in the ocean. The green colored areas are what might have been Kumari. It is estimated that this landmass that united what is today Western Indonesia and the Philippines to the mainland of South East Asia, China, and Australia was over 1.7 million square kilometers in size.

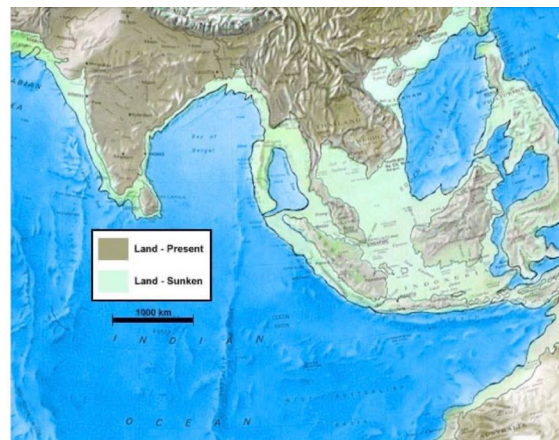

This enormous landmass had a large, inland, freshwater sea and apparently several smaller ones that might have supported a human population of millions. Kumaria was a continent that existed for well over 30,000 years. This fact is substantiated by the changes in the ocean depths that remained low during that time – which, since then, has risen 400 feet. The big thaw and the rapidly rising sea levels reduced Kumaria from 1.7 million square kilometers to less than 1 million square kilometers and increased coastlines more

than threefold. The interior of Kumaria and the coastal areas where the heaviest concentrations of human population were located simply vanished beneath the sea. Traces of these ancient civilizations are being found off the coast of India, Japan, and other areas around the world.

The idea that there was an advanced, Ice-Age civilization is well founded. One clear example of such a civilization, existing 35,000 to 12,000 years ago, is found in Fukui Cave of Northern Kyushu Island, the southwestern island of Japan, in the form of Jomon pottery containers. These have been dated as slightly later than 12,750 +/- 500 years old, and therefore coincide with the end of the advancing ice sheets and the increased global warming about 11,600 years ago. (Joseph B. Lambert, *Traces of the Past*, 1997) The Jomon pottery most likely was taken to Fukui Cave of Kyushu by Jomon people of the Ice Age civilization when they fled the flooding of the surrounding lowlands during the worldwide deluge caused by melting icecaps and related monsoons around 11,600 – 12,000 years ago.

These pottery containers were closed containers in which vegetables and fish could be steamed. This concept of steaming food is a relatively advanced concept, as are the pottery containers.

Many stories of a lost continent and a lost civilization can be found in the folklore and writings of the ancient people. In *Timaeus and Critias*, Plato wrote the story of Atlantis, a lost civilization that sank beneath the oceans. Ancient legends around the world tell of a great flood that swept the world thousands of years ago. Modern science has shown, through the analysis of the earth's ice caps and ocean levels, that the earth experienced a great flood of cataclysmic proportions during 11,000 - 10,000 BCE.

Current archaeological theories state that before 10,000 BCE no early human civilizations developed agriculture or built great empires. Modern archeology further states that during the Paleolithic age humans were hunters and gathers that lived a subsistence level comparable to the Neanderthal man.

Ancient literature of Tamil Nadu states differently. According to these texts and contrary to general thought, a highly developed civilization existed during the Ice Age periods in the equatorial belt on Kumari Continent and in other places around the globe.

The existence of music and musical instruments is a sign of a somewhat advanced culture.



In China, the Institute of Cultural Relics and Archaeology of Henan Province, Zhengzhou, Henan, China, holds a number of ancient flutes carbon dated to be over 9,000 years old. These flutes are tuned very closely to modern pitch and have been exactly replicated to playable instruments.

In the Indus Valley, numerous sophisticated carpenters tools were found as well as advanced indoor water systems and architectural forms. These date as far back as 9,000 BCE. The civilizations of that day were not as primitive in some parts of the world as previously thought.

As mentioned earlier, ancient Tamil texts say that there was a great migration from Kumari Continent around the globe between 10,000 and 11,000 BCE due to its being engulfed by the rising oceans. Certainly the sophistication of that society provided the means for such a mass migration. One of the individuals who migrated to the Indian mainland was an enlightened sage named Brahmarishi Mayan. It is this Rishi who cognized the Science and Art that is the subject of this book.





### Chapter 3 The Progenitor of Vastu



Mamuni Mayan by Dr. V Ganapati Sthapati

A great scientist/artist named Mamuni Mayan (circa 10,000 BCE) originated this ancient work, Vastu Science and Vaastu Science and Technology. Mayan lived on a landmass south of India, south of the present Kanyakumari, known as Kumari Continent. This landmass was called Kumari Mandalam during Sangam days (a period of time in ancient history when scientists and scholars met and shared their ideas, literature, music, art, and scientific discoveries), and today it is known as the Lumerian Continent. This is thought to be the original home of the human race and human culture according to ancient Tamil texts.

According to Tamil tradition – carried on through his disciples and the Vishwakarmas – Mayan’s father’s name was Thamarai (Lotus), and his mother’s name was Karung Kulazli (beautiful lady with long hair). This information is found in a Tamil text called Sirpa Chennool. Mayan’s daughter was Mandodari (flat bellied) the wife of Ravana – found in many texts. Two of his son’s names were Maayavi and Dunthibi. Mayan is said to have had a number of wives. While this might have been custom, it was also because, in order to propagate his work, he traveled a great deal.

As mentioned earlier, due to a series of land disturbances, including ocean water encroachments from melting icecaps and deluges, the continent became a series of islands and other landmasses separated by the ocean. One large island called Jamboo Dweepa was the home of Mamuni Mayan. Just before the last great deluge (perhaps the Biblical flood of Noah) that covered Jamboo Dweepa with water, Mayan migrated to Southern India.

An interesting note is that in South India, Tamil Nadu, there is a small remote village called Thiruvelliyankudi that has preserved a temple site and the legend that Mayan built the first shrine there way beyond 5,000 years ago, according to the villagers. A Vishnu temple was built on the site. Next to the Vishnu temple is a beautiful, old Siva temple. There is great significance that the two exist together. Mayan coined the concept of Shiva and Vishnu. He says that Shiva is Vastu and Vishnu is Vaastu. While they are thought to be names of gods, they are actually technical scientific terms that refer to the

transformation of energy (Vastu) to matter (Vaastu). In the Vishnu temple sanctum, there was a statue that the villagers said was Mayan. Brahmin priests removed the statue last year (an act that is only supposed to be done by a Sthapati, according to Agama).

During that ancient time, Mayan established Vastu and Vaastu as a dynamic science and technology. His work covered numerous areas, including architecture, sculpture, dance, music, astronomy, herbology, cartography, ship building, and other arts and sciences. At the request of the former President of India, to give credit to the progenitor, Mayan, and to differentiate this science from incomplete misappropriated forms of Vastu that predominate in this and recent centuries, we call this entire field of study Mayonic Science and Technology.

A highly respected ancient Tamil text called Vaisampayana, describes the life of Mayan. Mayan lived in a forest of banyan trees. He wore long, matted hair and sat under a banyan tree where he taught his 12 special Rishi students. He spoke of the science and technology of Vaastu and Vastu. Over time, more disciples sat with him until the student body grew large. He was held as the Supreme Silpa Guru. He became known far and wide as “*Alamar Selvan*” – *the chosen Guru seated under a banyan tree*.

The esteemed *Vaisampayana* states:

*Since the grace – gilding Mayan occupied his seat under the banyan tree, since the unique science of Vaastu flourished and got propagated from the bottom of the banyan tree through Mayan, since the disciples deeply interested in gaining knowledge, grew large in number, holy temples (seats of learning) were constructed in each town for the study and growth of Vaastu Science and wisdom.*

The form of Mayan, according to tradition, is installed in Shiva temples and early Vishnu temples, seated in this way under a banyan tree, at temples throughout India. He is called Dakshinamurthi. Mayan is memorialized at these temples as Guru Murtha (the form of Supreme Master), and he faces South, from whence he came. Even today, Mayan is worshipped as “Supreme Guru” by enlightened persons. The knowledge of this has been lost to the public but has been maintained by the esteemed Vishwabrahmin Dr. V. Ganapati Sthapati, who is actively building a Mayan Memorial in Mahabalipuram, Tamil Nadu, India.

At one point in history, many cultures based their architecture, art, herbology, astronomy, etc. on Mayonic Science and Technology. In addition to the East Indian culture, cultures of China, Tibet, Mexico, and Central and Southern Americas used Mayonic Science and Technology as the basis of their culture. We see evidence of this in the precise mathematical Vaastu formulas and Vaastu building science evident in the many Maayan structures existing today in Mexico and Central America, as well as structures in China,

Bosnia, Egypt, Japan, the southern US, and in other parts of the world. The Aztec ruins in Mexico and the Incan ruins in Machu Picchu, Peru also demonstrate Mayonic measure and order. Recent discoveries in Peru have identified what appear to be pre-Incan Mayonic structures. King Solomon's temple is clearly a Mayonic structure and its architect King Hiram was a Sthapati trained in this science. It is a known fact that a number of kings were of the traditional clans of Sthapatis' (traditional builders). One well-known Vaastu Shastra – the Samaranga Sutradhara – was written by a king (Boja Deva).

One of those cultures even adopted the name Mayan – the Maayan culture of Mexico and Central America. The name Mayan is derived from Tamil – the language of South India and the language in which the original Vastu/Vaastu texts are written. Dr. V. Ganapati Sthapati visited Maya land and verified that the architectural principles of the Maayan temples were exactly the same as in Mayonic Science. In addition, he found numerous Tamil words that were too similar to be coincidental. This is dealt with in advanced textbooks and studies in Mayonic Science and Technology.

According to Hunbatz Men – elder leader of Maayan people of South, Central, and North America – the Maya state that thousands of years ago, *the sacred teachings from the cosmos were deposited in many magnetic centers throughout the world:*

Chan Chan (Peru), Huete (Spain), Tulle (France), Hu-nan (China), Bethlehem (Israel), Tih (Egypt), Mississippi (United States), Humac (Brazil), Nagasaki (Japan), Mul (England), Maya (Russia), Naga (India), and Chukotz (Bering Strait) are all words associated with both the Maayan culture and Tamil culture.

There are numerous Hebrew words that are similar or the same as Tamil words. Scholars have indicated that these language similarities originated from Tamil land. That is, Hebrew has its basis in Tamil. One such word is Ma'ayan. In Hebrew, the word "ma'ayan" means spring, fountain, wellspring, as in wellspring of knowledge. A women's poetry group with this name exists even today. Interestingly enough, Mayan was a great poet.

The names of all these places are of Tamil/Maya origin, which indicates that, in different periods of time, there was a Mayonic presence in these places. Ancient Tamil literature confirms that Mayan and or his 12 main disciples traveled the world. It would make sense that when he sent them out to teach this knowledge, they would go to places around the world where there were people who spoke their language – the clans who left Kumari Continent and spread throughout the world. It is possible that that is what brought Mayan and his Rishi students to other parts of the world to teach.

Mayan was an individual who had the depth and clarity of perception to understand the physics of manifestation of Pure Consciousness (Absolute Space) from its unmanifest state (Vastu) to its manifest state (Vaastu). Through precise mathematical formulas, Mayan was able to recreate the process of Pure Consciousness (Absolute Space) becoming conscious and awakened in structures such as buildings, temples, statues,

dance, music, and other forms of expression. Structures created in this way became “live” or living structures. One might say that through the knowledge of *consciousness becoming conscious*, life was breathed into forms and structures.

In addition, through precise mathematical formulas, Mayan was able to create structures that were not only alive with Pure Consciousness but also resonated specifically to the individual resonance of any given human being. Thus, the human being had direct and immediate contact/resonance with Pure Consciousness, making the individual more alive and vibrant “*just as life is within the space boundaries of our flesh and skin.*” (oral commentary by Dr. V. Ganapati Sthapati)

Dr V. Ganapati Sthapati writes:

*Mayan the architect and town planner of India and the progenitor of Vaastu Shastra lived in the southern part of the Indian sub-continent, known as Kumari Mandalam (Lumerian Continent), some ten to fifteen thousand years ago. He is the author of Mayamata Vastu Shastra and Surya Siddhanta, the two great works, which are still alive, being used by scholars and practitioners, all over India. They have revolutionized the erstwhile material culture of India into a spiritual one, and today they are known worldwide and admired for the rich scientific material they contain.*

*References about him are found in our epics Ramayanam and Mahabharatam. In Mahabharatam, he is found to have been introduced by Veda Vyasa to Aruba as Vishwakarma – “ahamhi Vishwakarma vai dana vanam mahakavi – I am the Vishwakarma (the creator) and the great poet of the Danava clan.” It shows that he was adored as the poet of Danavas and as Vishwakarma, implying thereby that Mayan was aware of the dynamics of the Space and was able to apply the space-mechanism in his own creations and transform them to little universes on earth. Whatever be the creation, a building, a sculpture, a town or a city, they behaved like living organisms pulsating with life. Hence he was rightly called Vishwakarma of the material world or sometimes as the Vishwakarma of the celestial world. No scientist of his caliber or status is found to have emerged in the soil of Bharat to date.*

*In Ramayana, Maharishi Valmiki extols him as highly enlightened and endowed with super human intelligence and talents. In the words of Sage Valmiki, Mayan was ‘mahatejaswi’ and ‘maayaavi’. ‘Mayonaama mahaateja maayaavi vaanarishabha.’*

*Another authority that introduces Mayan to the later-day Shilpins is Prince Elango of Kerala, in his historical epic ‘Silappathikaaram’, as a tradition builder. He has also authored the most ancient and scientific treatise on*

*Astronomy titled 'Surya Siddhanta'. As scholars have pointed out, it is he who has painted a comprehensive but succinct picture of Brahman, the Ultimate and Absolute, addressed as Kaala Brahman by Mayan himself. This particular identification of Time as Brahman has earned him a significant title 'Kaalajnani' (one who has recognized that Time is the causal element of the universe and universal objects – visual and aural forms). It is he who has equated Time and Space and evolved a system of spiritual arts namely poetry, music, dance, architecture, and sculpture – all governed by the principle of energy vibrating into space and spatial form.*

*There is another treatise carrying his name, called Mayamatam, where we have the principles of Vastu and Vaastu, rendered in the pattern of a technological treatise, followed by the Shilpis across the length and breadth of India.*

*Another notable discovery made recently is that he was the author of Pranava Veda, the primal and most significant of all Vedas, which is referred in Bhagavata Mahapurana as 'eka eva pura vedah pranava sarva vangmayah', whereby, Veda Vyasa confirms the existence of the one and only Veda in the very remote past. Evidence shows that it originated in the Kumari Continent, Mayan being the author. The text in technical Tamil, as the Siddha literature of the Tamils, is getting printed and likely to see the light of day before long.*

*There is already a Tamil text of Mayan called AINTIRAM, published by the Directorate of Technical Education, Govt. of Tamil Nadu, India. It is actually another version of Pranava Veda in sutra form. Later-day scholars called this Aintira Vyakarana. This appears to have served as a 'source book' for later day grammar of Indian languages. ([www.Vastuved.com](http://www.Vastuved.com))*

Among his great achievements, Mayan identified the structure of infinite and finite energy particles. Mayan defined the vibration of inner space and outer space as quantifiable and was able to identify the structure of energy particles and an order in the development of forms of matter. He described Absolute Time and used mathematics to define frequency and vibration.



**Brahmarishi Mayan**

अचिन्त्य अव्यक्त रूपाय निर्गुणाय गुणात्मने ।  
समस्त जगदाधार मूर्तये ब्रह्मणेनमः ॥ -मयः

பரம்பொருள் எங்கும் உண்டு பெருங்கலை யாண்டும் உண்டு  
பரம்பொருள் உணர்வினாலே ஒளி வழிபாடு கண்டேன்  
பரம்பொருள் அருளினாலே திருநடராசன் கண்டேன்  
பரம்பொருள் அருளினாலே மாக்கலை படைத்தேன் காண்பீர்

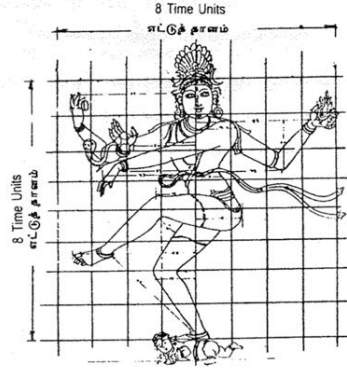

**VAASTU PURUSHA MANDALA  
ENERGY - GRID**

"Absolute Time creates life"

"Mathematics has its roots in Time"

"The vibrating element called 'Time' causes this phenomenon"

From Building Architecture of Sthapatya Veda by Dr. V. Ganapati Sthapati

In the above mandala, Shiva, or Nataraja, represents the scientific principle of vibrating pure energy and depicts frequency in the Absolute Space/Time continuum. The form is both male and female with the left side and upturned foot being the female aspect of creation – Shakti. The dwarf is constrained Time. This will be discussed in more detail later.

Mayan states:

*There exists an order in the Universe – subtle universe and material universe. This power is attributed to the consciousness of the cosmic space as well as of the inner space of the animate beings. This consciousness, by its personal effort to express its own inner feelings, causes a kind of*

*vibration or pulsation in the inner space, resulting in energy-grids. The vibration or pulsation, being the causal element of all these events, is called Kaala. This is actually the force of energy aroused by the inner consciousness, causing waves and contributing to the growth of living forms. This Kaala resides in all living beings. So, space is the offshoot of the vibration of the primordial energy. This is how the space was born. All forms of nature are manifest forms of subtle energy. For all to get manifested, the force is Kaalam. This waveform frequency realm is the creative element of the universe. (Aintiram)*

Mayan took these fundamental principles and applied them to all manifestations of consciousness. Thus, the force of Kaalam (Absolute Time, pulse, frequency) was seen to influence the entire cosmos. Mayan articulated these and other principles in a number of texts including the 1 million verses of the Pranava Veda.

### **The Pranava Veda and Other Works by Mayan**

As mentioned earlier, the Pranava Veda is the first Veda and the *source Veda*. Dr. V. Ganapati Sthapati explains: *A good deal of evidence is available both in Tamil as well as in Sanskrit works, particularly in Srimat Bhagavatam and Skandam about the remote existence of Pranava Veda. This Veda was later on called the science of Vastu (energy) and Vaastu (embodied energy), which is gaining much popularity today across the globe.*

Dr. V. Ganapati Sthapati goes on to say that Veda Vyasa himself said in the Bhagavatam:

*Eka eva pura vedo pranavha sarva vangmayha*  
(9<sup>th</sup> skandha, 14<sup>th</sup> chapter, sloka 48 of Bhagavatam)

This phrase by Veda Vyasa, the compiler of the present day Vedas, means that there was only one Veda in the remote past and that Veda is called Pranava Veda – the Veda of the Shilpis of India. Atharva Sheershopanishad makes mention of the term “Pranava” as being “ongara” – the all-pervasive substance.

Pranava Veda elucidates the science of Pranava. It is the scientific study of The All Pervading Substance. Pranava Veda presents the science of “how the invisible substance of the universe (paravastu) makes itself manifest in the visible material (Vaastu) forms.” In other words, Pranava Veda reveals the process of how the All Pervasive pure Energy turns into Matter or material existence. ([www.vastuved.com](http://www.vastuved.com))



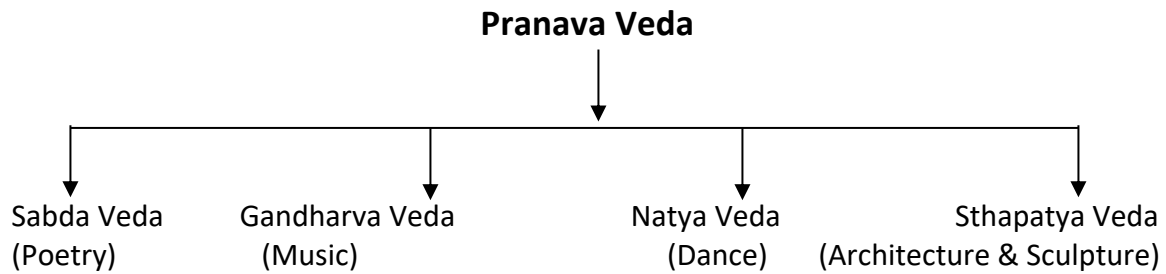

What we see above is called the “Five-Fold Veda.” This is the “source” Veda that presents the scientific manifestation process (Pranava Veda) and the four products of that manifestation (poetry, music, dance, and architecture).

All of these “forms” (poetry, music, dance, architecture, sculpture) are generated from the Unmanifest Space or Brahman based on SPACE, TIME, SOUND, and LIGHT, which give rise to all aural and visual forms in the manifest world. In this science and technology, each of these manifest forms of paravastu or Vastu are governed by a common grammar of Kaala mana (time units) called Taala maana. The dominant and all-pervasive element in the creation of these forms is the concept and process of the unmanifest becoming manifest by its own creative nature.

Based upon this theory of manifestation, and to signify the Five-Fold Veda, the Shilpis have created a form with five heads. This form is called Vishwakarman. It represents the five Vedas, that is the Pranava Veda, which is the instruction manual for how the Unmanifest (Vastu) turns itself into Manifest creation (Vaastu) and the four products of that manifestation (poetry, music, dance, architecture and sculpture)

### **The Surya Siddhanta**

The most ancient treatise on Astronomy is a treatise authored by Mayan. It is called *The Surya Siddhanta*. Included in this treatise are the following chapter topics following the Introduction:

- I. The Motions of the Planets
- II. The Places of the Planets
- III. Direction, Place, and Time
- IV. The Moon and Eclipses
- V. The Sun and Eclipses
- VI. The Projection of Eclipses
- VII. Planetary Conjunctions
- VIII. Of the Stars
- IX. Risings and Settings
- X. The Moon’s Risings and Settings

- XI. Certain Malignant Aspects of the Sun and Moon
- XII. Cosmogony, Geography, and Dimensions of the Creation
- XIII. The Gnomon
- XIV. The Movement of the Heavens and Human Activity

Mayan is the author and Mayan's name occurs in the text itself as Mayasura. Scholars have ignored his authorship and profound scholarship and attributed it to a later-day astronomer. Mayan was dismissed as an asura with the definition of asura misrepresented as meaning demon. Unknown to those and present-day scholars, the term "asura" means one who is spiritually and intellectually strong and supreme in ability above others. In actuality, the great Vedic Gods Indra and Varuna are classified as asuras. (Dr. V.G. Sthapati, p. 79, Building Architecture of Sthapatya Veda, Second Edition, September 2005.)

### **Medical Treatise on the Siddha System**

We know from ancient texts that Mayan wrote *Treatise on Herbology*. This is the oldest known codified reference on the topic. Dr. S.P Sabharathnam, Secretary, International Society for Investigation of Ancient Civilization, Chennai, India, is a longtime researcher of Siddha literature and refers to Mayan as a Siddha – a self-realized person of great spiritual power and ability. Given this and his interest in herbology, it is not surprising that Mayan most likely is the author of the medical treatises on the Siddha System of Medicine often thought to be the precursor to Ayurvedic Medicine.

### **Technical Works**

The following are technical works written by Mayan and represent the 12 vowels of the Tamil language:

- |                       |  |
|-----------------------|--|
| 1. Ovia Chennool      | Treatise on Drafting and Painting                      |
| 2. Sirpama Chennool   | Treatise on Iconometry                                 |
| 3. Kattida Chennool   | Treatise on Architecture                               |
| 4. Nilamanai Chennool | Treatise on House Building based on quality of land    |
| 5. Manainila Chennool | Treatise on Land based on the nature of house building |
| 6. Baniyal Chennool   | Treatise on Astro Physics                              |
| 7. Perunata Chennool  | Treatise on Divine Dance                               |
| 8. Muligai Chennool   | Treatise on Herbs                                      |
| 9. Ganitama Chennool  | Treatise on Mathematics                                |
| 10. Arakkala Chennool | Treatise on Ship Building                              |
| 11. Vinkala Chennool  | Treatise on Space Ship                                 |
| 12. Elisai Chennool   | Treatise on Science of Music                           |

It is quite interesting to note that the Treatise on Drafting and Painting and the Treatise on Iconometry exist in Sanskrit texts, but they are mutilated and mistranslated and are unintelligible when read. Those aspects of Vastu Science (the science of Energy, Matter,

Time and Space, and Space and Spatial Forms) missing from the Sanskrit texts exist in their entirety and completeness in the Tamil Vaastu Shilpa texts and in Mayan's Aintiram in sutra form. The Aintiram is held as the Brahma Sutra of the science of visual and aural forms. This term, Brahma sutra, is a technical and scientific term originating in Aintiram and now found in the Vaastu Shastra. (Dr. V. G. Sthapati, Building Architecture of Sthapatya Veda, Second Edition, September 2005.)

### **The Aintiram**

In Mayan's deep, spiritual and scientific treatise called the Aintiram, the profound underpinnings of Vastu Science are articulated. From the text itself, it is clear that this Treatise was written for and presented to a meeting of scholars called in those times a Sangam. In the text, Mayan mentions his own name, thus there is little reason to doubt that he wrote it.

The following is a summary of some of the principles put forth by Mayan in the Aintiram:

1. Nothing is created – it is manifested from the One Source.
2. The Originating Source is sometimes called Moolam, Brahmam (Quantum Field).
3. It constantly creates (manifests) so that it may forever savor and enjoy its own Ultimate Beauty. That is, the Originating Source found itself to be so beautiful and perfect and in love with that beauty and perfection that it manifested itself in different material forms in order to experience and savor that beauty eternally.
4. This Originating Source or spiritual center is Moolam (meaning source), Maiyyam (meaning center) and Pulli (meaning point) – the central source point of consciousness – pure energy.
5. All objects of nature are unified entities (forms) of energy and matter.
6. The free Space is the unified field of energy and matter and source of all forms that we see in material world.
7. There are two OMs: OM Light and OM Sound, the former is the source of all visible objects and the latter, the source of all aural forms.
8. All material forms of the universe are musical forms or have taken shape on musical rhythm or musical scale.
9. Time creates, sustains, and destroys all, so created.
10. The primal manifest form of the unmanifest is square (primal wave pattern).
11. The primal square pattern is designated as the diagram of embodied energy – Vaastu Purusha Mandala.
12. The free space is packed with cubical atoms of energy. They are building blocks of the structure of the universe.
13. The cube is microabode called Sittravai/ Chittrambalam (mini hall in Tamil).
14. Within the hall there is a vertical luminous shaft called Brahma Sutra (Oli nool).
15. This Olinool/Brahma Sutra is a shaft of consciousness also called Moolathoon/ Moolasthambham.

16. This shaft of consciousness vibrates in a particular order called rhythm. This is the order of nature.
17. This rhythmic vibration of the shaft of consciousness is the dance of Shiva, the Space.
18. The micro space, in the cubical shape is fetus, Garbha or Bindu. This is known as Vinkaru in Tamil.
19. This microabode is the repository of light and sound.
20. The free space is Light and the Light is Moolam or source of the universe and universal forms. Light is Brahman, Atman, and Vastu Brahman – Nun porul in Tamil.
21. The embodied energy is Vaastu Brahman/Vaastu Purushan. The space enclosed in a building is Prasada Purushan – energized building – Building is a living organism, built of musical units of measure.
22. Architecture is the supreme achievement of mathematics.
23. Mathematics is rooted in the dynamism of Absolute Time.
24. Time is the vibration of Space.
25. Time and Space are equal.
26. Time is one of the subtle elements of Space (Akasha).
27. Time is the causal element of all objects of the Universe.
28. The microcosmic structure is in total identity with macrocosmic structure.
29. The supreme space is throbbing every moment to express itself out.
30. Through the power of inner consciousness, the knower of Vastu should know about light aspects and sound aspects of OM pertaining to both inner and outer space.
31. Those who do not realize the creative dynamism of inner space cannot know the dynamism of outer space.

These 31 principles form part of the foundation of the sciences called building architecture of Sthapatya Veda, Vaastu Shastra and Traditional Indian Architecture. These are commonly called Vastu or Vaastu. While these ideas may seem unfamiliar or perhaps abstract, their meaning and significance becomes clear as one delves more deeply into the science of Vastureva Vaastu – energy becoming matter through the manifestation process.

I mentioned previously that this was a lost science. The Pranava Veda, the foundation for the scientific background of this body of knowledge, was lost for hundreds, maybe thousands, of years. There is an amazing story about its rediscovery that will shed light on the privilege it is to learn about Mayan and the Pranava Veda.

### **The Discovery**

In a small village in rural Tamil Nadu, India, there lived a scholar and poet by the name Veerabathiranan, also known as Kaurmari Dasar. Veerabathiranan was a savant and had a divine gift of perfectly memorizing thousands of verses of ancient texts. The works of Mayan were among the texts he memorized in his younger years.

Veerabathiranan had a special interest in astrology and sought out ancient palm leaf texts at the famed Saraswati Mahal Library in Tanjour, Tamil Nadu, India. The Saraswathi Mahal Library contains rare and valuable collections of palm leaf manuscripts on all aspects of art, culture, literature, and medical prescription of ancient Ayurveda scholars, including patient case studies and interviews in the manuscripts classified under the Dhanvantari section. These manuscripts have been collected for hundreds of years – some of the knowledge is thousands of years old.

In his search for the most ancient texts on astrology, Veerabathiranan found a large cache of very ancient palm leaf texts. He read portions of them and then continued to look for astrology texts. Something inside drew him back to the old cache of texts he found. He kept reading them again and again for four years. He soon came to realize that these texts were of great import. He realized that the legendary great sage and architect named Mamuni Mayan wrote them.

Over time, Veerabathiranan became so entranced by Mayan's writing that he began to memorize thousands and thousands of verses. He returned on a regular basis to study and memorize what was called the Pranava Veda.

One day many years later, Veerabathiranan went back to the library to view the text once again. He discovered that the source texts were missing. They were stolen, sold, or lost in a fire. It was unclear what actually happened to them. He came to understand that *he* was the only source available for the preservation of this profound knowledge. He then sought out Dr. V. Ganapati Sthapati whom he knew had a great interest in the works of Mamuni Mayan because of Sthapati's ancient family lineage as a Mayonic architect.

As Dr. Sthapati listened to Veerabathiranan chant the ancient texts, he was mesmerized. He soon became overwhelmed with the importance of these scriptures. He realized that this knowledge being transmitted in front of him was the foundation of his own Vaastu lineage and the authentic entire lineage of Sthapatya Veda.

While Mayan was thought of as a mythical being from legends in many parts of India, in the southern region of Tamil Nadu, where he first lived after the great deluge, he was respected as a real human and authentic progenitor of Pranava Veda – the ultimate source of Vaastu Shastras, Agamas, and much of Indian culture. There even exist today places where he was known to have built shrines. His teachings were passed down to his 12 disciples and spread throughout India and to many places in the rest of the world. Dr. Sthapati's lineage was part of the tradition begun by Mayan.

Dr. V. Ganapati Sthapati took great effort in recording, in writing, the fifty-thousand verses of the Pranava Veda that Veerabathiranan recited to him. The Pranava Veda is one of the oldest Tamil Works available today. It is presented as the source of Vedas by Veda Vyasa himself (compiler of the Vedas). This scripture deals with the basic principles of

Light, Sound, Space, Time, and Self (individual and Universal soul). The Pranava Veda is said to be a detailed commentary on Mayan's seminal work *The Aintiram* that is currently a published text.

Dr. S. P. Sabharathnam, a Vastu and Agama scholar and translator of Mayan's works and many other ancient texts says this about Pranava Veda:

*The working pattern of the basic two aspects of Pranava (OM) – OM Light and OM Sound is the core subject of this work. The nature of Primal Light is analyzed in terms of visible rays, invisible rays, sparks and flames, which are constantly working. In inner cosmos and outer cosmos, (inner cosmos is within every human body) the nature of Primal Sound is analyzed in terms of audible and inaudible sounds which go hand in hand with the Luminous rays and sparks. The Pranava Veda establishes the truth that there is the basic source of Primal Light, which emits trillions and trillions of luminous beams, which are classified into three – solar, lunar, and fiery. All the visible luminous bodies moving in the near and distant heavens derive their energy only from this Basic Source of Primal Light ... The Pranava Veda speaks elaborately on the 64 square grid, microabode, five-fold manifestation, five cosmic elements, the positive, negative and neutral interaction between the five cosmic elements and above all the unfailing total identity and correspondence between the inner cosmos (human body) and the outer cosmos.*

*Some of the worthy declarations made in this Veda are:*

- *Who is there in this world who has perfectly realized the greatness and efficacy of the human body?*
- *It is only the perfect human being who could gain the essential knowledge of the Eternal Existence and of the ever-pure Space of Consciousness.*
- *It is only the perfect human being who could gain the beatific intuition and everlasting Bliss.*
- *It is only the perfect human being who could co-ordinate the basic functions of light, sound, space, and time.*
- *It is only the perfect human being who could attain the knowledge of Cosmic totality within himself and elevate himself to the extreme spiritual heights.*

*The Pranava Veda, which is replete with basic principles and concepts of the ever-expanding universe and the visible and invisible cosmic structures, is sure to benefit the reader in great measure.*

One can see the depth and elegance of the Pranava Veda by reading the following verses. They are at once science and spirituality – the physics of the Divine.

### **Pranava Veda Vs. 1**

- 1 Ōm Ōm Ōmiyal Ōmurum
- 2 Olikalai Olinilai Urusudarey
- 3 Ōm Ōm Velinilai Veliyurum
- 4 Olikalai Viyanurum Virisudarey
- 5 Ōm Ōm Murukoli Arusudar
- 6 Ainilai Aimarai Muthalmarayey
- 7 Ōm Ōm Kalaiyoli Nilaiyurum
- 8 Aivakai Neriyyurum Kuripporuley

Ōm Ōm (OM Light and OM Sound); Ōmiyal (Energy generated from OM); Ōmurum (form generated from Energy)

Olikakalai (Light aroused in a disorderly manner); Olinilai (state of Light); Urusudarey (flame)

Velinilai (state of Light in Space); Veliyurum (form of Light in Space)

Viyanurum (magnificent); Virisudarey (luminous Light)

Murukoli arusudar (beautiful Light form with six faces)

Ainilai (five stages); Aimarai mudalmarayey (of the five Vedas, this is the first)

Kalaiyoli (disorderly Light); nilaiyurum (transformation to orderly state)

Aivakai (five types); Neriyyurum Kuripporuley (order found in all material forms)

*Vs. 1. OM Light and OM Sound are the Primal Source of all manifest forms. OM Light is aroused by its own effort in a state of disorder and appears as a flame. The state of OM Light and OM Sound in Space is a magnificent luminous six-faced Light form that is called "murukoli". The transformation of OM Light and OM Sound through the five stages is concealed in the five-fold knowledge, of which, this is the first. This process of transformation of disorderly OM Light and OM Sound into orderliness is found in all five-fold material forms. (Translation by Santhana Krishnan, Krithika Karuppiah, with Jessie Mercay)*

### **Pranava Veda Vs. 2**

- 1 Ōm Ōm Oliyolir Urunilai
- 2 Urusudar Iyalviri Kalaiyoliyey
- 3 Ōm Ōm Thiruveli Peruveli
- 4 Ennilai Enkalai Nilai Iyaley
- 5 Ōm Ōm Oliyasai Olioli
- 6 Peroli Peroli Periyaley
- 7 Ōm Ōm Oliyiyi Lurumoli
- 8 Nilaiyasai Kalaivirip Perunsudarey

Ōm Ōm (OM Light and OM Sound); Oliyolir

(luminous Light); Urunilai (state of creation)

Urusudar (flame produced); Iyalviri (spreading force);

Kalaiyoliyey (creative Light)  
Thiruveli (invisible Space); Peruveli (visible Space)  
Ennilai Enkalai (mathematical order); Nilai Iyaley (state exists)  
Oliyasai (vibration of Sound); Olioli (Sound)  
Peroli (cosmic Light); Peroli Periyaley (magnificent force of cosmic Light)  
Oliyiya Lurumoli (generation of Sound from Light)  
Nilaiyasai (vibrant stillness); Kalaivirip (beautifully spread); Perunsudarey (immense flame)

*Vs. 2 The self-effulgent luminous Light transforms itself into a flame, which spreads in all directions as a creative Light. This Light infuses the invisible and visible Spaces creating a mathematical order, which is ever existent. Vibration of OM Sound and the magnificent force of cosmic Light generates Sound (Sound particles). Vibrant stillness of OM Light creates a beautifully spread, immense flame.*

These two verses form the basis for understanding what is called the manifestation process – how the unbounded Space or Consciousness becomes bound as material form – the drama of life unfolding. They will be repeated again when the manifestation process is described herein.





## Chapter 4 The Manifestation Process Called Vastureva Vaastu: The Physics of the Divine

*The Self unfolds Itself, by Itself, for its Self*  
Bhagavad Gita

*The theme of the Vaastu traditions is that God is the most Primal, energetic, vibrant existence as a scientific substance full of consciousness which cognizes itself and gets itself turned into manifold forms in tune with its own self-awareness. This is called self-manifestation. (Dr. V. Ganapati Sthapati)*

*Vastu is the Primal energetic substance and Vaastu is all the worldly objects, which are actually the modifications and transformations of Vastu. (Ibid)*

### **The Source of Vaastu Energy**

Many people who practice some form of Vaastu consulting believe that *Vaastu energy* comes from the sun and planets or somehow from the Northeast outside the building. Through time and due to the loss of technical understanding of the Shastras, individuals looked at old existing Vaastu houses and patterned their own Vaastu model after what the houses looked like. They neither knew why they appeared that way nor how to properly construct them (principles of architecture). The few families who understood this knowledge in depth were never consulted on most of these ideas.

Vaastu Shastras speak of *Cosmic Space* as being the source of energy in a Vaastu house. When non-technically trained Vaastu consultants read about concepts of *Cosmic Space*, they erroneously think that *Cosmic Space* refers to outer space – the Sun, Moon, Planets, and Stars. This notion is amplified by the mistranslation of the fifth element in the center of the Vaastu Purusha Mandala as meaning *Sky* when in fact it means *Space*. What they fail to understand is that *Cosmic Space* refers to Brahman or Consciousness itself – the source of the entire material world. We can think of Brahman as being similar to the concept in physics called the Unified Field. Thus, the source of energy in a Vastu building is not the sky or outer space – it is Cosmic Space or Consciousness.

Physicists theorize that there is a single unified field of unmanifest pure energy that is the source of the material world. They view the material world as impulses or waveforms that are fluctuations of a unified field. In addition, there are various other theories, such as string theory, that hold that the unified field is filled with “strings” that are one-dimensional oscillating lines or threads. Without going into too much depth, these oscillating strings (similar to the concept of Brahma Sutra which will be discussed later) are holographic in nature (similar to the microabode – to be discussed later) and ultimately produce matter. These scientific principles are similar to the principles that underlie the concept of Brahman or unmanifest energy in Mayonic Science.

Fortunately, there are several treatise written by Brahmarishi Mayan that clearly state the source of Vaastu energy as being Brahmam or Consciousness – that is the real meaning of Cosmic Space. We can look at one great and sacred text called *Brahma Sutra* for further evidence of Mayan’s assertion that Space is not just a material element.

*Adhikarana VIII*: Sutra 22 shows that the ether (Akasa) from which, according to Chandogya Upanishad I-9, all beings originate is not the elemental ether but the Supreme Brahmam – Vastu Brahmam.

*Space (Akasa) is Brahmam, for Brahmam’s indicatory mark is in evidence.*

In addition, great enlightened Tamil poets, saints like Thirumular, also state that Space is Consciousness. In his *Thirumaintiram*, he makes a number of references to Space as being consciousness. He also makes a number of other references that indicate his understanding of the knowledge in Vaastu Shastras and Pranava Veda. As an example, we can refer to verse 129 of Thirumular’s *Thirumaintirum*. Thirumular states:

*In Space pure is tranquility seated  
In space pure it does repose.*

The prestigious scholar Dr. B. Natarajan states in his commentary on *Thirumanitiram* that Thirumular is speaking of the Ultimate, Consciousness itself as Cosmic Space. He says that according to Thirumular, the essence of jiva and all things is the selfsame Space in a microcosmic state. Thirumular seemed to be steeped in Mayonic wisdom.

In other verses, Thirumular points out that Space is the source of Consciousness and that everything in the material world is born of that Space. He mentions the eight directions flowing from the central Moolam.

### **Vs. 385: Universe of Five Elements – Evolutes**

*Out of Maan evolved space  
From space, ether  
From ether, water  
From water, earth's hard crust;  
Thus they formed in succession  
The elements five;  
They were for the universe  
The nectar unto Flower.*

### **Vs. 521**

*... He fills Space in directions eight,  
On the throat of His Downward-directed Face  
Darkness suffuses;  
They say, "He swallowed poison;"  
They are ignorant, they know not truth.*

### **Vs. 787: God as Knowledge**

*The Lord is the Knowledge  
He stood as knowledge of elements five – air and the rest;  
He stood as knowledge pervading world all and life  
Inseparate from them;  
If sought within,  
That knowledge will in pervasive richness glow.  
Knowledge of the five elements (Vaastu Purusha Mandala)*

The crux of Vastu Science and Technology is the manifestation process called Vastureva Vaastu. This process gives rise to a set of principles and a mathematical order – the Mayonic Order. The application of those principles to poetry, dance, music, sculpture, and architecture gives rise to vibrating living forms. While our focus in this document is on built space in the form of architecture, the same principles apply in terms of the manifestation process regarding sculpture, music, poetry, and dance.

Vastureva Vaastu simply means unmanifest pure potential Energy (Vastu) turning itself into material form (Vaastu). This is the technical meaning of the term Pranava. With the understanding of this process and the simultaneous yet successive manner in which it occurs, one comes to fully realize that Vastu *is* Vaastu. Pure Consciousness, Brahman, is the same as the material world and the material world is the same as Pure Consciousness, Brahman. There really is no distinction between manifest and unmanifest. There is no distinction between an individual and consciousness itself.

Patanjali, in his yoga sutras, recommends that a seeker perform dharna (concentration), dhyana (contemplation), and samadhi (deep meditation) on the distinction between buddhi (representing manifest) and Purusha (representing unmanifest), and he or she will experience an awakening. That awakening comes because over time one realizes that, as pointed out by Mayan, there is no distinction between Buddhi and Purusha. They are one and the same. Everything in the manifest world is nothing but consciousness. When that awareness becomes a permanent experience then the goal of life is realized. The study and application of Vastu Science is a path to that realization because understanding and experiencing Vastureva Vaastu on a very deep level promotes the understanding and experience that All is One.

*... forms produced by the application of Vaastu Science are the forms of the  
Spirit ...*

Dr. V. Ganapati Sthapati

The following diagram, created by Dr. V. Ganapati Sthapati, depicts the process of Vastu becoming Vaastu – potential energy transforming into kinetic energy. While at first the process may seem complicated, as you read on, you will find that it is simple and elegant. As you read, know that this process is occurring every nanosecond within your Self. Read with an open heart and open mind. That openness will create deep and profound understanding that you will find to be transformative.

\* अचिन्त्य अव्यक्तरूपाय निर्गुणाय गुणात्मने ।  
समस्त जगदाधार मूर्तये ब्रह्मणे नमः ॥

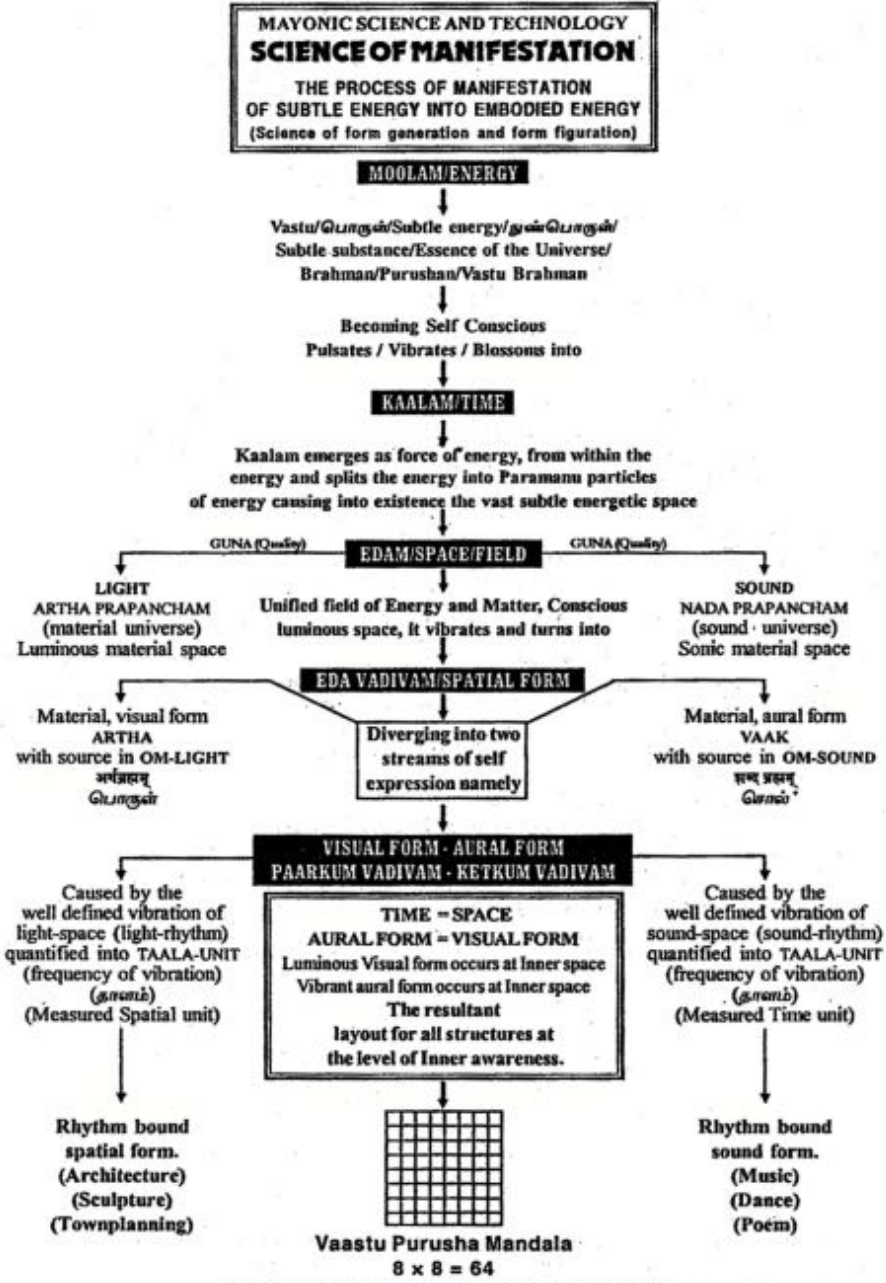

TRI-Dimensionally every particle of space is a subtle cube of energy, called CHITRAMBALAM or MICRO-ABODE within which there is a 'shaft of light' or  'shaft of consciousness' vibrating or performing a 'rhythmic dance'. This is the dance of the DANCER, GOD SHIVA.

The whole universe is filled with subtle cubes of energy called KARU or BINDU or FOETUS.

\* Brahman as defined by Mayan, in his astronomical treatise called 'Surya Siddhanta'.

**The Absolute Theory of Manifestation:  
Vastureva Vaastu and the Birth of the Material World**

*“Though I am unborn and of imperishable  
nature, though Lord of all beings, yet  
remaining in My own nature I take birth  
through My own power of creation.”  
(Bhagavad-Gita Ch 4. v6)*

Mayan’s greatest achievement, and root of all of his other achievements, was the discovery of the Brahman principle, which is akin to modern Unified Field Theory (the field of Brahman) and quantum physics (the actions of particles and waves within the Unified Field). Not only did he discover The Brahman principle, but he also discovered principles akin to modern point theory, wave theory, string theory, and particle theory. He, in a nutshell, was able to describe the *fabric of the universe* and the innate functioning of an underlying intelligence responsible for the formation of matter. And, in that description, he explained a fundamental particle (micro and macro) from which all of life arises.

Mayan, in his understanding of the Unified field and quantum field activities (ripples in the Unified field), was able to go further than modern science. Mayan states:

*There exists an order in the Universe – subtle universe and material universe. This power is attributed to the consciousness of the cosmic space as well as of the inner space of the animate beings. This consciousness, by its personal effort to express its own inner feelings, causes a kind of vibration or pulsation in the inner space, resulting in energy-grids. The vibration or pulsation, being the causal element of all these events, is called Kaala (Absolute Time). This is actually the force of energy aroused by the inner consciousness, causing waves and contributing to the growth of living forms. This Kaala resides in all living beings. So, space is the offshoot of the vibration of the primordial energy. This is how the space was born. All forms of nature are manifest forms of subtle energy. For all to get manifested, the force is Kaalam. This waveform frequency realm is the creative element of the universe. (Aintiram)*

Without exception, the ancient Vedic texts speak of Mayan’s Brahman principle. Modern science has, in theory, come to understand that there is that one unified field from which the material world arises; yet, it is only a theory today. However, Mayan thought of it, saw it, and described it – the Brahman principle.

Mayan identified the structure of infinite and finite energy particles. Mayan defined the vibration of inner Space and outer Space as a quantifiable one by virtue of which he was able to identify the structure of these energy particles and an order in the development

of forms of matter. He discovered that the subtlest and smallest particle exists as a cubical structure containing a vibrating Thread of Consciousness or Cosmic Fire. This Cosmic Fire is the creative element. This particle he called anu or microabode (Dr. V. Ganapati Sthapati). The microabode is the smallest particle in the Absolute or relative existence. It is the foundation from which all matter rises. Absolute Space is packed with these energy particles.

It is from these particles that Absolute Space manifests itself through Time, OM Light, OM Sound, the subtle aspects of the Pancha Bhutas (five elements – air, fire, water, earth, space). At this point, there is a question in the minds of almost every human in history: Why? A philosopher asks – Why did the Absolute manifest Itself? A religious person asks – Why did God create the world? A scientist asks – Why does the quantum field project forth sound and light waves that form the material world? At last, we have the answer thanks to Mamuni Mayan:

*Dr. Sthapati says that “the paradox lies in the utter simplicity of the answer: The Moolam (Brahmam) is in love with its own inherent beauty and this beauty it searches for on the outside, and this perfection it constantly creates so that it may forever savor and enjoy this ultimate beauty. In its desire to create a substantive representation of itself on the outside, in order to savor its own beauty, the Moolam impels itself into a spin. Upon rotating, the particles are thrown out all around the center. Mayan says that it is from this action of discharging particles of light from the luminous core that the Moolam anticipates the end product of a manifested outer phenomenon. The very act of anticipation of a final outcome and the effort put into bringing this about are the reasons for the ultimate object to be transformed into a reality from being figment of an inner dream.”*

Let us explore this process more deeply with a summary written by an advanced student of the American University of Mayonic Science and Technology. In the following paragraphs, Rosie O’ Sullivan comments on an article written by Dr. Mercay called *The Cosmological View of Mamuni Mayan in His Mayonic Science*. It is a commentary on a monograph by Dr. V. Ganapati Sthapati:

*The “Cosmological View of Mamuni Mayan in His Mayonic Science” is a very profound and deeply moving description by Dr. Jessie Mercay of Dr. Sthapati’s translation of The Center of Origination, a chapter in his overview of Mayan’s Aintiram. It follows the theme of revealing why Brahmam or Consciousness chose and chooses to manifest and ultimately helps one understand why he or she was born and what brings true happiness. What most inspires me about this description of the unfolding of life is that it is a love story, the greatest love story, in that it is this Supreme 1<sup>st</sup> impulse of Love that brought and continues to bring into being, in every nanosecond, all that we know and experience as our world and the pulsating universe. It starts as the Originating One Source, called Moolam, Brahmam, The Quantum field, finding itself to be so beautiful and perfect and so in love with that beauty and perfection that it begins to vibrate, pulse, spin and order itself, manifesting over and over again into the myriad of material forms in the universe in order*

*to experience and savor that beauty eternally. This process of manifestation, besides being vibrant with the impulse of love, is spontaneous, orderly, intelligent, unforced, auto catalytic, and pure.*

*These are its beginnings, where even in its stillness it is not frozen but filled with the promise of its throbbing, where it then impels itself into a spin discharging particles of light from its luminous core in anticipation of the end product of a manifested outer form, as the birth of a now and later are born, bringing Time and limits into being. An intrinsic order is created as Moolam exercises control on its luminous particles. This is what we call Mayonic Order or Tala Purusha. This vibrant energy flutters to this ceaseless rhythm and is compared to an eternal dance of love, the dance of all reality, the divine dance of Nataraja. In love with its own beauty and pulsing itself to this divine dance, it transforms itself into infinitely complex material forms. The knowledge of this process not only thrills the reader with intense happiness it shows us that our true happiness lies in the ability to savor our own individual beauty and perfection that pulsates with great luminosity from our own vibrant core. It tells us that we are a perfect creation/manifestation of the ultimate Divine Love that sprung from its own desire to savor its own beauty in our living form. To know this brings one into resonance with that highest vibration of Love that vibrates us and everything into being. (Rosie O’Sullivan, PA, USA, Graduate Student AUM S&T)*

### **The Growth Dynamics of the Unmanifest**

How does unmanifest, potential energy become manifest, material form?

As stated above, the fundamental crux of Mayonic Science is that Mayan perceived that there is one force, one fundamental First Principle from which all life emerges and in which all life resides and ultimately returns to its Primal state of pure energy. He named this principle Brahman. He saw that Brahman (Absolute Space, Consciousness, Potential Energy), by its own initiative, goes through a specific process to transform and manifest itself as the material world and its objects, Kinetic Energy. Mayan perceived that that process is accomplished through a mathematical order and that this order can be replicated by humans to unfold specific qualities of Brahman that vibrate with specific frequencies, bringing health, happiness, and spiritual bliss. This is essentially Mayonic Science, beginning with an unmanifest micro-particle called microabode, activating it into a material micro-particle also called microabode, then building from there. Microbode or microabode refers to the smallest manifest and unmanifest particle, which contains vibrating consciousness. Also called Chidambaram – mini hall.

We must begin with the unmoving vast expanse called Brahman. He is called *Shiva* (pronounced as Civa) when he causes manifestation or grows through Time (We say “he” here but in fact Shiva is both male and female in its form as Nataraja). The cube – microabode – is the first manifestation of Brahman from Soonyambaram (zero or Cosmic Space).

From the field of consciousness, we begin with the point value (Point theory) of the source of creativity. Dr. V. Ganapati Sthapati, Vaastu Vyasa, articulates Mayan’s discoveries



about this fundamental level of the unified field known as Brahmam. He says that in the beginning, there is a square flattish form (Eka Pada) that is pregnant with potential – it is like a burning ember. Mayan refers to that point value in the Pranava Veda when he speaks of the quantum mechanical process of manifestation within the Unified Field. Mayan says that from that point (eka pada) a Cosmic flame arises, by its own effort. An outside force does not stimulate it. It is autocatalytic.

Om Om Iyalviri Olinirai

Nilai Iyal Kalaiperu Miyalvirivey

Om Om Moolap Porulneri

Naarpurat Thiyalnilai Kalaisudarey

Om Om Ennilai Arupaan

Naankiyal Kanakkiyal Sitravayey

Om Om Sudaroli Moolak

Kanalnilai Onkurum perunthiraney

ஓம்ஓம் இயல்விரி ஒளிநிறை  
நிலையியல் கலைபெறு மியல்விரிவே  
ஓம்ஓம் மூலப் பொருள்நெறி  
நாற்புறத் தியல்நிலை கலைச்சுடரே  
ஓம்ஓம் எண்ணிலை அறுபாள்  
நான்கியல் கணக்கியல் சிற்றவையே  
ஓம்ஓம் சுடரொளி மூலக்  
கனல்நிலை ஓங்குறும் பெருந்திறனே

*The self-spread OM light exists in a permanent state of luminosity (like a burning ember throbbing with potential). This luminosity is amazingly creative in appearance. The orderly shape of this primal source of luminous flame is four-sided (square – Eka Pada) .... The luminous primal ember contained within this square has enormous potency. (Pranava Veda Vs .3 Translated ibid.)*

Dr. S.P. Sabharathnam says of this verse:

*The science of OM, which includes OM Light and OM Sound, is of the nature of explaining all the functional aspects of luminous rays and sparks which give rise to the emergence of universe, the nature of various kinds of space, the space-born luminous lights, the inspiring effulgence and beauty of cosmic totality called morgue, six sparks functioning within inner space and in outer space, five cosmic locales, five scriptures, and five cosmic orders.*

The genesis of this self-activating process begins with Zero Space – Soonyambaram. Imagine a vast, unbounded field of pure, unmoving vibrant potential energy. This field has no beginning and no end. It just is. This is the field called Absolute Space. This Zero Space can be visualized as an uncompounded, vibrant, concentrated square energy form (Eka pada) likened to a burning ember (Moolak Kanalnilai) pregnant with potential yet in vibrant stillness (nilaiyasi). It can be viewed as an unimaginably concentrated point of energy.

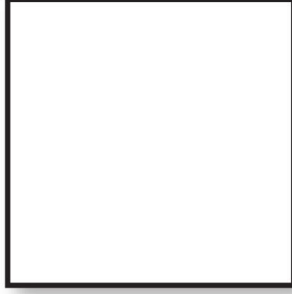

View of Eka pada from  
above looking down.

From a cross section or side view, it can be represented here for the sake of analogy as a flat line.



This Absolute Space is Zero Point or Zero Time, no *time* or *pulse*, Absolute stillness and silence yet filled with potential energy.

Om Om Iyalviri Olinirai	Om Om (OM Light and OM Sound); Iyalviri (self spread); Olinirai (Light filled)
Nilai Iyal Kalaiperu Miyalvirivey	Nilai Iyal (permanent state); Kalaiperu Miyalvirivey (creative self spread)
Om Om Moolap Porulneri Naarpurat	Moolap Porulneri (order of primal source) Naarpurat Thiyalnilai (four sided shape);
Thiyalnilai Kalaisudarey	Kalaisudarey (creative flame)
Om Om Ennilai Arupaan	Ennilai (mathematical state); Arupaan Naankiyal (sixty-four)
Naankiyal Kanakkiyal Sittravayey	Kanakkiyal (mathematics); Sittravayey (microbode)
Om Om Sudaroli Moolak	Sudaroli (luminosity); Moolak Kanalnilai (state of Primal ember)
Kanalnilai Onkurum Perunthiraney	Onkurum (highlight); Perunthiraney (enormous Potency)

*The self-spread OM light exists in a permanent state of luminosity. This luminosity is amazingly creative in appearance. The orderly shape of this primal source of luminous flame is four sided (square). The mathematical state of this square is a composition of 64 microbodes or grids. The luminous primal ember contained within this square has enormous potency. (Pranava Veda vs. 3)*

In this verse, Mayan uses the word *square* for the first time (Naarpurat Thiyalnilai – four sided shape). This gives shape to the unimaginably enormous flame that he describes in his previous verses. There are a number of other references that explain the shape of the primal source of energy. *Vaastu Purusha chaturasra samstaha* – *Vaastu* (material energy), *purusha* (embodied primal energy), *chaturasra* (square), *samstaha* (contained).

Now, imagine that at some “point” in Space that flat unbounded Absolute Space begins to move within itself or pulse within itself. An autocatalytic activation (pulse or Time)

begins from this highly concentrated square cosmic energy point (point theory). This point surges upward and becomes a vertical shaft of pure energy called *Moolasthan* – referred to by the Sage Mayan as Cosmic Flame. The sage Mayan describes this as, “*Naarpurat Thiyalnilai Kalaisudarey*” (Four-sided creative flame).

At this early stage of manifestation there are five stages. First the throbbing Consciousness withdraws into itself. Moolam consolidates itself through withdrawal called *Amizhdal* or converging to a point.

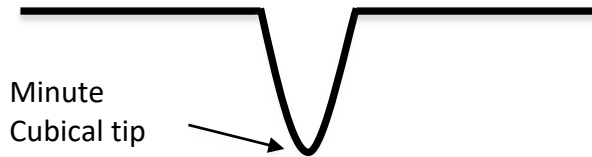

This Moolam then gushes or explodes outward and emerges and spreads (*Imizhdal*) and consolidates its self (*Kumizhdal*). The movement of energy in self-spin (*kalavisai*) propels and projects this energy (*Unuzhdal*) so that it comes out into form (*Tamizhdal*).

Interestingly enough, for the experience to merge into word-form the inner being has to undergo or travel through these five levels states, namely *Amizhdal* (“converging to a point”... withdrawal), *Imizhdal* (“emerging and spreading”), *Kumizhdal* (“coming together and consolidating”), *Unizhdal* (“projecting or delivering”), and *Tamizhdal* (“coming out into form”).

Using the flat line, we will create a pulse or waveform in that line as a cross section of the event as the energy gushes forward.

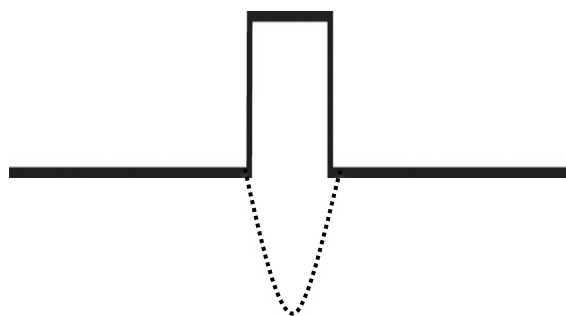

Vertical shaft with cuboidal Bindu/central point at top.

Gushes upward into pillar

This Cosmic pillar, or Moolasthan, goes into a clockwise self-spin (spin theory); as it spins light particles (OM Light) or waveforms are emitted; through the movement or friction of these light particles, sound (OM Sound) is emitted; this begins a process of emission of chaotic light and sound particles (chaos theory).

A more accurate visualization of this cosmic Form is this:

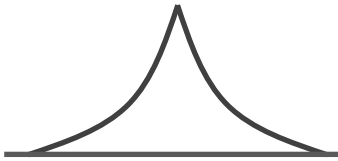

As described above, the Cosmic Flame rises upward as a result of a “gushing” forth of Consciousness. It was explained previously that at first there is an enormous withdrawal (*Amizhdal*) of Primal Energy – a withdrawal within itself. That withdrawal causes a concentration of energy that results in an explosion or gushing. This gushing forth has great momentum and power. As it gushes forward and subsequently spins, it produces OM Light, which is its basic nature. In other words, the nature of this Zero Space (*Soonayambarum*) – Space of everything – is *luminosity*. Thus, as it gushes forth as an enormous pulse, light is emitted and sound (OM Sound often referred to as AUM) is emitted due to the gushing upward and spinning nature of this enormous Luminosity. This form springs forth from the Ekapada (indicated by the flat line), which is square in nature. Thus, even though this form is funnel shaped as it rises, the tip is cuboidal – a six-faced cube that is replicated again and again as you will see. The enormity of this action might be equated to a *big bang*.

This form is *pyramidal*. *Pyre* means fire. *Pyramidal* means fire in the middle. This alludes to the cosmic fire in the middle. An understanding of this pyramidal primal form as explained here is important because the function of Vaastu architecture is to replicate the manifestation process by building the form that consciousness itself builds as it moves toward manifesting itself as material forms.

Most Vaastu forms demonstrate the pyramidal form in some way (as well as the cube as you will see). Please note that the pyramidal form is not complete within itself, and it must be connected with other forms when taken in totality to replicate the full stable form of consciousness that is being explained in these chapters. Later in this text the full realization of what that form is will be demonstrated. As a preliminary example, the roof shown in the below left Kerala picture is, in fact, a replication of this initial form shown above. This form is also seen around the world in ancient Vaastu forms. The picture on the right is a more complicated intentional replication of this form at Gangaikondacholapurim, Tamil Nadu. This process is further explained below.



ஒம்ஒம் ஒமியல் ஒமுறும்  
 ஒளிகலை ஒளிநிலை உறுகடரே  
 ஒம்ஒம் வெளிநிலை வெளியுறும்  
 ஒளிகலை வியனூறும் விரிகடரே  
 ஒம்ஒம் முருகொளி அறுகடர்  
 ஐந்நிலை ஐம்மறை முதல்மறையே  
 ஒம்ஒம் கலையொளி நிலையுறும்  
 ஐவகை நெறியுறும் குறிப்பொருளே

Om Om Omiyal Omurum

Olikalai Olinilai Urusudarey

Om Om Velinilai Veliyurum

Olikalai Viyanurum Virisudarey

Om Om Murukoli Arusudar

Ainilai Aimarai Muthalmarayey

Om Om Kalaiyoli Nilaiyurum

Aivakai neriyurum Kuripporuley

*OM Light and OM Sound are the Primal Source of all manifest forms. OM Light is aroused by its own effort in a state of disorder and appears as a flame. The state of OM Light and OM Sound in Space is a magnificent luminous six-faced Light that is called Murukoli. The transformation of OM Light and OM Sound through the five stages is concealed in the five-fold knowledge, of which this is the First. This process of transformation of disorderly OM Light and OM Sound into creative orderliness is found in all five-fold material forms. (PV Vs. 1, SK, KK)*

Dr. S. P. Sabarathanan:

*Various aspects of all the scientific pursuits concerned with cosmic Primal Light, the invisible space, the visible space, eight spots, eight forces emerging from the eight spots – all these are explained in the Pranava Veda. Energetic sound waves, which give rise to the powerful Light and potential Universe, are explained in this Veda.*

The act of pulsing or moving within itself, created an element called Absolute Time. Here we see the full range of a waveform pulse.

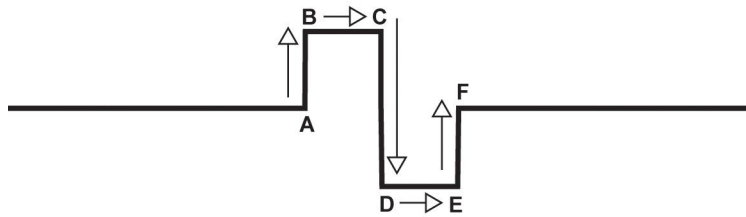

What do we mean by Absolute Time? From the moment that Absolute Space began to pulse (point A) it went through a *time* sequence. That is, it took "*time*" to move from point A to point B; from point B to Point C; from point C to point D; from point D to point E and point E to point F. The pulse rises and then falls back to the steady state – represented as the flat line.

---

Mayan says in his *Aintiram: Time creates, sustains, and destroys all, so created*. It is easy to see that it is indeed “Time” that created and destroyed the form or pulse in Absolute Space.

At this point in the genesis of Space becoming matter, we have two elements present: Absolute Space and Absolute Time. These two elements form a micro cube. As these two elements continue and commingle, a clockwise self-spin occurs as time marches on from point A to B to C to D to A.

The formation of the six-sided cube is of great significance, the importance of which will be seen as we explore architectural forms. The genesis of this cube is simple: The Moolasthan / pillar of Cosmic Fire replicates itself four times. Each replication of itself becomes the corner of the cube. This action occurs immediately and simultaneously. These corners instantaneously fill in as the faces of the six-sided cube. Dr. Sthapati says that this is Brahman “born in cubicle form.”

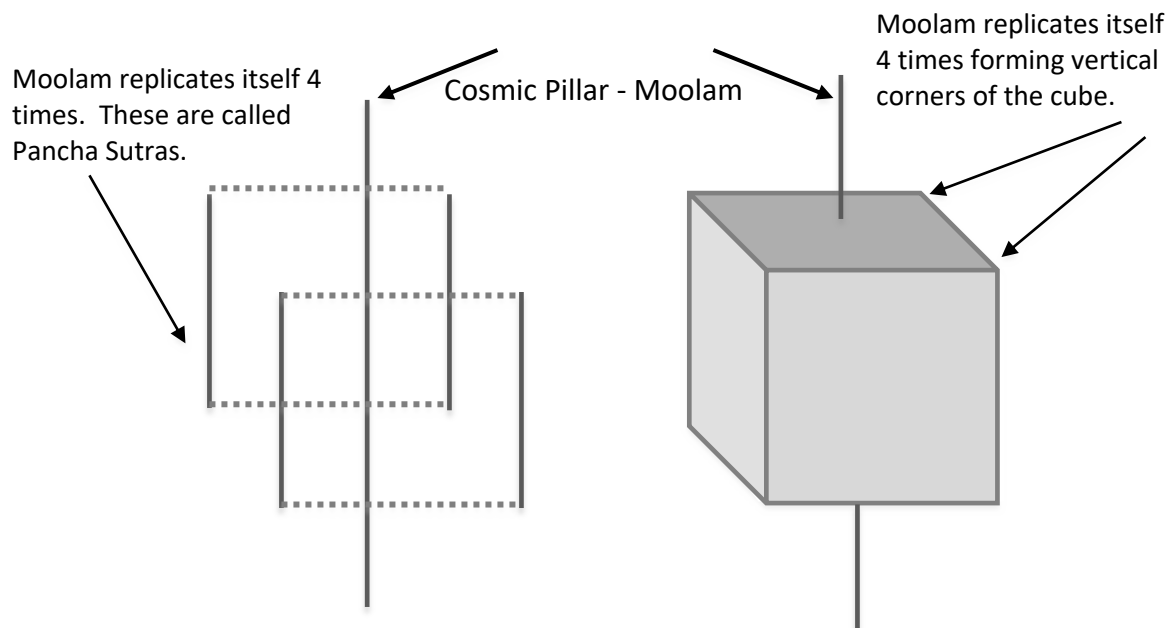

Thus, being self-conscious, Moolasthan principle multiplies itself four times, creating the four corners of what then becomes a six-sided cube (Murukoli arusudar – beautiful Light form with six faces). This six-sided cube provides a boundary within which the particles of light and sound can be contained in the form of square waves and can manifest as the visual and auditory forms through dispersion into sine waves and thus take form without complete dissipation. (Later in the discussion of building architecture you will see that the vertical corners or replicates of the Moolasthan described above are mirrored in the form of the corners of the main wall in a Vaastu house).

The central Moolasthan then becomes the infinite thread or string that continuously emits light and sound particles that give rise to matter. This macro-cube becomes filled with untold numbers of micro cubes each of which have a lively, vibrant thread of light through its vertical center (miniature Cosmic Flame called Brahma Sutra). The entire Cosmic Body or Cosmic Space is filled with these microabodes with a vibrant thread of light that is akin to String Theory (a series of strings or threads make up the fabric of the Unified field).

Representation of this self-spin is noted throughout history in many cultures, including China, Tibet, Nepal, Mexico, Native American, South Pacific, and of course India. The images or a permutation of the image is in the form of the *swastika*. This image is not to be confused with the tilted swastika used by the Nazis.

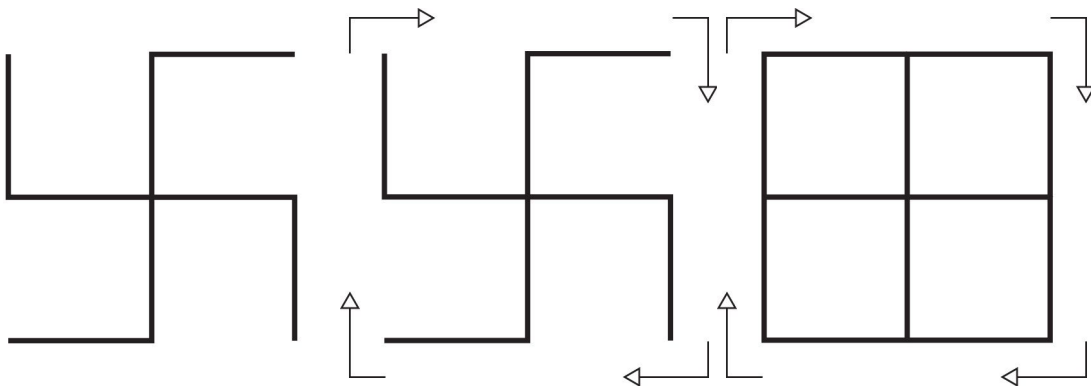

As the commingling of the elements of 1. Absolute Space and 2. Absolute Time continues, a third element 3. OM Light is produced. Then, with the commingling of 1. Absolute Space + 2. Absolute Time + 3. OM Light a fourth element is produced called OM Sound. Right here at this very moment you can see that OM Sound is a well-known element mentioned profusely in Vedic texts, but OM Light has been left out of the Vedas. OM Light eventually gives rise to all visual forms and OM Sound eventually gives rise to all aural forms (language etc).

As this unmanifest structure continues to spin around the central point called the *Bindu* Point (micro cube), and with the commingling of the four elements the cubicle shape gains more structure and mass.

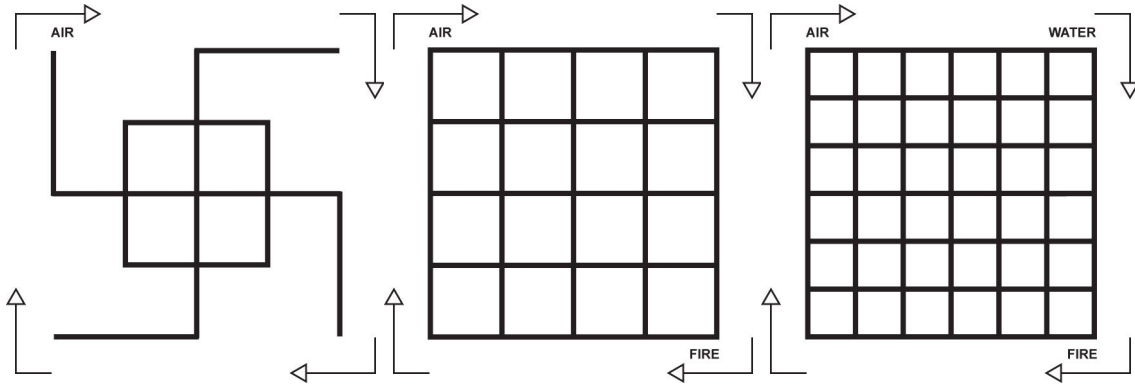

With the continued self-spin and additive, commingling effect of 1. Absolute Space + 2. Absolute Time + 3. OM Light + 4. OM Sound, we see the formulation of yet another element called Air. This is still in pre-manifest crystalline structure. The qualities of the element are not yet the gross qualities that can be perceived in the manifest world – they are the elements in their Luminous form. Note the position of the formation of the Luminous air element within the cubicle structure. It is as if the centrifugal force of the self-spin caused the previous elements to coalesce as the air element in that locality in the Time/Space continuum.

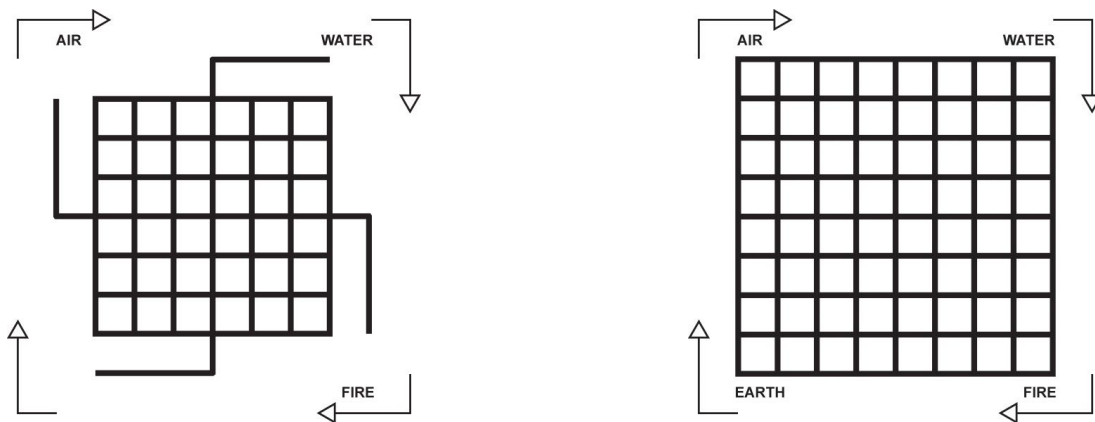

Self-spin continues, and with the addition of the Luminous form of the air element, the micro cube begins to take on more mass as 1. Absolute Space + 2. Absolute Time + 3. OM Light + 4. OM Sound 5. Luminous Air commingling and coalesce.

Through Time, that is, the Time it takes to spin a half turn, the commingling and coalescence of the existing elements form a new element. That element is Fire in its Luminous form.



Notice that the elements form the Luminous Fire element in a specific quadrant just as the previous elements formed the air element in a specific quadrant. Why? It is due to Time. (Absolute Time, not conceptual time). *Time creates, sustains, and destroys all, so created.* (Mayan, *Aintiram*)

As self-spin continues, the elements with their new companion Luminous Fire continue to add unto each other and coalesce again and again, forming Water element in its Luminous form.

Once again, the progression continues with the process of all of the previous elements adding together and combining with each other to form yet another element: Earth. 1. Absolute Space + 2. Absolute Time + 3. OM Light + 4. OM Sound + 5. Air + 6. Fire + 7. Water = 8. Earth. Here the elements are in their Luminous form. Creating Eight Absolute Elements in all. These are all considered subtle elements.

All of the aforementioned Elements continue to commingle and develop together in a natural order and frequency to form the Earth element and simultaneously the fully realized 8x8 *Manduka Mandala*. This all takes place in the Unmanifest Field of Vastu.

Mayan speaks of the subtle and gross elements in his *Aintiram* and *Pranava Veda*. He considers Time, OM Light, and OM Sound as subtle elements and the Pancha Bhutas (five elements) as gross elements. In these diagrams, I have shown the formation of the five elements in the unmanifest subtle level. The implication here is that the five elements, known as Pancha Bhutas or gross elements, while not fully manifest, are pre-formed during the manifestation process in *seed form* or *Luminous form*.

As we see, through Time or pulse the commingling of these elements (Space, Time, Light, and Sound) all potentiality exists. Inherent within this Light and Sound pulse, pre-manifest forms of the material elements (subtle space, air, fire, water, earth) exist. These are the elements that eventually form material space, air, fire, water, and earth.

As these pre-elemental forms arise, an 8x8 cubical form with 64 cells emerges – as yet unmanifest pure energy. This 8x8 form called *Manduka Mandala* or *Vastu Purusha Mandala* continues to spin in a clockwise direction. The drama of material creation occurs.

A subtle but important point is that the word *creation* is not fully appropriate here. Creation implies making something out of nothing. In this process something is made – but not out of nothing. That something is the material world from the finest to the grossest form. What has been described as *nothingness* by modern science and philosophy is really a Unified Field packed with vibrant cuboidal luminous forms each of which is a fetus (*Karu*) for birthing the material world. Thus, the term manifestation is more accurate because the actual event is a transformation of energy to matter and the

two are equal ( $E=mc^2$ ). In other words, this Unified Field called Brahman does not create something outside itself – rather, it manifests itself as innumerable forms within itself.

There are several important points to note here:

1. We now have an 8x8 cube. This 8x8 cube is called Manduka Mandala. Manduka means frog. The significance of this name of a leaping or jumping creature associated with this Mandala will become clear as you read on.
2. There are 64 modules or *Padas* within the 8x8 cube. Each module/pada within the cube is of equal size and shape. Within each module or sub-cube, the process just described (formation of Time, OM Light and OM Sound, Air, Fire, Water etc.) is occurring on a miniscule level and mirroring the original process that we are discussing.
3. As the original micro cube continues to spin and expand through Space and Time, and as the elements of Air, Fire, and Water and Earth are formed, Space organizes itself in cubes that mirror the original micro cube. These cubes are strung together, forming bands around the central point. Remember that the origin of the micro cube was a pulse in Absolute Space. This pulse caused the onset of Absolute Time. Pulses in Time linked together form rhythm; rhythm through Space forms frequencies; frequencies form meter or beat; frequencies and meter/beat have a numerical equivalent; the numerical equivalent can be translated into specific qualities based upon the length of the beat and frequency, just as the various lengths of strings on a musical instrument produce different qualities of sound when plucked.
4. The individual horizontal and vertical lines contain the potency of Primal Light and Sound in the form of frequency.
5. The frequencies created by the cubes strung together form Space/Time bands around the central module or pada that expand outward as each element is created. These are bands of energy or frequency that have particular attributes based upon the elements that predominate within these bands. This will become clear as you read on.
6. The cubical structure of the 64 squares of the Manduka Mandala is the graphic and atomic structure of the whole Cosmos and is the modified version or representational version of the *Pranava Veda*. The exact center of the 64 squares is called Moolam or Primal Dot. The Primal Dot is square in shape and has within itself the presence of 64 squares and within those 64 squares is another Primal Dot with 64 innate squares with Primal Dot ad infinitum. (Dr. S. P. Sabharathnam, p xi, *Mayan's Aintiram*)
7. Each module or pada within the 8x8 structure resonates with a specific Space, Time, Light, Sound, and Elemental frequency based upon its position in the Space/Time continuum. This frequency is called a luminous body or *Devata*. This *Devata* (Padadevata) has particular attributes based upon its position and qualities in the Space/Time continuum (placement among the 64 sub-cubes or padas). These Padadevatas are also referred to as Riks or Rikshas.

While the above are just static images, it is important to remember that this is a very dynamic process. Each of the bands around the central nucleus are vibrating frequencies in constant motion fluctuating and pulsing in a specific rhythm that creates a whole structure that is in constant motion.

This 8x8 Manduka Mandala is a vibrant structure of Primal Space, Time, Light, Sound, Air, Fire, Water, and Earth. It is the manifested movement of rhythm or frequency over the space of the mandala constituted of 64 squares that gives rise to Form. What we have thus far is the invisible process of manifestation. Now we move to the visible process – while invisible to the naked eye, it is nevertheless the transformational process that leads to the formation of all material objects.

The 8x8 grid – Manduka Mandala - is the fabric of the Unmanifest Universe. It is the unfolding of Absolute Space born of its love for its own beauty and desire to savor that beauty.

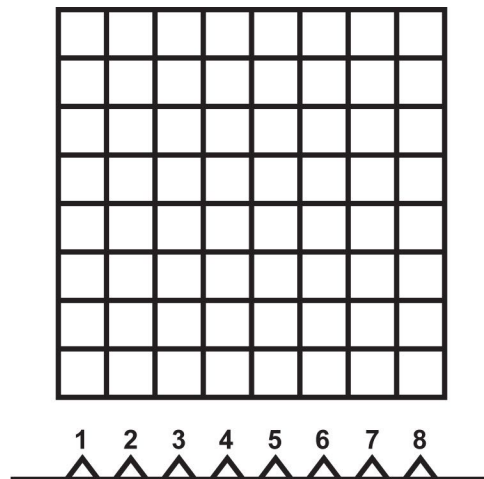

An interesting point to note is that each string of modules represents a pulse/beat creating rhythm or frequency in the Absolute Space/Time continuum. 8x8 modules = 8 beats. This rhythm or frequency exists in the form of sound and light waves. This is reflected in the Pranava Veda verse below.

*The self-effulgent light transforms into a flame, which spreads in all directions as a creative light. This light infuses the invisible and visible spaces **creating a mathematical order**, which is ever existent. Vibration of OM Sound and the magnificent force of Cosmic Light generate sound (sound particles). Vibrant stillness of OM Light creates a beautifully spread enormous flame. (Vs. 2)*

In verse 3, mentioned earlier, we have mention of both the mathematical order and the 64 microabodes residing within the grid lines as shown above.

*The mathematical state of this square is a composition of 64 microabodes or grids. The luminous primal ember contained within this square has enormous potency. (PV vs. 3, Translated by Sthapati Santhana Krishnan and Architect Krithika Karuppiah)*

Understanding the full scope of the meaning of *Time* is of utmost importance, for it reveals the principles at play in the underlying causal force responsible for the genesis of the material world. Time can be viewed as a noun indicating frequency or beat and as a verb transitive indicating a process. We have discussed Time as a frequency; let us now discuss *Time* as a transitive verb.

### **Time or Kaalam/Kaala as a Process**

We think of Time as having to do with minutes ticking by on a clock. With this definition in mind, Mayan's writings can at first be confusing unless a deeper understanding of the word "Time" is discovered. Mamuni Mayan refers to Absolute Time as Kaalam or Kala. He says that it is Time that creates, maintains, and destroys. As I investigated this word, I asked many Indians what they took the word Kala or Kaalam to mean. Without hesitation, they all answered, "Time."

Mayan also defines Time as the vibration of Cosmic Space or the pulse/frequency exerted by the vibration of Space – consciousness – luminosity. It is through individuated time pulse or time units that – defined by their beat – all individuated objects get their qualities. He says that the dimensions of any building are units of time. The Tamil word for Time is Kaalam.

Knowing the deep significance of every word used by Mamuni Mayan, I felt compelled to dig further into the meaning of Kaalam. Many dictionaries reported that the meaning was "time." One dictionary, the Cologne Online Tamil Lexicon, gave a deeper and much more significant meaning to the word Kaala: 1. to mix, unite, join; to commingle, combine; to be absorbed, 2. a process.

Exploring the meaning of Time further, the etymological meaning of the Tamil term "Kaalam" is to put forth, to give rise, to impel, to incite and urge on. It is in fact the vibration of Space that puts forth or gives rise to the manifest world, and thus this vibration of space is referred to as Kaalam or *Time*. Space and its' vibrating state called Time are really one – they cannot be separated as *Time* or Kaalam are in fact simply scientific expressions of Absolute Space, or Brahmam on the move. This movement is Divine Rhythm. Yet, it is in the same breath a scientific principle underlying the physical and non-physical world.

Elsewhere, I found the meaning to be *to flow as one*.

I find this to be very revealing in light of what Mamuni Mayan says and what is written here based upon his writings. It is written that the eight gunas/elements grow from one another as a result of Time. Time is described as a pulse of movement in Absolute Space.

As a result of that movement or pulse, OM Light arises. As Time and OM Light commingle and flow together within Space, OM Sound arises. Space, Time, OM Light, OM Sound commingle and “flow together” forming Air; then all of those commingle, forming fire and so on.

When Mayan uses the word Time or Kaalam, what he really meant is that Time is a process in which Absolute Space commingles with itself and creates OM Light, which commingles with space and manifests OM Sound, etc. And all of those individual elements mix, unite, and flow together, ultimately manifesting as the material world. Here we are given a deeper insight into Mayans meaning of Time or Kaalam. When we see "Time" written, what is really implied is that it is a cosmic process that has the elements of mixing, uniting, and flowing as one. It is this mixing, uniting, and flowing as one that is the creator, maintainer, and destroyer of all things. Thus, the notion of Time becomes a concrete scientific term that describes a scientific process fundamental to Vastu Science, the science of manifestation.

Dr V. Ganapati Sthapati provides another view of Time that deepens one’s understanding even more:

*The vibration of this OM Light is called Time or Kaalam. The vibration of the primal OM Light is the dance of Lord Shiva and that of sound is Uma. Hence 'Omkaara' Natana. Uma is 'word' (vaak) and Shiva is 'meaning' (artha). So, Mayan says that Kaalam is the creative element of all the objects of the universe and adds that the universe itself is the product of Time. 'Time is the creative source of all objects. It is time that changes into form. It is time that blossoms into the universe and Kaalam thus does wonders' – Mayan. Therefore, Kaalam itself is designated as Kaala Brahman. Kaalam, in simple words, is the speed or vibration of energy or light. The summum-bonum of these discussions is that vibration causes all phenomena. This concept is extended to poetry, music, and dance where Kaalam is redesignated as Taalam, maatra, or kaalam, the ruling element of all forms of poetry, music, and also dance. What would be unique and astonishing is that the same Taala measure is extended to create visual material forms (time-spaces) of which one is the building, whether it is a temple or house. Sculptural representations are also born of this scientific theory of rhythm (Taala), and therefore they are divine and worship worthy.*

*Temple Architecture: The Living Tradition*

*Dr. V. Ganapati Sthapati*

Throughout Mayan’s writings he refers to Kaalam as “Time God.”

Mayan says:

*It is Time that creates; it is Time that maintains; it destroys; it conceals; it sets right the discordant and disproportionate aspects and effects purity; it makes the fruits fructify; it*

*stabilizes; it assimilates; it provides an effective and great path; it brings into effect a supreme and sacred form. (Aintiram: 815, Dr. S.P. Sabharathnam commentary)*

The deep meaning expression “*viditthuk-koduttha*” denotes the orderly behavior of divine energy. It is this orderly behavior underlying *viditthuk-koduttha* – the manifestation of the unmanifest. It is Time that functions as part of this process.

It is only because of Time or frequency (movement of consciousness within itself) that Space or Brahman manifests itself into material form. Time is, in effect, simply Space or God itself moving – vibrating. Mayan says that it is Time that functions in every living being as in-breath and out-breath. Time is the dance and Space is the dancer. They are one and the same. Thus, we have the concept of Time God.

Mayan says in his Pranava Veda verse 1:

*OM Light and OM Sound are the Primal Source of all manifest forms. OM Light is aroused by its own effort in a state of disorder and appears as a flame. The state of OM Light and OM Sound in Space is a magnificent luminous six-faced Light form that is called “murukoli”. The transformation of OM Light and OM Sound through the five stages is concealed in the five-fold knowledge, of which, this is the first. This process of transformation of disorderly OM Light and OM Sound into orderliness is found in all five-fold material forms.*

More sayings of Mayan regarding Time:

*The throbbing or forcible movement of the Primal Space or Mulam (Moolam) is called Time (Kala). The place where this throbbing or movement takes place is called Space (inner space called ullam). The form assumed through this throbbing is called creation/manifestation (Porul). The numerical system shows the essential nature of mula – vastu, through the expositions on time, space, and creation (manifestation). Aintiram 16*

*When the traditional practitioner of Vaastu analyses the metrical syllable (phase or rhythm of primal existence) and understands that it exists for the purpose of regulation (control) and order, then naturally there would arise a state of beatitude and beneficence in which all objects meant for ephemeral and sensual pleasures get affected. Aintiram 218*

*... those who execute their creative works through divisional process involving Ayadi etc. (using the Ayadi formulas that require division to be discussed later) could surpass even the providential course of events and perceptually see the light energy. Aintiram 255*

*The process of constructional science shines forth as the basis of creative order and it is capable of effecting luminosity. (Effecting luminosity means effecting pulse or Time. In other words, constructional science provides the knowledge for controlling/effecting Time.) Aintiram 550*

*With Ayadi, we determine the rhythm or Time measure of a building – in other words, the time units of the building. This then determines the luminosity or consciousness of the building. We then can be said to control Time and Consciousness. Aintiram 685*

### **Another View**

There is another way to visualize the manifestation process. As mentioned earlier, we can consider the concept that the manifest world began as a single point in the body of consciousness – moolam. From this point, within the structure of Eka pada – undifferentiated Field – the moolam or cosmic fire extended outward in two directions forming two lines – Brahma Sutra and Civa Sutra – thus dividing itself into four units. Then again dividing it self into eight units, sixteen units, thirty-two units, and sixty-four units. Each division is through the extension from point to line to form, expanding outward as square forms forming square belts of energy around the central point. This outward expansion is shown as the development of energy belts around the central nucleus later in this text. The significance of this perspective will be seen later under the discussion of energy belts around the central Brahmasthan in a building.

The point in the center can be seen as the tip of the pyramidal form mentioned above. In the expansion outward, Brahmam divides itself by creating replicas of itself through waveforms. The rows of lines are vibrating forms within which are replicated pyramidal forms that gush and spin, have a cubical center, and then again expand outward ad infinitum. This is another way of viewing characteristics of the manifestation of energy to matter. It is a bit of a repetition of previous material with a different slant.

The point here is that the manifestation process is a multifaceted process with a number of actions occurring at once. It is both simultaneous and successive. Each way of viewing this process is ultimately reflected in the process of applying the Vaastu Shastras to building architecture. It is also reflected in the other Cosmic arts – dance, music, poetry, and sculpture.

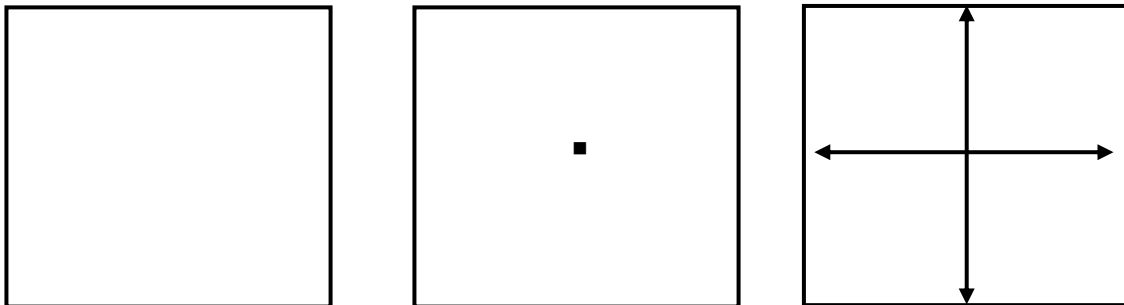

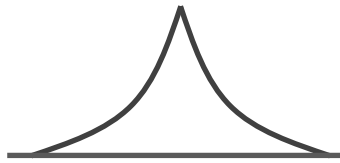

This is the side view, and the three preceding and three following diagrams are a top-down view. The curvature of the form is not seen in the top-down view. Here we have an extension upward of Moolam and a spreading, swelling, or extending of the Cosmic material. We see this form mimicked in Vaastu architecture, especially in Kerala and in Asia.

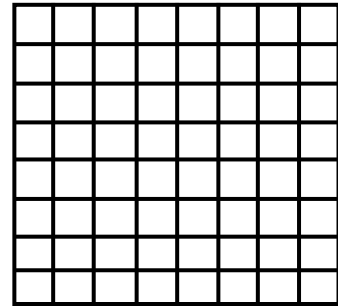
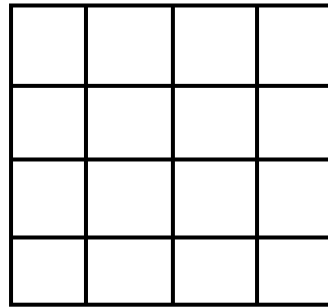
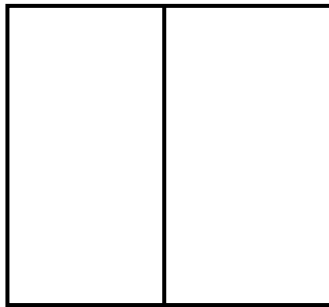

We can see from this that the definition of the word “Brahmam” is appropriate in that Brahmam means expansion and growth: to swell, growth, expansion, evolution, development, swelling of the Spirit or soul. This is a technical term that has been misunderstood by literary thinkers. It is a scientific term that describes a process in the Quantum Field.

I have mentioned “self-spin” in several places throughout this text. Spin is a characteristic found on every level of the manifest world from the largest of the largest – clusters of galaxies – to the smallest of the smallest – sub atomic particles – and everywhere between. Galaxies spin, planets spin, atoms spin, and there is spin occurring on every level in every manifest form. The source of this spin is Brahmam or Consciousness – the Field. This universal spin can be explained by various theories such as changes in density, gravitation, and other explanations shown through mathematics. Yet, no theory or mathematical formula has truly explained the origin of *spin (spin theory)*.

Mayan says that this is a self-generated spin. We might think of it as a result of the exuberance of Brahmam as it gushes forward after having contracted within itself. Think of a person that is filled with joy and who then starts spontaneously swirling around with his or her arms extended. This joyful person becomes like the whirling Dervishes as he or she dances with joy. We can say that Brahmam swirls, spins, and dances with joy as it manifests its own qualities as frequencies of OM Light and OM Sound then farther as the gross elements. We can say that this joy is the origin of what we call “Spiritual Bliss,” the joy of Brahmam as It experiences Itself through manifestation. *It is this “joy of Brahmam” that we have the opportunity to experience when living in a Vaastu home.*



Continuing with the manifestation process, we can observe more dynamics activated throughout the process. We have mentioned that waveforms spread out from the central point or Bindu. The following diagram demonstrates the growth dynamics of the unmanifest Fabric of Creation in values of eight and steps of five.

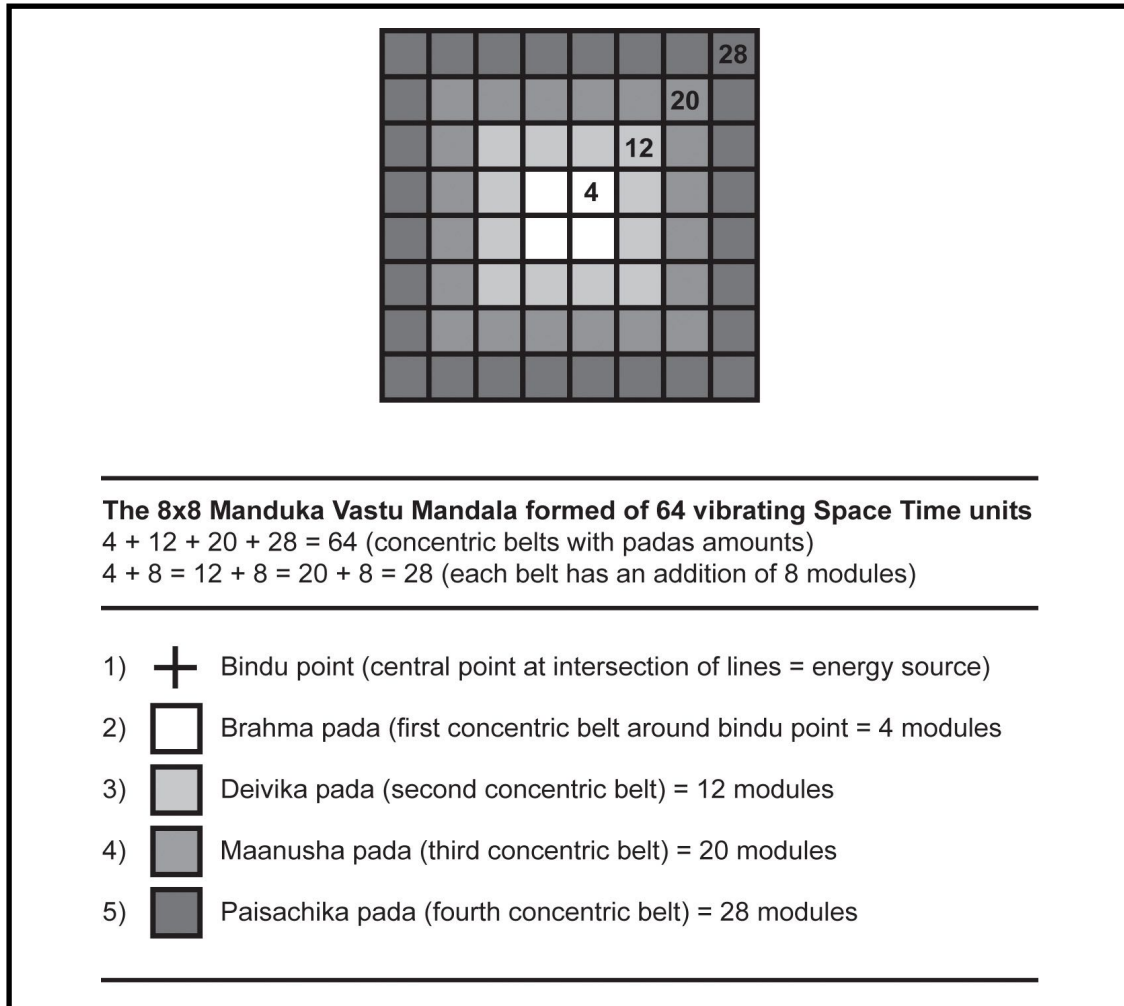

By observing this process of manifestation, two dynamics of manifestation are evident:

1. Manifestation occurs in additive values of eight ( $4+8=12+8=20+8=28$  with a total additive factor of 64).
2. Manifestation occurs in sequences of five steps known as the Pentadic Order.

In other words, five stages occur with an additive numerical frequency of eight:

(1) The subtle energy point in the center becomes a self-effulgent energy generator pouring out waves of energy by (2) becoming a self-spinning stabilized structure of four padas/modules then (3) adding eight units of energy to manifest the 4X4 structure of 16 units or modules; then (4) adding another eight units of energy to manifest the 6X6

structure of 36 units or modules; which (5) then adds eight more units culminating in 64 units or modules strung concentrically around the Bindu point or central generator. The entire process produces a total of sixty-four (64) vibrating units with *each* concentric belt having its own wavelength (4,12,20,28 modules) and waveform and individual vibration while contributing to the sum total vibration of the whole.

(2) These dynamics of manifestation simultaneously and successively produce two other observable phenomena:

1. The elements (air, fire, water, earth – manifested from space), which tend to constellate in the four quadrants of the 8X8 mandala, are produced as waveforms or frequencies – each having specific and different qualities and characteristics. This means that each element vibrates with its own frequency and demonstrates different qualities as a result of its frequency.

2. The outpouring of energy from the central Bindu point distributes concentric modules or padas linked together around itself with each concentric belt having unique and separate square waveforms and frequency. Thus, each concentric belt and the individual units or modules within each belt has its own qualities and characteristics.

While this knowledge is significant of itself, when these phenomena are viewed in light of material manifestation as built space in architecture, the significance becomes stunning and profound.

A vital point here is to consider what the complete form of the 8x8 microabode looks like. Among other things, we know that it is cubicle and that it has a vertical thread of light through its center. In addition, it is composed of four concentric belts of energy that move outward as the thread of light vibrates. The thread of light is vibrating or dancing primal fire. In addition to moving outward, the concentric energy belts also move upward, forming a stepped pyramid. In its silent and unmoving state, it is cubicle. In its active state, it takes on other geometric forms. This same form exists on the macro level as the embodiment of God or Brahman; in the micro-state, it is the embodiment of the inner Being of all living things.

The term *Brahman* is frequently used in Mayonic Science. It is useful here to understand that *Brahman* is a scientific term that means: growth, expansion, evolution, development, swelling of the Spirit or Soul. This definition is critical in understanding that this process of the growth from a point (the Bindu) outward in energy belts is a growing, expanding, or swelling of Consciousness or Space – Unified Field. This growing or expanding of consciousness occurs on the micro level at the level of individual soul or Jivatman (microabode) as well as on Cosmic or Universal level of Paraatman (macroabode). (Our tradition does not differentiate between Atman (Universal Macroabode) and Jivatman (individual microabode). It views them as one and the same. Atman = jivatman just as energy = matter or  $E=mc^2$ .) This can be seen through the growth, expansion, or evolution from the single point through the various stages of the growth of

the energy belts expanding outward. As the energy belts grow outward, they also grow upward and downward causing the cube to *swell* (see diagram below). It is this swelling of the Soul that gives the feeling called *Spiritual Bliss*, which is experienced while being in a Vaastu building.

Mayan perceived the complete form of the 8x8 microabode as thus:

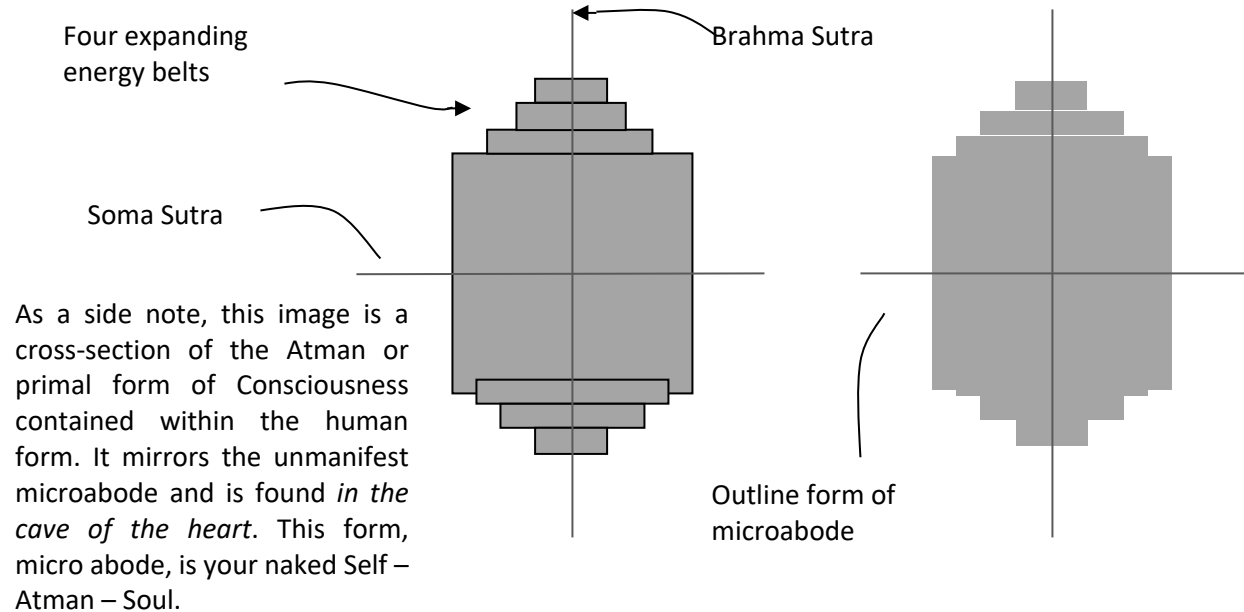

Dr. S.P. Sabharathnam, in his detailed translation of Mayan's Aintiram said, *The most important scientific theme ensouled and explained in this work is the concept of microabode, the basic space-cube which gives rise to the emergence and existence of Primal Space, Time rhythm, form, and matter.*

Mayan, in his treatise on astronomy called *Surya Siddhanta* gave this description of Brahmam: *Tri-dimensionally every particle of space is a subtle cube of Energy, called Chitrambalam or Micro-Abode within which there is a 'shaft of light' or 'shaft of consciousness' vibrating or performing a 'rhythmic dancer'. This is the dance of the Cosmic Dancer, Lord Shiva. The whole universe is filled with subtle cubes of energy called Karu or Bindu or Foetus.*

Mayan also said: *Supreme Being is omnipresent and the exceptional art (manifestation process) is eternal. Experience of the Supreme Being's consciousness led me to worship spiritual Light. Blessings of the Supreme Being helped me visualize 'Nataraja,' the dance of Shiva (vibration of the thread of consciousness – Brahma Sutra). Blessings of the Supreme Being helped me create this magnificent art.*

Nataraja or Luminous thread is the Cosmic Dancer who dances or vibrates by its own volition as it arouses itself to manifest within itself. This vibration or frequency gives rise

to the entire material world as individuated frequencies or waveforms. These manifested waveforms called Vishnu (Vaastu) become the Dance.

Ancient and modern shilpins are creative architects who give concrete expression to the cosmos. Pranava Veda outlines the very nature of Primal Existence, then Vastu Shastra shows us how to mirror that primal existence in something called built space. We take various building materials and manifest a direct mirror of Nataraja in the material world. This is the essence of Mayonic Science and Technology. This form of Nataraja, seen in several places in this text, in a visual representation, developed by Mayan to encode this Cosmic Dance. Every detail of the form is scientifically significant.

While Mayan gave the most direct and detailed understanding of this micro and macro form, other sages have spoken of it as well.

*When I saw the effulgent abode of my Lord,  
I bowed to it in awe and reverence ...  
I rejoiced with my whole mind.  
That Divine Vision is ever present to me ...  
I have attained the form of Love.  
(Vs. 3897, Thiruarupta, Tamil Saint Ramalinga, translated by Sri A. Balakrishna Pillai,  
1966)*

Here, the beloved Tamil saint Ramalinga, describes this internal form – *abode of lord* indicates that there is a "form" in which the *Lord* exists – the same *microabode* perceived by Mayan. This form is the *form of Love*, or from Mayan's perspective, the source of resonance with the divine called Bhakti. This Bhakti or resonance brings a spiritual bliss one might compare to love.

The great Tamil sage Thirumular, who wrote the seminal scripture Thirumanitiram, also gives us a hint of this concept of Mayan:

*Vs. 114: He Planted His Feet on My Heart  
All impurity He shattered – our Nandi, Forehead-eyed,  
Shattered to pieces before His opening Eye of Grace,  
His Eye, at whose radiant light impurity quails;  
So transfixed He His Coral Feet on heart of mine, Crystal turned.*

*Crystal turning* is an amazing concept offered in this vibrant poem. The microabode is crystalline in shape. It is a cubicle form with a pyramidal shape on the top and bottom; hence, it looks like an uncut diamond. It is said to be located within the human body. It is a direct replicate of the Cosmic Body. Running vertically through this crystalline form is a vibrant thread of light known variously as Moolam or Brahma Sutra. The Nataraja form of Shiva indicates this Brahma Sutra graphically. This poetic phrase, *So transfixed*

*He His Coral Feet on heart of mine, Crystal turned,* refers to this dancing thread of light and the crystalline structure of the microabode within the heart of each person.

This poet noticed that his own form, the crystalline structure of the microabode, becomes activated through this experience at Chidambaram (a perfect Vaastu temple in South India). His poetry comments on this genuine experience of Bhakti or resonance and its effect upon himself. This experience does not only come to sages, rather it comes to all who partake of the experience of being at the door of Vaastu temple or residing within a Vaastu house.

Vibrations from a building can be transferred to its inhabitants. We are affected by the vibrations or waveforms surrounding us, both the positive and negative. With the principles of Vaastu, you can build a home that not only resonates harmoniously with you, but also can uplift your vibrations. Your home can support your wellbeing, health, happiness, prosperity, and inner-peace.

One of Einstein's great insights was to realize that matter and energy are really different forms of the same thing. As illustrated in his equation  $E=mc^2$ , matter can be turned into energy, and energy into matter. This is the basis of the science of Vastu/ Vaastu.

*What we perceive as qualities of matter, are actually differences in periodicity.* Bertrand Russell

*The generation of forms out of the vibration of energy-space is identified and quantified by Mayan as "eight" and multiples of eight, in that order. Hence, in the table of time-units and space units, you find the evolution of the measure starting from zero and evolving into forms, in terms of multiples of eight. ... The nature of the number eight is to turn into form.*

*This is the basic formula of rhythms influencing the growth of all animate forms in a mathematical order, and this is the fundamental measure adopted by the dancers, musicians, poets, sculptors, and architects for all the development of artistic forms that they experience and generate from within.* Dr. V. Ganapati Sthapati, Building Architecture of Sthapatya Veda. (Please stop reading this section and go to **Appendix A**)

## Chapter 5

### Eight Equals Nine: The Relative Theory of Manifestation

Understanding the mystery of how Unmanifest Vastu becomes manifest Vaastu rests in understanding how the fabric of the unmanifest – the 8x8 cubicle form Vastu - becomes the fabric and fundamental structure of manifest Vaastu – the 9x9 cubicle form.

*“This has [...] led to the discovery that the universe is subject to a mathematical formula and architecture is yet another manifestation of this formula.” (Dr. V Ganapati Sthapati, Building Architecture of Sthapatya Veda p.49)*

We see confirmation of the details of this manifestation process outside the Mayonic literature in Chapter 9, verse 8 of the Bhagavad Gita where Lord Krishna describes his manifestation process to Varuna:

*prakritim svaam avastabhya visrijaami punah punah*

*Curving back onto myself, I create again and again...*

(Interpreted by Maharishi Mahesh Yogi, Interlaken, Switzerland, 1976)

As the 8X8 cubical Manduka mandala continues to spin through Space and Time, it begins to take on different shapes.

Those shapes begin with the square, which transforms itself into a polygon, and then a circle. The circle then transforms itself back into a cube/square with one more string of sub cubes making a 9x9 cubicle structure described in the following pages.

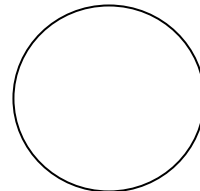
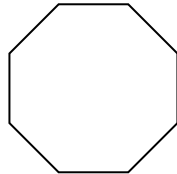

Fully formed 8x8 Manduka continues to spin. The elements are not in manifest form at this time.

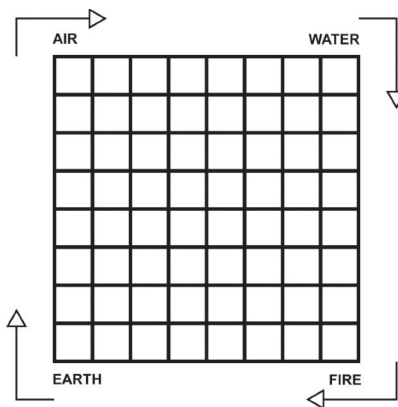

The sheer velocity of the spin and the collection of the elements in the corner padas cause the corners of the cube to curve into itself.

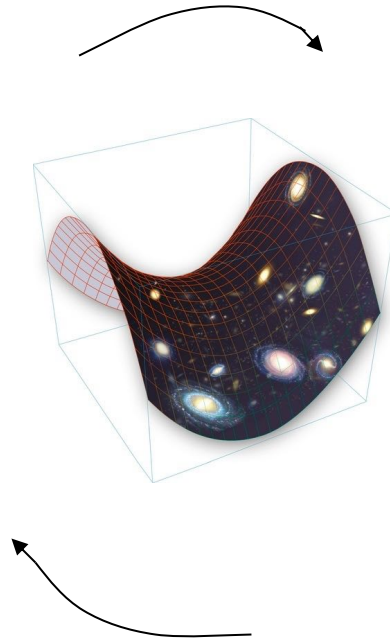

With this spinning and curving back onto itself, an octagon form takes shape.

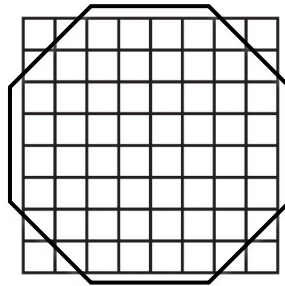

The corners of the octagon also fold in or curve into themselves, forming a transitional polygon shape.

The spin and inward curving continues, creating a dynamic circle. Inherent in the octagon and circle is the subtle 8x8 Cosmic grid.

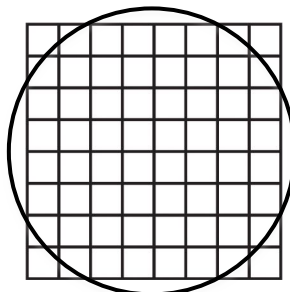

*Curving back onto myself, I create again and again...*

These three primal forms, square, octagon, and circle, have distinct and individual qualities. They form the mass through which the material world is created. They are called the three gunas or qualities.

The perfect square form is called Satwa; the octagonal form is called Rajas; the circular form is called Tamas. A visual summary of this is presented by Dr. V. Ganapati Sthapati in *Building Architecture of Sthapatya Veda* and other texts and is presented below:

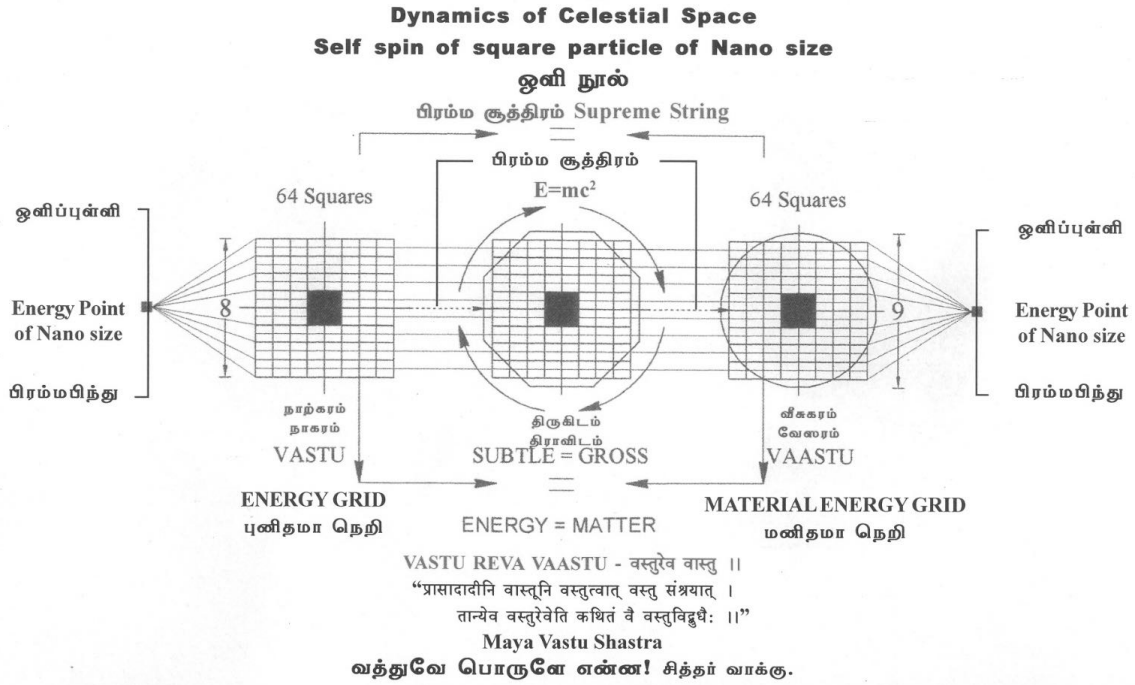

Following this three step evolution of form, the circle is transformed into the shape of its underlying pattern – the square (six-sided cube). Through this process, the subtle 8x8 cube transforms itself to the grosser 9x9 cube. In other words, this primal subtle form becomes denser and thus expresses itself as a 9x9 cube rather than an 8x8 cube. The cube contains the same area but enlivens itself with additional padas (micro cubes in the grid). Interestingly enough, the 8x8 is inherent in the 9x9.

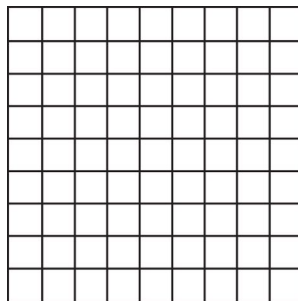



According to Pranava Veda, these three intermediary archetypical forms have separate qualities. Thus they are called the three Gunas. Guna means quality. They are, from left to right, Satwa (8x8 square); Rajas (octagon); and Tamas (circle). As far as we know, Mayan was the first to describe these names and forms. In modern times, they are thought to mean something other than what Mayan intended. Tamas guna is said to describe something negative equated with lethargy. Mayan, however, did not intend for that to be the meaning. Satwa, according to Mayan, is a steady, restful, and peaceful state. Rajas is a dynamic state of form. Tamas contains massive or gross material qualities.

According to Pranava Veda, each and every material substance, regardless of its outer shape, is ingrained with a three-segmented subtle design. These segments each have an individual design and are linked together to create a whole structure.

These shapes are ingrained within all cosmic and worldly structures, and all cosmic and worldly structures are ingrained in these cosmic structures. This three-segmented subtle design is the subtle form of Pranava (2 OMs). Mayan calls this three-fold cosmic subtle design “mun nilai.”

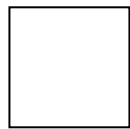
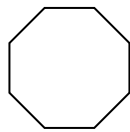
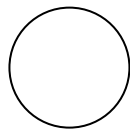

The top circular shape (cylindrical) is known as Rudra Bhaga. It is the form of Tamasa Guna and indicates self-spin and movement – gross and massive qualities.

The middle octagonal shape is known as Vishnu Bhaga. It is the form of Rajasa Guna and is known as the middling form and the transformational form between Tamasa and Satvika. It has dynamic and active qualities.

The bottom square (cubical) shape is known as Brahma Bhaga. It is known as Satvika Guna and is the form of calm and peaceful existence.

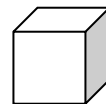
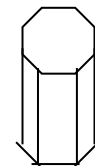

These forms are encoded within the structure of the Shiva Lingam. And the real meaning of the Shiva Lingam is ascertained from what I have just mentioned. It is a visual form of the intermediary part of the manifestation process that is literally contained within each of us.

## Shiva Lingam

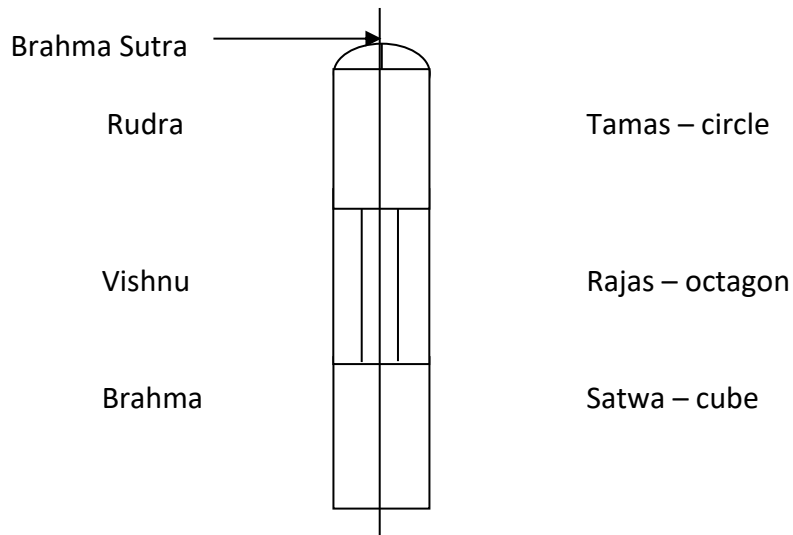

It is interesting to note that the waveforms that make up the octagonal and circular forms are transitional waveforms. They fail to have the stability of the square form. If these forms (octagonal and circular) are used in home building, they will cause a mental and psychological agitation and fermenting that will then cause physical agitation. Thus, these two forms are rejected for homes while the peace-producing square is preferred. In addition, these forms should be avoided for meditation halls and other structures where peace and harmony are desired. Certain public buildings may be designed using these forms.

Many people believe that Pranava refers to the sound AUM. In fact, *pranava* comes from the roots Pirazh + Nava = Pranava. This means to Turn/Flip or turn into nine. Pranava means the transformation of 8 into 9 (8x8 grid to 9x9 grid). Brahmarishi Mayan says in the Pranava Veda that consciousness multiplies itself into eight units or pulses (units of Time) of OM Light and OM Sound. One unit of TIME has two aspects, OM LIGHT and OM SOUND. OM LIGHT divides itself into eight light atoms that become the raw material for all visual forms. OM SOUND divides itself into eight sound atoms that become the raw material for all aural forms.

*"Yettin pirazhve navamenavagi "* – Mamuni Mayan – *The flipping or turning of 8 is 9.*

This combination of eight units of Light and Sound form the "Three Gunas," which then form the five gross elements, or "Pancha Bhutas."

The entire process unfolds a mathematical order that can be emulated for the uplifting of humanity.

From the expression and commingling of the three gunas, a new grid emerges as the grid restores itself into 9x9 cube of tranquility and stillness. This transformation is signified by

the 8x8 Manduka Mandala (frog) leaping into existence as the 9x9 Paramasayika Mandala (Vaastu Purusha Mandala). At this point, the Five Elements have transformed from their subtle state to their manifest state as part of the 9x9 Vaastu Purusha Mandala.

The 9x9 grid (cube) is the fabric of the manifest universe. Its full form is a six-sided cube.

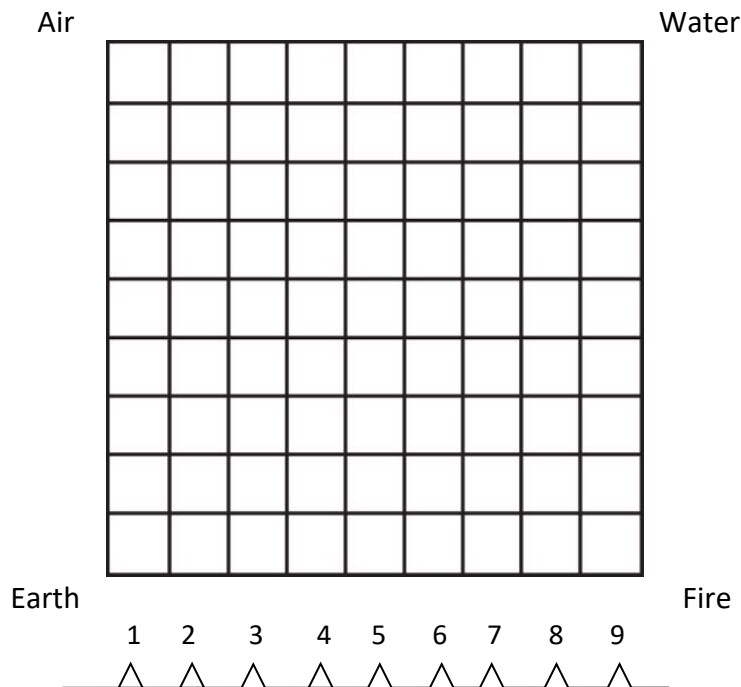
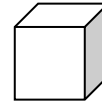

Note here that the strings of modules form pulse/ beat and rhythm/frequencies, known as “time units,” in the Space /Time continuum.

The eight pulses or beat of the 8x8 has transformed into nine pulses or beat, changing the overall rhythm or frequency of the cubical form. This frequency of nine beats or pulses becomes important in Vaastu as the frequency of a Vastu born structure is articulated through numerical functions discussed later as Ayadi calculations. (It is useful to remember that while these diagrams are shown as flat squares, they are in reality six-sided cubes.)

Mayan says, “Those persons who have analyzed the subtle nature of TIME should contemplate the potency of the Primal Existence and realize the manifested movement of rhythm over the space of the mandala constituted of 64 squares which gives rise to FORMS [...] They should analyze the visible process of the gross aspect of the mandala and the invisible process of its subtle aspect.” (Aintiram, vs. 177)

There are several important points to note:

1. There are 81 modules or padas within the 9x9 cube. Each module/pada within the cube is of equal size and shape. Within each module or sub-cube, the process just described (formation of Time, OM Light and OM Sound, Air, Fire, Water, etc.) is occurring on a miniscule level and mirroring the original process that we have discussed.
2. The original micro cube continues to spin and expand through Space and Time. The elements of Air, Fire, and Water, and Earth are formed. Space organizes itself in cubes that mirror the original micro cube. These cubes are strung together forming bands around the central point. Remember that the origin of the micro cube was a pulse in Absolute Space. This pulse caused the onset of Absolute Time. Pulses in Time linked together form rhythm; rhythm through space forms frequencies; frequencies form meter or beat; frequencies and meter/beat have a numerical equivalent; the numerical equivalent can be translated into specific qualities based upon the length of the beat and frequency just as the length of a string on a musical instrument produces different qualities of sound when plucked with varying beats.
3. The individual horizontal and vertical lines contain the potency of primal light and sound in the form of frequency.
4. The frequencies created by the cubes strung together form Space/Time bands around the central module or "pada" that expand outward as each element is created. These are bands of energy or frequency that have particular attributes based upon the elements that predominate within these bands.
5. The cubical structure of the 81 squares of the mandala is (as is the 8x8 mandala) the graphic and atomic structure of the whole cosmos. It is the modified version or representational version of the Pranava Veda. The exact center of the 81 squares is called Moolam or primal dot – sometimes referred to as the Bindu point. The primal dot is square in shape and has within itself the presence of 81 squares, and within those 81 squares is another primal dot with 81 innate squares with primal dot, ad infinitum. (Extension of the idea presented by Dr. S.P. Sabharathnam, p xi, Mayan's Aintiram.)
6. Each module or pada within the 9x9 structure resonates with a specific Space Time, Light, Sound, and Elemental frequency based upon its position in the Space/Time continuum. The position in the Space/Time continuum is determined by the commingling of Absolute Space, Absolute Time, OM Light and Sound, Air, Fire, Water, Earth, and the three gunas. This vibrating frequency is called a luminous body or Devata. Each Devata has particular attributes based upon its position and qualities in the Space/Time continuum (placement among the 81 sub-cubes or padas).
7. The 9x9 module is made up of fractions of time units. These time units are expressions of frequency.
8. Frequency, because it is moving energy, can be measured. The time that it takes to move through space from the steady zero state to its peak state and back to its steady state can be mathematically defined. Thus, the frequency of any given 9x9 module can be described in mathematical terms.

9. The basis of frequency and ultimately Form is Absolute Space/Time and OM Light and OM Sound. OM Light is the foundation for all visual forms and OM Sound is the basis of all aural forms. This principle includes the human form. *Viewed deeply, it is to be understood that the power of primal light is indeed the power of consciousness in each and every soul.* (Aintiram sutra 189)

Mayan describes this entire process in the Pranava Veda and the Aintiram. He describes individual time units, and the progression of their growth into larger and larger units, as modules or padas that are strung together. Mayan says, *The minute fraction of time-unit becomes the basis for mathematical calculations...* (Sutra 176).

The most fundamental idea is that Space (Akasha – consciousness) is the emanator of Air, Fire, Water, and Earth. Brahmarishi Mayan reveals that the entire Space around us goes into vibration and that vibration is called (Absolute) Time. Each energy particle will vibrate and give rise to aural and visual forms. So Time, Light, and Sound as the three subtle elements of creation along with Space, Air, Fire, Water and Earth, being the gross elements, cause the entire universe and all existing forms. Existence is nothing more than vibrating Consciousness – Brahman.

It is interesting to note that all of the elements exist in unmanifest form and then materialize as gross elements.

Mayan says in Verse 4 of the Pranava Veda:

1. Ōm Ōm Maraioli Mōlap
2. PoruLāL Muthalmarai Yoliyasaiyey
3. Ōm Ōm Aimarai Iyaltharu
4. Semmarai Meymarai Olilsayey
5. Ōm Ōm KalaiyoLi VeLiyiyal
6. VaLiyiyal Thēnēr Kātriyaley
7. Ōm Ōm Nilampunal AnalvaLi
8. VinveLi Iyalkalai ViriveLiyey

*The primal material source of Light concealed with Sound vibrates thereby visualizing the hidden Sound for the first time referred as “muthalmarai yoliyasaiyey.” This phenomenon of musical note born out of the vibration of Light is found in the Five-Fold Vedas, which is well done and truthful. This dispersed Light in Space gets transformed into Air, from Air comes Fire, from Fire comes Water and from Water comes Earth. In brief, Sound is evolved from Light due to the vibration (TIME) of Light in Cosmic Space eventually creating the five natural elements. (Vs. 4 ibid)*

Dr. Sthapati mentions this in his beautiful book *Who Created God?*

*God has not created anything anew; God himself becomes the universe and all the objects and beings of the universe. This act of becoming is basically a scientific phenomenon, for which there is a mathematical formula. (p. 11)*

Second only to the discovery – through introspection – of the manifestation process, Mayan discovered that he, as a scientist, sculptor, carpenter and architect, could replicate this process of manifestation by creating enclosed space. He discovered that wherever he created enclosed space, the manifestation process would occur and give rise to energy within that space. He discovered that the variations in all of creation were due to the changes in frequency of the Primal Existence (Vastu) and ultimate mathematical nature of the manifold forms in creation (Vaastu).

He also discovered that the qualities and behavior of the many forms in creation varied due to the mathematical formula equated to any given form and the arrangement and predominance of the elemental factors. With this discovery, he understood that The Primal Existence does not differentiate between good and bad. It just is. It manifests through its own process, creating various forms/frequencies that are harmonic permutations of Itself. However, an individual form may be disharmonic to another individual form. For example, one variety of plant may not enjoy growing next to another kind of plant, while it might thrive next to a third kind of plant.

Furthermore, Mayan discovered that he could create and control the qualities generated by a form (sculpture, house, poem, music, dance) by applying specific mathematical formulas to the creation of that form. Mayan discovered, for example, that he could apply his mathematical formulas to building a house. Depending on the formula used, that house will be harmonic to a human inhabitant or it will be disharmonic to that dweller. If a house was disharmonic, it could affect the life of the person in a negative way. If it was harmonic, it could affect the life of the dweller in a positive way.

This concept of harmony is called *resonance*. As discussed elsewhere in this text, this is the origin of the concept of Bhakti. It is a term coined by Mayan. Many people think of Bhakti as meaning love or service. It in fact means resonance. It has nothing to do with love or service. It means that in a Vaastu form, the form and the individual come into resonance, and that resonance elevates the individual to the Divine level of the form. The Vaastu form is a divine form, and the individual who is in resonance or Bhakti with that form begins to vibrate with the qualities of that form.

This concept can be demonstrated by striking a tuning fork and holding a still tuning fork of the same chord next to it. The still tuning fork will soon be vibrating as a result of being placed next to a vibrating tuning fork.

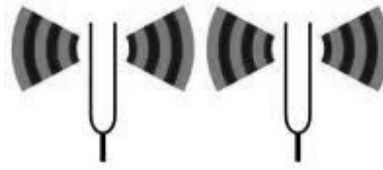

In that same way, the vibration or frequency of the built space will cause the inner space of the dweller to vibrate at the same frequency as the house. The built space emulates the Cosmic microabode and has at its heart – the center of the Brahmasthan or Brahma Bindu – a Cosmic microform. The human has the same microform within in the cave of the heart. The individual microform is like a tuning fork to environmental influences. Whatever is in the environment, the individual will begin to vibrate with that frequency. If you place yourself in the environment of a Cosmic Force, you automatically become in resonance with the qualities of the Cosmic Force. In a Vaastu building, your heart resonates with the heart of the Cosmos – from Cosmic Heart to individual heart. Mayan realized that for a human to be at peace, enjoy health, and experience spiritual bliss, he or she should dwell in a structure that vibrates with those qualities. A Vaastu building is constructed to vibrate with those qualities so that the indweller may live a life of bliss and wellbeing.

You as a vibrating particle in the Unified Field having your own individual experience, which is a mix of joy and sorrow along with an underlying yearning or longing.



**Unified Field  
of Brahmam**  
Vastu Brahmam

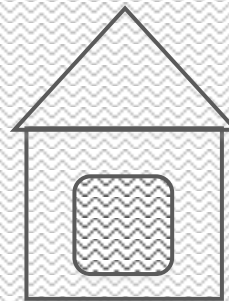

You as a particle living in a Vaastu home (Vaastu Brahmam) vibrating in coherence with the Unified Field of Brahmam. Your experience is Cosmic, and while there may be joy or sorrow, you live and radiate spiritual bliss and happiness. That which you long for has been found and integrated into your experience.

This Cosmic force that we activate through applying the principles laid out in the Vaastu Shastras per Mayan is called Purusha or Vaastu Purusha. It is the manifest form of Vastu Purusha. In the Rig Veda, we find numerous references to Purusha. An entire sukta is called the Purusha Sukta.

Here the Rig Veda says:

vedAhametam purusham mahAntam Aditya varNam tamasaH parastAt |  
tam evam vidvAn amRta iha bhavati na anyaH panthA vidyate 'yanaaya ||

*This great Purusha, brilliant as the sun, who is beyond all darkness,  
I know him in my heart.  
Who knows the Purusha thus, attains immortality in this very birth.  
I know of no other way to salvation.*

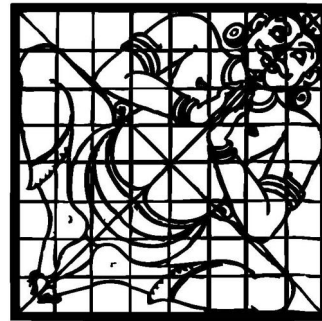
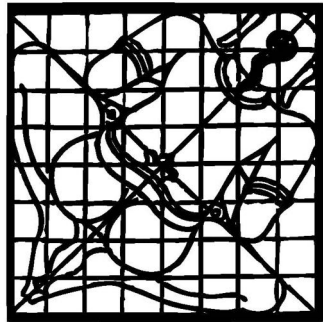

Vaastu Purusha Mandala demonstrated in its traditional form.

Vastu Purusha facing down is symbolic of waves of Vastu energy drizzling down onto and into a Vaastu building. This is Cosmic Space (Consciousness/Quantum field) transforming itself into matter and commingling with Vaastu Purusha within the center of a Vaastu building. Vaastu Purusha facing upward represents the Vastu Energy of the earth rising upward from the earth's central cubical core and entering into a Vaastu building then commingling with Vastu Purusha. Scientists have recently shown what Mayan proclaimed in 10,500 BCE. That is, the central core of the earth is cubical (macroabode).

Swedish researchers have presented evidence to support their new theory about the structure of the earth's core. "We found that the body-centered cubic structure of iron is the only structure that could correspond to the experimental observations," says Börje Johansson, professor of condensed-matter theory at Uppsala University. (Science Daily, Feb. 11, 2008)

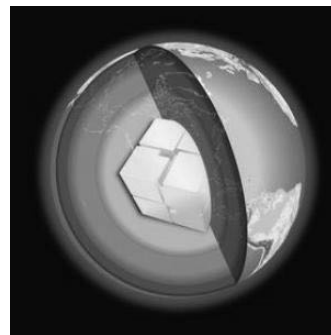



Scientists have estimated that this cubical form is about 1,200 kilometers square. If you analyze this according to Mayan's theory, the end product is amazingly interesting. That is if you divide that number by 9; then divide that product by 9, and do this 8 times, then you come up with a number (about 1 and 3/32 inches) that is very close to Mayan's angula (1 3/8 inches). This angula is the measure found on the thumb and middle finger of the human body of the human who is enlightened or in harmony with the Divine!

1. 1,200,000 m (1,200 km) divide by 9
2. 133,333.33 m divide by 9
3. 14,814.81 m divide by 9
4. 1,646.091 m "
5. 182.899 m "
6. 20.32211 m "
7. 2.258012 m "
8. .25089 m "
9. .027877 m = 1 3/32<sup>nd</sup> "

From this, I can say that 1,200 m is only approximate. But a very close approximation. I believe that if the cubicle form found in the center of the earth could be exactly measured and that that measurement were reduced as above, it would come to 1 3/8 inches (and we can find the exact measure of the cubical earth center by using 1 3/8 inch). I expect the cubicle center of the earth to be, not 1200 m, but 1503.4063 m, the measurement that Mayan says is the finger measurement of the ideal human who is in complete harmony with the Universe.

The 8x8 form is the fabric of the subtle universe – a description of the Unified Field and a description of the body of the Divine – Vastu Purusha. The 9x9 cubicle form is a description of the fabric of the gross Universe known as Vaastu Purusha.

How do we come to know this Purusha in our heart? Our microform is found in the cave of our heart. It is through the resonance we experience in a Vaastu house or temple that we can come to know this great Purusha in our heart.

*In the center of the castle of Brahman (our own body)  
there is a small shrine in the form of a lotus flower (appearance of fully  
blossomed microabode as you look down from above),  
and within can be found a small space.  
We should find who dwells there,  
and we should want to know him.*

*And if anyone asks–  
"Who is he who dwells in the small shrine  
in the form of a lotus flower in the center of the castle of Brahman?"*

*We can answer–*

*"The little space within the heart is as great as this universe.  
The heavens and the earth are there;  
the sun, the moon, the stars;  
fire and lightning and winds...  
For the whole universe is in him  
and he dwells within our heart."*

Chandogya Upanishad 8:1

### **God and Feminine Qualities in Vaastu**

The word *God* as we use it refers to something akin to *Unified Field* or *Quantum Field*. Often in the various texts *God* is referred to as *Him*. It is noted elsewhere that this Field called *God* or *Brahman* has both male and female attributes. This is discussed in the comments on *Nataraja*. In fact, the entire manifestation process relies on the feminine energy force that is called *Shakti*. *Kalam* or *Absolute Time* is considered to be a feminine energy force which is often represented as *Kali* the so-called female deity – in actuality a scientific term. It is significant to note that from time immemorial the Sthapatis and Shilpis have recognized *God* as the Feminine.

### **Shilpi Worship of Goddess**

India's Shilpis have for millennia been holders of the knowledge of the *Vastu/Vaastu* tradition and are worshippers of *Shakti*. This is the *Vastumatam*, *vastu* "religion." This is also called *Mayamatam*, name after its originator, *Mayan*. The Shilpis worship Goddesses *Kali*, *Kamakshi*, *Ankalaparameshvari*, *Akilandeshvari*, *Bhuvaneshvari*, and *Brahma Chamundi*. Science, *Shakti*, and *bhakti* are integrated in the life of the Shilpi.

The importance of the feminine energies is demonstrated in one way through the use of engraved stones used in a special ceremony prior to the construction of a *Vaastu* building – *Vaastu Puja*. These stones are engraved with the five Tamil vowels and placed in the northeast corner of the plot (within the motherwall or foundation) of the building to be constructed. They are called the *foundation stones*. The feminine is the foundation of *Vaastu Science and Technology*.

These vowels signify the aural and visual manifestation of *OM Sound*. They of themselves exhibit wonderful qualities. The Tamil Vowels are traditionally engraved on five granite bricks: ` , ;, u, e, O.

Each of the five vowels represents the two Supreme Brahman – *OM Light* (*Artha Brahman*) and *OM Sound* (*Naada Brahman*), the form of the letter being *Artha Brahman* and the uttered syllable, the *Naada Brahman*. *Mayan* makes it clear in his *Aintiram* that letters and words contain both *OM Light* and *OM Sound* – name and form. The number five represents the *Pancha Marabu* of *Mayonic* tradition. This stands for the five aspects of creation. Also, the five stone bricks represent the five female forces of the tradition namely *Nanda*, *Bhadra*, *Poorna*, *Jaya*, and *Riktha*. Blessings of these and other forces are

invoked for the upcoming building during the stone-laying process. Invoking these five female forces is seen an essential aspect of Vaastu science.

While there is a much deeper significance to these five feminine forces, there are some general qualities invoked into every Vaastu structure with the placing of the puja stones with vowels inscribed as follows: Nanda gives prosperity, Bhadra creates well-behaved children, Purna gives fruits of all works early in life, Jaya gives victory over all obstacles, and Rikta avoids emptiness in every aspect of life. These qualities are refinements of frequencies of the Vaastu building. They do not create proper Vaastu but they sweeten it. While there is a deeper meaning to these energies, this is a brief overview to bring to light some the feminine aspects considered in this science.

Included in this discussion is the form called Vastu Purusha (Nataraja or Vastu Brahman) and Vaastu Purusha which have been mentioned elsewhere herein. These forms have been mentioned in the Vedic texts as well as the Vaastu texts and Pranava Veda. Vastu Purusha and Vastu Purusha are often thought of as male forms. The fact is they are not. The term “Purusha” does not mean “male.” It denotes the ingrained energy or innate energy called *Shakti*. This Shakti is generally thought of as feminine energy or of neutral gender (like neutron).

Mayan’s cognition of the Divine led to a full and complete understanding of what many people call God. During his time, it was usual to worship many gods and spirits. Mayan brought out the concept of one God – one Supreme Being. He taught the nature of this God and taught that this God – Brahman – was a very concrete living God who made itself knowable.

The Vaisampayanana, an ancient text on the life of Mayan, reveals this:

*The disciples of Mayan understood well that the Supreme Lord presents himself as Vatthu (Vastu) by manifesting as a short duration of Time and setting the rhythmic order in action by limiting the Time to the duration of one and half an hour (one muhurta) so that the Vatthu could be duly worshipped during the specified time. They realized that the Primal Existent (substance) is indeed the Supreme Lord himself, and it is Vatthu in its wholeness and perfection. Also, they realized that over and above these short durations of Time, there is one undivided and pure Time. Such enlightenment gained by them made the whole world wonder at. (Vaisampayanam 65)*

*They understood that Vatthu is indeed the Supreme reality and conceived that Vatthu is the most Divine and Blissful form, meant for worship. They realized the uniqueness of the Vatthu and its inseparable unity with the Time. They realized the significant and innate nature of the Vatthu in such a way as to derive appreciations from all corners of the world. They rendered services to the Lord (Vastu Brahman) and codified a perfect system of worshipping him. (Vaisampayanam 66)*

*Having gained well the power of knowing the basic truth and principles through systematic investigation, they were able to have good access with authentic scriptures. Though the Primal substance is impervious to such investigations, they knew that It could be known through Its own manifestations (forms and structures). The process that enabled them to arrive at the very root of the Primal source is called “ayadi.” Let us understand this unique process. (Vaisampayanam 67)*

If “ayadi” is meticulously applied, they could be enlightened to understand the significance of each form; to design an elegant and everlasting house and to understand many more technical processes. They can gain mastery in constructing a beautiful edifice. The (disciples) studied the principles set forth in the scriptures and applied them accurately. (Vaisampayanam 68)

The Shilpis considered Time as feminine. They understood the nature of time to be creative and the foundation of the manifest world. Time is consciousness in motion. It is the frequency of which all things are made. Mayan discovered that Time could be modulated or controlled through Ayadi calculations and that we as humans could create buildings that were divine and held divine attributes. Then, these buildings could be worshipped as divinity, causing the devotee to gain spiritual bliss.

Please stop reading at this point and **go to Appendix B and C** for additional information on what I call the Mayonic Code. Understanding the information in this appendix will amplify your understanding of the previous information and then deepen your comprehension of the importance of the application of Vaastu Science to Architecture.

## Chapter 6 What is Vaastu Science and Technology?

Vaastu Shastras, the texts that contain the knowledge base for the subject of Vaastu are anchored in the Science of Spirit (Pure Energy). The emphasis in Vaastu Shastra is the application of the principles of how Spirit – Brahman – unfolds during its transformation from energy to matter.

Brahman, as defined by Mayan in his astronomical treatise called “Surya Siddhanta,” says that tri-dimensionally, every particle of Space is a subtle cube of Energy, called Chitrambalam or Microabode, within which there is a “shaft of light” or “shaft of consciousness” vibrating or performing a “rhythmic dancer.” This is the dance of the Cosmic Dancer, Lord Shiva. The whole universe is filled with subtle cubes of energy called Karu or Bindu or Fetus.

Vaastu Shastras and Sthapatya Veda outline the specific technology of creating built space that mirrors the form of Spirit with specific qualities of Spirit that will uplift an individual and bring him or her into complete resonance or harmony with Spirit. Built space constructed using the principles set forth in Vaastu Shastras are forms of Spirit – energized forms that vibrate with the aliveness of Spirit. It is Spirit and its laws of manifestation that is the basis of the principles of building that are set forth in Vaastu Shastras. The fundamental principle is that *the Universe is subject to a mathematical formula and architecture is a manifestation of this formula.* (Dr. V. Ganapati Sthapati, Building Architecture of Sthapatya Veda, p. 36)

The purpose of Vaastu Science is to give form to consciousness. That is, it is the transformation of consciousness into visual and aural forms governed by the science of Time and Space using Light and Sound as raw materials.

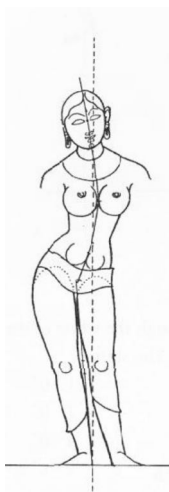

Vaastu Science is the application of the principles of manifestation (Vastu Science) to the material world. When the principles of Vastu Science are applied to forms of art, music, dance, poetry, and architecture, the form (art, music, etc.) becomes directly resonant with the positive qualities of Pure Consciousness or Absolute Space. That resonance of positive qualities is in turn transmitted to the viewer, listener, or dweller.

*In the heart of the cave of the body there is an inner space and in that inner space there is the vibrant thread of consciousness. It is this thread of consciousness that functions as the string of the sarira-vina (bodily instrument)...*

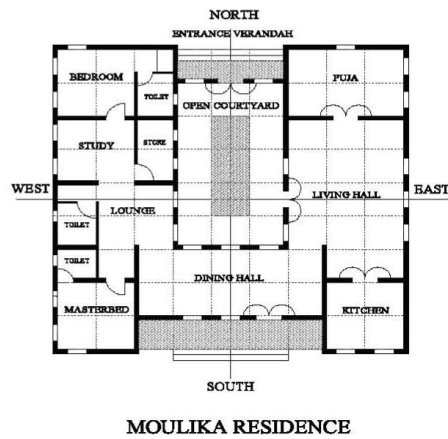
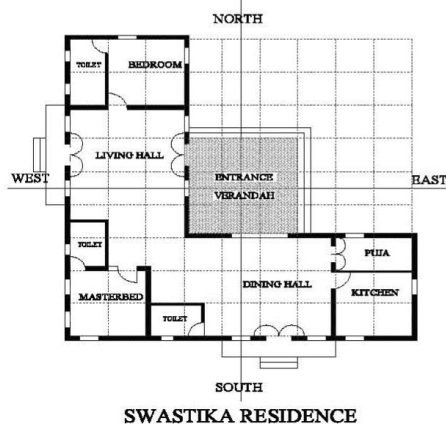
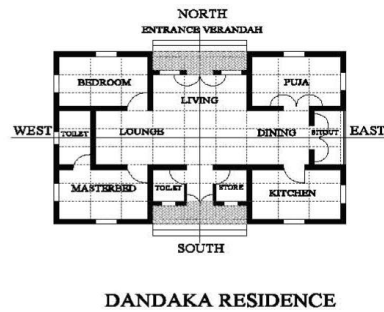
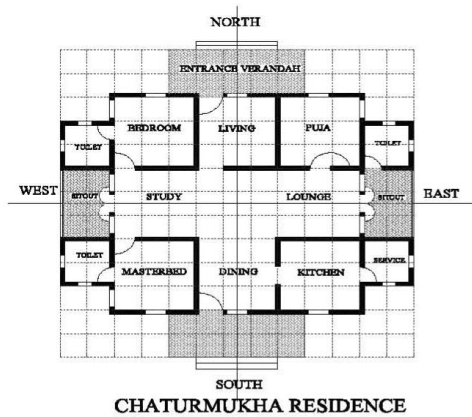

*The structure of the Vaastu-inspired building vibrates with cosmic energy, and the bodily instrument resonates with this vibration. [...] If a part of free space is isolated and confined into a four-walled structure called building, it becomes a living organism, and the space enclosed will start vibrating in a particular order. If such a building is designed to vibrate in the same numerical order as that of the indweller, the resultant phenomenon is that he will experience harmony or perfect union with the Universal Self [...] Dr. V. Ganapati Sthapati*

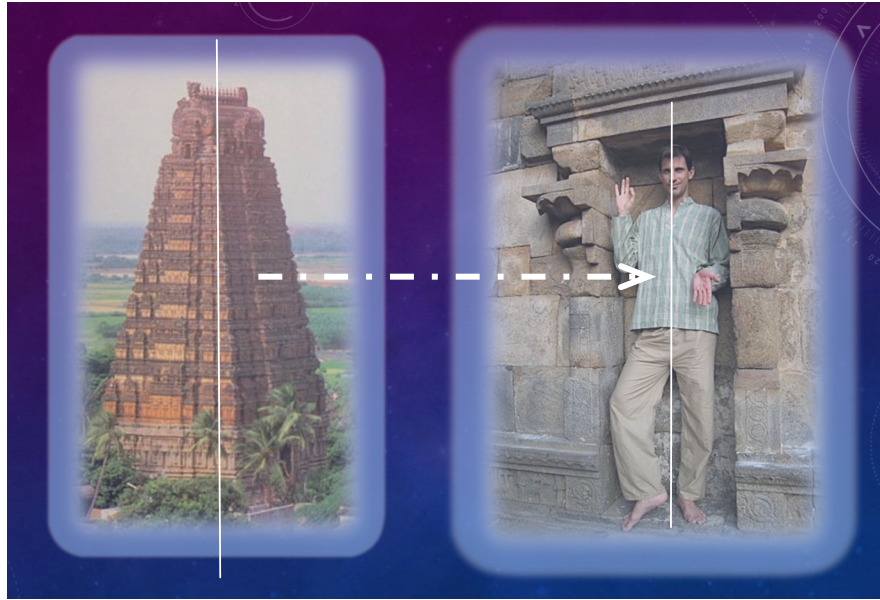

Mayan says in the first verse of his *Aintiram*: *The vibration of Jivatman (individual atman) should resonate with that of Paramatam (Cosmic Atman), supreme power.*

In the previous picture, we see the frequency of the house affecting the frequency of the individual. Each person has within a vibrant thread of consciousness or Brahma Sutra that is contained within the Atman or jivatman. That cubical- or diamond-shaped Atman shown on previous pages is the seed that blossoms at the joining of the sperm and egg. It has its own frequency, and that frequency is born of Brahman or Pure Consciousness. It vibrates with specific attributes or qualities of Brahman. When that frequency activates, it builds around itself the human body, mind, brain, heart, etc., and with all of that – personality with all of its individuated characteristics and qualities. Those qualities of heart, mind, and physiology then create our life. Whatever one's life is, is due to the pulse or frequency that generates those qualities. Thus, our life is born of the essential frequency that we were born with in our jivatman. Our own jivatman or frequency creates the *fabric of our life*. Brahman is the Original Cause.

We can affect the frequency and therefore the qualities of our life through environment, people, food, etc. All manifest forms have a frequency or vibration born of Originating Pulse. Our exposures to the frequencies around us affect our own frequency or pulse, which then affects our body, mind, and emotions, which then affects the quality of our life. This is because jivatman is influenced by other jivatman, just as a tuning fork is affected by another tuning fork that is activated. We also affect the frequencies around us. We can uplift others or detract from others depending on our own frequency. We know that water seeks its own level – so does frequency. In any group of people, for example, the individual frequencies held by each person affect the other people and average out to a specific frequency. Some people are uplifted and some people are decreased in quality. This concept is demonstrated over and over again in popular

literature that suggests that if you want to be successful in life associate with successful people. A common saying also is that someone is a good influence or bad influence on you. Now you can understand the principle and what that saying really means.

One major influence in our life is the frequency of our home. The frequency of our home either enriches us or detracts from our life. A home that has a distorted frequency – one that does not improve the life of the human – actually alters our own frequency, and then causes our mind, body, and emotions to produce a distressed life. Our own life energy is taken to, in a sense, uplift the house. A home that is intentionally built using positive Ayadi (mathematical formulas that determine the frequency or pulse of built space) can likewise uplift one's own frequency. Through Ayadi calculations, the mathematical measure used to enclose Space, one may build a house that lowers the frequency of the inhabitant, maintains the same frequency, or uplifts the frequency of the person, thus the quality of his or her life. This is accomplished by resonance or Bhakti as defined by Mayan. Because knowledge of Ayadi has such a powerful impact on human life, it has been guarded closely and entrusted by only a few. This close guardianship, however, has almost cost the loss of this knowledge.

If we wish to experience an improved quality of life and wellbeing, we can do so by living in a Vaastu – compliant house that has a frequency or pulse that is higher than our own. In that way, the building uplifts our own life – it changes the *fabric of our life*. We can, in fact, through proper application of Ayadi calculations and other principles of Vaastu science, live in a house that vibrates with spiritual bliss – and then we subsequently vibrate with the quality of spiritual bliss and wellbeing.

Please stop reading at this point and **go to Appendix C** for additional information on what I call the Mayonic Code. Understanding the information in this appendix will amplify your understanding of the previous information and then deepen your comprehension of the importance of the application of Vaastu Science to Architecture.



## Chapter 7

### Application of Vaastu Science to Architecture

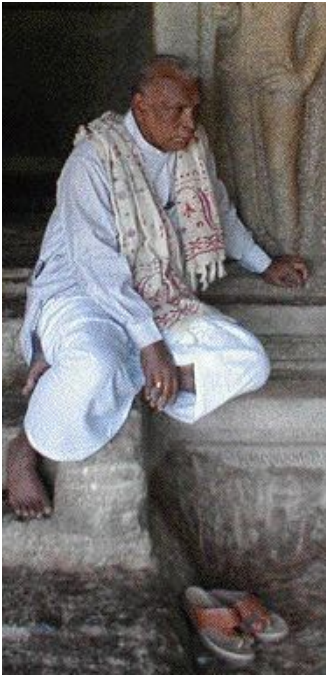

*When inner space and outer space resonate together in harmony, then peacefulness, vitality, health, prosperity, and dynamic, ecstatic creativity become the natural order and effortless experience.*

Brahmarishi Mayan, circa 10,500 BCE

Photo: Dr. V. Ganapati Sthapati by Michael Borden

*The Universal Space, when bounded or enclosed by a walled structure, assumes negative and positive qualities, just like the human being possessing a particle of the Universal Space (called inner space/inner being) does exhibit positive and negative behavior during his or her lifetime.*

*The Vaastu Shastras attempt to calm down all negative qualities of space by arranging the built space in a scientific way. The individual or individuals living in such a well-defined space experience peace and bliss. This wards off all illnesses attributable to Space. Hence Indian architecture is said to be therapeutic. (Dr. V. Ganapati Sthapati, Contributions of Vishwakarma to the Science, Technology & Culture of Indian Origin, 2000, Appendix II)*

When the 8x8 grid becomes 9x9, it forms the basic energetic structure of the manifest universe. When the same principles of Cosmic manifestation are applied in the construction of built space, that built space reflects the energy of the cosmos. What we want to replicate for permanent human and divine living space is the most peaceful, stable form that reflects a full balance of OM Light, OM Sound, Air, Fire, Water, Earth, and Space. Vaastu Shastras recognize no other form for human dwelling other than the square or rectangle. In Sthapati's quote above, he mentions that enclosed space brings both negative and positive qualities. He mentions that proper application of Vaastu Shastras calm down all negative qualities of space by arranging it in a scientific way. An example of the effect of space can be seen in nomadic peoples who dwell in circular or

polygonal forms (teepees, domes, and yurts). Their lives are in constant movement and their communities do not thrive in a settled manner. The dome or circular form produces an overabundance of the air element, which has the characteristic of excessive motion and movement.

An examination of the life of the Plains indigenous people who lived in teepees in contrast to the Eastern indigenous people makes this point clear. As an example, the Eastern peoples lived in rectangular buildings, had a formal government that united the tribes (Iroquois Federation upon which our nation was modeled), farmed, and enjoyed peaceful communal living. The Plains people were on the move, did not farm or raise much food, and were constantly at war with each other. Fundamentally, round structures reflect the Tamas guna and ultimately do not bring Spiritual Bliss and happiness. They are missing the settled expression of air, fire, water, earth, and space elements. They are fine for temporary structures (in fact, excellent for disaster situations, etc.) but not for habitation where they will remain for any length of time. Ultimately, they will bring disharmony to a dwelling site especially if they are activated through Vaastu.

In India, the only traditional buildings that are round are for dancing and entertainment where people only stay a short time and movement is part of the character of their use. In addition, Kali temples are round. These temples are rare and require very special care to avoid certain inharmonious affects.

Creating positive, life-supporting and spiritually enlightening effects requires knowledge of specific rules of Vaastu Science. Those specific rules have been meticulously delineated in the writings of Mamuni Mayan and translated and applied by Dr. V. Ganapati Sthapati in his Building Architecture of Sthapatya Veda, Dakshini Publishing House, Chennai, Tamil Nadu, India, Third Edition, 2009. And they are taught at the American University of Mayonic Science and Technology in the U.S.

This book is not an attempt to offer a detailed discussion of the rules and procedures in applied Vaastu Science and Technology. However, some of the rules will be described below as examples of the application of Vaastu Science and Technology to building architecture. Knowledge and application of the Vaastu building codes and deep science requires detailed study with an experienced teacher authorized by a Shilpi Guru.

The scientific knowledge of Mamuni Mayan extends from the innermost, smallest particle of the un-manifest to the outermost largest conglomeration of particles in the manifest world. Within that entire range, Mayan was able to note the size of what scientists today call the atom. He accurately predicted and measured the size of the earth's mantle. In addition, he noted the movement of the planets and constellations, including the qualities and characteristics of what are called nakshatras (27 celestial bodies that have frequency and numerical equivalence). He was an expert at understanding vibration and frequency.

## Essential Components of Vaastu Technology

While this is not a complete list, the following are some of the essential components considered in the Vaastu Shastras and considered by an authentic Vaastu consultant or Vaastu architect.

1. Selection of Building Site
  - a. Shape of site and rectification
  - b. Underground water flow test
  - c. Soil tests for compactness, toxicity (gasses), sound test, soil taste test, color of soil
  - d. Ambiance and feeling, behavior of people at a site
  - e. Vegetation analysis
  - f. Water bodies, rivers, streams, lakes, ponds
  - g. Ants, bones, hair, grave sites (visual inspection)
  - h. Slope and declivity of land
2. General orientation of buildings, cities, villages, and location of environmental pollutants (industry, dumps, etc.)
3. Vaastu Purusha Mandala
4. Effects of subtle and gross space on human system and psychology
5. Designing of built space for human dwelling

Placement of building on plot

Orientation of building to cardinal directions, declination, declivity

Finding true north, gnomon, pole star

Basic patterns for house building

Proportions of building (length/width)

Motherwall

Ayadi calculations, nakshatra, nama nakshatra

Converting space to energy grid (9x9)

Identify Brahmasthan

Division of padas

Brahma Sutra/ Soma Sutra

Extensions

Placement of walls

Calculating wall and ceiling height

Windows and ventilators

Pillars

Roof pitch and proportion

Special considerations: staircase, bathrooms, toilet, utility room, fireplace, stove and sink, hot water heater, furnace

Outside considerations: incoming water (well), electricity, oil tank, gas/propane, grey water/sewage, ponds, rain catchments, animals (cattle, etc.)

Garage

Driveway

Energy wall purpose and placement

Gates

Trees and plants surrounding building

Out buildings

6. Building materials
7. Auspicious and cosmic periods for beginning Vaastu construction
8. Vaastu ceremony
9. Drawing initial floor plans and elevations
10. Follow through on construction (working with architect, builder, framer, plumber, electrician, concrete contractor)
11. Town planning – traditional and modern
12. Public structures (health centers, library/museums, live entertainment)
13. Assessing existing buildings:

Checking location on grid

Check dimensions of main wall – is Motherwall possible?

9X9 grid on existing structure

Locating Brahmasthan

Rectifying soil and slope of land

Room placements (can you move rooms?)

Move electricity, water, fireplaces, etc.

Changing driveway

Also included is supervision of excavation, plumbing, electrical both outside and inside a building, site planning, plantings and landscape, design, placement and construction of secondary buildings, digging wells, town planning and numerous other tasks governed by the Vaastu Shastras. Vaastu Shastras also include furniture making, bridge and road design and construction, and in ancient times, conduct of warfare.

In order to execute all of these aspects of Vaastu technology, a specially trained individual (Sthapati) must be at the helm of any Vaastu consultation or project. It is easy to observe that a few workshops or even a month or six months training is profoundly insufficient to properly supervise a Vaastu consultation. As mentioned elsewhere, it takes years of training in terms of theory and years of practice under the supervision of an established Sthapati. A Sthapati must be a designer, builder (sculptor) trained in a number of the arts, sciences (including physics, earth science, etc.) and must have a knowledge of engineering.

Anyone who undertakes Vaastu consulting or claims to be a Vaastu consultant or architect without proper training is guilty of malpractice. It is only a Sthapati or his or her appointed colleagues or disciples who are qualified to work in the area of Sthapatya Veda or Vaastu Shastras.

The following text describes what a Sthapati is in the words of some of the great Vaastu Shastras and other ancient texts. It is taken from *Quintessence of Sthapatya Veda* by Dr. V. Ganapati Sthapati.

Before coming to understand and appreciate the term **Sthāpatya Veda**, it would be immensely useful to the reader to know who a Sthapati is and what the term Sthapati actually means. To be brief and precise, the word ‘**Sthapati**’ is the title of a traditional-designer, builder and sculptor. Vaastu Shastras define the term Sthapati and put him meaningfully at the highest pedestal of “Director General of Architectural Establishments”.

स्थापनाधिपतिः यस्मात् तस्मात् स्थपतिरुच्यते ।

— **Mānasara**

*'sthāpanādhi patihi yasmāt tasmāt  
sthapati ruchyate!'*

*'He, who is empowered or entitled to do design and constructions is Sthapati.'*

The same Shastra reveals him to be the one well versed in the Vedas and in all sciences, in addition to being qualified in designing and construction of a variety of edifices.

स्थपतिः स्थापनार्हः स्यात् वेदविच्छास्त्रपारगः ।

— **Manasara**

*'sthapatihi sthāpanārhaḥ syāt veda  
vichchāstra pāragaha'*

*'Sthapati is one who is qualified to establish buildings and also well versed in all sciences.'*

आचार्य लक्षणैः युक्तः स्थपतिर्नाम धीयते ।

— **Manasara**

*'āchārya lakshanaihi yuktaha  
sthatirnāma dhieyate'*

*'Sthapati is one who is qualified to be a teacher in the subject of construction of edifices.'*

Mayan, the progenitor of Vaastu tradition says

स्थपतिः स्थापनार्हः स्यात् सर्वशास्त्र विशारदः ।

*'sthapatihi sthāpanārhaḥ syāt sarva  
shāstra vishāradaha'*

*'Sthapati is well versed in all sciences and qualified and entitled to establish buildings of all types'.*

Modern scholars interpret the term ‘Sthapati’ as one traditionally qualified in Art and Architecture<sup>1</sup>, but in reality it means something more and deeper than what is generally assumed. He is not merely a temple builder and image maker, as one finds him today, but a designer and

builder of all kinds of habitable spaces from hut to mansion, as also a town and village-planner. He is a designer of vehicles and furniture too. All such things happened and existed before the advent of foreign rules and spread of western culture and most of them continue to exist even today. These are his contributions, too many to be enumerated and too stupendous to be narrated here, at this juncture. Many a monument have been accorded the status of 'World Heritage' under a UNESCO scheme. In fact, the material and spiritual culture of India has originated mostly from Sthāpatya Veda and spread all over India and even extended its roots and expanded its branches outside her frontiers, at one point of time in the history. These facts are being brought to society's attention today, by honest researchers of the East and the West.

Vaastu Shāstra, as seen from the traditional angle, would mean to be a

A Sthapati must be a master of a broad field of knowledge. He or she must be an expert in the knowledge contained in Vaastu Shastras. There are a number of basic elements involved in the proper execution of Vaastu Shastras. These elements only apply to a building that is properly oriented on the cardinal directions (with a slight deflection) and designed and built using specific mathematical calculations for the main wall (motherwall) and the extensions. Without proper orientation and mathematical calculations (Ayadi), a building is not a Vaastu-compliant building. Without these two elements, it is fruitless to expect that you can have a peaceful home that brings wellbeing and prosperity. There are about 1 out of 100–200 homes properly placed on the cardinal directions, which may come close to a proper Ayadi measurement, but it is very rare. Hence, it is a waste of money to attempt to "fix" an existing home unless it is oriented on the cardinal directions. There are helpful hints later in this text.

treatise which deals with the science of **Brahmajnāna**<sup>1</sup> and technology of **Brahma srishti**<sup>2</sup> - the former being expressed through the science underlying Vaastu Principles and the latter, through the related technology leading into the realm of 'spirit-centric' (spiritual) creations.

**In other words, a sthapati is one who has been initiated into the application of an unique mathematical formula or mathematical order which is none other than the one that is applied to the creative activities that take place in Nature.** All such creations of the Sthapati are tangible, tridimensional, measurable and charged with life. They are therefore considered as living organisms. Hence, this science of creation or manifestation is glorified and elevated to the status of a Veda - the **STHĀPATYA VEDA**. In tune with this, the sthapati's concepts, designs and constructions go parallel to God's design and construction<sup>3</sup>.

## Basic Elements of Vaastu Technology

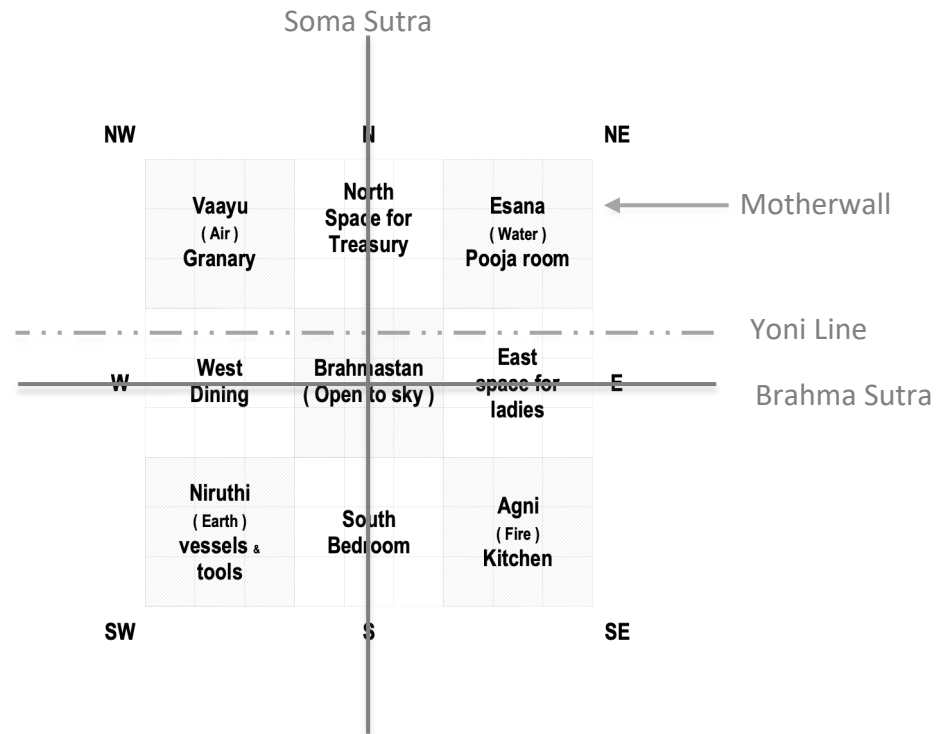

Room or Space Designations in Relation to Five Elements

1. Motherwall – the main perimeter of the house mathematically selected to be in resonance with the inmate and precisely executed as built space
2. Orientation – oriented to the cardinal directions with slight deflection on appropriate site
3. Yoni Line – clear line of sight from front door to back door resulting from properly placed front door
4. Brahma sutra – follows Yoni but through center of Brahmasthan line and is a vibrant thread of light
5. Soma Sutra – perpendicular to Brhama Sutra – also a vibrant thread of light
6. Brahmasthan – open space, no walls or obstacles, no furniture, no fountains. The point of energy generation for the house
7. Five Elements – naturally distributed due to laws of nature
8. Room placement – based upon functions related to the five elements
9. Elevational elements – based upon math of Motherwall and precisely executed with proper placement of windows, doors, and other elements

Mayan discovered that the earth is a spinning structure that mirrors the spinning of the micro cube and 9x9 grid. Just as the nature of the 9x9 grid is to be composed of an energy grid, the earth also has as its nature an energy grid.

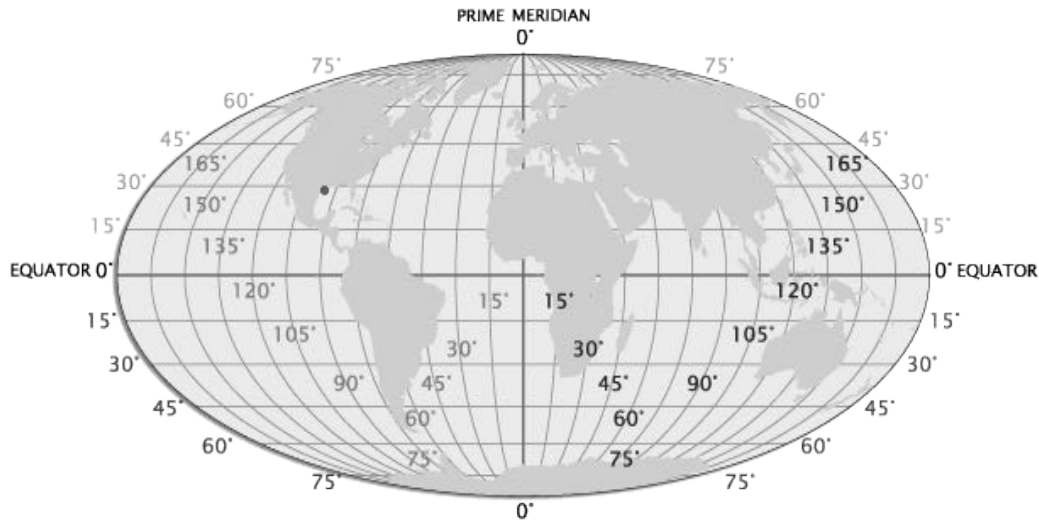

Because the grid lines of the earth energetically mirror the grid lines of the 9x9 and subsequently the 8x8, they resonate with the frequency of the cosmos. Mayan discovered that if built space were placed directionally on the earth's grid, then the space would also vibrantly resonate with the frequency of the cosmos. The following are the principles of Vaastu Science that apply to the grid.

### The Earth Grid

- The earth has a flow of energy that is called *the grid*.
- This flow of energy is related to the earth's rotation at the equator.
- It flows north and south in alignment with true north rather than magnetic north. It also flows east to west.
- When a house or structure is aligned precisely with "The Grid," the positive effects of Vaastu are realized if other principles are observed.
- Grid lines in a built space are carriers of energy values and qualities.

In Vaastu Shastras, earth is seen as a conscious Primal Vaastu – Vaastu Purusha. When we do not take into account the principles of Vaastu Shastras, we are violating the very laws of nature that run the Universe, including the earth. *By violating the rules of Vaastu we are wounding Mother earth.* (From a personal communication with Dr. V. Ganapati Sthapati.) This violation cannot be recovered or altered by using principles of green building, Bau Biologie, natural building, or sustainable building practices because none of those practices support the subtle laws of nature – they only support gross energy systems. In fact, certain of these building practices violate the most basic principles found



in Vaastu Shastras. The first principle often violated is proper orientation of enclosed space. Most natural building or eco-building of various kinds promotes solar gain. That is, deflecting built space upwards to 18 or 20 degrees to maximize heat from the sun in the winter. This deflection moves the house in the worst possible position *off the earth grid* toward what is called *agneya prachee*. The Shastras indicate that this position of built space off the earth grid deflected toward the southeast increases the Fire element in a structure to such an extent that the entire psychology of the inhabitants will suffer. (Interestingly enough, the Vaastu Shastras do support natural building, etc. It was a great concern of Mayan. But, without using the fundamental principles found in Vaastu Shastras, natural building and its sister sciences generally violate the laws of nature.)

Every aspect of human wellbeing is considered in the Vaastu Shastras. Properly trained Vaastu consultants (trained by an authentic program supervised by a Shilpi Guru) can identify the qualities of land and determine its suitability for human and divine habitation. In addition, they have the proper training to carry out all of the above evaluations and tasks.

Earth is a Vaastu form. From the dynamic center of the earth Vaastu energy shoots out in all directions. Just as the Brahman shoots out sparks and waveforms that have various qualities, the earth shoots out waveforms of various qualities. Those waveforms contain the fundamental pulses or vibrations that create the geology, geography, animals, humans, vegetation, and all aspects of earthly life in any given place around, in and on the earth. Because various waveforms differ, we find diverse geology, geography, vegetation, animals, etc., in different places on the earth.

In addition, the qualities of Vaastu Purusha also produce the five elements on the earth, just as the five elements are manifested within the Vaastu Purusha Mandala. At some locations, the fire element is dominant (the desert); at other sites, the water element dominates (the oceans and swamps); others, air or wind (certain places have high winds); and yet others have a preponderance of Space and spiritual bliss (these are places where temples have been built or were people naturally congregate because of the qualities of Vaastu Purusha present there).

Every form on this planet is a result of the type of waveform expressed by Vaastu Purusha at that site. And different qualities of Vaastu Purusha may exist at any given site. For example, in the swamps of the Southern US, there is a preponderance of water and fire element. This gives rise to certain vegetation, animals, plants, serpents, and many other diverse life forms.

We assess the qualities of Vaastu Purusha at a site by assessing the vegetation, geology, geography, existence of heat, water, etc. The geography, for example, reveals to us a great deal about the qualities of Vaastu Purusha in that particular place. The principle underlying this idea is that the earth is a Vaastu form. As it rotates, it produces waveforms with varying qualities of Vaastu Purusha. Those qualities contain different quantities of

the five elements. Those different quantities of the five elements then manifest as qualities of vegetation, geology, geography, etc. For example, Death Valley in California, US is dry, extremely hot, and life there is not very abundant. It is a thriving environment for snakes and scorpions but not for humans and many other animals or vegetation – the Fire and Air elements predominate. In the swamps of Georgia, US, there is an abundance of Water. Certain kinds of vegetation thrive there – cactus, however would die. Crocodiles, water snakes, and numerous insects thrive there. It too is out of balance for human habitation. The hills of North Central Missouri, US have a balance of the five elements. Animals and humans thrive there.

### **Slope of Land**

The slope of the land is an important factor that indicates certain qualities of Vaastu Purusha at a given site. Those qualities will affect a human living there based on the specific direction of slope in relation to the earth's grid. Specific qualities of Vaastu Purusha form the physical slope of the land and other geophysical features. Through insight and observation, Mayan was able to assess the energetic patterns of a given site and then how those patterns would affect humans living there. This gave rise to various site assessment codes that at first glance might seem born of superstition. In fact, they are born of fundamental principles of the transformation of energy to matter.

It is optimal to select a site that has the proper slope of land already in place. It is possible to *rectify* a site using specific principles, but the underlying energetic patterns that formed the land slope and geology will always exist on that site, even if only on a subtle level. Certainly, it is of value to rectify an existing site if the land is already purchased, but it will never be perfect in terms of subtle energy. Yet, good will come to the individual once she lives in her Vaastu-compliant house.

A small inclination of the site in an inappropriate direction is not as crucial as a large inclination in an improper direction. The force of nature that caused the small inclination is not as potent as a large inclination. In any case, the land must be flat for a minimum of 10 feet around the house for optimal Vaastu effect and ensuing results. These are laws of subtle origin and thus of a subtle nature. We cannot overcome the laws of subtle nature through trickery (doing some special trick to overcome them). We cannot trick Vaastu Purusha by hanging a mirror in the house or using a yantra or other device. In that same way, we can't trick Vaastu Purusha by flattening a drastically sloping piece of land. The essential patterns of subtle nature are there and can only be altered by that great Cosmic Force itself.

The diagrams below are an example of some of the many Shastric Codes set forth by the Vaastu Shastras that ensure the wellbeing of individuals inhabiting any given parcel of land or site.

**Slope of Land Compliant With Shastras**

Dhana Veethi – Good

**West Elevated**

Sloping toward East – Material Growth and Prosperity

**South Elevated**

Sloping towards North – Growth of Wealth

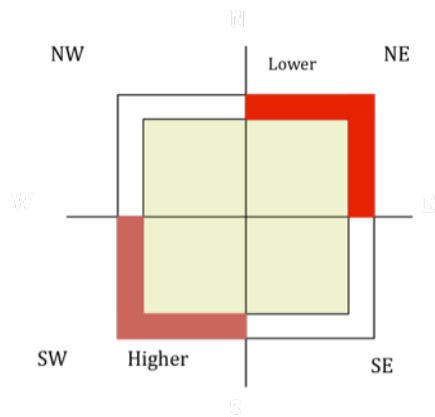

Good Slope

**Non-Compliant Slope of Land**

Bhoota Veethi – Bad

**East Elevated**

Sloping toward West – Loss of Wealth

**North Elevated**

Sloping towards South – Loss of Inhabitants

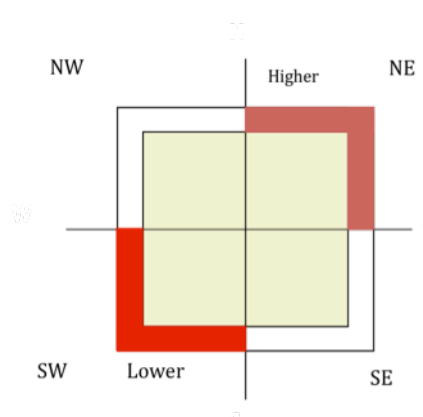

Not Good Slope

Mayan also applied his understanding of the effect of mathematical values creating varying frequencies and qualities in any given built space. He formulated specific calculations – Ayadi calculations – that are applied to the perimeter of a built space called a *Motherwall*.

**Building Measure: the Yardstick Used to Give Form to Consciousness**

The System of proportionate measures is the most instrumental factor for vibrant presence of divinity in a form – that is, it is the proper application of mathematical formulas, called Ayadi calculation, to form generation that actually causes a building or other Vaastu form to vibrate with life-giving qualities.

*If the house-building is not according to the relevant proportionate measures and if the inner spaces or built-spaces of the house are wrongly designed and allocated, then that house becomes the source of numerous difficulties and hindrances of the indwellers and the source of even detrimental effects. (Dr. V. Ganapati Sthapati, Who Created God, p. 83)*

The Ayadi calculation is the calculation used to determine the size of the main wall or Motherwall of the Vaastu structure – home, office, or temple. In the past, the Sthapati

used a stick 33 inches long divided into 24 segments  $1 \frac{3}{8}$  inches each or 24 angulas. This was the standard of measure for temples and homes. One of the names given to this stick is “hasta.” It is interesting to note that Hasta refers to the hand. Elephants with facile trunks are called Hastin or “having hand.”

This reference to the hand is an indication of the importance of the human body in relation to Vaastu Science and Technology. The body inch, angular or viral is the length of the thumbs first joint – approximately  $1 \frac{3}{8}$  inches. Another measure used is from the top of the thumb to the base of the thumb (a measure for some deities), which is approximately three angulas or three times  $1 \frac{3}{8}$  inches ( $4 \frac{1}{8}$  inches). Another measure equivalent to three angulas is a hand width from the base of the thumb to the base of the outside palm. These are all measures based on the hand – hence the Hasta. Thus, the standard of measure for the Vaastu house or temple is that of the human body.

Not everyone has an exact body inch of  $1 \frac{3}{8}$  inches. This is determined by Mayan to be the body inch of the ideal person who vibrates with the divine. Rather than using the individual human body inch to build a temple or house, Mayan used the Divine measure – the perfect body inch of the divine –  $1 \frac{3}{8}$  inches. In that way, the imperfect human would come into resonance with the divine. These measures are pure measures that arise during the orderly transformation called Vastureva Vaastu as Absolute Space takes its form as the material world and its manifold objects.

**Ayadi Calculations: Measures of Light and Sound That Bring Spiritual Peace and Comfort**  
Spiritual calmness, spiritual bliss, and material wellbeing are the most sought after goals of human kind. These are the qualities offered by buildings created by the use of principles of Vaastu Science and Technology. Manifesting these qualities requires knowledge of unique mathematical formulas articulated in the tradition of Vaastu Science and Technology.

These formulae consider the perimeter of the temple or house, the ratio between the length and the width of the perimeter, the height of the ceilings/walls, the height and pitch of the roof, the size of windows and doors, the size of open space in the center of the temple or house, and more. The Shilpis of India have kept this secret for millennia.

The fundamental measure from which many of the above measures are derived is called Ayadi Calculation or Ayadi Gananam. This calculation forms the core of Vaastu Technology and was known as **Vaastu rahasya – secret of Vaastu.**

*The harmonious resonation of the wavelength of the building with that of the inmates is the main aim of Ayadi Gananam. (Dr. V. Ganapati Sthapati; Ayadi Calculations, 2003)*

Ayadi calculation is a measure of the exact size of the container that encloses space. Space is filled with vibrating energy particles. When space is enclosed, the size and shape of

the boundaries that enclose that space and those particles determine the frequency in which the space vibrates.

If four walls, such as in a building, enclose energetic space, the building becomes alive with that special energy and becomes a living organism with rhythmic vibrancy determined by the Ayadi measurement. Just as we humans feel and vibrate with cosmic essence, the Temple or house also feels and vibrates. A specific Ayadi calculation is chosen that has a known rhythmic vibration that promotes spiritual bliss and material wellbeing. The calculations chosen will resonate those qualities our own inner vibrations, and by this resonance, the dweller of the house is able to be in harmony and communion with the universal space (Mayamatam) and to experience spiritual bliss.

*The use of arbitrary length and width measurements are to be avoided. Or else, it would cause disorder in the energy flow within the built space. (Dr. V. Ganapati Sthapati; Ayadi Calculations, Mathematics of Vibrational Matching, November 2003)*

*If the proportionate measures fall short of / are reduced, then there would occur severe diseases, and if the ordained measures get increased, then the one who commissions the silpin for such designs, would be ruined. (Dr. V. Ganapati Sthapati, Who Created God, p. 99)*

Modern architecture uses arbitrary measures in its design, and more often than not it falls short or goes beyond measures that produce life-giving qualities. While modern architectural measures may make sense in terms of utility, they do not make sense to God.

The concept of visible and aural forms is explored in Pranava Veda and Upanishads such as Tejo Bindu. Tejo Bindu describes two Brahman – Sabda (Sound) and Para Brahman (Light). This Upanishad echoes Mayan's assertion that to understand the material world you must understand the unmanifest world. Like that, Tejo Bindu asserts that to understand Sabda (Sound) you must understand Para Brahman (Light). Implicit in Mayan's statement is the concept that the unmanifest brings forth the manifest. And, implicit in Tejo Bindu, Light brings forth Sound.

Understanding that Light precedes Sound, helps us to understand that Sound has its basis in inner vision. This inner vision is likened to intuition and is subtle in nature. It is this inner vision that brings meaning to the Sound that we hear. This meaning is really only derived by the action of the Unmanifest Pure Brahman. It is awareness itself. When we allow ourselves to be quiet inside, we can experience our own inner awareness – inner vision – Brahman. This awareness is called Artha Brahman or Vastu Brahman by the shilpins. Vastu Brahman is called Oli in Tamil – meaning Light.

The Luminous Being (Artha) and the Sonic Being (Sabda) are the raw materials from which material light and sound emerge. And it is actually this Luminous Being Oli that is at the root of all aural and visual forms in the manifest world. It is Primal Light or Luminous Form that is in fact called Vastu.

How do both of these events occur? They occur through a grammar or mathematical order. It is this mathematical order, along with design principles based upon this order, that is the secret of Vaastu Shastra. This knowledge is so important and potent that according to Mayan, *If the proportionate measures fall short of / are reduced, there would occur severe diseases, and if the ordained measures get increased, then the one who commissioned the shilpin for such designs would be ruined; therefore, by all means and efforts, one should design the forms according to the lineaments prescribed.*

What is the causal element of this mathematical, grammatical, Mayonic order?

Mayan says that it is the rhythmic pulse of Para Brahman (free from vibration). First we have Para Brahman, which then begins to pulse or vibrate. That vibration is called Tudi, which takes on the name Time. Time implies rhythm or moving pulse. This Time (Kala Brahman) emits OM Light. Everything is implicit in Para Brahman. But then as Para Brahman begins to vibrate, it differentiates itself into Time, OM Light, OM Sound, etc.

As stated earlier in this text, this unfolding process occurs in a mathematical order. It is this mathematical order that manifests all of the innumerable qualities of the manifest world. Just as light rays for the color blue have certain qualities that arise from a certain length or mathematical equation, all other qualities of light and sound have their own mathematical wavelength. Through Ayadi calculations, we can determine the mathematical wavelength (the perimeter of the main wall of the house – Motherwall), which will give rise to qualities that will support human growth and physical and spiritual wellbeing.

Heavy black line forms main wall or *mother wall*. (Design by Gretchen Leary, AUM S&T Advanced Student under supervision of Dr. Jessie Mercay)

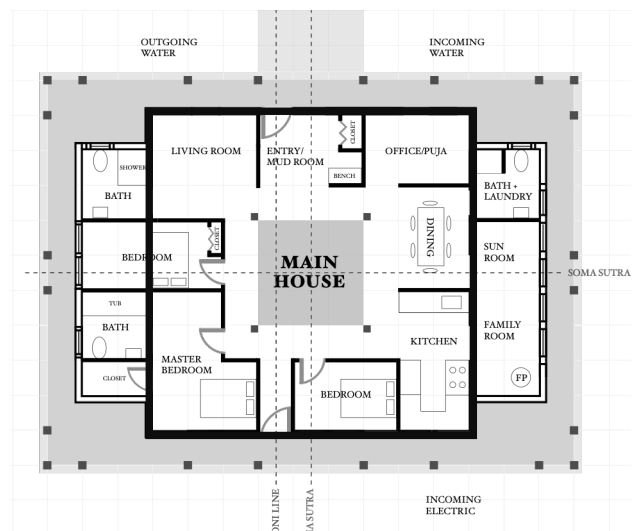

## **The Motherwall**

- The “Motherwall “ is the primary wall or container that serves to create a space for Consciousness to become conscious – for Vastu (unmanifest energy) to become Vaastu (manifest).
- In a home, for example, it is often the main four walls of the house.
- We call it “Motherwall” because it forms the structure that gives birth to Vastu becoming Vaastu.
- The Motherwall is constructed on a 9x9 grid and is formed with very specific individualized measurements that cause the central pada (module) to exude specific life-giving qualities that then vibrate through the whole structure. It is through this form that consciousness, Purusha, takes the form of its container.
- The dweller then begins to vibrate with those same qualities, just as a vibrating tuning fork of one pitch causes another tuning fork of the same pitch in close proximity to vibrate.

The calculations used to form the Motherwall are called Ayadi calculations.

- The Ayadi calculation is chosen to be an exact mathematical calculation that scientifically equates to the personal resonance/vibration of the dweller.
- With the Ayadi calculation, a number of factors are considered in determining exactly what size the Motherwall must be in order to resonate the effect of consciousness becoming conscious within the dweller when he or she enters and resides in a specific house. This is a vital piece of information that supports the fullness of the Vastu effect.
- Once the Ayadi calculation is determined, the structure is divided into 9x9 modules. The modules can be square or rectangular. These modules help locate important features such as windows and doors on the appropriate grid lines. This maximizes the positive effect of the grid, solar energies, and cosmic energies. Extensions (rooms) of various shapes and forms can be added beyond the Motherwall but only in accordance with the mathematical formulas of the Ayadi and modules.

We can say that a house is a convergence of frequencies – a Vaastu or Mayonic house is a convergence of known frequencies determined by Ayadi, which bring spiritual peace, wellbeing, and happiness.

## **The Brahmasthan**

The central point of the structure is the Brahmasthan. It is the central module and the adjacent row of modules surrounding the central module of the 9x9 grid formed by the Motherwall (see diagram below).

- It is the nucleolus of space from which and in which consciousness becomes conscious. The energy generator for the Vaastu building.

- Locating the Brahmasthan is of vital importance in breathing life into a structure.
- This central point can be likened to the nucleus of an atom around which energetic forces revolve.
- Maximum benefit arises when this central area is designed in harmony with the rest of the structure.
- The key feature of the Brahmasthan is that it is an autocatalytic energy generator. The qualities and characteristics of the energy generated (happiness, wealth, health, relational and spiritual bliss, success, respect, etc.) are determined by the Ayadi calculation of the Motherwall. As described above, these numerical calculations determine the pulse and ultimate frequency of all the modules/padas and the Brahmasthan. The properly placed walls act as energy conduits. The sum total of these frequencies determines the vibrational frequency of the structure. The vibrational frequency generated by the Brahmasthan creates the same frequency within the body and consciousness of the dweller.

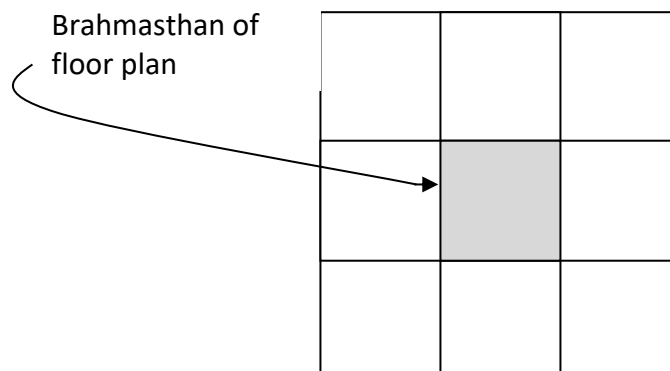

Many so-called Vaastu consultants who are not properly trained attempt to “open the Brahmasthan” when they are doing “rectification” of non-Vaastu-compliant houses. This is an improper use of the Shastric knowledge. The qualities of a house are determined by the measure of the main wall, its orientation on true east and true north, and several other points. If the Brahmasthan of a non-compliant house is opened, it may increase any negative traits produced by the measurement of the house and the improper orientation. This can bring misfortune to the inhabitant.

### **The Five Elements**

The formation of the Five Elements (Space, Air, Fire, Water, Earth) is the outcome of the self-effulgent nature of the 9x9 Vaastu Purusha Mandala. Each element was created through the commingling of the previous elements – born of Cosmic Space, OM Light and OM Sound. As the unmanifest microabode progresses through its self-spin, unmanifest qualities of the five elements are distributed throughout the 8x8 cube. When the 8x8 cube springs forth into material existence, the five elements take on material form and are distributed throughout the 9x9 manifest form in the same pattern as in the 8x8 cube. In the center of the cube (Brahmasthan), Absolute Space mixes with relative/material space. *In other words, the unmanifest and manifest coexist at once.*



Each of the five elements has specific qualities. The individual qualities of the five elements support specific activities and purposes in human life. In built space where this 8=9 process intentionally occurs, activities of daily life are assigned to and conducted within the quadrants with the qualities most likely to support those activities. For example, if a structure is aligned with “The Grid” described above, the southeast corner of that grid is dominated by the element of fire. Assigning activities related to that element (cooking over a fire) creates a life-supporting effect on the results of those activities (preparation of food).

Thus, in a built space reflecting the qualities of Vaastu Science and Technology, the laws of nature and the dynamic energies and vibrations of the elements of manifestation directly support activities of daily living.

### **The Thread of Light or Brahma Sutra**

The Thread of Light or Brahma Sutra is a pathway of light energy that moves through the house in a straight line parallel to the properly placed front door. It flows from the Bindu point or center point of the Brahmasthan. This vibrating energy string is the central cosmic fire from which OM Light, OM Sound, and the Five Elements arise. Its origin is the central point of the Brahmasthan and extends outward and upward from there. The Brahma Sutra also exists on the vertical plane. It rises vertically through the elevation of the house from the center of the Brahmasthan (Bindu point) as a vertical pillar of Cosmic Fire – a cosmic energy generator. The origin of Vaastu energy in a Vaastu house is from this central point in the house and not from the sun, moon, or stars. The properly established Vaastu house generates its own energy and draws from consciousness directly. Hence, we do not want to block the center of the house with walls, tables, fountains, statues, or any other object. It must be unobstructed.

### **The Yoni Line**

The Yoni Line (*Yoga Naalam*) is a pathway of energy that flows from the front door straight through the house to the back door or window – placed directly opposite the front door. It allows for the free flow of energy through the structure. That free flow of energy interacts with the aliveness of the house, making the entire structure even more vibrant. When properly placed, the structure lives and breathes harmoniously. Yoni refers here to direction – the direction of the face of the house – where the front door is located.

- A point of interest is that in some forms of home design (Feng Shui for example), the house is closed from the outside as much as possible to contain the energy. In Vaastu Science and Technology, because the structure is actually an energy generator, it is appropriate to allow the energy to flow outward through the Yoni Line, the Brahma Sutra, and Soma Sutra lines. The self-effulgent nature of a Vaastu home far surpasses most homes in which the energetic patterns are stagnant or otherwise unknown.

## **The Front Door**

The correct front entrance placement is vital to the general effect that Vastureva Vaastu has on a home or structure.

The placement of the front door determines which cosmic forces are stimulated at the entrance and what the effects are based upon that cosmic force. For example, a main entrance in the east-northeast zone (placed in a very specific, mathematically determined position) is very supportive to health, family relationships, and relationships in general.

The front entrance placed in the very center of the south-facing in a house wall creates a harmful effect on the occupants. Moving that door to the module east or west of south center using specific mathematical equations will do the opposite and actually enhance the lives of the occupants.

The front door located in the *central east* promotes egotistical behavior and the demise of children. Whereas if the front door is located one pada to the north of central east it promotes fame and wellbeing.

The front door can be located in any of the four directions but only in the correct module as directed by the Shastras. This effect is due, in part, to the cosmic energy (Vastu) that pours down onto the house from Unbounded Space as the earth's Vaastu attracts it to the building. That energy showers the building up to about 10 feet around the building (hence the need to ensure that the plot is flat at least 10 feet around the building). When the front door is opened, this energy pours in through the door. This is not energy from the stars, planets, sun, etc. (all material energy) but rather direct Vastu energy (spiritual energy).

People with limited knowledge of authentic Vaastu Shastras do not know that the front door may go on any side of the house if placed in a correct position for that direction. Because they are unaware of this Shastric declaration, out of fear they place the front door only in the East or North. Again, because they are unaware of the Shastric rules for placing front doors, they place the front door in the central east location. This location for most homes is prohibited as it gives rise to egotistical behavior and demise of children either through death or departure from the home in unhappy circumstances.

Another interesting front door phenomenon executed by improperly educated designers and builders is that they read or heard that the front of the house should be deflected 1.5 degrees to improve material wellbeing. They interpret that to mean that the front door should be moved 1.5 to 2 inches to the right of center (center of the pada). This in fact creates a disturbance in the Vaastu of the house and can result in disharmony for the inhabitants, as the center of the door should be centered on the pada per Shastric rule.

Another common error of improperly trained Vaastu consultants and Sthapatya Veda consultants is that they rely solely on a text called the Manasara. The text used is a

literary translation by a Classical Sanskrit translator who was unfamiliar with technical Sanskrit. This fact produced a text that is only about sixty percent accurate.

It is only through proper training directly under the auspices of a Shilpi Guru that one can learn the nuances of ancient and authentic Shastric rules. The only existing organizations that provide that training are Vaastu Vedic Research Foundation ([www.vaastuved.com](http://www.vaastuved.com)) Chennai, and The American University of Mayonic Science and Technology, USA ([www.aumscience.com](http://www.aumscience.com)).

Cosmic Space turns itself into form according to its own desire. As mentioned earlier, the Source material called Cosmic Fire or Brahma Sutra is the thread of light or consciousness also known as “Luminous Nataraja.” The primal form is known as microabode in English. It is square at its base and cubical in structure with six sides. It is called Chidambaram in Sanskrit. This square pattern is the subtle unit of Space (anu), and is the shape of the subtle space contained in our heart known as Atman (some people refer to individual Atman as jivatman – but there is no difference, so we use the term Atman). There is a creative hotness in this Cosmic fire called vaisvanara Agni or Cosmic Fire – the flame is blue.

On the journey to manifestation, this subtle cube or microabode replicates itself through frequency or waveform by virtue of Absolute Time or Shakti. Thus, Absolute Time or Shakti is frequency, pulse, vibration, or waveform. When this unitary cell goes into action, it splits itself into 64 or 81 smaller cubes or “padas”; this is called Vaastu Purusha Mandala. These fractional spaces unfold in sequential order as concentric square belts around the central point called Brahma Pada (luminous space of fire), Devika Pada (space of effulgence), Maanusha Pada (space of awareness), and Paisaachika Pada (space of grossness). These concentric belts are wave patterns and form one large wave pattern. They will be discussed in more detail later in this section.

These 64 (in the 8x8) or 81 (in the 9x9) Padas that make up the energy belts have specific qualities and characteristics that, when stimulated by human activity, emit specific frequencies and then affect the human occupant based on those frequencies or qualities. Their role as emanations of consciousness cannot be overstated in terms of their effect on humans. Their qualities, along with the five elements, guide the placement of rooms, doors, and activities in a Vaastu house. They are referred to as luminaries because they are direct luminescent energies born of consciousness or Brahmam. The Vaastu Purusha Mandala acts as a filter or grid through which the energy of Brahmam (light energy) passes and is fractionalized. That fractionalization splits the light consciousness and forms individuated energy forms – Padadevatas (Riks). Each of these forms has specific values and qualities that reflect in the building. And each of these forms contain aspects of Cosmic knowledge.

The individuated qualities of these cosmic forms are reflected within a diagram called Phalagunasruti – qualities of consciousness in seed form. In addition to OM light, OM

Sound, the five elements, and three gunas, these Padadevatas influence the occupant and thus the life of the occupant in innumerable ways.

In the chart below, you will see notations for the placement of front doors according to Vaastu Shastras. There are positive qualities derived from the placement of doors at certain padas that contain specific Padadevatas. You will note that doors placed incorrectly produce negative results. Does this mean that the Padadevata in that space is negative? No, not necessarily. It simply means that that energy does not react well to the stimulation resulting from a door being in its place.

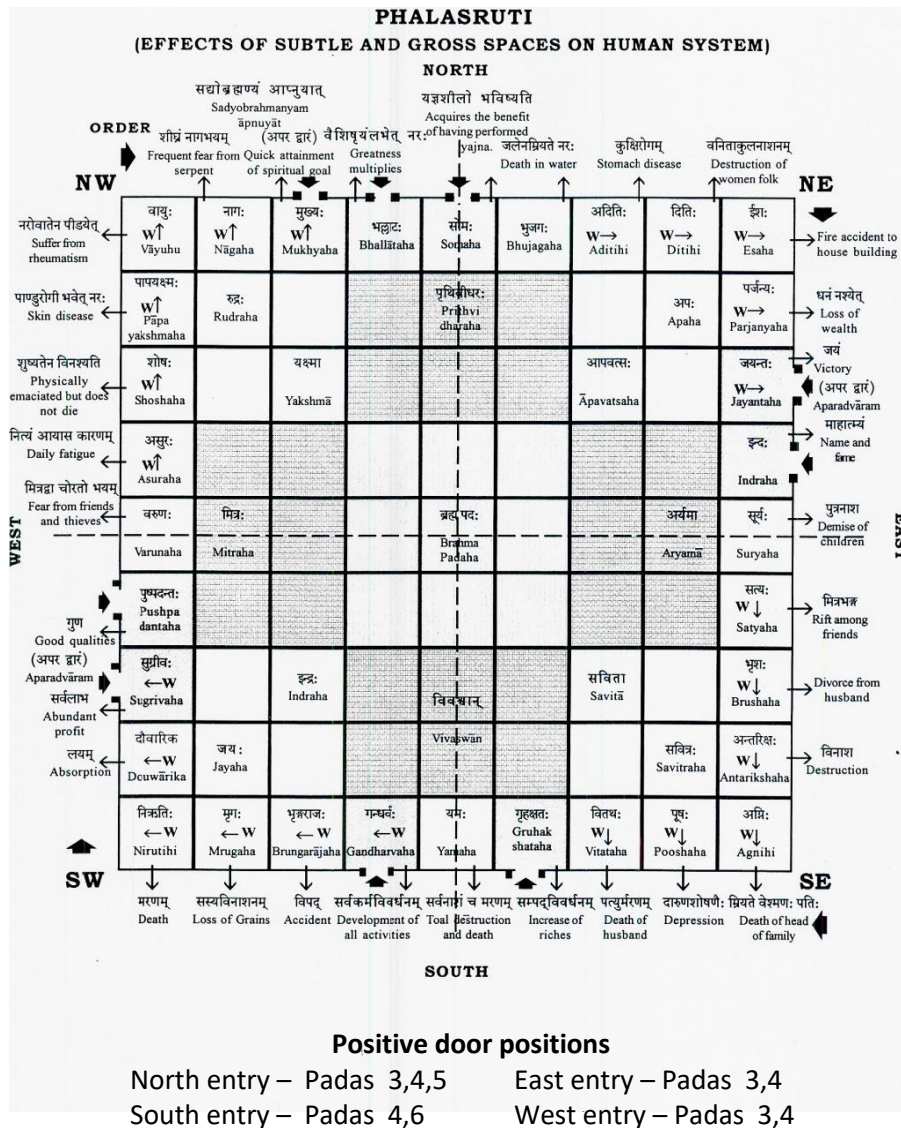

Front-door placement is indicated by broad arrows in the cardinal directions. The preferred door placement on all sides is the fourth pada from the corner going clockwise around the mandala from the northeast. Contrary to popular belief, the Vaastu Shastras make it clear that a front entrance may be in any one of four cardinal directions. Lack of

knowledge of the Shastras has caused individuals and groups to propagate improper information on the topic of front-door placement. Because they are unaware of the concept of “proper pada placement,” they fear placing the door anywhere but the east. It is a fact that the door must be in the proper pada in each direction. Improper placement in any direction can bring mishaps to the occupant.

The Padadevatas shown here are found throughout the Vedas and referred to as Riks. (The author is the first person to make this connection between the Padadevatas and the Riks in the Veda in modern times.) It is said in the Rig (Rik) Veda that *He who is awake the Riks will seek him out*. The general concept here (stated in a simplistic way) is that in a Vaastu house, at some point when the occupant becomes attuned to the divine frequency of the house, Divine knowledge (divine experience – spiritual bliss) will come to him or her. This concept is explored more deeply during advanced training at the American University of Mayonic Science and Technology [www.aumscience.com](http://www.aumscience.com).

### **Meaning of the Luminaries in Padas**

I mentioned earlier that proper door placement and room placement is important in a home – especially a Vaastu home within which the energy is highly activated. In some cases, specific activities are connected with specific Padadevatas. As an example of the potency of the Padadevatas, I would like to offer information on one specific Padadevata.

One of the most important and influential Padadevatas is the one located in the pada where the cook stove goes in the kitchen. It is called Anta Riksha:

Antaricksha literally means middle region – between Dyava and Prithivi. Region of the trees or vanaspatis.

Location: Second pada from southeast on east wall.

Affects: Affects in a positive way the nervous system, helps stimulate righteousness and freedom from committing sin, especially from atmospheric influences or influences from the environment.

The cook stove is placed in this pada in a house. The effect is to stimulate righteousness. That is, when food is cooked in this pada, it is imbued with righteousness. Then the person who eats the food becomes more righteous. Furthermore, the cook herself or himself becomes more righteous due to the influence of this Padadevata. The cook must be righteous because the food he or she prepares takes on an influence by the cook. A righteous cook would never poison the family or use spoiled food in the meals. If the family has a cook, then the woman or mother of the family should go to the stove every morning and prepare tea. She should stand over the stove and absorb the qualities of the Padadevata for her health and the family. The Bhagavad-Gita speaks of the role of the woman in upholding Dharma in the family and society (chapter 1 vs. 40 & 41).

*On destruction of families,  
Their rites of dharma then die out,  
From the destruction of dharma,  
Adharma overwhelms them all. (40)*

*Overpowered by adharma  
The family's women then are  
Corrupted, and from corruption  
The confusion of castes arise. (41)*

The influence of righteousness from this luminary helps maintain the Dharma of the mother and the entire family.

The Rig (Rik) Veda itself indicates the importance of the Padadevatas or Riks in the hymn: *Richo akshare parame vyoman – the Riks abide in the immutable supreme Space (parame vyoman) where are seated all the Devas or luminaries.* Rig Veda 1.164.39.

### Significance of Energy Belts in Layout of Living Space

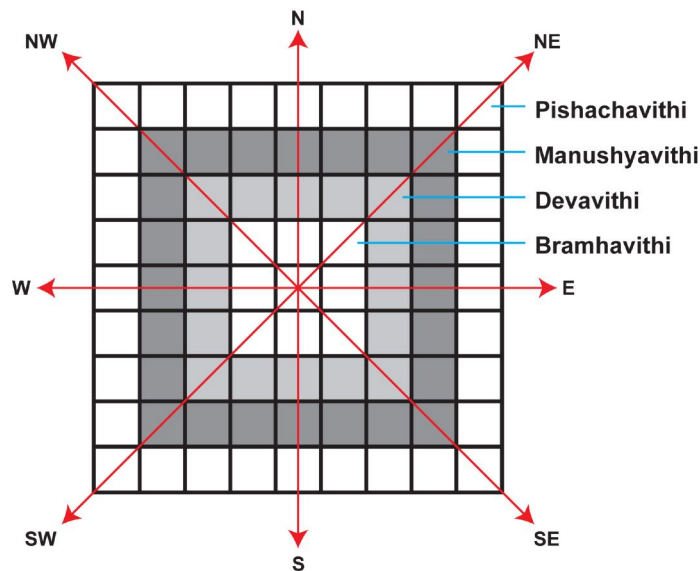

Earlier in the discussion on the manifestation process, a point was made concerning the five concentric belts that spread as square belts of energy coming from the center of the Brahmasthan. I have also mentioned that the central area of a building called the Brahmasthan must be left empty because it is the seat of Brahman where the energy patterns arise.

You can see in the above diagram that these energy belts have specific names. The first belt pushing outward from the Brahma pada is called Brahmavithi. This is the abode of Brahmam. This point is OM – a composite of subtle light and sound. The second energy

belt coming from the center is called Devavithi (Devika Pada). This is the abode of luminosity, in ancient India, this belt was also left un-built and used as a passageway. The third energy belt is called Manushyavithi (Manusha Pada). This is the field of consciousness – often left un-built in ancient times and used as a passageway. The last energy belt is Pishachavithi (Paisachika Pada) – the abode of gross matter or human existence. This energy belt is where rooms were traditionally placed. In modern building, due to space constraints, we generally use the space of Devavithi, Manushyavithi, and Pishachavithi.

The order in this pattern is said to be the Universal Order. It is also reflected as the same order of manifestation within the human being. When the egg and the sperm unite, a thread of consciousness or Brahma Sutra is activated around which a cubical Atman arises and subsequently forms a human body through its vibration. Just as the fetus of consciousness activates itself to form the universe, the same fetus on the micro level is activated to form a human life. The frequency within the atman (jivatman to some) forms the body and mind of the person. As it continues to vibrate, one's whole life is formed. Who we are and what we do is born of that vibrating thread of consciousness. The same manifestation process that occurs within the human and other beings occurs in the cosmos as described earlier in this text.

We as humans have the opportunity through free will to change that frequency for better or worse. We can go to lowly places and associate with people of lesser frequency and alter our own frequency in that direction. We can, on the other hand, choose to surround ourselves with saintly people and raise our frequency. We can choose to live in a lowly house and lower our frequency, or we can choose to live in a saintly house and raise our frequency. The saintly house is one that is built using the mathematical order and building codes promulgated by Mayan. This order is called *Vaastu Dharma*, and one who applies this order to building is said to be following Vaastu Dharma – called the *Luminous Path* by Mayan.

In ancient times, in South India, every community had a *saintly house*. It was called a temple or koil (pronounced ko-eel) – temple of Space. Everyone could not afford to live in a Vaastu house (although small Vaastu houses, sheds, Dhyana Garbhas, or shrines can be built in one's backyard), so every community had a Vaastu building that was used as a community meeting place and healing center. They did not do this to worship idols – worship of idols in temples did not occur until Brahmins came from the North. If a statue of Nataraja or a Siva lingam was present, it was with the knowledge that these were representations of the principle of Vastureva vaastu. They did this because they understood the knowledge of the union of Jivatman and Paraatman that occurs by being in a Vaastu building or temple. In the evening, people would congregate at the temple and talk and share their day. There would be Vaastu music and Vaastu dancing as well as reading of Vaastu poetry. They would experience complete rejuvenation from the frequency of the building. If someone was ill, he or she would sleep and live in the temple



until his or her illness was healed. This is the power of a building built using Vaastu codes on the Vaastu Purusha Mandala.



Sangakala Sirpachittan Mamuni  
“MAYAN”

ஆலமா மரத்தின் கீழே	அருள்மயன்	அமர்ந்த தாலே
ஆலமா மரத்தின் கீழே	அருட்கலை	வளர்ந்த தாலே
ஆலமா மரத்தின் கீழே	அறிவர்கள்	வளர்ந்த தாலே
ஆலயம் ஊரூர் தோறும்	அமைந்தன	செழிக்கநன்றே!

Seated under the shade of Banyan tree, surround by highly learned and aged people, Mayan, the great preceptor blessed them with the knowledge of the union of the Jeevaatman and Paramaatman, in cyclin order. Hence, emerged temples of space, every where on the Tamil and Indian spaces.



## Vaastu Purusha Mandala and Room Activity Layout

पूर्वायां श्रीगृहं प्रोक्तं आग्नेय्यां स्यात् महानसम् ।  
 शयनं दक्षिणायां स्यात् नैऋत्यां आयुधालयम् ॥  
 भोजनं पश्चिमायां स्यात् वायव्यां धान्यसञ्चयम् ।  
 उत्तरे द्रव्यसंस्थानं ऐशान्यां देवतागृहम् ॥

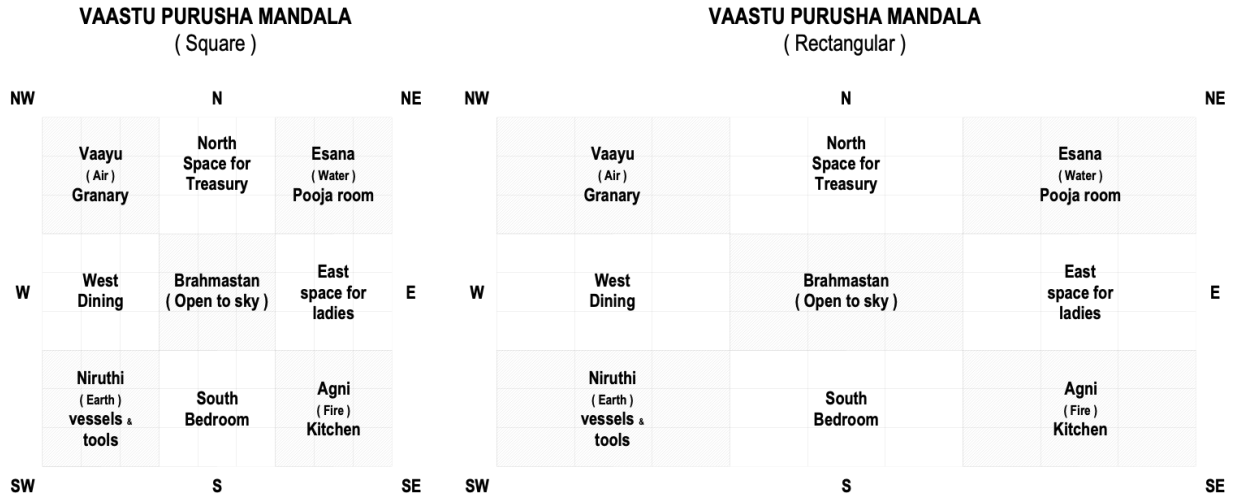

On the East shall be the space for ladies  
 And the kitchen on the South East  
 The bedroom in the South  
 With space for instruments & utensils on the South West  
 The dining hall shall be in the West  
 And the storage of grains done in the North West  
 The treasury shall be located in the North  
 And the Service (puja) room in the North East

Vaastu Shastras

## The Knower and the Known

Creating a Vaastu house requires more than simply a general understanding of the Shastras. One Shastra may say that *an L-shaped house is acceptable* and only say that. An untrained individual may then, based upon that, build an L-shaped house with the opening of the L facing the Southwest. Yet in another Shastra, a scholar would find that the L must be facing a specific direction to uphold happiness and wellbeing. The knowledge of various Shastras is extremely important. No one Shastra can be taken in isolation. In addition, knowledge of both Vaastu Shastras and Agamas must be learned and comprehended.

Langala

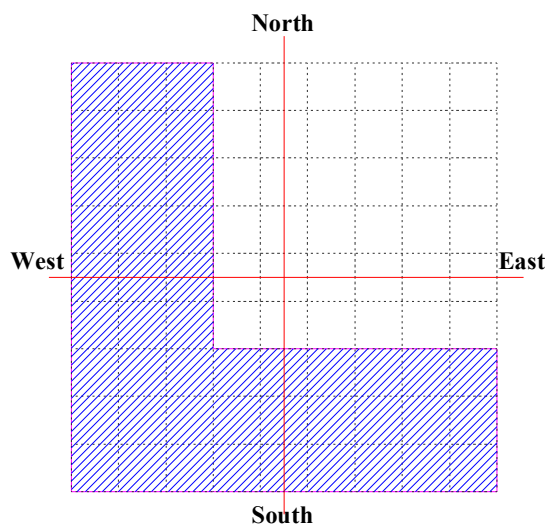

The *Kiran Agama*, for example, speaks of *langala* type of buildings (L - shaped) as below:

The *langala* house, in which south wing and west wing are combined, is known as *siddhaartha*, and it is auspicious and beneficial for courtesans. The *langala* house in which the west wing and north wing combine is known as *yamasurpa*, and it is said to cause untimely death. The *langala* house in which the north wing and the east wing combine is known as *danda* – living in this house would yield all sorts of troubles and inconveniences. The *langala* house in which the east wing and the south wing combine is known as *pana* and it would create quarrels and disputes especially among women.

As I have mentioned elsewhere, this is not due to superstition; it is due to the creation of disturbances in the energetic pattern of Vaastu Purusha. Why? When the langala (L-shaped house) is open to the northwest, the structure is highly energized with the air and fire elements, which feed each other and emphasizes unstable air and fiery qualities of the individuals. When the L is open to the southwest an imbalance of elements cause a lack of stability. The earth element creates that stability and is lost in such a house.

Before using principles of Vaastu Shastras, be sure you know what you are doing or the person who helps you knows what he or she is doing. Don't rely on books to learn it – study with someone who knows – someone who is a traditional Sthapati and has been all of his life or someone who has his training and blessings to teach. People claim to have been studying for 20 to 30 years, but what they have studied are the books of someone who studied books written by someone who studied books. And none of those books were Shastric based. You will never find a Vaastu Shastra that suggests gadgets, devices, or other such things to so-called *rectify* a house or to "fix" bad Vaastu. It is something made up by people who do not understand Vaastu.

Here we have seen two points. 1. Vaastu houses don't have to be only square. 2. Vaastu designers, architects, and building consultants must be properly trained and must employ a great deal of knowledge and skill. Beyond design, construction must be supervised by a trained Vaastu Consultant who is actually certified by a traditional Indian architect born into the Vishwakarma clan, has learned through the Guru Kulam system, and is preferably a Shilpi Guru.

This is a modern Vaastu house plan built as a New Mexico Territorial style home with a 9:12 pitched roof. All of the proper elements of Vaastu Shastras can be found in this plan.

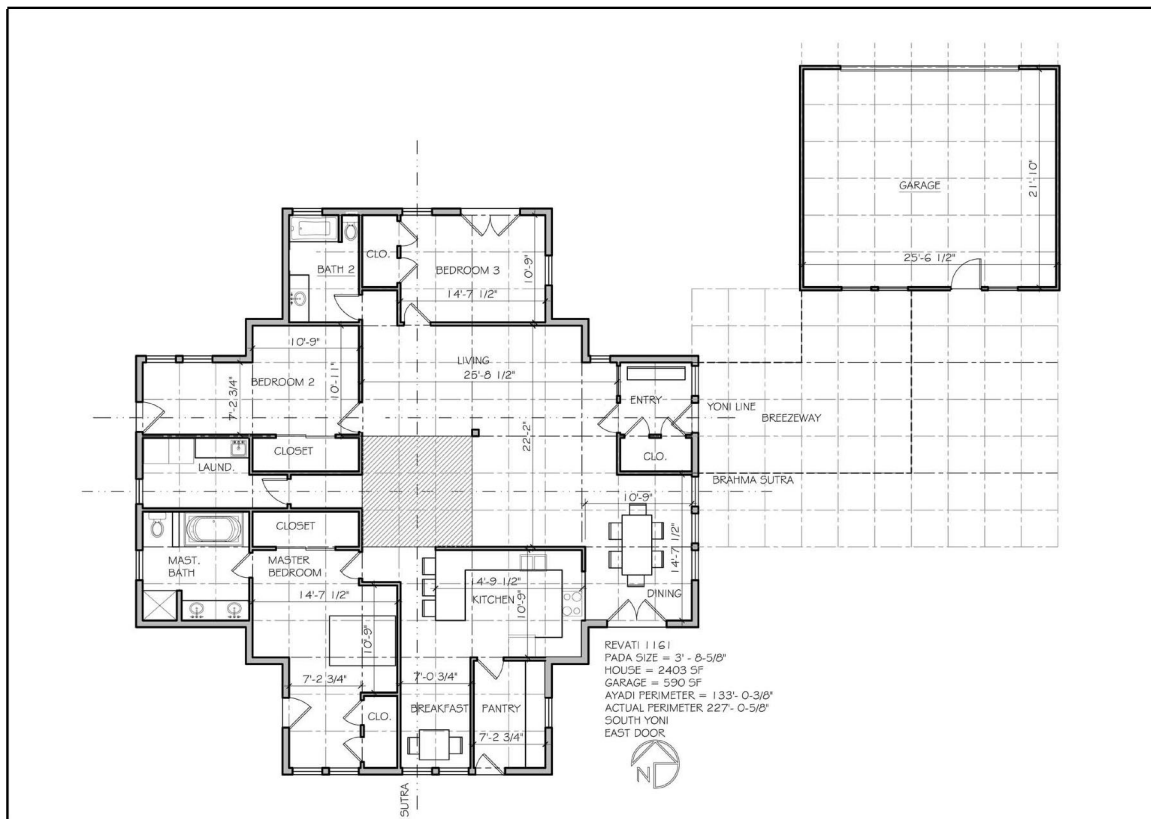

Produced by Dr. Jessie Mercay, Master Vaastu consultant/designer and builder. Assisted by Betsy Pierce, Student Vaastu Architect.

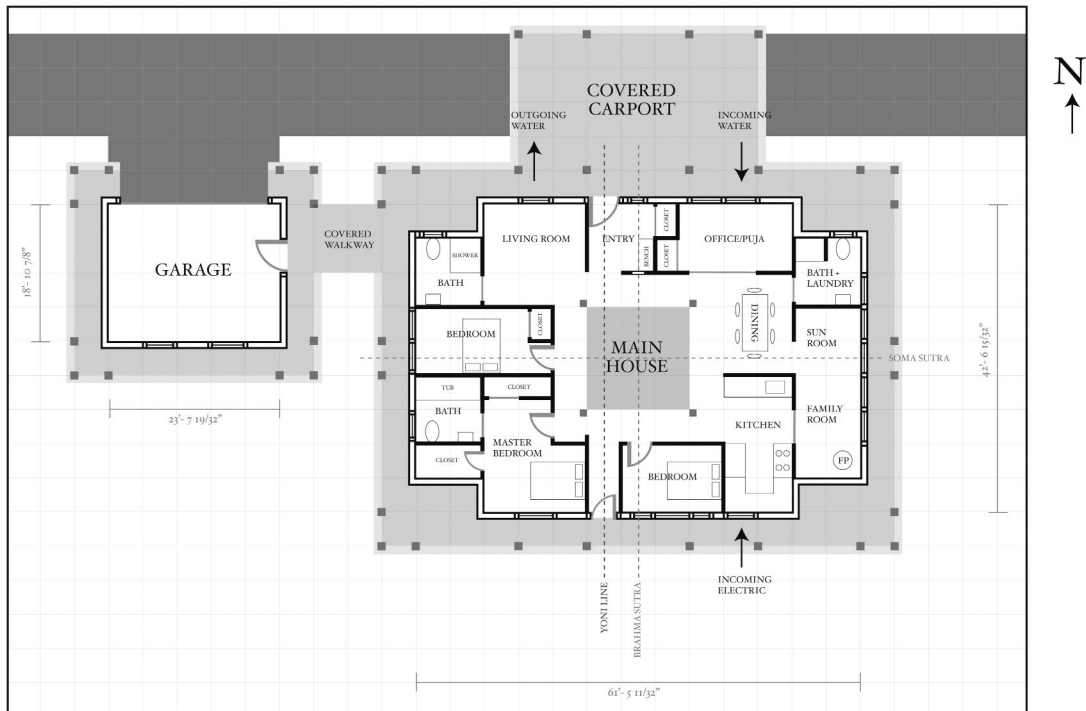

This plan was developed under the supervision of the author by Gretchen Leary, an advanced student at the American University of Mayonic Science and Technology in the distance learning program. It should be noted that this student is not an architect but gained these skills during her extensive training at AUM S & T.

All of the points in the Vaastu Shastras, from proper measure to placement of toilets and all other design elements, are adhered to in these drawings. There is one error in the design, which is located in the entryway closet. The back wall of the closet is improperly placed in that it should be on a grid line. Simply looking at these drawings brings a sense of order to the viewer. They are harmonious and designed in a way that supports the balance and free flow of the five elements. The two most important factors have been upheld: 1. Proper orientation 2. Proper measurement of the main wall according to Ayadi. All other Shastric principles have been upheld.

The floor plan is critical, but the elevation is also critical. A properly constructed Vaastu house has elevational elements executed as precisely as the elements of the floor plan.

## Other Aspects

Vaastu Science when applied to built space takes other aspects into consideration, including: slope of land, flow of underground water, roads, bodies of water, quality of soil, vegetation, flowing water on the surface (streams and rivers), the flow of water through pipes in the building, to some extent building materials, secondary door placements, window placements, elevational factors, and much more. The unique aspect of Mayonic Science, the original form of Vaastu Science, is that these considerations are based on mathematics, astro-dynamics, and geophysics and physics rather than superstition.

The impact of applying these Vaastu principles to a structure (home, office, church, temple, apartment, village, statue, painting, piece of jewelry, etc.) is that that structure, regardless of size, becomes a “living structure.” Living structure means that the structure is vibrating with life-giving qualities of consciousness specifically selected for a particular inhabitant or group of inhabitants. While the concept of “living structure” is difficult to understand, a story by Dr. V. Ganapati Sthapati, in the documentary film *A Shilpi Speaks*, might help clarify this concept:

*When my father was working in the Ramana ashram, he had to make a statue of Sri Ramana Maharishi. My father was very close to him. He had seen the innermost feelings of the Maharishi on his face. What my father saw, he savored and absorbed. When the work on the image was begun, the Maharishi would come every day and look at the progress. As the image was nearing completion, he looked at the statue and said, “Oh! Ramana is here!” Immediately, my father put away his hammer and chisel.*

Through the proper execution of Vaastu Science, the statue ceased to be simply a chunk of stone – it became enlivened with the consciousness, qualities, and characteristics of Ramana Maharishi. When Ramana Maharishi witnessed his own consciousness and qualities awakened in the stone, he acknowledged that to the Shilpi. The stone had become a *living structure* exuding the vibrational frequency of Sri Ramana Maharishi.

Another way to view this is that animate objects vibrate at a specific frequency in Space and Time. Inanimate objects have their own frequencies as well. The term *living structure* describes the frequency of animate objects. It is as if, when Vaastu Science is applied to an inanimate stone and the stone is formed into a Vaastu structure, it begins to vibrate in the same way as an animate object. Those who know the secrets of Vaastu Shastras can determine the qualities or frequencies that objects (enclosed spaces) produce.

According to Dr. V. Ganapati Sthapati, without applying Vaastu principles, specifically Mayonic Science and Technology, the structure, jewelry, art, or other object is “sick.” That means that consciousness is not harmonic with the wearer or dweller. In that state, the individual associated with that structure does not experience the possible gain and benefit available from Primal Existence.

The “sick” object or structure can, in some cases, drain the life of the individual and create ill health and misfortune. It is as if the “sick” structure is seeking energy from the owner/resident in an effort to struggle for life. The result is that the owner/resident begins to struggle for life. In a properly constructed or rectified Vaastu structure, life energy and harmony is added to the life of the owner and occupant.

The entire structure of a Vaastu house becomes a self-effulgent living organism that transforms its dweller into a radiant self – effulgent spiritual being. A properly constructed built space created through the application of Vastu Science and Vaastu Science brings spiritual bliss to the dweller.

*The embodied energy is Vaastu Purusha Mandala or the Creative Essence made manifest on the physical plane. The space enclosed in a building is Praasaada Purusha Mandala or "energized building." Such a building is a living organism built of musical units of measure. These units correspond with the primal vibrations of the cosmos itself.*

Brahmarishi Mayan, circa 10,500 BCE

The success of Vastu/Vaastu Science in contributing to the welfare of a home dweller is based upon the fundamental structure (enclosed space) and subsequent frequency emitted by that vibrant structure. It is the mathematical formula used in creating the Motherwall and the alignment with the earth’s grid that gives rise to the vibrational frequency of the structure called Vaastu. The placement of the walls, windows, doors, and other Vaastu building code elements ensure the uninterrupted flow of energy within the structure.

The use of objects such as mirrors, yantras, crystals, etc. that are often used in many Vastu consultations in an effort to “correct” or “rectify” the harmful effects of a disharmonic structure is based upon superstition rather than scientific principles. The thought that a mirror or other object can cancel out the negative effects of the powerful Primal force emitted by a built space is sheer fantasy. The success of a Vaastu consultation relies solely on the ability of the consultant to understand and apply the principles of Absolute Space, Absolute Time, OM Light, OM Sound, and the ensuing unfolding of Vastureva Vaastu.

Mayan said:

*Through the power of inner consciousness, the knower of Vastu should know about light aspects and sound aspects of OM pertaining to both inner and outer space. Those who do not realize the creative dynamism of inner space cannot know the dynamism of outer space. (Aintiram: sutras 195,831)*

Once an individual understands the principles of Vastu/Vaastu Science, he or she comes to realize what is truly necessary to build a structure properly and does so in accordance with the authentic principles of Vastu/Vaastu Science rather than with principles based on superstition. Furthermore, once the knower understands the dynamics of inner Space, then one truly understands life itself.

### **Assessing Existing Structures: Can we fix an existing home and make it Vaastu compliant?**

This question is a very important question and loaded with implication. My Shilpi Guru and I discourage many of the practices done by modern pseudo-Vaastu consultants. Vaastu is pretty much an all or nothing proposition. Its value and qualities are based primarily on just a few points, without any of which there are no positive Vaastu effects. (I have discussed these points earlier, so you can go back to them for review if this does not make sense to you.)

These are the conditions necessary for good Vaastu:

1. A good site that emanates with positive Vaastu dynamics. (A certified consultant from AUM S&T is trained to identify a good site as well as to execute all of the Vaastu compliant technology.)
2. Orientation of building with earth grid to be in alignment with Vaastu energy grid so that the built space can capture the Vaastu energy of the earth and Cosmic Space straight on. If the building is more than a few degrees off true north, there is nothing that can be done to help the house and its inmates. (Dr. V. Ganapati Sthapati, Building Architecture of Sthapatya Veda)
3. The proper mathematics (house perimeter) that provides energetic qualities of Vaastu that is helpful for humanity. (Without special measures you have unknown qualities)
4. An open Brahmasthan to allow the Vaastu energy to flow in smoothly from the ground (Vaastu Brahman) and from Consciousness (Cosmic Space – not outer space, Vastu Brahmam, or Quantum Field) directly above the building.
5. Placement of rooms and their living functions in accordance with the qualities of the distributed energy flowing through the Brahmasthan from the earth and Cosmic Space.
6. Elevational properties, wall placements, bathroom, stairs, etc., and other aspects properly executed.
7. Slope of land, placement of utilities, water bodies, trees, etc.
8. A design or house plan that is beautiful, functional, and spiritually uplifting.
9. Careful and proper execution of the building plan to 1/16<sup>th</sup> of an inch.

Then of course, there are the many Vaastu building codes that enrich and maintain Vaastu compliance. Above all, the first five must be present.

- Without proper orientation on the earth grid, you have no smooth flow of Vaastu energy into the enclosed space – the energy is distorted.
- Without the proper mathematics, you have faulty energy being produced by the built space.

Without these, you have nothing but distorted energy being produced.

- If the Brahmasthan (center of the house) is covered or has walls going through it, the energy is suppressed. (No fountains, tables, plants, pillars, posts, or anything else in the Brahmasthan – they suppress the Vaastu energy coming up from the earth.)

These points are directly referenced in the Vaastu Shastras. The Vaastu Shastras and Agamas are the only authority on Vaastu. *There is not one single reference in Vaastu Shastras or Agamas that suggests ways to “fix” a non-Vaastu-compliant house.* The concept of “fixing” a non-Vaastu house is completely made up by individuals who have never read the Vaastu Shastras or Agamas and have not studied at length with the only people living who understand Vaastu Shastras – Sthapatis and Shilpis.

It is almost impossible to find existing built space with these basic qualities present. If any one is missing (especially 2,3,4) then you really don't have a Vaastu house. You can't make a silk purse out of a sow's ear. It is the mathematics of the main wall that determines the quality of the energy in built space. Then the orientation on the earth grid and open house center that activate the energy. So in this respect, a building is Vaastu or not. (This is not to say you can have these three and ignore all of the other building codes – you can't – you want to optimize the flow of energy in the structure.)

No manner of chimes, yantras, crystals, etc. is going to correct the fundamental existing energy of the house. What I mean is that none of these so-called correction devices change the orientation or mathematics of the house. Without proper orientation and mathematics (perimeter of the house), the energy produced by the house will be improper.

If this is the case, why bother doing rectification of existing structures? Well, first, by chance, you might find a house on the grid that has a good motherwall (mathematics). Out of about 200, I found 2. I then bought one of the houses and went to the trouble of moving the front door, opening the Brahmasthan, putting in new windows in the right places. I couldn't change the elevation – it would have been too expensive... but the house felt good. However, it was not a real Vaastu house. It would have been cheaper to tear it down and rebuild, to be honest. But it was an amazing learning experience in reverse engineering.

So there may be a few houses out there on which doing some rectification would be helpful. Also, a few small points can be helpful especially if the house is on the earth energy grid or close to the grid:

1. Move the sleeping arrangements around – get your mother-in-law or bossy teenager out of the SW corner, so he or she stops trying to be head of the household!
2. Change the position/location of the main door.



These are about the only things we can offer a person in terms of making physical changes that may bring a bit more harmony. They don't correct the Vaastu but might help a bit.

Many people think that if they open the center of the house – Brahmasthan – they are doing something good. What happens if you open the Brahmasthan in a house that has a motherwall/main wall that provides negative qualities? You enhance those negative qualities. Yes, don't just randomly open up Brahmasthan without knowing the Ayadi/measurement and formulas of a house. Not many people have thought about this. Most Vaastu consultants want to open the center of the house. It is not a good idea. I can vouch for it from personal experience. You simply end up activating the negative qualities produced by the main wall.

There are a couple of other suggestions that are possible:

1. Have a certified Vaastu Consultant who is properly trained (email [aumcourses@aumscience.com](mailto:aumcourses@aumscience.com) for a name) build a small Vaastu Dhyana Garbha or shrine in your yard. (See Amazon.com *How to Build a Backyard Vaastu Dhyana Garbha*.) It won't change the Vaastu of your house but will provide positive energy for you while you are in or near the shrine or Dhyana Garbha.
2. Have your consultant build a small Vaastu form that will generate some positive Vaastu energy if placed properly in the house. It won't change the Vaastu of the house but will be a little generator that is beneficial if placed by the bed in the proper orientation.
3. Play what we call Vaastu music 24/7 at a very low volume. Go to [www.aumscience.com](http://www.aumscience.com) bookstore for Vaastu music.

The most important thing that comes out of a Vaastu rectification consultation by a properly trained Vaastu Consultant is education. You will learn a great deal about the Vaastu Shastras and their proper application.

Lastly, if your life isn't broken, don't try to fix it. Don't change your house except for the few suggestions above. Some people have houses that support their life that aren't Vaastu houses per se. Sure, a Vaastu house would be better but, their house is cozy and comfortable and their lives are going well. Just move the mother-in-law out of the SW and have a Dhyana Garbha built. If your life is really going downhill fast since you moved into the house, then move – fast.

So, as you can see, there are a few things you can do with some help. But you can't "Vaastu" your house if it does not have the five points above in place.

There are a lot of people hearing about Vaastu and the miracles that can occur if they would just by a yantra to hang on the wall. Several of my students were duped into believing that an \$800 three-dimensional yantra (with a bad motherwall by the way) would Vaastu their house. This is highway robbery. It is better to have a real consultation and pay \$250 for it, get a few good suggestions, and hear the truth than to pay several

thousand dollars for yantras and crystals.

The next question that begs a reply is this: Is it better to build a partial Vaastu house than no Vaastu at all? First, once one knows Vaastu Shastra, I would imagine it would be difficult to build anything but Vaastu-compliant structures. With that said, if you use Ayadi for this partial Vaastu house, then you "activate" the energy of the house. From that point on, the rest better be done properly. Otherwise, if you don't build a fully compliant house, then every Vaastu building code that you break is a breaking of natural law. You can't fool Mother Nature. Each of the Vaastu building codes that you fail to comply with will distort the energy of the house, and you will feel that in your life.

We are building with the highest ecologically sound principles available – natural law – the laws of nature. Beyond that, we are building with the laws of Consciousness – the laws of manifestation that even transcend the laws of nature. You can have an eco-house that is compliant with everything from green building principles to building biology principles and still build a sick house if you don't use Vaastu Shastric building codes. All of these building codes that have to do with green building, natural building, etc. are only dealing with the material aspect of building.

Yes, Mayan was an eco-builder. He said where we should build (environmentally clean sites) and the materials we use are important (how trees should be cut, which stones are good for what, etc.). But more than that, is the subtle energy or quantum energy that we activate when we enclose Space. Vaastu is primarily about enclosed Space. That is, the energy that will have the greatest and deepest effect on human wellbeing. We have to change our way of thinking. We have to stop trying to fit Vaastu into our building style and try to put our building style into proper Vaastu. Vaastu comes first – the rest follows.

Even an emphasis on the "building codes of Vaastu" is almost inaccurate because the building codes are secondary to the concept of Vastureva vaastu (pure energy or consciousness becoming matter – the material world). The building codes (rules for building per Vaastu Shastras) are simply to ensure that Vastureva Vaastu happens the way we want it to and that the qualities of energy/consciousness that are housed by the built space are undistorted. The real point we must understand is that our priority is to enclose space that vibrates with life-supporting qualities of consciousness itself.

### **The Builder**

Thousands of years of experience have verified that the individuals who undertake the construction or forming of an authentic Vaastu structure (Sthapati, Shilpi, Architect, Vaastu consultant, dancer, poet, etc.) develop a yogic intimacy with the structure or form. The trained Sthapati and the Shilpis internalize these scientific and spiritual concepts so that they impart the maximum knowledge to their construction. Just as the sculptor becomes the sculpture, the architect becomes the architecture, and the poet becomes his poem. The authorization of such a person to work in the field of Vaastu must be given by a Shilpi Guru or his or her representative.

### **Shastric Evidence for Building Per Vaastu Shastras**

If a house or building is not built according to the divine measure cognized by Mayan, and if the inner spaces are wrongly designed (according to proper Shastric rules of design), and the spaces are improperly designated in terms of use based on qualities of the elements and Padadevatas, then the house becomes a source of innumerable difficulties and hindrances for the occupant. The Shilpis of India have kept this secret for millennia.

Five important texts from the Vaastu Shastras illuminate this point:

1. *Mayamata: Since Vastu is vibrantly present as the inner essence of all the Vaastus, such as buildings, constructions generally known as praasaada, our predecessors considered them as vastus only.*

This statement simply says that Vaastu buildings are Vastu – living consciousness.

2. *Manasara: Vaastus such as vimaana, etc. indeed have emerged from Vastu and remain surcharged with Vastu. Verily, they themselves are to be considered Vastu. Thus it has been declared by the scholarly persons who are the knowers of Vastu Vimana is not only referring to temples – it means, in technical language, all built structures built with systematic systems of measure.*
3. *Saklaadhikaram of Agastya: The body of the Supreme Being shines forth in three states: Formable, Formless, and Mixed (both formed and formless). Of these, I will explain the rules and procedures pertaining to the Form as enunciated by lord Siva.*

(Interestingly enough, here we see a reference to these rules and procedures being *enunciated by Lord Shiva*. Earlier in this text, I offered a quote from Mayan in which he mentions that the Supreme Being helped him to visualize Nataraja, Lord Shiva. Agastya, being part of Mayan's direct lineage, was aware of this and mentions it in his Shastra by saying that these rules were *enunciated by Lord Shiva*. From Mayan, we know that Shiva/Nataraja is a scientific term used to describe the vibration of the Brahma Sutra on a cosmic and individual level and its transformation of energy – Vastu – to matter – Vaastu.)

4. *Samaranga Sutra Dhara Vaastu Shastra of King Boja Deva*  
*If the principles of Vaastu are violated, serious dangers can occur:*  
*Decrease in measure (the measurement of the Motherwall falls short of the correct Ayadi more than 1/16 of an inch) = severs diseases*  
*Increase in measure (main wall larger than properly Ayadied number) = the patron dies*  
*Increase in length = increase in enemies*  
*Decrease in girth = decay*  
*Decrease in breadth = poverty and insufficiency*  
*Increase in breadth = sudden demise of spouse*

*Discrepancy in plumb line = pollution and dirt of the country*  
*Increase or decrease of measure of inner space = troubles and turmoil of the Shilpi and Guru*

5. *Building Architecture of Sthapatya Veda, Vaastu Shastra of Dr. V. Ganapati Sthapati*  
*We build within 1/16 of an inch of a properly ayadied perimeter.*

These significant quotes reveal that there is something special about Vaastu Shastra that deals with consciousness itself. This special knowledge is focused on how consciousness itself – the invisible – becomes visible and aural forms. In other words, a Vaastu house is a house in which the proper Shastric building codes were employed, thus the invisible Vastu becomes visible Vaastu in the house. One of the most important building attributes is the Ayadi calculation that defines the qualities exhibited by any given building based on the frequency generated due to the mathematics of the perimeter of the main wall. Without the proper application of these codes, there is no proper Vaastu. Most buildings today have errors in the measure of their main wall in that it varies in length and width from measures that produce positive results. An existing building that was not built using these codes cannot generally be “corrected.” A trained consultant can look at door placement, driveway, and a few other aspects of an existing house and may make recommendations for changes, but the Vaastu of the house cannot be corrected short of tearing down the house and starting over. In a few rare situations, a house may have a proper motherwall. In these cases something might be able to be done.

This concept of visible and aural forms is explored in other Upanishads such as Tajo Bindu. Tajo Bindu describes two Brahmanas – Sabda (Sound) and Para Brahman (Light). This Upanishad echoes Mayans assertion that to understand the material world you must understand the unmanifest world. Like that, Tejo Bindu asserts that to understand Sabda (Sound) you must understand Para Brahman (Light). Implicit in Mayan’s statement is that the unmanifest brings forth the manifest. And implicit in Tajo Bindu, Light brings forth Sound.

Understanding that Light precedes Sound helps us to understand that Sound has its basis in inner vision. This inner vision is likened to intuition and is subtle in nature. It is this inner vision that brings meaning to the sound that we hear. This meaning is really only derived by the action of the Unmanifest Pure Brahman. It is awareness itself. When we allow ourselves to be quiet inside, we can experience our own inner awareness – inner vision – Brahman. This awareness is called Artha Brahman or Vastu Brahman by the Shilpins.

Vastu Brahman is called Oli in Tamil – meaning Light. The Sonic Being (Sabda) and the Luminous Being (Artha) are the raw materials from which material Light and Sound emerge. And it is actually this Luminous Being Oli that is at the root of it all (both aural and visual forms). It is Primal Light or Luminous Form that is in fact called Vastu.

How do both of these events occur? They occur through a grammar or mathematical order. This mathematical order, along with design principles based upon this order, is the secret of Vaastu Shastra. This knowledge is so important and potent that according to Mayan, *If the proportionate measures fall short of / are reduced, then there would occur severe diseases, and if the ordained measures get increased, then the one who commissioned the shilpin for such designs would be ruined; therefore, by all means and efforts, one should design the forms according to the lineaments prescribed.*

What is the causal element of this mathematical, grammatical, Mayonic order? Mayan says that it is the rhythmic pulse of Para Brahman (free from vibration). First we have Para Brahman, which then begins to pulse or vibrate. That vibration is called Tudi, which takes on the name Time. Time implies rhythm or moving pulse. This Time (Kaala Brahman) emits OM Light. Everything is implicit in Para Brahman. But then as Para Brahman begins to vibrate, it differentiates itself into Time, OM light, OM Sound, etc. This is the manifestation process shown in this text that gives rise to all forms in the material world. It is a description of the Fabric of the Universe both manifest and unmanifest as articulated by Mamuni Mayan as Vastu and Vaastu.

### **Learning to Practice Vaastu**

In ancient days, Mayan taught at his academy through the Guru Kulam system – direct transmission of knowledge and experience from Guru or teacher to student. Over time, Vaastu Shastras have traditionally only been taught to Vishwakarmans – father to child. It is indeed a privilege that Dr. V. Ganapati Sthapati has taught this knowledge in an academy-like setting and has opened up the teaching and authorized Dr. Jessie Mercay to teach in an academy setting much like Mayan.

Learning this knowledge is a serious and profound undertaking. It cannot be learned in a weekend workshop or even a few weeks. In addition to the technical knowledge that can be learned through lecture and texts, it is an internal process. It's not only that the brain has to learn this knowledge. Rather, there must be a direct connection with Atman in the cave of the heart cultured in a specific way in order to fully understand this system. One may know the "rules" yet not understand a building plan or the knowledge in general on the level of frequency.

This understanding does not come from the intellect – it comes from direct contact with inner being. This is a higher level of knowing. The teacher must be able to help the student culture that "knowing" over time through specific methods of instruction. It is a process that requires experience and integration. The American University of Mayonic Science and Technology offers that experience and integration. There, the student researches the Primal Source and Force within. From this, he or she comes to understand the Force and to know the qualities of the Supreme Substance. Then and only then can the individual understand life according to Mayan.

Mayan says in the 16<sup>th</sup> verse of the Pranava Veda:

*When those who are searching for the truth in a state of independence understand the force, technology, character, and meaning of the knowledge hidden within the OM (Light and Sound), then they will acquire the complete knowledge of the five-fold Veda.*

Mayan indicates that seekers of Truth will find that Truth when they understand the hidden meaning and character of OM. This deep learning can only come from specific guidance through this body of knowledge by a teacher of the tradition. When that occurs, the full Veda will be understood in parts and as a whole.

Mayan also says (vs. 20) that Pranava Veda and related Vedas guide the way for *survival of earthial beings*. This knowledge brings order to life and allows humans to exist in a state of harmony, prosperity, and bliss.

The American University of Mayonic Science and Technology invites you to learn this knowledge in the proper setting. You may take introductory, one-week courses or the complete program just for the knowledge, or you may take the Vaastu certification programs for lay people, architects, and builders. ([aumcourses@aumscience.com](mailto:aumcourses@aumscience.com)) Your life will be changed forever.

Shastric information herein should not be used for any purpose other than your own information. Isolated pieces of information regarding Vaastu Shastras should never be used in building without extensive training and an understanding of the parts to the whole.



## Chapter 8 Our Inspiration

We are in great debt to Mamuni Mayan for his deep insights born of introspection and presented to the world through his writings. In addition, we are grateful for the immense contribution of Dr. V. Ganapati Sthapati for his untiring effort to faithfully translate and transmit this Pure Knowledge of Vastu Science and Vaastu Science.

### Guru Kulam



Jagedguru Brahmarishi Mayan



Shilpi Guru Dr. V. Ganapati Sthapati



Dr. Jessie J. Mercay





**Chapter 9**  
**Epilogue**  
**The Swelling of Brahman: Vaastu Through the Arts**

The musician is poised for a moment over her sitar. Her attention is drawn to her source – her center point in the cave of her heart – Atman. She waits. In a moment, a swelling of consciousness begins as a vibration of the Brahma Sutra in her Atman. She translates that vibration into action as she strums the strings of her instrument. The music swells just as her Atman swells. The supreme bliss felt by the musician, as she becomes the bodily instrument of Brahman is transferred through her music to the listener. She becomes the song of God. The listener becomes the song of God. Throughout her recital she strikes special micro notes that tap directly into the pulse of God that brings bliss to the listener. These *srutis* are received by the listener, transferred to the Atman of the listener, and the Atman of the listener begins to vibrate with Supreme bliss.

The poet pauses for a moment with his pen... The sculptor pauses for a moment with his chisel... The painter pauses for a moment with her brush...

When the artist knows the secrets of Vaastu science and arts, then that artist becomes the bodily instrument for the swelling of consciousness and transfers that pulse or frequency into their art. The viewer or listener then shares in that unspeakable bliss. This was the art and music that lived worldwide in ancient days. One can experience bits and pieces of this through selections of Classical Indian music – particularly Carnatic music. Mozart seems to have struck a few blissful chords. Traditional Indian dance holds the secrets of a mathematical order. But music and dance today are pretty much bereft of access to these micro sounds called *srutis*. Dr. Veerapandian of SHASTRA University in Tanjour, India has decoded Mayan's Aintiram in terms of what we call Mayonic music or Vaastu music with the hope of transforming music around the world for the wellbeing of humanity.

The sculptors of Dr. V. Ganapati Sthapati's stone yard strike these micro notes with their chisels in the form of the mathematical order of the stone they sculpt. Vaastu architects, consultants, and builders who are trained through the American University of Mayonic Science and Technology also strike the micro notes with the application of the precise measure, called *Ayadi*, to building architecture.

Earlier in this text, I mentioned a definition of Vastu and Vaastu based upon a study of the roots of the words. Here is what I wrote earlier:

*Vas: to shine; to grow bright, to bestow by shining upon, to cause to shine; to enter into, to dwell, becoming light, dawning, the seat or place of, an abiding substance or essence, the pith or substance of something, to cohabit with.*

*Vaas: to make fragrant or to perfume, an intoxicant, to be or make firm, dwelling place, to assume the appearance of, matter. (Cologne Lexicon)*

*Tu: One who changes his shape at will.*

*Vastu is that energy or force that lives eternally. It is never ending and omnipresent.*

*In examining these definitions, we can see that Vastu is the seat of an abiding, shining luminous substance or essence (the essence of life). It has a quality of growing brightness and is the pith or substance that enters into and cohabits with that in which it dwells and that which dwells within it. It is the source of the material world, yet it cohabits with the material world as Vaastu. It does not separate itself from the material world. In fact, the material world (Vaastu) exists within the body of Vastu. It changes its shape at will and becomes the innumerable forms of the material world and exists as Vaastus (all material forms).*

*Vaastu is that which assumes the appearance of matter. It makes firm or gives concrete shape to the place where it dwells. It makes fragrant that in which it dwells. That fragrance is the intoxicating spiritual bliss experienced by people who live in or visit a Vaastu structure, listen to Vaastu music or poetry, or view Vaastu sculpture and dance. Here we are speaking of authentically created and executed forms of these arts based on the ancient Shastras.*

Authentic Vaastu or Mayonic arts that use the principles Mayan established brings forth this essence we call Vastu. This essence is luminous. It causes that which it enters to shine – to glow. As it becomes Vaastu, that form which it enters – music, poetry, architecture etc. – becomes fragrant with the light of Vastu – the light of consciousness. The listener, viewer, or inmate then becomes permeated with specific qualities of consciousness exhibited in the art. This results in an intoxicating experience of spiritual bliss.

This Mayonic Science/ Vaastu Science and Technology must live. Conscious people must take it as a personal responsibility to help it grow in their area of interest. It is the savior of the world, the balm for the suffering on the weary road of life. It brings enlightenment and spiritual bliss to those who partake of arts and architecture that demonstrate its principles.

From the pen of Santi-Deva, a 14<sup>th</sup> century monk:

*This Thought of Enlightenment...*

*it is an elixir made to destroy death in the world,  
an unfailling treasure to relieve the world's poverty,  
a supreme balm to allay the world's sickness,  
a tree under which may rest all creatures wearied with wandering over life's paths,  
a bridge open to all wayfarers for passing over hard ways,  
a moon of thought arising to cool the fever of the world's sin,*

*a great sun driving away the gloom of the world's ignorance,  
a fresh butter created by the churning of the milk of the Good Law.  
For the caravan of beings who wander through life's paths hungering  
to taste of happiness, this banquet of bliss is prepared, that will satisfy  
all creatures coming to it.*

Those of us who have supported, studied, and applied this art and science bring this banquet of bliss to the world. Come join us. Build a Vaastu house, garden cottage, or Dhyana Garbha, learn the application of Mayonic/Vaastu principles to the visual arts, or study Vaastu music. Support AUM S&T. Somehow participate in this great endeavor for the wellbeing of humanity.



# The Cosmological View of Mamuni Mayan in His Mayonic Science

By Dr. Jessie J. Mercay



Mamuni Mayan

*Now (while one has a human birth), one should inquire into Brahman.*

Brahma Sutra 1.1.1

## **Mamuni Mayan**

Mamuni Mayan, the great architect and scientist, had long been thought of as a mythological figure. His exploits are recorded in numerous places in the corpus of Indian literature called the Vedas or Vedic literature. Veda Vyasa, the first compiler of the Vedas, mentions Mayan as the author of the Pranava Veda and that the Pranava Veda is the first Veda. Mayan is also described in the Upanishads, Mahabharata, and numerous other texts as a builder, architect, scientist, and almost super-human man. His name and fame have been held in reverence for centuries by members of the Shilpi clan.

During the early- to mid-1900s, an inquisitive young man, Kaurmari Dasar, interested in finding original, palm-leaf texts on Vedic astrology, came across some ancient palm leaves stored in the Saraswati library in Tamil Nadu that he found interesting. They were the palm leaves that held the knowledge of Pranava Veda and other treatises. This poet bard had an unusual gift for memorization. Though uncommon, there are other individuals who also had the ability to memorize large amounts of knowledge – for example the living sage, Chartur Vedi of Bangalore, who, at this writing is 121 years old, has memorized the full body of the Vedas. Hence this is not an unheard-of ability. In fact, there are a number of such men and women in Indian history.

While the topic was not what he was seeking, he was drawn again and again to these texts, and over time he memorized them. After a number of years passed, he went back to the library and found that the texts were missing. No one knew where they were. Knowing the importance of these texts, he went to Dr. V. Ganapati Sthapati and recited them.

Dr. Sthapati soon realized that these texts were the long missing Pranava Veda mentioned by Veda Vyasa in his Bhagavatam. Linguists have been unable to understand these documents because of the technical language in which they were written. But for Dr. Sthapati these were the missing link to centuries of Vaastu tradition. These texts were found to be the ancient science

behind Vastu Science and Vaastu Science Technology – The Pranava Veda written by Mamuni Mayan over 12,000 years ago. Dr. Sthapati spent hour after hour pouring over these documents. Transfixed by the profundity of these illuminating texts, he lost himself in time and often studied deep into the night. With only a few hours rest, he still continued to perform his daily activities as a thriving architect.

It was only because of Dr. Sthapati's former education (mathematics, science, Sanskrit, technical Tamil, Vaastu Shastra), his close association with his scholarly father who was a renowned Sthapati and Sanskrit scholar, and over 50 years of practical work in the field of traditional architecture and sculpture that he was able to delve deeply into the meaning of the ancient, palm-leaf texts. His deeply spiritual nature led him to see that these texts were about more than building architecture – they were about the Source and Essence of life itself – the architecture of life.

Mayan's science or Mayonic Science is a complete cosmology – a scientific study of the origin and structure of the universe, manifest and unmanifest. The ancient Mayonic secrets, which lead an individual to complete harmony with himself, others, his environment, and with the universe, are revealed in these cosmogony.

These ancient records reveal that Mayan was born about 12,000 years ago, in the now-lost continent described in many Tamil texts as Kumari continent. Kumari continent was a landmass off the Indian sub-continent that stretched across the seas to all of Indonesia and Australia. By the time Mamuni Mayan was an adult, all that was left was a large island mass called Jamboo Dweepa and a number of smaller land masses – perhaps Madagascar, Sri Lanka, and other bodies of land are all that remain after the deluge caused by the melting ice caps that covered Jamboo Dweepa.

In this article, it is revealed why Brahman or Consciousness chose and chooses to manifest itself as the material world. The reader, through careful attention, will come to understand why he or she was born and what he or she must do in life to be happy.

### **The Center Of Originator**

From Mayan's original work, Dr. V. Ganapati Sthapati translated a body of knowledge that reveals Mamuni Mayan's deep insights into what we might call the creative process. More aptly put, it is the manifestation process, for according to Mayan, nothing is created – it is manifested from the One Source. Even what we call "creativity" in art, science, literature, and so forth is a manifestation from the One Source. Modern science bears this out to be true: energy can neither be created nor destroyed – only transformed into different states. And, after all, according to Unified Field Theory and Quantum Physics, everything in the cosmos is nothing more than energy.

Thus, what Mayan was exploring and elucidating was the transformation of energy from potential energy (Unified Field) to kinetic energy (the material world). This is the story of the manifestation of life from and within the One Source. It is the story of the love that the Originating Source, sometimes called Moolam, Brahman, the Unified Field, had for its own inherent beauty and its search for that beauty in the manifest world. According to Dr. Sthapati, "This perfection It constantly creates (manifests) so that it may forever savor and enjoy this Ultimate Beauty" (An overview of Mayonic Aintiram, Dr. V. Ganapati Sthapati, 1992, p8). That is, the Originating Source found itself to be so beautiful and perfect, and in love with that beauty and perfection, that it

manifested itself in different material forms in order to experience and savor individual aspects of that beauty eternally. What is this beauty? Beauty is its infinite potential and its completeness, wholeness, and perfection. The Originating Source – Brahman – found its own *infinite potential, completeness, and wholeness* to be beautiful. That It contains infinite potential and completeness within Itself, is of itself beautiful and worthy of immense love. And the act of manifesting this perfection and wholeness – this beauty – provides the opportunity for this Originating Source to love and savor itself.

"The Personality of Godhead is perfect and complete, and because He is completely perfect, all emanations from Him, such as this phenomenal world, are perfectly equipped as complete wholes. Whatever is produced of the Complete Whole is also complete in itself. Because He is the Complete Whole, even though so many complete units emanate from Him, He remains the complete balance."

Shri Ishopanishad, Invocation

The following text is taken and paraphrased from various brilliant and insightful articles, monographs, and texts written by Dr. V. Ganapati Sthapati, one of which is a chapter called "The Center of Origination" and is part of his *Overview of Mayonic Aintiram* mentioned above. Much of the language that follows is that of Dr. V. Ganapati Sthapati who faithfully translated the concepts of Mamuni Mayan. Sthapati's words are in *italics*. I have added my own discussion to the text, remaining loyal to the meaning and understanding put forth by Mayan.

In this article, there are a number of words used that can be confusing. One in particular is the use of the word *Time*. The word *time* conjures up in the mind the concept of *conceptual time*. That is, time that has to do with numbers on a clock, the passage of hours minutes and seconds, the number of hours in a day, days in a week, how long it takes a runner to move 100 yards, and so on.

When Mayan speaks of Time, he is not speaking of conceptual time. Rather, he is speaking of Absolute Time – Kaalam. Absolute Time actually means frequency or pulse. In thinking about frequency or pulse, there is a notion of conceptual time (the time it takes for the pulse or waveform to rise and fall vertically, and the time it takes for the waveform to move horizontally through a medium), but when we consider Absolute Time, we are speaking of something greater than conceptual time. While conceptual time is inherent in Absolute Time, Absolute Time occurs in an unmanifest field and is the entirety of the pulse or frequency of the entire unmanifest field and underlies manifest particles, not just the vertical and horizontal movement in Space. In fact, Absolute Time is Cosmic Space or Consciousness in motion as a pulse or frequency.

Dr. Sthapati says that Mayan revealed that *the laboratory of the process of creation is within the inner being of every individual*. This is the source of all creativity. To comprehend the unfolding drama of the origin of universal beginnings, we must journey deep into the heart of the human center from which the Source or spirit consciousness vibrates and acts. Mayan says that this is the source of all origination. That is, the source from which everything in the universe and beyond originates. Mayan describes it as "the space of the action." And it is our origin.

Mayan says that this Inner Being is an extraordinary place. Its quality and its action are without pretense, and it is always spontaneous. The unforced, autocatalytic, natural action emanating from the center of consciousness makes it possible for the resulting manifestations to be



untainted and pure. Hence the ability of the Inner Being can be called spontaneously orderly and inherently intelligent. In fact, *intelligence of the inner being is the only real fact, while the cleverness of the brain is only a pale distortion.*

Sthapati says, *This center of the being is the place where the impact of all outer phenomena makes their impression. This is the space where the response to the outer world of reality is born. This is the genetic center of change and of metamorphosis. It is the untainted source of creation/manifestation. The outer impinges into the still inner consciousness and sets the inner being into motion. The spirit vibrates, spins around its own center, and begins to activate itself. Even in its stillness it is not frozen but filled with the promise of its throbbing, and hence that of the spirit can be called the vibrant core of consciousness. Within its aliveness and its ceaseless potential for action is contained a vigilant self-awareness, a watchful sensitivity. All the responses to itself and to reality are stored in this vibrant center. This spirit or the receptacle of awareness becomes the substratum from which the energy of the self is harnessed so that the Being could leap into action.*

*Mayan calls this spiritual center as Moolam (meaning source), Maiyyam (meaning center), and Pulli (meaning point) – the central source point of consciousness. In its awareness of the essence of reality, the Moolam is constantly coming into touch with its own fundamental nature. The Moolam absorbs and integrates the awareness of the essence of all substances within itself, and this intelligent self-awareness becomes the source of light. Hence the Moolam is capable of illumining itself constantly.*

*The first state in the appearance of the external creation of the individual being is the emergence of the luminous intelligence. This ambience of light is made up of countless particles of light, which appear in the space of the Moolam (Source).*

*In its desire to create a substantive representation of itself on the outside, the Moolam impels itself into a spin. Upon rotating, the particles are thrown out all around the center. It is from this action of discharging particles of light from the luminous core that the Moolam anticipates the end product of a manifested outer phenomenon. The very act of anticipation of a final outcome and the effort put into bringing this about are the reasons for the ultimate object to be transformed into a reality from the figment of an inner dream.*

*What is the substance of the outer phenomenon? Its nature and its substance are gathered from Moolam and are products of its own being, says Mayan. In other words, the Moolam recreates itself on the outside, but why? The joy it attains in its own existence is so intense that it constantly replicates itself so that the joy may never come to an end.*

*The action of replication that makes use of volition and the energy of light is the process of Time. The very act of holding an idea of the ultimate product and striving towards its attainment requires "Time," says Mayan, and the concept of a continuity and the birth of a now and a later, take place at this point. Hence the Moolam, which originally inhabited a timeless, limitless space, has now brought time and limits into the picture. It follows that it also has to limit itself in a manner that would contribute to the efficiency and order of the ultimate product. The Moolam creates an order in its energy discharge, and the control it exercises on its luminous particles is called "Seelam" or intrinsic order. This is called Tala Purusha or Mayonic Order. Without discipline, the energy would be needlessly wasted, and the final product would prove to be disorderly or chaotic.*

*From the movement of the Moolam or Pinda Moolam (the source of animate objects/source of the micro universe), in orderly rhythm, the beauty of art and the sweetness of language are born. In a similar manner to the nature and action of the individual Moolam, the universe too acts from its own center, which may be called the macro cosmic center or Anda Moolam. This larger consciousness too feels and vibrates, impels its inner being into action so that it too may perpetuate its unending "joy of awareness." It is from this action of the Anda Moolam that the five elements (space, air, fire, water, earth) are born, as also the whole of universal reality.*

*Starting with this all-encompassing base, Mayan moves on to build further on his theory, by according a grammar to all creativity. This grammar or order is natural to the growth and movement of life itself and hence inseparable from the consonant co-existence of the macro and micro beings. Thus he stretches this order from the very nature of existence to the emergence of all the arts, the emergence of language, the beginning of technology, and so on. (The formation of life from the smallest of the small to the largest of the large follows the cosmic grammar or order perceived and articulated by Mayan.)*

*Dr. Sthapati goes on to say that, in a nutshell, the theory can be stated thus: The inner being of both universal and individual consciousness has the inherent ability to become aware of itself and its experiencing of the world of reality. (This awareness is intelligent and hence luminous.) The luminosity of the inner being can be harnessed and directed to create a tangible evidence of its own inner savoring. The order brought into play to control this luminous self-energy is capable of being fundamental to all outer action that is Time-based and hence can be set out in a light symbolic manner. From this, all creation can be set into motion.*

*Dr. Sthapati continues by saying that now that the inner being has created an audible and visible representation on the outside, what does it really perceive and hear? The paradox lies in the utter simplicity of the answer. The Moolam (Brahmam) is in love with its own inherent beauty, and this beauty it searches for on the outside, and this perfection it constantly creates so that it may forever savor and enjoy this ultimate beauty.*

Let us now examine the individual particle of light that is flung out from the Moolam when it begins its clockwise spin around itself. Mayan says that each of these particles is a cube in form when still, but it is rounded off through the action and momentum the spinning motion, which has an impact on the natural form and shape of the original substance. Time (pulse, vibration) is the reason for the decadence of the inherent form of substances; that is, Time destroys and puts limits on the manifested form. But the un-manifested supreme substance is incapable of being reduced and is called the eternal substance. The destructible outer manifested form is the never-ending spin of life and death, the movement of casual nature.

Dr. Sthapati goes on to say that the original cube of the Moolam contains the pulsating throbbing energy of potential light within it. This energy is always vibrant and never frozen. To this primary particle Mayan gives the name of *sitravai* or the minute cell. The vibrant energy is fluttering to an inherent rhythm not unlike the steady regular beat of the heart. This ceaseless vibrancy Mayan compares to an eternal dance – the dance of all reality – *the divine dance of Nataraja*. He calls the image of the eternal cosmic substance as the aesthetic vision of the primeval vibrant particle of consciousness.

The primary inner consciousness activates itself and creates the visible (from OM Light) and audible (from OM Sound) phenomena on the outside. In answer to this question, “What is the nature of the original space from which the multiple reality of the universe is created?” In his cosmogony, Mayan concludes that the Moolam (source), which is the seat of this creative unfolding, is substance too, and so a participant in the numerical progression emanating from its center. Space, in fact, is a substance; Consciousness is then known as the primary substance or Vastu, Porul. And it is that primary substance, Vastu, that contains within itself infinite potential. In love with its own beauty and wanting to experience that beauty outwardly, it transforms itself into the infinitely complex material Vaastu we know as atoms, molecules, cells tissue, humans, plants, minerals, animals – the sum of the manifest world.

### **From Beneath the Sea**

When visitors to the southern tip of India, called Kanyakumari, view the rock outcropping that holds a magnificent 133-foot, 7000-ton Vaastu statue of the great poet Thiruvalluvar, they stand in awe of the structure. What they don’t see is the empty space within. They see the beauty, material order, and the stone, but they don’t see the space, time, energy, and Mayonic Order that is contained within the massive structure designed and constructed by Dr. V. Ganapati Sthapati using traditional Vaastu principles as put forth by Mamuni Mayan in his Pranava Veda, Aintiram, and Vaastu Shastras.

They also don’t know that the vastness and greatness of this structure is minute compared to the massive landmass, now beneath the sea, that stretched from India to throughout Asia to Antarctica – a portion of which birthed one of the greatest humans in history over 12,000 years ago. It is by virtue of this man, Mamuni Mayan, that the principles of Vastu Science and Vaastu Science and Technology were developed and preserved through the Pranava Veda and the Aintiram.



These two publications (*Fabric of The Universe* and this article) record the process and order employed by the Supreme Intelligence that lives manifest and unmanifest. It is only through the untiring efforts of Dr. V. Ganapati Sthapati and functioning of The American University of Mayonic Science and Technology that these principles are being brought to the light of the world. It is from the depths of the sea of

consciousness that he has perceived the subtle truths contained in these publications from ancient times – the knowledge of The Center of Origination – Mayan’s scientific yet spiritual cosmological view.

### Epilogue: The Unseen Force

The power and beauty of Mayonic Science and Technology and Vaastu Science and Technology is displayed more by what is not seen than what is seen. The beautiful temple structure below is a temple under construction in Hawaii – being built by Dr. V. Ganapati Sthapati. The “Dhyana Garbha” below is a structure built by the students of The American University of Mayonic Science and Technology in Las Vegas, New Mexico during the practicum in July and August and October 2006. My experience and the experience of others who have been in both places is that the Vaastu effect is equally powerful and clear at both sites. It is not the outside that creates the effect; rather it is the mathematically precise bound Space within. While ambiance is very important in Mayonic Science and Technology, it is the scientifically and mathematically defined and constructed bound Space that generates the Vaastu effect. The boundary may be lavish or simple – as long as the principles of Mayonic Science and Technology are faithfully executed, the effect of spiritual bliss and peace may be experienced. All gratitude to Mamuni Mayan.





## APPENDIX A

### Manifestation and The Square Wave: What the Blip Is Going On?

*As in Micro, so in Macro. The whole exists within the minutest particle and the minutest particle contains the whole. The atom contains the universe and the universe contains the atom, and neither exists without the other. Creator exists within creation, even as creation exists within creator.*

Brahmarishi Mayan, circa 10,500 BCE

Mamuni Mayan discovered that the fundamental form of creation is the cube. This cubical structure is called the microabode (smallest particle that is the abode of pure consciousness/Absolute Space/Akasha). The initial pulse in Absolute Space as described in this monograph forms this minute structure.

In examining the dynamics of manifestation, we see that manifestation occurs in additive values of eight as described in this monograph. However, one could be puzzled by the fact that the very first “structure” is shown as four units rather than eight. One might be compelled to ask, “If the principle of eights is true, then why does the first form only have four space-time units?”

If we take Mamuni Mayan’s statement above and apply it to current scientific knowledge about the nature of square waves gained through modern science, perhaps we can have a better understanding of the subtle formation of the initial 4x4 structure during the manifestation process. In other words, Mayan’s law above states in essence that what is in the manifest world is found in the unmanifest world and vice versa. Since we already have scientific knowledge about square waves in the material world, perhaps we can apply this to the unmanifest world and the manifestation process. This will possibly help us to understand the peculiarities of the process of manifestation.

The particular issue under consideration here is the principle that manifestation occurs in eights, yet the very first module that appears in this text is the 2x2 mandala. It is from the 2x2 structure that the principle of the additive factor of eight begins rather than at the very onset of the process. The following may shed some light on this.

Scientists have discovered that when a square wave begins, it has a fall equal to its rise. In the figure below, the + point is the zenith (peak) of the rise of the square wave while the – points out the nadir (lowest point) in the fall of the square wave. This represents one full pulse in the square wave.

The following diagram demonstrates this:

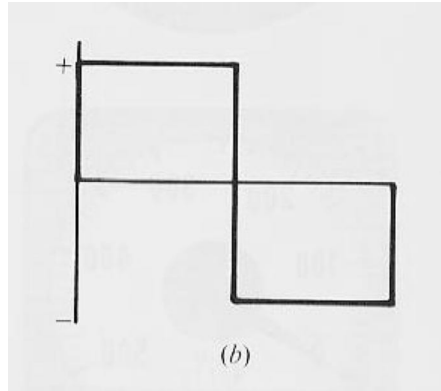

Notice that as the square wave falls to its nadir, it proceeds forward in the space-time continuum. Thus the rise and fall of the square wave pulse actually occupies what might be called four units of space within the one pulse.

In observing this phenomenon visually, it becomes immediately apparent that the single pulse of the square wave actually creates four space-time units as shown below:

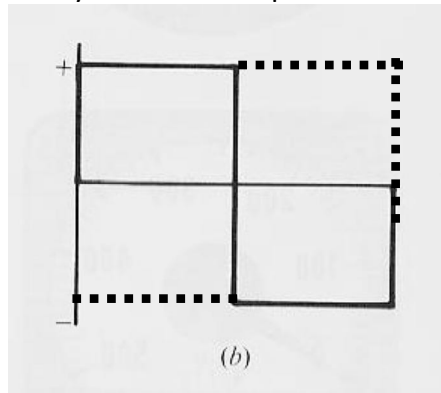

In other words, one square wave pulse could be said to create four space-time units. Hence, we may extrapolate from this that with the first pulse of Absolute Space, four Space Time units are created.

It is as if with one blip or pulse, Absolute Time, OM Light and OM Sound are created (four units composed of Absolute Space, Absolute Time, OM Light, and OM Sound). Then manifestation occurs in two pulses at a time (each blip contains four Space-Time Units or eight units each in an additive manner) – blip, blip (Air) – and continues – blip, blip (Fire); blip, blip (Water); blip, blip (Earth). Eventually forming what is called the 8x8 Manduka Mandala.

In summary, the initial manifestation process begins with the formation of a 2x2 structure formed from one pulse of Absolute Space. It is from that point on that the additive factor of eight begins.

This discussion is merely an attempt to present a theoretical concept designed to reconcile the apparent initial non-conformity to the general principle that manifestation

occurs in eights. Future additions or deletions may be made to this theoretical construct. Note: Below are two demonstrations of the development of the sacred form known as the swastika related to the concept the square wave. It is easy to see how this ancient cross-cultural image was derived.

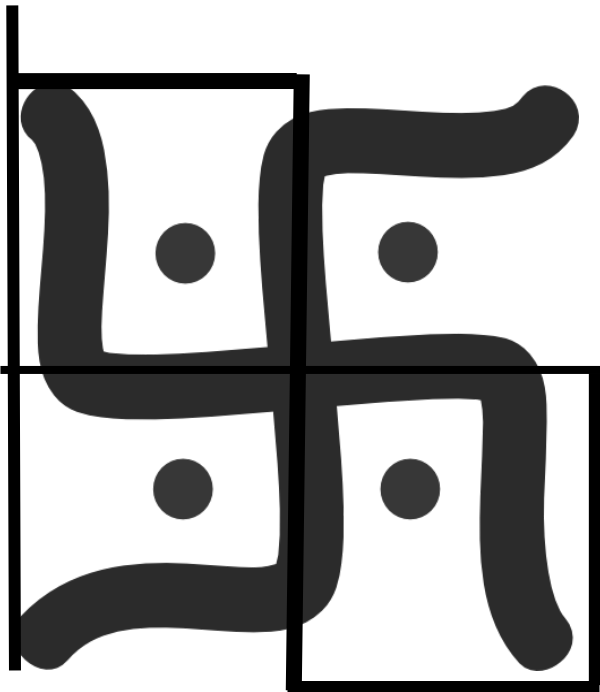
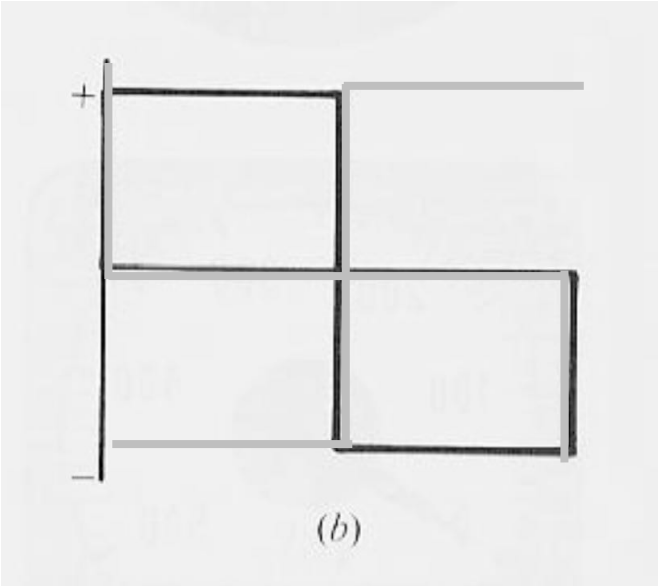

Please return to the main text and continue reading section 4.





## APPENDIX B

### The Mayonic Code: The Physics of Wave Forms and Vastureva Vaastu

Mayonic Science and Technology and its sub-topics of Vastu Science and Vaastu Science and Technology are deeply rooted in the science of physics. More accurately, since Mayonic Science and Technology preceded physics as a discipline by about 10,000 years, one could say that physics is deeply rooted in Mayonic Science and Technology, and it is Mayonic Science and Technology that will ultimately explain the science of physics. In the meantime, we can use principles of physics to help us understand the mechanisms and dynamics of Mayonic Science and Technology.

In this discussion, I will present some fundamental ideas found in most basic physics texts and relate them to Mayonic Science and Technology. Physics is the scientific study of matter, energy, force, and motion and the way they relate to each other. Physics also investigates and elucidates on the physical processes, interactions, qualities, properties, and behavior of something.

Mayonic Science and Technology is the science of manifestation of subtle energy into embodied energy. It is the science of manifestation, energy, matter, time, space, rhythm, and form. Principles of physics can be found in Mayonic Science. Mayonic Science extends those theoretical principles of physics through Mayonic Technology to material applications. The study of physics will in turn help us to understand Mayonic Science and Technology.

#### Physics 101

##### Principle

Present-day physics has confirmed that everything in this Universe is composed of vibratory or oscillatory components, be it solid or evanescent (transient/disappearing). Those oscillatory components are fluctuating waves of energy called sine waves and square waves. The genesis of these waveforms is called a pulse.

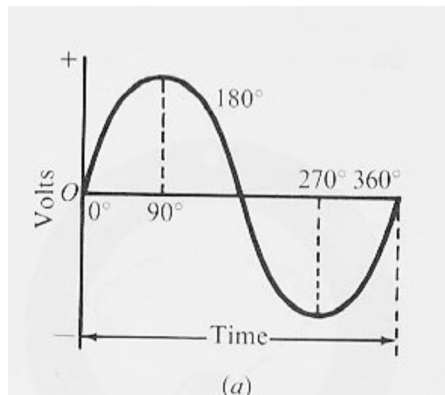

Sine wave

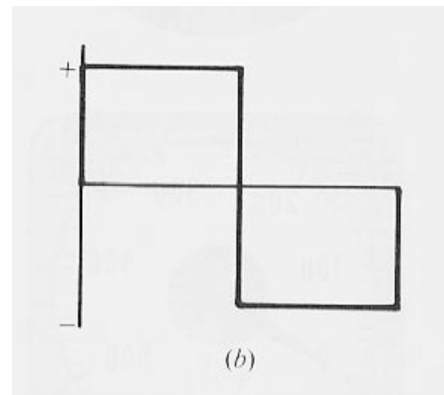

Square wave

- A pulse is a single disturbance moving through a *medium* from one location to another location. One particle is stimulated or pulsed, and that particle acts upon adjacent particles. The repeating and periodic disturbance, which moves through a medium from one location to another, is referred to as a wave.

### **Application to Mayonic Science**

Mamuni Mayan says, “The primal manifest form of the unmanifest is square.” He calls it a primal wave pattern – (Aintiram) – the pure energy cube. From this we can say that the most fundamental waveform is cubical/square in nature.

Interestingly enough, scientists say that contained within square waves are potential sine or curved waves. If we use the knowledge gained from Mamuni Mayan (as in micro, so it is in macro and vice versa) and the facts offered by modern physics, it is possible to understand the mechanisms of unmanifest pure energy (Vastu). Why is this important to think about and apply to Vastureva Vaastu?

In understanding that the square wave contains a series of sine waves, if we look at what happens to square waves under certain conditions, we might find a clue to the 8=9 phenomena.

### **Principle**

- The speed of a wave increases with wavelength (the change of speed with wavelength is called dispersion).
- Dispersion causes long wavelength waves in the square wave to move faster than the short wavelength waves.
- As *time* progresses, the square wave is decomposed into a spreading series of waves of different wavelengths. In other words, with increase in amplitude, the square wave spreads out into various wavelengths as it decomposes with increased speed and gives way to sine waves.
- Sine waves are curved by nature and, if spinning, form a circle.

The following diagram shows a square wave increasing in amplitude and speed then decomposing into sine waves.

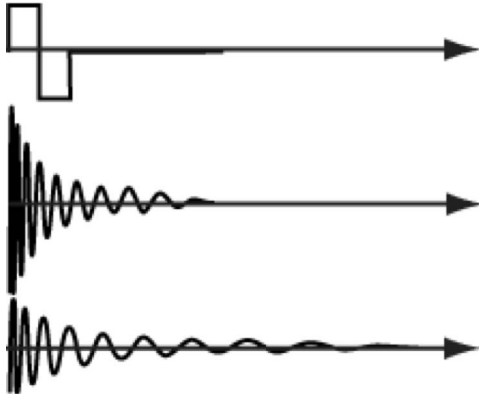

(See Appendix C for more on this)

### Application to Mayonic Science

In the formation of the 8x8 Manduka Mandala, it was previously noted that the concentric bands of time space-time units (modules or padas) that form around the central Bindu point contain more and more modules (space-time units strung together), forming increasingly long bands of energy. In addition, it was established that those bands around the central Bindu point are frequencies or waveforms/wavelengths. During the process of manifestation, wavelength increases additively by eight. That means that there is also a change of speed with the increase in wavelength. It is hypothesized that, as described above, when there is an increase of wavelength, and speed, the square wave becomes dispersed and forms a sine wave. Since the whole entity is spinning, it is easy to see how the sine waves could form a circle.

### Principle

When sine waves interact with each other in a specific way (two sine waves of equal frequency and intensity traveling in opposite directions combine), those waves appear to be stationary or standing still. This illusion is called *standing waves*.

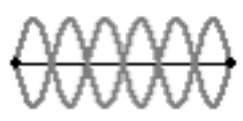

Standing waves

Waveforms have specific qualities based upon only a very few simple characteristics.

Those characteristics are:

- A. Wavelength – the actual length or measure of the wave – length of one complete wave cycle.
- B. Amplitude: the height of the wave or the maximum amount of displacement of a particle on the medium from its rest position – the distance from rest to crest.

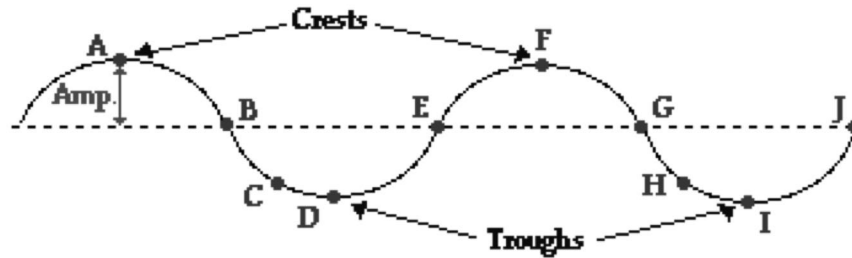

(The units from A to B, B to C, C to D, and so on, can be viewed as Space-Time Units.)

To fully understand the nature of a wave, it is important to consider the *medium* as a series of interconnected or interacting particles. In other words, the medium is composed of parts, which are capable of interacting with each other. The interactions of one particle of the medium with the next adjacent particle allows the disturbance to travel through the medium

### **Application to Mayonic Science**

In the case of unmanifest creation, within the fundamental medium called Absolute Space, there are uncountable numbers of cubical particles called microabode (smallest particle that contains absolute space). When a self-activated pulse occurs within Absolute Space, one particle acts upon adjacent particles and ultimately creates a waveform or waveforms. Given the nature of Absolute Space, it would be easy to imagine a holographic waveform. This vibrant but unmanifest energy is called Vastu.

### **Principles**

Waves are said to be an energy transport phenomenon. As a disturbance or pulse moves through a medium from one particle to its adjacent particle, energy is being transported from one end of the medium to the other. This is the story of the formation (in the medium of Absolute Space) of Absolute Time, OM Light, OM Sound, Air, Fire, Water, and Earth as described in this monograph.

An interesting property of wave functioning deals with the results that occur when a wave moves across a medium and strikes a boundary.

- A portion of the energy carried by the pulse is reflected at the boundary and returns toward the source of the wave. (Light energy is reflected back and sound energy is echoed back.) The disturbance, which returns to the source after bouncing off the boundary, is known as the reflected pulse.
- A portion of the energy carried by the pulse (about half) is transmitted to the boundary, causing the boundary to vibrate.

### **Application to Mayonic Science**

In Vaastu Science and Technology, we understand that pure waveforms are generated at the center of the Brahmastan and move outward in all directions toward the boundary or Motherwall established through the numerical equation of the Ayadi calculation. As we

know in physical wave dynamics as described above, part of the wave generated in the Brahmastan is transmitted to the boundary or Motherwall. The Motherwall then vibrates with the qualities generated in the Brahmastan. That vibration is carried throughout the structure, creating a constantly vibrating form.

*...if a part of free space is isolated and confined into a four-walled structure called building, it becomes a living organism, and the space enclosed will start vibrating in a particular order. If such a building is designed to vibrate in the same numerical order as that of the indweller, the resultant phenomenon is that, he will experience harmony or perfect union with the Universal Self...* Dr. V. Ganapati Sthapati

Square waves of the 8x8 transform into vibrating sine waves represented by Nataraja (dancing Shiva). They proceed out from the center of the Brahmastan in all directions (only one direction indicated below) and pass through space to the boundary established by the Motherwall. In following the principle that when a wave hits a boundary it splits, part of the pulse is transmitted into the boundary and causes the boundary to vibrate, and the other part is reflected backward to its source. The part of the wave that moves backward causes a commingling or interference with new waves, moving forward toward the boundary, thus causing standing waves. The amount of wave energy that stays with the boundary is influenced by the medium it is passing through and the boundary conditions.

As the standing waves vibrate, the waves from the 8x8 structure can be said to meet themselves in the returning waves. That “meeting of itself” and commingling (Absolute Space meeting Itself) creates an additive factor that creates the 9x9 structure of the Vaastu Purusha mandala. In Mayonic Science and Technology, this phenomenon is understood to be the cause of the vibrational nature of a Vaastu form. That is, the Motherwall then becomes a vibrating structure that passes this vibration onto the inhabitant. This accounts for the many benefits experienced by people living in Vaastu homes.

Since a properly built Vaastu structure is cuboidal and mirrors the form of Vaastu Purusha, the entire structure – walls and airspace – are packed with vibrating microabodes (smallest unmanifest particle that contains consciousness). This accounts for the overall sense of wellbeing experienced by inmates as they begin to vibrate within their own microabode with that of the Cosmic Principle.

**Unmanifest** microabode vibrating within itself and manifesting as “house.”

**House** as manifest microabode vibrating with life-giving qualities.

**Human microabode** as recipient of frequency of house Bhakti.

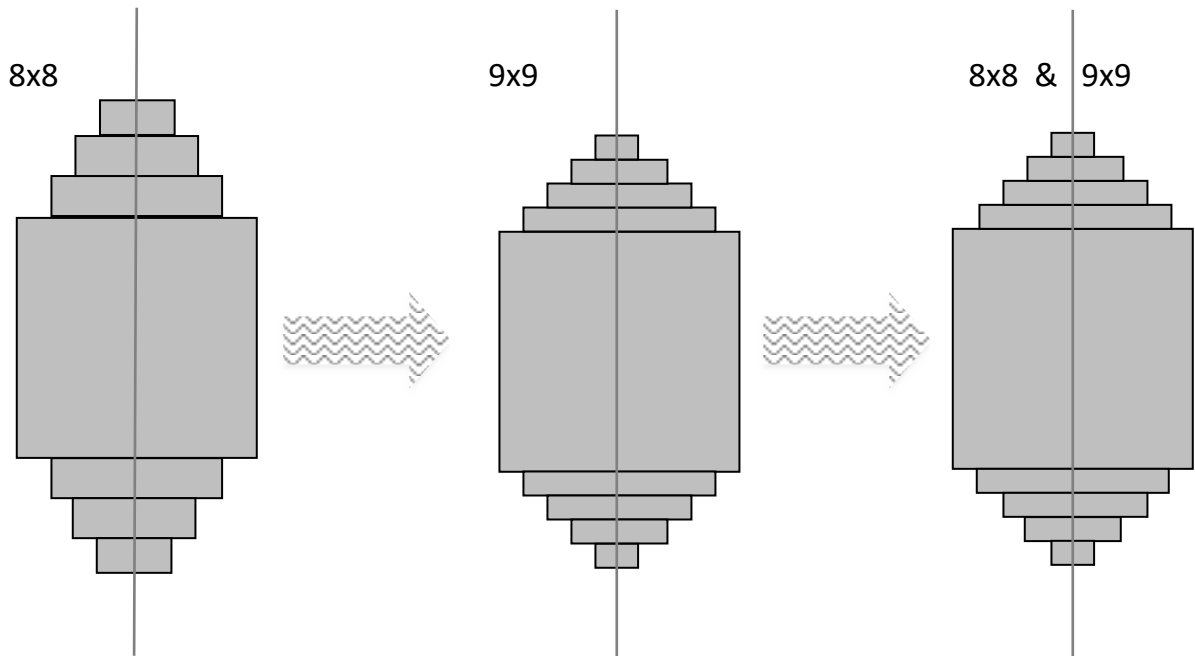

How does this happen? The following diagram demonstrates the mechanics of this phenomenon. And above and beyond this mechanism, as you can see from the previous diagram (three microabodes), the inhabitant (person) and the house are nothing but Brahman in bounded form.

Regarding the following drawing: The *Motherwall* is the main wall of the house the size of which is precisely calculated using specific mathematical formulas to create a vibration that is resonant with the inhabitant. Please go to Chapter 5 (pg. 64-69) for a thorough discussion on the topic of *Motherwall*. After you read the entire book, you might want to come back here and review this section – it will be even more meaningful to you then.

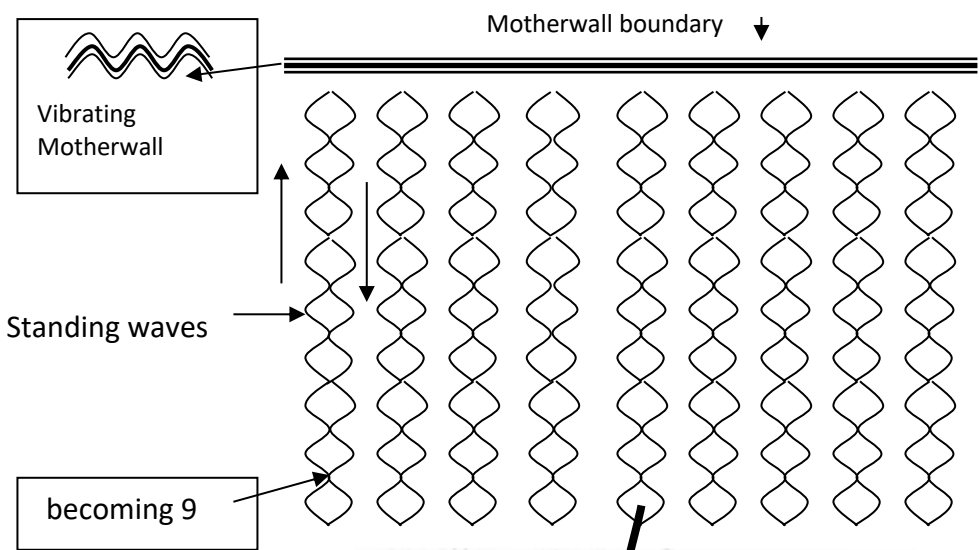



## The Code

The transformation from *square waves* to *sine waves* and back again is the story of the dynamics of Vastureva Vaastu – the 8x8 Vastu Purusha Mandala transforming itself into the manifest 9x9 Vaastu Purusha Mandala and back again.

As this takes place, I suggest that the transformation of eight to nine results in the production of *standing waves*. I believe that this scientific principle is encoded in the forms created by Vishwakarmans (Shilpis, Sthapatis, etc.) using principles of Mayonic Science and Technology. For example, I suggest that the famous Vishnu Statue is one such encoded form. The coiled serpent with many heads (*Adishesha*) represents/demonstrates *standing square waves* and *standing sine waves* in their steady state forming a foundation for manifest Vaastu to sustain itself in material form represented by the God Vishnu (*Ranganatha*). While there may be other meanings associated with this particular statue form, I am suggesting that this might be an encoded scientific meaning.

In review, a standing wave pattern is a vibrational pattern created within a medium (space, stone, clay, architectural structures, etc.). When the vibrational frequency of the source causes reflected waves from one end of the medium to interfere with waves traveling from the source, specific points along the medium appear to be standing still. Because the wave pattern appears to be standing still, the pattern is called a "standing wave pattern." These standing wave patterns are only created within the medium at specific frequencies of vibration; these frequencies are known harmonics. In Mayonic Science and Technology, the medium is Absolute Space and all of the elements described earlier in this monograph (Absolute Time, OM Light, OM Sound, Air, Fire, Water, Earth) are vibrating frequencies and the materials used to create manifest forms. The vibrational frequency is manifested through the mathematical formula used to create the Motherwall of a Vaastu structure/form.

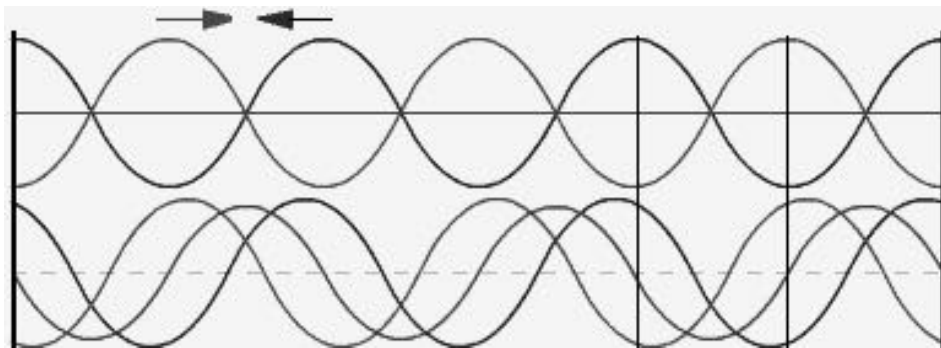

Top row: sine waves coming from opposite directions, interacting with each other, causing standing waves.

I believe that in the Shilpic tradition of Mayonic Science and Technology, this (and other scientific principles) was preserved through visual language and visual mathematics in the reclining Vishnu statue and in the forms of other gods and goddesses.

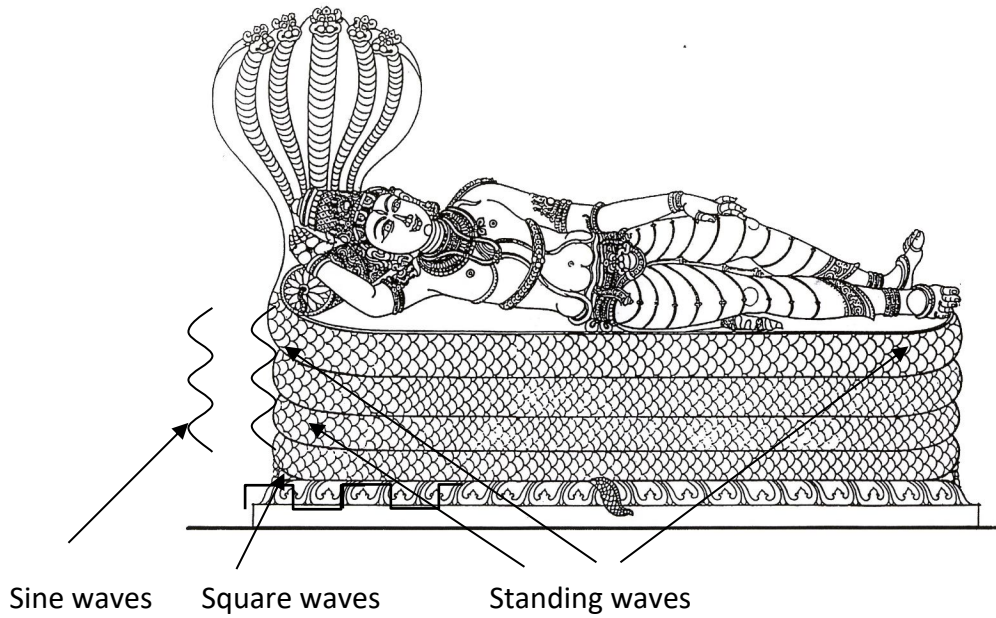

In *Indian Sculpture and Iconography* (Dr. V. Ganapati Sthapati), this is further demonstrated on pages 49-56 where discussion on *Nata Manam* – measurement of the body in flexion – is conducted. The measure of flexion when turned sideways is none but the form of a sine wave. See figure below.

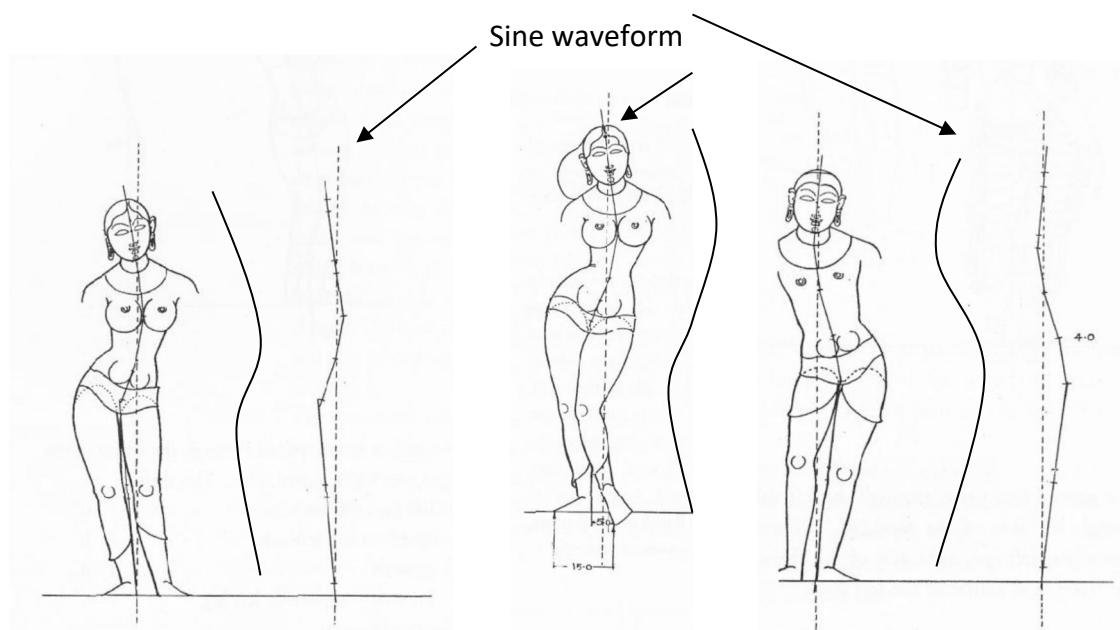

In light of these ideas, Vishnu and other gods and goddesses may be viewed as gods but more appropriately, should be viewed as scientific phenomenon. I contend that this is a scientific principle demonstrated and preserved by the Shilpic arts and science – none other than Vaastu Science and Technology.

In the Shilpic tradition, the “medium” is stone, metal, clay, wood, etc., and the mathematical formula used to create the form serves as the boundary that the waves strike and cause vibration.

Another example of the coding of scientific principles in Mayonic Science and Technology is illustrated by the following information derived from the writings of P.V.N. Murthy (Author and Editor: <http://www.vedsri.org/linguamths.asp>).

*Take the two words Ganapathi and Shanmuham appearing in books on different topics. Logically, a person reading them from a Hindu religious book will immediately think of Lord Vinayaka with a potbelly, elephant head sitting with a big mouse at his foot and of Lord Subramanya with a three-headed dagger in his hand, sitting on a peacock. It will also come to mind they both have a brotherly relationship. Suppose the same names appear in a pure biography book and a person not knowing any Hindu religious names reads them. No gods will come to his mind at all. He will only think of some places or persons having these names. Suppose either a religious or a stranger to Hindu religion, not having any knowledge of science and mathematics, reads these words in an actual science or mathematics book, and suppose he does not know the subject of the book also. He is sure to get thoroughly confused. The words would appear non-cohesive, irrelevant, and do not make a meaningful sentence. He might even mistake them for mysterious “manthras.” He may fumble upon them in his curiosity to make out something useful. This might substantiate the third possibility. Suppose a scientist or mathematician knowing the exact code of the language in which the book was written reads the same two words. He takes the exact meanings:*

*“Gana” = cubic; “pathi” = space (or owner of gana); “Shan” = 6;  
“muham” = face.*

*“Ganapathi Shanmuham” = six faces of the cubic space. Incidentally, this is a mathematical concept in physics that a perfect cube of a given length has six faces. This substantiates the first possibility.*

So we see that the knowledge of the six-sided Vastu cube (microabode) is encoded and preserved in the statues of Ganapati and his brother.

Another example of this scientific code hidden in the names and forms of Shilpic designs is the description given to the Nataraja or Dancing Shiva shown on the previous page. Traditional practitioners in the Shiva temples adore Nataraja as “*Kalacakra Pravartakah*.” The translation of this is “the one who wields the clusters of time units and time divisions on various planes” (Dr. S.P. Sabharathnam, Introduction to Mayan’s Aintiram, p. xv). This clearly refers to the space-time units discussed at length in this book.

While this information refers to linguistic encoding, I would like to point out that language formation and meaning is within the scope Mayonic Science and Technology. The Shilpi tradition has used visual language to encode scientific principles and aural language to encode the same scientific principles by naming the forms they create. Their visual literacy is directly connected with verbal literacy. They create in name and form a heretofore-secret scientific code in the forms that have survived the centuries.

As you will see from reading this text, Space (Cosmic Space not celestial or outer space) itself turns into Earth through the manifestation process of unfolding qualities – OM Light, OM Sound, subtle Air, Fire, Water, Earth, three Gunas (Satwa, Rajas, Tamas); then material qualities of Air, Fire, Water, and Earth. There is energy in Space (Vastu) and energy in Earth (Vaastu). To be energetic and always vibrant, Earth must be in constant contact with Space. Earth, which is seeded with subtle but powerful energy, becomes known as Vaastu, and the energy itself seeded inside the earth is known as “Purusha” thus, the earth-energy is called Vaastu Purusha. (Temples of Space Science, Dr. VGS, p 102-103)

Vaastu Purusha is diagrammatically indicated through the Vaastu Purusha Mandala or Paramasayika Mandala. Vaastu Purusha may appear externally as calm, quiet, and undisturbed, but in reality, he is a great force, great Purusha (consciousness), ever vibrant, ever energetic. It this vibrant and energetic Bhumi Purusha (Bhumi means earth) that we call Vishnu. Lord Vishnu is Vaastu Purusha. While the statue of Lord Vishnu is taken as a being a god to be worshiped, it is, in face, an encoded form that demonstrates the produce of Vastureva Vaastu – that is, Earth, Vaastu Purusha, or Vishnu.

Unmanifest Luminous Space, or Energy, is known as Vastu Purusha Mandala or Manduka Mandala. This form is visually demonstrated and encoded through the beautiful statue Mayan cognized and created called Nataraja. When we look at Manduka Mandala or Vastu Purusha Mandala, we can think of Nataraja and Luminous space. This inimitable light that Nataraja demonstrates is of the nature of consciousness itself. It shines forth as the Brahman and the energy of Brahman; this itself is the luminous Nataraja. (The word light actually means consciousness – luminous Space means conscious Space).

Nataraja is the first manifestation of the Primal Light. The innate energy of the Primal Existence releases itself from the circumscription of the microabode. In sequence to this manifestation, the spinning rhythmic movements or dances of Light and Sound take

place. *Due to the explosion that takes place inside the microabode (essential form of consciousness), an ordered and uniform array of radiant light rays spreads in all directions, and it is such a picturesque vision of the marshaled luminous rays that are described as the Dance of Light or the Dance of luminous Nataraja. This is the traditional concept of atomic science centered on the explosion of atom into material form. (Dr. V.G.S)*

The frequency of vibration of the Primal Existence is employed and expressed in the image of Nataraja, and that a mathematical order or numerical expression arises as a result of that vibration is given in a concrete form – Nataraja. The statue of Lord Shiva represents the eternal dance or frequency of vibration of this dancing. *It is the dance, which signifies the creative and devouring role of the great Time, which signifies the cyclical order of Time (Dr. VGS). From this arises the mathematics of manifestation and manifest forms that we use in Mayonic Science and Technology, Vaastu Technology, and Sthapatya Veda. The form of Nataraja encodes the entire journey taken by Consciousness as it develops its material Self. The image of Nataraja is the quintessential form of Space Principle. Outer space or Supreme space is the abode of Nataraja (Dr. VGS). This is what we must think of when we think of Vastu Purusha Mandala or Manduka Mandala.*

The two energies (Nataraja & Rangaraja – Vishnu) are one and the same consciousness taking shape within the body of Consciousness or Space. The traditional Nataraja with uplifted foot pointing in the clockwise direction indicates Shiva or unmanifest Consciousness; the Nataraja form with the uplifted foot indicating a counterclockwise direction is actually indicative of Vishnu or Vaastu Purusha. Likewise, the two energies depicted by the two Mandalas (Vastu Purusha and Vaastu Purusha) are one and the same.

*Neither the brilliance of the sun, nor of the moon, nor of the stars, nor of the fire could be equated or compared with the luminosity of the effulgent Brahman-light. Nothing of these could excel it. It shines forth as the basic source of illumination for all the luminous objects of the universe. It shines forth of its own accord, i.e., it does not derive light from any external source. On the contrary, it serves as the very basic source of light for the whole universe. This is the innate efficacy of the primal light-thread. This is why the Mundakopanisad calls it “Jyotisam Jyotish,” i.e., light of the lights. This is also called Brahma Tejas, Paramjyoti, etc. In Tamil we call it “peroli,” the unexcellible effulgence, and in English we call it spiritual light. This incomparable light is of the nature of consciousness itself. Is it not consciousness that sees and makes us see, that hears and enables us to hear? So this itself shines forth as the Brahman and the energy of Brahman; this itself is the luminous Nataraja. (Dr. V. Ganapati Sthapati, Temples of Space Science)*

The concept that the images of Vastu Purusha Mandala and Vaastu Purusha Mandala are images of demons being forced to earth by mini gods is completely erroneous and should be completely disregarded.

This is an extremely exciting era in the unveiling of the secret scientific codes preserved by Mayonic Science and Technology through the Shilpis, Sthapatis, and other members of the scientist/artist Vishwakarmas of Mother India.

**Please return to the main text and continue reading.**

## APPENDIX C

### More On The Formation of Square Waves and Sine Waves

The purpose of the following section is to demonstrate that a square wave can be formed by a sine wave and that a sine wave can be formed by a square wave. This information is relevant to understanding how the 8x8 unmanifest cube changes itself into a 9x9 cube and its ensuing myriad forms of creation and vice versa.

A square wave can be constructed from combining multiple sine waves at different frequencies. The sine waves added in addition to the fundamental frequency are called harmonics; a square wave has harmonics at odd multiples of the fundamental frequency. As higher harmonics are added, the result gets closer to an ideal square wave, which contains infinite harmonics (<http://www.slack.net/~ant/bl-synth/4.harmonics.html>).

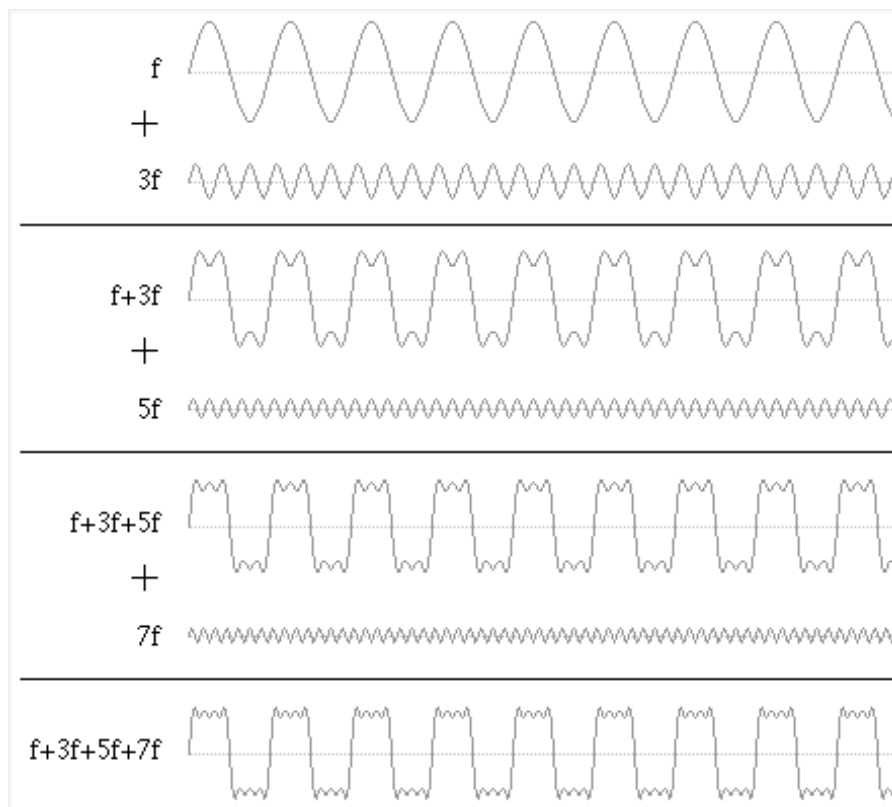

In the same way that a square wave can be created from multiple sine waves, a sine wave can be created/manifested from a square wave through *filtering* the many sine waves from the square wave. In other words, because a square wave is made up of innumerable sine waves, it can be transformed into an individual sine wave by filtering out the other sine waves.

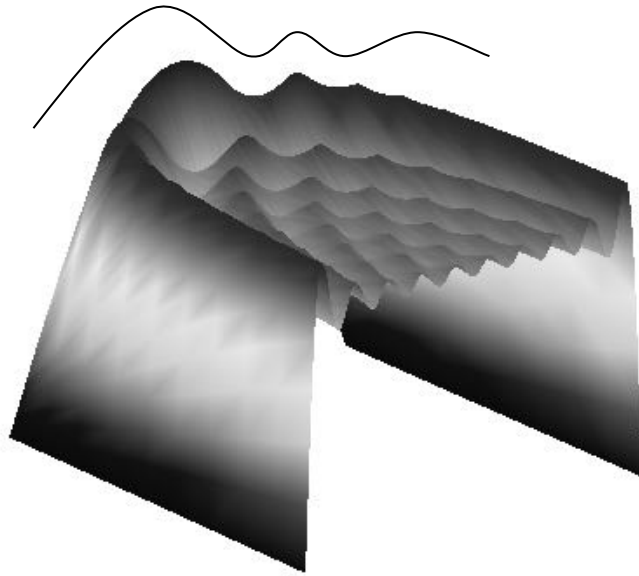

In the process of eight transforming into nine, we see the formation of individual sine waves from the square waves that form the 8x8. What evidence can we find to test that that theory?

1. The phenomenon of a circle arises during the process. A sine wave has the potential to become circular wave when spinning or stimulated.
2. If we look at the secret formulas of the Shilpis, we see the existence of the sine wave demonstrated by their images.

“OM Light and OM Sound are like huge waves of the ocean of The Primal Source. These waves subside as tiny ripples of normal sound and musical notes. OM Light and Ōm Sound belong to the luminous space in which the working system of light energy and space energy are seen.” (Vs 6, Pranava Veda, translation by Dr. S.P. Sabharathnam)

Mayan goes on to say in verse 7, that this primary event is in the form of a six-sided cube that has three dimensions (length, width, and height). He says that the force of light scatters itself causing luminosity in the cosmos. At this state, the cosmos appears as a beautiful creation (From Pranava Veda translation by Santhana Krishnan Sthapati, Architect Krithika Karuppiyah, confirmed by Dr. Ganapati Sthapati). Note: Usage in this is one of the few times in history that the Pranava Veda has been directly cited in English.

*Brahmam, as defined by Mayan, in his astronomical treatise called Surya Siddhanta: Tri-dimensionally every particle of space is a subtle cube of Energy, called Chitrabalam or Micro-Abode within which there is a "shaft of light" or "shaft of consciousness" vibrating or performing a "rhythmic dancer." This is the dance of the Cosmic Dancer, Lord Shiva. The whole universe is filled with subtle cubes of energy call Karu or Bindu or Foetus. (Dr. V. Ganapati Sthapati, Building Architecture of Sthapatya Veda, p. 53)*

**Please return to the main text and continue reading.**





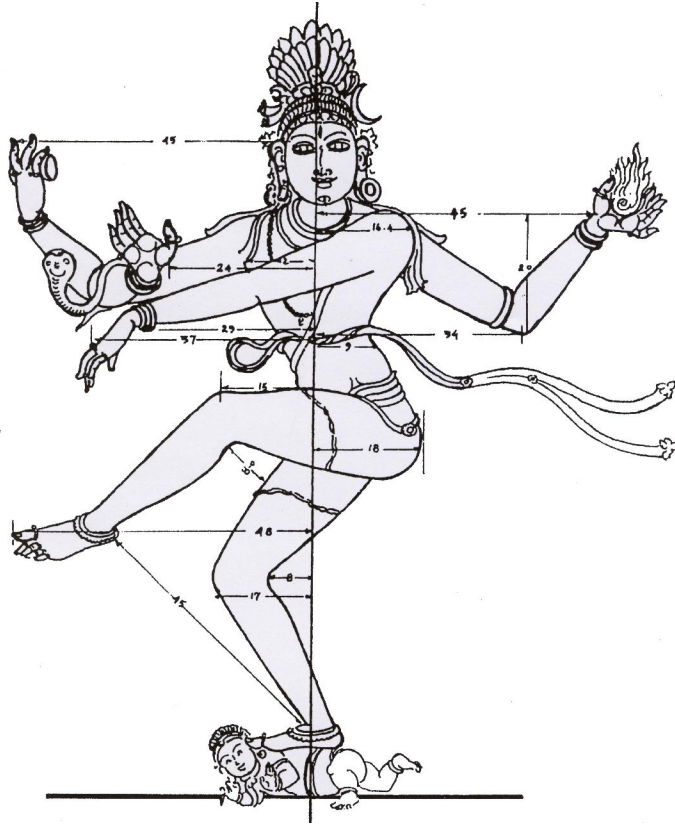

Nataraja, Dance of Shiva composed within 8 X 8 modulated Space  
 (Anushtub Chandas)  
 Dance of Light in Microabode  
 Celestial Being  
 Vastu or Energy