

Abbott-Interfast Corp
190 Abbott Dr
Wheeling, IL 60090



Abbott Screw & Mfg Co
6525 N. Clark St
Chicago, IL 60626

Yellow nylon insert for locknuts

ABSCOA INDUSTRIES
1071 West Arbor Vitae St
Inglewood, CA 90301

AB

**Accurate Automatic
Parta, Inc**
2885 S. 163rd St
New Berlin, WI 53151

AAP

**Accurate Precision
Fasteners Corp**
20 Honeck St
Englewood, NJ 07631

A

**Accurate Threaded
Fasteners, Inc**
3550 West Pratt Avenue
Lincolnwood, IL 60645



ACIMET MFG.
1710 Clarkstone Road
Cleveland, OH 44112



**Acme Rivet &
Machine Corp**
50 Emmett St
Bristol, CT 06010

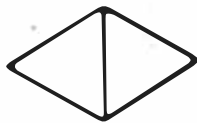

Acme Screw Company
1201 W. Union Ave
Wheaton, IL 60189

A Carbon steel

A 430 stainless steel

A 410 stainless steel

A 305 stainless steel

Adams Industries Inc
3 Bradley International
Airport
PO Box 291
Windsor Locks, CT 06096

ABE

**ADJUSTABLE
BUSHING CORP.**
11905 Vose Street
North Hollywood, CA 91605



Panel fastener



Quick-acting pins &
associated adjustable
diameter products.

**Aerospace
Manufacturing Inc**
PO Box 941
Lodi, NJ 07644

Plant
55 Contant Avenue
Lodi, NJ 07644

AM

**Aero Mechanical
Fastening Systems, Inc**
15481 West 110th Street
Lenexa, KS 66219



**Aerospace Products
Div of Apco Fasteners Inc**
123 N. Pine St
Indianapolis, IN 46202

APCO

AFI Industries, Inc
475 E. Kehoe Blvd
Carol Stream, IL 60188



**AIR INDUSTRIES
CORPORATION**
12570 Knott Street
Garden Grove, CA 92641



or
AIC

Airfasco, Inc
207 Schneider Road S.E.
North Canton, OH 44720

A F C

Ajax Bolt
11550 Hupp
Warren, MI 48089



End of point optional.



Inch parts.



Metric parts.

A. J. Fasteners, Inc
252 Kruse Ave
Monrovia, CA 91016

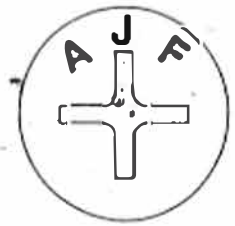

Akko Fastener, Inc
6855 Cornell Rd
Cincinnati, OH 45242



Standard
marking



Taperite
marking



Metric
marking

**Albany Fasteners/
Pawtucket Fastener Div**
327 Pine St
Pawtucket, RI 02862

**S B PMC
P A**

Allfast Fastening Systems
15200 Don Julian Rd
Industry, CA 91745

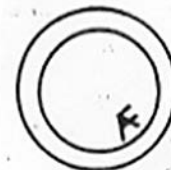

On rivet heads

Allied Tubular Rivet
294 Carlton Dr
Carol Stream, IL 60188

No standard headmark

**Alloy & Stainless
Fasteners, Inc**
11625 Charles St
Houston, TX 77041

X

Threaded full length studs; hex
nuts; hex head bolts; double end
studs; tap end studs.

ALPHA BOLT CO.
1524 East 14 Mile Road
Madison Heights, MI 48071

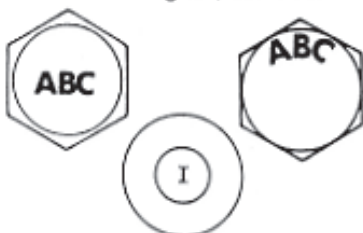

Numeral 1 shown on special bolts.

Amanda Bent Bolt Co
20 Gallagher Ave
Logan, OH 43138

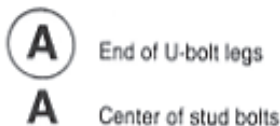

American Electric
1525 Woodson Rd
St Louis, MO 63114



American Monarch Corp
5900 Park Ave
Cleveland, OH 44105

AM

American Screw Products Co
5185 Richmond Rd
Bedford Heights, OH 44146



American Screw & Rivet
1625 Manse Jolly Rd
Anderson, SC 29621



American Socket Screw Mfg Co
495C Busse Rd
Elk Grove Village, IL 60007

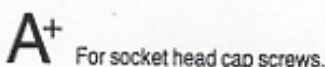

Ametek Straza Div
(Formerly California Aircraft Products)
790 Greenfield Dr
El Cajon, CA 92022



Receptacle



Stud

Z
ZAHODIAKIN

Anchor Bolt & Screw Company
2001 North Cornell Ave
Melrose Park, IL 60160



Hex cap and indented hex screws.

Machine screws and other products — 3 dots under head, 120° apart.

Anchor Fasteners, Inc
130 Huntingdon Ave
Waterbury, CT 06708



On top of bolt/screw heads and top of nut surfaces.

Asquared Industries, Inc
153 Water St
Torrington, CT 06790

A
generally for small items: twisted tooth lockwashers, plain & toothed hole spring nuts; belleville, cone & spring washers.

A²
for twisted tooth lockwashers; spring nuts; belleville, cone & spring washers.

A × A
for spring nuts; belleville, cone & spring washers.

Assembly-Line Products, Inc
Fastener Mfg Div
7630 Quincy St
Willowbrook, IL 60521



ATF, Inc
Accurate Threaded Fasteners, Inc
3550 W. Pratt Ave
Chicago, IL 60645



The Atlas Bolt & Screw Co
1628 Troy Rd
Ashland, OH 44805



Carbon steel screws.



300 series stainless steel screws.



410 series stainless steel screws

Atlas Engineering, Inc
173 Osceola Ave
Tallmadge, OH 44278



Auto Bolt & Nut Co
4619 Perkins Ave
Cleveland, OH 44103



Automatic Fastener Corp
Cosgrove Industrial Park
Branford, CT 06405



Automatic Screw Machine Products Co
PO Box 1608
Decatur, AL 35602



Avdel Corporation
50 Lackawanna Ave
Parsippany, NJ 07054



Avibank Mfg Inc
210 S Victory Blvd
PO Box 391
Burbank, CA 91503

AVK

ET Structural panel fastener

or **ETC**

AVILOK

For rivet nut marking and other special products —

84256 Manufacturers code

HI-TORQUER

Manually operated placing tool

For special part markings and rivet nut marking —

BALL•LOK Quick release pin
AVIBANK

Name of Manufacturer —
Name marked on parts

Baden Steelbar & Bolt Corp
Big Sewickley Creek Rd
R-3, Sewickley, PA 15143

B

**Barcar Division of
McHugh Screw Inc**
2365 Wyandotte Rd
Willow Grove, PA 19090



BASSICK DIVISION
960 Atlantic St.
Bridgeport, CT 06602

Bassick SW

Quick release fasteners

BBC Fasteners, Inc
4210 Shirley Lane
Alsip, IL 60658

BBC

Bead Chain Mfg Co
110 Mountain Grove St
Bridgeport, CT 06605

B

Bell Fasteners
333 Pine St
Pawtucket, RI 02862

S B PMC P A

**BF Goodrich — Aerospace
& Defense Division**
**Rivnut® Engineered
Fasteners**
250 North Cleveland-
Massillon Rd
Akron, OH 44313

BFG

Used for Rivnut®
engineered products

B&G Mfg Co Inc
(Formerly Jed Mfg Co)
3067 Unionville Pike
Hatfield, PA 19440

J

Binder Metal Products Inc
PO Box 2306
Gardena, CA 90247

B

The Blake & Johnson Co
SC Hwy #86
Beaufort, SC 29902

B or O

Blake Rivet Co
Div Liberty Fasteners Inc
5030 Firestone Blvd
South Gate, CA 90280

BB

The Bland Co
**Precision Threaded
Products Div**
55 Brook St
Elmwood, CT 06110

TN

Blue Water Plastics Co
315 S Whiting St
St Clair, MI 48079

B

B.M.C. INDUSTRIES, INC.
1879 W. Commonwealth Ave
Unit N
Fullerton, CA 92633



Boltform Products
Div GCG Ind Inc
PO Box 321
Northfield, OH 44067

BP

Bowman Distribution
Barnes Group Inc
850 E 72 St
Cleveland, OH 44103



Bowmalloy®
hex head cap screw



Bowma-Torq®/Grade 8
hex head cap screw



Bowmetric®
metric, hex head cap
screw

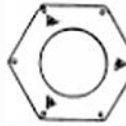

Bowma-Grip®
prevailing torque-type
locking nut

Brainard Rivet
Townsend/Textron
PO Box 30
Girard, OH 44420

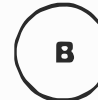

Briarwood Fasteners Inc
9701 Owensmouth Ave #8
Chatsworth, CA 91311

BFI

**Brighton-Best Socket
Screw Mfg Inc**
20 E Oakdene Ave
Teaneck, NJ 07666

B-B

1960 series socket head cap
screws; hex socket set screws;
Grade 8 capscrews

Bristol Industries
630 E. Lambert Rd
Brea, CA 92621

B+ B-PLUS

or ○ ○ (two dots side by side;
raised or depressed)

Bristol Locknut Co
32451 N. Avis
Madison Hts, MI 48071

2 slash marks
crimped on
top of locknut



2 slash marks
on flange of
locknut

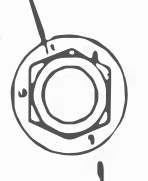

Property Class "9"

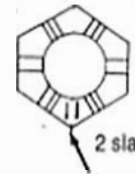

2 slash marks

Bruce Industries
1528 W 178th St
Gardena, CA 90248

**BAI
105**

**Brunner Drilling &
Manufacturing Co, Inc**
Elroy Street
Elroy, WI 53929



Buckeye Forge, Inc
5171 E 71st St
Cleveland, OH 44125



or **BUCKEYE**

Byrd Plastics, Inc
2953 W 12th St
Erie, PA 16505

TPL or BRILOX

California Screw Products
14957 Gwen Chris Ave
Paramount, CA 90723

CS For aircraft and commercial specialty externally threaded fasteners.

Camcar Division of Textron Inc

Socket Screw Products
Camcar Division of
Textron Inc
1302 Kerr Drive
Decorah, IA 52101



Drilllite Products
Camcar Division of
Textron Inc
1301 Kerr Drive
Decorah, IA 52101



Head marking



Under head marking

Raycarl Products
Camcar Division of
Textron Inc
600 Eighteenth Ave
Rockford, IL 61101



Head marking



Under head marking

Sems Products
Camcar Division of
Textron Inc
1818 Christina Street
Rockford, IL 61101



Head marking

AMSCO Products
Camcar Division of
Textron Inc
345 East Marshall Street
Wytheville, VA 24382



Head marking



Under head marking

Taptite Products
Camcar Division of
Textron Inc
826 East Madison Street
Belvidere, IL 61008

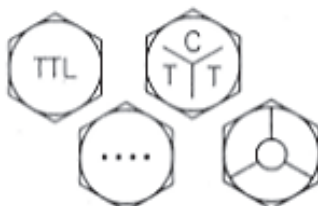

Head marking



Under head marking

Torx Products
Camcar Division of
Textron Inc
Formerly: Indiana Metal
Products Co.
PO Box 607
Rochester, IN 46975



Head marking



Nut marking Under head marking

PRODUCT TRADEMARK MARKINGS



Internal Torx®
Recess

External Torx®
Recess

Torxstem®

Cam-Tech Industries, Inc
48 Commercial St
Webster, NY 14580

No standard mark

Cardinal Fastener & Specialty Co, Inc
5185 Richmond Rd
Bedford Heights, OH 44146

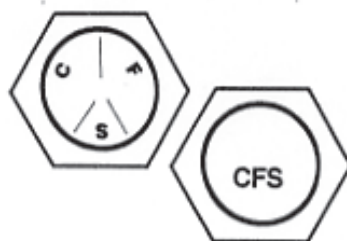

Cardinal Industrial Products Inc
3873 W. Oquendo Rd
Las Vegas, NV 89118

C for standard ASME/
ASTM bolting material
MULTI-C for ASME bolts
intended for nuclear

Carr Co
The United-Carr
Div of TRW, Inc
31 Ames St
Cambridge, MA 02142



CEM Co, Inc
PO Box 179
Danielson, CT 06239

No standard mark

Champion Rivet Div
Champion Commercial
Industries, Inc
5137 Indianapolis Blvd
East Chicago, IN 46312

V Rivets only

Chandler Products, Inc
1491 Chardon Rd
Cleveland, OH 44117

CP

Cherry Commercial Fasteners
Cherry Aerospace Fasteners
1224 E. Warner Ave
Santa Ana, CA 92707

T Cherry Commercial Fasteners mark



Cherry Aerospace Fasteners mark

Chesco Products Inc
Box 1054
Upland, PA 19015

CP USA
Hex key wrenches

Cinch-Monadnock
18301 Arenth Ave
City of Industry, CA 91749

• (a dot)

Clark Bros Bolt Co Inc
Canal St
Milldale, CT 06467

CB

Cleveland Cold Heading Corp
PO Box 38066
Cleveland, OH 44136

• (Dot) or **CC**

Coast Industrial Supply Co, Inc
15959 Pluma Ave
Cerritos, CA 90701

C

Alloy steel studs. Stainless and non-ferrous hex bolts.

Cobb and Drew, Inc
PO Box 3387
Plymouth, MA 02360

No standard mark

Cold Heading Co
4600 Bellevue
Detroit, MI 48207

H

Consolidated Metal Products, Inc
1028 Depot St
Cincinnati, OH 45204



At the end of U-bolts

Construction Fasteners, Inc
Box 6326
Wyomissing, PA 19610



Carbon steel



300 series stainless



400 series stainless

Continental/Midland, Inc
25000 S. Western Ave
Park Forest, IL 60466



Marking consists of 3 dots

Conveyor Accessories, Inc
7936 Madison St
Burr Ridge, IL 60521

CA

Cooper + Turner
A Division of
J & M Turner Inc
200 Rittenhouse Circle
East Building No. 8
Bristol, PA 19007



For load indicating washers.

Copper State Bolt & Nut Co
3637 N. 34th Ave
Phoenix, AZ 85017



Cornell Mfg Co, Inc
25 Ramland Rd
Orangeburg, NY 10962

No standard mark.

Coupling Nut Supply
PO Box 26
Sullivan, WI 53178



Crescent Manufacturing Co
700 George Washington Turnpike
Burlington, CT 06013



"V" scribed on bearing face of screws (underside of head).

Curtis Industries
34999 Curtis Blvd
Eastlake, OH 44094



Custom Bolt Mfg
3403 S. 1st Ave
Phoenix, AZ 85066



Cuyahoga Bolt & Screw Co
A Cuyam Company
5200 Harvard Ave
Cleveland, OH 44105

C

CWR Mfg Co
Div of AJ Murphy Co Inc
7000 Fly Rd
PO Box 2669
Syracuse, NY 13220

**C
WR
C**

Daniel Industries, Inc
Bolt and Gasket Div
PO Box 292
Houston, TX 77001



Studs



Hex nuts

Edward W. Daniel Co
4049 St Clair Ave
Cleveland, OH 44103



For eyebolts.

Darling Bolt Company
2941 E. 10 Mile Rd
Warren, MI 48090

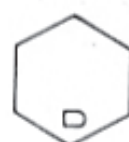
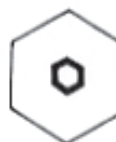

Darling Mfg Co
14600 23 Mile Rd
Mount Clemens, MI 48044



Raised or inverted hexagon which may be of different dimensions across the flats due to size of part applied to.

Dearborn Screw & Bolt Co
8947 Hubbell Ave
Detroit, MI 48228



For hex head bolts and cap screws

Decker Mfg Corp
703 N Clark St
Albion, MI 49224



or



Hex wheel nuts (depressed).



Square, hex and round weld nuts; metric weld nuts have depressed letter D on bottom.



or



ASTM A563 structural nuts (depressed).

John Deere Harvester Works — Moline
Fastener Division
501 3rd Ave
Moline, IL 61265



Delackner Fasteners Inc
One Lafayette Place
Kenilworth, NJ 07033

D or DE Studs

D or DE Nuts

Delaval Adel Fasteners Inc
1444 Washington Ave
Huntington, WV 25704

ADEL

Demby Rod & Fastener Mfg Inc
20260 First Avenue
Berea, Ohio 44017

D

Detroit Diamond Div
2200 Fourth St
Wyandotte, MI 48192



One diamond.



Three diamonds.



One dot.



Two lines on
two crimp pads.



One dash.



One dash and two dots.

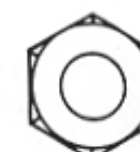

Six dashes.



Two lines.

Deutsch Fastener Corp
3969 Paramount Blvd
Lakewood, CA 90712



Deutsch has acquired and
integrated the following companies
and their respective source marks:

**Briles Mfg &
Omark Industries, Inc**



**Rockford
Aerospace**



RA

**Litton Fastening Systems
(former Dumont Aviation)**

DA

Diaco, Inc
1045 - H Shary Ct
Concord, CA 94518

DI

Driv-Lok, Inc
1140 Park Ave
Sycamore, IL 60178

No standard mark.

G B DuPont Co Inc
500 W Long Lake Rd
Troy, MI 48098

D

Duquesne Mine Supply Co
2 Cross St
Pittsburgh, PA 15209

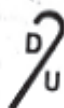

Jos Dyson & Sons Inc
53 Freedom Rd
Painesville, OH 44077

D D-Loc
or
M-Loc

Dzus Fastener Co Inc
425 Union Blvd
West Islip, NY 11795

DZUS

E&E Fastener Co, Inc
300/400 Industrial Dr
Plymouth, MI 48170

E or E₂

East Coast Metals, Inc
171 Ruth Rd
Harleysville, PA 19438

E

Eastern Screw Co, Inc
71 Mill St
Johnston, RI 02919

E

Elastic Stop Nut
2330 Vauxhall Rd
Union, NJ 07083

E, EN or ESNA

Red nylon insert identifies
Esna as manufacturer per
ANSI/ASME B18.16.1M



(2) Equally spaced
stakes identify
Property Class 5
per ANSI/ASME
B18.16.1M



(3) Equally spaced
stakes identify
Property Class 9
per ANSI/ASME
B18.16.1M



(4) Equally spaced
stakes identify
Property Class 10
per ANSI/ASME
B18.16.1M



Red nylon insert identifies
Esna as manufacturer.



Identification notch
identifies Grade C.



(6) Equally spaced
stakes identify
Grade B.

Elco Industries, Inc
1111 Samuelson Road
PO Box 7009
Rockford, IL 61125

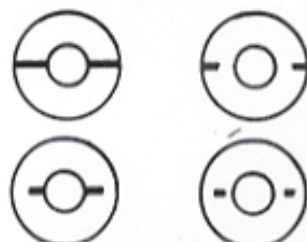

Underside of screw head



Top of head

Note: metric products are either
blue coated or identified by
property class number.

**Emhart Fastener Group
Parker-Kalon Div**
1 Roberts Rd
PO Box L
Campbellsville, KY 42718

Noncountersunk heads



12 impressed
deltas under
head

or



Impressed delta
on head

Countersunk head

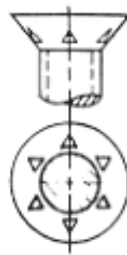

6 impressed deltas on countersunk

Hexagon head

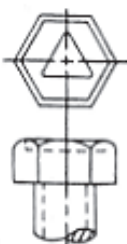

Raised delta in indent

Identification of material for hex and hex washer heads



Carbon steel



410 corrosion-resistant steel



300 series (18-8) stainless steel

Erie Bolt Corp
1325 Liberty St
Erie, PA 16502

E or **ERIE**

Everlock Chicago Division Industrial Fastening Systems Group
Microdot Inc
1640 West Hubbard Street
Chicago, IL 60622

EL

Everlock Detroit
6567 S. Sterling Dr
Sterling Hts, MI 48077

One line in two pads



Prevailing Torque Nut (top of nut)

Capped Wheel Nut



Nut & Washer Assy.
(top of nut)

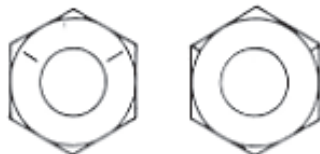

Two Radial Lines
120° apart

Faber Enterprises, Inc
2316 Lincoln Blvd
Santa Monica, CA 90405



FabriSteel Products Inc
22900 W Eight Mile Rd
Southfield, MI 48034



Head mark is rolled on stock from which pierce nuts are produced. Pattern can be random repeat.

Fabsco Corp
1745 W 124th St
Calumet Park, IL 60643



Falcon Forge Inc
PO Box 7173
Shreveport, LA 71107



Fall River Mfg Co, Inc
1075 Airport Rd
Fall River, MA 02722

fr or **f**

Fas-Mac Inc
5150 S 100 E Ave
Tulsa, OK 74146



Fastech Inc
550 Pineaire Dr
N. Bayshore, NY 11706

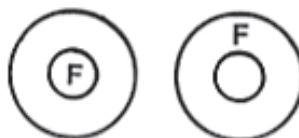

Top of head Under head

Fastener Industries, Inc
33 First Ave
Berea, OH 44017

THE OHIO NUT & BOLT COMPANY
Division of
Fastener Industries, Inc.

Small raised mark usually on underside of head.

MODERN FASTENERS CO.
Division of
Fastener Industries, Inc

Small raised mark usually on underside of head.

Fastener Manufacturing Co
1320 Kress
Houston, TX 77020

F

or



Fastener Systems Inc
25801 Richmond Rd
Cleveland, OH 44146

FX

Fastening Products Co, Inc
Price & Pine Sts
Holmes, PA 19043

FPC

Fastening Products of Lancaster, Inc
933 E. Orange St
Lancaster, PA 17602

No standard mark.

Fastron Company
11800 Franklin Ave
Franklin Park, IL 60131

Head marking only per customer request.

Fastron Corporation
5869 Enterprise Parkway
Fort Myers, FL 33905

On top of fastener head
Underside of head

Federal Screw Works
2400 Buhl Bldg
Detroit, MI 48226



For hex head fasteners (inch and metric)



CONNECTING ROD BOLTS



BALL STUDS
(THREADED END SHOWN)

PREVAILING TORQUE NUTS

HEX NUTS
(INCH)



(GRADE 5) (GRADE 8)

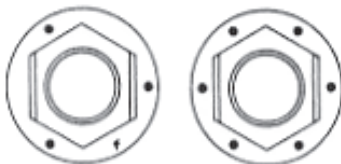

FLANGE NUTS
(INCH)

2 SIDE
CRIMP



HEX NUTS (METRIC)
(CLASS 9)



(OPTIONAL)

(CLASS 10)



(OPTIONAL)

FLANGE NUTS (METRIC)

(CLASS 9)

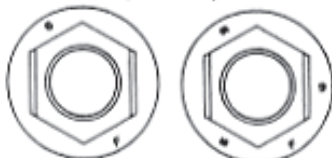

(OPTIONAL)

(CLASS 10)

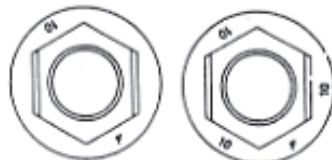

(OPTIONAL)

TOP LOCK
2 SIDES



PERMA-TORQUE

COLLAR HEX NUTS

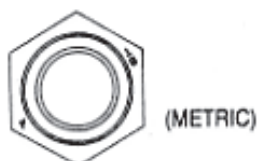

(METRIC)



(OPTIONAL)



(INCH)

Ferry Brothers, Inc
15300 Industrial Parkway
Cleveland, OH 44135

FB or **fb**

For cap screws and
carriage bolts

The Ferry Cap &
Set Screw Co
2151 Scranton Rd
Cleveland, OH 44113

FC

Fischer Special Mfg Co
111 Industrial Rd
Cold Spring, KY 41076



Flexalloy Inc
26000 Richmond Rd
Cleveland, OH 44146

FX Round, hex and hex
flanged head products
plus nuts

F Wheel nuts

Foremost Threaded
Products
19835 E. Walnut Dr
City of Industry, CA 91748



Formed Fastener Mfg, Inc
7247 S. 78th Ave
Bridgeview, IL 60455



Franklin Fastener Co
12701 Beech Daly
Redford, MI 48239

FF

The Freeman Co
8th & Walnut Sts
Yankton, SD 57078

F

Gaffney Bolt Co
Rockford, IL



(When requested)

Gardenbolt Industries, Inc
901 Stewart Ave
Garden City, NY 11530

GBI

Gardiner Manufacturing Co
2711 Union Street
Oakland, CA 94607

G or **GARCO**

Gateway Screw & Rivet Inc
1440 N. Keating Ave
Chicago, IL 60651

G

George K Garrett Co
Div MSL Industries, Inc
8801 Torresdale Ave
Philadelphia, PA 19136



Gesipa Fasteners USA Inc
610 Plum St
Trenton, NJ 08638

No standard mark.

The G.E.W. Co, Inc
180 North Main St
Branford, CT 06405

All fasteners are headless,
having no identification marks.

Giant Bolt & Fastener Div
8817 Lyndon
Detroit, MI 48238



Girard Fastener Co
525 W 169th St
South Holland, IL 60473



Hex and hex washer
head fasteners.

GMR Enterprises Ltd
1600 55th St NE
Canton, OH 44721

Company does not manufacture
products utilizing trade names or
logo markings.

Grant Ind Inc
33415 Groesbeck Hwy
Fraser, MI 48026

GI

Great Lakes Screw
13631 South Halsted St
Chicago, IL 60627

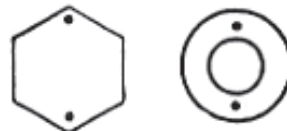

Trimmed hex
head — two
raised dots on
top of head.

Other head
styles — two
raised dots
under head.



Indented hex head

Optional ind hex head — two rings & two dots in indentation.

**Greer-Smyrna Inc
A Microdot Co**
PO Box 68
Smyrna, TN 37167

Green nylon insert identifies Greer-Smyrna as manufacturer of locknuts.

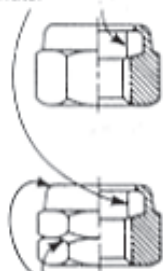

(6) equally spaced stakes plus notch in corner of hex identifies Grade C — inch.

(6) equally spaced stakes identifies Grade B — inch.



Green nylon insert identifies Greer-Smyrna as manufacturer of locknuts per ANSI/ASME.



PROPERTY CLASS 5, 9 AND 10 MARKINGS PER ANSI/ASME B18.16.1M LOCATED ON BEARING SURFACE AND/OR HEX FLATS.



Nylon insert



Grade markings per IFI Standard 100 (one or two small notches cut circumferentially into each of the six corners at about mid-height)

Conelok inch locknuts

The letter "G" identifies Greer-Smyrna as manufacturer



Conelok metric locknuts — Bearing surface

**Emhart
Fastening Systems Group
Gripco Fastener Division**
111 E. Broad Street
South Whitley, IN 46787

GRIPCO



Twin Delta Crownlock Grade B inch locknut



Gripco Crownlock Grade C inch locknut



Twin Delta Crownlock Class 9 metric locknut



Gripco Crownlock Class 10 metric locknut

Gripnall Corporation
280 Franklin St
Bristol, RI 02809



Groov-Pin Corp
1125 Hendricks Causeway
Ridgefield, NJ 07657

No standard mark.

G-Square Supply Corp
226 Beach 101st St
PO Box 245
Rockaway Park, NY 11694



G.T. Special Products, Inc
2175 West Maple Rd
Walled Lake, MI 48088

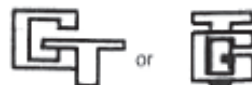

**Guardian Rivet and
Fastener**
70 Air Park Dr
Ronkonkoma, NY 11779



Haskell of Huntington Inc
300 Third Ave
Huntington, WV 25706

H

H. K. Metalcraft Mfg Corp
35 Industrial Rd
Lodi, NJ 07644

Produced washers are unmarked.

**Hardware & Metal
Specialties Inc**
550 E. 19th St
Tucson, AZ 85701

HMS

Hardware Specialty Co Inc
48-75 36th St
Long Island City, NY 11101

HS

The Harrison Bolt & Nut Co
2781 Wilkens Ave
Baltimore, MD 21223

HB

John Hassall Inc
PO Box 698
Cantiague Rd
Westbury, NY 11590

H

MNP CORPORATION
44225 UTICA RD.
P.O. BOX 189002
UTICA, MI. 48318-9002

MNP FASTENER DIVISIONS



MNP

HIGHLAND BOLTS & NUT DIVISION



HBN H



Haydon Bolts Inc
Adams Ave & Unity St
Philadelphia, PA 19124



Heli-Coil Products
Div of Mite Corp
Shelter Rock Lane
Danbury, CT 06810

SCREW-LOCK

Wire inserts colored with a red dye

Hewes Industrial Supply, Inc
159 La Grange Ave
Rochester, NY 14613

HIS

Heyman Mfg Co
PO Box 160
Kenilworth, NJ 07033

HEYCO



Highland Mfg Co
1240 Wolcott St
Waterbury, CT 06722

H

Hill Fastener Corp
McNeil Rd
Rock Falls, IL 61071

H

Hi-Shear Corp
2600 Skypark Dr
Torrance, CA 90509

hs

For bolts, threaded pins, rivets etc. for aerospace, automotive and other markets.



hs HS

Metric products are identified with an "M" in the part number and on the part.

Holo-Krome Company
Brook St
West Hartford, CT 06110



On some socket screw products



Present Holo-Krome identification design for 1960 Series socket head cap screws



New Holo-Krome identification design for 1960 Series socket head cap screws

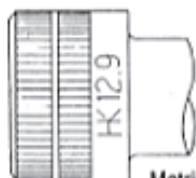

Metric socket head cap screws

Huck Manufacturing Company
8001 Imperial Dr
Waco, TX 76714



Inch and metric product

Hydro Fitting Mfg Corp
2446 Seaman
PO Box 3036
El Monte, CA 91733

HF

Hygrade Fastener Corp
115 Green St
Worcester, MA 01604



I.B.A. Company
15708 Brookpark Rd
Cleveland, OH 44135

IBA

Ideal Fasteners, Inc
1270 No. Red Gum St
Anaheim, CA 92806

IF

Industrial & Automotive Fasteners
3200 West 14 Mile Rd
Royal Oak, MI 48073



Metric Conelok nut.



Metric capped wheel nut.



Metric flange hex nut.



Inch Conelok nut.

Industrial Fastening Systems Group
Microdot Inc
431 Stephenson Hwy
Troy, MI 48083

Detroit Diamond Division
2200 Fourth St
Wyandotte, MI 48192



One Diamond

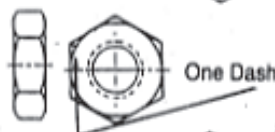

One Dash



Three Diamonds

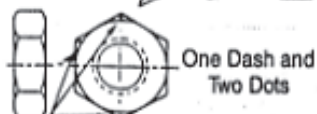

One Dash and Two Dots



One Dot



Six Dashes



Two Lines on two crimp pads



Two Lines

Everlock Chicago Division
1640 West Hubbard
Chicago, IL 60622

EL

Everlock Detroit Division
6567 South Sterling Drive
Sterling Heights, MI 48077

Microlok



Hi-Hex Microlok



Prevailing torque surface

One line in two pads plus appropriate grade or property class symbols on both inch and metric microlok nuts.

Flange Hi Hex Microlok



Prevailing torque surface

One line in two pads plus appropriate grade or property class symbols on both inch and metric microlok nuts.

Flange Toplock



Two radial lines 120° apart or the letter "E" on flange or top of nut plus appropriate grade or property class symbol.

Flange nut



Two radial lines 120° apart or the letter "E" on flange or top of nut plus appropriate grade or property class symbol.

Nut & washer assembly



Two radial lines 120° apart on chamfer surface or the letter "E" on top of nut plus appropriate grade or property class symbol.

Standard hex nut



Two radial lines 120° apart on chamfer surface or the letter "E" on top of nut plus appropriate grade or property class symbol.

Greer-Smyrna Division
Mayfield Drive
PO Box 68
Smyrna, TN 37167

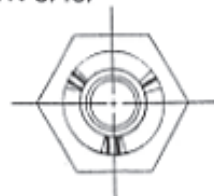

Manufacturer's I.D. — Two ribs in two depressions and one rib in one depression.

Letter "G" bar marked onto hex flats or indented into the bearing surface.



Manufacturer's I.D. — green nylon.

Denotes green

International Screw Division

50631 East Russell
Schmidt Blvd
Mt Clemens, MI 48045



Upper case Lower case

Industrial Nut Corp
1425 Tiffin Ave
Sandusky, OH 44870



Blue nylon insert identifies INC as manufacturer.



(6) Equally spaced stakes plus notch in corner of hex identifies Grade C.

(6) Equally spaced stakes identifies Grade B.



Inch nylon insert locknuts

Blue nylon insert identifies INC as manufacturer per ANSI/ASME B18.16.1M.



(2) Equally spaced stakes identifies property Class 5 per ANSI/ASME B18.16.1M.



(3) Equally spaced stakes identifies property Class 9 per ANSI/ASME B18.16.1M.



(4) Equally spaced stakes identifies property Class 10 per ANSI/ASME B18.16.1M.



Metric nylon insert locknuts

Innovative Products Inc
5000 Van Epps Road
Cleveland, OH 44131

INN

Interlock
CFH Acquisition Co Inc
2210 N. Tryon Street
Charlotte, NC 28206

SB or I

Standard bolts

SB and WP

ASTM - A325 Type 1,
Type 3 structural bolts

I and WP

ASTM - A325 Type 1,
Type 3 structural bolts

I

Loom bolts

I
Rail fasteners

P or I

A325, A194, A563
structural nuts

ITT Holub Industries
413 Elm St
Sycamore, IL 60178



ITW Buildex
1349 West Bryn Mawr Ave
Itasca, IL 60143

**B
X**

ITW Fastex
195 Algonquin Rd
Des Plaines, IL 60016



I / USA Mfg Corp
209 Redneck Ave
Little Ferry, NJ 07643

No standard marking.

IVACO Fastener Group
700 Ouellette
Marieville, Quebec,
Canada JOL 1JO

Infasco
700 Ouellette Street
Marieville, Quebec
Canada JOL 1JO



Cold forged standard bolts;
cold and hot made nuts.

Federal Bolt & Nut



Standard and special bolts and nuts.

Infasco Nut Company
7283 Torbram Road
Mississauga, Ontario
Canada L4T 1G8



Standard and special nuts

Ingersoll Fasteners
390 Thomas Street
Ingersoll, Ontario
Canada N5C 3K1



Fasteners over 1/2" diameter



Fasteners 1/2" and smaller

Jacobson Mfg Co Inc
1 Mark Rd
Kenilworth, NJ 07033



Inch markings

Grade B

Grade C

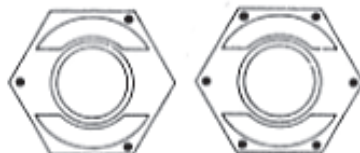

Autoloc locknuts

Metric markings

Class 5



Class 9



Class 10



Autoloc locknuts



Alternate shape of indent for Autolock locknuts.

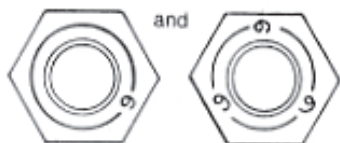

Metric markings: the partial ring is the manufacturer identification and the numeral (5, 9 or 10) is the metric property class identification.



Combination Grade 5 and manufacturer identification.



Hex flange nut.

Jay Bee Machine Works, Inc
120 South Keswick Ave
Glenside, PA 19038

B

J. S. Screw Mfg Company
Div of J. Schwartzman
Mfg & Supply
7040 Laurel Canyon Blvd
North Hollywood, CA 91605



Jupiter Washers, Inc
10-01 37th Avenue
Long Island City, NY 11101

J

Kar Products
461 North Third Ave
Des Plaines, IL 60016



For hex head cap screws. Matching grade level nuts and alloy washers.



Kaynar Mfg Co Inc
800 S State College Blvd
Fullerton, CA 92634

K or **K**

Keeler Brass Co
PO Box 821
Kentwood, MI 49508



For metric hex washer head screws only.

Keen Mfg
2500 S. Gully
Dearborn Hts, MI 48125

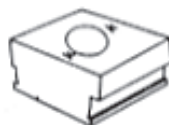

Keen Screw Products, Inc
605 Bonnie Lane
Elk Grove Village, IL 60007

K

Kenaloy Products Inc
a subsidiary of
Masco Corp
15500 Cornet Ave
Santa Fe Springs, CA 90670

K

On aerospace fasteners and some socket screw products

Kerr Lakeside Inc
26841 Tungsten Rd
Euclid, OH 44132



Keystone Threaded Products
7621 Old Rockside Rd
Independence, OH 44131



Kilbourn Engineering Co, Inc
9226 W. Flagg Ave
Milwaukee, WI 53225

K For all products

Klincher Locknut Corp
2153 Hillside Ave
Indianapolis, IN 46218

K-L For all locknuts.

Laminadora Mexicana de Metales, S.A.
Lago Zurich 168
Col. Ampliacion Granada
11520 Mexico, D. F.

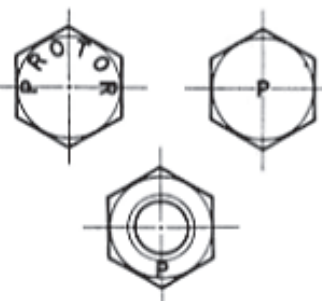

Lake Erie Screw Corporation
13001 Athens Ave
Cleveland, OH 44107

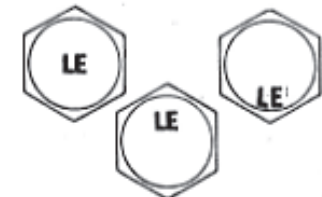

Lamson & Sessions of Canada Ltd
5190 Bradco Blvd
Mississauga, Ontario,
Canada L4W 1G7

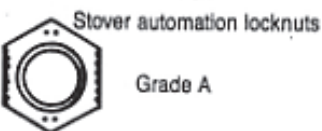

Grade B



Grade C



Metric

Stover flange locknuts



Grade F



Grade G



Metric

Lancaster Threaded Products
Box 3004
Lancaster, PA 17604

L On the ends of studs at customer request.

Lang Fastener Corp
15289 12 Mile Rd
Roseville, MI 48066

L

Lawrence Engineering & Supply, Inc.
500 S. Flower St
Burbank, CA 91503

LE

Lawson Products Inc
1666 E Touhy Ave
Des Plaines, IL 60018
BOLT MATCHING NUT



TRU-TORQ



SUPER-SIX



METRI-TORQ



Lewis Bolt & Nut Company
504 Malcolm Ave S.E.
Minneapolis, MN 55414

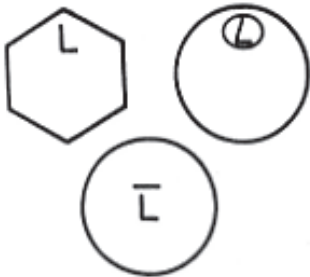

Lewis Screw Company
4300 South Racine Ave
Chicago, IL 60609

No standard headmarking.

LFC Industries Inc
1221 Corporate Drive West
Arlington, TX 76006

LFC for AN, MS, NAS
& NA fasteners

Liebig Int'l, Inc
1545 Avon St Extd
Charlottesville, VA 22901



On the side of bolts and anchors.

H L P on bolt heads.

Lister Bolt & Chain Ltd
1771 Savage Road
Richmond, B. C., V6V 1R1



Lock Thread Corp
690 E Maple Rd
Birmingham, MI 48001

LT or **CF**

**Lone Star Screw Co of
Houston Inc**
24131 Hardy Rd
Spring, TX 77383



Long-Lok Fasteners Corp
10630 Chester Rd
Cincinnati, OH 45215

LL or **LONG
LOK**

MacLean-Fogg Company
1000 Allanson Rd
Mundelein, IL 60060

Flange nuts less lock and
with Uni-Torque® lock.

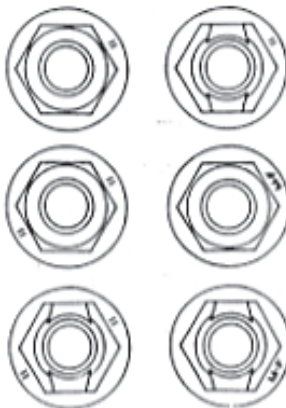

Hex and Flange screws/bolts

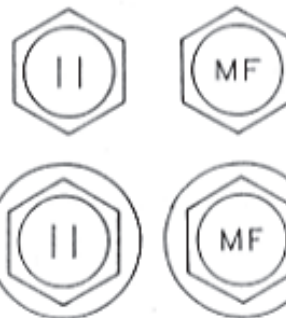

Hex nuts and Uni-Torque® locknuts

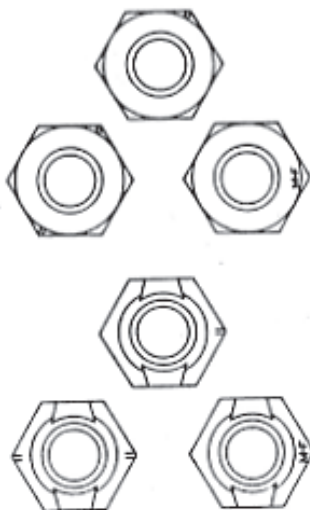

Marathon Fasteners, Inc
777 Sugar Lane
Elyria, OH 44036

No Standard Headmarking.

Mar-Bro Fasteners, Inc
5129 W. Latham
Phoenix, AZ 85043

No standard head mark.

**Marson Fastener Corp
Subsidiary of
Swingline Inc**
130 Crescent Ave
Chelsea, MA 02150

No standard mark.

**Maryland Bolt &
Nut Co Inc**
1340 Smith Ave
Baltimore, MD 21209



**Maynard Mfg Div —
Sealed Power Corp**
50855 E. Russell Schmidt
Mt. Clemens, MI 48045



Marking for
studs, pins,
non-headed
products.

Marking for
bolts, screws
and other
headed products
(raised or
indented)

McAtee Bolt Co Inc
4373 Jason St
Denver, CO 80211

MTB

McLane Company
7110 E. Rosecrans
Paramount, CA 90723

No standard head marking.

Mechanical Plastics Corp
Castleton Street
PO Box 328
Pleasantville, NY 10570

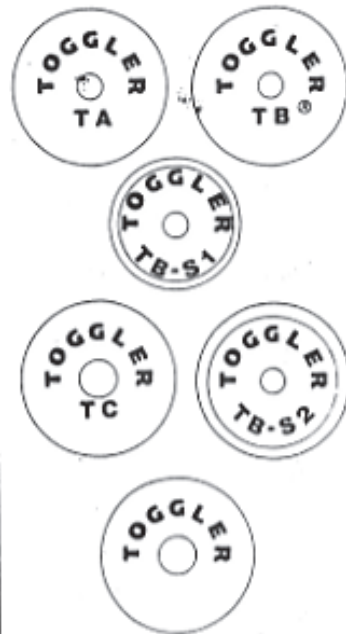

Medalist Champion Screw
1814 N. 15th Avenue
Melrose Park, IL 60160



Used on hex and
hex washer
head parts.

**Mellowes Company
Div Charter Mfg Co, Inc**
3704 N. Palmer Street
Milwaukee, WI 53212

No standard headmarking.

**Mercury Aerospace
Fasteners**
11800 Sherman Way
North Hollywood, CA 91609



M - MERCURY

↪ - AEROSPACE

**Metalcrafters Div of
Keystone Consolidated
Ind Inc**
4500 Kishwaukee St
Rockford, IL 61125

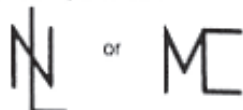

Indented hex & hex washer heads

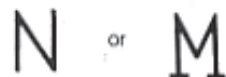

Hex cap screws - low carbon steel

Misc. markings for screws & bolts



Michigan Rivet Corp
13201 Stephens Rd
Warren, MI 48089



**Microdot Aerospace
Fastening Systems**
PO Box 3001
Fullerton, CA 92634-3001



K symbol used on sheet metal or stamped products.



Stylized K symbol used on forged or foreign products.



Two parallel lines used on Spirallock® products only. (Spirallock® products have a patented thread form).



Special K symbol marking used on metric products.

K

K symbol used on miscellaneous and general Kaynar products.

Any of the preceding markings will appear on fasteners of 3/16" nominal thread diameter or larger. For metric parts, 5mm nominal thread diameter or larger.

**Microdot, Inc
Microdot Industrial
Fastening Systems Group
Everlock Detroit**
431 Stephenson Highway
Troy, MI 48083



Micro Plastics, Inc
Highway 178 N
Flippin, AR 72634

MP

**Mid America Aerospace
Div of MAA**
16201 West 110th St
Lenexa, KS 66219



**Mid-Continent Screw
Products Company**
3701 West Lunt Avenue
Lincolnwood, IL 60645



**Mid-States Screw
Corporation**
1817 18th Avenue
Rockford, IL 61108

MAX

Mid-West Fabricating Co
313 N Johns St
Amanda, OH 43102

MW

Midwest Fastener Corp
665 W. Armory Dr
S. Holland, IL 60473



**Miniature Nut &
Screw Corp**
436 Hartford Ave
Newington, CT 06111



Missouri Alloy Stud Inc
2511 North Ninth St
St Louis, MO 63102



MNP Corporation
44225 Utica Rd
Utica, MI 48087

MNP FASTENERS



HIGHLAND BOLT & NUT



SMALL SCREW



VIKING FASTENERS



Modform, Inc
800 - 13th Street
East Moline, IL 61244

MI

**Monogram Aerospace
Fasteners**
3423 South Garfield Ave
Los Angeles, CA 90040

N

MI

MONOGRAM AEROSPACE

WEDGELOCK

Permanent and temporary fasteners, both blind and non-blind for metallic and composite structures.

MSL Stamping
Connell St & Moen Ave
Joliet, IL 60436

M Structural washers

National Fasteners Inc
7192 Patterson Dr
Garden Grove, CA 92641

N

National Molding Corp
5 Dubon Court
Farmingdale, NY 11735



National Rivet & Mfg Co
21 E. Jefferson St
Waupun, WI 53963

No standard mark.

**Nelson Stud Welding Div
TRW Assemblies &
Fasteners Group**
E 28th and Toledo Ave
Lorain, OH 44055



Raised letter on a depressed pad for stud welded fasteners.

New England Bolt Corp
9 Charlton St
Everett, MA 02149

N.E.B.

N.J. Rivet Co
1785 Haddon Ave
Camden, NJ 08103

No standard mark.

Non-Ferrous Bolt & Mfg Co
4085 Nevso Dr Suite C
Las Vegas, NV 89103

NF

Northwest Bolt & Nut Co
4250 Eighth Ave NW
Seattle, WA 98107

Y

Nova Machine Products Corporation
PO Box 30287
Middleburg Hts, OH 44130

N

Nucor Fastener
PO Box 6100, CR 60
St Joe, IN 46785

n

Standard fastener products

Nuts Incorporated
Route 724 & 23
Phoenixville, PA 19460

N

Nylok Aerospace
1161 E. Sandhill Ave, #D
Carson, CA 90746

NK

Nylok Fastener Corporation
800 W University — Suite E
Rochester, MI 48063

NK

Nylosa Industries, Inc
6949 N. Hamlin
Chicago, IL 60645

Orange color nylon collar-insert identifies Nylosa as locknut manufacturer.

Ohio Nut & Bolt Co Division of Fastener Industries, Inc
33 First Avenue
Berea, OH 44017

 Small raised mark usually on underside of head.

Olympic Fastening Systems, Inc
11445 Dolan Ave
Downey, CA 90241

 (indented circle)

Omark Industries Precision Fastening Subsidiary
1415 E Grand Ave
El Segundo, CA 90245

OM

Opus Ferrum
465 Signet Dr
Weston, Ontario, Canada M9L 1V5

OF

PAC Fasteners
21200 Telegraph Rd
Southfield, MI 48086

PAC

PAC

The Palnut Co A United-Carr Div of TRW Inc
Glen Rd
Mountainside, NJ 07092

PAL

Parker Brass
300 Parker Dr
Otsego, MI 49078

P Forgings.

b Extruded bodies & nuts.

PH Air brake nuts.

Parker-Kalon
395 Roberts Rd
Campbellsville, KY 42718

Tapping screws

Non Countersunk Heads Countersunk Heads



12 Impressed Triangles

6 Impressed Triangles

Hexagon Heads

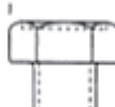

Slotted drive Cross recessed drive



 Hardened masonry nails.

Patterson Industries Inc Acimet Div
PO Box 1069
East Liverpool, OH 43920

AAW A ACIMET

Patterson Lake Products
PO Box 200
Pinckney, MI 48169

PLP

H. Paulin & Co Ltd
55 Milne Ave
Scarborough, Ontario, Canada M1L 4N3

P

PB Fasteners
1700 W 132nd St
Gardena, CA 90249

PBF This identification precedes part number.

Pearson Fastener Corporation
1400 Samuelson Rd
Rockford, IL 61109

PF

Peerless Industries
2800 Tyler Rd
Ypsilanti, MI 48197



Tube nuts

P

All other

Penn Engineering & Mfg Corp
5190 Old Easton Rd
Danboro, PA 18916



A dimpled recess in the end of self-clinching studs and pins.

PEM Inch product

PEM-m

Metric product



Double squares are a registered trademark for self-clinching floating fasteners



Blue-nylon® hexagonal locking element.

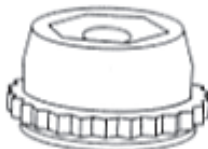

Penn Jacobson Co
4601 Cortland Ave
Altoona, PA 16601

J

Pennsylvania Industrial Fasteners
N. Gliffa Dr
Donora, PA 15033



Pheoll Mfg Co Inc
5700 W Roosevelt Rd
Chicago, IL 60650



One raised dot on underside or top of head.



Raised P

Phoenix Specialty Manufacturing Co, Inc
PO Box 418
Bamberg, SC 29003

Plant
Highway 301 South
Bamberg, SC 29003



Pilgrim Screw Corp
120 Sprague St
Providence, RI 02901



Pioneer Screw & Nut Co
2700 York Road
Elk Grove Village, IL 60007



Indented hex heads and indented hex washer heads use stylized P on top of head.



All other head styles have slash-dot symbol appearing on bearing surface upon request.

Plainville Mfg Co Inc
48 Lewis St
Plainville, CT 06062



Portland Bolt & Mfg Co
1210 N.W. Johnson
Portland, OR 97208

PB

Precision Form, Inc
(Purchased Alcoa's Precision Products Div in May 1986)
PO Box 5407
Lancaster, PA 17601

No standard mark.

Precision Metal Products of Malden Inc
41 Elm St
Stoneham, MA 02180

PMP

Premier Industrial Corp
4415 Euclid Ave
Cleveland, OH 44103



For inch fasteners



For metric fasteners

Prestige Stamping, Inc
23513 Groesbeck Hwy
Warren, MI 48089



Pro Fast Mfg Corp
195th & School House Rd
Mokena, IL 60448

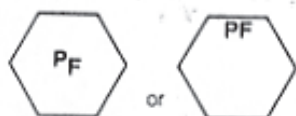

Cap screws & structural bolts

Quality Screw Products, Inc
35101 Schoolcraft Rd
Livonia, MI 48151

Q (formerly QS)

Quality Socket Screw Mfg Corp
Route 30, PO Box 437
Hampstead, MD 21074

QSS

Radax Industries, Inc
700 Basket Rd
Webster, NY 14580

No standard headmarking.

Rassini International, Inc
617 E. Huron St
Ann Arbor, MI 48104

Plant address:

Tornillas Rassini, S.A. de C.V.
Av Electricidad Y E. Pugibet
Cd Industrial Xalostoc
Sta. Clara, Edo. de Mexico
Apartado Postal 14-711
Mexico D.F.

RR

For hex cap screws, hex bolts, hex nuts, heavy hex structural bolts, heavy hex nuts, shackle bolts, hex cone nuts and wheel bolts.

RB&W Corp
5970 Heisley Rd
Mentor, OH 44060

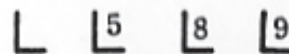
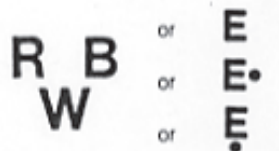

XP exposure protected
ASTM A325 Type 3
bolts and nuts.

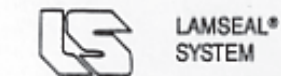



VIBRESIST® prevailing torque locking screws

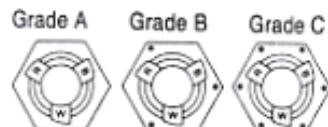

VIBRESIST® hex locknut



VIBRESIST® hex locknut



SAE J995 Grade 5 hex nuts



SAE J995 Grade 8 hex nuts

OVALOK® TRI-OVAL™ prevailing torque locknuts

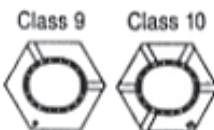
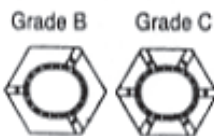

Stover® prevailing torque locknuts

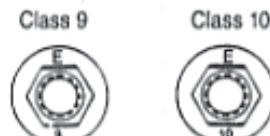
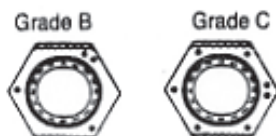
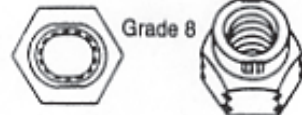
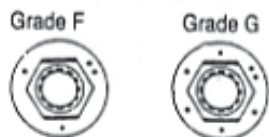

REC Corporation
10 Beach St
Mt Vernon, NY 10550

R

Republic Fastener Mfg Corp
1300 Rancho Conejo Blvd
Newbury Park, CA 91320

R

Rexnord - Specialty
Fastener Division
East Coast Operations
601 Rt 46 West
Hasbrouck Heights, NJ 07604



Rexnord/Tridair
3000 W. Lomita Blvd
Torrance, CA 90505

Rexnord

DELRON

Tridair



Ring Screw Works
31550 Stephenson Highway
Madison Heights, MI 48071



Ring Screw
Division



Ferndale
Fastener Division



Fenton
Heading Division



Semco Fastener
Division



Titan Fastener Division

Riteloc Co Division of
Solos Fasteners Inc
260 W. Sunrise Hwy
Freeport, NY 11520

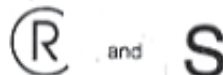

Robbins Mfg Co, Inc
1200 Airport Road
PO Box 704
Fall River, MA 02722



Robertson Whitehouse
Member of the
Marmon Group
97 Bronte St
Milton, Ontario,
Canada L9T 2N8

No standard head marking.

Rockford Bolt & Steel Co
126 Mill St
Rockford, IL 61101

RBS and R

Rockford Fastener Inc
725 South St
Rockford, IL 61105

No standard headmarking.

Rockford Headed
Products
4814 American Rd
Rockford, IL 61109

HP

Rockford Products Corp
707 Harrison Ave
Rockford, IL 61108

RP

ROCKFORD



R

R



Hex Nut
Grade 5



Hex Nut
Grade 8

Rock River Fastener Corp
3035 Eastrock Dr
Rockford, IL 61125

RRF

RONSON
Manufacturing Inc
9933 Chillicothe Rd
Kirtland, OH 44094

R

For nuclear and military type
washers, studs, hex bolts and nuts.

Rosan Inc
2901 W Coast Highway
Newport Beach, CA 92663

HP On headed products

R&R Engineering Co
107 S. Main St
Summitville, IN 46070

No standard mark on
U-bolts and studs.

Safety Socket Screw Corporation

6501 N. Avondale Ave
Chicago, IL 60631



Diagonal knurl design® around the periphery of socket head cap screws.

Scovill Apparel Fasteners Inc

76 Westbury Park Rd
Watertown, CT 06795



Socket shell.

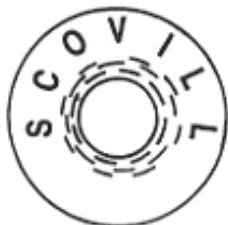

Posts

Screwcorp Div VSI Corp
13001 E Temple Ave
City of Industry, CA 91746



Indented circle on all fasteners, except machine screws.

Seastrom Mfg Co, Inc
701 Sonora Ave
Glendale, CA 91201

SEA or S

George H. Seltzer & Co
103-5 Ridley Ave
Folsom, PA 19033

ZIP

Trademark is forged onto "T" slot bolts.

Semplex Corporation
199 West Diversey
Elmhurst, IL 60126



Setko Fasteners, Inc
26 Main St
Bartlett, IL 60103

No standard mark for screw machined set screws.

Simon Industries Ltd
20 Sheffield St
Toronto, Ontario,
Canada M6M 3E6

SIL or SIL

Shakeproof Div Illinois Tool Works Inc
St Charles Rd
Elgin, IL 60120

S S. S..

for hex head sems, machine screws, tapping screws and drill screws.

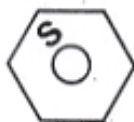

Hex nuts.

Sheffield Inc
1025 Winchester Ave
Kansas City, MO 64126



Shur-Lok Corp
2541 White Rd
Irvine, CA 92714



Southern Bolt & Fastener Corp
301 Montgomery
Shreveport, LA 71107

S

Southern Fastener Corporation
1641 Conception Street Rd
Mobile, AL 36601

SF

Southern Fastening Systems
1211 Barkley Rd
Statesville, NC 28677



2 notches for slotted heads only.

Spar Group
PO Box 1808
Swift Current, SK, Canada

No standard mark.

Special Screw Company
14325 E. Nine Mile Rd
Warren, MI 48089

S All headed products.

Specialties Unlimited
33220 Lakeland Blvd
Eastlake, OH 44094

S

Special-T-Metals
14740 West 101st Terrace
Lenexa, KS 66215

**STM
ACI**

Specialty Bolt & Screw Mfg Inc
3052 East 80th St
Cleveland, OH 44104

SBS

Spirol International Corporation
Route 12
Danielson, CT 06239

No standard head marking.

SPS Technologies
Route 332
Newtown, PA 18940

The following characters (used alone or in combination with other digits/letters which designate material, size, strength grade or part number) indicate SPS as manufacturing source:

C	K	U
CCS	K-5673	U130
EWB	KS	UNBRAKO
EWN	S	UNW
FNF	SPS	56878
HI PSI	TJB	71838
HI TI	TM9	80539

For "inch" socket head cap screws



Straight knurls with an unknurled band adjacent to the bearing surface on socket heads. The diameter over the straight knurl does not exceed the band. There may be 2 or 3 grooves near the band or a diamond knurl band at top of head.



A raised or depressed triangle pointing from the wrenching flat toward thread on nut products.

Stafast Products, Inc
505 Lake Shore Blvd
Painesville, OH 44077

ST Stamped on spring steel clips.

Stafford Mfg Corp
PO Box 2370
Woburn, MA 01888

No standard mark.

Stalcorp Cold Forming
127 South Pearl
Thorntown, IN 46071

S On bolt head or end of stud.

Standard Nut & Bolt Co
49 Abbott St
Cumberland, RI 02864

S

Standco Industries, Inc
2701 Clinton Dr
Houston, TX 77020

SC or S

Stanley Hardware
367 Victoria St
New Hamburg, Ontario,
Canada N0B 2G0

No standard mark.

Star Expansion Company
Pleasant Hill Rd
Mountainville, NY 10953

☆ **STAR**

Star Heel Plate
187 Christie St
Newark, NJ 07105



Positive lock nut.

Steel City Bolt & Screw, Inc
PO Box 1747
Birmingham, AL 35201



Stelco Fastener and Forging Company
1250 Appleby Line
Burlington, Ontario,
Canada L7L 5G6



Bolts, including metric



SAE Gr 5
hex nuts



SAE Gr 8
hex nuts

E Some nuts to designate Swansea Works as originator.

S Used on some like parts to distinguish from other like parts for sorting at Swansea Works.

■ Small square dot on parts too small to accommodate dog bone symbol.



Metric hex nuts and certain inch types



Grade B



Grade C



Conelok

Conelok — Bearing Surface



Class 5



Class 9



Class 10

Stillwater Fasteners, Inc
PO Box 128
East Freetown, MA 02717

SW or &

St Louis Screw & Bolt Co
6900 N Broadway
St Louis, MO 63147

SL

Studwelding Systems Inc
15326 Proctor Ave
Industry, CA 91745

No standard mark.

Supreme Automotive Mfg
1149 McDonald Ave
Brooklyn, NY 11230

S

TEBCO Threaded Fasteners
Division of Tennessee Bolt & Screw
2700 Summer Ave
Memphis, TN 38112



TE-CO
109 Quinter Farm Rd
Union, OH 45322



Terry Machine Co
5331 Dixie Hwy
Waterford, MI 48095

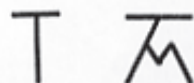

New Products

Texas Bolt Company
3233 West 11th Street
Houston, TX 77008

TB Headed bolts

T Nuts & studs

TEXAS BOLT

Used on some A325 structural bolts.

Third Coast Industries, Inc
PO Box 3824
Beaumont, TX 77704

A

**Thomas Industries
Tool & Fastener Div**
1817 Iowa Ave
Lorain, OH 44052

F For drive pins

**Threaded Rod
Company, Inc**
1029 Fletcher Ave
Indianapolis, IN 46203

No standard mark.

**Towne Robinson
Fastener Company**
4401 Wyoming Ave
Dearborn, MI 48121

TR

**Townsend Division of
Textron Inc**
5250 - 77 Center Drive
Suite 300
Charlotte, NC 28217



Brainard Rivet



Townsend
Engineered Products



FABCO® Fastening
Systems

**Tridair Industries
Fastener Div**
3000 W Lomita Blvd
Torrance, CA 90505



Tridon, Inc
PO Box 1600
Nashville, TN 37202



Trillium Screw Mfg Co Ltd
234 Clements Rd W. Unit 9
Ajax, Ontario,
Canada L1S 3K5

No standard mark.

Trojan Rivet Corp
1833 Dana St
Glendale, CA 91201



Tru-Fit Products Corp
460 Lake Road
Medina, Ohio 44256

TF or **T**

Metrics have ring around



TRW Fasteners Division
265 Third St
Cambridge, MA 02142

TRW

Used for specialty
fasteners.



Denotes Dot®
products . . . snap
type fasteners.

PAL

Used for push on, single
thread & multi thread
fasteners produced by
TRW Fasteners Div.,
Glen Rd., Mountainside,
NJ 07092.

**TRW Nelson Stud
Welding Division**
2707 Toledo Avenue
Lorain, OH 44055
Plant
7900 West Ridge Road
PO Box 4019
Elyria, OH 44036-2019

N

Unimetric Corp
5 Tripps Lane
East Providence, RI 02915

U

United Dowel Pin Mfg
41350 Executive Dr
Mt Clemens, MI 48045

No standard mark.

**United Precision
Products Co., Inc**
25040 Van Born Road
Dearborn Hts, MI 48125

UP

United Steel & Fasteners
1500 E. Industrial Dr
Itasca, IL 60143



Used on all large dia bolts.



All nuts and small dia bolts.

Universal Fasteners, Inc
501 South Varney St
Burbank, CA 91502



Universal Metal Prod
29980 Lakeland Blvd
Wickliffe, OH 44092



On body of clamp.

**Urania Engineering
Co, Inc**
SPEC-NUT®
198 South Poplar Street
Hazleton, PA 18201



USM/Pop Fasteners
510 River Road
Shelton, CT 06484

No standard mark.

Utex Fastener
400 DeKraft
Big Rapids, MI 49307



Valco/Valley Tool & Die, Inc
10020 York Theta Dr
North Royalton, OH 44131



Valley-Todeco
12975 Bradley Avenue
Sylmar, CA 91342



Victor Products Corp
2635 West Belmont
Chicago, IL 60618

V

Virginia Fasteners
PO Box 2158
Norfolk, VA 23501



Vitco Nuclear Products Inc
4445 Hamann Parkway
Willoughby, OH 44094



**VSI Aerospace Products
Division**
3630 Eastham Dr
Culver City, CA 90232

VS

Indicates all Voi-Shan
originated Fastening Systems:
special bolts, nuts, rivets,
blind bolts, etc.



Signifies standard bolts: MS, NAS, etc. as manufactured by the Screwcorp Manufacturing Facility.

Vulcan Rivet & Bolt Corp
PO Box 170129
Birmingham, AL 35217

Plant
1020 Pinson Valley Pkwy
Tarrant, AL 35217

V.

All fasteners marked with the letter "V" followed by a period (.)

V.

Fasteners manufactured from special alloy steels are identified with the letter "V" followed by a period (.) and a line under the letter "V"

**304
V.**

Stainless steel fasteners are marked with the letter "V" followed by a period (.) with the type of stainless

Wales Beech Corporation
4814 American Rd
Rockford, IL 61109

WB

Walker Bolt Mfg Co, Inc
PO Box 38502
Houston, TX 77238

WB

Warren Bolt & Screw Division
14325 E. Nine Mile Rd
Warren, MI 48089



For all headed products.

Warren Fastenings Corp
121 Hudson St
New York, NY 10013

WF

Wayne Bolt & Nut Co
14471 Livernois Ave
Detroit, MI 48238



West Coast Aerospace, Inc
812 Miraflores Ave
San Pedro, CA 90731

WC or W

Westland Steel Products Ltd
PO Box 1052
Winnipeg, Manitoba,
Canada R3C 2X4

W

**Western Canada Steel Ltd
Fastener Division**
450 S.E. Marine Dr
Vancouver, BC
Canada V5X 2T2

P

Whitney Screw Corp
14A Broad St
Nashua, NH 03061



Whittet-Higgins Co
33 Higginson Avenue
Central Falls, RI 02863



Wodin Inc
5441 Perkins Rd
Bedford Hts, OH 44146



Wrought Washer Mfg, Inc
2100 South Bay St
Milwaukee, WI 53207



ASTM F436 Type 1
Structural Washer



ASTM F436 Type 3
Structural Washer



Used for low carbon
washers only at
customer request.

Xact Products, Inc
11530 Brooklyn Rd
Brooklyn, MI 49230



X in a circle.

Yardley Products Corp
10 W. College Ave
Yardley, PA 19068

No standard mark

This IFI-122 document lists manufacturer identification head markings for over 400 North American fastener producers. Companies not yet included in this compilation are kindly requested to send their head marks for future inclusion to: Industrial Fasteners Institute, 1505 East Ohio Building, Cleveland, OH 44114.