





**GSM 180x210**  
**HORIZONTAL MANUAL MITER**  
**BAND SAW MACHINE**

\*Photo may feature machine with optional accessories

**GSM 180x210 MANUAL MITER BAND SAW MACHINE**

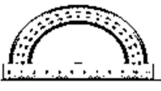
## CUTTING CAPACITY

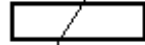
	0°	45°	60°
	180 mm	135 mm	80 mm
	180 mm	135 mm	80 mm
	180 x 210 mm	135 x 140 mm	80 x 90 mm

## TECHNICAL SPECIFICATIONS

<b><i>Main Motor</i></b>	: 0.75 kW
<b><i>Gearbox</i></b>	: Worm Gear Reducer PMRV 50
<b><i>Coolant Motor</i></b>	: 0, 09 kW
<b><i>Coolant Tank Capacity</i></b>	: 15 liters
<b><i>Blade Speed</i></b>	: 25 – 90 m/min
<b><i>Machine Weight</i></b>	: 200 Kg
<b><i>Machine Dimensions</i></b>	: 600 x 1300 x 1400 mm
<b><i>Table Height</i></b>	: 910 mm

## STANDARD ACCESSORIES

### ***Inverter***

Provides to adjust blade speed up to  
Work piece diameter, thickness and hardness.



### ***Rotating Table***

Our machine has rotating table to turn angle.  
So you do not have to move material while  
you want to make miter cutting.

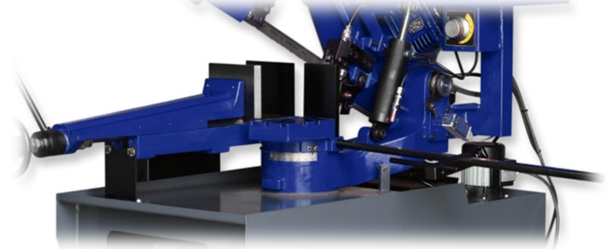

### ***Fast Clamping Vise***



### ***Swarf Brush***

Removes swarfs to keep clean the  
Wheels and blade.



### ***Hydromechanical Blade Tension***



### ***Blade Bedding with Bearings and Carbide Plate***



*S.A.P. (Italy) Brand Coolant Pump*

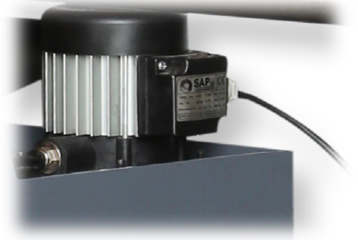

*Fast Clamping Arm*

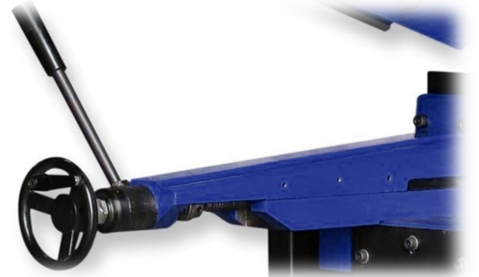

*Arm for Lifting Bow*



*60 cm Long Material Stopper System*

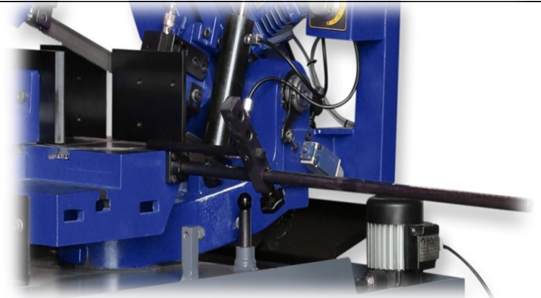

*Adjustable Bow Down Speed*



*Bow Cylinder*



***Easy Readable Angle Ruler***

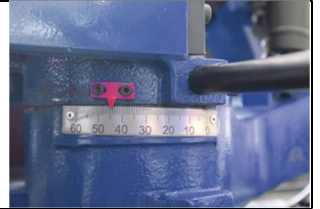

***Wheel Bedding with Bearing***



***Bow Cover Switch***

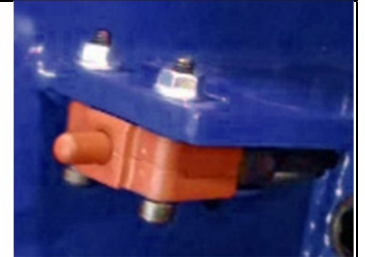

***Blade Tension Switch***



***Dismountable Saw Frame***

***24 VDC Wiring at Control Panel***

***Automatic Stop When;***

- The covers are open
- Blade is broken
- Blade tension is low

## **SAFETY EQUIPMENTS**

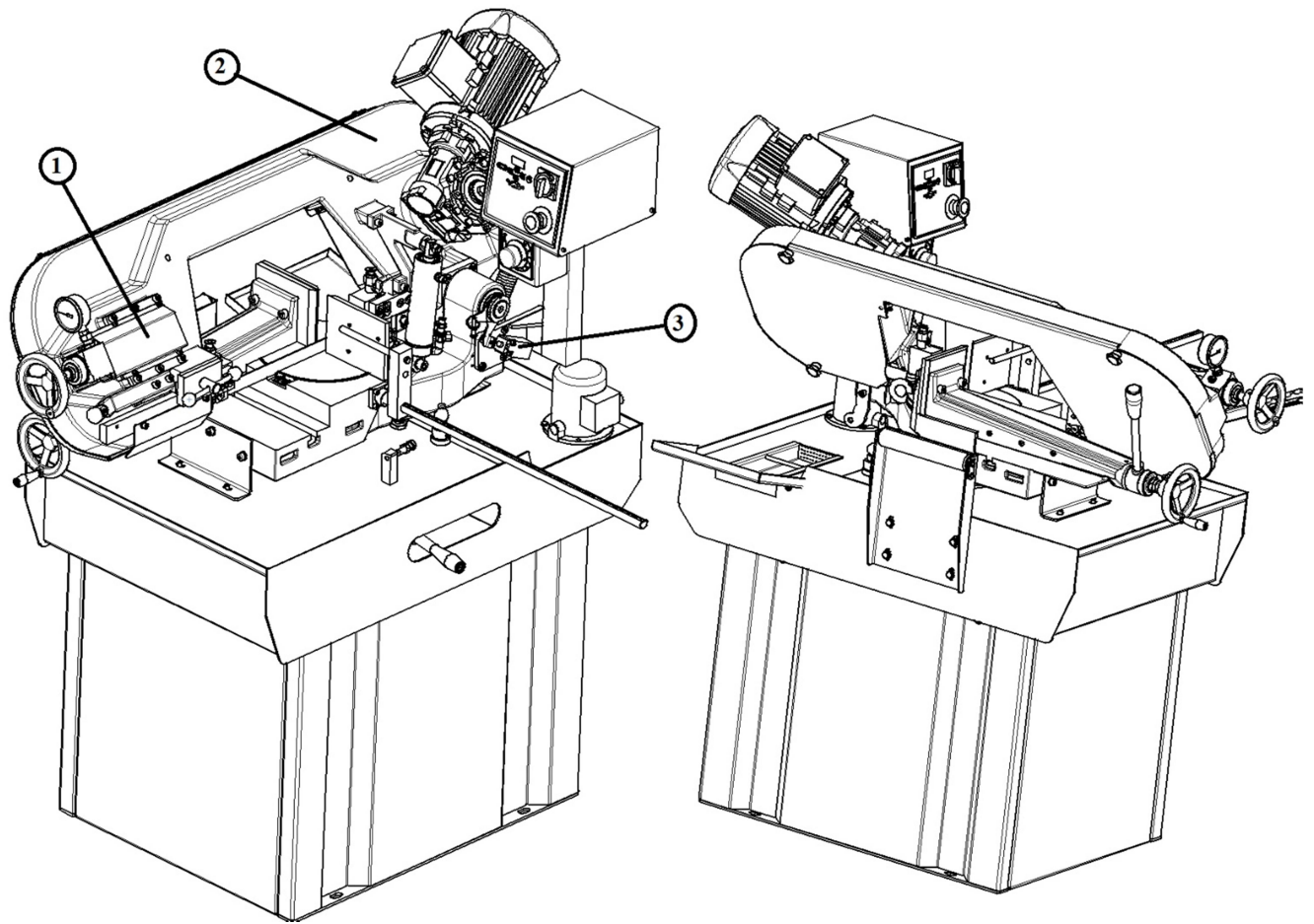

- 1) Break-off Switch**
- 2) Cover Switch**
- 3) Down Limit Switch**

,

## **TERMS**

**Delivery(After Receipt of written PO) :**

**Type of Delivery** : **Exworks**

## **WARRANTY CONDITIONS**

The machine is under the warranty of SAPHIR. For a period of 2 years for mechanical parts, 1 year for electric and electronic parts from the date of purchase. This warranty is subject to all of the terms and conditions listed below:

1. This warranty is valid only if the **Warranty Registration Form** is filled in and returned to the manufacturer or its authorized dealer within **two months after the** date of purchase.
2. The obligation of the manufacturer under this warranty shall be limited to repairing or replacing components which proves defective and which our examination shall disclose to our satisfaction to be defective.
3. Defects due to improper operation, misuse, neglect, alteration, irregular voltage conditions, inadequate wiring, improper installation (**all electrical and electronic components, all electrical motors etc.**) and due to accidents or any damage caused by transportation, flood, fire, natural disasters, theft are not included in this warranty and are strictly the responsibility of the purchaser.
4. Any part returned to SAPHIR or its authorized dealer under the terms of this warranty shall be on the basis of transportation charges prepaid by the customer and must be accompanied by a record of the machine model code and serial number.
5. This warranty does not apply to the following components; band saw blade, blade pressure pads or brackets and blade guide bearings **because of being consumables.**
6. Manufacturer and authorized dealer cannot be blamed within maximum repair period for the material or moral damage. Apart from that act the period as Warranty Conditions and there will not be done any retroactive requirement.



**SAPHIR BANDSAW MACHINES**  
**Hanlı Merkez Mah. Hatip Sok. No:32**  
**Arifiye/Sakarya/TURKEY**  
**Phone: +90 264 276 59 16**  
**Fax: +90 264 276 59 19**  
[www.saphirbandsaw.com](http://www.saphirbandsaw.com)  
[sales@saphirbandsaw.com](mailto:sales@saphirbandsaw.com)

**GSM 180x210 MANUAL MITER BAND SAW MACHINE**