

SAPHIR







RFM 300x340 ENC HORIZONTAL AUTO MITER BAND SAW MACHINE

*Photo may feature machine with optional accessories

RFM 300x340 ENC Auto Miter Band Saw Machine

CUTTING CAPACITY

	0°	45°	60°
	300 mm	230 mm	120 mm
	280 mm	210 mm	110 mm
	280 x 340 mm	180 x 250 mm	100 x 210 mm

TECHNICAL SPECIFICATIONS

<i>Main Motor</i>	: 2, 2 kW
<i>Gearbox</i>	: Bevel Helical PKD 1390 100L/4C High Efficiency
<i>Hydraulic Motor</i>	: 0, 37 kW
<i>Coolant Motor</i>	: 0, 12 kW
<i>Blade Speed</i>	: 25-90 m/min
<i>Blade Dimensions</i>	: 3.850 x 27 x 0, 9 mm
<i>Machine Weight</i>	: 960 kg
<i>Machine Dimensions</i>	: 1.220 x 2.000 x 1.300 mm
<i>Table Height</i>	: 750 mm

STANDARD ACCESSORIES

Digital Control Panel

50 programs with 50 lines
Error page
Alarm list
Easy language selection
Easy denomination selection



Inverter

Provides to adjust blade speed up to workpiece diameter, thickness and hardness.



Feeder Vise

Pressure, clamping period and clamping time can be adjusted.



Hydramechanical Blade Tensioning

Tensioning period and tensioning time can be adjusted. So blade does not relax and curve cutting gets prevented.



Swarf Brush

Removes swarfs to keep clean the wheels and blade.

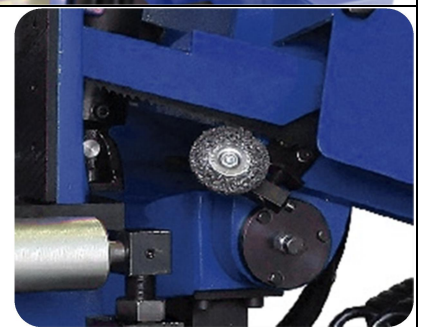

Bevel Helical Gearbox



Transport Hooks



Levelling Foot Leg



Mechanical Top Clamp

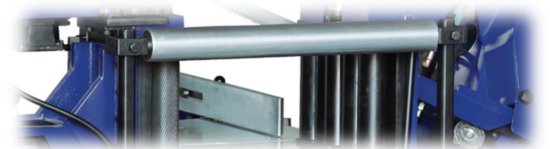

Material Move Support Roller

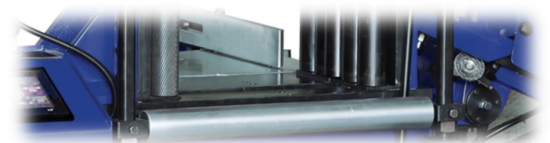

Single Roller Table



Adjustable Vise Pressure



Rotating Table

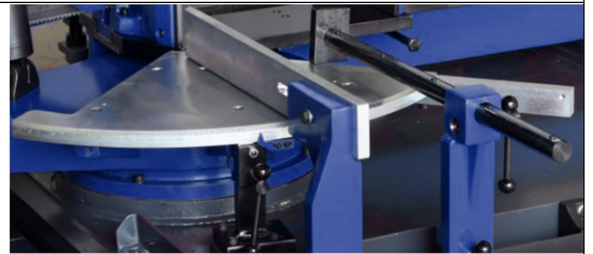

Rotating Vise Flange



Moveable Guide Arms



Helical Channeled Feeder Roller

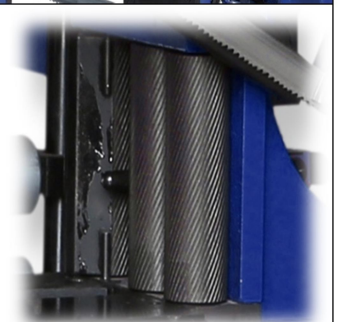

Blade Bedding with Carbide and Bearings

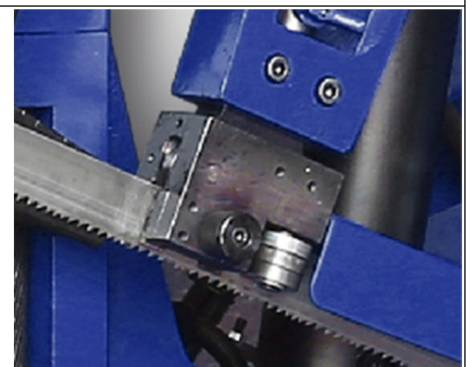

oManometer



Cover Switch



Tension Switch



Electric Cabinet Switch



S.A.P (Italy) Brand Coolant Pump

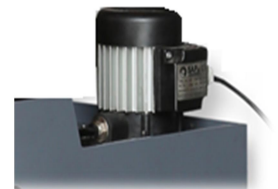

Easy Readable Angle Ruler



Adjustable Bow Down Speed



Blade Bedding at Wheels



Automatic Stop When;

- The covers are open
- Blade is broken
- Blade tension is low

OPTIONAL ACCESSORIES

Laser Line Indicator



Micro Molecular Coolant System



SAFETY EQUIPMENTS

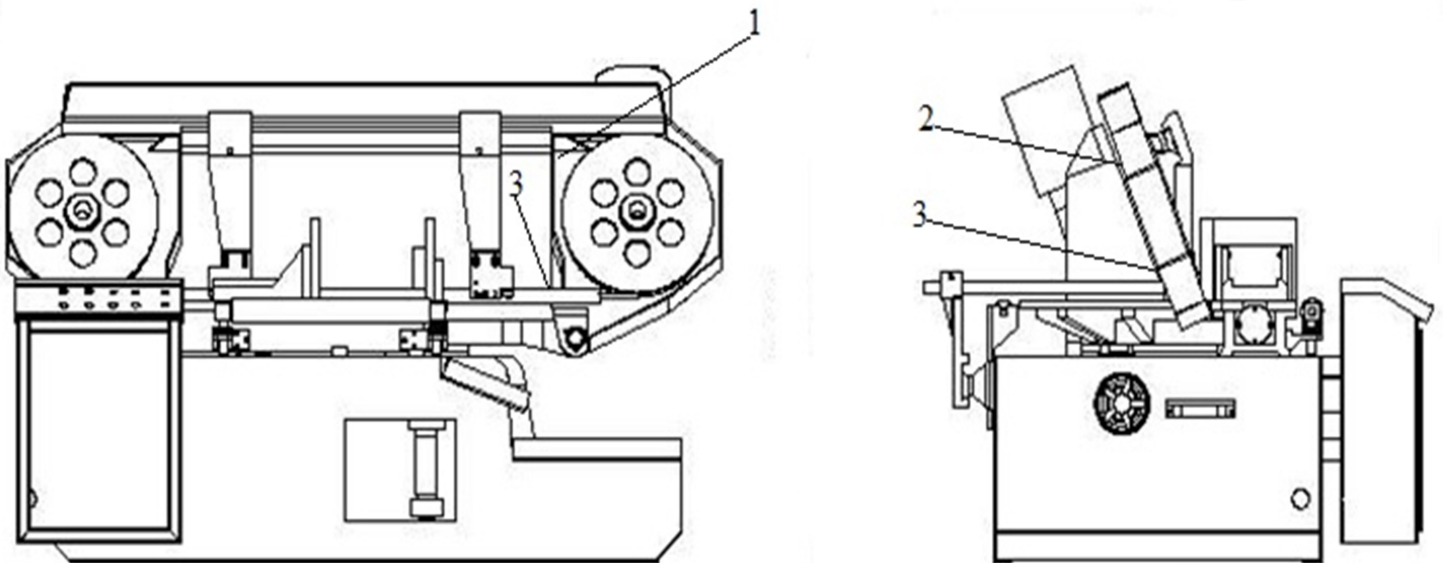

NO	
1	Right Cover Switch
2	Hydraulic Band Tension Switch
3	Upper Limit Switch
	Lower Limit Switch

TERMS

Delivery (After Receipt of written PO) :

Type of Delivery : **Exwork**

WARRANTY CONDITIONS

The machine is under the warranty of SAPHIR For a period of 2 years for mechanical parts, 1 year for electric and electronic parts from the date of purchase. This warranty is subject to all of the terms and conditions listed below:

1. This warranty is valid only if the **Warranty Registration Form** is filled in and returned to the manufacturer or its authorized dealer within **two months after the** date of purchase.
2. The obligation of the manufacturer under this warranty shall be limited to repairing or replacing components which proves defective and which our examination shall disclose to our satisfaction to be defective.
3. Defects due to improper operation, misuse, neglect, alteration, irregular voltage conditions, inadequate wiring, improper installation (**all electrical and electronic components, all electrical motors etc.**) and due to accidents or any damage caused by transportation, flood, fire, natural disasters, theft are not included in this warranty and are strictly the responsibility of the purchaser.
4. Any part returned to SAPHIR or its authorized dealer under the terms of this warranty shall be on the basis of transportation charges prepaid by the customer and must be accompanied by a record of the machine model code and serial number.
5. This warranty does not apply to the following components; band saw blade, blade pressure pads or brackets and blade guide bearings **because of being consumables**.
6. Manufacturer and authorized dealer cannot be blamed within maximum repair period for the material or moral damage. Apart from that act the period as Warranty Conditions and there will not be done any retroactive requirement.



SAPHIR BANDSAW MACHINES
Hanli Merkez Mah. Hatip Sok. No:32
Arifiye/Sakarya/TURKEY
Phone: +90 264 276 59 16
Fax: +90 264 276 59 19
www.saphirbandsaw.com
sales@saphirbandsaw.com