

SAPHIR





SAM 220x310 DM SEMI AUTO MITER BAND SAW MACHINE

*Photo may feature machine with optional accessories

SAM 220x310 DM SEMI AUTO MITER BAND SAW MACHINE

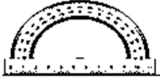
CUTTING CAPACITY

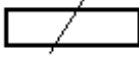
	0°	45°	60°	-45°
	220 mm	200 mm	120 mm	180 mm
	220 mm	200 mm	120 mm	140mm
	220 x 310 mm	200 x 200 mm	120 x 130 mm	90 x 220 mm

TECHNICAL SPECIFICATIONS

Main Motor	: 1,5kW
Gearbox	: Worm Gear Reducer PMRV 063
Hydraulic Motor	: 0,37kW
Hydraulic Tank Capacity	: 8 Liters
Coolant Motor	: 0,12kW
Coolant Tank Capacity	: 15 liters
Blade Speed	: 25 -90 m/min
Blade Dimensions	: 3.000 x 27 x 0,9 mm
Machine Weight	: 480 kg
Machine Dimensions	: 900 x 1750 x 1400 mm
Table Height	: 980 mm

STANDARD ACCESSORIES

Manuel Control Panel

Only control panel with buttons
Easy control



Inverter

Provides to adjust blade speed up to
workpiece diameter, thickness and hardness.



Swarf Brush

Removes swarfs to keep clean the
wheels and blade.



Roller Table

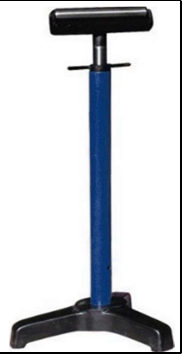

Pneumatic Vice



Double Miter

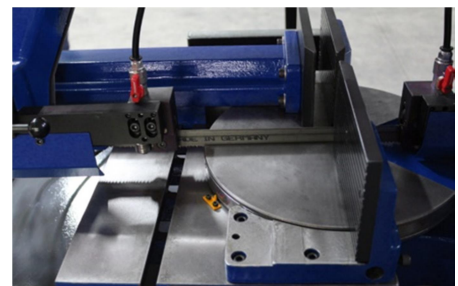

Fast Clamping Vise

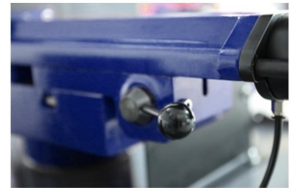

Manometer



S.A.P (Italy) Brand Coolant Pump



Rotating Vise Flange

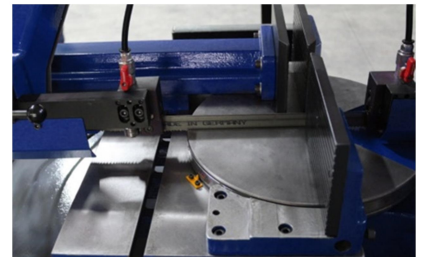

Easy Readable Angle Ruler

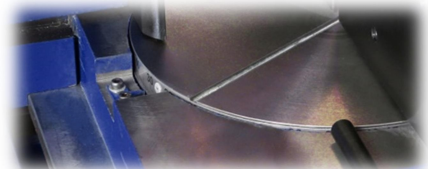

60 cm Long Material Stopper System



Adjustable Bow Down Speed



Blade Bedding with Carbide and Bearings

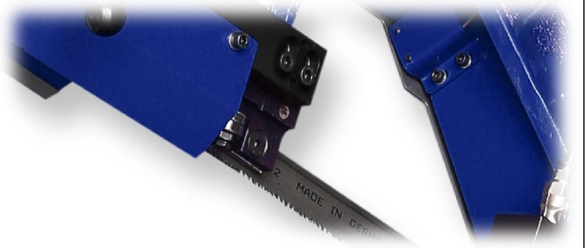

Rotating Table

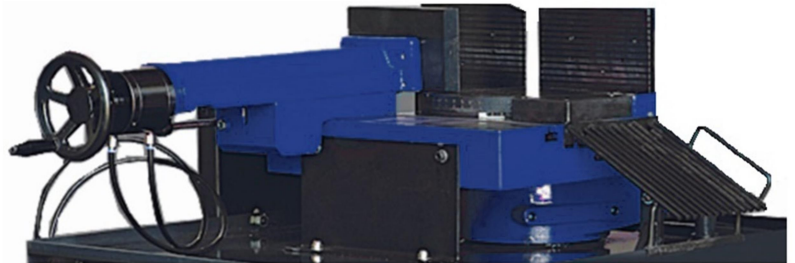

Hydromechanical Blade Tension

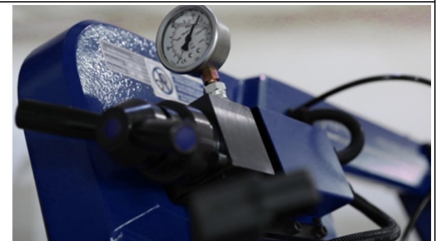

Bow Cover Switch



Blade Tension Switch



Levelling Foot Leg



Wheel Bedding with Bearing



Automatic Stop When;

- The covers are open
- Blade is broken
- Blade tension is low

OPTIONAL ACCESSORIES

Micro Molecular Coolant System



Foot Pedal



Hydraulic Vise

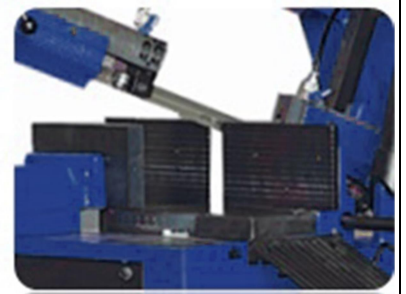

SAFETY EQUIPMENTS AND ASSIGNMENTS

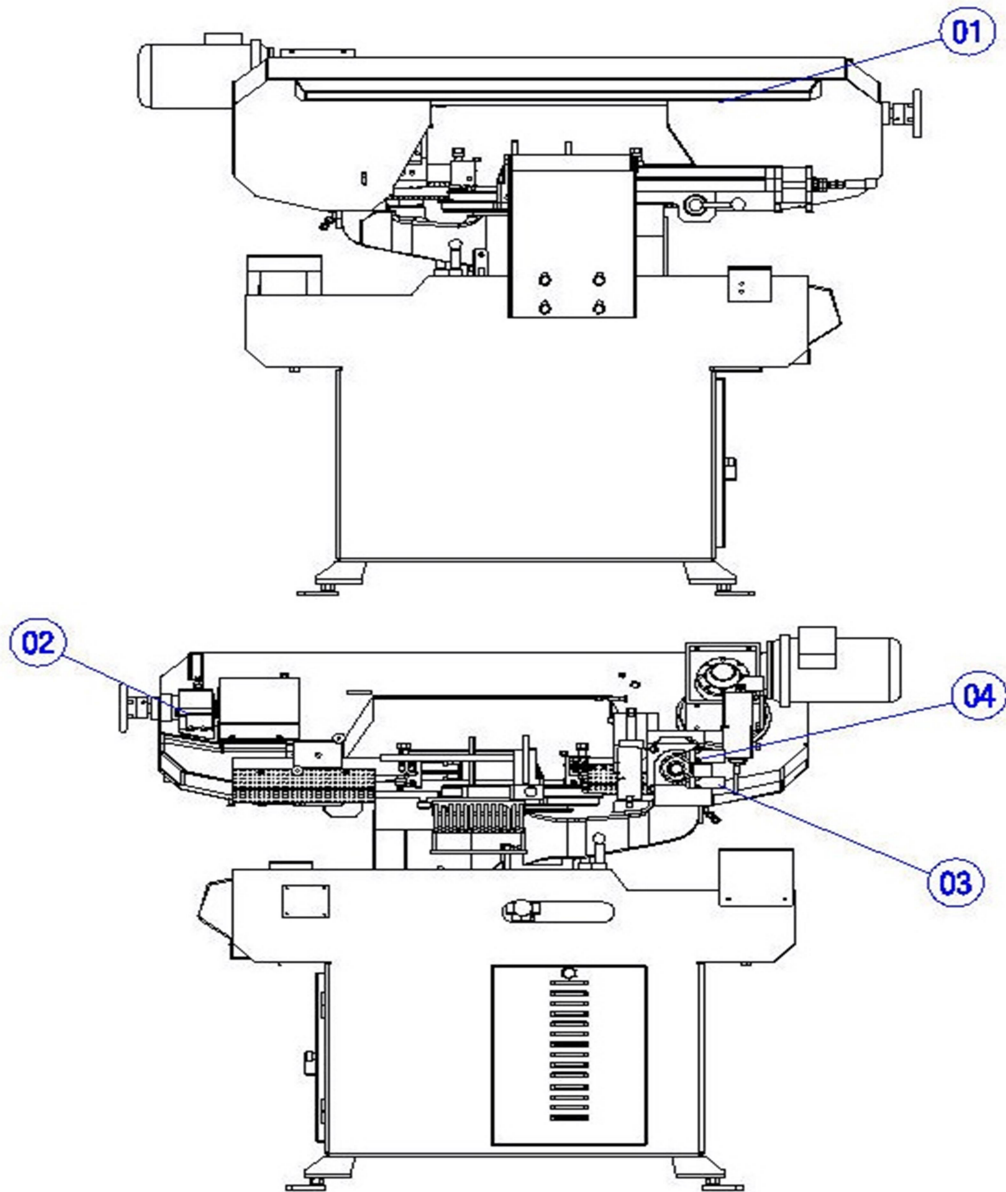

1	Lid Safety Switch
2	Break-off Switch
3	Down Limit Switch
4	Top Limit Switch

TERMS

Delivery (After Receipt of written PO) :

Type of Delivery : **Exwork**

WARRANTY CONDITIONS

The machine is under the warranty of SAPHIR. For a period of 2 years for mechanical parts, 1 year for electric and electronic parts from the date of purchase. This warranty is subject to all of the terms and conditions listed below:

1. This warranty is valid only if the **Warranty Registration Form** is filled in and returned to the manufacturer or its authorized dealer within **two months after the** date of purchase.
2. The obligation of the manufacturer under this warranty shall be limited to repairing or replacing components which proves defective and which our examination shall disclose to our satisfaction to be defective.
3. Defects due to improper operation, misuse, neglect, alteration, irregular voltage conditions, inadequate wiring, improper installation (**all electrical and electronic components, all electrical motors etc.**) and due to accidents or any damage caused by transportation, flood, fire, natural disasters, theft are not included in this warranty and are strictly the responsibility of the purchaser.
4. Any part returned to SAPHIR or its authorized dealer under the terms of this warranty shall be on the basis of transportation charges prepaid by the customer and must be accompanied by a record of the machine model code and serial number.
5. This warranty does not apply to the following components; band saw blade, blade pressure pads or brackets and blade guide bearings **because of being consumables**.
6. Manufacturer and authorized dealer cannot be blamed within maximum repair period for the material or moral damage. Apart from that act the period as Warranty Conditions and there will not be done any retroactive requirement.



SAPHIR BANDSAW MACHINES
Hanlı Merkez Mah. Hatip Sok. No:32
Arifiye/Sakarya/TURKEY
Phone: +90 264 276 59 16
Fax: +90 264 276 59 19
www.saphirbandsaw.com
sales@saphirbandsaw.com