

Life Is On

Schneider
Electric



 Price List

Final Distribution, Wiring Devices and Lighting Control Products

With effect from January 30th, 2023

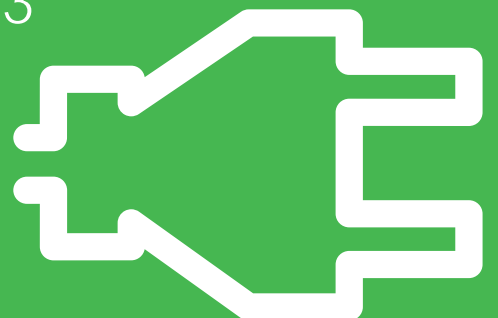

se.com/in

Acti 9 Distribution System

- > Miniature Circuit Breakers (MCBs).....8
- > Residual Current Devices.....12
- > Auxiliaries and Accessories for MCBs / RCDs14
- > Surge Protection Devices.....16
- > Control and Command Products.....18
- > ComReady Control and Command Products.....20
- > Isobar Distribution System21
- > Acti 9 Isobar Pan Assembly23
- > Acti 9 Distribution Boards.....24
- > Modular Distribution Boards - Metallic28

Kaedra Enclosures

- > Weather Proof34

Pratika

- > Plugs and Sockets - IP44 / IP6736

Electra

- > Metal Clad Plugs & Sockets40

56 Series

- > Plugs and Sockets - IP56 / IP6641

Wiring Devices

- > LIVIA - Switch to the extra-ordinary.....46
- > Clipsal X - As Stylish As Your World47
- > Opale - Switches with Satin Finish51
- > Unica Pure - Irresistibly Beautiful53
- > ZENcelo India - The Revolutionary Full-Flat Switch.....63
- > AvatarOn - It's also a Switch.....67
- > Kavacha - Weather Protected Series.....74
- > Metal Boxes.....75
- > Wiser.....76
- > Surface and Flush Mount Occupancy Sensors.....77
- > Dimmable Sensors with Light Regulation.....77
- > Wall Mount Sensors.....78
- > Hotel - ELV Dual Motion Sensor78
- > Timers & Time Switches79

Acti 9 | Advanced Communication Technology that Inspires

> Protection devices

- Miniature circuit breakers
- Residual current circuit breakers
- Vigi™ residual current devices
- Surge Protection Devices

> Protection monitoring and supervision

- Indication and tripping auxiliaries
- Remote control auxiliaries
- Automatic reclosure auxiliaries



Innovative
Protection monitoring Total control and
Metering @ DB level



Efficient
Manage loads, reduce operating and project
costs, and accurately plan maintenance

> Control and monitoring

- Contactors
- Impulse relays
- Integrated control circuit breakers
- Light indicators
- Push-buttons and selector switches
- Kilowatt hour meters
- Communicating architecture

> Installation system

- IP20B terminals
- Splitter blocks
- Full range of mounting and wiring accessories



Reliable

Dual certifications for one product, 100 percent MCB and RCD coordination, easy ordering and design, error free fast connections

Acti 9 | Advanced Communication Technology that Inspires.....

> Innovative

- Centralized control system including energy metering
- Large and variable data reading and computing through universal Modbus protocol

> Efficient

- One-click, prefabricated wiring for comprehensive communication between your distribution board or panel and any facility management system

> Reliable

- Error proof connection leading to reduction in downtime
- EMC tested for immunity, radiated and conducted safety

NEW

Email Notification upon Event (Devices Status Change, Alarm threshold reached etc.)

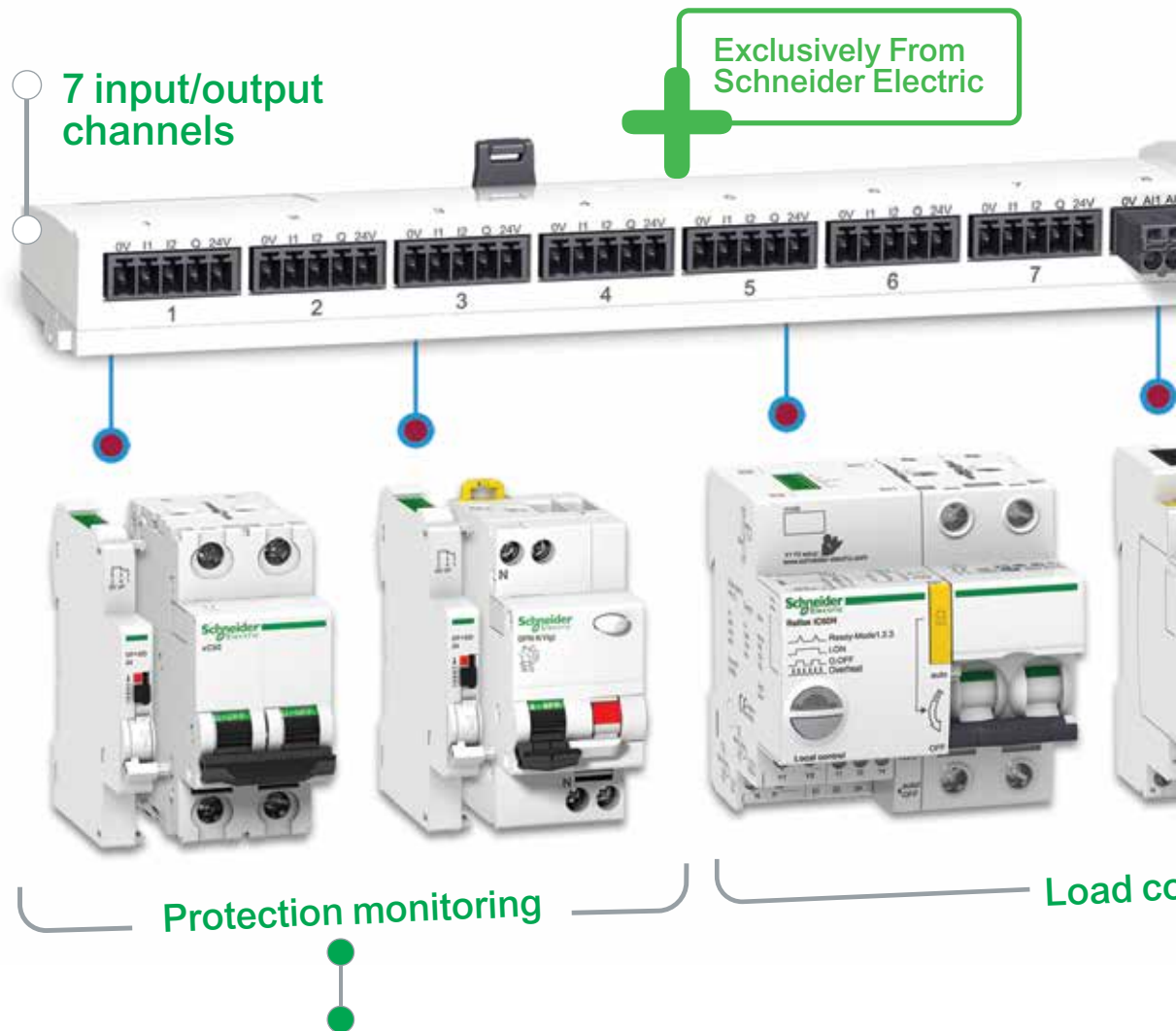

7 input/output channels

Exclusively From Schneider Electric

Protection monitoring

Load control

- > Status Monitoring - ON / OFF / TRIP
- > Trip Alarm Indication
- > Load Monitoring - No. of tripping cycles, Running Hours

- > Switching Action - ON / OFF
- > Monitoring - No. of Switching cycles, running hours



Meets the challenge of all your applications

Detailed load control, reduced downtime and accurately planned maintenance

Ready to connect to any facility management solution

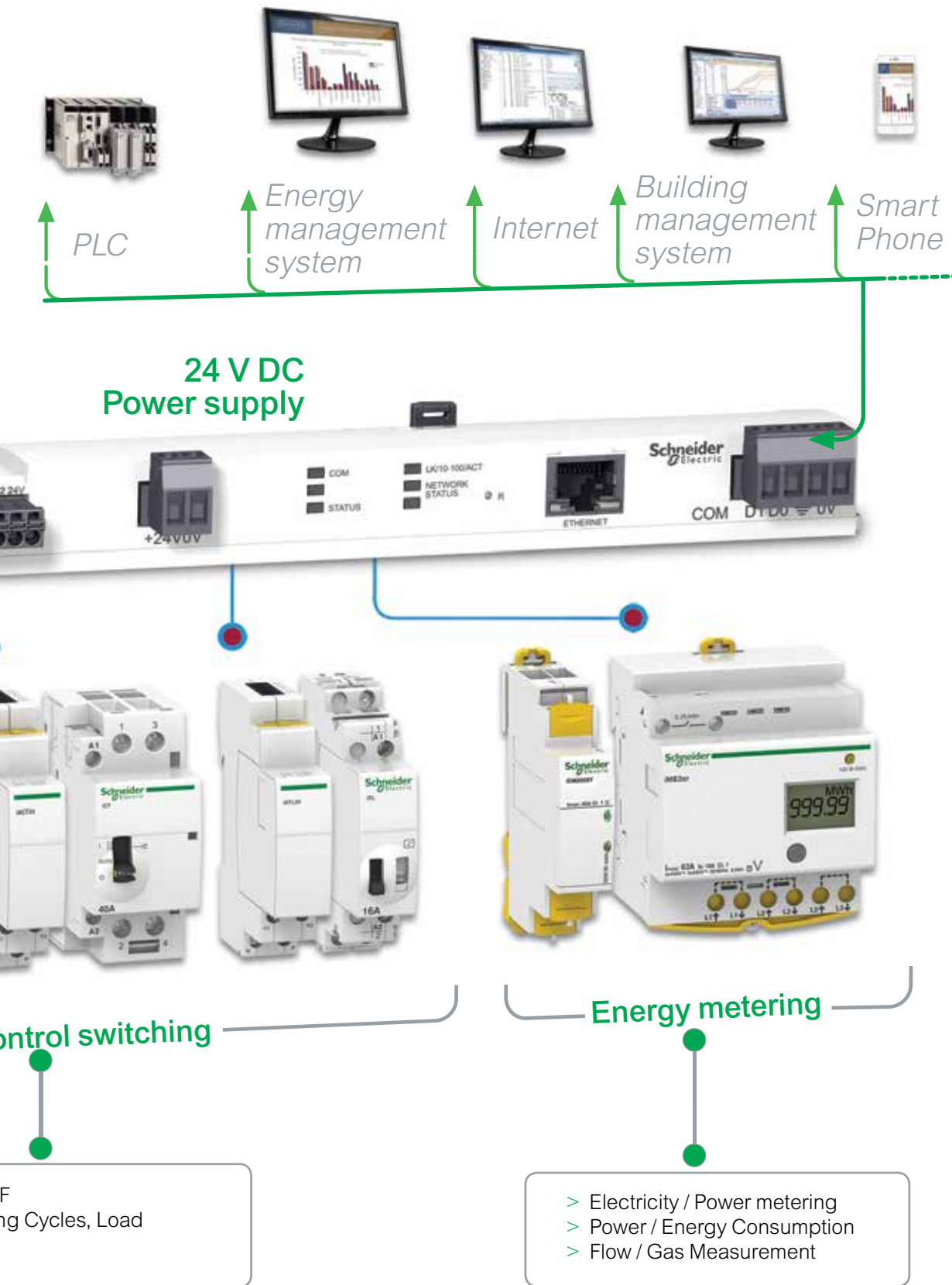

Green Premium Products

100% Recyclable and Recoverable
REACH, RoHS, PEP, EOL compliant

AC Miniature Circuit Breakers - xC60



Green Premium

- Breaking Capacity as per IEC 60898 and IS/IEC 60898-1, Icn = 10kA
- Breaking Capacity as per IEC 60947-2, Icn = 15kA, upto 40A
- Can be used for DC application upto 60V per pole
- Higher system performance with optimized cost: Cascading*
- Increased System Continuity: Discrimination*
- Higher Installation Life: Energy Limitation Class 3, Fast Closure Mechanism
- Ease, Speed and Flexibility of installation - Biconnect, Line-Load Reversible
- Field-fittable auxiliaries for advance protection and monitoring
- Positive Contact Indication for assurance of disconnection

[In] Rated Current (A)	1 Pole Reference	Unit MRP [₹]	2 Pole Reference	Unit MRP [₹]	3 Pole Reference	Unit MRP [₹]	4 Pole Reference	Unit MRP [₹]
Module Width**	1 mod		2 mod		3 mod		4 mod	
MOQ	12 Nos.		6 Nos.		4 Nos.		3 Nos.	

B curve

6	A9N1P06B ✓	442	A9N2P06B ✓	1312	A9N3P06B ✓	2177	A9N4P06B	2933
10	A9N1P10B ✓	442	A9N2P10B ✓	1312	A9N3P10B ✓	2177	A9N4P10B ✓	3094
16	A9N1P16B ✓	442	A9N2P16B ✓	1312	A9N3P16B ✓	2177	A9N4P16B ✓	2933
20	A9N1P20B ✓	442	A9N2P20B ✓	1312	A9N3P20B ✓	2177	A9N4P20B ✓	2933
25	A9N1P25B ✓	442	A9N2P25B ✓	1312	A9N3P25B ✓	2177	A9N4P25B ✓	2933
32	A9N1P32B ✓	442	A9N2P32B ✓	1312	A9N3P32B ✓	2177	A9N4P32B ✓	2933
40	A9N1P40B ✓	960	A9N2P40B ✓	2112	A9N3P40B ✓	3316	A9N4P40B ✓	4223
50	A9N1P50B	960	A9N2P50B	2112	A9N3P50B	3316	A9N4P50B	4280
63	A9N1P63B ✓	973	A9N2P63B ✓	2170	A9N3P63B ✓	3344	A9N4P63B ✓	4261

C curve

1	A9N1P01C ✓	678	A9N2P01C ✓	1817	A9N3P01C ✓	2867	A9N4P01C ✓	3609
2	A9N1P02C ✓	678	A9N2P02C ✓	1817	A9N3P02C ✓	2867	A9N4P02C ✓	3609
3	A9N1P03C ✓	678	A9N2P03C ✓	1817	A9N3P03C ✓	2867	A9N4P03C ✓	3609
4	A9N1P04C ✓	678	A9N2P04C ✓	1817	A9N3P04C ✓	2867	A9N4P04C ✓	3609
6	A9N1P06C ✓	409	A9N2P06C ✓	1312	A9N3P06C ✓	2177	A9N4P06C ✓	2933
10	A9N1P10C ✓	409	A9N2P10C ✓	1312	A9N3P10C ✓	2177	A9N4P10C ✓	2933
16	A9N1P16C ✓	409	A9N2P16C ✓	1312	A9N3P16C ✓	2177	A9N4P16C ✓	2933
20	A9N1P20C ✓	409	A9N2P20C ✓	1312	A9N3P20C ✓	2177	A9N4P20C ✓	2933
25	A9N1P25C ✓	409	A9N2P25C ✓	1312	A9N3P25C ✓	2177	A9N4P25C ✓	2933
32	A9N1P32C ✓	409	A9N2P32C ✓	1312	A9N3P32C ✓	2177	A9N4P32C ✓	2933
40	A9N1P40C ✓	960	A9N2P40C ✓	2112	A9N3P40C ✓	3316	A9N4P40C ✓	4138
50	A9N1P50C	960	A9N2P50C	2112	A9N3P50C	3316	A9N4P50C	4261
63	A9N1P63C ✓	973	A9N2P63C ✓	2131	A9N3P63C ✓	3425	A9N4P63C ✓	4439

D curve

1	A9N1P01D ✓	685	A9N2P01D	1836	A9N3P01D ✓	2912	----	----
2	A9N1P02D ✓	685	A9N2P02D ✓	1836	A9N3P02D ✓	2912	A9N4P02D	3781
3	A9N1P03D ✓	685	A9N2P03D ✓	1836	A9N3P03D ✓	2912	A9N4P03D	3808
4	A9N1P04D ✓	685	A9N2P04D ✓	1836	A9N3P04D ✓	2912	A9N4P04D	3884
6	A9N1P06D ✓	577	A9N2P06D ✓	1376	A9N3P06D ✓	2293	A9N4P06D ✓	3042
10	A9N1P10D ✓	577	A9N2P10D ✓	1376	A9N3P10D ✓	2293	A9N4P10D ✓	3042
16	A9N1P16D ✓	577	A9N2P16D ✓	1376	A9N3P16D ✓	2293	A9N4P16D ✓	3042
20	A9N1P20D ✓	577	A9N2P20D ✓	1376	A9N3P20D ✓	2293	A9N4P20D ✓	3042
25	A9N1P25D ✓	577	A9N2P25D ✓	1376	A9N3P25D ✓	2293	A9N4P25D ✓	3042
32	A9N1P32D ✓	577	A9N2P32D ✓	1376	A9N3P32D ✓	2293	A9N4P32D ✓	3042
40	A9N1P40D ✓	1036	A9N2P40D ✓	2232	A9N3P40D ✓	3512	A9N4P40D ✓	4405
50	A9N1P50D	1099	A9N2P50D	2232	A9N3P50D	3512	A9N4P50D	4405
63	A9N1P63D	1049	A9N2P63D ✓	2259	A9N3P63D ✓	3544	A9N4P63D ✓	4450

Note: * Please contact nearest Schneider Electric Sales Office or Customer Care Center for coordination chart

**18mm/module

Please contact Customer Care Center for Stockable and Non stockable status of references.

✓ NORMAL STOCK ITEMS

W.E.F. January 30th, 2023

AC Miniature Circuit Breakers - C120



- Breaking capacity as per IEC 60898, Icn = 10kA/15kA
- Positive Contact Indication for assurance of disconnection
- Degree of pollution: 3 (suitable for industrial environment)
- Operating Temperature: -30 to 70°C
- Terminal connections: Flexible cables up to 35 sq.mm; Rigid cables up to 50 sq.mm

[In] Rated Current (A)	1 Pole Reference	Unit MRP [₹]	2 Pole Reference	Unit MRP [₹]	3 Pole Reference	Unit MRP [₹]	4 Pole Reference	Unit MRP [₹]
Module Width**	1.5 mod		3 mod		4.5 mod		6 mod	
MOQ	12 Nos.		6 Nos.		4 Nos.		3 Nos.	
C120N (10kA)								
80	A9N18357 ✓	3607	A9N18361 ✓	7993	A9N18365 ✓	12556	A9N18372 ✓	16363
100	A9N18358 ✓	4046	A9N18362 ✓	8526	A9N18367 ✓	13382	A9N18374 ✓	17049
125	A9N18359 ✓	4452	A9N18363 ✓	9371	A9N18369 ✓	14843	A9N18376 ✓	19295
C120H (15kA)								
80	A9N18446	4359	A9N18457	9619	A9N18468	14756	A9N18479	20474
100	A9N18447	4997	A9N18458	10058	A9N18469	16076	A9N18480	22700
125	A9N18448	5254	A9N18459	11411	A9N18470	17349	A9N18481	23980

DC Miniature Circuit Breakers - C60H



- Specially designed MCB for enhanced protection in DC installation
- Magnetic Arc Chutes to quick break DC current in event of fault
- Breaking capacity 6kA as per IEC 60947-2
- Voltage Rating: 1P - 250 V DC & 2P - 500 V DC
- Impulse Voltage: 6 kV
- Higher Installation Life: Energy Limiting Class: 3

[In] Rated Current (A)	Module Width 18mm/ module	1 Pole Reference	Unit MRP [₹]	Module Width 18mm/ module	2 Pole Reference	Unit MRP [₹]
MOQ		12 Nos.			6 Nos.	
C60H-DC						
0.5	1	A9N61500	1699	2	A9N61520	3730
1	1	A9N61501 ✓	1239	2	A9N61521 ✓	2557
2	1	A9N61502 ✓	1239	2	A9N61522 ✓	2557
3	1	A9N61503 ✓	1239	2	A9N61523 ✓	2557
4	1	A9N61504 ✓	1239	2	A9N61524 ✓	2557
5	1	A9N61505	1239	2	A9N61525	2557
6	1	A9N61506 ✓	1018	2	A9N61526 ✓	2081
10	1	A9N61508 ✓	1018	2	A9N61528 ✓	2081
16	1	A9N61511 ✓	1018	2	A9N61531 ✓	2081
20	1	A9N61512 ✓	1018	2	A9N61532 ✓	2081
25	1	A9N61513 ✓	1018	2	A9N61533 ✓	2081
32	1	A9N61515 ✓	1172	2	A9N61535 ✓	2081
40	1	A9N61517 ✓	1395	2	A9N61537 ✓	3069
50	1	A9N61518 ✓	1395	2	A9N61538 ✓	3069
63	1	A9N61519 ✓	1395	2	A9N61539 ✓	3069

Special application MCBs



Solar Application – PV DC

- DC MCB for multi string PV installations
- Operating Voltage: 800V DC
- Current Rating up to 25A
- Complies to IEC / EN 60947-2



Rail Application* (including Rolling Stock)

- Fire & smoke Resis tant – Level 2 (NF F 16-101, NF F 16-102)
- Shock & vibration resistant (IEC 61373) – Cat 1, Class B
- Breaking Capacity: up to 25kA
- Complies to IEC / EN 60947-2



UL MCB

- Type: UL1077, UL489
- Breaking Capacity of 10kA
- Complies to IEC 60947-2 / UL1077 / UL489 / CSA

Note:

Please contact nearest Schneider Electric sales office or Customer Care for Reference and prices of Application Specific MCBs

*Rail Application RCDs are also available on demand

**18mm/module

Please contact Customer Care Center for Stockable and Non stockable status of references.

✓ NORMAL STOCK ITEMS

W.E.F. January 30th, 2023

AC Miniature Circuit Breakers - NG125



- Compliance to IEC / EN 60947-2
- High Breaking Capacity MCBs – up to 50kA
- Current Rating up to 125A
- Trip on fault indication on front face of MCB
- Suitability for isolation in the industrial sector to IEC/EN 60947-2
- Available in B, C, D Curves

[In] Rated Current (A)	1 Pole Reference	Unit MRP [₹]	2 Pole Reference	Unit MRP [₹]	3 Pole Reference	Unit MRP [₹]	4 Pole Reference	Unit MRP [₹]
Module Width**	1.5 mod		3 mod		4.5 mod		6 mod	

NG125N – 25kA Breaking Capacity

10	18610	5556	18621	12779	18632	18540	18649	24620
16	18611	5291	18622	9856	18633	18459	18650	22428
20	18612	5298	18623	11874	18634	18540	18651	22422
25	18613	5291	18624	11641	18635	17663	18652	22428
32	18614	5291	18625	11945	18636	18546	18653	24613
40	18615	6823	18626	14423	18637	24262	18654	31918
50	18616	8513	18627	14988	18638	23094	18655	30831
63	18617	6823	18628	15693	18639	27264	18656	33701
80	18618	7196	18629	17631	18640	28661	18658	33933

NG125H – 36kA Breaking Capacity

10	18705	7993	18714	10356	18723	16204	18732	28098
16	18706	6714	18715	10563	18724	16204	18733	28098
20	18707	7985	18716	20712	18725	22146	18734	28098
25	18708	6223	18717	13664	18726	21083	18735	28105
32	18709	6223	18718	13664	18727	23151	18736	28098
40	18710	7621	18719	15793	18728	23576	18737	34148
50	18711	7768	18720	17077	18729	27574	18738	35073
63	18712	7981	18721	18335	18730	24152	18739	38500
80	18713	8780	18722	23941	18731	31246	18740	40604

NG125H – 50kA Breaking Capacity

10	18777	8113	18788	17805	18799	28050	18810	35591
16	18778	7760	18789	16957	18800	28050	18811	35591
20	18779	7760	18790	18282	18801	28050	18812	35591
25	18780	7760	18791	18275	18802	26707	18813	35591
32	18781	7760	18792	18275	18803	29317	18814	37209
40	18782	9418	18793	21749	18804	35051	18815	44174
50	18783	13226	18794	22847	18805	37532	18816	45666
63	18784	9889	18795	25667	18806	38280	18817	51095
80	18785	14569	18796	26860	18807	41608	18818	50269

**18mm/module

Note: Reference provided above are for C Curve MCBs – B and D Curve details available on request

Residual Current Devices (RCDs) - For Human and Fire Protection



**30
mA**

Use of **30mA RCDs** is now **mandatory** for all **domestic intallations** in India {CEA Amendment regulation 2015*}



Schneider Electric provides voltage independent RCDs which work on current sensing technology and provide protection from residual current even at extra low voltages (down to zero volts) and in case of break of neutral.

**SI
Type**

Schneider Electric offers SI RCD built to operate in electrically polluted or installation in aggressive environments:

- Flourescent / Variable lighting with Electronic ballast
- Powerful IT / Telecom equipment / Air conditioning
- Severe Atmosphere - High lighting risk / Swimming pools

* for Measures relating to Safety and Electric supply

Please contact Customer Care Center for Stockable and Non stockable status of references.

NORMAL STOCK ITEMS

W.E.F. January 30th, 2023

AC Residual Current Circuit Breakers - xID



Suitable for
ComReady
Auxiliary



- Complies to standards IEC/EN 61008-1 and IS 12640
- AC Class protection
- Selective range available for time based discrimination
- Easy Monitoring: Earth fault indication and Test Button on front face
- Operating temperature up to +70°C
- Mandatory to use OF-S auxiliary to add any indication or tripping auxiliary

[In] Rated Current (A)	Earth-Leakage Sensitivity (mA)	Module Width 18mm/module	2 Pole Reference	Unit MRP [₹]	Module Width 18mm/module	4 Pole Reference	Unit MRP [₹]
25	30	2	A9N16201	4560	4	A9N16251	6401
	100	2	A9N16203	5061	4	A9N16253	6802
	300	2	A9N16202	5215	4	A9N16252	7002
40	30	2	A9N16204	5367	4	A9N16254	6301
	100	2	A9N16205	5787	4	A9N16255	6840
	300	2	A9N16206	6069	4	A9N16256	7104
63	30	2	A9N16208	6463	4	A9N16258	7296
	100	2	A9N16209	6951	4	A9N16259	8081
	300	2	A9N16210	7091	4	A9N16260	8119
80	30	2	A9N16212	10866	4	A9N16261	12870
	100	2	A9N16213	11047	4	A9N16262	13077
	300	2	A9N16214	11253	4	A9N16263	13148

AC Residual Current Circuit Breakers (RCCBs) - ID



- Complies to standards IEC 61008-1 and VDE 0664
- AC Class protection
- Degree of pollution: 3 (suitable for industrial environment)
- Electrical ON/OFF indication by using OFSP auxiliary

Poles Description	[In] Rated Current (A)	Earth-Leakage Sensitivity (mA)	Module Width 18mm/module	Reference	Unit MRP [₹]
4P	100	30	4	**A9R11491	----
		100	4	**A9R12491	----
	125	30	4	16905	52673
		100	4	16906	51285
		300	4	16907	51524

Note: **For 100A RCCB Auxiliary kindly contact Customer Care

AC Residual Current Breaker Overload (RCBO) - DPN N Vigi



Suitable for
ComReady
Auxiliary



- Complies to standards IEC/EN 61009
- AC Class Protection; Tripping characteristics - C curve
- Overvoltage category (IEC 60364): IV
- Suitable for indication & tripping auxiliaries

Poles Description	[In] Rated Current (A)	Earth-Leakage Sensitivity (mA)	Module Width 18mm/module	Reference	Unit MRP [₹]
1P+N	6	30	2	A9N19661	7242
		300	2	A9N19681	7355
	10	30	2	A9N19663	7242
		300	2	A9N19683	7355
	16	30	2	A9N19665	7242
		300	2	A9N19685	7355
	20	30	2	A9N19666	7242
		300	2	A9N19686	7355
	25	30	2	A9N19667	7242
		300	2	A9N19687	7355
	32	30	2	A9N19668	7242
		300	2	A9N19688	7722
	40	30	2	A9N19669	9162
		300	2	A9N19689	9322

Note: Application specific RCDs also available with 10mA, 500mA and 1000mA sensitivities | Please contact nearest Schneider Electric Sales Office or Customer Care Center for Reference and Prices

Please contact Customer Care Center for Stockable and Non stockable status of references.

✓ NORMAL STOCK ITEMS

W.E.F. January 30th, 2023

SI Type Residual Current Circuit Breakers (RCCBs) - xID SI



- Complies to standard IEC/EN 61008-1
- SI RCDs offer enhanced immunity against Electrical Disturbances; Polluted and Corrosive environments - Guaranteed performance in harsh operating conditions
- Ensures continuity of supply in networks with:
 - Transient overvoltages
 - Loads generating HF leakage current i.e. harmonics
 - Loads generating continuous leakage current
- Ensures tripping on genuine earth fault in networks with:
 - Pulsating DC components
 - HF applications which "Blinds" (non-tripping) the conventional RCDs

[In] Rated Current (A)	Earth-Leakage Sensitivity (mA)	Module Width 18mm/module	2 Pole Reference	Unit MRP [₹]	Module Width 18mm/module	4 Pole Reference	Unit MRP [₹]
25	30	2	A9N16234	10609	4	A9N16321	11823
40	30	2	A9N16237	11143	4	A9N16324	12196
63	30	2	A9N16240	11463	4	A9N16327	12523
	300	2	A9N16246	11549	4	A9N16334	13028

Vigi Block for xC60 (Add-on RCD Module, 2 & 4 Pole)



- Flexibility to use MCB of any tripping curve to suit applications, ensuring best 3 in 1 protection
- No auxiliary supply required
- AC Class protection
- Degree of pollution: 3 (suitable for industrial environment)
- Immune to nuisance tripping due to transient over voltages

[In] Rated Current (A)	Earth-Leakage Sensitivity (mA)	Module Width 18mm/module	2 Pole Reference	Unit MRP [₹]	Module Width 18mm/module	4 Pole Reference	Unit MRP [₹]
25	30	1.5	A9N26581	7503	3	A9N26595	9009
	100	1.5	A9N26582	9543	3	A9N26596	9716
	300	1.5	A9N26583	10090	3	A9N26597	10456
63	30	2	A9N26611	10490	3.5	A9N26643	10530
	100	2	A9N26612	11109	3.5	A9N26644	10936
	300	2	A9N26613	11636	3.5	A9N26645	11442

Note: Vigi Block for High Rating up to 125A (C120) and High Breaking Capacity (NG125) available on demand

SI Type Residual Current Breaker Overload (RCBO) - DPN N Vigi SI



- Complies to standard IEC/EN 61009
- Ensures continuity of supply in networks with:
 - Transient overvoltages
 - Loads generating HF leakage current i.e. harmonics
 - Loads generating continuous leakage current
- Ensures tripping on genuine earth fault in networks with :
 - Pulsating DC components
 - HF applications which "Blinds" (non-tripping) the conventional RCDs

Poles Description	[In] Rated Current (A)	Earth-Leakage Sensitivity (mA)	Module Width 18mm/module	Reference	Unit MRP [₹]
1P+N	6	30	2	A9N19631	14417
		300	2	A9N19641	13997
	10	30	2	A9N19632	14417
		300	2	A9N19642	13989
	16	30	2	A9N19634	14417
		300	2	A9N19644	14417
	20	30	2	A9N19635	13997
		300	2	A9N19645	13997
	25	30	2	A9N19636	14417
		300	2	A9N19646	13997
	32	30	2	A9N19637	14417
		300	2	A9N19647	17158
	40	30	2	A9N19638	17070
		300	2	A9N19648	18996

*For Prices, please contact nearest Schneider Electric Sales Office or Customer Care Center are Center for Reference and Prices

*For prices, Please contact nearest Schneider Electric Sales Office or Customer Care Center and prices.

Please contact Customer Care Center for Stockable and Non stockable status of references.

NORMAL STOCK ITEMS

W.E.F. January 30th, 2023

Common Auxiliaries for xC60 / C120 / RCDs Range

- Field-fittable auxiliaries (clip fitted) mounted on left side with maximum width of 54mm
- Order: Tripping Auxiliaries (MN first) followed by Indication Auxiliaries (SD first)

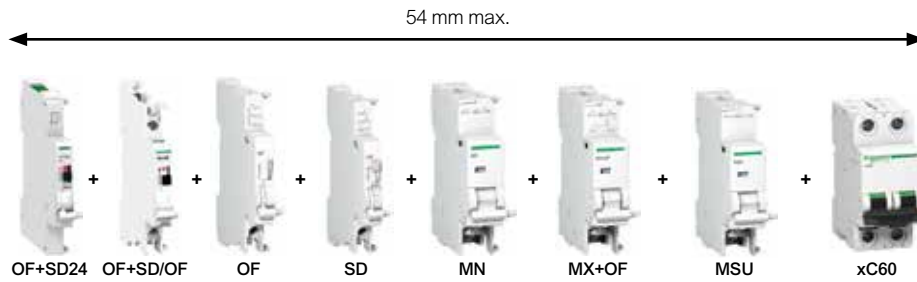

Type	Module Width 18mm/module	Reference	Unit MRP [₹]
Indication Auxiliaries			
OF Auxiliary Switch: for ON/OFF indications	0.5	A9N26924	1413
SD Alarm Switch: for Trip on fault indications	0.5	A9N26927	1660
OF + SD/OF Auxiliary switch	0.5	A9N26929	4407
OF+SD24 auxiliary contact (ComReady)	0.5	A9N26899	3694
Protection Auxiliaries – Trip Indication on front face			
MN Under-voltage Release 220-240V AC	1	A9N26960	5935
MSU Over-voltage Release 275V AC	1	A9N26500	7029
Tripping Auxiliaries – Trip Indication on front face			
MX + OF Shunt Release 110-415V AC: for Remote tripping of Circuit Breaker	1	A9N26946	3861
MX + OF Shunt Release 12-24V AC/DC: for Remote tripping of Circuit Breaker	1	A9N26948	3861
Auxiliary Switch for RCCBs – Mandatory for use of Auxiliaries with RCCBs			
Auxiliary switch for RCCB up to 80A (OF-S)	0.5	A9N26923	3664
Auxiliary switch for RCCBs 125A (OFSP)	0.5	16940	2785

Accessories



Type	Description	Reference	Unit MRP [₹]
Rotary Handle*	Breaker Switching Sub-Assembly	27046	6394
	Extended, Disconnectable handle	27047	3229
Padlock** (bag of 2)		26970	1256
Multicable terminal for 3 copper cables**		19096	10393
Aluminum cable terminal**		27060	752
Spacer		A9N27062	317

* for xC60, C120, DPN N Vigi, C60H-DC, xSW - Multi poles only

**for xC60, xID, DPN N Vigi, C60H-DC, xSW, C60PV-DC

Note: For all above Reference MOQ = 1

Please contact Customer Care Center for Stockable and Non stockable status of references.

NORMAL STOCK ITEMS

W.E.F. January 30th, 2023

Protection Against Lightning Strikes And Switching Surges



For all low voltage switchboards and electrical enclosures:

Comprehensive range

- To ensure the protection of equipment connected to:
- Low voltage networks,
- Telecommunications networks,
- Computer networks.
- Easy to implement and use.
- Compatibility with all earthing systems (TT, TNS, TNC, IT).
- Technical and aesthetic consistency

Continuity of service and certified safety

Schneider Electric certified coordination between the surge arrester and its disconnection circuit breaker.

Compliance with standards: IEC/EN 61643-11.



More and more electrical equipment today is sensitive to overvoltages caused by lightning.



90%

of power outlets supply equipment incorporating electronic devices.



iQuick PRD “built-in” technology surge arresters, a Schneider Electric innovation, incorporate their own disconnection circuit breaker: easy to choose and simple to install for greater effectiveness.



Up to **30%** of installation time saved.

Please contact Customer Care Center for Stockable and Non stockable status of references.

NORMAL STOCK ITEMS

W.E.F. January 30th, 2023

Surge Arresters - Type 1+ 2



- Complies to IEC 61643-1 and EN 61643-11
- Withdraw able type: Easy Replacement
- Inbuilt SPD health Indicator: Also available with remote signaling
- For protection against Direct lightning surge, Indirect lightning surge, Switching surge
- Iimp up to 25kA & Imax upto 40kA
- **Always use a Back-up MCB with your SPD**
- Maximum Operating Voltage [Uc]: 350V

Type	Pole Description	Module Width 18mm/module	Reference	Unit MRP [₹]
PRD1 25r	1P	2	16329	23208
	1P + N	4	16330	41658
	3P	6	16331	62471
	3P + N	8	16332	77618

Surge Arresters iPRD- Type 2 (Withdrawable type) (TT, TN-S, TN-C Systems)



- In conformance with standards IEC 61643-11/2011 T2 and EN 61643-11 Type 2
- For protection against Indirect lightning surge and Switching surge
- Inbuilt health Indicator
- Response time < 25ns
- Imax (8/20 s): 65/40/15/8kA
- Maximum Operating Voltage [Uc]: 340V
- Level of protection,Up: 1.0 - 2.0 kV
- Remote indication contact with 8r/20r/40r/65r
- **Always use a Back-up MCB with your SPD**

Type	Rated Voltage (V)	Pole Description	Module Width 18mm/module	Reference	Unit MRP [₹]
iPRD8	230	1P	1	A9L08100	5574
	230	1P+N	2	A9L08500	10631
	230/400	3P	3	A9L08300	14349
	230/400	3P+N	4	A9L08600	21659
iPRD8r	230	1P+N	2	A9L08501	12745
	230/400	3P+N	4	A9L08601	25991
	230	1P	1	A9L20100	6372
iPRD20	230	1P+N	2	A9L20500	13365
	230/400	3P	3	A9L20300	17108
	230/400	3P+N	4	A9L20600	24187
iPRD20r	230	1P+N	2	A9L20501	15582
	230/400	3P+N	4	A9L20601	29575
	230	1P	1	A9L40100	7534
iPRD40	230	1P+N	2	A9L40500	15392
	230/400	3P	3	A9L40300	22094
	230/400	3P+N	4	A9L40600	30809
iPRD40r	230	1P	1	A9L40101	8857
	230	1P+N	2	A9L40501	19843
	230/400	3P	3	A9L40301	29733
iPRD65r	230/400	3P+N	4	A9L40601	36977
	230	1P	1	A9L65101	11841
	230	1P+N	2	A9L65501	25290
iPRD65r	230/400	3P	3	A9L65301	33002
	230/400	3P+N	4	A9L65601	42822

Spare Cartridges for iPRD



- Spare Cartridges for iPRD8r, iPRD20r, iPRD40r and iPRD65r
- End of life indication available on front face
- These Cartridges are not compatible with Old SPD range (A9L16...)**

Type	Spare Cartridges for	Reference	Unit MRP [₹]
iPRD 65-350	iPRD65r	A9L65102	7561
iPRD 40-350	iPRD40, iPRD40r	A9L40102	5817
iPRD 20-350	iPRD20, iPRD20r	A9L20102	4662
iPRD 8-350	iPRD8, iPRD8r	A9L08102	4081
iPRD Neutral	All products (1P+N, 3P+N)	A9L00002	6121

**Spare Cartridges for Old SPD Range (A9L16...) are available on demand - please contact nearest Schneider Electric Sales Office or Customer Care for Reference and prices

Note: Note: For all above Reference MOQ = 1

Please contact Customer Care Center for Stockable and Non stockable status of references.

NORMAL STOCK ITEMS

W.E.F. January 30th, 2023

iQuick PRD - Type 2 with inbuilt MCB



- Compact SPD with in-built back up MCB - saving on space, MCB selection, wiring time
- Compliance to EN 61643-11
- Withdrawable Type - Cost Efficient - Allows damaged Cartridges to be replaced without having to replace entire SPD
- Inbuilt SPD Health Indicator on front face of device; Remote signaling functionality also available
- Incoming Protection: iQuick PRD 40r (High Risk level) and iQuick PRD 20r (Moderate Risk level)
- Secondary Protection: iQuick PRD 8r is cascade mounted with incoming surge arresters

Type	Pole Description	Module Width 18mm/module	Reference	Unit MRP [₹]
iQuick PRD 8r	1P+N	4	A9L16298	16330
	3P	6.5	A9L16299	23322
	3P+N	7.5	A9L16300	29020
iQuick PRD 20r	1P+N	4	A9L16295	18670
	3P	6.5	A9L16296	27997
	3P+N	7.5	A9L16297	34825
Quick PRD 40r	1P+N	4	A9L16292	22240
	3P	6.5	A9L16293	33319
	3P+N	7.5	A9L16294	41408

Note: Spare / Replacement Cartridges available - For Reference and prices contact nearest sales office or customer care

Photovoltaic surge arresters



- Protection for photovoltaic panels and the DC input to the inverter from overvoltages due to a lightning strike
- Type 2 surge arresters
- Should be installed in switchboard inside the building. If switchboard is located outside, it must be weatherproof
- Withdrawable surge arrester allows damaged Cartridges to be replaced quickly
- Inbuilt SPD Health Indicator on front face of device; Remote signaling functionality also available

Type	U (cqv) Maximum Operating Voltage (V)	Module Width 18mm/module	Reference	Unit MRP [₹]
iPRD 40r	800	3	A9L40271	12416
	1000	3	A9L40281	14474

Note: Spare / Replacement Cartridges available - For Reference and prices contact nearest sales office or customer care

Surge Arresters for Communication Networks



- Analogue telephone line protection: iPRC surge arrester wired in series to the private installation input, protects the telephones, the modems (including ADSL) etc
- Protection for 2 low-current lines without common potential or 4 lines with common reference potential
- iPRI protects measuring instrument and PLC sensor inputs and the DC power supply inputs up to 53 V and AC power supply inputs up to 37 V

Type	[Ue] Operational Voltage (V)	Module Width 18mm/module	Reference	Unit MRP [₹]
PRI	48 V DC	1	A9L16339	22589
PRC	130 V AC	1	A9L16337	13543

Note: For all above Reference MOQ = 1

Please contact Customer Care Center for Stockable and Non stockable status of references.

NORMAL STOCK ITEMS

W.E.F. January 30th, 2023

Isolator - xSW



- Complies to IEC/EN 60947-3
- Switching duty: AC-22
- Impulse voltage: 6kV
- DC application: 48V (110V with 2 poles in series)
- Short circuit withstand 20 In for 1 second
- Upto 80A Bi connect terminals & 100A to 125A with mono connect terminals

Poles Description	[In] Rated Current (A)	Module Width 18mm/module	MOQ	Reference	Unit MRP [₹]
2	40	2	6	A9S2P040	863
	63	2	6	A9S2P063	1140
	80	2	6	A9S2P080	1339
	100	2	6	A9S2P100	1938
	125	2	6	A9S2P125	2173
3	40	3	4	A9S3P040	1508
	63	3	4	A9S3P063	1766
4	40	4	3	A9S4P040	1909
	63	4	3	A9S4P063	2078
	80	4	3	A9S4P080	2702
	100	4	3	A9S4P100	3476
	125	4	3	A9S4P125	3842

Selector Switch - iSSW



- Complies to IEC 60947-5-1 and IEC 60669-1
- Rating 20A, 250V AC
- Electrical life (AC22): 30,000 cycles
- Connection: tunnel terminals cables up to 10 sq. mm

No. of positions	Poles Description	Contacts	Module Width 18mm/module	MOQ	Reference	Unit MRP [₹]
2	1	1 C/O	1	12	A9E18070	1846
	2	2 C/O	2	6	A9E18071	2538
		1NO + 1NC	1	12	A9E18072	1479
3	1	1 C/O	1	12	A9E18073	1779
	2	2 C/O	2	6	A9E18074	3062

iRO Buzzers



- Audible indication in housing and the tertiary sector
- Sound level of 70dBA at a distance of 60cm

Voltage	Module Width 18mm/module	Reference	Unit MRP [₹]
230V AC	1	A9A15322	2292
8..12V AC	1	A9A15323	1224

Please contact Customer Care Center for Stockable and Non stockable status of references.

NORMAL STOCK ITEMS

W.E.F. January 30th, 2023

iCT Contactors



- Complies with standards IEC 1095, E N 61095
- 4 operating modes switch on front face :
 - Automatic mode
 - Temporary "ON" mode
 - Permanent "ON" mode
 - Shutdown
- Mechanical contact position Indicator
- Safe installation maintenance: lock the contactor in ON position
- Silent operation (20dB) for entire range

Type	Rating (A)	No. of Contacts	Module Width 18mm/module	Reference	Unit MRP [₹]
1P	25	1NO	1	A9C20731	2720
	16	2NO	1	A9C22712	2800
2P	25	2NO	1	A9C20732	3348
	40	2NO	2	A9C20842	6822
	63	2NO	2	A9C20862	7317
3P	25	3NO	2	A9C20833	4313
	40	3NO	2	A9C20843	9576
	63	3NO	3	A9C20863	10407
4P	25	4NO	2	A9C20834	4517
	40	4NO	2	A9C20844	11153
	63	4NO	3	A9C20864	11767
	63	2NO + 2NC	3	A9C20868	13108

Note: 100A Contactor in 2P / 4P - available on request

iTL Impulse Relays



- Complies with standards IEC/EN 60669-2-2
- Safe maintenance: disconnection of remote control by selector switch
- Manual Controls on front face: 0-I toggle
- Mechanical contact position Indicator
- Maximum 5 operations/min. and 100 switching operations/day
- Degree of pollution: 3 (suitable for industrial environment)

Type	Rating (A)	Control Voltage	No. of Contacts	Module Width	Reference	Unit MRP [₹]
1P	16	230-240 VAC	1NO	1	A9C30811	1764
	32	230-240 VAC	1NO	1	A9C30831	2220
2P	16	230-240 VAC	2NO	1	A9C30812	2892
	32	230-240 VAC	2NO	1	A9C30831 + A9C32836	6771
3P	16	230-240 VAC	1NO+1NO/NC+1NO	2	A9C30811 + A9C32816	5415
	32	230-240 VAC	1NO+1NO/NC+1NO	2	A9C30831 + 2* x A9C32836	11322
4P	16	230-240 VAC	4NO	2	A9C30814	5871
	32	230-240 VAC	4NO	2	A9C30831 + 3* x A9C32836	15873

iIL Indicator Lights



- Complies with standard IEC 60947-5-1
- Indicator light with LED technology
- Service life 100,000 hours with constant luminous efficiency

Type	Colour	Module Width 18mm/module	Reference	Unit MRP [₹]
Single Indicator light	Red	1	A9E18320	1824
	Green	1	A9E18321	1824
	Blue	1	A9E18323	1824
	Orange	1	A9E18324	1824
3 phase voltage presence light	Red/Red/Red	1	A9E18327	5269
Single Push Button (1 NO+ 1NC)	Grey	1	A9E18033	2456

Note: For all above Reference MOQ = 1

Please contact Customer Care Center for Stockable and Non stockable status of references.

NORMAL STOCK ITEMS

W.E.F. January 30th, 2023

Smartlink



- Compliance to IEC/EN 61131-2
- Protection Monitoring – Device Status and alarm notifications
- Load Control / Switching through Contactors and Impulse Relays
- Energy Monitoring through pulse meters
- Alarm over email and analog sensors (temperature / humidity) with Smartlink Ethernet
- Plug & Play – Pre fabricated cables and in built web pages
- Rated Voltage: 24V DC

Description	Reference	Unit MRP [₹]
Wiser Energy Module IP	EER31800	29980

Communication Auxiliaries



Auxiliary for Protection Devices (OF+SD24)

Auxiliary for Contactors (iACT24)

Auxiliary for Impulse Relays (iATL24)

Description	Module Width	Reference	Unit MRP [₹]
OF+SD24	0.5	A9N26899	3694
iACT24	1	A9C15924	17842
iATL24	1	A9C15424	18787

Acti 9

Description	Reference	Pack	Unit MRP [₹]
Distribloc 63A			
Distribution from the top (4 Module)	04040	1	15571
Distribution through the bottom (4 Module)	04041	1	15571

Reflex iC60 - Integrated Control & Overcurrent Protection Device



- All in One Solution: MCB + Contactor + Impulse Relay + Auxiliary
- 10kA Breaking capacity as per IEC/EN 60947-2,
- Ti24 interface: Connection to PLC, Smartlink
- 3 operating modes to cater to a variety of applications
- Safe lock down with Integrated Padlocking
- Simplified maintenance: Front face Indicator allows better reliability

[In] Rated Current (A)	2 Pole Reference	Unit MRP [₹]	3 Pole Reference	Unit MRP [₹]	4 Pole Reference	Unit MRP [₹]
Module Width **	4.5 mod		5.5 mod		6.5 mod	
B Curve						
10	A9C61210	49082	A9C61310	51257	A9C61410	56047
16	A9C61216	49076	A9C61316	51257	A9C61416	54948
25	A9C61225	49076	A9C61325	51257	A9C61425	54948
40	A9C61240	50701	A9C61340	54818	A9C61440	58347
63	A9C61263	53926	A9C61363	56954	A9C61463	61661
C Curve						
10	A9C62210	49632	A9C62310	52825	A9C62410	56074
16	A9C62216	49632	A9C62316	53887	A9C62416	56074
25	A9C62225	49626	A9C62325	52825	A9C62425	56074
40	A9C62240	52268	A9C62340	54844	A9C62440	58385
63	A9C62263	55077	A9C62363	56954	A9C62463	62899
D Curve						
10	A9C63210	50752	A9C63310	53898	A9C63410	58327
16	A9C63216	50752	A9C63316	53898	A9C63416	58327
25	A9C63225	50752	A9C63325	53898	A9C63425	58327

Note: **18mm/module

Please contact Customer Care Center for Stockable and Non stockable status of references.

NORMAL STOCK ITEMS

W.E.F. January 30th, 2023

Isobar Distribution System

EcoStruxure™ Innovation At Every Level

From sensors to services, our Innovation At Every Level approach improves energy and operational efficiency by tapping the true business value of IoT advancements. We've made mobility, sensing, cloud, analytics, and cyber security technologies meaningful to customers, helping them compete in our IoT economy.

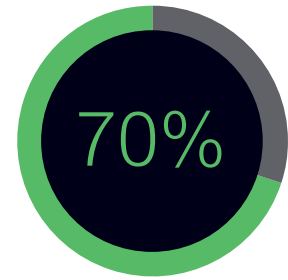

70%
of decision-makers
see the business
value of IoT*

*Schneider Electric IoT 2020
Business Report

Connected Products:

The Internet of Things starts with the best things. Our IoT-enabled best-in-class connected products include breakers, drives, UPSs, relays, sensors, and more. Devices with embedded intelligence drive better decision-making throughout operations.

Edge Control:

Mission-critical scenarios can be unpredictable, so control of devices at the edge of the IoT network is a must. This essential capability provides real-time solutions that enable local control at the edge, protecting safety and uptime.

Applications, Analytics, and Services:

Interoperability is imperative to supporting the diverse hardware and systems in building, data center, industry, and grid end markets. EcoStruxure™ enables a breadth of agnostic applications, analytics, and services for seamless enterprise integration.

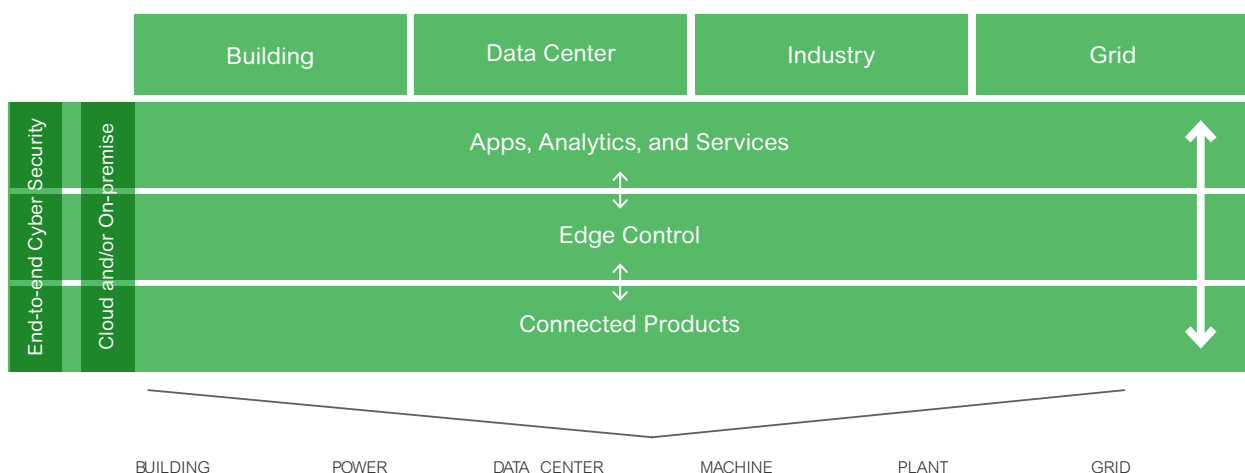

Please contact Customer Care Center for Stockable and Non stockable status of references.

NORMAL STOCK ITEMS

W.E.F. January 30th, 2023

Connectivity built in

Acti9 Isobar harnesses the connectivity of the Acti9 range enabling distribution boards to become smart and connected.



1. Enable asset management on all outgoing ways with **PowerTag**



2. **Smartlink SiD** for wireless data concentration



3. Enable further asset and energy management through PowerTag for Compact NSX



4. Monitor and control your assets with SiB Smartlink



5. See the power and optimise the use of your assets with Facility Expert our simple on-line services platform



Please contact Customer Care Center for Stockable and Non stockable status of references.

NORMAL STOCK ITEMS

W.E.F. January 30th, 2023

Acti 9

Isobar Pan Assembly

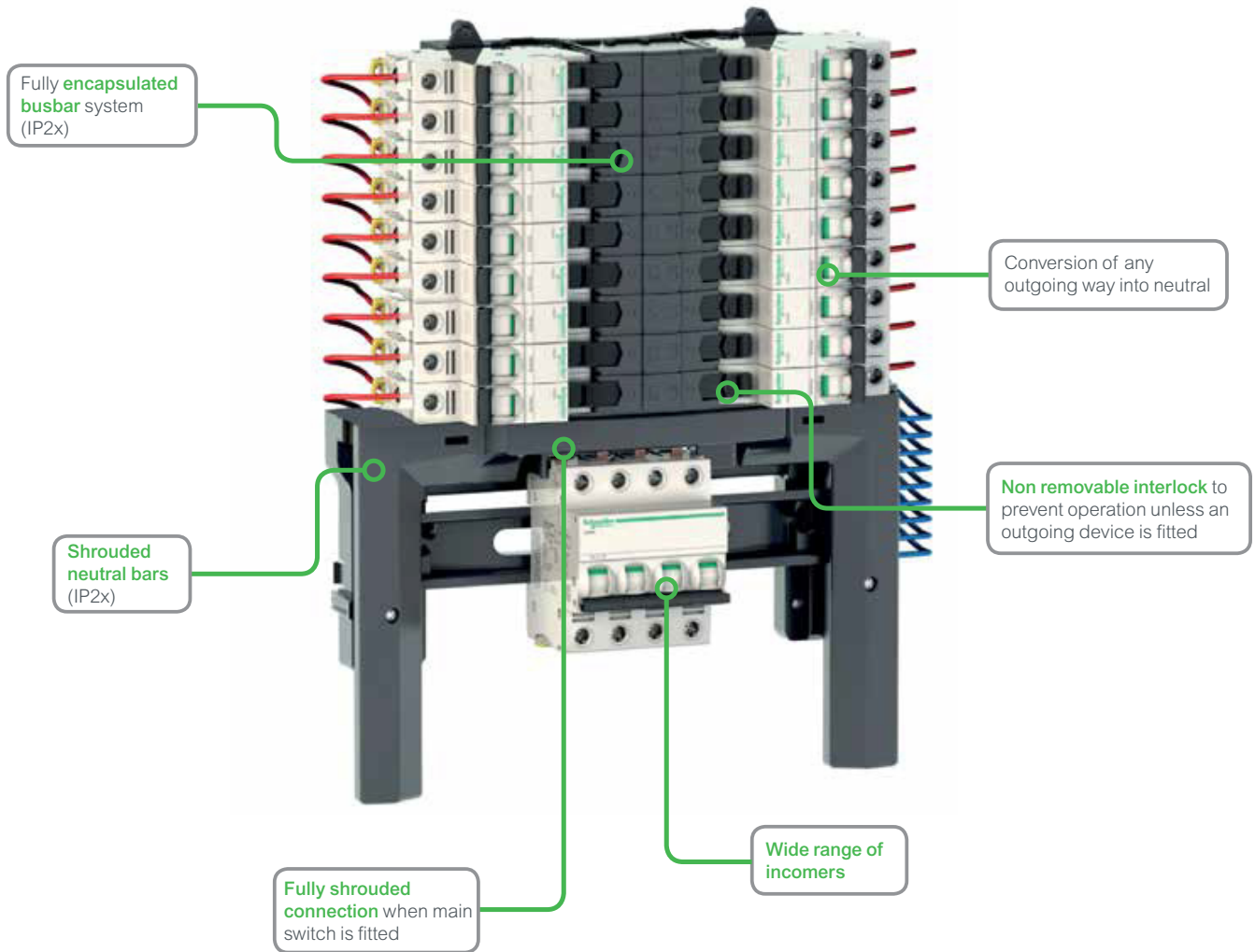

- Fully type tested conditional short circuit rating of 25kA to BS EN 61439-3
- High performance MCB 10kA BS EN 60898 15kA BS EN 60947-2 in B, C or D curve 1, 2, 3, 4 pole
- 250A busbar rating
- Isobar disconnection to BS EN 60947-3 ensuring unused outgoing ways are isolated
- Option of switching outgoing neutral on all boards using distributed neutral kit
- Range of incomers: switch disconnectors, residual current devices, terminal blocks, mccb
- Single pole RCBO for new or retrofit maintaining device density
- Full range of device accessories and auxiliaries
- Shrouded Neutral
- Convention of any outgoing way into Neutral

Description	Double Door Metal (IP43) Reference	Unit LP [₹]
Acti9 Isobar B - pan assembly - 16 ways TP + earth + neutral	SEA9BN16PEV	*
Acti9 Isobar B - pan assembly - 18 ways TP + earth + neutral	SEA9BN18PEV	*
Acti9 Isobar B - pan assembly - 24 ways TP + earth + neutral	SEA9BN24PEV	*
Acti 9 - 1P blank terminal block (no electrical connection)	SEA9BP	*
Isobar B - neutral bar - 1N - for distribution board - 16 ways	SEA9NB16	*
Isobar B - neutral bar - 1N - for distribution board - 18 ways	SEA9NB18	*
Isobar B - neutral bar - 1N - for distribution board - 24 ways	SEA9NB24	*
Isobar A - neutral bar - 1N - for distribution board - 4 ways SP+N	SEA9NKIT	*
Acti 9 - terminal block - 250A	SEA9NPB250TB	*
Acti 9 Isobar B - MCCB/Interpact connection kit	SEA9BINCKIT	*

* - Price on Request

Please contact Schneider Electric Customer Care Center for Prices

NORMAL STOCK ITEMS

W.E.F. January 30th, 2023

Acti 9

Distribution Boards

Spectacular Design

Blends seamlessly with interiors



Unique Rounded Corners | Color - RAL 9003 white | Designer Rotary Knob

Maximized Wiring Space

Convenient and Safe wiring

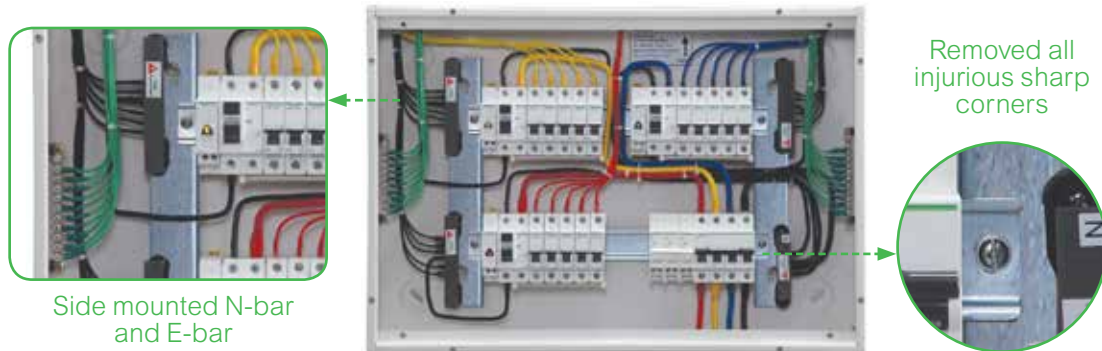

Side mounted N-bar and E-bar

Removed all injurious sharp corners

15% more wiring area | Reduced U-box Collar | Removable Frame, Centre plate & Gland plate

Adaptable

Total Flexibility for ease of installation and usage

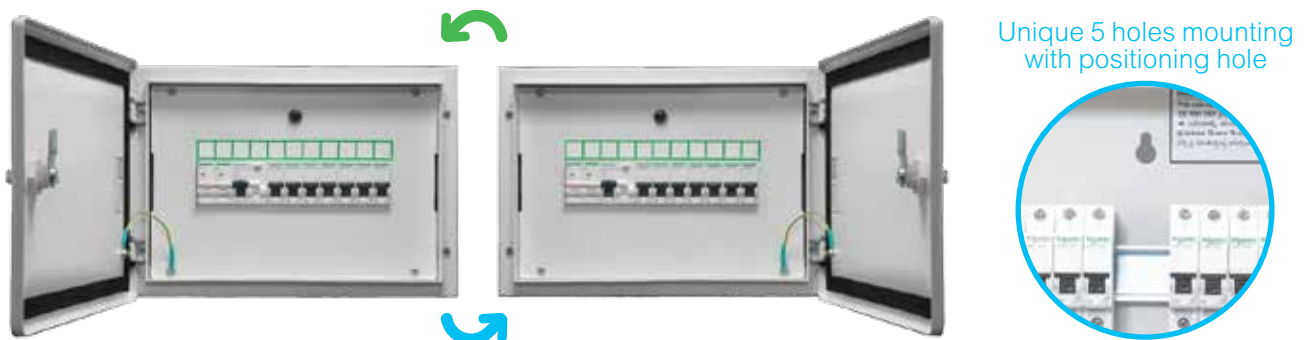

Unique 5 holes mounting with positioning hole

Surface and Flush installation | Field fittable key lock provision | Reversible Door

Inspiring the **S.M.A.R.T.** choice!!!

Robust Architecture

Perfect blend of Strength & Weight



High Strength-to-Weight ratio | RoHS and REACH Compliance – ideal solution for GREEN Buildings

NEW

Base Material used - Galvanized Iron

4X Rust Resistance



1. Powder Coating
- 2. Galvanized Iron**
3. Base Iron

Galvanized Iron | Gives 4X rust resistance
No Rusting | Even if the powder coating is scratched
No Propagation Of Rust | Even If base material is chipped off
No Hassle | of repainting due to rusting

Inspiring the **S.M.A.R.T.** choice!!!

Technically Proven

Safety Guaranteed



Designed and Manufactured as per **IS 8623 - 1 & 3** | IP and IK test by ERDA & CPRI | Glow wire tested

Type Tested as per IEC 61439 - 1 & 3

NEW



IEC 61439 - 3* Fully Compliant

*Tested at **NABL** and **ASTA** accredited testing facility



Salt Spray



IP43



IK09



Reliable Door



Earthing



Temp@
Max Curr

Mechanical Tests

Electrical Tests

Please contact Customer Care Center for Stockable and Non stockable status of references.

NORMAL STOCK ITEMS

W.E.F. January 30th, 2023

Acti 9

Distribution Boards

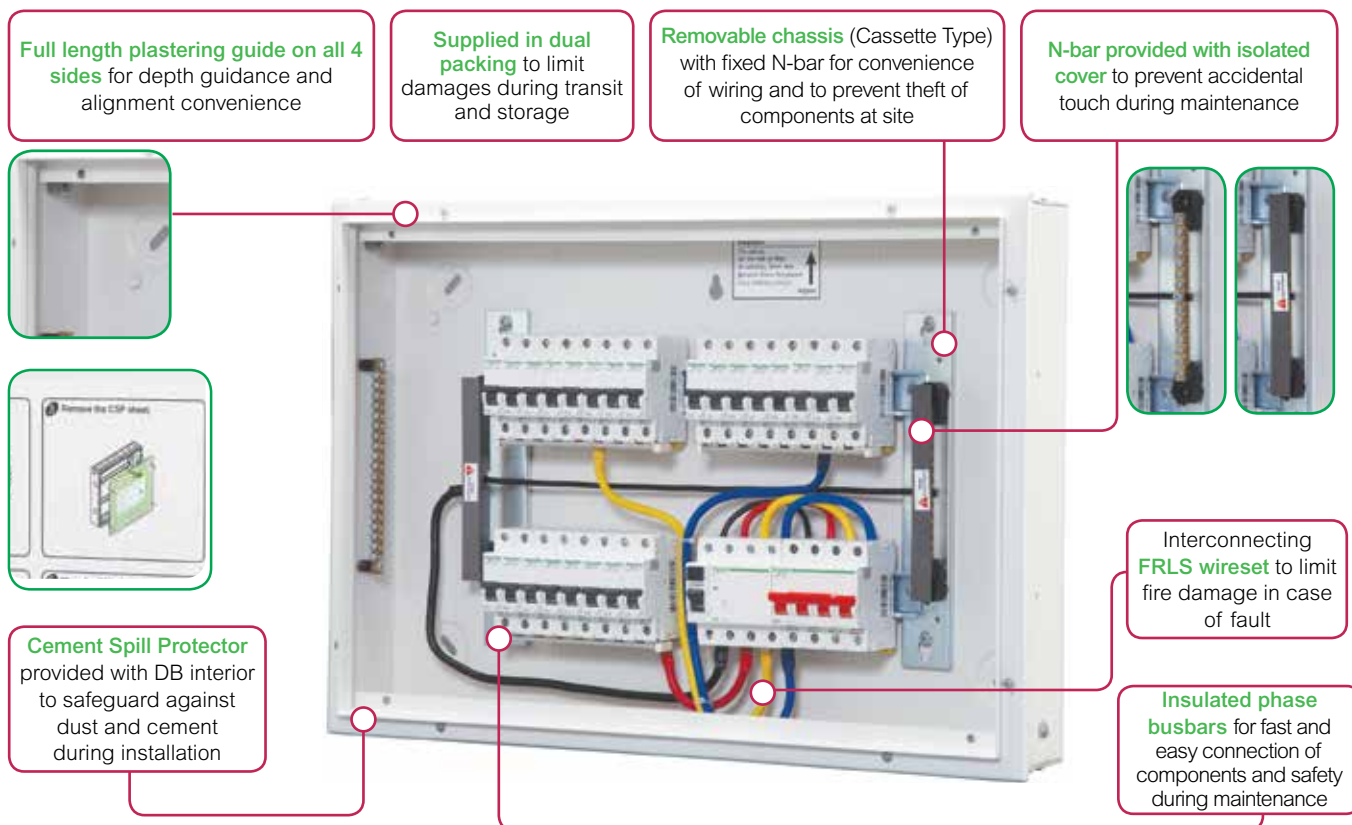
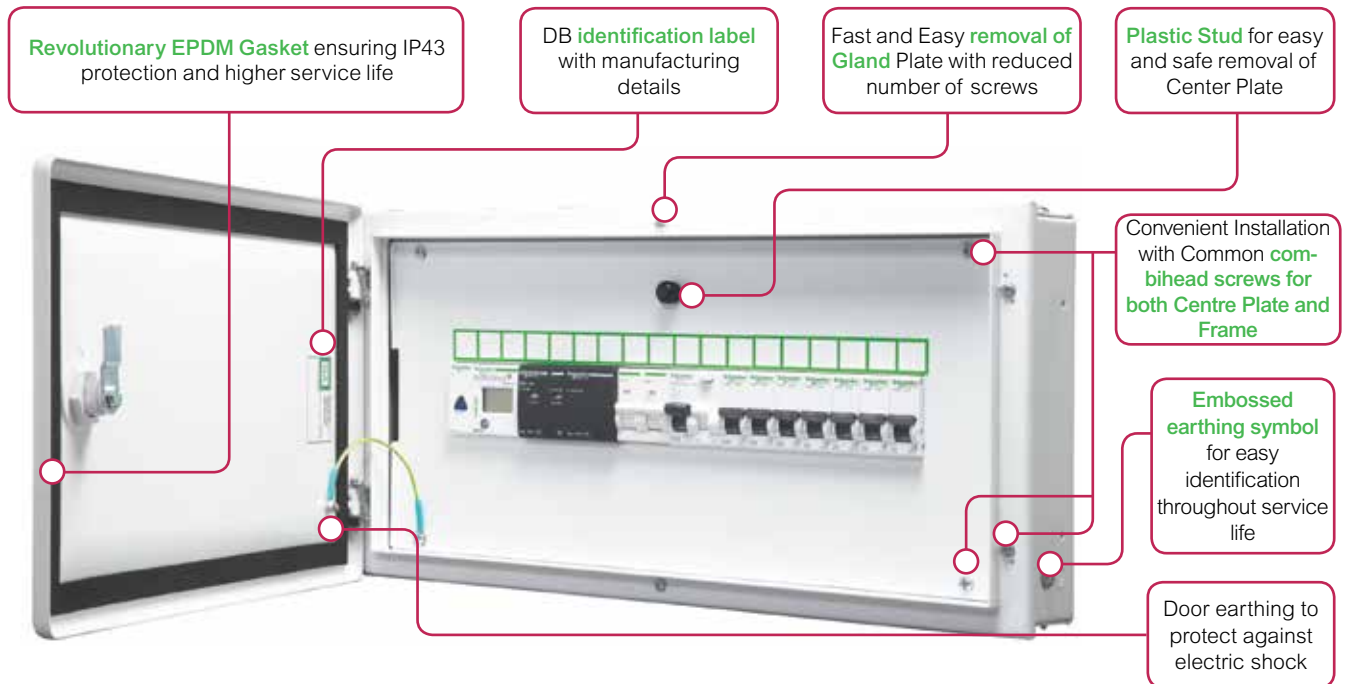

Please contact Customer Care Center for Stockable and Non stockable status of references.

NORMAL STOCK ITEMS

W.E.F. January 30th, 2023

Metal Enclosures



- Metal Enclosure to mount individual Modular Device feeding directly to the load or final distribution board

Description	Total Module Cutout	Single Door (IP30) Reference	Unit MRP [₹]
2 way	1 / 2	A9HMES02 <input checked="" type="checkbox"/>	1039
4 way	3 / 4	A9HMES04 <input checked="" type="checkbox"/>	1039

SPN DBs



- SPN DB for distribution of Single Phase Neutral supply to respective load MCBs
- Incomer - DP RCCB/RCBO/Isolator/MCB
- Outgoing - SP MCBs

Description	Total Module Cutout (Incomer + Outgoing)	Single Door (IP30) Reference	Unit MRP [₹]	Double Door Metal (IP43) Reference	Unit MRP [₹]
6 way	6	A9HSNS06	2013	A9HSND06 <input checked="" type="checkbox"/>	2892
8 way	8	A9HSNS08 <input checked="" type="checkbox"/>	2387	A9HSND08 <input checked="" type="checkbox"/>	3152
12 way	12	A9HSNS12	2825	A9HSND12 <input checked="" type="checkbox"/>	3790
18 way	18	A9HSNS18	3884	A9HSND18 <input checked="" type="checkbox"/>	5078

TPN DBs



- Standard TPN DBs for distribution of Three Phase and Neutral supply
- Incomer - FP RCCB/RCBO/Isolator/MCB
- Outgoing - SP MCBs
- TPN DBs can be converted to PPI DB using 'PPI Kit' provided on next page

Description	Total Module Cutout (Incomer + Outgoing)	Single Door (IP30) Reference	Unit MRP [₹]	Double Door Metal (IP43) Reference	Unit MRP [₹]
4 way eco	4 + 12	-	-	A9HTND04E <input checked="" type="checkbox"/>	7544
4 way	8 + 12	A9HTNS04	5771	A9HTND04 <input checked="" type="checkbox"/>	7609
6 way	8 + 18	A9HTNS06	-	A9HTND06 <input checked="" type="checkbox"/>	7722
8 way	8 + 24	A9HTNS08	7868	A9HTND08 <input checked="" type="checkbox"/>	9522
12 way	8 + 36	A9HTNS12	11858	A9HTND12 <input checked="" type="checkbox"/>	14538

Flexi Tier DBs



- Flexi DBs give total flexibility to mount any type and size of Modular devices as per load requirement
- Provided with N-Bar and E-Bar
- Flexi Tier DBs can be converted to PPI DB using 'PPI Kit' provided on next page

Description	Total Module Cutout (Incomer + Outgoing)	Single Door (IP30) Reference	Unit MRP [₹]	Double Door Metal (IP43) Reference	Unit MRP [₹]
2 Tier 24 Modules	2 x 12	-	-	A9HFD224	8155
3 Tier 36 Modules	3 x 12	-	-	A9HFD336	9794
4 Tier 40 Modules	4 x 10	-	-	A9HFD440 <input checked="" type="checkbox"/>	10346
4 Tier 56 Modules	4 x 14	-	-	A9HFD456 <input checked="" type="checkbox"/>	10814

Note: For all above Reference MOQ = 1

Please contact Customer Care Center for Stockable and Non stockable status of references.

NORMAL STOCK ITEMS

W.E.F. January 30th, 2023

Acti 9

Distribution Boards

New Phase Segregated DBs

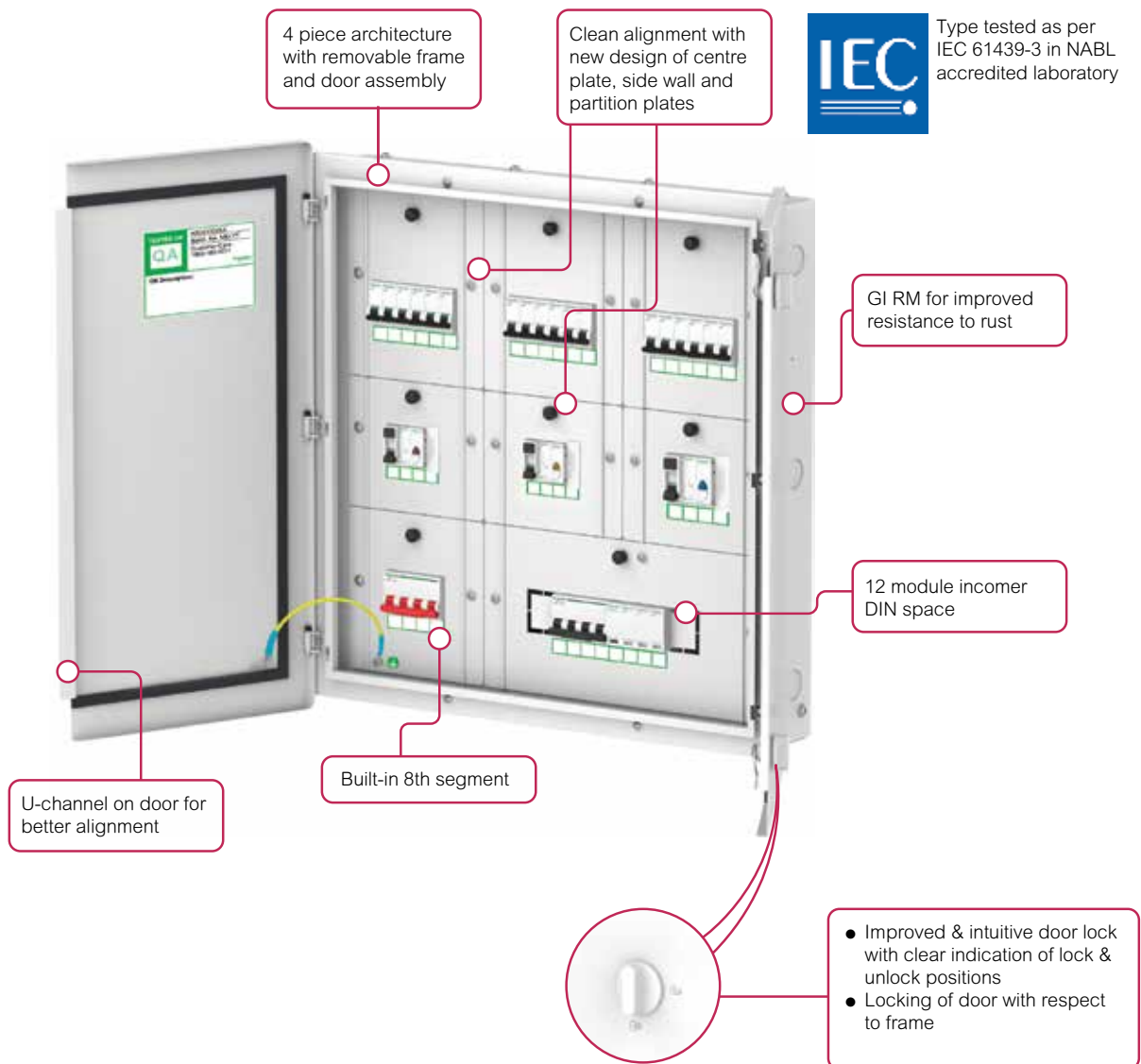

Key highlights

- 1 New compact design
- 2 Robust architecture
- 3 Type-tested system
- 4 4 piece construction
- 5 Built-in 8th segment
- 6 Split door for all variants
- 7 Clean alignment of doors, centerplates
- 8 Improved door locking
- 9 High rust resistance with GI
- 10 Increased incomer DIN space

Please Contact nearest Schneider Electric Sales Office and Customer Care Center for your reference.

Please contact Customer Care Center for Stockable and Non stockable status of references.

NORMAL STOCK ITEMS

W.E.F. January 30th, 2023

Per Phase Isolation DBs

- PPI DBs to mount DP Residual Current Device (RCD) at an individual phase level to isolate the faulty phase in case of earth leakage and ensure continuity of supply to other healthy phases
- Incomer - Modular (FP MCB/Isolator) using PPI Kit / MCCB100A (TP/FP Compact NSX or EasyPact CVS)
- Sub-Incomer - DP RCCB/RCBO
- Outgoing - SP MCBs

Description	Total Module Cutout (Incomer + Outgoing)	Single Door (IP30) Reference	Unit MRP [₹]	Double Door Metal (IP43) Reference	Unit MRP [₹]
12 way	100A MCCB + 6 + 30	-	-	A9HPID12M	21565

PPI TPN DB



- Set of accessories to convert TPN DBs and 4 tier Flexi DBs to PPI DB
- Kit is provided with additional required quantity of N-Bar, wire set, Busbars (only for Flexi Tier) and Mounting Kit (only for TPN)

Description	Total Module Cutout (no. of rows x No. of modules per row)	Double Door Metal (IP43)	No of Ways	Unit MRP [₹]
6 Way TPN PPI DB	8 + 2 x 3 + 4 x 3	A9HTPI06	6 Ways	9750
8 Way TPN PPI DB	8 + 2 x 3 + 6 x 3	A9HTPI08	8 Ways	11310
12 Way TPN PPI DB	8 + 2 x 3 + 10 x 3	A9HTPI12	12 Ways	15560

PPI Flexi Tier DB

Description	Total Module Cutout (no. of rows x No. of modules per row)	Double Door Metal (IP43)	No of Ways	Unit MRP [₹]
4T40M Flexi PPI DB	4 x 10	A9HFPI10	10	15100
4T56M Flexi PPI DB	4 x 14	A9HFPI14	14	17000

Phase Segregated DBs



- Phase Segregated DBs to provide total safety for installer and maintenance personnel, by compartmentalizing each Phase and separating Incomer, Sub-Incomer and Outgoing
- Offers better continuity of supply in case of faults during maintenance at DB level.
- Incomer - Modular (FP MCB/Isolator) / MCCB 100A (TP/FP during maintenance Compact NSX or EasyPact CVS)
- Sub-Incomer - DP RCCB/RCBO
- Outgoing - SP MCBs
- GI sheet ensures improved rust resistance
- Type-tested system conforming IEC 61439-3
- Built-in 8th segment (for modular incomer only)
- Increased incomer DIN space of 12M for 6 ways to 12 ways
- Split door for all variants
- New design ensures clean alignment of doors, centerplates
- 4 piece architecture with removable frame
- Improved, intuitive door lock design with clear indication of lock and unlock positions

Description	Total Module Cutout (Incomer + Sub-incomer + Outgoing)	Double Door Metal (IP43) Reference	Unit MRP [₹]
4 way	8 + 12 + 12+4	A9HPSG06	16936
6 way	8 + 12 + 18+4	A9HPSG06	16936
8 way	8 + 12 + 24+4	A9HPSG08	18910
12 way	8 + 12 + 36+4	A9HPSG12	23739
12 way with MCCB I/c	100A MCCB + 12 + 36	A9HPSG12M	32033

Note: For all above Reference MOQ = 1

Please contact Customer Care Center for Stockable and Non stockable status of references.

NORMAL STOCK ITEMS

W.E.F. January 30th, 2023

VTPN DBs for Modular Incomer



- Ideal solution to distribute power supply to both 3 Phase and 1 Phase loads in the same DB
- Incomer - FP RCCB / RCBO / Isolator / MCB
- Outgoing - SP MCBs / TP MCBs
- 65% more Incomer Wiring Space.
- New Compact Fishbone with better Thermal Performance
- Short Circuit Withstand – 17 kA for 250mS (100 A)/ 25 kA (250 A) for 500mS
- Secure Connections with Fixed Spreader links
- IP 2X protection at Incomer with new shrouds
- Type tested as per IEC 61439 – 3 in NABL accredited Lab
- Knockout size for Incomer increased to 50mm (to accommodate Aluminium Cable)

Description	Total Module Cutout (Incomer + Outgoing)	Double Door Metal (IP43) Reference	No of Ways	Unit MRP [₹]
Acti9 VTPN DB 4 Ways Modular i-c 63A	12 + 12	A9HVM04	4 Ways	14,310
Acti9 VTPN DB 8 Ways Modular i-c 63A	12 + 24	A9HVM08	8 Ways	18,210
Acti9 VTPN DB 12 Ways Modular i-c 63A	12 + 36	A9HVM12	12 Ways	24,360

VTPN DBs for MCCB Incomer



- DBs for higher incoming current distribution up to 250A
- Incomer - TP/FP Compact NSX or EasyPact CVS MCCB up to 250A
- Outgoing - SP MCBs / TP MCBs
- 65% more Incomer Wiring Space.
- New Compact Fishbone with better Thermal Performance
- Short Circuit Withstand – 17 kA for 250mS (100 A)/ 25 kA (250 A) for 500mS
- Secure Connections with Fixed Spreader links
- IP 2X protection at Incomer with new shrouds
- Type tested as per IEC 61439 – 3 in NABL accredited Lab
- Knockout size for Incomer increased to 50mm (to accommodate Aluminium Cable)

Description	Total Module Cutout (Incomer + Outgoing)	Double Door Metal (IP43) Reference	No of Ways	Unit MRP [₹]
Acti9 VTPN DB 4 Ways MCCB i-c 100A	100 A MCCB + 12	A9HVN04L	4 Ways	15,670
Acti9 VTPN DB 4 Ways MCCB i-c 160A	160 A MCCB + 12	A9HVN04M	4 Ways	17,250
Acti9 VTPN DB 8 Ways MCCB i-c 100A	100 A MCCB + 24	A9HVN08L	8 Ways	19,860
Acti9 VTPN DB 8 Ways MCCB i-c 160A	160 A MCCB + 24	A9HVN08M	8 Ways	21,490
Acti9 VTPN DB 8 Ways MCCB i-c 250A	250 A MCCB + 24	A9HVN08H	8 Ways	27,550
Acti9 VTPN DB 12 Ways MCCB i-c 100A	100 A MCCB + 36	A9HVN12L	12 Ways	26,400
Acti9 VTPN DB 12 Ways MCCB i-c 160A	160 A MCCB + 36	A9HVN12M	12 Ways	28,680
Acti9 VTPN DB 12 Ways MCCB i-c 250A	250 A MCCB + 36	A9HVN12H	12 Ways	32,590

Mivan Compatible DB SPN DBs

Description	Total Module Cutout (Incomer + Outgoing)	Double Door Metal (IP43) Reference	No of Ways	Unit MRP [₹]
Acti9 DB 6 way SPN DD 1.6mm	2 + 4	A9HSND06Z	6 Ways	On Request
Acti9 DB 8 way SPN DD 1.6mm	2 + 6	A9HSND08Z	8 Ways	On Request
Acti9 DB 12 way SPN DD 1.6mm	2 + 10	A9HSND12Z	12 Ways	On Request
Acti9 DB 18 way SPN DD 1.6mm	2 + 16	A9HSND18Z	18 Ways	On Request

TPN DBs

Description	Total Module Cutout (Incomer + Outgoing)	Double Door Metal (IP43) Reference	No of Ways	Unit MRP [₹]
Acti9 DB 4 way TPN DD 1.6mm	8 + 4 x 3	A9HTND04Z	4 Ways	On Request
Acti9 DB 6 way TPN DD 1.6mm	8 + 6 x 3	A9HTND06Z	6 Ways	On Request
Acti9 DB 8 way TPN DD 1.6mm	8 + 8 x 3	A9HTND08Z	8 Ways	On Request
Acti9 DB 12 way TPN DD 1.6mm	8 + 12 x 3	A9HTND12Z	12 Ways	On Request

Please contact Customer Care Center for Stockable and Non stockable status of references.

NORMAL STOCK ITEMS

W.E.F. January 30th, 2023

Flexi Tier DBs

Description	Total Module Cutout (no. of rows x No. of modules per row)	Double Door Metal (IP43) Reference	No of Modules Per Row	Unit MRP [₹]
4 Tier 40 Modules	4 x 10	A9HFD440Z	10	On Request
4 Tier 56 Modules	4 x 14	A9HFD456Z	14	On Request

TV TEL DB

Description	Double Door Metal (IP30) Reference	Unit MRP [₹]
Acti9 DB TVTEL BOX 1mm IP30	A9HTVTEL	On Request
Acti9 DB TVTEL & ONT BOX 1.2MM IP30	A9HOTVTEL	On Request

Note: For all above Reference MOQ = 1

Metal Clad P&S Units



- Plug & Socket Unit with Electra Plug & Socket and provision to mount modular protection devices to feed the end load directly

Description	Total Module Cutout	Single Door (IP30) Reference	Unit MRP [₹]
10A 1P+N+E P&S	2	A9HMS210	2645
20A 1P+N+E P&S	2	A9HMS220	2831
30A 3P+E P&S	3	A9HMS330	6196

Industrial P&S Units (provision to mount PratiKa Sockets)



- Plug & Socket Unit with provision to mount PratiKa straight / angled* socket and modular protection devices to feed the end load directly

Description	Total Module Cutout	Single Door (IP30) Reference	Unit MRP [₹]
16A 3P PK P&S	2	A9HKS316	2445
32A 3P PK P&S	2	A9HKS332	4039
32A 5P PK P&S	4	A9HKS532	4784
63A 5P PK P&S	4	A9HKS563	9661

Locks for Acti 9 DBs



Key Lock*

Lock & Unlock symbol
on door for easy &
intuitive operation

Description	Reference	Unit MRP [₹]
New Rotary Lock**	A9HRL901	757

Note: **Use New Rotary lock reference A9HRL901 for:
Acti9 DBs manufactured September 2020 onwards
Acti9 DBs with lock & unlock symbol on door.

Please contact Customer Care Center for Stockable and Non stockable status of references.

NORMAL STOCK ITEMS

W.E.F. January 30th, 2023

Modular Distribution Boards - Metallic

Accessories for Distribution Boards

Description	Reference	Unit MRP [₹]
Busbars		
Fork Busbar 1P 12MOD. 63A	R9XFH112	1024
Fork Busbar 1P 57MOD. 63A	R9XFH157	2279
Fork Busbar 2P 12MOD. 63A	R9XFH212	1180
Fork Busbar 2P 57MOD. 63A	R9XFH257	4371
Fork Busbar 3P 12MOD. 63A	R9XFH312	2664
Fork Busbar 3P 57MOD. 63A	R9XFH357	9535
Fork Busbar 4P 12MOD. 63A	R9XFH412	2457
Fork Busbar 4P 57MOD. 63A	R9XFH457	10262
Busbar Accessories		
Set of 10 End Caps 1P	R9XE110	*
Set of 10 End Caps 2P	R9XE210	*
Set of 10 End Caps 3P	R9XE310	1077
Set of 10 End Caps 4P	R9XE410	*
Set of 4 Connector Fork 63A	R9XFC04	*
Set of 20 Tooth Caps	R9XT20	1294
Blanking Plate	13229B	53

Note: Blanking Plate MOQ = 10, All other MOQ = 1

Customized Distribution Boards to Suit Your Need - Available on Request*

- TV/Telephone DBs
- Pre-Wired DBs
- 8 Segment DBs
- Acrylic Door DBs
- IP54 DBs
- DBs with Phase Indication Lamps

*upto 32A socket only

Note: For all above Reference MOQ = 1

Note: * Please contact nearest Schneider Electric Sales Office or Customer Care Center for coordination chart

Please contact Customer Care Center for Stockable and Non stockable status of references.

NORMAL STOCK ITEMS

W.E.F. January 30th, 2023

Kaedra enclosures for PratiKa industrial sockets are part of a complete system of Watertight enclosures from 16A to 125A providing solutions for protection, control and electrical distribution for tertiary and industrial applications



- Degree of protection - IP65
- Impact strength - IK09
- Resistant to chemical and atmospheric agents, UVs etc.
- Self extinguishing class 2 insulating material
- Flame and abnormal heat resistance: 650°C
- Reversible front face for opening of door to left/right
- Combining of enclosures horizontally/vertically while still maintaining IP
- DIN channel can be positioned in 2 depths & 2 heights for cabling purpose

Mini Enclosures for modular devices



Description	Reference	Unit MRP [₹]
4 module	13441 <input checked="" type="checkbox"/>	3859
6 module	13442	4392
8 module	13443	5172
12 module	13444	8310

Enclosures for modular devices (with terminal blocks)



Description	Reference	Unit MRP [₹]
1 row 12 module	13431	9171
1 row 18 module	13432	12087
2 row 24 module	13433	13726
2 row 36 module	13434	17376
3 row 36 module	13435	18118
4 row 72 module	13437	34582

Mini Enclosure (suitable to mount modular devices and PratiKa 16A socket)



Description	Reference	Unit MRP [₹]
4 module 1 vertical opening	13175 <input checked="" type="checkbox"/>	1841
4 module 2 horizontal opening	13176	2271
4 module 3 horizontal opening	13177	2858

Note: For all above Reference MOQ = 1

Please contact Customer Care Center for Stockable and Non stockable status of references.

NORMAL STOCK ITEMS

W.E.F. January 30th, 2023

Enclosure (suitable to mount modular devices and PratiKa 16A / 32A sockets)



Description	Reference	Unit MRP [₹]
5 module 2 opening	13178 <input checked="" type="checkbox"/>	4431
8 module 4 horizontal opening	13179	6048
13 module 3 opening	13180	7992
13 module 6 opening	13181	8785
19 module 8 opening	13182	11322

Functional Plaques



Description	Reference	Unit MRP [₹]
Blank - marked for 1 socket 50x50	13135	573
Blank - marked for 1 socket 65x65 or 75x75	13137	573
Intermediate with 65x85 opening	13136	699
Intermediate with one opening for 65x85 & 90x100	13142	1159

Note: For all above Reference MOQ = 1

Please contact Customer Care Center for Stockable and Non stockable status of references.

NORMAL STOCK ITEMS

W.E.F. January 30th, 2023

Wander Plugs



- Conforms to IEC 60309-1 & IEC 60309-2
- PK PratiKa Screw Connect: same orientation of clamp's screws
- External impact strength: IK08
- Glow wire test: 850°C

[In] Rated Current (A)	[Ue] Rated Operational Voltage (V)	Poles Description	Reference	Unit MRP [₹]
PratiKa Screw				
IP44				
16	200...250	2P + E	PKE16M423 <input checked="" type="checkbox"/>	578
		2P + E	PKX16M423 <input type="checkbox"/>	1168
	380...415	3P + E	PKE16M434 <input checked="" type="checkbox"/>	731
3P + N + E		PKE16M435 <input checked="" type="checkbox"/>	762	
32	200...250	2P + E	PKE32M423 <input checked="" type="checkbox"/>	909
		3P + E	PKE32M434	1055
	380...415	3P + N + E	PKE32M435 <input checked="" type="checkbox"/>	1040
IP67				
16	200...250	2P + E	PKE16M723 <input checked="" type="checkbox"/>	1262
		2P + E	PKX16M723 <input type="checkbox"/>	1857
	380...415	3P + E	PKE16M734	1426
3P + N + E		PKE16M735	1524	
32	200...250	2P + E	PKE32M723	1786
		3P + E	PKE32M734 <input checked="" type="checkbox"/>	1927
	380...415	3P + N + E	PKE32M735 <input checked="" type="checkbox"/>	1941
PK (63A & 125A available in IP67 only)				
63	200...250	2P + E	81378	5063
		3P + E	81382 <input checked="" type="checkbox"/>	4827
	380...415	3P + N + E	81383 <input checked="" type="checkbox"/>	4834
125	200...250	2P + E	81390	12929
		3P + E	81394	14765
	380...415	3P + N + E	81395	14765

Note: * Fast Connection

Small Wall Mounted Sockets



- Conforms to IEC 60309-1 & IEC 60309-2
- External impact strength: IK08
- Glow wire test: 850°C

[In] Rated Current (A)	[Ue] Rated Operational Voltage (V)	Poles Description	Reference	Unit MRP [₹]
IP44				
16	200...250	2P + E	PKF16W423	1011
		3P + E	PKF16W434	1173
	380...415	3P + N + E	PKF16W435	1282
32	200...250	2P + E	PKF32W423	1322
		3P + E	PKF32W434	1587
	380...415	3P + N + E	PKF32W435	1675
IP67				
16	200...250	2P + E	PKF16W723	1607
		3P + E	PKF16W734	2018
	380...415	3P + N + E	PKF16W735	2087
32	200...250	2P + E	PKF32W723	2010
		3P + E	PKF32W734	2936
	380...415	3P + N + E	PKF32W735	3894

Note: For all above Reference MOQ = 1

Please contact Customer Care Center for Stockable and Non stockable status of references.

NORMAL STOCK ITEMS

W.E.F. January 30th, 2023

Wall Mounted Sockets



- Conforms to IEC 60309-1 & IEC 60309-2
- Rated operational voltage upto 415V
- Rated operational current upto 125A
- External impact strength: IK08
- Glow wire test: 850°C
- Available only in IP67

[In] Rated Current (A)	[Ue] Rated Operational Voltage (V)	Poles Description	Reference	Unit MRP [₹]
63	200...250	2P + E	81178	6237
		3P + E	81182 ●	6419
	3P + N + E	81183	6511	
125	380...415	3P + E	81194	22493
		3P + N + E	81195	22603

Wander Sockets



- PK PratiKa Screw Connect: same orientation of clamp's screws.
- PK PratiKa: 16A & 32A; IP44 & IP67
- External impact strength: IK08
- Glow wire test: 850 °C
- Conforms to IEC 60309-1 & IEC 60309-2

[In] Rated Current (A)	[Ue] Rated Operational Voltage (V)	Poles Description	Reference	Unit MRP [₹]
PratiKa Screw				
IP44				
16	200...250	2P + E	PKF16M423 ✓	800
		2P + E	PKY16M423	882
	380...415	3P + E	PKF16M434	923
		3P + N + E	PKF16M435	1007
32	200...250	2P + E	PKF32M423 ✓	1100
		3P + E	PKF32M434	1335
	380...415	3P + N + E	PKF32M435 ✓	1344
IP67				
16	200...250	2P + E	PKF16M723	1481
		2P + E	PKY16M723 ●	1802
	380...415	3P + E	PKF16M734	1857
		3P + N + E	PKF16M735	1941
32	380...415	2P + E	PKF32M723	2037
		3P + E	PKF32M734	2254
	3P + N + E	PKF32M735	2275	
PK (63A & 125A available in IP67 only)				
63	200...250	2P + E	81478	5514
		3P + E	81482	5563
	380...415	3P + N + E	81483	5653
125	200...250	2P + E	81490	21116
		3P + E	81494	17408
	380...415	3P + N + E	81495	17749

Also Available on Request:

- Patented FAST connect Plugs & Sockets - innovative cabling system that enables connection without stripping the conductor and with absolutely no screws required
- Extra Low Voltage Plugs & Sockets down to 50V

Please contact nearest Schneider Electric Sales Office or Customer Care for Reference and Prices

Note: For all above Reference MOQ = 1

Please contact Customer Care Center for Stockable and Non stockable status of references.

✓ NORMAL STOCK ITEMS

W.E.F. January 30th, 2023

Panel Mounted Sockets - Angled



- PK PratiKa Screw Connect: same orientation of clamp's screws
- External impact strength: IK08
- Glow wire test: 850°C
- Conforms to IEC 60309-1 & IEC309-2

[In] Rated Current (A)	[Ue] Rated Operational Voltage (V)	Poles Description	Reference	Unit MRP [₹]
PratiKa Screw				
IP44				
16	200...250	2P + E	PKF16F423 <input checked="" type="checkbox"/>	619
		2P + E	PKY16F423 <input type="checkbox"/>	668
	380...415	3P + E	PKF16F434	923
		3P + N + E	PKF16F435 <input checked="" type="checkbox"/>	984
32	200...250	2P + E	PKF32F423 <input checked="" type="checkbox"/>	1100
	380...415	3P + E	PKF32F434	1276
		3P + N + E	PKF32F435	1271
IP67				
16	200...250	2P + E	PKF16F723 <input checked="" type="checkbox"/>	1166
		2P + E	PKY16F723 <input type="checkbox"/>	1412
	380...415	3P + E	PKF16F734	1328
		3P + N + E	PKF16F735 <input checked="" type="checkbox"/>	1344
32	200...250	2P + E	PKF32F723	1517
	380...415	3P + E	PKF32F734	1773
		3P + N + E	PKF32F735	1802
PK (63A & 125A available in IP67 only)				
63	200...250	2P + E	81278	4979
	380...415	3P + E	81282 <input checked="" type="checkbox"/>	4987
		3P + N + E	81283 <input checked="" type="checkbox"/>	5085
125	200...250	2P + E	81290	16372
	380...415	3P + E	81294	16797
		3P + N + E	81295	16879

Panel Mounted Sockets - Straight



- PK PratiKa Screw Connect: same orientation of clamp's screws
- External impact strength: IK08
- Glow wire test: 850°C
- Conforms to IEC 60309-1 & IEC309-2

[In] Rated Current (A)	[Ue] Rated Operational Voltage (V)	Poles Description	Reference	Unit MRP [₹]
PratiKa Screw				
IP44				
16	200...250	2P + E	PKF16G423	701
		2P + E	PKY16G423	909
	380...415	3P + E	PKF16G434	1223
		3P + N + E	PKF16G435	1055
32	200...250	2P + E	PKF32G423	1113
	380...415	3P + E	PKF32G434	1282
		3P + N + E	PKF32G435	1389
IP67				
16	200...250	2P + E	PKF16G723	1173
		2P + E	PKY16G723 <input type="checkbox"/>	1322
	380...415	3P + E	PKF16G734	1613
		3P + N + E	PKF16G735	1344
32	200...250	2P + E	PKF32G723	1496
	380...415	3P + E	PKF32G734	1684
		3P + N + E	PKF32G735	1747
PK (63A & 125A available in IP67 only)				
63	200...250	2P + E	81678	6025
	380...415	3P + E	81682	5036
		3P + N + E	81683	5036
125		3P + N + E	81695	16879

*Fast Connection

Note: For all above Reference MOQ = 1

Please contact Customer Care Center for Stockable and Non stockable status of references.

NORMAL STOCK ITEMS

W.E.F. January 30th, 2023

Sockets with Interlock Switches - for guaranteed safety of operation

- Allows closure of main switch only when the plug is fully inserted in socket - when complete mechanical & electrical connection has occurred
- Plug removal is possible only when the switch is in "off" position

Wall Mounted Sockets with Interlock Switch Unika (w/o protection)



83047

83081

- Switch designed for use in AC 22A class applications
- Conforms to IEC 60309-1 & IEC 60309-2
- Rated operational voltage upto 415V
- Rated operational current upto 32A
- External impact strength: IK08
- Available in IP44 / IP65 versions
- Glow wire test: 750°C

[In] Rated Current (A)	[Ue] Rated Operational Voltage (V)	Poles Description	Reference	Unit MRP [₹]
IP44				
16	200...250	2P + E	83031	8416
	380...415	3P + E	83035	14155
32	200...250	3P + N + E	83036	11878
		2P + E	83042 <input checked="" type="checkbox"/>	10926
	380...415	3P + E	83046	15474
		3P + N + E	83047	12875
IP65				
16	200...250	2P + E	83081	8708
	380...415	3P + E	83085	11991
		3P + N + E	83086	12235
32	200...250	2P + E	83092	11412
	380...415	3P + E	83096	16647
		3P + N + E	83097	13703

Socket with Interlock Switch & DIN Rail Isoblock (4.5 modules)



82754

83796

- Switch designed for use in AC- 22A class applications
- Conforms to IEC 60309-1 & IEC 60309-2
- Provision to DIN mount 4.5 module device
- External impact strength: IK10
- Available in IP65 version
- Glow wire test: 850°C

[In] Rated Current (A)	[Ue] Rated Operational Voltage (V)	Poles Description	Reference	Unit MRP [₹]
16	200...250	2P + E	82754 <input checked="" type="checkbox"/>	10433
	380...415	3P + E	82758	15439
		3P + N + E	82759	15954
32	200...250	2P + E	83791 <input checked="" type="checkbox"/>	12352
	380...415	3P + E	83795	17763
		3P + N + E	83796	14716

Socket with Interlock Switch & DIN Rail Isoblock (6 modules)



82766

82771

- Switch designed for use in AC- 22A class applications
- Conforms to IEC 60309-1 & IEC 60309-2
- Provision to DIN mount 6 module device
- External impact strength: IK10
- Available in IP65 version
- Glow wire test: 850°C

[In] Rated Current (A)	[Ue] Rated Operational Voltage (V)	Poles Description	Reference	Unit MRP [₹]
32	200...250	2P + E	82766	16295
	380...415	3P + E	82770	23213
		3P + N + E	82771	19684
63	380...415	3P + E	82782	21957
		3P + N + E	82783	22027

Note: For all above Reference MOQ = 1

Please contact Customer Care Center for Stockable and Non stockable status of references.

NORMAL STOCK ITEMS

W.E.F. January 30th, 2023

ELECTRA Metal Clad Plugs & Sockets are specially designed incorporating the latest safety, quality and user friendly features.

Construction

- The casting is made from non-corroding die-cast aluminum alloy combining exceptional compactness with high strength
- The design/construction eliminates the possibility of mismatch in fitting of plugs in corresponding sockets
- The floating contacts in the sockets are self aligning and facilitates smooth plugging in without undue pressure (These can be easily removed for wiring)
- A provision for pilot pin facilitates mechanical interlocking in case of 63A ratings

Human Safety

Specially designed shroud to avoid accidental finger contact with plug-pins while inserting/removing the plug
Similarly, the contact tubes in sockets are deeply recessed to avoid human contact

- The earthing pins ensure that earth connection is made first and broken last, being longer than conducting pins
- The visible earth terminals facilitate easy checking of earth connection
- The cable grip to the plug is made very strong by providing a compression gland and by protecting it at the point of entry by a strong rubber guard

Applications

Industrial, Commercial & Domestic portable equipments like Hand/Power Tools, Industrial Ovens, Welding Sets, Mobile Generators, Furnaces, Ships, Office Machines, Refrigerators, Coolers, Air-Conditioners, Overhead Cranes, Chilling Cabinets, Tile Polishers and Sewing Machines

Plug



Rating (A)	Poles Description	Voltage (V)	MOQ	Reference	Unit MRP [₹]
10	2P	250	30	AP10 <input checked="" type="checkbox"/>	275
20	2P	250	30	AP20 <input checked="" type="checkbox"/>	289
20	3P	440	30	BP20 <input checked="" type="checkbox"/>	384
30	3P	440	20	BP30 <input checked="" type="checkbox"/>	700
63	3P+N+E	440	4	CP63 <input checked="" type="checkbox"/>	3166

Socket



Rating (A)	Poles Description	Voltage (V)	MOQ	Reference	Unit MRP [₹]
10	2P	250	30	AS10 <input checked="" type="checkbox"/>	289
20	2P	250	30	AS20 <input checked="" type="checkbox"/>	308
20	3P	440	30	BS20 <input checked="" type="checkbox"/>	432
30	3P	440	20	BS30 <input checked="" type="checkbox"/>	741
63	3P+N+E	440	4	CS63 <input checked="" type="checkbox"/>	3479

Please contact Customer Care Center for Stockable and Non stockable status of references.

NORMAL STOCK ITEMS

W.E.F. January 30th, 2023

Complete range of switches & sockets suitable for both indoor & outdoor applications like Kitchens, Swimming Pools, Landscape Gardens, Exterior Walls and Other Environmentally Challenged Locations.



56SW116LE-GY



56SW216LE-GY



56SW332LE-GY

Description	IP Rating	Reference	Unit MRP [₹]
Surface Switches			
Single Pole Switches Less Enclosure			
1 Pole 250V 10A	IP66	56SW110LE-GY	3710
1 Pole 250V 16A	IP66	56SW116LE-GY	3476
1 Pole 250V 20A	IP66	56SW120LE-GY	5264
1 Pole 250V 32A	IP66	56SW132LE-GY	6217
Double Pole Switches Less Enclosure			
2 Pole 500V 16A	IP66	56SW216LE-GY	6007
2 Pole 500V 20A	IP66	56SW220LE-GY	6007
2 Pole 500V 32A	IP66	56SW232LE-GY	6974
2 Pole 500V 50A	IP66	56SW250LE-GY	8144
Triple Pole Switches Less Enclosure			
3 Pole 500V 10A	IP66	56SW310LE-GY	5555
3 Pole 500V 16A	IP66	56SW316LE-GY	5795
3 Pole 500V 20A	IP66	56SW320LE-GY	6101
3 Pole 500V 32A	IP66	56SW332LE-GY	7113
3 Pole 500V 50A	IP66	56SW350LE-GY	8207
3 Pole 500V 63A	IP66	56SW363LE-GY	9527
Four Pole Switches Less Enclosure			
4 Pole 500V 20A	IP66	56SW420LE-GY	8054



66CV563-RG



66P563-EO

Description	IP Rating	Reference	Unit MRP [₹]
IP66 Industrial Combination Switch Sockets with Enclosure			
Single Pole Switches Less Enclosure			
500V, 63A with 4 pole switch and 63A 5 Pin Socket	IP66	66CV563-RG	107969
Plug Top 5 Pin 500V 63A	IP66	66P563-EO	32407

Please contact Customer Care Center for Stockable and Non stockable status of references.

NORMAL STOCK ITEMS

W.E.F. January 30th, 2023



56SO316RP-LE-GY-EX



56SO432LE-GY



56SO532LE-GY

Description	IP Rating	Reference	Unit MRP [₹]
Surface Socket Outlets			
3 Pin Sockets Less Enclosure			
3 Pin 250V 16A Indian Standard	IP66	56SO316RP-LE-GY-EX	3499
3 Pin 250V 20A Round Pin	IP66	56SO320LE-GY	5080
3 Pin 250V 32A Round Pin	IP66	56SO332LE-GY	5605
4 Pin Sockets Less Enclosure			
4 Pin 500V 20A Round Pin	IP66	56SO420LE-GY	7515
4 Pin 500V 32A Round Pin	IP66	56SO432LE-GY	8986
4 Pin 500V 50A Round Pin	IP66	56SO450LE-GY	13826
5 Pin Sockets Less Enclosure			
5 Pin 500V 10A Round Pin	IP66	56SO510LE-GY	8121
5 Pin 500V 20A Round Pin	IP66	56SO520LE-GY	8121
5 Pin 500V 32A Round Pin	IP66	56SO532LE-GY	9644
5 Pin 500V 40A Round Pin	IP66	56SO540LE-GY	13914
5 Pin 500V 50A Round Pin	IP66	56SO550LE-GY	14286

*Alternate reference 56SO440-GY (coming soon)



56PA420-EO



56PA532-EO



56CV1520-GY

Description	IP Rating	Reference	Unit MRP [₹]
Plugs			
3 Pin Angle Plugs			
3 Pin 250V 20A Round Pin	IP66	56PA320-EO	5264
3 Pin 250V 32A Round Pin	IP66	56PA332-EO	6023
4 Pin Angle Plugs			
4 Pin 500V 20A Round Pin	IP66	56PA420-EO	6414
4 Pin 500V 32A Round Pin	IP66	56PA432-EO	6677
4 Pin 500V 40A Round Pin	IP66	56PA440-EO	8970
4 Pin 500V 50A Round Pin	IP66	56PA450-EO	7923
5 Pin Angle Plugs			
5 Pin 500V 10A Round Pin	IP66	56PA510-EO	6305
5 Pin 500V 20A Round Pin	IP66	56PA520-EO	6305
5 Pin 500V 32A Round Pin	IP66	56PA532-EO	7284
5 Pin 500V 40A Round Pin	IP66	56PA540-EO	7704
5 Pin 500V 50A Round Pin	IP66	56PA550-EO	7887
Combination Switch Socket Outlet			
IP66 Interlocked Switch Socket with Enclosure			
4 Pin 500V 20A Round Pin	IP66	56CVI420-GY	24114
5 Pin 500V 20A Round Pin	IP66	56CVI520-GY	24932
5 Pin 500V 32A Round Pin	IP66	56CVI532-GY	25160

Please contact Customer Care Center for Stockable and Non stockable status of references.

NORMAL STOCK ITEMS

W.E.F. January 30th, 2023

56 Series



56DB2-GY



56CB4N-GY

Description	IP Rating	Reference	Unit MRP [₹]
Adaptable Enclosures with Gear Tray			
2 Gangpoints, 198X101X140mm	IP66	56DB2-GY	6879
3 Gangpoints, 294X101X140mm	IP66	56DB3-GY	8748
6 Gangpoints, 294X198X140mm	IP66	56DB6-GY	20649
Junction Boxes			
1 Gangpoint, 107X101X90mm	IP66	56JB1-GY	2993
2 Gangpoints, 204X101X90mm	IP66	56JB2-GY	4811
3 Gangpoints, 300X101X90mm	IP66	56JB3-GY	10310
4 Gangpoints, 204X198X90mm	IP66	56JB4-GY	9679

Description	Module Width	Reference	Unit MRP [₹]
Switchgear Cover Assembly			
For 1,2,3 Pole MCB with 4 Pole RCD (max. 4M Width)	4	56CB4N-GY	5714



56FA2-GY



56E2-GY



56E1-GY-EX



56E3-GY

Description	No. of Gangs	Reference	Unit MRP [₹]
Flush Surrounds			
Flush Surround	1	56FA1-GY	2790
Flush Surround	2	56FA2-GY	2815
Flush Surround	3	56FA3-GY	4432
Mounting Enclosures (Back Boxes)			
198X101X63mm	2	56E2-GY	3141
294X101X63mm	3	56E3-GY	4986
198X198X63mm	4	56E4-GY	6414
294X198X63mm	6	56E6-GY	10256
391X198X63mm	8	56E8-GY	13456
391X391X63mm	16	56E16-GY	24381

Please contact Customer Care Center for Stockable and Non stockable status of references.

NORMAL STOCK ITEMS

W.E.F. January 30th, 2023

SWITCH TO STYLE



Perfect solutions for the perfect you



Clipsal X



Opale



Anti-Bacterial
Range

LIVIA
Life. Style.



Avatar On



ZENcelo



Unica Pure

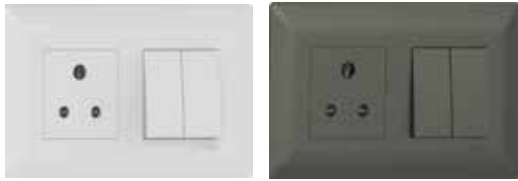

- **Sleek Design** - 2.7mm thin plate with curved body to minimize dust accumulation
- **Stylish Looks** - Soft white texture with glossy finish
- **Robust & Strong** - Innovative honeycomb designed grid plate for extra rigidity
- **Reliable** - High grade heat-resistant polycarbonate and laser marked wiring diagrams. Tested for 4 Lac clicks
- **Easy to Install** - Snap-In / Snap-Out front loading modules and Bigger terminal holes
- **Green & Eco Friendly** - RoHS compliant range

NEW Livia Painted Grey to be launched soon.



Description	Reference for White	Unit MRP [₹]	Box Qty	Reference for Steel Grey	Unit MRP [₹]	Box Qty
Switches						
10AX 1 way switch	P1001	136	20	P1001_PG	190	20
10AX 1 way switch with Indicator lamp	P1081	281	20	P1081_PG	391	20
10AX 2 way switch	P1002	222	20	P1002_PG	276	20
16AX 1 way switch	P1101	239	20	P1101_PG	297	20
16AX 1 way switch with Indicator lamp	P1181	336	20	P1181_PG	388	20
16AX 1 way switch (2M)	P1121	375	10	P1121_PG	496	10
16AX 2 way switch	P1102	329	10	P1102_PG	456	1
20A 1 way switch (1M) with indicator lamp	P11201	303	20	P11201_PG	395	20
20A DP switch with Indicator lamp	P1120	534	20	P1120_PG	749	20
32A DP switch with Indicator lamp	P1132	781	10	P1132_PG	1,023	20
Motor Starter Switch						
25A Motor Starter switch	P1186MS	1,353	1	P1186MS_PG	1,834	1
Bell Push						
10A Bell Push switch	P1005	248	20	P1005_PG	341	10
10A Bell Push switch (2M)	P1025	333	10	P1025_PG	503	10
10A bell push switch with Indicator	P1085	300	20	P1085_PG	419	20
10A bell push switch with Indicator (2M)	P1086	388	10	P1086_PG	542	10
Sockets						
6A 3Pin socket Outlet with shutter (BIS)	P2005NS	264	10	P2005NS_PG	322	10
6A/16A 3-pin Socket Outlet with Shutter	P2106	397	10	P2106_PG	473	10
Fan Regulators & Dimmers						
Step type fan regulator (1M)	P3100	765	10	P3100_PG	966	10
Step type fan regulator (2M)	P3200	889	6	P3200_PG	1,121	10
Dimmer 400W (1M)	P3004	1,421	6	P3004_PG	1,938	6
Dimmer 1000W (2M)	P3012	2,104	6	P3012_PG	2,463	6
USB Charger						
USB Charger	P7002	1,752	10	P7002_PG	2,138	10
Livia - A+C Type USB Charger (1M)	P7003	2842	10	P7003_PG*	3420	10
Accessories						
RJ 11 Telephone outlet with shutter	P4011	218	20	P4011_PG	311	20
RJ 45 Cat 5e Data outlet with shutter	P4045	745	20	P4045_PG	919	20
RJ 45 Cat6 Data outlet with shutter	P4046	829	20	P4046_PG	1,056	20
TV socket	P4500	210	20	P4500_PG	297	20
Blank off unit (1M)	P0001	59	40	P0001_PG	77	40
Foot Lamp with LED	P7001	899	1	P7001_PG	1,108	1
Cord Outlet	P4550	276	20	P4550_PG	339	20
LED Phase Indicator	P5001	372	20	-	-	-
Hotel Series						
DND Switch	P6002	306	20	P6002_PG	373	20
MMR Switch	P6004	306	20	P6004_PG	373	20
DND & MMR Indicator	P6013	863	20	P6013_PG	1,210	20
20A Key Card Switch - Electronic (3M)	P6005	4,685	1	P6005_PG	6,541	1
Cover Plates						
1-2 M Grid & 1 M Cover Frame	P0701	149	15	P0701_PG	203	15
1-2 M Grid & 2 M Cover Frame	P0702	149	15	P0702_PG	186	15
3 M Grid & 3 M Cover Frame	P0703	189	10	P0703_PG	219	10
4 M Grid & 4 M Cover Frame	P0704	219	8	P0704_PG	270	8
6 M Grid & 6 M Cover Frame	P0706	276	5	P0706_PG	357	5
8 M Grid & 8 M Cover Frame - Horizontal	P0708	363	5	P0708_PG	441	5
8 M Grid & 8 M Cover Frame - Square	P0709	438	5	P0709_PG	615	5
9 M Grid & 9M Cover Frame	P07010	412	5	P07010_PG	569	5
12 M Grid & 12 M Cover Frame	P0712	530	5	P0712_PG	657	5
16 M Grid & 16M Cover Frame	P07016	631	5	P07016_PG	753	5
18 M Grid & 18 M Cover Frame	P0718	763	5	P0718_PG	1,071	5

**Livia Dark Grey will be available only till stock last.

Please contact Customer Care Center for Stockable and Non stockable status of references.

NORMAL STOCK ITEMS

W.E.F. January 30th, 2023

Clipsal X - As Stylish As Your World



Xtra STYLE

- Trendy Dual tone colour and finish
- Contemporary sloped design that blends seamlessly with the wall
- Vibrant and youthful colours and textured finishes that can stand out or blend in
- Textured finishes to match most Indian decors – Wood, Slate & Leather

Xtra STRONG

- Made to last for more than 1 Million Clicks
- 10A rated switches to enable Grouping – add as many loads as you want
- UV Stabilized to avoid decoloring

Xtra COMFORT

- Least noise level for unobtrusive switching
- Smooth finish which avoids light reflection off the surface
- Glossy Band making it Easy to Clean
- Large plate overhang to hide wall & paint imperfections



CPX101SW1M_WE



CPX161SWL1M_WE



CPX20DP2M_WE



CPX6BP2M_WE



CPX6SK3PNS_WE



CPXACUSB1P1M_WE



CPX5STFAN2M_WE



CPX21USB1P1M_WE



CPXACUSB1P1M_WE



CPXTVCOAX1M_WE



CPXCORD1M_WE



CPXDNDIN1M_WE



CPXMMRIN1M_WE



CPXKEYCARDSW_WE

Description	Reference for White	Unit MRP (₹)	Pack	Reference for Coke Grey	Unit MRP (₹)	Pack
Switches						
10AX 1 Way Switch	CPX101SW1M_WE	127	20	CPX101SW1M_GY	226	20
10A X1 Way Switch with Indicator	CPX101SWL1M_WE	311	20	CPX101SWL1M_GY	368	1
10AX 2 Way Switch	CPX102SW1M_WE	264	20	CPX102SW1M_GY	319	20
16AX 1 Way Switch	CPX161SW1M_WE	319	1	CPX161SW1M_GY	393	1
16AX 1 Way Switch with Indicator	CPX161SWL1M_WE	419	20	CPX161SWL1M_GY	496	20
16AX 2 Way Switch	CPX162SW1M_WE	423	1	CPX162SW1M_GY	500	20
10AX 1 Way Switch (2M)	CPX101SW2M_WE	350	1	CPX101SW2M_GY	417	10
16AX 1 Way Switch (2M)	CPX161SW2M_WE	449	1	CPX161SW2M_GY	534	10
10AX 1W Switch with Indicator (2M)	CPX101SWL2M_WE	442	1	CPX101SWL2M_GY	528	10
16AX 1W Switch with Indicator (2M)	CPX161SWL2M_WE	516	1	CPX161SWL2M_GY	637	10
20A DP Switch with Indicator (2M)	CPX20DP2M_WE	710	1	CPX20DP2M_GY	828	1
32A DP Switch with Indicator (2M)	CPX32DP2M_WE	1,080	1	CPX32DP2M_GY*	1,634	10
Motor Starter Switch						
25A Motor Starter Switch	CPXMTSTART2M_WE	1,224	10	CPXMTSTART2M_GY	2,267	10
Bell Press						
6A Bell Push	CPX6BP1M_WE	297	20	CPX6BP1M_GY	340	1
6A Bell Push (2M)	CPX6BP2M_WE	451	10	CPX6BP2M_GY	527	1
6A Bell Push with Indicator	CPX6BPL1M_WE	411	1	CPX6BPL1M_GY	491	20
6A Bell Push with Indicator (2M)	CPX6BPL2M_WE	491	1	CPX6BPL2M_GY	558	10
Sockets						
6A 3P Socket Outlet with Shutter (BIS Std.)	CPX6SK3PNS_WE	337	10	CPX6SK3PNS_GY	382	10
6A/16A 3P Socket with Shutter	CPX616SK_WE	510	10	CPX616SK_GY	576	10
Fan Regulators and Dimmers						
5-Step Fan Regulator (2M)	CPX5STFAN2M_WE	1,133	1	CPX5STFAN2M_GY	1,356	5
4-Step Fan Regulator (1M), White	CPX4STFAN1M_WE	1,033	10	CPX4STFAN1M_GY	1,237	10
400W Dimmer (1M)	CPXDIM1M_WE	1,116	1	CPXDIM1M_GY	1,274	1
400W Dimmer (2M)	CPXDIM2M_WE	1,651	1	CPXDIM2M_GY	2,065	1
1200W Dimmer	CPXDIM2M_1200_WE	2,125	1	CPXDIM2M_1200_GY	2,548	5
USB Chargers						
2.1A USB Charger (1M)	CPX21USB1P1M_WE	1,836	1	CPX21USB1P1M_GY	2,168	1
2.1A USB Charger (2M)	CPX21USB2P2M_WE	2,585	15	CPX21USB2P2M_GY	3,716	15
2.4A A+C USB Charger(1M)	CPXACUSB1P1M_WE	3,134	10	CPXACUSB1P1M_GY	3,382	10
Accessories						
RJ11 Tel Outlet, No Shutter	CPXRJ11NS1M_WE	276	5	CPXRJ11NS1M_GY	334	5
RJ11 Tel Outlet with Shutter	CPXRJ11_1M_WE	267	5	CPXRJ11_1M_GY	319	5
Twin RJ11 Tel Outlets (1M)	CPXRJ11TW1M_WE	415	12	CPXRJ11TW1M_GY	506	12
RJ45 Data Outlet with Shutter	CPXRJ451M_WE	913	12	CPXRJ451M_GY	1,070	12
TV Socket	CPXTVCOAX1M_WE	250	5	CPXTVCOAX1M_GY	305	5
RJ45 Cover for Keystone Type	CPXRJ45KS1M_WE	313	5	CPXRJ45KS1M_GY	384	5
Gripped Cord Outlet	CPXCORD1M_WE	298	5	CPXCORD1M_GY	342	10
Foot Light with LED	CPXFTLP2M_WE	1,172	-	CPXFTLP2M_GY	1,393	-
Buzzer	CPXBUZZ2M_WE	1,224	-	CPXBUZZ2M_GY	1,283	2
Blank Off Unit (1M)	CPXBLANK1M_WE	70	-	CPXBLANK1M_GY	94	5
Neon Phase Indicator						
Neon Phase Indicator (Green)	CPXPHASEG1M	438	12	-	-	-
Neon Phase Indicator (Red)	CPXPHASER1M	438	12	-	-	-
Neon Phase Indicator (Red)	CPXPHASEY1M	438	12	-	-	-
Hotel Series						
DND Indicator	CPXDNDIN1M_WE	650	12	-	-	-
DND Switch	CPXDNDSW1M_WE	510	1	CPXDNDSW1M_GY	603	1
MMR Indicator	CPXMMRIN1M_WE	650	12	-	-	-
MMR Switch	CPXMMRSW1M_WE	510	1	CPXMMRSW1M_GY	603	20
16A Electronic Keycard Switch	CPXKEYCARDSW_WE	5,926	1	CPXKEYCARDSW_GY	6,686	1
Shaver Socket Horizontal	CPXSHAVER_WE	6,126	1	CPXSHAVER_GY	7,227	1

Please contact Customer Care Center for Stockable and Non stockable status of references.

NORMAL STOCK ITEMS

W.E.F. January 30th, 2023

Clipsal X - As Stylish As Your World



White



Coke Grey



Metallic Copper



Charcoal Black

Description	Reference for White	Unit MRP [₹]	Pack	Reference for Coke Grey	Unit MRP [₹]	Pack	Reference for Metallic Copper	Unit MRP [₹]	Pack	Reference for Charcoal Black	Unit MRP [₹]	Pack
Cover Plates												
1M or 2M Grid & 1M Cover Frame	CPXCP1M_WE	173	1	CPXCP1M_GY	296	10	CPXCP1M_MC	344	10	CPXCP1M_CB	344	10
1M or 2M Grid & 2M Cover Frame	CPXCP2M_WE	187	10	CPXCP2M_GY	319	10	CPXCP2M_MC	373	10	CPXCP2M_CB	373	10
3M Grid & 3M Cover Frame	CPXCP3M_WE	215	10	CPXCP3M_GY	363	10	CPXCP3M_MC	426	10	CPXCP3M_CB	426	10
3M Uni Grid & 3M Cover Frame	CPXCP3MU_WE	255	10	CPXCP3MU_GY	451	10	CPXCP3MU_MC	484	1	CPXCP3MU_CB	505	1
4M Grid & 4M Cover Frame	CPXCP4M_WE	253	1	CPXCP4M_GY	429	10	CPXCP4M_MC	501	10	CPXCP4M_CB	501	10
6M Grid & 6M Cover Frame	CPXCP6M_WE	367	5	CPXCP6M_GY	623	5	CPXCP6M_MC	729	1	CPXCP6M_CB	729	1
8M Grid & 8M Cover Frame, Horizontal	CPXCP8ML_WE	454	1	CPXCP8ML_GY	772	5	CPXCP8ML_MC	903	5	CPXCP8ML_CB	903	5
8M Grid & 8M Cover Frame, Square	CPXCP8MSQ_WE	491	1	CPXCP8MSQ_GY	955	1	CPXCP8MSQ_MC	1066	1	CPXCP8MSQ_CB	1066	1
9M Cover Frame	CPXCP9M_WE	484	5	CPXCP9M_GY	817	5	-	-	-	-	-	-
9M Grid & 9M Cover Frame	-	-	-	-	-	-	-	-	-	CPXCP9M_CB	1235	5
12M Grid & 12M Cover Frame	CPXCP12M_WE	555	1	CPXCP12M_GY	1120	1	CPXCP12M_MC	1254	5	CPXCP12M_CB	1254	5
16M Cover Frame	CPXCP16M_WE	668	5	CPXCP16M_GY	1090	5	-	-	-	-	-	-
18M Grid & 18M Cover Frame	CPXCP18M_WE	858	5	-	-	-	-	-	-	-	-	-

Please contact Customer Care Center for Stockable and Non stockable status of references.

NORMAL STOCK ITEMS

W.E.F. January 30th, 2023

Clipsal X - As Stylish As Your World



Sheesham



Rich Leather

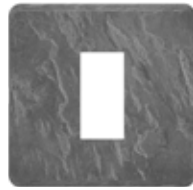

Slate

Description	Reference for Sheesham	Unit MRP [₹]	Pack	Reference for Metallic Rich Leather	Unit MRP [₹]	Pack	Reference for Slate	Unit MRP [₹]	Pack
Cover Plates									
1M or 2M Grid & 1M Cover Frame	CPXCP1M_SH	544	10	CPXCP1M_RL	544	10	CPXCP1M_SL	544	10
1M or 2M Grid & 2M Cover Frame	CPXCP2M_SH	589	1	CPXCP2M_RL	589	1	CPXCP2M_SL	589	1
3M Grid & 3M Cover Frame	CPXCP3M_SH	673	10	CPXCP3M_RL	673	10	CPXCP3M_SL	673	10
3M Uni Grid & 3M Cover Frame	CPXCP3MU_SH	764	1	CPXCP3MU_RL	797	1	CPXCP3MU_SL	764	1
4M Grid & 4M Cover Frame	CPXCP4M_SH	792	1	CPXCP4M_RL	792	1	CPXCP4M_SL	792	1
6M Grid & 6M Cover Frame	CPXCP6M_SH	1150	1	CPXCP6M_RL	1150	1	CPXCP6M_SL	1150	1
8M Grid & 8M Cover Frame, Horizontal	CPXCP8ML_SH	1427	5	CPXCP8ML_RL	1427	5	CPXCP8ML_SL	1427	5
8M Grid & 8M Cover Frame, Square	CPXCP8MSQ_SH	1685	1	CPXCP8MSQ_RL	1685	1	CPXCP8MSQ_SL	1685	1
12M Grid & 12M Cover Frame	CPXCP12M_SH	1979	5	CPXCP12M_RL	1979	5	CPXCP12M_SL	1979	5

Please contact Customer Care Center for Stockable and Non stockable status of references.

NORMAL STOCK ITEMS

W.E.F. January 30th, 2023

Wiring Diagram Clipsal X

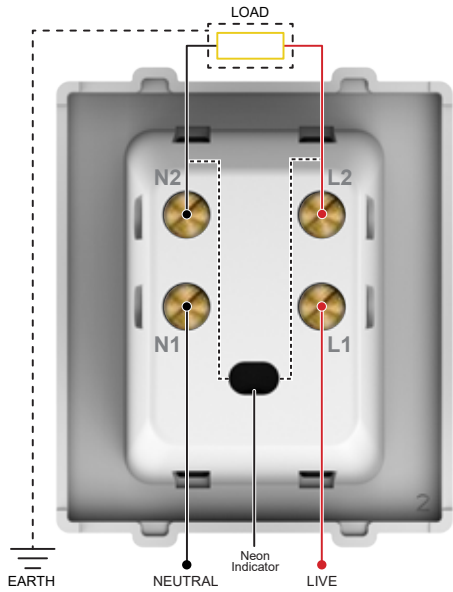

> 20A DP Switch with Indicator (2M)
CPX20DP2M_WE, CPX20DP2M_GY

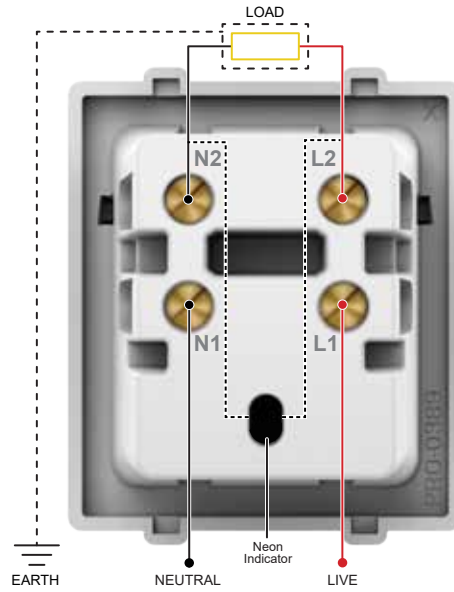

> 32A DP Switch with Indicator (2M)
CPX32DP2M_WE, CPX32DP2M_GY

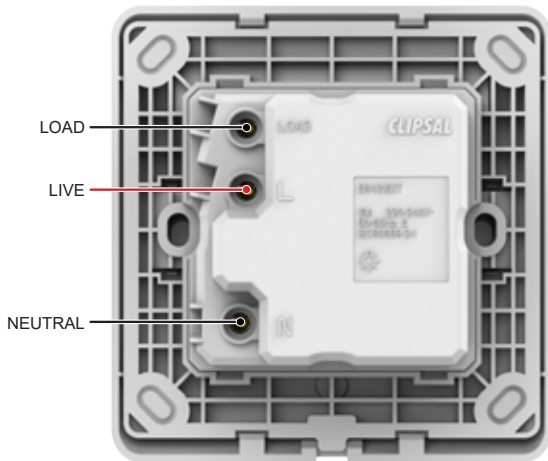

> 16A Electronic Keycard Switch
CPXKEYCARDSW_WE, CPXKEYCARDSW_GY

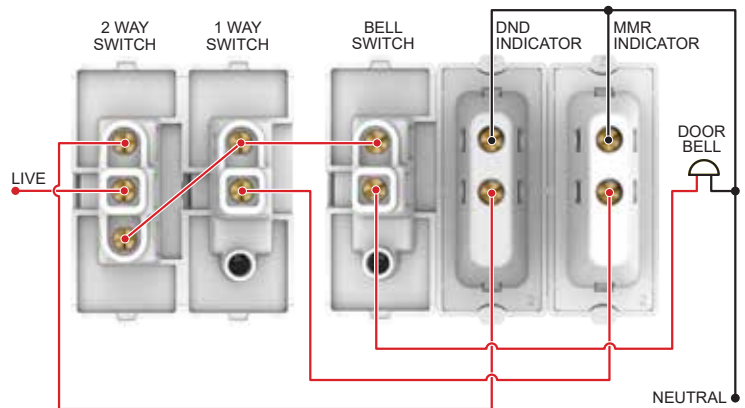

> DND Switch > MMR Switch
> DND Indicator > MMR indicator
CPXDND1M_WE, CPXDND1M_GY,
CPXMMR1M_WE, CPXMMR1M_GY,
CPXDNDIN1M_WE, CPXMMRIN1M_WE

Please contact Customer Care Center for Stockable and Non stockable status of references.

☑ NORMAL STOCK ITEMS

W.E.F. January 30th, 2023

Opale - Switches with Satin Finish



- **Patented Smooth Satin Finish** - Scratch Resistant, Easy to Clean & Prevents light reflection off surface
- **Safe to Use** - High grade flame retardant polycarbonate material & Child Proof sockets with unique shutter design
- **Hassle Free Operation** - 'Soft sound' switches with Gold plated Data Socket contacts for better connection
- **Easy to Install** - Snap-In / Snap-Out front loading modules and terminals with indented screws
- **Green & Eco Friendly** - RoHS compliant range



X1001WH



X1286WH



X1186WH



X1005WH



X1085WH



X2005WHNS



X2106WH



X4020WH



X3200WH



X3104WH



X4010WH



X7003WH



X5001



X5002

Description	Reference for White	Unit MRP [₹]	Pack	Reference for Coke Grey	Unit MRP [₹]	Pack
Switches						
6AX 1 way switch	X1001WH	227	20	AAKY1001	288	20
6AX 1 way switch with Indicator lamp	X1081WH	392	20	AAKY1081	464	20
6AX 2 way switch	X1002WH	313	20	AAKY1002	421	20
16AX 1 way switch	X1101WH	365	20	AAKY1101	457	20
16AX 1 way switch with Indicator lamp	X1181WH	512	20	AAKY1181	604	20
16AX 2 way switch	X1102WH	492	20	AAKY1102	631	20
6AX 1 way switch (2M)	X1021WH	431	10	AAKY1021	666	10
16AX 1 way switch (2M)	X1121WH	520	10	AAKY1121	671	10
6AX 1 way switch	X1001WH	227	20	-	-	-
16AX 1 way switch with Indicator (2M)	X1128WH	650	10	AAKY1128	982	10
20A DP switch with Indicator (2M)	X1286WH	846	10	AAKY1286	1,090	10
32A DP switch (2M)	AAKX1232	1,259	10	-	-	-
Motor Starter Switch						
25A Motor Starter switch	X1186WH	2,201	10	AAKY1186	2,864	10
Bell Push						
6A Bell Push	X1005WH	353	20	AAKY1005	469	20
6A Bell Push (2M)	X1025WH	506	10	AAKY1025	666	10
6A Bell Push with Indicator	X1085WH	509	20	AAKY1085	790	20
6A Bell Push with Indicator (2M)	X1086WH	579	10	AAKY1086	894	10
Sockets						
6A 3Pin Socket outlet with Shutter (BIS)	X2005WHNS	384	10	AAKY2005NS	464	10
6A/16A 3-Pin Socket Outlet with Shutter	X2106WH	588	10	AAKY2106	700	10
16A 3-Pin Socket Outlet with Shutter	X2103WH	661	10	AAKY2103	861	10
Fan Regulators & Dimmers						
Step Fan Regulator (1M)	X3100WH	985	10	AAKY3100	1,206	10
Step type fan regulator (2M)	X3200WH	1,381	5	AAKY3200	1,651	5
Dimmer 400W (1M)	X3104WH	1,236	10	AAKY3104	1,608	10
Dimmer 400W (2M)	X3004WH	1,923	5	AAKY3004	3,182	5
USB Chargers						
2 Gang USB Charger - 2.1A (2M)	X7003WH	3,635	15	AAKY7003	4,332	15
Accessories						
RJ11 Telephone outlet (no shutter)	X4010WH	318	10	-	390	-
RJ11 Telephone outlet with shutter	X4011WH	316	10	AAKY4011	421	10
Twin RJ11 Telephone outlets (no shutter) (1M)	X4020WH	482	10	AAKY4020	813	20
RJ45 Data Outlet with shutter	X4045WH	1,088	20	AAKY4045	1,303	20
TV Socket	X4500WH	296	10	AAKY4500	401	10
RJ45 Cover for Key Stone Type	X4050WH	395	10	AAKY4050	480	-
Gripped Cord Outlet	X4550WH	357	10	-	396	-
Buzzer	X3300WH	1,353	2	AAKY3300	1,617	2
Blank off unit (1M)	X0001WH	84	10	AAKY0001	119	20
Neon Phase Indicator (Red)	X5001	512	20	-	-	-
Neon Phase Indicator (Green)	X5002	554	20	-	-	-
Neon Phase Indicator (Yellow)	X5003	554	20	-	-	-

Please contact Customer Care Center for Stockable and Non stockable status of references.

☑ NORMAL STOCK ITEMS

W.E.F. January 30th, 2023

Opale - Switches with Satin Finish



AAKX6002 + AAKX6004 + X0702



AAKX6006 + X0703



AAKX6005

Description	Reference	Unit MRP [₹]	Pack
Hotel Series*			
DND Panel	AAKX6001	861	20
DND Switch	AAKX6002	671	20
MMR Panel	AAKX6003	813	20
MMR Switch	AAKX6004	671	20
Key Tag Switch (Mechanical Type 20 A)	AAKX6005	1,617	1
Shaver Socket	AAKX6006	7,137	1

*Available in white colour only



X0733WH



AAKX0744



AAKX0754

Description	Reference for White	Unit MRP [₹]	Pack	Reference for Coke Grey	Unit MRP [₹]	Pack	Reference for Matt Silver	Unit MRP [₹]	Pack	Reference for Matt Gold	Unit MRP [₹]	Pack
Cover Plates												
1-2 M Grid & 1 M Cover Frame	X0701	207	10	AAKY0801	273	10	AAKX0741	676	10	AAKX0751	676	10
1-2 M Grid & 2 M Cover Frame	X0702	219	10	AAKY0802	287	10	AAKX0742	570	10	AAKX0752	570	10
3 M Grid & 3 M Cover Frame	X0703	259	10	AAKY0803	316	10	AAKX0743	681	10	AAKX0753	681	10
3 M Universal Grid & 3 M Cover Frame	X0733WH	372	10	AAKY0833	567	10	AAKX0744	868	10	AAKX0754	868	10
4 M Grid & 4 M Cover Frame	X0704	304	10	AAKY0804	406	10	AAKX0745	813	10	AAKX0755	1,036	10
6 M Grid & 6 M Cover Frame	X0706	423	5	AAKY0806	502	5	AAKX0746	1,284	5	AAKX0756	1,008	5
8 M Grid & 8 M Cover Frame - Horizontal	X0708	551	5	AAKY0808	654	5	AAKX0747	1,673	5	AAKX0757	1,313	5
8 M Grid & 8 M Cover Frame - Square	X0709	651	5	AAKY0809	845	5	AAKX0748	1,673	5	AAKX0758	1,673	5
12 M Grid & 12 M Cover Frame	X0712	766	5	AAKY0812	991	5	AAKX0749	2,288	5	AAKX0759	1,795	5
18 M Grid & 18 M Cover Frame	AAKX0718	998	5	-	-	-	-	-	-	-	-	

Please contact Customer Care Center for Stockable and Non stockable status of references.

NORMAL STOCK ITEMS

W.E.F. January 30th, 2023

Unica Pure - Irresistibly Beautiful



Wood



Glass



Metal Rhodium Black



Sandy Beige

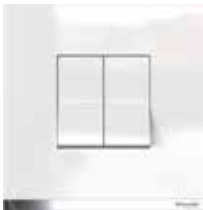

Polar White



Volcanic Grey



Pearl Black



Pewter Grey



Oak

Irresistibly Beautiful

- Authentic finishes - developed from the high quality natural material
- Ingenious Design - Demarcated dolly depicting clear on/off mode of the switch
- Modish Colors - perfectly gel with neutral, accent wall colors and blends perfectly with any decor

Irresistibly Safe & Sturdy

- Self Piercing Terminal - ensuring completely safe, robust and fast installation
- Facile & Guarded Technology - reduces tension in the switch rocker & increases the longevity of the switch
- Plated metal with Plastic over molded Gridplate - Robust, rigid & shock proof gridplate, ensuring durable installation on the metal box

Irresistibly Easy

- Key Hole Feature - Angular and linear adjustments of the gridplate can be easily achieved
- Revolutionary Ease of Mounting with Indicators & Markings

Irresistibly Sustainable

- Green Premium - Complies to HIGHEST INTERNATIONAL STANDARD of Green
- Certification for manufactured products (RoHS, REACH, PEP, EoL) and is 100% Recyclable

Irresistibly Innovative

- Future Ready - Features of Voice & Mobile control to fit with smart homes

Irresistibly Versatile

- One Stop Shop - Extensive range covering residential, office, commercial or hospitality
- **Intermediate switches to control multiple 2way switches**

Unica Pure switches with six patented technologies



Life Guarded Sockets

Eliminate possibility of Single Pin Insertion making it extra safe for children

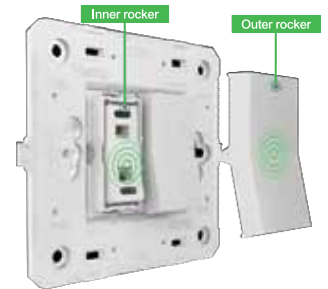

Facile & Guarded Technology

Reduces tension in the switch rocker & increases the longevity of the switch

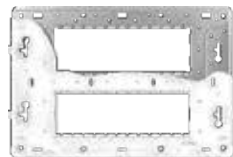

Key Hole Feature

Angular and linear adjustments of the gridplate can be easily achieved



Adjoining (V) Feature Technology

Ensuring perfect alignment of switches

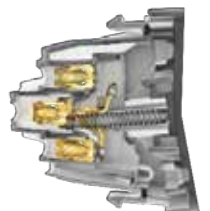

Self-piercing Terminal

Ensuring completely safe, robust and fast installation

Please contact Customer Care Center for Stockable and Non stockable status of references.

☑ NORMAL STOCK ITEMS

W.E.F. January 30th, 2023

Unica Pure - Irresistibly Beautiful



UNS61SW1M_WE

UNS161SWL1M_WE



UNS162MSWL1M_WE

UNS10SW1M_WE

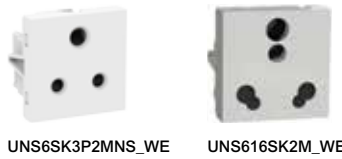

UNS6SK3P2MNS_WE

UNS616SK2M_WE



UNS162SW2M_WE

UNSMTSTART2M_WE

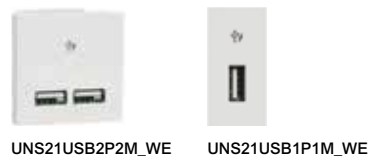

UNS21USB2P2M_WE

UNS21USB1P1M_WE



UNS5STFAN2M_WE

UNSLEDDIM1M_WE



UNSEMERGENCY2M_WE UNSACUSB1P1M_WE



UNSHDMI_WE

UNSCPTVDIG1M_WE



UNSSKTLT2M_WE

UNSDM1M

Description	Reference for Polar White	Unit MRP [₹]	Pack	Reference for Volcanic Grey	Unit MRP [₹]	Pack
6A Switches						
6AX 1 Way Switch	UNS61SW1M_WE	214	20	UNS61SW1M_GY	246	20
6AX 1 Way Switch With Indicator	UNS61SWL1M_WE	373	20	UNS61SWL1M_GY	428	20
6AX 2 Way Switch	UNS62SW1M_WE	305	10	UNS62SW1M_GY	341	10
6A Intermediate Switches						
10AX Intermediate Switch	UNS10SW1M_WE	1,337	1	UNS10SW1M_GY	1,612	1
16AX Switches						
16AX 1 Way Switch	UNS161SW1M_WE	356	20	UNS161SW1M_GY	416	20
16AX 1 Way Switch With Indicator	UNS161SWL1M_WE	426	20	UNS161SWL1M_GY	496	20
16AX 2 Way Switch, Polar White	UNS162SW1M_WE	463	10	UNS162SW1M_GY	545	10
16A Master Switch, 2 Way, With Locator & Label	UNS162MSWL1M_WE	1,069	20	UNS162MSWL1M_GY	1,263	1
16Ax 2 Way 2M Switch	UNS162SW2M_WE	463	10	UNS162SW2M_GY	550	10
Double Pole Switches						
20A Double Pole Switch With Indicator	UNS20DP2M_WE	843	10	UNS20DP2M_GY	992	1
32A Double Pole Switch With Indicator	UNS32DP2M_WE	1,289	10	UNS32DP2M_GY	1,537	10
Motor Starter Switch						
Motor Starter	UNSMTSTART2M_WE	1,884	10	UNSMTSTART2M_GY	2,229	10
Bell Switches						
6A Bellpress, 1M	UNS6BP1M_WE	316	20	UNS6BP1M_GY	370	20
6A Bellpress With Indicator, 1M	UNS6BPL1M_WE	429	20	UNS6BPL1M_GY	510	1
6A Bellpress, 2M, Polar White	UNS6BP2M_WE	426	10	UNS6BP2M_GY	500	1
6A Bellpress With Indicator, 2M	UNS6BPL2M_WE	525	10	UNS6BPL2M_GY	616	1
6A Sockets						
6A 3PIN Sockets outlet with Shutter (BIS)	UNS6SK3P2MNS_WE	450	10	UNS6SK3P2MNS_GY	496	10
6/16A Sockets						
6/16A Socket	UNS616SK2M_WE	527	10	UNS616SK2M_GY	655	10
USB Chargers						
2.1A 5V USB Charger, 2 Module	UNS21USB2P2M_WE	3,138	10	UNS21USB2P2M_GY	3,709	1
2.1A 5V USB Charger, 1 Module	UNS21USB1P1M_WE	2,210	20	UNS21USB1P1M_GY	2,620	20
2.4A 5V A+C USB Charger, 1 Module	UNSACUSB1P1M_WE	3,410	10	UNSACUSB1P1M_GY	3,834	10
Blank Plates						
Single Module Blank Plate	UNSBLANK1M_WE	77	20	UNSBLANK1M_GY	85	20
Fan Regulators						
4 Steps 360 Deg Fan Regulator, 1M	UNS4STFAN1M_WE	924	20	UNS4STFAN1M_GY	1,071	20
5 Steps 360 Deg Fan Regulator, 2M	UNS5STFAN2M_WE	1,465	10	UNS5STFAN2M_GY	1,653	10
Dimmers						
400W Dimmer for Incandescent, 1M	UNSDIM1M_WE	1,379	10	UNSDIM1M_GY	2,062	10
100W Dimmer for LED, 1M	UNSLEDDIM1M_WE	4,708	1	UNSLEDDIM1M_GY	5,625	10
Emergency Light Indicator						
Emergency Light Module*	UNSEMERGENCY2M_WE	9,894	1	-	-	-
Network, Connectivity & Media Series						
RJ 11 (WITH Shutter)	UNSRJ11_1M_WE	293	20	UNSRJ11_1M_GY	345	20
RJ 45 (WITH Shutter), Cat 6	UNSRJ45_1M_WE	1,071	20	UNSRJ45_1M_GY	1,240	20
TV Socket Coaxial	UNSTVCOAX1M_WE	303	20	UNSTVCOAX1M_GY	361	20
Volume Control	UNSVOLCTRL2M_WE	2,343	10	UNSVOLCTRL2M_GY	2,793	10
HDMI	UNSHDMI_WE	1,997	20	UNSHDMI_GY	2,252	20
TV Socket Digital (F-Connector)	UNSCPTVDIG1M_WE	337	1	UNSCPTVDIG1M_GY	405	10
Shaver Socket	UNSSHAYER_WE	7124	1	UNSSHAYER_GY	8391	1
PIR Motion Sensor*	UNSPIR_WE	9084	4	-	-	-
1 Socket + 1 Switch Prewired, 3M, Polar White	UNS1SK1SW3M_WE	1679	1	-	-	-

Please contact Customer Care Center for Stockable and Non stockable status of references.

✓ NORMAL STOCK ITEMS

W.E.F. January 30th, 2023

Unica Pure - Irresistibly Beautiful



UNSEKCSW_WE



UNSCURTAINSW2M_WE



UNSSHAVER_WE



UNSPIR_WE



UNSPHASEG1M



UNSPHASER1M

Description	Reference for Polar White	Unit MRP [₹]	Pack	Reference for Volcanic Grey	Unit MRP [₹]	Pack
Hotel Series*						
Skirt Light with LED, 2M	UNSSKTLT2M_WE	1,311	10	UNSSKTLT2M_GY	1,535	10
Buzzer	UNSBUZZER1M_WE	2,057	10	UNSBUZZER1M_GY	2,255	10
Cord Outlet	UNSCORD1M_WE	381	20	UNSCORD1M_GY	424	20
Door Chime	UNSCHIME2M_WE	539	10		-	-
DND / MMR Indicator*	UNSDM1M	1,416	20		-	-
DND/MMR Indicator v.2	UNSDM1M_WE	1,637		UNSDM1M_GY	1,870	
DND Switch	UNSDNDSW1M_WE	564	10	UNSDNDSW1M_GY	688	10
MMR Switch	UNSMMRSW1M_WE	564	10	UNSMMRSW1M_GY	688	10
Electronic Keycard Switch, White	UNSEKCSW_WE	7,421	5	UNSEKCSW_GY	8,578	5
Electronic Keycard Switch, Sandy Beige	UNSEKCSW_CL	7,568	5	UNSEKCSW_CD	7,466	5
Curtain Control Switch	UNSCURTAINSW2M_WE	928	10	UNSCURTAINSW2M_GY	1,076	10

Description	Reference	Unit MRP [₹]	Pack
LED Phase Indicator			
LED Phase Indicator, Red	UNSPHASER1M	484	20
LED Phase Indicator, Green	UNSPHASEG1M	484	20
LED Phase Indicator, Yellow	UNSPHASEY1M	484	20

Please contact Customer Care Center for Stockable and Non stockable status of references.

NORMAL STOCK ITEMS

W.E.F. January 30th, 2023

Unica Pure - Irresistibly Beautiful



UNPGP2M



UNPGP6M

Description	Reference for Gridplate	Unit MRP [₹]	Pack
Cover Plates			
2Module Gridplate (Fixing Frame) Only	UNPGP2M	170	4
3Module Gridplate (Fixing Frame) Only	UNPGP3M	208	9
4Module Gridplate (Fixing Frame) Only	UNPGP4M	239	8
6Module Gridplate (Fixing Frame) Only	UNPGP6M	324	9
8M Gridplate (Fixing Frame) Only, Linear	UNPGP8ML	335	9
8M Gridplate (Fixing Frame) Only, Square	UNPGP8MSQ	429	6
12Module Gridplate (Fixing Frame) Only	UNPGP12M	500	6



UNPSP2M_WD



UNPSP6M_WD

Description	Reference for Oak Wood	Unit MRP [₹]	Pack
Cover Plates			
1 Module Wood Cover Frame Only	UNPSP1M_WD	2,406	6
2 Module Wood Cover Frame Only	UNPSP2M_WD	2,557	6
3 Module Wood Cover Frame Only	UNPSP3M_WD	3,165	6
4 Module Wood Cover Frame Only	UNPSP4M_WD	3,662	6
6 Module Wood Cover Frame Only	UNPSP6M_WD	5,226	3
8 Module Wood Cover Frame Only, Linear	UNPSP8ML_WD	6,350	3
8 Module Wood Cover Frame Only, Square	UNPSP8MSQ_WD	7,576	6
12 Module Wood Cover Frame Only	UNPSP12M_WD	10,129	6



UNPSP2M_GW



UNPSP6M_GW

Description	Reference for Aqua Glass	Unit MRP [₹]	Pack
Cover Plates			
1Module Aqua Glass Cover Frame Only	UNPSP1M_GW	1,337	6
2Module Aqua Glass Cover Frame Only	UNPSP2M_GW	1,504	6
3Module Aqua Glass Cover Frame Only	UNPSP3M_GW	1,693	6
4Module Aqua Glass Cover Frame Only	UNPSP4M_GW	1,769	6
6Module Aqua Glass Cover Frame Only	UNPSP6M_GW	3,196	3
8M Aqua Glass Cover Frame Only, Linear	UNPSP8ML_GW	3,632	3
8M Aqua Glass Cover Frame Only, Square	UNPSP8MSQ_GW	4,600	6
12Module Aqua Glass Cover Frame Only	UNPSP12M_GW	5,705	6

Please contact Customer Care Center for Stockable and Non stockable status of references.

NORMAL STOCK ITEMS

W.E.F. January 30th, 2023

Unica Pure - Irresistibly Beautiful



UNPSP2M_GB



UNPSP6M_GB

Description	Reference for Pearl Black Glass	Unit MRP [₹]	Pack
Cover Plates			
1M Pearl Black Glass Cover Frame Only	UNPSP1M_GB	1,583	6
2M Pearl Black Glass Cover Frame Only	UNPSP2M_GB	1,780	6
3M Pearl Black Glass Cover Frame Only	UNPSP3M_GB	1,935	6
4M Pearl Black Glass Cover Frame Only	UNPSP4M_GB	2,097	6
6M Pearl Black Glass Cover Frame Only	UNPSP6M_GB	3,770	3
8M Pearl Black Glass CF Only, Linear	UNPSP8ML_GB	4,279	3
8M Pearl Black Glass CF Only, Suare	UNPSP8MSQ_GB	5,421	6
12M Pearl Black Glass Cover Frame Only	UNPSP12M_GB	6,714	6



UNPSP2M_ML



UNPSP6M_ML

Description	Reference for Pewter Grey Metal	Unit MRP [₹]	Pack
Cover Plates			
1 Module Pw Grey Metal Cover Frame Only	UNPSP1M_ML	2,377	6
2 Module Pw Grey Metal Cover Frame Only	UNPSP2M_ML	2,638	6
3 Module Pw Grey Metal Cover Frame Only	UNPSP3M_ML	3,002	6
4 Module Pw Grey Metal Cover Frame Only	UNPSP4M_ML	3,156	6
6 Module Pw Grey Metal Cover Frame Only	UNPSP6M_ML	5,589	3
8Module Pw Grey Metal CF Only, Linear	UNPSP8ML_ML	6,297	3
8 Module Pw Grey Metal CF Only, Suare	UNPSP8MSQ_ML	7,998	6
12Module Pw Grey Metal Cover Frame Only	UNPSP12M_ML	9,921	6



UNPSP2M_MD



UNPSP6M_MD

Description	Reference for Black Metal	Unit MRP [₹]	Pack
Cover Plates			
1Module Rh Black Metal Cover Frame Only	UNPSP1M_MD	2,377	6
2Module Rh Black Metal Cover Frame Only	UNPSP2M_MD	2,638	6
3Module Rh Black Metal Cover Frame Only	UNPSP3M_MD	3,002	6
4Module Rh Black Metal Cover Frame Only	UNPSP4M_MD	3,156	6
6Module Rh Black Metal Cover Frame Only	UNPSP6M_MD	5,589	3
8Module Rh Black Metal CF Only, Linear	UNPSP8ML_MD	6,297	3
8 Module Rh Black Metal CF Only, Suare	UNPSP8MSQ_MD	7,998	6
12M Rh Black Metal Cover Frame Only	UNPSP12M_MD	9,921	6

Please contact Customer Care Center for Stockable and Non stockable status of references.

NORMAL STOCK ITEMS

W.E.F. January 30th, 2023

Unica Pure - Irresistibly Beautiful



UNPCP3M_GW



UNPCP6M_GW



UNPCP3M_GB



UNPCP6M_GB

Description	Reference for Aqua Glass	Unit MRP [₹]	Pack	Reference for Pearl Black Glass	Unit MRP [₹]	Pack
Cover Plates						
1 Module Glass Surround and Gridplate	UNPCP1M_GW*	1,512	6	UNPCP1M_GB*	1,758	6
2 Module Glass Surround and Gridplate	UNPCP2M_GW*	1,679	6	UNPCP2M_GB*	1,955	6
3 Module Glass Surround and Gridplate	UNPCP3M_GW*	1,907	6	UNPCP3M_GB*	2,149	6
4 Module Glass Surround and Gridplate	UNPCP4M_GW*	2,015	6	UNPCP4M_GB*	2,344	6
6 Module Glass Surround and Gridplate	UNPCP6M_GW*	3,529	3	UNPCP6M_GB*	4,104	3
8 Module Glass Surround and Gridplate, Linear	UNPCP8ML_GW*	3,977	3	UNPCP8ML_GB*	4,623	3
8 Module Glass Surround and Gridplate, Square	UNPCP8MSQ_GW*	5,041	3	UNPCP8MSQ_GB*	5,862	6
12 Module Glass Surround and Gridplate	UNPCP12M_GW*	6,219	6	UNPCP12M_GB*	7,228	6



UNSCP3M_CL



UNSCP6M_CL



UNSCP3M_GY



UNSCP6M_GY

Description	Reference for Pewter Grey Metal	Unit MRP [₹]	Pack	Reference for Rhodium Black Metal	Unit MRP [₹]	Pack
Cover Plates						
1 Module Metal Surround and Gridplate	UNPCP1M_ML*	2,552	6	UNPCP1M_MD*	2,552	6
2 Module Metal Surround and Gridplate	UNPCP2M_ML*	2,813	6	UNPCP2M_MD*	2,813	6
3 Module Metal Surround and Gridplate	UNPCP3M_ML*	3,216	6	UNPCP3M_MD*	3,216	6
4 Module Metal Surround and Gridplate	UNPCP4M_ML*	3,402	6	UNPCP4M_MD*	3,402	6
6 Module Metal Surround and Gridplate	UNPCP6M_ML*	5,923	3	UNPCP6M_MD*	5,923	3
8 Module Metal Surround and Gridplate, Linear	UNPCP8ML_ML*	6,642	3	UNPCP8ML_MD*	6,642	3
8 Module Metal Surround and Gridplate, Square	UNPCP8MSQ_ML*	8,440	3	UNPCP8MSQ_MD*	8,440	3
12 Module Metal Surround and Gridplate	UNPCP12M_ML*	10,435	6	UNPCP12M_MD*	10,435	6

*all real material combined plates shall be discontinued once the existing stock is exhausted.

Please contact Customer Care Center for Stockable and Non stockable status of references.

NORMAL STOCK ITEMS

W.E.F. January 30th, 2023

Unica Pure - Irresistibly Beautiful



UNPCP3M_WD



UNPCP6M_WD

Description	Reference for Oak Wood	Unit MRP [₹]	Pack
Real Material Cover Plates			
1 Module Wood Surround and Gridplate	UNPCP1M_WD*	2,581	6
2 Module Wood Surround and Gridplate	UNPCP2M_WD*	2,732	6
3 Module Wood Surround and Gridplate	UNPCP3M_WD*	3,379	6
4 Module Wood Surround and Gridplate	UNPCP4M_WD*	3,909	6
6 Module Wood Surround and Gridplate	UNPCP6M_WD*	5,560	3
8 Module Wood Surround and Gridplate, Linear	UNPCP8ML_WD*	6,695	3
8 Module Wood Surround and Gridplate, Square	UNPCP8MSQ_WD*	8,018	6
12 Module Wood Surround and Gridplate	UNPCP12M_WD*	10,643	6

*All real material combined plates shall be discontinued once the existing stock is exhausted.



UNSCP3M_CL



UNSCP6M_CL



UNSCP3M_CD



UNSCP6M_CD



UNSCP3M_WE



UNSCP6M_WE



UNSCP3M_GY



UNSCP6M_GY

Description	Reference for Painted Sandy Biege	Unit MRP [₹]	Pack	Reference for Painted Mocha Brown	Unit MRP [₹]	Pack	Reference for Molded Polar White	Unit MRP [₹]	Pack	Reference for Molded Volcanic Grey	Unit MRP [₹]	Pack
Cover Plates												
1 Module Plastic Surround and Gridplate	UNSCP1M_CL	454	20	UNSCP1M_CD	446	20	UNSCP1M_WE	238	20	UNSCP1M_GY	338	20
2 Module Plastic Surround and Gridplate	UNSCP2M_CL	515	20	UNSCP2M_CD	497	20	UNSCP2M_WE	265	20	UNSCP2M_GY	378	20
3 Module Plastic Surround and Gridplate	UNSCP3M_CL	578	10	UNSCP3M_CD	580	10	UNSCP3M_WE	303	10	UNSCP3M_GY	431	10
4 Module Plastic Surround and Gridplate	UNSCP4M_CL	606	14	UNSCP4M_CD	606	14	UNSCP4M_WE	319	14	UNSCP4M_GY	460	14
6 Module Plastic Surround and Gridplate	UNSCP6M_CL	1,079	5	UNSCP6M_CD	1,043	5	UNSCP6M_WE	557	5	UNSCP6M_GY	794	5
8 Module Plastic Surround and Gridplate, Linear	UNSCP8ML_CL	1,198	5	UNSCP8ML_CD	1,176	5	UNSCP8ML_WE	627	5	UNSCP8ML_GY	887	5
8 Module Plastic Surround and Gridplate, Square	UNSCP8MSQ_CL	1,489	10	UNSCP8MSQ_CD	1,489	10	UNSCP8MSQ_WE	795	10	UNSCP8MSQ_GY	1,206	10
9 Module Plastic Surround and Gridplate	-	-	-	-	-	-	UNSCP9M_WE	993	5	UNSCP9M_GY	1551	5
12 Module Plastic Surround and Gridplate	UNSCP12M_CL	1,861	5	UNSCP12M_CD	1,864	5	UNSCP12M_WE	1,101	5	UNSCP12M_GY	1,936	5
16 Module Plastic Surround and Gridplate	UNSCP16M_CL	2,523	5	UNSCP16M_CD	2,523	5	UNSCP16M_WE	1,355	5	UNSCP16M_GY	2,338	5
18 Module Plastic Surround and Gridplate	UNSCP18M_CL	2,703	1	UNSCP18M_CD	2,703	1	UNSCP18M_WE	1,405	1	UNSCP18M_GY	2,496	1

Please contact Customer Care Center for Stockable and Non stockable status of references.

NORMAL STOCK ITEMS

W.E.F. January 30th, 2023

Wiring Diagram Unica Pure

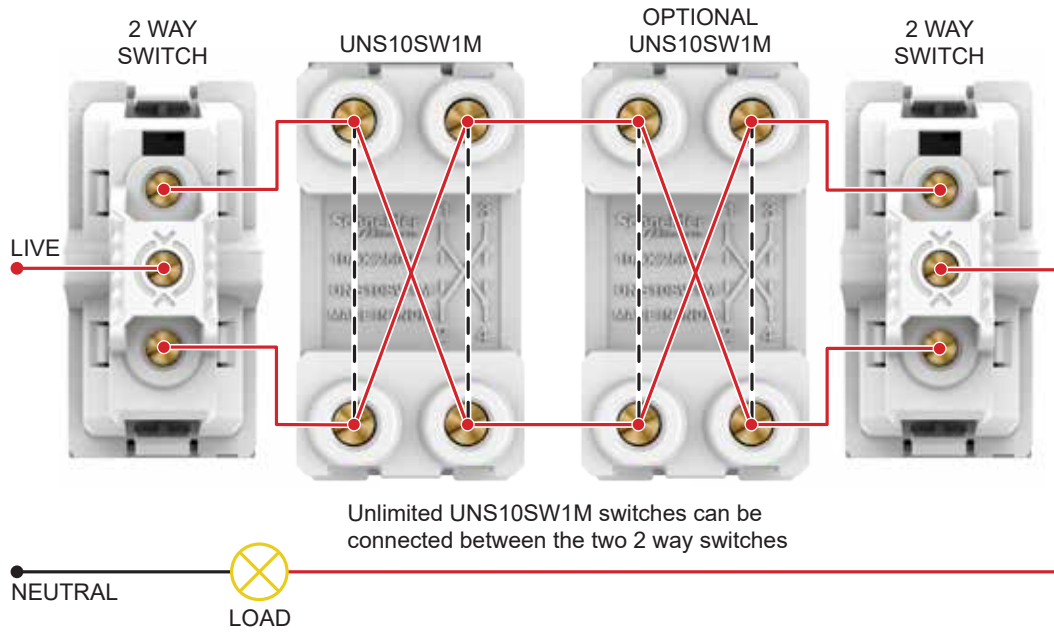

> 10AX Intermediate Switch
UNS10SW1M_WE, UNS10SW1M_GY

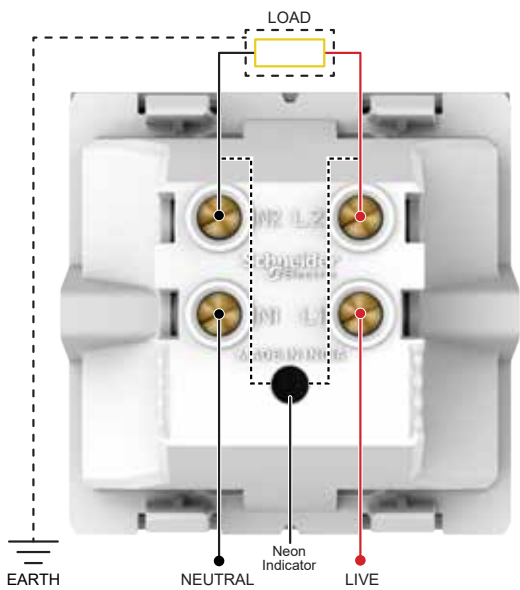

> 20A Double Pole Switch With Indicator
UNS20DP2M_WE, UNS20DP2M_GY

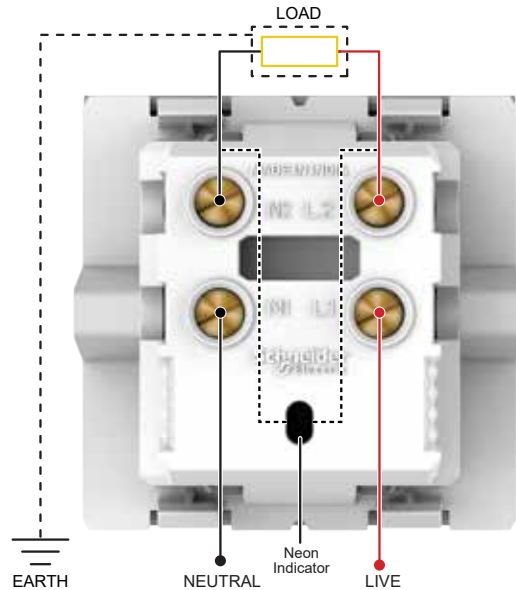

> 32A Double Pole Switch With Indicator
UNS32DP2M_WE, UNS32DP2M_GY

Please contact Customer Care Center for Stockable and Non stockable status of references.

☑ NORMAL STOCK ITEMS

W.E.F. January 30th, 2023

Wiring Diagram Unica Pure

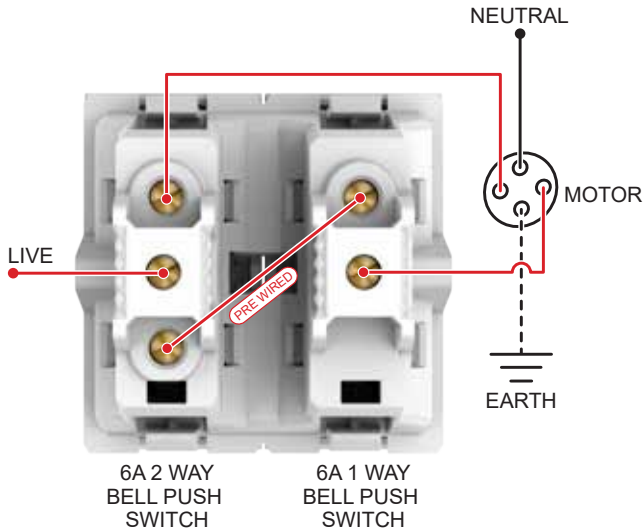

> Curtain Control Switch

UNSCURTAINSW2M_WE, UNSCURTAINSW2M_GY



> Emergency Light Module*

UNSEMERGENCY2M_WE

1. Normal Operation

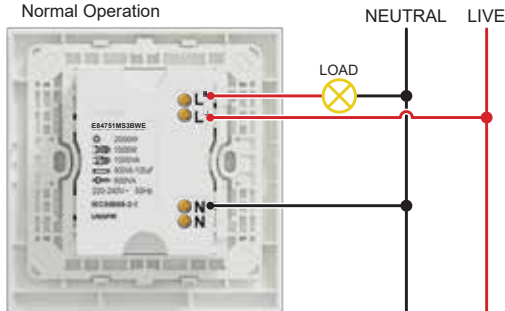

> PIR Motion Sensor*

UNSPIR_WE

3. One sensors control staircase timer (set time knob to 1s)

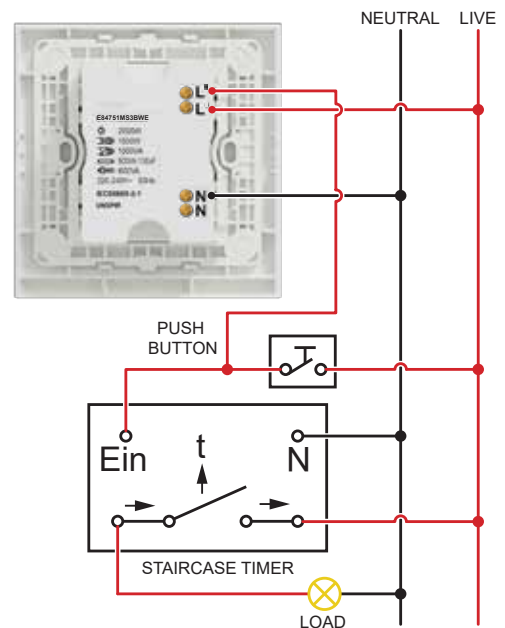

> PIR Motion Sensor*

UNSPIR_WE

2. Two sensors control one load

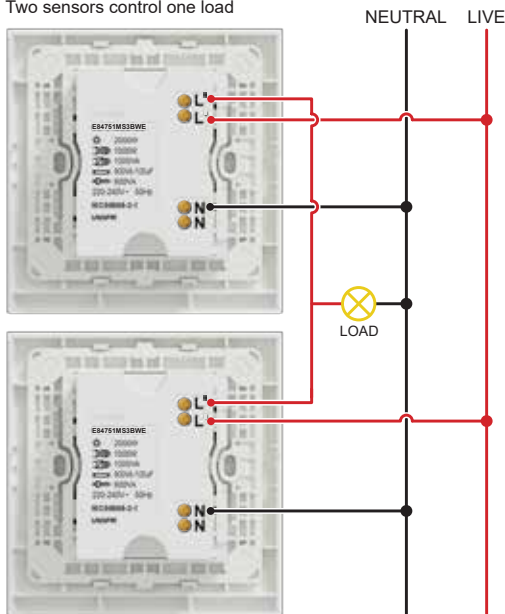

> PIR Motion Sensor*

UNSPIR_WE

Please contact Customer Care Center for Stockable and Non stockable status of references.

☑ NORMAL STOCK ITEMS

W.E.F. January 30th, 2023

Wiring Diagram Unica Pure

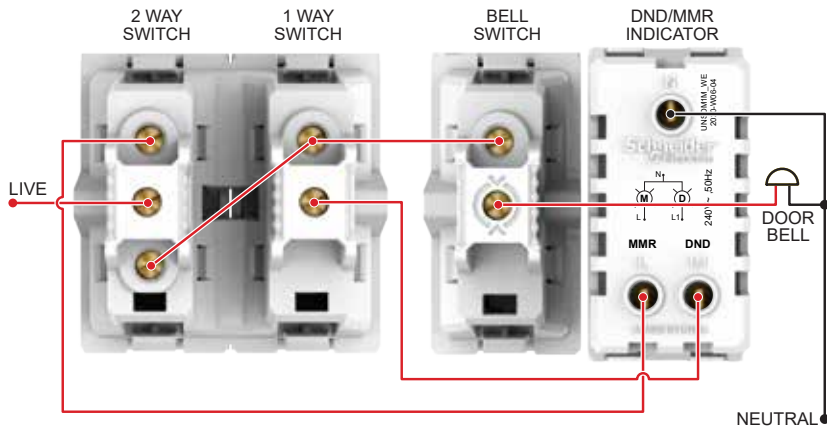

> DND/MMR Indicator v.2 > Do Not Disturb Switch
 > Make My Room Switch > DND Switch
 > MMR Switch

UNSDM1M_WE, UNSDM1M_GY, UNSDNDSW1M_WE,
 UNSDNDSW1M_GY, UNSMMRSW1M_WE, UNSMMRSW1M_GY

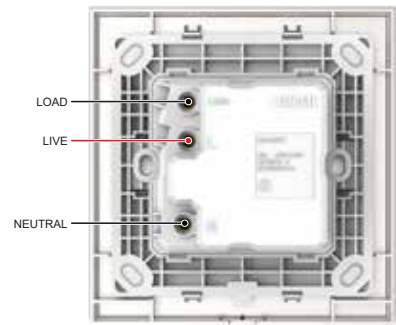

> Unica Pure Key Card

UNSEKCSW_WE, UNSEKCSW_GY,
 UNSEKCSW_CL, UNSEKCSW_CD

ZENcelo India - The Revolutionary Full-Flat Switch



- **World's First and only Full-Flat Mechanical Switch**
- **Patented Iso-Motion Technology** - Ensures switch stays in the same position whether On or Off
- **Robust & Strong** - Made of corrosion-resistant, heat-resistant and impact-resistant polycarbonate
- **Safe to Use** - Electric arc encapsulated switches and Data Sockets with patented integrated shutter
- **Designed to Last** - Switches tested to 80,000 times; Sockets tested to 15,000 cycles.
- **Green & Eco Friendly** - RoHS compliant range
- **Dust Proof Cover**
- **All Dark Grey references covered with electrostatic protective film**
- **Intermediate switches to control multiple 2way switches**
- **16AX~20A 1 Way 2G Switch (1M) - IN8444/16: Single: switch to control two loads**

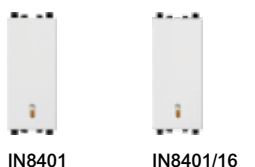

IN8401

IN8401/16



IN8444/16

IN8486/20



IN8405

IN8425



IN84SFR

IN8404D

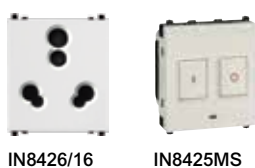

IN8426/16

IN8425MS



IN8431RJS4

IN8431ACUSB_BZ



INH8451

INH8454

Description	Reference for White	Unit MRP [₹]	Pack	Reference for Dark Grey	Unit MRP [₹]	Pack
Switches						
6AX 1 Way switch	IN8401	392	10	IN8401(BZ)	491	10
6AX 1 Way switch (2M)	IN8421	653	10	IN8421(BZ)	787	10
6AX 2 Way switch	IN8402	491	10	IN8402(BZ)	589	10
6AX 1 Way switch with Neon	IN8481	611	10	IN8481(BZ)	732	10
16AX~20A 1 Way switch	IN8401/16	592	10	IN8401/16(BZ)	721	10
16AX~20A 1 Way switch (2M)	IN8421/16	871	10	IN8421/16(BZ)	1,216	10
16AX~20A 1 Way switch with Neon	IN8481/16	834	10	IN8481/16(BZ)	989	10
16AX~20A 1 Way switch with Neon (2M)	IN8482/16	1,029	10	IN8482/16(BZ)	1,212	10
16AX~20A 2 Way switch	IN8402/16	826	10	IN8402/16(BZ)	1,022	10
16AX~20A 2 Way switch (2M)	IN8422/16	989	10	IN8422/16(BZ)	1,217	10
16AX~20A 1 Way 2G switch (1M)	IN8444/16	960	10	IN8444/16(BZ)	1,157	10
10AX Intermediate switch	IN8430/1M	1,451	10	IN8430/1M(BZ)	1,640	1
20A DP Switch with Neon (2M)	IN8486/20	1,286	5	IN8486/20(BZ)	1,591	5
32A DP Switch with Neon (2M)	IN8486/32	2,019	5	IN8486/32(BZ)	2,403	5
Motor Starter Switch						
25A Motor Starter switch (2M)	IN8425MS	3,274	10	IN8425MS(BZ)	3,484	10
Bell Push						
6A Bell Push switch	IN8405	557	10	IN8405(BZ)	672	10
6A Bell Push switch (2M)	IN8425	851	10	IN8425(BZ)	1,008	10
6A Bell Push switch with Neon	IN8485	758	10	IN8485(BZ)	894	10
6A Bell Push switch with Neon (2M)	IN8486	942	10	IN8486(BZ)	1,109	10
6A Momentary Switch, WH	IN8487	723	10	IN8487_BZ	854	10
Sockets						
6A 3PIN Socket Outlet with Shutter (BIS)	IN8426UNS	641	10	IN8426UNS_BZ	776	10
6A/16A 3 Pin Socket with Shutter	IN8426/16	954	10	IN8426/16(BZ)	1,168	10
Fan Regulators & Dimmers						
Fan Control (5 Speeds)	IN84SFR	2,268	5	IN84SFR(BZ)	2,722	5
Full Flat 400W Dimmer Module (1 Gang)	IN8404D	2,041	10	IN8404D(BZ)	2,418	10
USB Chargers						
1 Gang USB Charger - 2.1A (1M)	IN8431USB_WE	3,679	10	IN8431USB_BZ	4,220	10
2 Gang USB Charger - 2.1A (2M)	IN8432USB_WE	5,380	1	IN8432USB_BZ	6,191	10
2.4A 5V A+C USB Charger (1M)	IN8431ACUSB_WE	4,027	10	IN8431ACUSB_BZ	4,615	10
Accessories						
RJ11 Telephone Outlet with shutter (1 Gang)	IN8431RJS4	613	10	IN8431RJS4(BZ)	749	10
RJ45 Cat6 Data Outlet with shutter	IN8431RJ6	2,133	10	IN8431RJ6(BZ)	2,606	10
Data Outlet Wall Plate (for RJ45 key stone jack)	IN8431RJC	635	10	IN8431RJC(BZ)	747	10
TV Socket	IN8431TV	464	10	IN8431TV(BZ)	587	10
Cord Outlet	IN8445CO	559	10	IN8445CO(BZ)	679	10
Foot Lamp with White LED (2M)	IN8490FLW	4,287	10	-	-	-
Foot Lamp with Yellow LED (2M)	IN8490FLY	4,180	10	-	-	-
Blank off unit (1M)	IN8430X	143	10	IN8430X(BZ)	176	10
Hotel Series						
Do Not Disturb Panel	INH8451	3,105	10	INH8451(BZ)	3,678	10
Make My Room Panel	INH8454	2,823	10	INH8454(BZ)	3,332	10
Do Not Disturb Switch	INH8452	1,542	10	INH8452(BZ)	1,734	10
Do Not Disturb Switch (2M)	INH8453	1,856	10	INH8453(BZ)	1,855	10
Make My Room Switch	INH8455	1,506	10	INH8455(BZ)	1,777	10

Please contact Customer Care Center for Stockable and Non stockable status of references.

NORMAL STOCK ITEMS

W.E.F. January 30th, 2023

ZENcelo India - The Revolutionary Full-Flat Switch



IN8403C

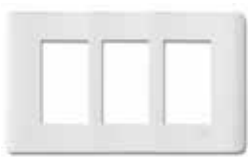

IN8406C



IN8402C(BZ)



IN8404C(SZ)



IN84012C(SA)

Description	Reference for White	Unit MRP [₹]	Pack	Reference for Dark Grey	Unit MRP [₹]	Pack	Reference for Silver Bronze	Unit MRP [₹]	Pack	Reference for Satin Silver	Unit MRP [₹]	Pack
Cover Plates												
1M Grid & 1M Cover Frame	IN8401C	368	10	IN8401C(BZ)	436	10	IN8401C(SZ)	1012	10	IN8401C(SA)	1060	10
2M Grid & 2M Cover Frame	IN8402C	382	10	IN8402C(BZ)	456	10	IN8402C(SZ)	1002	10	IN8402C(SA)	1049	10
3M Grid & 3M Cover Frame	IN8403C	450	10	IN8403C(BZ)	538	10	IN8403C(SZ)	1231	10	IN8403C(SA)	1289	10
4M Grid & 4M Cover Frame	IN8404C	490	10	IN8404C(BZ)	632	10	IN8404C(SZ)	1479	10	IN8404C(SA)	1550	10
6M Grid & 6M Cover Frame	IN8406C	748	5	IN8406C(BZ)	889	5	IN8406C(SZ)	2031	5	IN8406C(SA)	2127	5
8M Grid & 8M Cover Frame - Horizontal	IN8408HC	889	5	IN8408HC(BZ)	1063	5	IN8408HC(SZ)	2745	5	IN8408HC(SA)	2875	5
8M Grid & 8M Cover Frame - Square	IN8408SC	1175	5	IN8408SC(BZ)	1550	5	IN8408SC(SZ)	3333	5	IN8408SC(SA)	3491	5
9M Grid & 9M Cover Frame	IN8409C	1529	5	IN8409C(BZ)	1912	5	IN8409C(SZ)	4608	5	IN8409C(SA)	5446	5
12M Grid & 12M Cover Frame	IN84012C	1931	5	IN84012C(BZ)	2376	5	IN84012C(SZ)	6139	5	IN84012C(SA)	6432	5
18M Grid & 18M Cover Frame	IN84018C	2724	5	IN84018C(BZ)	3357	5	IN84018C(SZ)	8127	5	IN84018C(SA)	8514	5

ZENcelo - The Revolutionary Full-Flat Switch



E8431EKT-OS



E8432DMS>SZ-OS



E84T727H-OS



E84T727V>SZ-OS

Description	Reference for White	Unit MRP [₹]	Pack	Reference For Silver Bronze	Unit MRP [₹]	Pack
Hotel Series						
"Please Clean Up" Symbols	E8431BPDM-OS	6,115		E8431BPDM>SZ-OS	7,629	1
16A Electronic Key Card Time Delay Switch	E8431EKT-OS	12,219		E8431EKT>SZ-OS	15,275	1
Universal Shaver Unit, Vertical	E84T727V-OS	6,913		E84T727V>SZ-OS	8,611	1
Universal Shaver Unit, Horizontal	E84T727H-OS	6,913		E84T727H>SZ-OS	8, 611	1

Please contact Customer Care Center for Stockable and Non stockable status of references.

NORMAL STOCK ITEMS

W.E.F. January 30th, 2023

Wiring Diagram ZENcelo

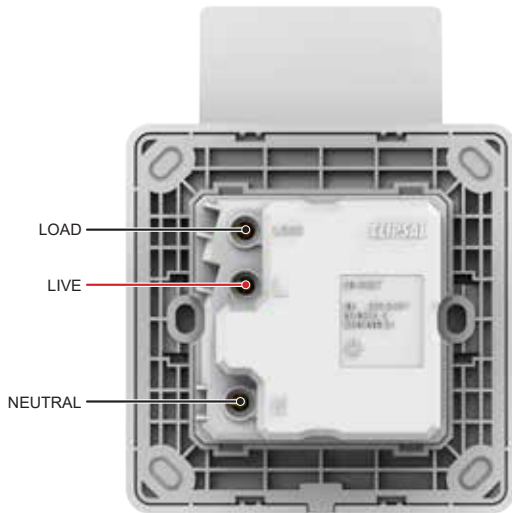

> 16A Electronic Key Card Time Delay
E8431EKT-OS, E8431EKT>SZ-OS

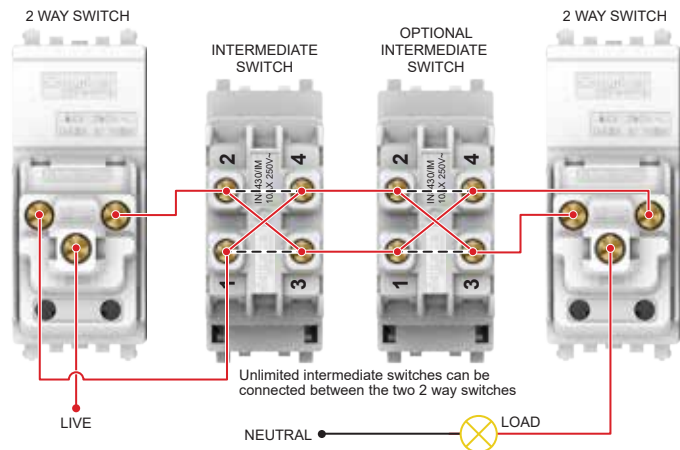

> 10AX Intermediate Switch
IN8430/IM, IN8430/IM (BZ)

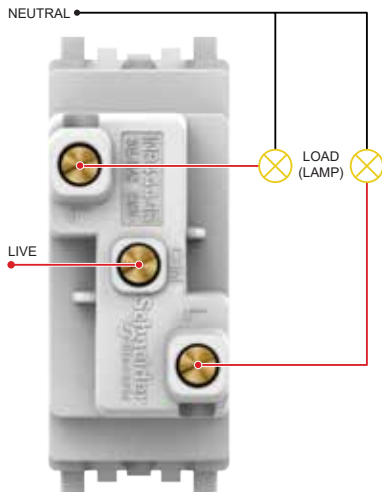

> 16AX~20A 1 Way 2G Switch (1M)
IN8444/16, IN8444/16 (BZ)

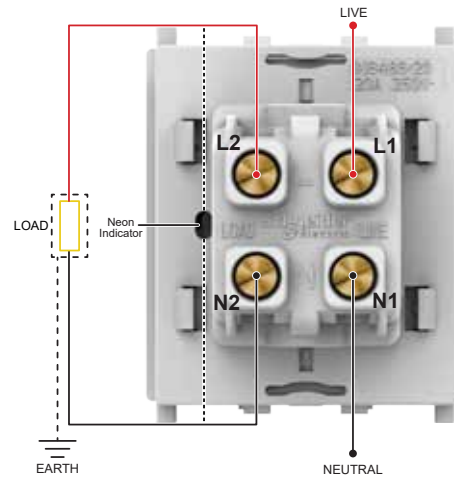

> 20A DP Switch with Neon (2M)
IN8486/20, IN8486/20 (BZ)

Please contact Customer Care Center for Stockable and Non stockable status of references.

☑ NORMAL STOCK ITEMS

W.E.F. January 30th, 2023

Wiring Diagram ZENcelo

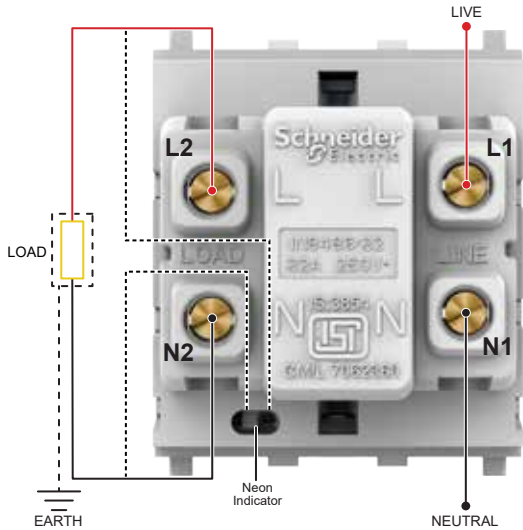

> 32A DP Switch with Neon (2M)

IN8486/32, IN8486/32 (BZ)

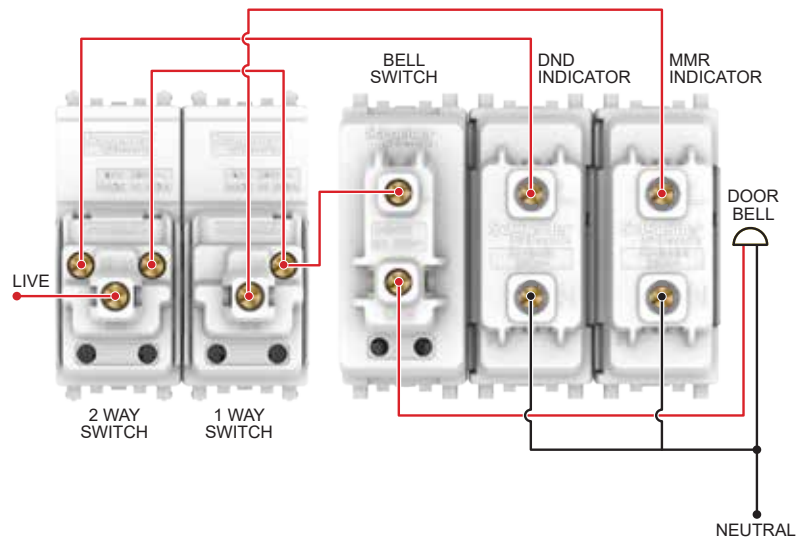

> Do Not Disturb Panel > Make My Room Panel

> Do Not Distrub Switch > Make My Room Switch

INH8451, INH8451 (BZ), INH8454, INH8454 (BZ),
INH8452, INH8452 (BZ), INH8455, INH8455 (BZ)

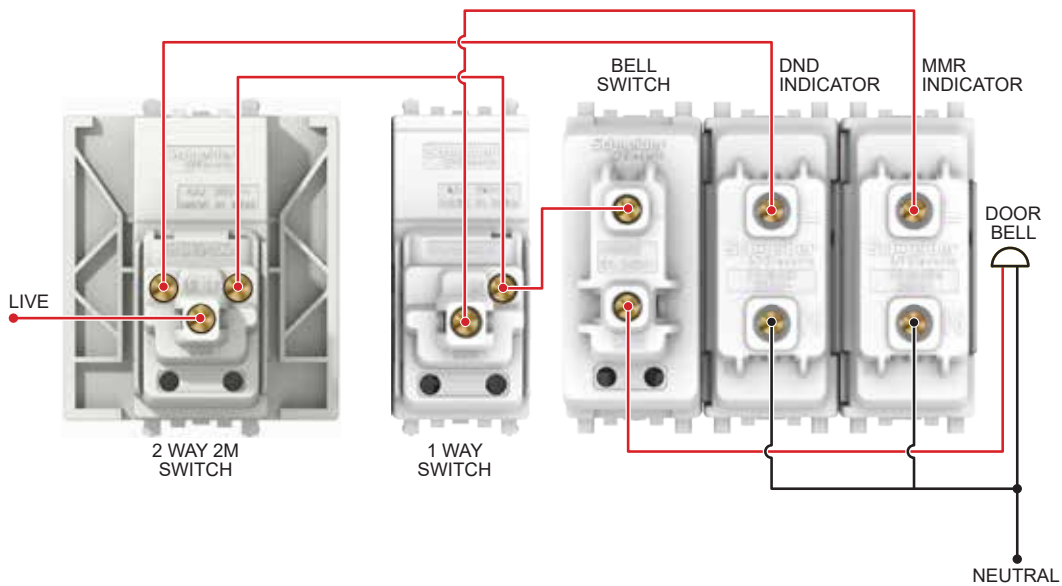

> Do Not Disturb Panel > Make My Room Panel

> Do Not Disturb Switch (2M) > Make My Room Switch

INH8451, INH8451 (BZ), INH8454, INH8454 (BZ)
INH8453, INH8453 (BZ), INH8455, INH8455 (BZ)

Please contact Customer Care Center for Stockable and Non stockable status of references.

☑ NORMAL STOCK ITEMS

W.E.F. January 30th, 2023

AvatarOn - It's also a Switch



White (WE)



Wine Gold (WG)



Dark Grey (DG)



Dark Wood (WD)



Gold Hairline (GH)



Light Wood (LW)



Award-winning Designs: In 2017, AvatarOn gained international recognition for its innovative design and quality excellence and was awarded the iF Design Award

Ingenious Beauty

- The ground-breaking AvatarOn series is a true marriage of aesthetics and practicality, making it a perfect choice for all home or office designs.

Safe and Reliable

- Our patented "Slim Rocker, Sure Click" SS technology not only gives AvatarOn a greater thinness overall, but also a near-zero contact jitter that reduces sparks, thus ensuring a safe and reliable use.

Customisable Covers for True Adaptability

- AvatarOn switches are available in an array of replaceable covers for full customisation and integration into any home decor. The customised pattern covers of AvatarOn provides you with an extra canvas to showcase your creativity in a subtle yet apparent way.

Modern Look

- The stylish and streamlined design of AvatarOn switch covers are finished in white, soft wood, dark wood and gold hairline materials for a classic look and universal elegance.

Tech-chic Design that Shines

- The AvatarOn soft LED locators merges seamlessly with its sleek giant dolly, creating a stylish and streamlined design and glow with a soft luminescent in the dark, indicating the exact location of each switch at night.

Multifunctional Accessories for Every Day Conveniences

Product Description	Color	Product Ref. No.	Unit MRP [₹]	Pack
16A Switches (Base + Cover Plate)				
16AX 250V 1 Gang 1 Way Switch	White	E8331L1_WE_G8	555	1
	Wine Gold	E8331L1_WG_G8	834	10
	Dark Grey	E8331L1_DG_G8	834	1
	Metal Gold Hairline	E8331L1_GH_G8	834	10
	Light Wood	E8331L1_LW_G8	834	10
	Dark Wood	E8331L1_WD_G8	834	10
16AX 250V 1 Gang 1 Way Switch with LED Indicator	White	E8331L1LED_WE_G8	834	1
	Wine Gold	E8331L1LED_WG_G8	1,247	10
	Dark Grey	E8331L1LED_DG_G8	1,247	1
	Metal Gold Hairline	E8331L1LED_GH_G8	1,247	10
	Light Wood	E8331L1LED_LW_G8	1,247	10
	Dark Wood	E8331L1LED_WD_G8	1,247	10
16AX 250V 1 Gang 2 Way Switch	White	E8331L2_WE_G8	593	1
	Wine Gold	E8331L2_WG_G8	890	10
	Dark Grey	E8331L2_DG_G8	890	1
	Metal Gold Hairline	E8331L2_GH_G8	890	10
	Light Wood	E8331L2_LW_G8	890	10
	Dark Wood	E8331L2_WD_G8	890	10
16AX 250V 1 Gang 2 Way Switch with LED Indicator	White	E8331L2LED_WE_G8	890	10
	Wine Gold	E8331L2LED_WG_G8	1,336	10
	Dark Grey	E8331L2LED_DG_G8	1,336	1
	Metal Gold Hairline	E8331L2LED_GH_G8	1,336	10
	Light Wood	E8331L2LED_LW_G8	1,336	10
	Dark Wood	E8331L2LED_WD_G8	1,336	10
16AX 250V 2 Gang 1 Way Switch	White	E8332L1_WE_G8	857	1
	Wine Gold	E8332L1_WG_G8	1,287	10
	Dark Grey	E8332L1_DG_G8	1,287	1
	Metal Gold Hairline	E8332L1_GH_G8	1,287	10
	Light Wood	E8332L1_LW_G8	1,287	10
	Dark Wood	E8332L1_WD_G8	1,287	10
16AX 250V 2 Gang 1 Way Switch with LED Indicator	White	E8332L1LED_WE_G8	1,287	1
	Wine Gold	E8332L1LED_WG_G8	1,931	10
	Dark Grey	E8332L1LED_DG_G8	1,931	1
	Metal Gold Hairline	E8332L1LED_GH_G8	1,931	10
	Light Wood	E8332L1LED_LW_G8	1,931	10
	Dark Wood	E8332L1LED_WD_G8	1,931	10
16AX 250V 2 Gang 2 Way Switch	White	E8332L2_WE_G8	1,043	1
	Wine Gold	E8332L2_WG_G8	1,565	10
	Dark Grey	E8332L2_DG_G8	1,565	1
	Metal Gold Hairline	E8332L2_GH_G8	1,565	10
	Light Wood	E8332L2_LW_G8	1,565	10
	Dark Wood	E8332L2_WD_G8	1,565	10

Please contact Customer Care Center for Stockable and Non stockable status of references.

NORMAL STOCK ITEMS

W.E.F. January 30th, 2023

AvatarOn - It's also a Switch

		Product Description	Color	Product Ref. No.	Unit MRP [₹]	Pack
16A Switches (Base + Cover Plate)						
 E8332L2LED_WE_G8	 E8332L2LED_WD_G8	16AX 250V 2 Gang 2 Way Switch with LED Indicator	White	E8332L2LED_WE_G8	1,565	10
			Wine Gold	E8332L2LED_WG_G8	2,349	10
			Dark Grey	E8332L2LED_DG_G8	2,349	1
			Metal Gold Hairline	E8332L2LED_GH_G8	2,349	10
			Light Wood	E8332L2LED_LW_G8	2,241	10
			Dark Wood	E8332L2LED_WD_G8	2,349	10
 E8333L1LED_WE_G8	 E8333L1LED_WD_G8	16AX 250V 3 gang 1 Way Switch	White	E8333L1_WE_G8	1,407	1
			Wine Gold	E8333L1_WG_G8	2,111	10
			Dark Grey	E8333L1_DG_G8	2,111	1
			Metal Gold Hairline	E8333L1_GH_G8	2,111	10
			Light Wood	E8333L1_LW_G8	2,111	10
			Dark Wood	E8333L1_WD_G8	2,111	10
 E8333L2_WE_G8	 E8333L2_WD_G8	16AX 250V 3 gang 1 Way Switch with LED Indicator	White	E8333L1LED_WE_G8	2,111	10
			Wine Gold	E8333L1LED_WG_G8	3,165	10
			Dark Grey	E8333L1LED_DG_G8	3,165	1
			Metal Gold Hairline	E8333L1LED_GH_G8	3,165	10
			Light Wood	E8333L1LED_LW_G8	3,165	10
			Dark Wood	E8333L1LED_WD_G8	3,165	10
 E8333L2LED_WE_G8	 E8333L2LED_WD_G8	16AX 250V 3 gang 2 Way Switch	White	E8333L2_WE_G8	1,514	1
			Wine Gold	E8333L2_WG_G8	2,273	10
			Dark Grey	E8333L2_DG_G8	2,273	1
			Metal Gold Hairline	E8333L2_GH_G8	2,273	10
			Light Wood	E8333L2_LW_G8	2,273	10
			Dark Wood	E8333L2_WD_G8	2,273	10
 E8333L2LED_WE_G8	 E8333L2LED_WD_G8	1 6AX 250V 3 gang 2 Way Switch with LED Indicator	White	E8333L2LED_WE_G8	2,273	10
			Wine Gold	E8333L2LED_WG_G8	3,408	10
			Dark Grey	E8333L2LED_DG_G8	3,408	1
			Metal Gold Hairline	E8333L2LED_GH_G8	3,408	10
			Light Wood	E8333L2LED_LW_G8	3,253	10
			Dark Wood	E8333L2LED_WD_G8	3,408	10
 E8334L1_WE_G8	 E8334L1_WD_G8	16AX 250V 4 Gang 1 Way Switch	White	E8334L1_WE_G8	2,024	1
			Wine Gold	E8334L1_WG_G8	3,037	10
			Dark Grey	E8334L1_DG_G8	3,037	1
			Metal Gold Hairline	E8334L1_GH_G8	3,037	10
			Light Wood	E8334L1_LW_G8	3,037	10
			Dark Wood	E8334L1_WD_G8	3,037	10
 E8334L1LED_WE_G8	 E8334L1LED_WD_G8	16AX 250V 4 Gang 1 Way Switch with LED Indicator	White	E8334L1LED_WE_G8	3,037	10
			Wine Gold	E8334L1LED_WG_G8	4,554	10
			Dark Grey	E8334L1LED_DG_G8	4,554	1
			Metal Gold Hairline	E8334L1LED_GH_G8	4,554	10
			Light Wood	E8334L1LED_LW_G8	4,554	10
			Dark Wood	E8334L1LED_WD_G8	4,554	10
 E8334L2_WE_G8	 E8334L2_WD_G8	16AX 250V 4 Gang 2 Way Switch	White	E8334L2_WE_G8	2,328	1
			Wine Gold	E8334L2_WG_G8	3,491	10
			Dark Grey	E8334L2_DG_G8	3,491	1
			Metal Gold Hairline	E8334L2_GH_G8	3,491	10
			Light Wood	E8334L2_LW_G8	3,491	10
			Dark Wood	E8334L2_WD_G8	3,491	10
 E8334L2LED_WE_G8	 E8334L2LED_WD_G8	16AX 250V 4 Gang 2 Way Switch with LED Indicator	White	E8334L2LED_WE_G8	3,491	10
			Wine Gold	E8334L2LED_WG_G8	5,237	10
			Dark Grey	E8334L2LED_DG_G8	5,237	1
			Metal Gold Hairline	E8334L2LED_GH_G8	5,237	10
			Light Wood	E8334L2LED_LW_G8	5,237	10
			Dark Wood	E8334L2LED_WD_G8	5,237	10

Please contact Customer Care Center for Stockable and Non stockable status of references.

NORMAL STOCK ITEMS

W.E.F. January 30th, 2023

AvatarOn - It's also a Switch

		Product Description	Color	Product Ref. No.	Unit MRP [₹]	Pack
16A Intermediate Switches						
 E8331M_WE_G8	 E8331M_WD_G8	16AX 250V 1 Gang Intermediate Switch	White	E8331M_WE_G8	1,647	1
			Wine Gold	E8331M_WG_G8	2,470	1
			Dark Grey	E8331M_DG_G8	2,470	1
			Metal Gold Hairline	E8331M_GH_G8	2,357	1
			Light Wood	E8331M_LW_G8	2,357	1
			Dark Wood	E8331M_WD_G8	2,357	1
10A Momentary Switches						
 E8331PRL1_WE_G8	 E8331PRL1_WD_G8	10A 250V 1 Gang Momentary Switch	White	E8331PRL1_WE_G8	605	10
			Wine Gold	E8331PRL1_WG_G8	905	10
			Dark Grey	E8331PRL1_DG_G8	905	1
			Metal Gold Hairline	E8331PRL1_GH_G8	905	10
			Light Wood	E8331PRL1_LW_G8	864	10
			Dark Wood	E8331PRL1_WD_G8	864	10
 E8332PRL1_WE_G8	 E8332PRL1_WD_G8	10A 250V 2 Gang Momentary Switch	White	E8332PRL1_WE_G8	725	10
			Wine Gold	E8332PRL1_WG_G8	1,086	10
			Dark Grey	E8332PRL1_DG_G8	1,086	1
			Metal Gold Hairline	E8332PRL1_GH_G8	1,086	10
			Light Wood	E8332PRL1_LW_G8	1,086	10
			Dark Wood	E8332PRL1_WD_G8	1,086	10
Double Pole Switches						
 E8331D20N_WE_G8	 E8331D20N_WD_G8	20A 250V 1 Gang Double Pole Switch with LED Indicator	White	E8331D20N_WE_G8	1,421	10
			Wine Gold	E8331D20N_WG_G8	2,129	10
			Dark Grey	E8331D20N_DG_G8	2,129	1
			Metal Gold Hairline	E8331D20N_GH_G8	2,129	10
			Light Wood	E8331D20N_LW_G8	2,034	10
			Dark Wood	E8331D20N_WD_G8	2,129	10
 E8331D32N_WE_G8	 E8332D20N_WD_G8	20A 250V 2 Gang Double Pole Switch with LED Indicator	White	E8332D20N_WE_G8	1,809	10
			Wine Gold	E8332D20N_WG_G8	2,556	10
			Dark Grey	E8332D20N_DG_G8	2,556	1
			Metal Gold Hairline	E8332D20N_GH_G8	2,556	10
			Light Wood	E8332D20N_LW_G8	2,556	10
			Dark Wood	E8332D20N_WD_G8	2,556	10
 E8332D20N_WE_G8	 E8331D32N_WD_G8	32A 250V 1 Gang Double Pole Switch with LED Indicator	White	E8331D32N_WE_G8	1,885	10
			Wine Gold	E8331D32N_WG_G8	2,827	10
			Dark Grey	E8331D32N_DG_G8	2,827	1
			Metal Gold Hairline	E8331D32N_GH_G8	2,827	10
			Light Wood	E8331D32N_LW_G8	2,827	10
			Dark Wood	E8331D32N_WD_G8	2,827	10
 E8331D45N_WE_G8	 E8331D45N_WD_G8	45A 250V 1 Gang Double Pole Switch with LED Indicator	White	E8331D45N_WE_G8	2,355	10
			Wine Gold	E8331D45N_WG_G8	3,534	10
			Dark Grey	E8331D45N_DG_G8	3,534	1
			Metal Gold Hairline	E8331D45N_GH_G8	3,534	10
			Light Wood	E8331D45N_LW_G8	3,534	10
			Dark Wood	E8331D45N_WD_G8	3,373	10

Please contact Customer Care Center for Stockable and Non stockable status of references.

NORMAL STOCK ITEMS

W.E.F. January 30th, 2023

AvatarOn - It's also a Switch

Product Description	Color	Product Ref. No.	Unit MRP [₹]	Pack
				
E8331BPL1_WE_G8	E8331BPL1_WD_G8			
Bell Push Switch				
10A 250V Door Bell Push Switch	White	E8331BPL1_WE_G8	605	1
	Wine Gold	E8331BPL1_WG_G8	905	10
	Dark Grey	E8331BPL1_DG_G8	905	1
	Metal Gold Hairline	E8331BPL1_GH_G8	905	10
	Light Wood	E8331BPL1_LW_G8	905	10
	Dark Wood	E8331BPL1_WD_G8	905	10
Sockets				
6A 2/3 Pin Switched Socket	White	E8315_6_WE	1,220	8
	Wine Gold	E8315_6_WG	1,551	8
	Dark Grey	E8315_6_DG	1,551	1
	Metal Gold Hairline	E8315_6_GH	1,551	8
	Light Wood	E8315_6_LW	1,551	8
	Dark Wood	E8315_6_WD	1,551	8
6/16A Switched Socket	White	E8315_16_WE	1,531	8
	Wine Gold	E8315_16_WG	1,947	8
	Dark Grey	E8315_16_DG	1,947	1
	Metal Gold Hairline	E8315_16_GH	1,947	8
	Light Wood	E8315_16_LW	1,947	8
	Dark Wood	E8315_16_WD	1,947	8
Fan Regulators				
5 Steps 360 Deg Fan Regulator	White	E8331FR350_WE_G8	2,907	1
	Wine Gold	E8331FR350_WG_G8	3,831	1
	Dark Grey	E8331FR350_DG_G8	3,831	1
	Metal Gold Hairline	E8331FR350_GH_G8	3,831	1
	Light Wood	E8331FR350_LW_G8	3,831	1
	Dark Wood	E8331FR350_WD_G8	3,831	1
Switch & Socket Covers (Additional)				
1 Gang Switch Cover	White	E8331_WE	160	1
	Wine Gold	E8331_WG	399	1
	Dark Grey	E8331_DG	381	1
	Metal Gold Hairline	E8331_GH	399	1
	Light Wood	E8331_LW	364	1
	Dark Wood	E8331_WD	399	1
1 Gang Switch Cover with Keyholder	White	E8331KH_WE	352	1
	Wine Gold	E8331KH_WG	636	1
	Dark Grey	E8331KH_DG	513	1
	Metal Gold Hairline	E8331KH_GH	607	1
	Light Wood	E8331KH_LW	490	1
	Dark Wood	E8331KH_WD	636	1
2 Gang Switch Cover	White	E8332_WE	242	1
	Wine Gold	E8332_WG	545	1
	Dark Grey	E8332_DG	520	1
	Metal Gold Hairline	E8332_GH	545	1
	Light Wood	E8332_LW	520	1
	Dark Wood	E8332_WD	545	1
3 Gang Switch Cover	White	E8333_WE	374	1
	Wine Gold	E8333_WG	801	1
	Dark Grey	E8333_DG	764	1
	Metal Gold Hairline	E8333_GH	801	1
	Light Wood	E8333_LW	764	1
	Dark Wood	E8333_WD	946	1
3 Gang Switch Cover with Keyholder	White	E8333KH_WE	487	1
	Wine Gold	E8333KH_WG	1,109	1
	Dark Grey	E8333KH_DG	896	1
	Metal Gold Hairline	E8333KH_GH	1,060	1
	Light Wood	E8333KH_LW	856	1
	Dark Wood	E8333KH_WD	1,109	1

Please contact Customer Care Center for Stockable and Non stockable status of references.

NORMAL STOCK ITEMS

W.E.F. January 30th, 2023

AvatarOn - It's also a Switch



E8334_WE



E8334_WD



E8315C_6_WE



E8315C_6_WD



E8315C_16_WE



E8315C_16_WD



E8332USB_WE_G8



E8332USB_WD_G8



E8331_26_WE



E8332ACQUSB_WE

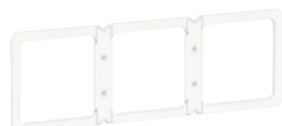

E8331_36_WE



E8331_46_WE



E8330TX_WE

Product Description	Color	Product Ref. No.	Unit MRP [₹]	Pack
4G Switch Cover	White	E8334_WE	527	1
	Wine Gold	E8334_WG	1,092	1
	Dark Grey	E8334_DG	1,043	1
	Metal Gold Hairline	E8334_GH	1,092	1
	Light Wood	E8334_LW	1,043	1
	Dark Wood	E8334_WD	1,092	1
6A 2/3 Pin Switched Socket Cover	White	E8315C_6_WE	429	12
	Wine Gold	E8315C_6_WG	728	12
	Dark Grey	E8315C_6_DG	728	1
	Metal Gold Hairline	E8315C_6_GH	728	12
	Light Wood	E8315C_6_LW	728	12
	Dark Wood	E8315C_6_WD	728	12
	6/16A Switched Socket Cover	White	E8315C_16_WE	463
Wine Gold		E8315C_16_WG	760	12
Dark Grey		E8315C_16_DG	760	1
Metal Gold Hairline		E8315C_16_GH	760	12
Light Wood		E8315C_16_LW	726	12
Dark Wood		E8315C_16_WD	760	12
USB Chargers				
2 Ports Max 2.1A USB Charger with Mobile Holder	White	E83311USB_WE_G8	5,723	1
	Wine Gold	E83311USB_WG_G8	8,584	1
	Dark Grey	E83311USB_DG_G8	8,584	1
2 x 2.1A USB Charger with Mobile Holder (2.1A with 2 outputs used simultaneously)	White	E8332USB_WE_G8	7,154	1
	Wine Gold	E8332USB_WG_G8	10,731	1
	Dark Grey	E8332USB_DG_G8	10,731	1
	Metal Gold Hairline	E8332USB_GH_G8	10,731	1
	Light Wood	E8332USB_LW_G8	10,731	1
	Dark Wood	E8332USB_WD_G8	10,731	1
	21W Type A+C, PD+QC3.0 USB Charger	Metal Gold Hairline	E8332ACQUSB_GH	6,542
Light Wood		E8332ACQUSB_LW	6,542	-
Dark Wood		E8332ACQUSB_WD	6,542	-
White		E8332ACQUSB_WE	5,288	-
Wine Gold		E8332ACQUSB_WG	6,542	-
Bracket/Frame (to ensure alignment of switches on 2/3/4 Gang metal box)				
2 Gang Bracket/Frame	White	E8331_26_WE	265	1
	Wine Gold	E8331_26_WG	347	1
	Dark Grey	E8331_26_DG	331	1
3 Gang Bracket/Frame	White	E8331_36_WE	292	1
	Wine Gold	E8331_36_WG	408	1
	Dark Grey	E8331_36_DG	390	1
4 Gang Bracket/Frame	White	E8331_46_WE	311	1
	Wine Gold	E8331_46_WG	438	1
	Dark Grey	E8331_46_DG	418	1
Blank Plates				
1 Gang Blank Plate	White	E8330X_WE	366	1
	Wine Gold	E8330X_WG	550	1
	Dark Grey	E8330X_DG	550	1
	Metal Gold Hairline	E8330X_GH	576	1
	Light Wood	E8330X_LW	550	1
	Dark Wood	E8330X_WD	576	1
2 Gang Blank Plate	White	E8330TX_WE	511	10
	Wine Gold	E8330TX_WG	794	10
	Dark Grey	E8330TX_DG	794	1
	Metal Gold Hairline	E8330TX_GH	794	10
	Light Wood	E8330TX_LW	759	10
	Dark Wood	E8330TX_WD	794	10

Please contact Customer Care Center for Stockable and Non stockable status of references.

NORMAL STOCK ITEMS

W.E.F. January 30th, 2023

AvatarOn - It's also a Switch



E8331BPDMW_ WE_G8



E8331BPDMW_ WD_G8



E8331KPB_WE



E8331KPB_WD



E8332C_WE_G8



E8332C_WD_G8



E83T727V_WE



E83T727V_WD



E8330FSG_WE



E8330FSG_WD



E8330FSGN_WE



E8330FSGN_WD



E8331TB_WE



E8331TB_WD



E8331RJS4_WE



E8331RJS4_WD

Product Description	Color	Product Ref. No.	Unit MRP [₹]	Pack
Hotel Series				
DND, PCU, PW Indicator with Bell Switch (Do Not Disturb, Please Clean Up, Please Wait)	White	E8331BPDMW_WE_G8	5,209	1
	Wine Gold	E8331BPDMW_WG_G8	7,813	10
	Dark Grey	E8331BPDMW_DG_G8	7,813	1
	Metal Gold Hairline	E8331BPDMW_GH_G8	7,813	10
	Light Wood	E8331BPDMW_LW_G8	7,457	10
	Dark Wood	E8331BPDMW_WD_G8	7,813	10
16AX 3 Gang Switch with PCU, DND, PW Sym (Do Not Disturb, Please Clean Up, Please Wait)	White	E8333DMWS_WE_G8	5,051	1
	Wine Gold	E8333DMWS_WG_G8	7,233	10
	Dark Grey	E8333DMWS_DG_G8	7,578	1
	Metal Gold Hairline	E8333DMWS_GH_G8	7,578	10
	Light Wood	E8333DMWS_LW_G8	7,233	10
	Dark Wood	E8333DMWS_WD_G8	7,578	10
250V 16A Electronic Keycard Switch	White	E8331EKT_WE	9,100	1
	Wine Gold	E8331EKT_WG	13,651	1
	Dark Grey	E8331EKT_DG	13,650	1
	Metal Gold Hairline	E8331EKT_GH	13,650	8
	Light Wood	E8331EKT_LW	13,031	8
	Dark Wood	E8331EKT_WD	14,300	1
Panic Button with Key Reset	White	E8331KPB_WE	1,307	1
	Wine Gold	E8331KPB_WG	2,080	1
	Dark Grey	E8331KPB_DG	1,986	1
	Metal Gold Hairline	E8331KPB_GH	2,458	1
	Light Wood	E8331KPB_LW	1,986	1
	Dark Wood	E8331KPB_WD	2,458	1
10A 2 Gang Mechanical Curtain Switch	White	E8332C_WE_G8	1,080	1
	Wine Gold	E8332C_WG_G8	1,619	10
	Dark Grey	E8332C_DG_G8	1,619	1
	Metal Gold Hairline	E8332C_GH_G8	1,619	10
	Light Wood	E8332C_LW_G8	1,546	10
	Dark Wood	E8332C_WD_G8	1,619	10
115/240V 20VA Universal Version Shaver	White	E83T727V_WE	5,145	1
	Wine Gold	E83T727V_WG	8,181	1
	Dark Grey	E83T727V_DG	8,571	1
	Metal Gold Hairline	E83T727V_GH	8,571	1
	Light Wood	E83T727V_LW	8,181	1
	Dark Wood	E83T727V_WD	8,979	1
Connection Units				
13A 250V 1 Gang Fused Connection Unit	White	E8330FSG_WE	1,362	10
	Wine Gold	E8330FSG_WG	1,525	10
	Dark Grey	E8330FSG_DG	1,525	1
	Light Wood	E8330FSG_LW	1,525	1
	Dark Wood	E8330FSG_WD	1,525	10
	White	E8330FSGN_WE	1,476	10
13A 250V 1 Gang Fused Connection Unit with Neon	Wine Gold	E8330FSGN_WG	1,904	10
	Dark Grey	E8330FSGN_DG	1,904	1
	Light Wood	E8330FSGN_LW	1,904	1
	Dark Wood	E8330FSGN_WD	1,904	10
	White	E8331DFSGN_WE	2,666	10
	Wine Gold	E8331DFSGN_WG	4,442	10
13A 250V 1 Gang Fused Connection with DP Switch and Neon	Dark Grey	E8331DFSGN_DG	4,442	1
	Light Wood	E8331DFSGN_LW	4,442	1
	Dark Wood	E8331DFSGN_WD	4,442	10
	White	E8331TB_WE	1,184	10
	Wine Gold	E8331TB_WG	1,973	10
	Dark Grey	E8331TB_DG	2,067	1
25A 250V 1 Gang Connection Unit	Metal Gold Hairline Light	E8331TB_GH	1,973	10
	Wood	E8331TB_LW	1,973	1
	Dark Wood	E8331TB_WD	2,067	10
	Telecom, Network, Connectivity & Media Series			
1 Gang Telephone Socket, Shuttered Wallplate	White	E8331RJS4_WE	794	1
	Wine Gold	E8331RJS4_WG	1,324	1
	Dark Grey	E8331RJS4_DG	1,324	1
	Metal Gold Hairline	E8331RJS4_GH	1,324	1
	Light Wood	E8331RJS4_LW	1,324	10
	Dark Wood	E8331RJS4_WD	1,324	1

Please contact Customer Care Center for Stockable and Non stockable status of references.

NORMAL STOCK ITEMS

W.E.F. January 30th, 2023

AvatarOn - It's also a Switch



E8332RJS4_WE



E8331RJS5_WE



E8332RJS5_WE



E8331RJS6_WE



E8332RJS6_WE



E8331TV_WE



E8331TVSF_WE



E8332TVFMM_WE



E8332TDRJS5_WE



E8332TVRJS5_WE



E8332HDUSB_WE



E8332HDRJS5_WE



E8332HDHD_WE



E8331RCA_S_WE



E8332HD15PH_WE



E8331VC_WE



E8331SC_WE



E8332SC_WE



E8331RJS_WE



E8332RJS_WE

Product Description	Color	Product Ref. No.	Unit MRP ₹	Pack
2G Tel Socket, Shuttered Wallplate	White	E8332RJS4_WE	1,949	1
	Wine Gold	E8332RJS4_WG	2,926	1
	Dark Grey	E8332RJS4_DG	2,793	1
1 Gang RJ45 Data Cat5E, Shuttered	White	E8331RJS5_WE	1,242	1
	Wine Gold	E8331RJS5_WG	2,166	1
	Dark Grey	E8331RJS5_DG	2,067	1
	Metal Gold Hairline Light	E8331RJS5_GH	2,067	1
	Wood	E8331RJS5_LW	2,067	10
	Dark Wood	E8331RJS5_WD	2,166	1
	White	E8332RJS5_WE	2,269	1
2 Gang RJ45 Data Cat5E, Shuttered	Wine Gold	E8332RJS5_WG	3,785	1
	Dark Grey	E8332RJS5_DG	3,613	1
	Metal Gold Hairline Light	E8332RJS5_GH	3,613	10
	Wood	E8332RJS5_LW	3,613	10
	Dark Wood	E8332RJS5_WD	3,785	1
1 Gang RJ45 Data Cat6, Shuttered	White	E8331RJS6_WE	1,483	1
	Wine Gold	E8331RJS6_WG	2,224	1
2 Gang RJ45 Data Cat6, Shuttered	Dark Grey	E8331RJS6_DG	2,224	1
	White	E8332RJS6_WE	2,780	1
	Wine Gold	E8332RJS6_WG	4,170	1
1 Gang TV Socket, 75Ω, Through-Connect	Dark Grey	E8332RJS6_DG	834	1
	White	E8331TV_WE	626	1
	Wine Gold	E8331TV_WG	1,043	1
	Dark Grey	E8331TV_DG	1,043	1
	Metal Gold Hairline Light	E8331TV_GH	1,043	10
	Wood	E8331TV_LW	994	10
	Dark Wood	E8331TV_WD	1,043	1
1 Gang TV Socket, Slave 5-1000	White	E8331TVSF_WE	692	10
	Wine Gold	E8331TVSF_WG	1,043	10
	Dark Grey	E8331TVSF_DG	994	1
2 Gang TV Master/FM Socket	White	E8332TVFMM_WE	2,513	10
	Wine Gold	E8332TVFMM_WG	3,767	10
	Dark Grey	E8332TVFMM_DG	3,767	1
1 Gang Tel + RJ45 Data Cat5E, Shuttered	White	E8332TDRJS5_WE	1,949	1
	Wine Gold	E8332TDRJS5_WG	3,249	1
	Dark Grey	E8332TDRJS5_DG	3,102	1
	Metal Gold Hairline Light	E8332TDRJS5_GH	3,102	1
	Wood	E8332TDRJS5_LW	2,961	10
	Dark Wood	E8332TDRJS5_WD	3,249	1
	White	E8332TVRJS5_WE	2,417	1
1 Gang TV+ RJ45 Data Cat5E, Shuttered	Wine Gold	E8332TVRJS5_WG	4,033	1
	Dark Grey	E8332TVRJS5_DG	3,849	1
	Metal Gold Hairline Light	E8332TVRJS5_GH	3,849	1
	Wood	E8332TVRJS5_LW	3,674	10
	Dark Wood	E8332TVRJS5_WD	4,033	1
	White	E8332TVRJ6_WE	2,417	1
	Wine Gold	E8332TVRJ6_WG	4,033	1
1 Gang TV+ RJ45 Data Cat6, Shuttered	Dark Grey	E8332TVRJ6_DG	3,849	1
	White	E8332HDUSB_WE	5,151	1
	Wine Gold	E8332HDUSB_WG	8,584	8
HDMI + USB Socket	Dark Grey	E8332HDUSB_DG	8,193	1
	White	E8332HDRJS5_WE	3,135	1
	Wine Gold	E8332HDRJS5_WG	4,701	1
HDMI + RJ45 Data Cat5E, Shuttered	Dark Grey	E8332HDRJS5_DG	4,701	1
	White	E8332HDHD_WE	2,825	1
	Wine Gold	E8332HDHD_WG	4,708	8
2 Gang HDMI+HDMI , Keystone on Wallplate	Dark Grey	E8332HDHD_DG	4,708	1
	White	E8331RCA_S_WE	1,983	1
	Wine Gold	E8331RCA_S_WG	2,839	1
RCA/S-Video Socket	Dark Grey	E8331RCA_S_DG	2,839	1
	White	E8332HD15PH_WE	1,983	1
	Wine Gold	E8332HD15PH_WG	2,839	1
VGA + Mini Audio	Dark Grey	E8332HD15PH_DG	2,839	1
	White	E8331VC_WE	2,248	1
Volume control, 5W, 8Ohm	Wine Gold	E8331VC_WG	3,372	10
	Dark Grey	E8331VC_DG	3,372	1
Speaker Connection, One Pair	White	E8331SC_WE	1,822	10
	Wine Gold	E8331SC_WG	2,864	10
	Dark Grey	E8331SC_DG	2,734	1
Speaker Connection, Two Pair	White	E8332SC_WE	2,644	1
	Wine Gold	E8332SC_WG	3,966	1
	Dark Grey	E8332SC_DG	3,786	1
1 Gang S Keystone Wallplate (w/o Mod)	White	E8331RJS_WE	587	10
	Wine Gold	E8331RJS_WG	881	10
	Dark Grey	E8331RJS_DG	881	1
2 Gang S Keystone Wallplate (w/o Mod)	White	E8332RJS_WE	1,103	10
	Wine Gold	E8332RJS_WG	1,654	10
	Dark Grey	E8332RJS_DG	1,654	1

Please contact Customer Care Center for Stockable and Non stockable status of references.

NORMAL STOCK ITEMS

W.E.F. January 30th, 2023

Kavacha - Weather Protected Series



WHT20-GY-EX

- Pleasing looks with **IP56 protection**
- Large press switch
- Co-moulded sealing with no risk of gasket damage
- Chemical resistant & UV stabilised



CSW110-GY-EX



A3031WBP_WE

Description	Reference	Unit MRP [₹]	Pack
Kavacha IP56 Surface Mount Switches			
Switches with Looping Terminal			
10A 1 Gang 2 Way Switch	CSW110-GY-EX	3,543	1
20A/16A 1 Gang 2 Way Switch	CSW120-GY-EX	5,303	1
10 A 2 Gang 2 Way Switch	CSW110/2-GY-EX	6,287	1
10A 1 Gang 2 Way Bell Press Return Switch	CSW110BPR-GY-EX	3,926	1
Switches with Looping Terminal with Neon			
20A 1 Gang 2 Way with Looping Terminal with Neon	CSW120N-GY-EX	4,599	1
Double Pole Switches			
20A 1 Gang Double Pole Switch	CSW220-GY-EX	5,323	1
Kavacha Heavy Duty Isolator Switches			
35A Triple Pole	WHT35-GY-EX	6,454	1
55A Triple Pole	WHT55-GY-EX	10,590	1
63A Triple Pole	WHT63-GY-EX	8,312	1
Kavacha IP56 Surface Mount Combined Switched Socket Outlets			
Combination Switch Socket Outlets			
16A Single Pole Switched Socket Outlet	CSC316RP-GY-EX	4,360	1
Kavacha IP56 Surface Mount Socket Outlets			
16A Socket Outlet	CSO316RP-GY-EX	2,933	1
Kavacha Full-Time Weatherproof Cover			
Full-Time Weatherproof Single Gang Socket Cover (Transparent) IP55	E223R_TR	1,062	1

Please contact Customer Care Center for Stockable and Non stockable status of references.

NORMAL STOCK ITEMS

W.E.F. January 30th, 2023

Metal Boxes



- **Weld free design** to minimize corrosion and rusting without compromising on strength
- Mounting clip and earth pin designed for **easier installation** and to **avoid loss during transportation**
- Removable side plates and optimized knock outs and for **easier wiring**
- Completely tested & validated as per **IS 14772**

Description	Reference	Unit MRP [₹]	Pack
Metal Boxes for Indian Format Ranges (Livia, Opale Clipsal X, Unica Pure & ZENcelo India) NEW			
0.8 mm thickness			
Metal Box 1 & 2 modules	ME0102	105	20
Metal Box 3 modules	ME0103	135	20
Metal Box 4 modules	ME0104	156	20
1 mm thickness			
Metal Box 1 & 2 modules	MR1102	116	20
Metal Box 3 modules	MR1103	153	20
Metal Box 4 modules	MR1104	177	20
Metal Box 6 modules	MR1106	240	10
Metal Box 8 modules - Horizontal	MR1108	311	10
Metal Box 8 modules - Square	MR1109	311	10
Metal Box 12 module	MR1112	400	5
Metal Box 18 modules	MR1118	474	5

Description	Reference	Unit MRP [₹]	Pack
Metal Boxes for BS Format Ranges (AvatarON, ZENcelo BS, NEO, ULTI) - New & Improved Design NEW			
Use Bracket/Frame to ensure alignment of switches on 2/3/4 Gang Metal Box (refer to Avataron section for references)			
1 mm thickness			
2 GANG GI Metal Boxes	MM1102	291	20
3 GANG GI Metal Boxes	MM1103	413	20
4 GANG GI Metal Boxes	MM1104	534	20

- Special Metal Box with Gang Partition to accommodate BS format ranges
- Single Metal Box can accommodate up to 4 units
- Number of Gangs for Metal Box = Number of units that it can accommodate (Eg. 3 GANG Metal Box can accommodate up to 3 BS format Units)

Please contact Customer Care Center for Stockable and Non stockable status of references.

NORMAL STOCK ITEMS

W.E.F. January 30th, 2023



Make your home smart with our Wisier - Smart Homes offering.

- Easy to operate
- Easy to maintain
- Easy to control
- Easy on pocket

A solution which blends with your existing Switches and all this without any change in Wiring.

With the Internet of Things taking over the lives, automation has made lives simpler and homes smarter.

Smart homes are the base to smart cities and a much secure lifestyle. It is a connected home technology that is designed to automate functions and grant you control over the property.

- Set the schedule, and the rest is automated and based on your personal preferences thus providing convenience, control, money savings, and an overall smarter home.
- Alerts about lights still switched on after leaving the house
- Make personalization's to the home using just an app

Once there were smart homes, now there are Wisier™.

Smart homes are about technologies. Wisier Homes evolve around people. It adds a new dimension - being Stylish, Living Well and Eco-friendly Interlinks the electrical, multi-media and telecommunication worlds with a single and user-friendly solution - enabling you to monitor, control and access your home beyond physical boundaries at anytime, anywhere.

Features

- Integrates with any existing switch.
- Interlinks the electrical, multi-media and telecommunications worlds through Wi-Fi, providing
 - True and easy integration for devices from different brands and makes.
- The intuitive graphic user interface with jargon-free language and self-explanatory icons is easy-to-use, while the interface is consistent across different control devices and no need to spend extra time to learn different control interfaces.
- Control and access home anywhere and at any time through the secured wireless connection.
 - With time scheduling, scene control



SE Ref.	Description of reference	Unit MRP [₹]
Wiser 4 Channel Automation Relay	IH14000100	12,786
Wiser Automation Gateway	IH101ZWIFI	35,987
2 Channel Dimmer Controller	IH12000020	15,786
Wiser 1 Channel Analog Dimmer + 1 Channel Direct dimmer Controller	IH12001010	15,786
Wiser Curtain Controller	IH11000200	14,915
Fan Speed Controller	IH1200010F	15,786
Smart Doorbell	IH100WFVDP	27,211
IR Controller	IH101ZW2IR	14,786

Please contact Customer Care Center for Stockable and Non stockable status of references.

NORMAL STOCK ITEMS

W.E.F. January 30th, 2023

Surface and Flush Mount Occupancy Sensors



PIR, Ultrasonic Sensors & High Frequency sensor suitable for both Surface & Flush Mount

Description	Reference	Unit MRP [₹]
Surface Mount Single-Load 360 degrees PIR	CSS54E_WE	3,788
Flush/Surface Mount Single-Load 360 degrees PIR	SAE-UE-MS-CSAWE	4,569
ARGUS Presence Dual-Tech PIR & Ultrasonic Sensor - 1ch	CCT551011	18,391
ARGUS Presence Dual-Tech - 2ch	CCT551012	16,469
ARGUS IR Remote Controller Dual-Tech	CCT556011	15,267
ARGUS Presence High Frequency High Bay Sensor - 2ch	CCT551023	18,391
ARGUS IR Remote Controller HF	CCT556023	15,267
ARGUS Presence Wide Sense - 2ch	CCT551003	15,260
INFRASCAN OUTDOOR 3WIRE 10A	750WPR-GY	19,647
INFRASCAN INDOOR 3WIRE 10A	751R-WE	10,606
INFRASCAN 360DEGREE 3WIRE	753R-WE	11,901



PIR Flush Mount Sensors

Description	Reference	Unit MRP [₹]
ARGUS Standard min 360° False ceiling indoor movement detector	CCT570005	5,453
ARGUS Standard 360° False ceiling indoor movement detector - 2ch	CCT570003	7,850
Flush Mount Dual load 360 degrees standalone sensor	SAE-UE-MS-CDBWE	9,116



Dimmable Sensors with Light Regulation

0-10V Analogue & Dali Dimmable Sensor

Description	Reference	Unit MRP [₹]
Flush/Surface Mount Dual Load 360° PIR, 0-10V Analogue Dimmable Sensor with remote	SAE-UE-MS-CDDWE	12,089
ARGUS Presence DALI 230V - 2 zones	CCT552006	19,630
ARGUS Presence DALI 230V - Slave	CCT555006	14,070
ARGUS IR Remote Controller DALI	CCT556006	16,032
ARGUS Presence Master with IR, DALI	MTN5510-1519	21,075

Please contact Customer Care Center for Stockable and Non stockable status of references.

NORMAL STOCK ITEMS

W.E.F. January 30th, 2023

Wall Mount Sensors



BS Standard & Outdoor IP55 Sensor

Description	Reference	Unit MRP [₹]
Neo C-Metro 200 degrees wall mount sensor, grey colour	E3751MS3C_GS	5,581
Neo C-Metro 90 degrees wall mount sensor, grey colour	E3751MS3A_GS	7,777
Zencelo 110 degrees wall mount sensor, white colour	E84751MS3B_WE	5,507
Zencelo 90 degrees wall mount sensor, white colour	E84751MS3A_WE	5,507
Argus 110 Electronic outdoor movement detector, angle of detection 110 degrees, max. range 12 mtrs, IP55 protection	MTN565119	8,029
Argus 220 Electronic movement detector for outdoor ceiling mounting angle of detection 220 degrees, max. range 12 mtrs, IP55 protection	MTN565219	12,388
Accessories		
Mounting bracket for Argus 110 and Argus 220 Sensors	MTN565291	1,495

Hotel - ELV Dual Motion Sensor

Description	Reference	Unit MRP [₹]
ELV DUAL TECH MOTION SENSOR	SAE_UE_MS_CULV_WE	13,114

Please contact Customer Care Center for Stockable and Non stockable status of references.

NORMAL STOCK ITEMS

W.E.F. January 30th, 2023

Timers & Time Switches

Analog Time Switches



- 24H, 7D Programmable switch Voltage Rating: 230V AC +10%, -15%
- Memory: Upto 56 Switching Operations
- Back up of program: Operating reserve for 100, 200 Hours
- Overall dimensions: 5 modules
- Minimum time between two switching operations: 15, 30 min
- Accuracy: $\leq \pm 1$ s/day at +20°C

Description	Module Width 18mm/module	Reference	Unit MRP [₹]
IH 24H 16 A 15 mts interval 1 channel	1	15336	5423
IH 24H 16 A 30 mts interval 1 channel	1	CCT15365	5915
IH 24H + 7 day 10 A 1 channel- Max 16 On, 16 Off and 7 On + 7 Off cycles	3	15366	9102
IH 7 day 16 A 1 channel- Max 21 On and 21 Off cycles	3	CCT15367	8468
IH 24H 16 A 30 mts 1 channel without reserve	3	CCT16364	4805

Digital Time Switches



- 7D, 24H Programmable switch .Voltage Rating: 230V AC +10%, -15%
- Consumption: 1 channel - max. 4VA; 2 channels - max. 7VA
- Memory: Upto 56 Switching Operations
- Back up of program & time by lithium battery: Operating reserve: 6 Years
- Overall dimensions: 5 modules
- Cable length: 100m
- Minimum time between two switching operations: 1 min

Description	Module Width 18mm/module	Reference	Unit MRP [₹]
IHP 1C w (24h/7d) programmable time switch	2.5	CCT15441	11656
IHP+ 1C (24h/7d) SMARTw programmable time switch	2.5	CCT15551	14380
IHP 2C w (24h/7d) programmable time switch	2.5	CCT15443	15036
IHP DCF (24h/7d) SMART programmable time switch	2.5	CCT15858	24853
IHP+ 2C (24h/7d) SMARTw programmable time switch	2.5	CCT15553	16636

Timers



- Switching capacity 16 A, max
- Delay range from 30 sec to 20 min
- Capacity for lighted pushbutton 150 mA
- Electric distribution busbar compatibility
- Output power capacity CCT15232-2300W
- Output power capacity CCT15223-3600W

Description	Module Width 18mm/module	Reference	Unit MRP [₹]
MINs - electronic timer - 0.5 to 20 min	1	CCT15232	6584
MINs - electronic timer - 0.5 to 20 min with switch Off Warning	1	CCT15233	8455
MINs - electronic timer - 0.5 to 20 min with switch Off Warning and Impulse relay function	1	CCT15234	8345

Please contact Customer Care Center for Stockable and Non stockable status of references.

NORMAL STOCK ITEMS

W.E.F. January 30th, 2023

Twilight switch



- Includes wall mounted cell
- Adjustable brightness threshold 2 to 2000 Lux
- 2 LEDs to signal the sensor status and the output status
- Test button: To check the product and load cabling
- Switching capacity: 16Amp
- Screwless Terminals compatible with rigid and flexible wires
- Consumption 6 VA
- Size 45mm

Description	Module Width 18mm/module	Reference	Unit MRP [₹]
IC2000 outdoor (2 - 2000 lux) twilight switch	1	CCT15369	13887
Analogue indoor light sensor cell	-	CCT15262	6852
Wall mounted Analogue outdoor light sensor cell	-	CCT15263	10621
IC100 (2 - 100 lux) twilight switch	1	CCT15482	11682
IC2000 indoor (2 - 2000 lux) twilight switch	1	CCT15285	10410
IC2000p+ (2 - 2000 lux) programmable twilight switch	2.5	CCT15483	25336
IC100kp+ 1C (1 - 99000 lux) SMART programmable twilight switch	2.5	CCT15494	29184
IC100kp+ 2C (1 - 99000 lux) SMART programmable twilight switch	2.5	CCT15495	35928
IC Astro 2C SMART programmable twilight switch	2.5	CCT15245	26484
IC Astro 1C SMART programmable twilight switch	2.5	CCT15225	21224

Time switch accessories

Description	Module Width 18mm/module	Reference	Unit MRP [₹]
Programming kit for IHP / IC	1	CCT15860	11657

Thermostat

Description	Module Width 18mm/module	Reference	Unit MRP [₹]
THP1+ 1C (24h/7d) programmable thermostat	2.5	CCT15834	26516

Please contact Customer Care Center for Stockable and Non stockable status of references.

NORMAL STOCK ITEMS

W.E.F. January 30th, 2023

Life Is 

Schneider
Electric

Schneider Electric India Pvt. Ltd.

Corporate Office: 9th Floor, DLF Building No. 10, Tower C, DLF Cyber City, Phase II, Gurugram 122002 Haryana
Tel.: ++91 124 6899000 Fax: ++91 124 4222036/037

Ahmedabad

Schneider Electric India (P) Ltd.
1506-1507, 15th Floor Shapth-5
Opp.Karnavati Club, SG Highway,
Ahmedabad, Gujarat - 380015
Tel.: 079-66826701

Bengaluru

Schneider Electric India (P) Ltd.
No. 3/1, JP Techno Park
Mezzanine Floor, Millers Tank Bund
Road, Vasanth Nagar
Bengaluru - 560052
Tel.: 080-71481351

Bhubaneswar

Schneider Electric India (P) Ltd.
Workloop Co-Working in the property
Office No. 316, Esplanade One Mall
Rasulgarh, Bhubaneswar - 751010

Chennai

Schneider Electric India (P) Ltd.
No: 29, 2nd Floor,
Bannari Amman Towers, B-Block
Dr. Radhakrishnan Road, Mylapore
Chennai - 600 004
Tel.:044-71912000

Cochin

Schneider Electric India (P) Ltd.
Alapatt Properties Private Limited
(Trade Name : Centre A)
Main Door Number : 66/4971
(Old Door Number: 40/6584-H)
7th Floor Alapatt Heritage Building
MG Road Kochi - 682035

Coimbatore

Schneider Electric India (P) Ltd.
Hanudev Info Tech Park, 6th Floor
Unit No. Block-C, SF No. 558/2
Udalyampalayam Road, Nava India
Coimbatore - 641028

Hyderabad

Schneider Electric India (P) Ltd.
D.No. 1-8-271, # 401, Ashoka
Bhoopal Chambers, SP Road
Secunderabad - 500003
Tel.: 040-67219500

Indore

Schneider Electric India (P) Ltd.
219, Dhan Trident Building
Vijay Nagar, A.B.Road
Indore - 452001

Jaipur

Schneider Electric India (P) Ltd.
Jaipur Business Centre 309
3rd Floor, Sangam Tower 190
Church Road, Jaipur - 302001
Tel.: 0141-2374810

Kolkata

Schneider Electric (I)Pvt.Ltd,
BP-4, Sector-V, Technopolis
3rd Floor, Salt Lake City
Kolkata - 700 091
Tel.: 033-66576400

Lucknow

Schneider Electric India (P) Ltd.
Summit, Plot No. TCG 3/3
6th Floor, 604A/B/C, Vibhuti Khand
Gomti Nagar, Lucknow
Uttar Pradesh - 226010
Tel.: 0522-3500334

Ludhiana

Schneider Electric India (P) Ltd.
SCO 23, 2nd Floor,
Chandigarh Road, Sector 32
Ludhiana, Punjab -141010
Tel.: 0161- 5203011

Mohali

Schneider Electric India (P) Ltd.
2nd Floor, Tower-A
Bestech Business Tower
Mega Information & Technology Park
Industrial Plot No.1, Phase IX
(Expansion), Mohali - 160059
Tel.: 0172-7198200

Mumbai

Schneider Electric India (P)(Ltd)
Marwah House, 2nd Floor
Krishanlal Marwah Marg
Andheri (East), Mumbai - 400072
Tel.: 022-62280000

Nagpur

Schneider Electric India (P) Ltd.
6, Vasant Vihar Complex
W.H.C Road, Shankar Nagar
Nagpur - 440010
Tel.: 0712-2558581

Nashik

Schneider Electric India (P) Ltd.
401, 4th Floor, Rishi Raj Towers
Jehan Circle, Gangapur Road
Nashik - 422013
Tel.: 0253-2344333

New Delhi

Schneider Electric India (P) Ltd.
C-56, Mayapuri Industrial Area, Phase-2
New Delhi - 110064
Tel.: 011-61317400

Pune

Schneider Electric India (P) Ltd.
Amar Caliber, CTS No 911, BMCC Road,
OFF F.C. Road, Deccan Gymkhana,
Shivaji Nagar, Pune - 411007
Tel.: 020-67492500

Vadodara

Schneider Electric India (P) Ltd.
Notus IT Park, 10th Floor, Block-D
Sarabhai Campus, Vadiwadi
Vadodara, Gujarat - 390017

Vishakhapatnam

Schneider Electric India (P) Ltd.
D.N.10-1-43, 1st Floor
Ratnam's Business Centre,
Siripuram Fort, C.B.M.Compound
Visakhapatnam - 530016
Tel.: 0891-6675500

Customer Care Centre

Monday-Saturday, 9 a.m. to 8 p.m.

Toll-free numbers: 1800 419 4272, 1800 103 0011

Email: customercare.in@schneider-electric.com

For more information, visit our website at: www.se.com/in

- All Prices are in Indian Rupees.
- Prices are subject to change without prior notice.
- Product evolution is a continuous process and Schneider Electric reserves the right to modify/withdraw any product at any time without prior notice.
- Prices charged will be as prevailing on the date of dispatch.
- Invoice Amount = (MRP – less Applicable discount) + Applicable GST %
- Tax incidence on invoices is basis applicable GST rates.
- Invoice amount not to exceed MRP.
- Product pictures shown are for illustration purpose only, actual product may vary.

Distributor