



 **Goldmedal**[®]
SWITCH TO THE AMAZING

Switch to the
amazing



**20
20**

PRODUCTS & PRICING
MANUAL
Edition-02

www.goldmedalindia.com

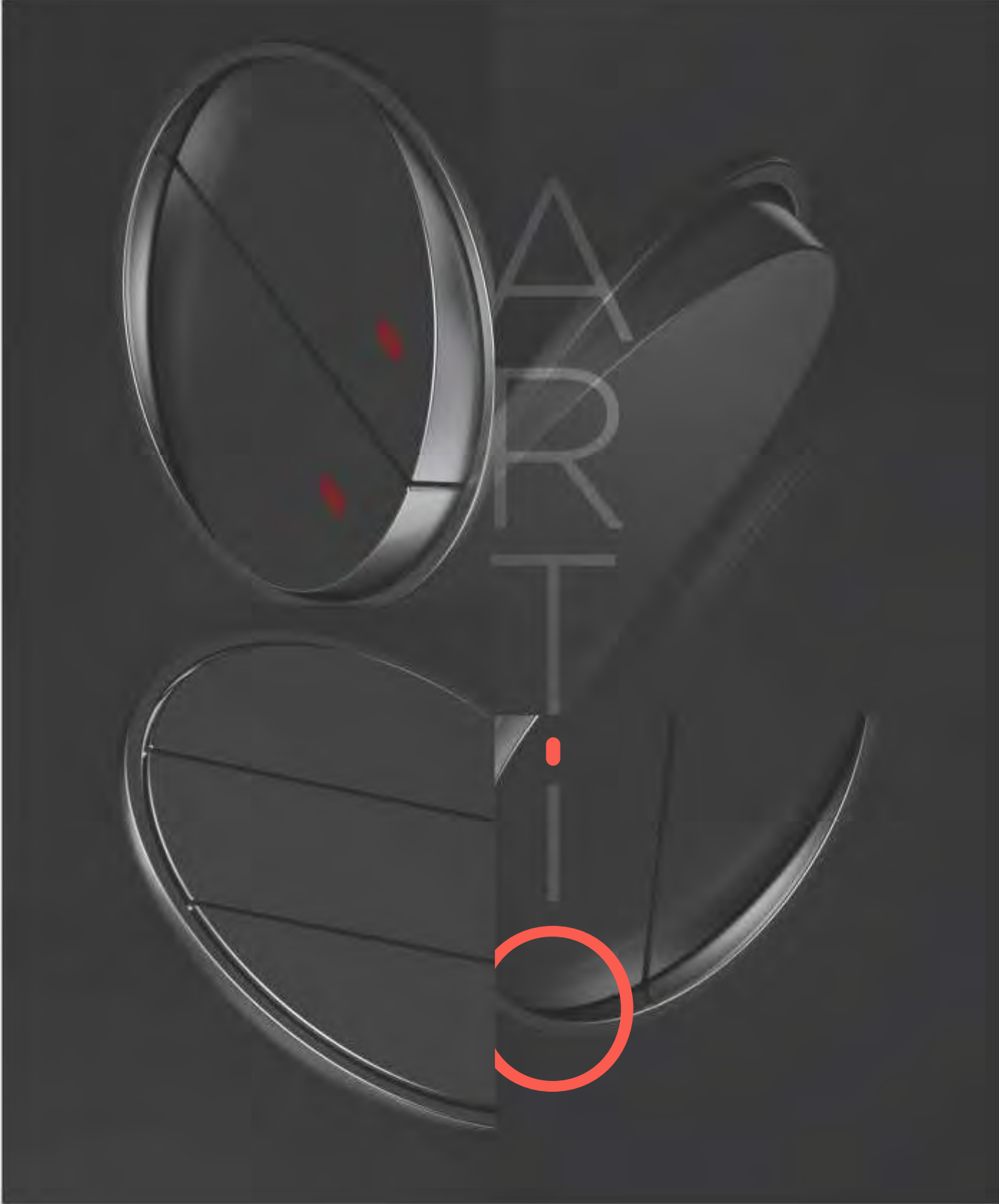

Brand Identity, concept & design by Goldmedal Electricals Pvt. Ltd.



Never ending innovation

At Goldmedal, the cycle of innovation never stops. We are constantly identifying new ways of making life more efficient, more inspiring, by creating products that are extraordinary in many ways. The new range of Artio switches in the AIR modular range is another example of this endeavour.

Like every product in the Air range, the Artio switches are delightfully simple and minimalist to behold. Embodying reductionism and refinement, which are the hallmarks of a sleek, modern and urbane lifestyle, the Artio makes a contemporary statement in every sense. An ingenious design, the Artio consists of either single or a combination of switches embedded within a square frame that is extremely easy to install. Once installed, either individually or as a combination, the switches form a perfect, graceful circle. The elegance, harmony, and compositional unity of the Artio switches gives it a truly timeless appeal.

The Artio follows Goldmedal's impeccable record of crafting products that delight users with their functionality as well as aesthetics. It's a product that is sure to set future benchmark for standard switches.





Artio

New Arrival SWITCHES...



Contents





Sec 01	New Arrivals	08-17
Sec 02	Curve Modular Inserts	18-27
Sec 03	Nixon Modular Inserts	28-47
Sec 04	Modular Cover Plates	48-69
Sec 05	Air Modular Inserts	70-83
Sec 06	Air Modular Cover Plates	84-93
Sec 07	Gifa Cloud 9 Inserts	94-101
Sec 08	Gifa Modular Cover Plates	102-109
Sec 09	Curve Plus Products	110-123
Sec 10	Gifa Mini Modular Series 8	124-129
Sec 11	Gzifa Mini Modular	130-134
Sec 12	Essenza	135-139
Sec 13	Gazelle Wood Plates	140-141
Sec 14	Urea Range	142-153
Sec 15	Dbc & Mcbs	154-169



Gifa Xg Absolute White Cover Plate with G-slide Switch in Titanium Grey

X9

It's the cover plate with the X-factor. Shaped like an eye-catching curved TV, the X9 cover plate exhibits the aesthetics of an artistic centerpiece. Mount it on the wall and its curved shape lends this cover plate a floating look that appears ultra premium in any setting. Available in a variety of finishes, the X9 is a cover plate that's distinctly a cut above the rest.



Gifa Xg Absolute White Cover Plate with G-line Switches
in Titanium Grey



Gifa Ag Mountain Dew Cover Plate With G-slide Switch in Titanium Grey

A9

The shape and texture of the Ag offers a modern, contemporary feel while the unique colours of these cover plates add a touch of warmth and elegance to the ambience. Overall, the Ag is the perfect choice for creating relaxed, peaceful environments – whether at home or office. These cover plates can effortlessly complement as well as contrast with your interiors – the choice is entirely yours.



Gifa Ag Mountain Dew Cover Plate With G-side Switches
in Titanium Grey

Air



Air A5 Absolute White Cover Plate with Aero Switch in Absolute White

A5

The new A5 cover plate is a mix of playful elegance and contemporary styling. Gently curved with rounded corners and a sleek chrome border around the inner frame, the A5 is a refreshingly clean and modern design with a dash of added fun. Like other AIR cover plates, the A5 is restrained in a quiet, refined manner without being dull and boring. Introduce A5 to your interiors to exhibit that rare combination of elegance and charming playfulness!



A5 Absolute White Cover Plate with Aero Switches
in Titanium Grey

Air



Air A7 Absolute White Plate with Aero Switch
in Absolute White

A7

The AIR A7 cover plate is a wonderful example of contemporary minimalistic design with sophisticated functionality. This is an ultra-flat plate with softly rounded corners and a sleek chrome border around the inner frame. Characterised by AIR's familiar austere yet elegant looks, the A7 offers a quiet and reserved presence without appearing mundane. A quintessential modern-day switch plate, the A7 adds a touch of elegance to every setting.



A7 Absolute White Cover Plate With Aero Switches
in Titanium Grey

Wega Absolute White Cover Plate with G-click Switches



Wega Titanium Grey Cover Plate with G-click Switches



Wega Champagne Gold Cover Plate with G-click Switches



Wega Titanium Silver Cover Plate with G-click Switches



Wega Jungle Wenge Cover Plate with G-click Switches



Wega Dark Espresso Cover Plate with G-click Switches



WEGA

The Wega, with its symmetrical peaks and slopes on four sides, is a unique cover plate from Goldmedal. The undulating shape creates an interplay of light that's a delight to the senses. Place it in any setting and it's sure to catch everyone's attention. From any angle. The Wega cover plates are now available in six lustrous colour options. Each one of them magnificent in its own way.



Code	Item	MRP ₹		Pkg.
		White Jazz	Digital Chrome Voltage Grey	
10AX SWITCHES 240V~ (1 Module)				
101001	1 Way Switch	69.00	76.00	20/600
101002	1 Way Switch with Indicator (LED)	129.00	142.00	20/600
101003	2 Way Switch	129.00	142.00	20/600
101004	Bell Push Switch	140.00	155.00	20/600
101005	Bell Push Switch with Indicator (LED)	160.00	177.00	20/600
10AX SWITCHES 240V~ (2 Module)				
102010	1 Way Switch	144.00	157.00	10/300
102011	1 Way Switch with Indicator (LED)	161.00	178.00	10/300
102012	2 Way Switch	179.00	197.00	10/300
102013	Bell Push Switch	179.00	197.00	10/300
102014	Bell Push Switch with Indicator (LED)	200.00	219.00	10/300
6AMP BELL PUSH 240V~ (2 Module)				
102015	Bell Push with Luminous Name Plate 240V~ 50-60Hz LED circuit with diffuser	249.00	249.00	10/300
20AMP / 25 AMP SWITCHES 240V~ (1 Module)				
101020	20A 1 Way Switch	172.00	189.00	20/600
101021	20A 1 Way Switch with Indicator (LED)	193.00	213.00	20/600
101022	20A 2 Way Switch	193.00	213.00	20/600
101023	25A 1 Way Switch	211.00	232.00	20/600
20AMP / 25AMP SWITCHES 240V~ (2 Module)				
102025	1 Way Switch	201.00	220.00	10/300
102026	1 Way Switch with Indicator (LED)	220.00	242.00	10/300
102027	2 Way Switch	232.00	255.00	10/300
102028	25A 1 Way Switch	252.00	277.00	10/300
32AMP DP SWITCHES 240V~				
102031	DP Switch with Indicator (LED) - 2M	332.00	365.00	10/300

Code	Item	MRP ₹		Pkg.
		White Jazz	Digital Chrome Voltage Grey	

6AMP / 6&16AMP SOCKETS 240V~

101035	6A 2 Pin Socket (1M) with safety shutter	115.00	128.00	20/600
102036	6A 3 Pin Multi Socket (2M) with safety shutter	104.00	114.00	10/450
102037	6A 2x1 Socket (2M) with safety shutter	129.00	142.00	10/450
102039	10A International Socket (2M) with safety shutter	225.00	248.00	10/450
102040	6A Universal Socket (2M) with mobile socket & safety shutter	150.00	165.00	10/450
102041	6&16A Universal Socket (2M) with safety shutter	243.00	267.00	10/450



25AMP SOCKETS 240V~ (2 Module)

102042	25A 3 Pin Socket with safety shutter	267.00	295.00	10/450
--------	---	--------	--------	--------



DIMMERS 240 V~50-60Hz 300-450W

101045	Dimmer (1M) 450W	293.00	323.00	20/600
102046	Dimmer (2M) 450W	398.00	439.00	10/300
102047*	Dimmer (2M) 1000W	584.00	643.00	10/300



FAN REGULATOR 240V~

101051	4 Step Regulator (1M)	432.00	475.00	20/600
102052	5 Step Regulator (2M)	467.00	514.00	10/300
102052A	5 Step Regulator - Full Rotary (2M) - Regulator Supplied in ISI & Non ISI	467.00	514.00	10/300



MOTOR STARTER (SP) 240V~ 50-60Hz (2 Module)

102056	10A Starter Switch	605.00	665.00	10/300
102057	16A Starter Switch	605.00	665.00	10/300
102058	20A Starter Switch	605.00	665.00	10/300
102059	25A Starter Switch	605.00	665.00	10/300
102060	32A Starter Switch	605.00	665.00	10/300

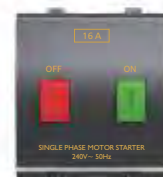

TV SOCKET / RJ-11 TELEPHONE JACKS (1 Module)

101062	TV Socket Coaxial 40-862 Mhz Socket	140.00	155.00	20/900
101069	RJ-11 Single Telephone Jack	131.00	145.00	20/600
101070	RJ-11 Double Telephone Jack	159.00	174.00	20/600



* introducing shortly



Code	Item	MRP ₹		Pkg.
		White Jazz	Digital Chrome Voltage Grey	
EDP SOCKET OUTLET RJ-45 WITH NAME PLATE (1 Module)				
101072	EDP Socket Outlet - RJ 45 (Cat 5e) Category 5e, Universal wiring T568A, insulating-piercing terminal with shutter	231.00	254.00	20/600
101074	EDP Socket Outlet - RJ 45 (Cat 6e) Category 6e, Universal wiring T568A, insulating-piercing terminal with shutter	605.00	665.00	20/600
SINGLE POLE MCBS 240/450V~ (1 Module)				
101077	C6 SP MCB	305.00	335.00	20/600
101078	C10 SP MCB	305.00	335.00	20/600
101079	C16 SP MCB	305.00	335.00	20/600
101080	C20 SP MCB	305.00	335.00	20/600
101081	C25 SP MCB	305.00	335.00	20/600
101082	C32 SP MCB 240/450V~ 50-60Hz 3kA Breaking Capacity	305.00	335.00	20/600
DOUBLE POLE MCBS 240/450V~ (2 Module)				
102083	C6 DP MCB	630.00	694.00	10/300
102084	C10 DP MCB	630.00	694.00	10/300
102085	C16 DP MCB	630.00	694.00	10/300
102086	C20 DP MCB	630.00	694.00	10/300
102087	C25 DP MCB	630.00	694.00	10/300
102088	C32 DP MCB 240/450V~ 50-60Hz 3kA Breaking Capacity	630.00	694.00	10/300
INDICATOR, FUSE UNITS (1 Module)				
101093	Indicator with LED & Red Diffuser	116.00	129.00	20/600
101098	Fuse Carrier 10 / 16AMP with miniature fuse dia 6.3x28	164.00	180.00	20/600
STEP MARKER LAMP (2 Module)				
102105	Step Marker Supply voltage 240V~ 50-60Hz with high-efficiency 1W LED & adjustable beam on three levels	558.00	614.00	5/120
FLOOR & STEP LIGHT 240V~ (4 Module)				
120405	G-Focus Light (Blue, White & Warm White LED)	731.00	804.00	5/120
120406	G-Focus Light Trio (LED) Fully recessed floor & step light with support frame & glassio cover plate with 3 color inbuilt LED Supply voltage 240V~50-60Hz	799.00	879.00	5/120



Code	Item	MRP ₹		Pkg.
		White Jazz	Digital Chrome Voltage Grey	
ELECTRONIC HAND LAMP 240V~ (2 Module)				
102114	TORCIA Electronic hand lamp with high-efficiency 0.5W LED, automatic emergency device, rechargeable & replaceable Ni-MH battery, 2 hours operating range - Battery included (102115)	1049.00	1154.00	5/120
102115	Ni-MH 4.8V 80 mAh Battery (Spare parts)	240.00	-	N.A.
101123	AAA Ni-MH 1.2V 1100 mAh without "memory" effect interchangeable - 3 Batteries set (Spare parts)	398.00	-	N.A.
LIGHTING FITTING WITH EMERGENCY FUNCTION 240V~				
102119	Lighting Fitting with Emergency Function (2M) with High Efficiency 2x0.5W LED	1022.00	1122.00	5/100
103121	Lighting Fitting with Emergency Function (3M) with High Efficiency 3x0.5W LED Supply voltage 240V~ 50Hz 3 Steps Dimming Switch 240V~ 50Hz When battery is inserted, the device will function as an emergency light - Batteries supplied separately (101124)	1375.00	1515.00	5/100
EMERGENCY LIGHT BATTERY				
101124	Battery Li-ion, 3.6V 600mAh 2/3A	261.00	-	20/600
BLANK MODULE/CORD GRIPPER (1 Module)				
101125	Blank Module	28.00	30.00	50/2000
101127	Cord Gripper (Output ϕ 9mm)	67.00	73.00	20/600
ELECTRONIC BUZZERS (2 Module)				
102138	Electronic Cuckoo Buzzer 240V~ 50-60Hz (LED)	191.00	211.00	10/300
102139	Electronic Bell 240V~ 50-60Hz (LED)	328.00	362.00	10/300
32A MAIN SWITCH (2 Module)				
102163	32A DP Operated by Key Tag 240V~, LED Supplied with Key Tag	545.00	599.00	10/300
102164	Only Key Tag with Name Plate	109.00	121.00	N.A.

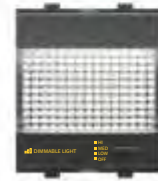

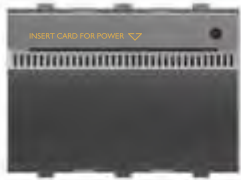

Code	Item	MRP ₹		Pkg.
		White Jazz	Digital Chrome Voltage Grey	
25A ELECTRONIC BADGE SWITCH (3 Module)				
103165	Electronic Switch with Smart Card 25A, 160-240V~ 50-60Hz with indicator (LED) & Integral relay having exit delay.	1590.00	1746.00	5/100
103166	Smart Card Customizable Smart Card	120.00	-	N.A.
DND / MAKE MY ROOM (2 Module)				
102168A	Do Not Disturb/Make My Room 240V~ 50-60Hz - Outside Room	432.00	473.00	10/300
102169A	Do Not Disturb/Make My Room 240V~ 50-60Hz - Inside Room	463.00	508.00	10/300
SHAVER SOCKET (4 Module)				
104171	Shaver Socket 240V~ 50-60Hz with isolating transformer output 110/240V~	1099.00	1209.00	5/50
USB CHARGER 240V~				
101172	USB Charger - Single Port (1M) Supply voltage 160-240V~ 50-60Hz Output - 5V DC, 1000mA or 1A	865.00	953.00	10/300
102173	USB Charger - Single Port (2M) Supply voltage 160-240V~ 50-60Hz Output - 5V DC, 1000mA or 1A with inbuilt switch & dual colour LED indicator	1030.00	1135.00	5/100
102174	USB Charger - Double Port (2M) Supply voltage 160-240V~ 50-60Hz Output - 5V DC, 2000mA or 2A	1020.00	1122.00	5/100
CRISTALLO SWITCH MEMORIO KNOB				
101540	1 Module Switch Knob	12.00	-	50/2000
102541	2 Module Switch Knob	19.00	-	30/900
103542	3 Module Switch Knob (with support knob)	29.00	-	20/800
RF TOUCH SWITCHES				
101206	RF 6A Touch Switch (1M) Supply voltage 160-240V~ 6A relay output Operating load (CFL & LED): 100W Max	1605.00	1766.00	5/120
102213	RF 6A Touch 2 Switch (2M) Supply voltage 160-240V~, 6A relay output Operating load (CFL & LED): 100W Max (per switch)	2089.00	2298.00	5/120
102207	RF 20A Touch Switch (2M) Supply voltage 160-240V~ 20A relay output Operating load (CFL & LED): 200W Max Air conditioner: 2 ton Radio Frequency : 433.92 Mhz Can also be operated by RF Remote control-103268 or web/mobile application via Gateway-101646	1847.00	2032.00	5/120



Code	Item	MRP ₹		Pkg.
		White Jazz	Digital Chrome Voltage Grey	

RF TOUCH DIMMER / FAN REGULATOR (2 Module)

102208	RF Touch Fan Regulator Supply voltage 160-240V~ Triac technology with 9 steps & digital display Operating load (Fan) : 100W	2217.00	2439.00	5/120
--------	---	---------	---------	-------

102214*	RF Touch Dimmer Supply voltage 160-240V~, Triac Technology with soft end & soft start function Operating load (LED) : 80W (Max) Incandescent Light: 40-450W Not suitable for Fan Radio Frequency : 433.92 Mhz Can also be operated by RF Remote control-103268 or web/mobile application via Gateway-101646	2217.00	2439.00	5/120
---------	---	---------	---------	-------



RF TOUCH DRAPE CONTROLLER (2 Module)

102209	RF Drape Controller Supply voltage 160-240V~ 2.5A relay output Electronic RF Drape Controller suitable for AC Motor Radio Frequency : 433.92 Mhz Can also be operated by RF Remote control-103268 or web/mobile application via Gateway-101646	2465.00	2630.00	5/120
--------	---	---------	---------	-------



PASSIVE INFRARED DETECTOR (1 Module)

101210	Passive Infrared Detector with infrared sensor, adjustable dusk/dawn sensor threshold and time delay cycle, supply voltage 240V~ 50-60Hz, 6A relay output	1099.00	1209.00	5/120
--------	---	---------	---------	-------



SMART PASSIVE INFRARED DETECTOR (2 Module)

102212	Smart Passive Infrared Detector with infrared sensor, auto on/off, adjustable dusk/dawn sensor threshold and time delay cycle, supply voltage 240V~ 50-60Hz, 6A relay output	1681.00	1849.00	5/120
--------	---	---------	---------	-------



LPG / METANO GAS DETECTOR 240V~ (3 Module)

103225	LPG / Metano Gas Detector Detector with acoustic and optical signaling and control on a solenoid valve, supply voltage 240V~50-60Hz	2599.00	2799.00	5/100
--------	---	---------	---------	-------



i-TOUCH BELL PUSH

102238	i-Touch Bell Push Switch (2M) Supply voltage 160-240V~ 2A relay output	2300.00	2500.00	5/100
--------	--	---------	---------	-------

103245	i-Touch Bell Push Switch (3M) Supply voltage 160-240V~ 2A relay output	3800.00	4500.00	5/100
--------	--	---------	---------	-------



* introducing shortly



Code	Item	MRP ₹		Pkg.
		White Jazz	Digital Chrome Voltage Grey	
i-TOUCH RF 20A SWITCH				
102239	i-Touch 20A Switch (2M) Supply voltage 160-240V~, 20A relay output	3600.00	4000.00	5/100
103246	i-Touch 20A Switch (3M) Supply voltage 160-240V~, 20A relay output Operating load (CFL & LED): 200W Max Air Conditioner: 2 ton Radio Frequency : 433.92 Mhz Can also be operated by RF Remote control-103268 or web/mobile application via Gateway-101646	5400.00	6200.00	5/100
i-TOUCH RF SWITCHES (3 Module)				
103244	i-Touch 4 Switch with Master Supply voltage 160-240V~ 6A relay output Operating load (CFL & LED):100W Max (per switch) Radio Frequency: 433.92 Mhz Can also be operated by RF Remote control-103268 or web/mobile application via Gateway-101646	5900.00	6900.00	5/100
i-TOUCH RF LIGHT DIMMER (3 Module)				
103248	i-Touch 2 Dimmer with Master Supply voltage 160-240V~, Triac Technology with soft end & soft start function Operating load (LED): 80W (per dimmer) Incandescent Light: 40-450W (per dimmer) Radio Frequency : 433.92 Mhz Not suitable for Fan Can also be operated by RF Remote control-103268 or web/mobile application via Gateway-101646	4800.00	5500.00	5/100
i-TOUCH RF SWITCHES & FAN REGULATOR (3 Module)				
103249	i-Touch 2 Switch + 1 Fan Regulator with Master Supply voltage 160-240V~ Switch: 6A relay output Operating load (CFL & LED): 100W Max (per switch) Fan Regulator: Variable Capacitance based 5 steps speed Operating load (Fan): 100W Radio Frequency : 433.92 Mhz Can also be operated by Remote control-103268 or web/mobile application via Gateway-101646	6700.00	7600.00	5/100
i-TOUCH RF DRAPE CONTROLLER (3 Module)				
103252	i-Touch Drapе Controller (2 Curtain) Supply voltage 160-240V~ 2.5A relay output (per chanel) Electronic RF Drapе Controller suitable for AC Motor Radio Frequency : 433.92 Mhz Can also be operated by RF Remote control-103268 or web/mobile application via Gateway-101646	4900.00	5700.00	5/100
RF REMOTE (RADIO FREQUENCY)				
103268	RF Remote with Stand 2 Nos AAA 1.5V Battery Radio Frequency : 433.92 Mhz All scene setting can be done through the Remote. - Battery not included <i>#please refer page no. 25 for wiring diagram & technical details of Touch Switches.</i>	-	1999.00	5/100

RF i-TOUCH / RF i-FEEL / RF TOUCH SYSTEMS

Installing i-Touch, i-Feel or Touch Switches does not require any drilling or any additional wiring. Simply plug them into your existing wiring. All i-Touch, i-Feel & Touch devices are designed with Switched Mode Power Supply (SMPS) for improved reliability, over current and over voltage protection. (For specific installation and technical details, please refer to the Technical Sheet provided within the product packaging). In case you need to upgrade, these electronic Touch devices can easily replace your existing Curve / Nixon modular switches.

RF I-Touch 4 Switch + Master Switch (Wiring Diagram)

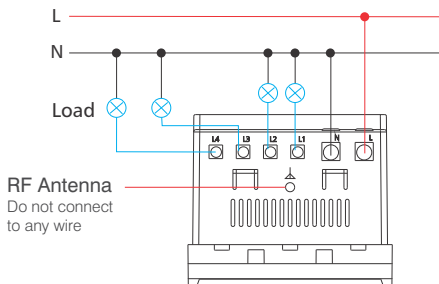

103244

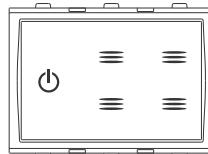

Technical Specifications

- Rated Voltage: 160-240V~ 50-60Hz
- Rated Load per Switch :
- a) Capacitive Load - CFL & LED (PF>0.8) : 100W
- b) Resistive Load - Incandescent & Halogen Lights: 1000 W
- c) Inductive Load - Fan and Motor : 800W
- Service Life: 50,000 Operations

RF I-Touch 2 Switch + Fan Regulator (Wiring Diagram)

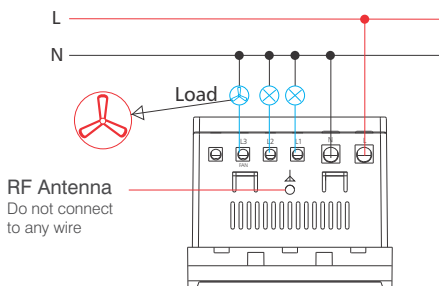

103249

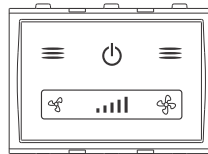

Technical Specifications

- Rated Voltage: 160-240V~ 50Hz
- Rated Load per switch:
- a) Capacitive Load - CFL & LED (PF>0.8) : 100W
- b) Resistive Load - Incandescent & Halogen Lights: 1000 W
- c) Inductive Load - Fan and Motor - 800 W
- Rated Load: Fan Regulator - Max 100 W
- 5-Level Speed Selection with Indicator
- Service Life: 50,000 Operations

RF Touch Switch (Wiring Diagram)

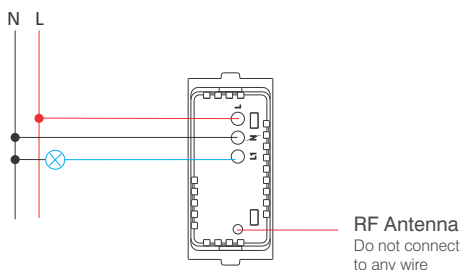

101206



Technical Specifications

- Rated Voltage: 160-240V~ 50-60Hz
- Rated Load:
- a) Capacitive Load - CFL & LED (PF>0.8) : 100W
- b) Resistive Load - Incandescent & Halogen Lights: 1000 W
- c) Inductive Load - Fan and Motor : 800W
- Service Life: 50,000 Operations

RF Touch Fan Regulator (Wiring Diagram)

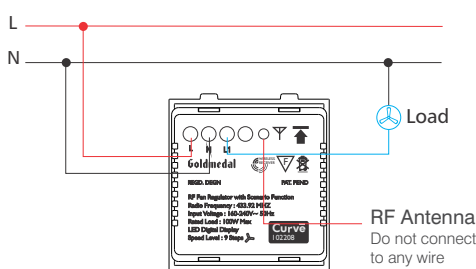

102208

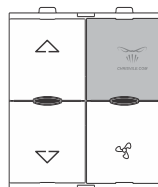

Technical Specifications

- Rated Voltage: 160-240V~ 50Hz
- Rated Load: Max 100 W.
- 9 Level Speed Selection
- 7 Segment Digital Display for Indicating Speed Level of the Fan.
- Service Life: 50,000 Operations

Wire colour codes: ■ Red (live),
■ Black (neutral),
■ Blue (load).



Code	Item	MRP ₹		Pkg.
		White Jazz	Digital Chrome Voltage Grey	
MP4 PLAYER DETACHABLE (4 Module)				
104271*	Mp4 Player Detachable Supply voltage 240V~ 2.8" wide screen TFT LCD Display, Feather Touch interface integrated with 8GB flash memory. Rechargeable lithium battery with audio playtime 20 hrs. Digital video playback, Music Player, FM Radio, E-book & Photos USB cable & stereo earphone included	-	8400.00	5/50
BLUETOOTH PLAYER (2 Module)				
102273	Bluetooth Player Supply voltage 240V~ Bluetooth player with transmitter & receiver. Multi colour LED to display different status Audio input - 3.5mm jack, Bluetooth (Rx mode) Audio output - Can be connected to bluetooth speaker or headphones in Tx mode (Input - Aux in) - Can be connected to any music system, home audio system, speakers i.e ceiling or inwall through amplifier via Line out Amplifier supplied separately - 101320	4900.00	5600.00	5/100
BLUETOOTH & FM PLAYER (8 Module)				
108274	Bluetooth & FM Player with Speaker Supply voltage 240V~ Mode selection -Aux (Line 1), Aux (Line 2), FM & Bluetooth. Audio input - 3.5 jack (Front), Line In (Back), Bluetooth Audio output - Inbuilt Stereophonic Speaker 3W x 2 - Can be connected to any music system, home audio system, speakers i.e ceiling or inwall through amplifier via Line out Amplifier supplied separately - 101320	5999.00	6499.00	5/50
JUKE BOX (4 Module)				
104277*	Juke Box with Remote Supply voltage 240V~ Touch Screen interface with inbuilt FM Radio, TFT with Multi Colour LCD display Micro SD Card slot, USB Drive 2.0 High speed. Audio input & output - 3.5mm jack Audio output - Stereo Line out, 2 Speaker out 3W each - Can be connected to any music system, home audio system, speakers i.e ceiling or inwall through amplifier via Line out (Aux out) Amplifier supplied separately - 101320 * introducing shortly	7200.00	8300.00	5/50



Code	Item	MRP ₹		Pkg.
		White Jazz	Digital Chrome Voltage Grey	

i - DOCK PLAYER (4 Module)

104281	<p>i-Dock Player Supply voltage 240V~ Inbuilt stereo amplifier : 2 x 4W, charging function for i-pod & i-phone. Audio input - 3.5mm jack, i-pod, i-phone & via Bluetooth Receiver (101283)</p> <p>Audio output - Stereo Line out, 2 Speaker out 4W each - Can be connected to any music system, home audio system, speakers i.e ceiling or inwall through amplifier via Line out (Aux out)</p> <p>- Amplifier supplied separately - 101320 - Bluetooth Receiver supplied separately - 101283</p> <p>Unit supplied with infrared Remote</p>	6100.00	6699.00	5/50
--------	---	---------	---------	------



BLUETOOTH RECEIVER (PORTABLE)

101283	<p>Bluetooth Receiver (Portable) Made for i-pod & i-phone docking Can be operated by any bluetooth device i.e. i-pod, i-phone, i-pad, Laptop, Mobile etc.</p>	-	2310.00	5/50
--------	--	---	---------	------



STEREOPHONIC SPEAKER (2 Module)

102306	<p>Stereophonic Speaker - 2piece set Stereophonic loud Speaker Load rating : 4W Impedance : 4 ohms</p>	1399.00	1599.00	10/100
--------	---	---------	---------	--------



MODULAR COVER PLATE SUITCASE

101645	Cover Plate Suitcase	-	4500.00	1/5
--------	-----------------------------	---	---------	-----



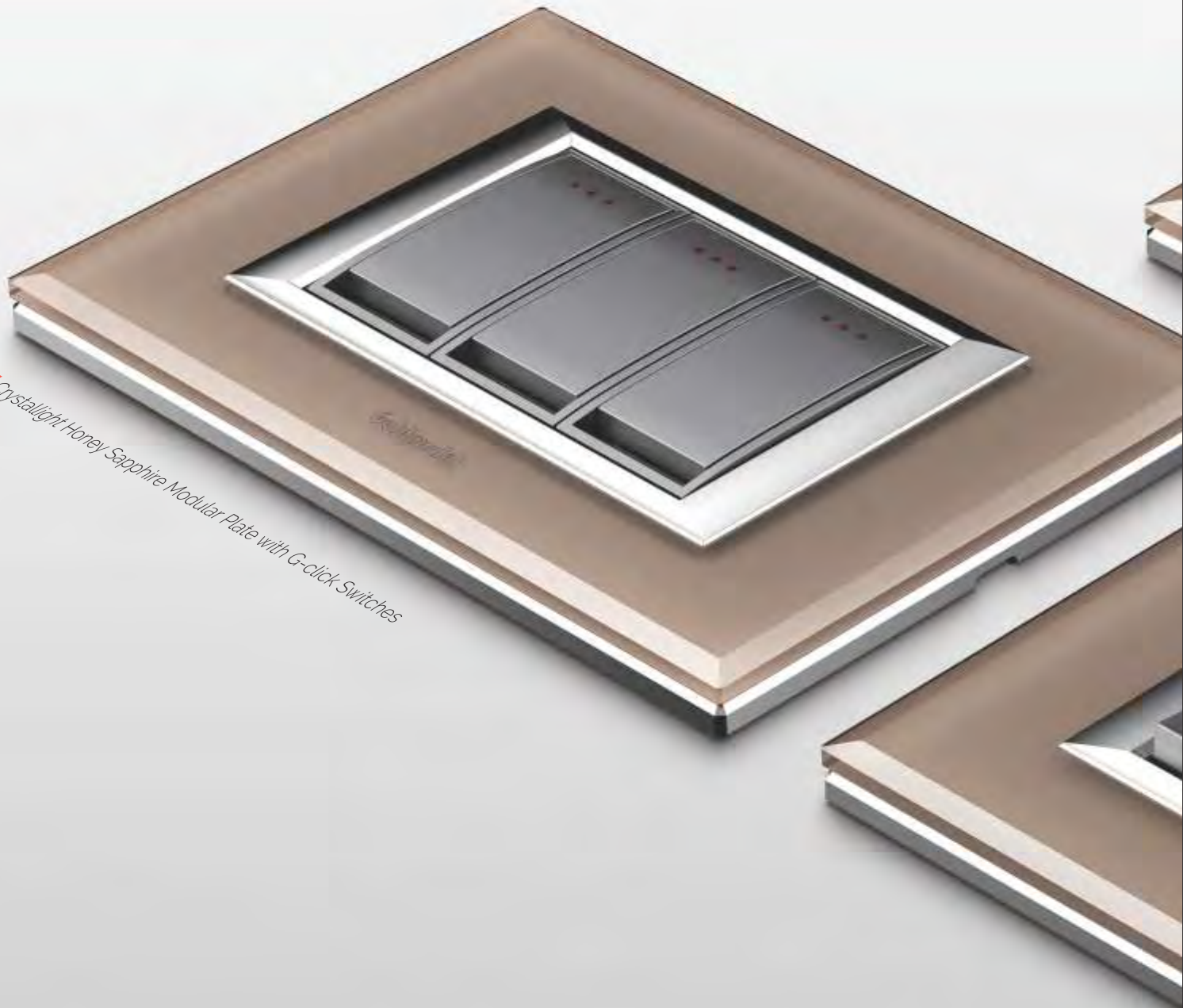

Crystalight Honey Sapphire Modular Plate with G-click Switches

Nixon

Classy and minimalistic, the Nixon range of modular inserts project a sleek, elegant presence on your walls. All Nixon products are compatible with Curve plates, making the possibilities for form, finish and colours, simply endless. Crafted in contemporary styles with minimalistic profiles in classical as well as revolutionary shades, Nixon introduces a variety of high quality lifestyle products that will change the way you look at modular switches and functions.

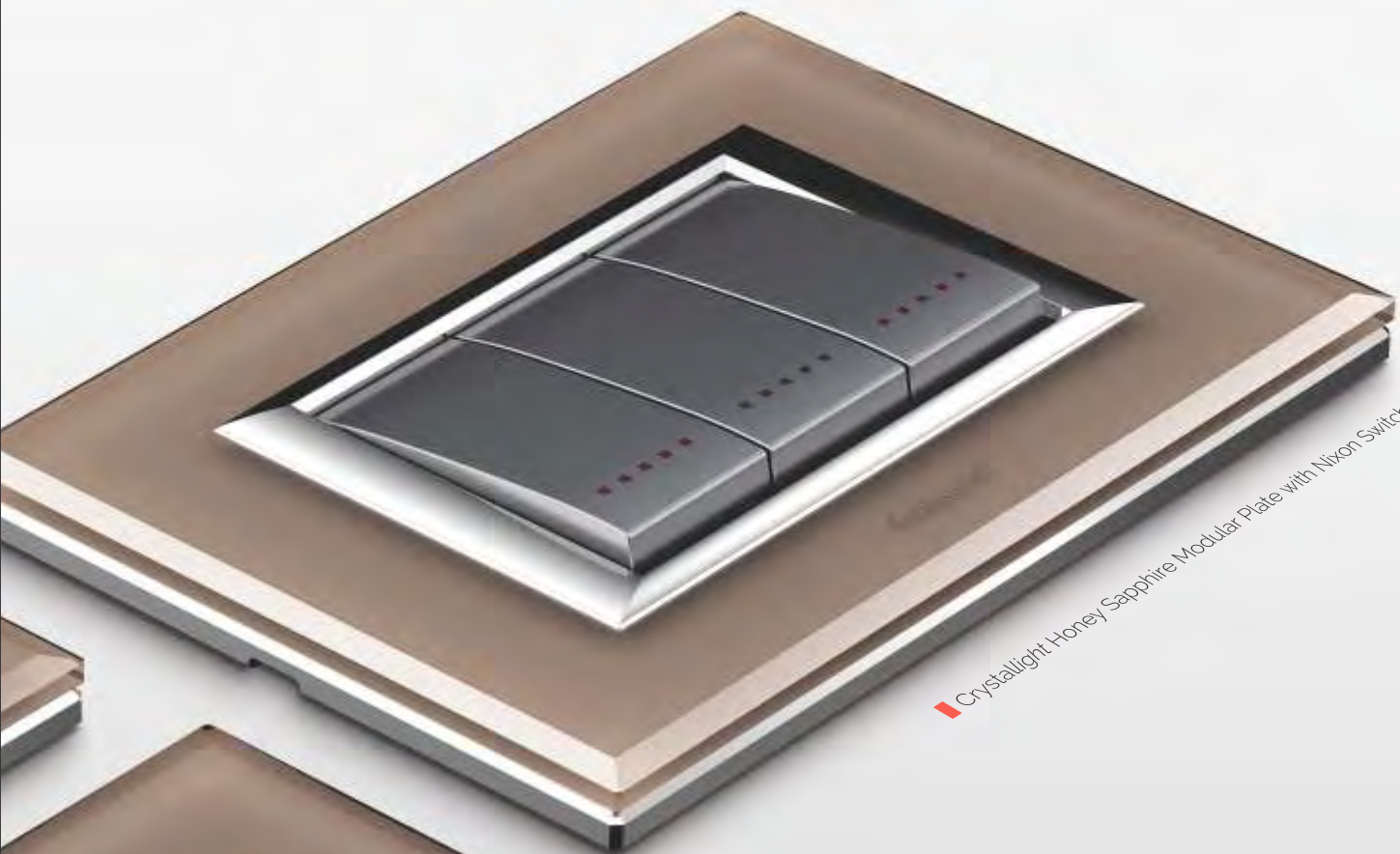

■ Crystallight Honey Sapphire Modular Plate with Nixon Switches

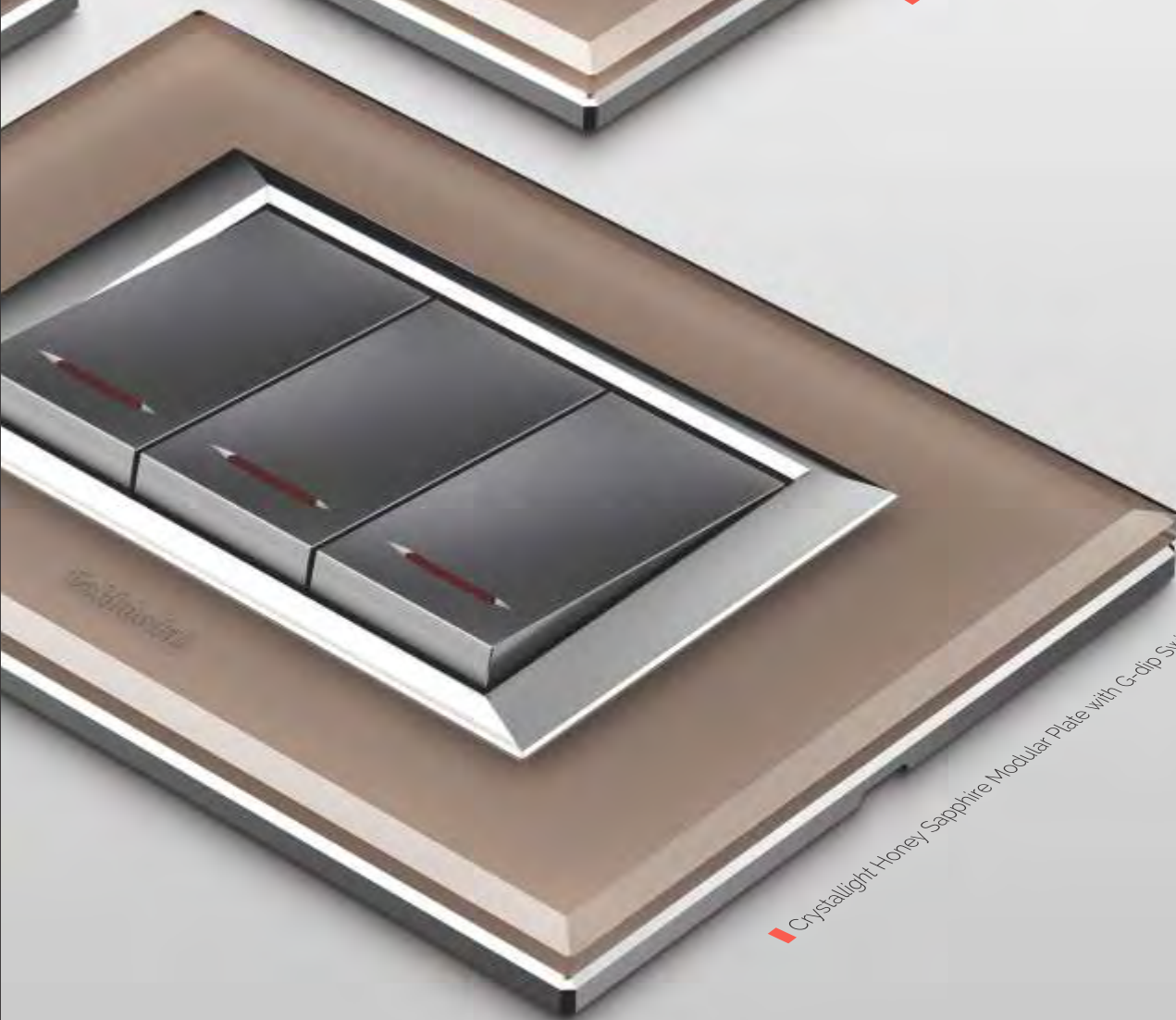

■ Crystallight Honey Sapphire Modular Plate with G-dip Switches



Code	Item	MRP ₹		Pkg.
		Absolute White	Digital Silver Titanium Grey	

10AX SWITCHES 240V~ (1 Module)

101401	1 Way Switch	70.00	77.00	20/600
101402	1 Way Switch with Indicator (LED)	134.00	148.00	20/600
101403	2 Way Switch	134.00	148.00	20/600
101404	Bell Push Switch	144.00	157.00	20/600
101405	Bell Push Switch with Indicator (LED)	164.00	180.00	20/600

10AX SWITCHES 240V~ (2 Module)

102410	1 Way Switch	151.00	166.00	10/300
102411	1 Way Switch with Indicator (LED)	171.00	188.00	10/300
102412	2 Way Switch	190.00	209.00	10/300
102413	Bell Push Switch	190.00	209.00	10/300
102414	Bell Push Switch with Indicator (LED)	211.00	232.00	10/300
102415	Bell Push Switch with Luminous	264.00	290.00	10/300

Name Plate

240V~ 50-60Hz LED circuit with diffuser

20AMP / 25AMP SWITCHES 240V~ (1 Module)

101420	20A 1 Way Switch	179.00	197.00	20/600
101421	20A 1 Way Switch with Indicator	202.00	223.00	20/600
101422	20A 2 Way Switch	202.00	223.00	20/600
101423	25A 1 Way Switch	218.00	240.00	20/600

20AMP / 25AMP SWITCHES 240V~ (2 Module)

102425	20A 1 Way Switch	208.00	228.00	10/300
102426	20A 1 Way Switch with Ind. (LED)	231.00	254.00	10/300
102427	20A 2 Way Switch	249.00	275.00	10/300
102428	25A 1 Way Switch	264.00	290.00	10/300

32AMP DP SWITCHES 240V~ (2 Module)

102431	32A DP Switch with Indicator (LED)	357.00	393.00	10/300
--------	------------------------------------	--------	--------	--------



Code	Item	MRP ₹		Pkg.
		Absolute White	Digital Silver Titanium Grey	

G-Click 10AX SWITCHES 240V~ (1 Module)

NEW

101751	1 Way Switch	77.00	84.00	20/600
101752	1 Way Switch with Indicator (LED)	140.00	155.00	20/600
101753	2 Way Switch	140.00	155.00	20/600
101754	Bell Push Switch	150.00	164.00	20/600
101755	Bell Push Switch with Indicator (LED)	172.00	189.00	20/600



G-Click 10AX SWITCHES 240V~ (2 Module)

NEW

102760	1 Way Switch	158.00	174.00	10/300
102761	1 Way Switch with Indicator (LED)	179.00	197.00	10/300
102762	2 Way Switch	199.00	218.00	10/300
102764	Bell Push Switch with Indicator (LED)	220.00	242.00	10/300



G-Click 20AMP / 25AMP SWITCHES 240V~ (1 Module)

NEW

101770	20A 1 Way Switch	187.00	206.00	20/600
101771	20A 1 Way Switch with Indicator	212.00	233.00	20/600
101772	20A 2 Way Switch	212.00	233.00	20/600
101773	25A 1 Way Switch	229.00	252.00	20/600



G-Click 20AMP / 25AMP SWITCHES 240V~ (2 Module)

NEW

102775	20A 1 Way Switch	217.00	239.00	10/300
102776	20A 1 Way Switch with Ind. (LED)	241.00	265.00	10/300
102777	20A 2 Way Switch	261.00	287.00	10/300
102778	25A 1 Way Switch	277.00	305.00	10/300



G-Click 32AMP DP SWITCHES 240V~ (2 Module)

NEW

102781	32A DP Switch with Indicator (LED)	374.00	412.00	10/300
--------	------------------------------------	--------	--------	--------





Code	Item	MRP ₹		Pkg. Outer/ Master
		Absolute White	Digital Silver Titanium Grey	
G-Dip 10AX SWITCHES 240V~ (1 Module)		NEW		
101801	1 Way Switch	70.00	77.00	20/600
101802	1 Way Switch with Indicator (LED)	134.00	148.00	20/600
101803	2 Way Switch	134.00	148.00	20/600
101804	Bell Push Switch	144.00	157.00	20/600
101805	Bell Push Switch with Indicator (LED)	164.00	180.00	20/600

G-Dip 10AX SWITCHES 240V~ (2 Module)		NEW		
102810	1 Way Switch	151.00	166.00	10/300
102811	1 Way Switch with Indicator (LED)	171.00	188.00	10/300
102812	2 Way Switch	190.00	209.00	10/300
102813	Bell Push Switch	190.00	209.00	10/300
102814	Bell Push Switch with Indicator (LED)	211.00	232.00	10/300

G-Dip 20AMP / 25AMP SWITCHES 240V~ (1 Module)		NEW		
101820	20A 1 Way Switch	179.00	197.00	20/600
101821	20A 1 Way Switch with Indicator	202.00	223.00	20/600
101822	20A 2 Way Switch	202.00	223.00	20/600
101823	25A 1 Way Switch	218.00	240.00	20/600

G-Dip 20AMP / 25AMP SWITCHES 240V~ (2 Module)		NEW		
102825	20A 1 Way Switch	208.00	228.00	10/300
102826	20A 1 Way Switch with Ind. (LED)	231.00	254.00	10/300
102827	20A 2 Way Switch	249.00	275.00	10/300
102828	25A 1 Way Switch	264.00	290.00	10/300

G-Dip 32AMP DP SWITCHES 240V~ (2 Module)		NEW		
102831	32A DP Switch with Indicator (LED)	357.00	393.00	10/300



Code	Item	MRP ₹		Pkg.
		Absolute White	Digital Silver Titanium Grey	

6AMP / 13AMP SOCKETS 240V~

101435	6A 2 Pin Socket (1M) with safety shutter	118.00	130.00	20/600
102437	6A 2x1 Socket (2M) with safety shutter	138.00	152.00	10/450
102439	10A International Socket (2M) with safety shutter	152.00	239.00	10/450
102440	6A Universal Socket (2M) with mobile socket & safety shutter	161.00	178.00	10/450



6&16AMP / 6&25AMP SOCKETS 240V~

102441	6&16A Universal Socket (2M) with safety shutter	261.00	287.00	10/450
102442	6&25A Universal Socket (2M) with safety shutter	282.00	310.00	10/450
103443	6&16A Universal Socket (3M) with safety shutter	234.00	256.00	10/300



6 & 16AMP SOCKET WITH FLAP - (2 Module)

102444	6&16A Universal Socket with flap & Indicator - 240V~	320.00	353.00	10/450
--------	---	--------	--------	--------



DIMMER / FAN REGULATOR 240 V~

101445	Dimmer - 450W (1M)	332.00	365.00	20/600
101451	4 Step Regulator (1M)	489.00	538.00	20/600
102452	5 Step Regulator (2M) - Regulator Supplied with ISI & Non ISI	521.00	573.00	10/300



FAN REGULATOR 240V~ (2 Module)

102453	5 Step Galaxy Step Regulator Half Rotary (Pure White)	512.00	-	10/300
102454	5 Step Galaxy Step Regulator Full Rotary (Pure White) - Regulator Supplied with ISI & Non ISI	512.00	-	10/300



FAN REGULATOR 240V~ (2 Module)

102453A	5 Step Galaxy Step Regulator Half Rotary (Chrome Knob)	535.00	588.00	10/300
102454A	5 Step Galaxy Step Regulator Full Rotary (Chrome Knob) - Regulator Supplied with ISI & Non ISI	535.00	588.00	10/300





Code	Item	MRP ₹		Pkg.
		Absolute White	Digital Silver Titanium Grey	
MOTOR STARTER (SP) 240V~ 50-60Hz (2 Module)				
102456	10A Motor Starter Switch	648.00	712.00	10/300
102457	16A Motor Starter Switch	648.00	712.00	10/300
102458	20A Motor Starter Switch	648.00	712.00	10/300
102459	25A Motor Starter Switch	648.00	712.00	10/300
102460	32A Motor Starter Switch	648.00	712.00	10/300
TV SOCKET / RJ-11 TELEPHONE JACKS / EDP SOCKET (1 Module)				
101462	TV Socket Coaxial 40-862 Mhz Socket	144.00	157.00	20/900
101468	Telephone Jack - RJ 11	152.00	167.00	20/600
101472	EDP Socket Outlet - RJ 45 (Cat 5e) Category 5e, Universal wiring T568A, insulating-piercing terminal	254.00	279.00	20/600
101474	EDP Socket Outlet - RJ 45 (Cat 6e) Category 6e, Universal wiring T568A, insulating-piercing terminal	640.00	704.00	20/600
SINGLE POLE MCBS 240/450V~ (1 Module)				
101477	C6 SP MCB	326.00	358.00	20/600
101478	C10 SP MCB	326.00	358.00	20/600
101479	C16 SP MCB	326.00	358.00	20/600
101480	C20 SP MCB	326.00	358.00	20/600
101481	C25 SP MCB	326.00	358.00	20/600
101482	C32 SP MCB	326.00	358.00	20/600
240/450V~ 50-60Hz 3kA Breaking Capacity				
DOUBLE POLE MCBS 240/450V~ (2 Module)				
102483	C6 DP MCB	643.00	707.00	10/300
102484	C10 DP MCB	643.00	707.00	10/300
102485	C16 DP MCB	643.00	707.00	10/300
102486	C20 DP MCB	643.00	707.00	10/300
102487	C25 DP MCB	643.00	707.00	10/300
102488	C32 DP MCB	643.00	707.00	10/300
240/450V~ 50-60Hz 3kA Breaking Capacity				
G-POWER 25A UNIT (4 Module)				
104491	G-Power 25A Unit (Metal Box) with Concealed Metal Junction Box (4M Plate with 25A MCB, 25A Socket & 16A G-grip Top)	839.00	929.00	5/60
104492	G-Power 25A Unit (Plastic Box) with G-surface Plastic Gang Box (4M Plate with 25A MCB, 25A Socket & 16A G-grip Top)	809.00	889.00	5/60
240/450V~ 50-60Hz 3kA Breaking Capacity				
INDICATOR / FUSE UNIT / BLANK MODULE (1 Module)				
101493	Indicator with LED & Red Diffuser	122.00	133.00	20/600
101498	Fuse Carrier (10Amp/16Amp) with miniature fuse dia 6.3x28	164.00	180.00	20/600
101525	Blank Module	30.00	32.00	50/2000



Code	Item	MRP ₹		Pkg.
		Absolute White	Digital Silver Titanium Grey	

STEP MARKER

102505	Step Marker (2M) Supply voltage 240V~ 50-60Hz with high-efficiency 0.5W LED	569.00	626.00	5/120
103506	Step Marker with Dimmable Function (3M)	1047.00	1151.00	5/100
102507	Step Marker with Dimmable Function (2M) Supply voltage 240V~ 50-60Hz with high-efficiency 2x0.5W LED & 3 level dimmable function	775.00	852.00	5/100



LIGHTING FITTING WITH EMERGENCY FUNCTION

102510	Lighting Fitting with Emergency Function (2M) with High Efficiency 2x0.5W LED	1082.00	1164.00	5/100
103511	Lighting Fitting with Emergency Function (3M) with High Efficiency 3x0.5W LED Supply voltage 160-240V~ 50Hz Dimmable function (3 Level) The device will function as an emergency light if battery is inserted - Battery supplied separately (101124)	1525.00	1646.00	5/100



EMERGENCY LIGHT BATTERY

101124	Battery Li-ion, 3.6V, 600mAH 2/3A	261	-	20/600
--------	--	-----	---	--------



ELECTRO MECHANICAL BUZZER / ELECTRONIC BUZZER 240V ~

101530	Electro Mechanical Buzzer (1M) 240V~50-60Hz	171.00	187.00	20/600
102539	Electronic Bell (2M) 240V~50-60Hz	387.00	425.00	10/300



ELECTRONIC DOOR BELLS (4 Module)

104541	Electronic Multi Tune Bell with 4 selectable melodies & Supply voltage 240V~ 50-60Hz,	1034.00	1150.00	5/150
--------	--	---------	---------	-------



i-TOUCH RF SWITCHES / BELL PUSH (2 Module)

102544	i-Touch 2 Switch Supply voltage 160-240V~, 6A relay output Operating load (CFL & LED): 100W Max (per switch) Radio Frequency : 433.92 Mhz Can also be operated by RF Remote control-103268 or web/mobile application via Gateway-101646	3500.00	3900.00	5/100
102545	i-Touch Universal Switch Supply voltage 240V~, - Can be paired wirelessly with any Goldmedal RF switch, fan regulator, dimmer etc. (Touch, i-Touch and i-Feel) as a two way switch - Can be configured as a switch for any particular scene or All ON or All OFF command	3900.00	4300.00	5/100





Code	Item	MRP ₹		Pkg.
		Absolute White	Digital Silver Titanium Grey	
i-TOUCH RF 20A SWITCH (2 Module)				
102548	i-Touch Bell Push Switch Supply voltage 160-240V~ 2A relay output	2300.00	2500.00	5/100
102550	i-Touch 20A Switch Supply voltage 160-240V~, 20A relay output Operating load (CFL & LED): 200W Max Air conditioner: 2 ton Radio Frequency : 433.92 Mhz Can also be operated by RF Remote control-103268 or web/mobile application via Gateway-101646	3600.00	4000.00	5/100
i-TOUCH RF DIMMER/FAN REGULATOR/DRAPE CONTROLLER (2 M)				
102553	i-Touch Light Dimmer Supply voltage 160-240V~, Triac Technology with soft end & soft start function Operating load (LED) : 80W (Max) Incandescent Light: 40-450W Not suitable for Fan	3500.00	3800.00	5/100
102554	i-Touch Fan Regulator Supply voltage 160-240V~ Variable Capacitance based 4 step regulator Operating load (Fan) : 100W	3500.00	3800.00	5/100
102556	i-Touch Drape Controller Supply voltage 160-240V~ 2.5A relay output Electronic RF Drape Controller suitable for AC Motor Radio Frequency : 433.92 Mhz Can also be operated by RF Remote control-103268 or web/mobile application via Gateway-101646	3800.00	4200.00	5/100
i-TOUCH DO NOT DISTURB/MAKE MY ROOM (2 Module)				
102560	i-Touch DND / Make My Room / Please Wait (Inside Room)	2100.00	2500.00	5/100
102561	i-Touch DND / Make My Room / Please Wait with Bell Push Switch (Outside Room) Supply voltage 160-240V~ (Inside & outside unit are connected to each other)	2300.00	2700.00	5/100
32A MAIN SWITCH (3 Module)				
103562	32A DP Operated by Key Tag 240V~, LED Supplied with Key Tag For key tag please refer Curve product 102164	645.00	709.00	5/150
32A MAIN SWITCH (2 Module)				
102563	32A DP Operated by Key Tag 240V~, LED Supplied with Key Tag	600.00	660.00	10/300
102564	Only Key Tag with Name Plate	111.00	121.00	N.A.
25A ELECTRONIC BADGE SWITCH (3 Module)				
103565	Electronic Switch with Smart Card 25A, 160-240V~ 50-60Hz with indicator (LED) & Integral relay having exit delay. For smart card please refer Curve product 103166	1590.00	1746.00	5/100



Code	Item	MRP ₹		Pkg.
		Absolute White	Digital Silver Titanium Grey	

BELL INDICATOR (6 Module)

106567	Bell Indicator for Call Display 6 Way with Name Plate 240V~	1699.00	1899.00	5/100
--------	---	---------	---------	-------



DND/MAKE MY ROOM 240~ (2 Module)

102568	Do Not Disturb/Make My Room 240V~ 50-60Hz - Inside Room	457.00	498.00	10/300
102569	Do Not Disturb/Make My Room 240V~ 50-60Hz - Outside Room	488.00	529.00	10/300



USB CHARGER 240~

101572	USB Charger - (1M) Supply voltage 160-240V~ 50-60Hz	865.00	952.00	10/300
102573	USB Charger - Double Port (2M) Supply voltage 160-240V~ 50-60Hz Output - 5V DC, 2A (Total)	1020.00	1122.00	5/100
103574	USB Charger & 10A Int. Socket (3M) Supply voltage 160-240V~ 50-60Hz Output - 5V DC, 2A (Total)	1468.00	1612.00	5/100



AUDIO - VIDEO SOCKET (1 Module)

101577	HDMI Socket	1000.00	1102.00	5/150
101579	Triple RCA Socket (Audio & Video)	660.00	720.00	5/150



ROUTER + EXTENDER (3 Module)

NEW

103580	Wi-Fi Router + Extender 300 MBPS wi-fi wireless router with Ethernet port, In-built USB port for internet connectivity and charging devices. Also support 4G dongle.	4500.00	5000.00	5/100
--------	---	---------	---------	-------



i-SENSE RF SWITCHES / DIMMER (2 Module)

102585*	i-Sense 4 Switch Feather Touch Electronic RF Switch 6A 240V~ relay output	-	6500.00	5/100
102587*	i-Sense 2 Switch + 1 Dimmer Feather Touch Electronic RF Switch & Dimmer 6A 240V~ relay output Triac Technology with soft end & soft start function Operating load : 300-450W Radio Frequency : 433 Mhz Supply voltage 240V~ Can also be operated by RF Remote control-103268 or web/mobile application via Gateway-101646	-	6800.00	5/100



* introducing shortly



Code	Item	MRP ₹		Pkg.
		Absolute White	Digital Silver Titanium Grey	
i-SENSE RF FAN REGULATOR / DRAPE CONTROLLER (2 Module)				
102589*	i-Sense 2 Switch + 1 Fan Regulator Feather Touch Electronic RF Switch & Regulator 6A 240V~ relay output Moftset Technology with 5 steps fan coil speed Operating load (fan) : 100W	-	7300.00	5/100
102591*	i-Sense Draper Controller (2Curtain) Feather Touch Electronic RF Draper Controller 6A 240V~ relay output Radio Frequency : 433 Mhz Supply voltage 240V~ Can also be operated by RF Remote control-103268 or web/mobile application via Gateway-101646	-	5700.00	5/100
i-SENSE HOME STATION & TFT COLOUR DISPLAY (2 Module)				
102596*	i-Sense Home Station Feather Touch Electronic Home Station Switching Lights, Operating Door, Call acceptance, Volume control of ringing tone.	-	8999.00	5/100
102597*	i-Sense TFT Colour Display TFT Colour display with high quality picture even viewed at an angle Colour display switches on automatically when bell is actuated & can also be switch on manually Supply voltage 240V~	-	10999.00	5/100
CAMERA / IP CAMERA				
102598*	Camera (2M) Automatic day/night switching, Camera can be manually swivelled 20° horizontally & vertically Automatic background lighting compensation. Automatic gain control (AGC) Protection type IP 44	-	8999.00	5/100
103599*	IP Camera (3M) Automatic day/night switching, Camera can be manually swivelled 20° horizontally & vertically Automatic background lighting compensation. Automatic gain control (AGC) Supply voltage 160-240V~	-	14400.00	5/100
i-SENSE SENSO SWITCH (2 Module)				
102601	i-Sense Senso Switch NEW Supply voltage 160-240V~ 6A relay output Allows to control lights by simply passing the hand in front of it (Max distance 50mm). 2 units can be combined to control the same light (2 way function).	3999.00	4399.00	5/100
i-SENSE FM RADIO / BLUETOOTH PLAYER				
102603*	i-Sense FM Radio (2M) Feather touch FM radio with digital display 87-50 MHZ, 30 Station Memory with scanner	-	6100.00	5/100
103604	i-Sense FM Radio / Bluetooth (3M) NEW FM & Bluetooth player Mode selection : FM & Bluetooth. Audio output - Stereo Line out - Can be connected to any music system, home audio system, speakers i.e ceiling or inwall through amplifier via Line out, Supply voltage 240V~ - Amplifier supplied separately - 101320	7500.00	-	5/100



Code	Item	MRP ₹		Pkg.
		Absolute White	Digital Silver Titanium Grey	

Outer/
Master

STEREOPHONIC SPEAKER

102610*	Stereophonic Speaker (2M)	-	850.00	5/100
103611*	Stereophonic Speaker (3M) Stereophonic Loud Speaker Load rating : 4W Impedance : 4 ohms	-	980.00	5/100

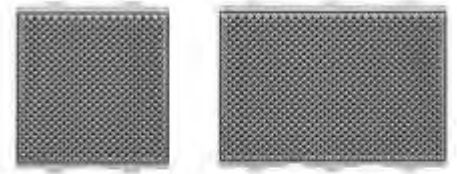

i-FEEL RF SWITCHES / BELL PUSH SWITCH (2 Module)

102626	i-Feel 2 Switch Supply voltage 160-240V~, 6A relay output Operating load (CFL & LED): 100W Max (per switch) Radio Frequency : 433.92 Mhz - Can also be operated by RF Remote control-103268 or web/mobile application via Gateway-101646	4500.00	5000.00	5/100
102630	i-Feel Bell Push Switch Supply voltage 160-240V~ 2A relay output	3000.00	3300.00	5/100



i-FEEL RF 20A SWITCH (2 Module)

102632	i-Feel 20A Switch Supply voltage 160-240V~, 20A relay output Operating load (CFL & LED): 200W Max Air Conditioner: 2 ton Radio Frequency : 433.92 Mhz Can also be operated by RF Remote control-103268 or web/mobile application via Gateway-101646	4700.00	5800.00	5/100
--------	---	---------	---------	-------



i-FEEL RF DIMMER / FAN REGULATOR (2 Module)

102634*	i-Feel Light Dimmer Supply voltage 160-240V~, Triac Technology with soft end & soft start function Operating load LED: 80W Incandescent Light: 40-450W Not suitable for Fan	4500.00	5000.00	5/100
102636	i-Feel Fan Regulator Supply voltage 160-240V~ Variable Capacitance based 4 step regulator Operating load (Fan) : 100W Radio Frequency: 433.92 Mhz Can also be operated by RF Remote control-103268 or web/mobile application via Gateway-101646	4500.00	5000.00	5/100

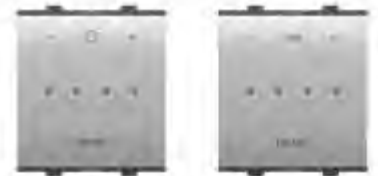

i-FEEL RF DRAPE CONTROLLER (2 Module)

102638	i-Feel Drape Controller Supply voltage 160-240V~ 2.5A relay output Electronic RF Drape Controller suitable for AC Motor Radio Frequency : 433.92 Mhz Can also be operated by RF Remote control-103268 or web/mobile application via Gateway-101646	4600.00	5000.00	5/100
--------	---	---------	---------	-------



i-REMOTE CONTROL

101926	i-Remote with Micro USB Cable Wifi-IR Remote Control Universal Infrared Remote Control Can operate TV, Set Top Box, AC and other IR Remotes Works with WiFi through iWorld App or Voice Command (Google Home / Amazon Alexa)	-	3999.00	1/1
--------	---	---	---------	-----



i-HOME AUTOMATION

101646	i-Home Gateway - Compatible with RF Touch, i-Touch & i-Feel products. - Connects electrical functions through a router. - Control from anywhere using your smartphone / tablet / laptop / desktop. - Individual device control as well as scene settings. - Schedule individual devices as well as scenes.	15999.00	-	1/1
--------	--	----------	---	-----



*introducing shortly



Code	Item	MRP ₹		Pkg.
		Absolute White	Digital Silver Titanium Grey	
NEW				
i-TOUCH WI-FI SWITCH (2 Module)				
102901	i-Touch - Wi-Fi 2 Switch Supply voltage 160-240V~, 6A relay output Operating load (CFL & LED): 100W Max (per switch) Radio Frequency : 433.92 Mhz Can also be operated by RF Remote control-103268 or via WI-FI Internet (without Gateway)	4999.00	5499.00	5/100
NEW				
i-TOUCH WI-FI 20A SWITCH (2 Module)				
102903	i-Touch - Wi-Fi 20A Switch Supply voltage 160-240V~, 20A relay output Operating load (CFL & LED): 200W Max Air conditioner: 2 ton Radio Frequency : 433.92 Mhz Can also be operated by RF Remote control-103268 or via WI-FI Internet (without Gateway)	4999.00	5499.00	5/100
NEW				
i-TOUCH WI-FI DIMMER/FAN REGULATOR (2 Module)				
102906	i-Touch Wi-Fi Dimmer Supply voltage 160-240V~, Triac Technology with soft end & soft start function Operating load (LED) : 80W (Max) Incandescent Light: 40-450W Not suitable for Fan	4999.00	5499.00	5/100
102907	i-Touch Wi-Fi Fan Regulator Supply voltage 160-240V~ Variable Capacitance based 4 step regulator Operating load (Fan) : 100W Radio Frequency : 433.92 Mhz Can also be operated by RF Remote control-103268 or via WI-FI Internet (without Gateway)	4999.00	5499.00	5/100
NEW				
i-TOUCH WI-FI DRAPE CONTROLLER (2 Module)				
102909	i-Touch Wi-Fi Drape Controller Supply voltage 160-240V~ 2.5A relay output Electronic RF Drape Controller suitable for AC Motor Radio Frequency : 433.92 Mhz Can also be operated by RF Remote control-103268 or via WI-FI Internet (without Gateway)	4999.00	5499.00	5/100
NEW				
i-TOUCH WI-FI SWITCH (3 Module)				
103913	i-Touch - Wi-Fi 4 Switch with Master Supply voltage 160-240V~, 6A relay output Operating load (CFL & LED): 100W Max (per switch) Radio Frequency : 433.92 Mhz	6600.00	7300.00	5/100
103916	i-Touch - Wi-Fi 2 Switch + 1 Fan Regulator with Master Supply voltage 160-240V~, 6A relay output Operating load (CFL & LED): 100W Max (per switch) Radio Frequency : 433.92 Mhz Can also be operated by RF Remote control-103268 or via WI-FI Internet (without Gateway)	7600.00	8400.00	5/100
NEW				
i-TOUCH WI-FI PANEL 240V~ (6 Module)				
106925	i-Touch - Wi-Fi 6 Switch + Fan Reg. + 2 USB Port + Int. Socket (With Glass Plate) Supply voltage 160-240V~, 6A relay output Operating load (CFL & LED): 100W Max (per switch) Radio Frequency : 433.92 MHz Variable Capacitance based 5 Step Fan Regulator USB Output: 5V 2A DC (Max) Socket: 10A International Socket Can also be operated by RF Remote control-103268 or via WI-FI Internet (without Gateway)	-	13500.00	5/100
NEW				
IN-WALL WI-FI CONTROLLER 240V~				
101931	In-Wall - Wi-Fi 3 Switch Controller Supply voltage 160-240V~, 6A relay output Operating load (CFL & LED): 100W Max (per switch) Compatible with existing modular switches Can also be operated by RF Remote control-103268 or via WI-FI Internet (without Gateway)	-	3100.00	5/100



Code	Item	MRP ₹		Pkg.
		Absolute White	Digital Silver Titanium Grey	

NEW

IN-WALL WI-FI CONTROLLER 240V~

101933	In-Wall - Wi-Fi Fan Regulator Controller Supply voltage 160-240V~ Variable Capacitance based 4 step regulator, works with modular switch / bell push only (No mechanical fan regulator needed)	- 3100.00		5/100
101934	In-Wall - Wi-Fi 2 Dimmer Controller Supply voltage 160-240V~, Triac Technology with soft end & soft start function Operating load (LED) : 80W (Max) Incandescent Light: 40-450W works with modular switch / bell push only (No mechanical dimmer needed) Not suitable for Fan Compatible with existing switches Can also be operated by RF Remote control-103268 or via WI-FI Internet (without Gateway)	- 3100.00		5/100



SIGNAGE 240V~ 50-60Hz - (3 Module)

103647	Foot Light (LED) Supply voltage 240V~ 50-60Hz	569.00	639.00	5/100
103648	Step Marker (LED) Supply voltage 240V~ 50-60Hz	531.00	595.00	5/100
103649	LED Indicator Supply voltage 240V~ 50-60Hz	515.00	570.00	5/100
103650	LED Signage Supply voltage 240V~ 50-60Hz	515.00	570.00	5/100



EDGE GLOW LED SIGNAGE 240V~ 50-60 Hz - (3 Module)

103652	Edge Glow LED Signage* Supply voltage 240V~ 50-60Hz	445.00	490.00	5/100
103653	Edge Glow Square Slide customizable symbol	205.00	-	5/100
103654	Edge Glow Rectangle Slide customizable symbol	225.00	-	5/100
103655	Edge Glow L Type Slide customizable symbol	255.00	-	5/100



* Edge Glow Slide Supplied Separately

SYMBOLS FOR CUSTOMIZABLE SLIDE OF EDGE GLOW LED SIGNAGE (LASER ENGRAVING)

01	02	03	04	05	06	07	08	09
10	11	12	13	14	15	16	17	18
19	20	21	22	23	24	25	26	27
28	29	30	31	32	33	34	35	36

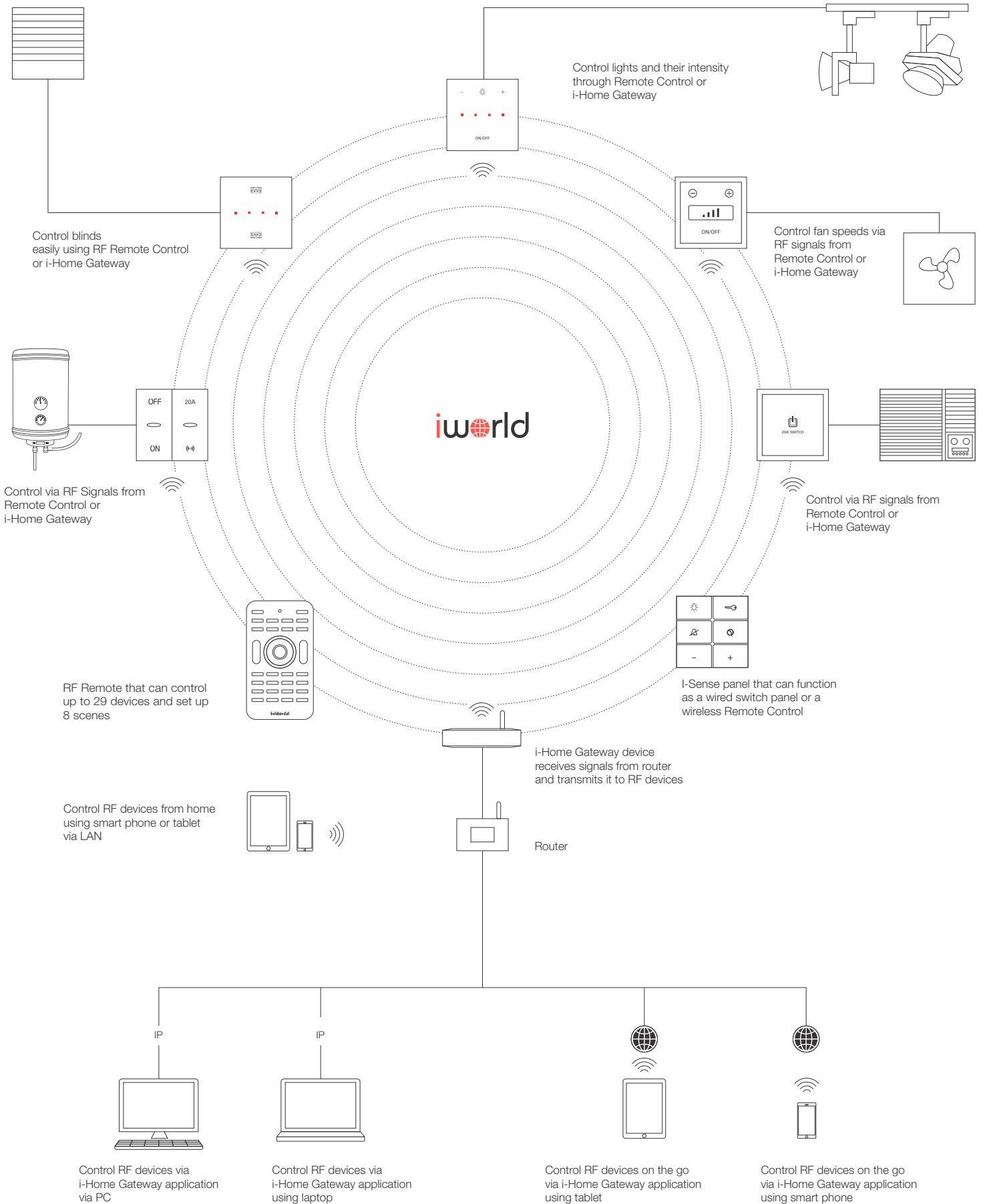



i-HOME Automation

INTELLIGENT GATEWAY



YOUR WORLD. YOUR WAY.

WELCOME TO YOUR NEW, **INTELLIGENT** HOME!



RF Touch Products



i-Touch Products



i-Feel Products

You have installed the latest Touch technology switches from Goldmedal in your home. Now, take it to the next level with the i-Home Gateway! From lights to fans to drapes and other functions, you can control individual devices, set scenes or even schedule the operations of scenes and devices using your smartphone, tablet, desktop or any smart mobile device ... from anywhere in the world.



I-HOME GATEWAY

The i-Home Gateway Router connects to your network in a few simple steps. Once connected, it captures commands from your smartphone, tablet, laptop or PC from anywhere in the world. The commands are then relayed to the relevant RF devices in the premises.

SMARTPHONE

Access the i-Home Gateway Application on the move on your Smart Phone, Tablet or PC. The intuitive interface enables you to set scenes, create timers and schedule devices as per your need!

Goldmedal i-Home

Download the Goldmedal i-Home App on your smart device to control your RF Switches from anywhere in the world. Download now!



Scan with your smartphone to download the user manual



Code	Item	MRP ₹	Pkg. Out/Master
GALAXY RGB LED SPEAKER			
101311	Galaxy RGB LED Speaker Load rating: 25W Impedance: 8 ohms - Toughened glass for maximum safety - Amplifier supplied separately - Supplied with wireless RGB LED Controller - Supplied with touch RF remote.	10399.00	1/1
2 CHANNEL AMPLIFIER			
101320	2 Channel Amplifier Power supply 110-240V~ Amplifier type BTL (class D) Output power max RL=4 ohms 35W per channel Treble (@20KHz) +- 12 db Bass (@40Hz) +- 12 db Frequency (-3 db) 25Hz-20KHz	4999.00	5/50
GIFA AUDIO HUB			
GTX 501	Audio Hub (Wireless docking station + LED Lamp Speaker) - Charging and Playback iPod models and iPhone - Plays MP3/WMA music through USB/SD/MMC card - Composite video out for iPod and iPhone - Aux in jack for Mp3 playback - DC-in Jack with AC/DC adaptor included - Docking station for iPod and iPhone - 2.4GHz wireless transmission - 85 white LED light - Back house with standard lamp E27 screw - 2.25" x 1 full range speaker - Control up to 8 group wireless devices (Supplied with wireless LED lamp speaker GRX 501)	11599.00	5/50
GIFA AUDIO LIGHT			
GRX 501	Audio Light (Wireless LED Lamp Speaker) Music power: 20W Lighting power: 5W 2.25" x 1 full range speaker Digital Amplifier - 2.4GHz wireless transmission - 85 white LED light burns upto 30,000 hrs. - Back house with standard lamp E27 connector - Semi transparent cover with metal grill - Can be paired upto 8 group wireless devices (Combine with GIFA Wireless docking GTX 501)	5999.00	5/50
I-ROCK BLUETOOTH SPEAKER			
101351	I-Rock Wireless Bluetooth Speaker Bluetooth frequency: 2.40GHz-2.480 Ghz Operating Distance: 10 meters, class II Two speakers can be paired Working time: 16 hours (one speaker) Working time: 8 hours (When two speaker use together) Charging input: DC 12V (12V DC Power adaptor included)	5999.00	5/50

Code	Item	MRP ₹	Pkg. Out/Master
------	------	-------	--------------------

KBSOUND® DOCK			
KB 50902	KBSOUND DOCK Wireless accessories for use with KBSOUND SPACE and KBSOUND iSELECT kit. Contents: Dock (52591), Wireless Module (52592), RF Antenna and 5V power supply with interchangeable plugs for different countries (When integrated with KBSOUND iSELECT you can enjoy the radio or listen to the music from your iPod, iPhone or additional sound source using a 3.5mm jack)	9999.00	5/50



KBSOUND® SPACE			
KB 50398	KBSOUND SPACE An open-ended model that allows you to freely choose your loudspeaker and amplifier to fulfil your specific design requirement. Contents: REMOTE CONTROL - IR Remote control with display screen that shows RDS information and iPod/iPhone playing list. - Keypad to access different sound sources such as FM, iPod, Audio IN and DAB. - Allows you to control the volume, bass and treble levels, together with scanning and storing stations in the memory. ELECTRONIC MODULE (52398) - Designed to incorporate the radio frequency device that permits integration with the KBSOUND DOCK. - Includes an improved antenna (RF) connector for better FM reception. IR RECEIVER / TRANSMITTER - A separate IR bi-directional receiver/transmitter to communicate with the remote.	11800.00	5/50



KBSOUND® iSELECT KIT			
KB 50302	KBSOUND iSELECT (KIT) A perfect sound system that allows you to hear FM radio and music from iPod/iPhone or 3.5mm Line IN when integrated with KBSOUND DOCK. Contents: REMOTE CONTROL - IR Remote control with display screen that shows RDS information. - Keypad to access different sound sources such as FM, iPod, Audio IN and DAB. (when integrated with KBSOUND DOCK) - Allows you to control the volume, bass and treble levels, together with scanning and storing stations in the memory. ELECTRONIC MODULE (52391) - Designed to incorporate any radio frequency device that permits integration with the KBSOUND DOCK. - Includes an improved antenna (RF) connector for better FM reception. TWO 2.5" LOUDSPEAKER - 1.5W+1.5W stereo output - IR receiver/transmitter built-in to loudspeaker grille ANTENNA WIRE (76cm) PARALLEL LOUDSPEAKER CABLING (10M)	10999.00	5/50



LOUDSPEAKERS i500 SERIES			
KB 50301*	Loudspeakers (Active & Passive Speaker) ACTIVE SPEAKER (55101) - Data and sound (four channels) input line from the central unit. - 5+5W Sound Amplifier. - 8 Ohm two-way loudspeaker. - 8 Ohm output for Passive Loudspeaker. - Line output for an Auxiliary Active Loudspeaker. - Supply voltage 110-240V~ - Load rating 20W PASSIVE LOUDSPEAKER (55301) - Two-way 8 ohm loudspeaker.	-	N.A.



* Introducing shortly



Bella White Jazz Plate with Curve White Jazz Switches

bella

You are mesmerized by the smile of a newborn; you wonder at the precision of a perfectly drawn line. Part dreamer, part realist, you synchronize your lifestyle with the demands of your heart and mind. You'll find an expression of this rare combination in the bella range of cover panels. Choose from the natural opulence of Bellewood panels, the elegant simplicity of White Jazz, the passion and energy of Metalik, the exuberance of Antik, or the soft-to-touch feel of Bellesoft. The options on offer are simply a myriad.

Bella Spirit Gold Plate with Nixon Titanium Grey Switches

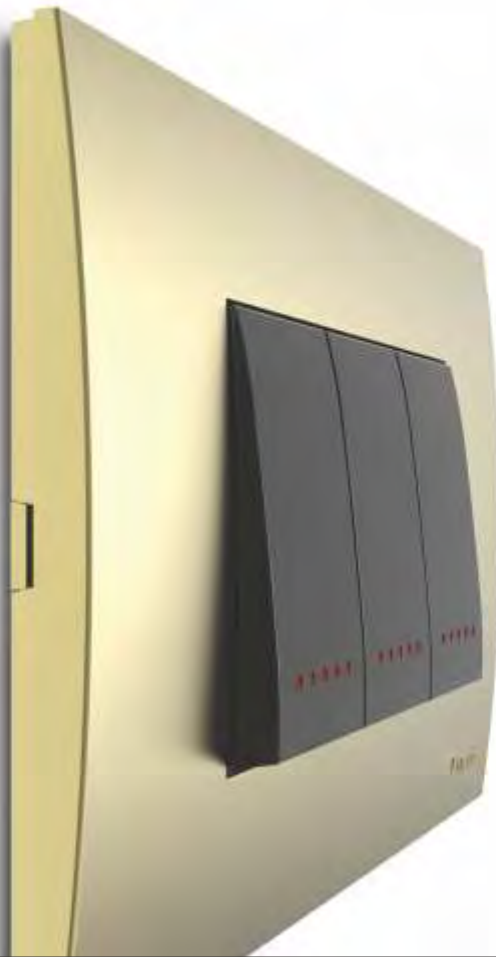

BELLA COVER PLATES WITH MOUNTING FRAMES

PLATES →	1M	2M	3M	3M*	4M	6M	7M*	8M(H)	8M*	8M (V)	8M(V)**	12M	16M	18M
COLOURS ↓	MRP ₹	MRP ₹	MRP ₹	MRP ₹	MRP ₹	MRP ₹	MRP ₹	MRP ₹	MRP ₹	MRP ₹	MRP ₹	MRP ₹	MRP ₹	MRP ₹
White Jazz	82.00	82.00	102.00	102.00	119.00	160.00	195.00	202.00	230.00	202.00	202.00	252.00	277.00	327.00
Metalik	105.00	105.00	137.00	137.00	154.00	202.00	258.00	263.00	288.00	263.00	263.00	331.00	335.00	365.00
Belle Soft	114.00	114.00	149.00	149.00	175.00	226.00	285.00	288.00	314.00	288.00	288.00	365.00	373.00	400.00
Antik	138.00	138.00	172.00	172.00	201.00	267.00	354.00	360.00	385.00	360.00	360.00	403.00	462.00	510.00
Belle Wood	138.00	138.00	172.00	172.00	201.00	267.00	354.00	360.00	385.00	360.00	360.00	403.00	462.00	510.00
CODE →	30101	30201	30301	33301	30401	30601	30701	30801	32801	38801	39801	31201	31601	31801
Outer/Master →	10/400	10/400	10/300	10/300	10/300	5/150	5/150	5/150	5/150	5/150	5/150	5/120	5/90	5/80
SIZE(mm) →	93x86	93x86	119x86	125x86	151x86	219x86	219x86	268x86	246x86	154x155	152x168	220x155	268x155	225x224

COVER PLATES

* Without Partition **8 Module Vertical Big Size



1 - Module



2 - Module



3 - Module*



3 - Module



4 - Module



6 - Module



7 - Module*



8 - Module



8 - Module*



8 - Module Vertical



8 - Module Vertical**



12 - Module



16 - Module

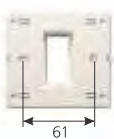

18 - Module

MOUNTING FRAMES - Horizontal & Vertical Distance for Screwing (Dimensions in mm)

61

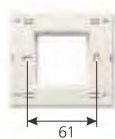

61

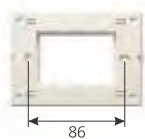

86

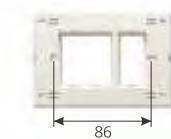

86

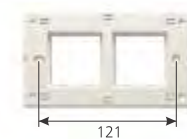

121



195

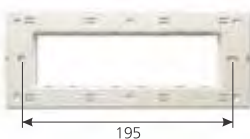

195

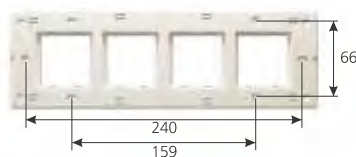

240

159

66

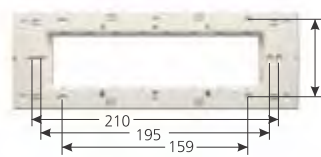

210

195

159

66

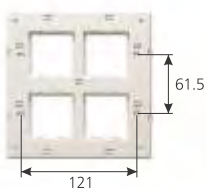

121

61.5

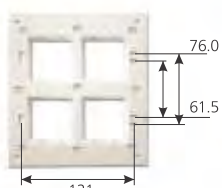

121

76.0

61.5

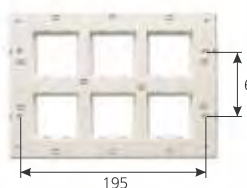

195

68

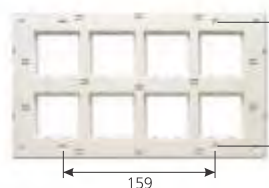

159

131

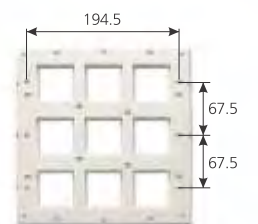

194.5

67.5

67.5



Cristallo Valentine Wine Plate with Curve Voltage Grey Emergency Light

Cristallo

With Curve Cristallo, you can create style statements that echo your true self. Choose the clear, transparent Memorio panels to showcase your memories from the past. Select the specially crafted Twixos panels with two-tone colours to lend a distinct verve to your interiors. Or opt for the Illumino panels that emit a soft, gentle glow that inspires as well as guides you in total darkness... Whichever your choice, the Cristallo range doesn't just allow you to express yourself more clearly, it sets trends for the rest to follow.

Cristallo Herbal Spa Plate with Curve Digital Chrome Switches



CRISTALLO COVER PLATES WITH MOUNTING FRAMES

PLATES →	1M	2M	3M	3M*	4M	6M	8M (H)	8M*	8M (V)	12M	16M	18M
COLOURS ↓	MRP ₹	MRP ₹	MRP ₹	MRP ₹	MRP ₹	MRP ₹	MRP ₹	MRP ₹	MRP ₹	MRP ₹	MRP ₹	MRP ₹
White Jazz	77.00	77.00	96.00	96.00	109.00	147.00	188.00	214.00	188.00	238.00	263.00	303.00
Memorio	177.00	177.00	213.00	213.00	257.00	329.00	447.00	447.00	447.00	492.00	591.00	674.00
Twixos/Metalik	152.00	152.00	196.00	196.00	226.00	278.00	336.00	336.00	336.00	410.00	457.00	524.00
Wood	179.00	179.00	232.00	232.00	271.00	319.00	394.00	394.00	394.00	480.00	533.00	597.00
CODE →	40101	40201	40301	43301	40401	40601	40801	42801	48801	41201	41601	41801
Outer/Master →	10/300	10/300	10/200	10/200	10/200	5/120	5/120	5/120	5/100	5/80	5/40	5/40
SIZE(mm) →	92x86	92x86	115x86	122x86	150x86	222x86	264x86	248x86	150x151	222x151	264x151	223x217

COVER PLATES

* Without Partition



1 - Module



2 - Module



3 - Module*



3 - Module



4 - Module



6 - Module



8 - Module (H)



8 - Module*



8 - Module (V)



12 - Module



16 - Module



18 - Module

CRISTALLO MOUNTING FRAME - Horizontal & Vertical Distance for Screwing (Dimensions in mm)

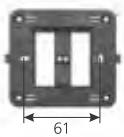

61

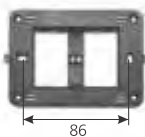

86

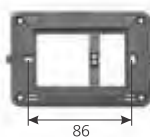

86

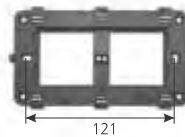

121

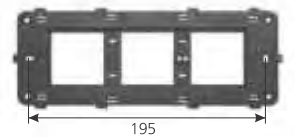

195

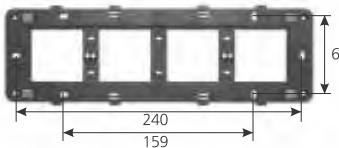

66

240

159

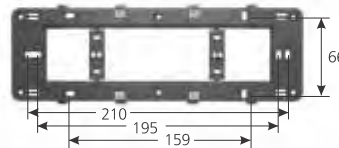

66

210

195

159

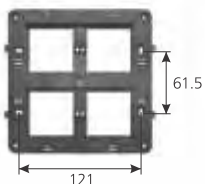

61.5

121

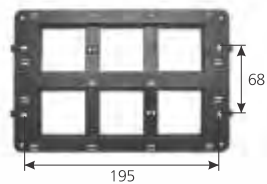

68

195

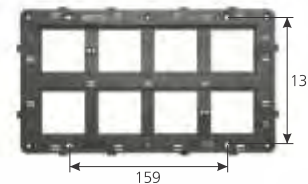

131

159

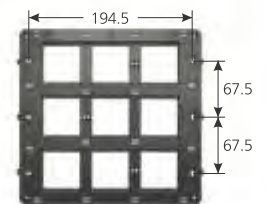

194.5

67.5

67.5



Crystallight Honey Mint Plate with Nixon Titanium Grey Gas Detector

QUORRA

The Crystallight cover frames are precisely crafted for that perfect finish – right from their delicately frosted facade to the exquisite chamfer around the edges. Like naturally occurring crystals, the Crystallight cover plate exhibits a rare brilliance that creates an aura of sophisticated elegance around it. Unmatched in their beauty and finish, these cover plates are without doubt, the definitive symbol of luxury on your walls.

Crystallight



Crystallight Grey Ghost Plate with Nixon Titanium Grey Switches



QUORRA BASIC COVER PLATES

PLATES →	1M	2M	3M	4M	4M*	6M	6M*	8M (H)*	8M	8M*	8M (V)	12M	18M
					(H&V)**		(H&V)**			(H&V)**			
COLOURS ↓	MRP ₹	MRP ₹	MRP ₹	MRP ₹	MRP ₹	MRP ₹	MRP ₹	MRP ₹	MRP ₹	MRP ₹	MRP ₹	MRP ₹	MRP ₹
Satin White	-	110.00	140.00	173.00	-	224.00	-	268.00	268.00	-	268.00	339.00	474.00
Metallic	-	182.00	202.00	237.00	-	285.00	-	344.00	344.00	-	344.00	475.00	582.00
Wood	-	213.00	237.00	296.00	-	344.00	-	427.00	427.00	-	427.00	582.00	772.00
Outer/Master →	-	10/400	10/300	10/300	-	5/150	-	5/150	5/150	-	5/150	5/120	5/80

QUORRA EXCLUSIVE COVER PLATES

Glass	-	366.00	528.00	701.00	-	988.00	-	1075.00	1075.00	-	1075.00	1297.00	1589.00
SIZE(mm) →	-	101x87	124x87	148x87	-	222x87	-	271x87	248x87	-	148x154	222x154	222x220

QUORRA PREMIUM COVER PLATES

Glass	470.00	470.00	665.00	876.00	963.00	1179.00	1298.00	-	1330.00	1461.00	1330.00	1574.00	1909.00
CODE →	50101	50201	53301	50401	50403	50601	50603	50801	52801	50803	58801	51201	51801
Outer/Master →	10/200	10/200	10/200	10/150	10/150	5/100	5/100		5/100	5/100	5/100	5/75	5/40
SIZE(mm) →	106x91	106x91	128x91	152x91	152x91	226x91	226x91	-	251x91	269x91	152x157	226x157	226x224

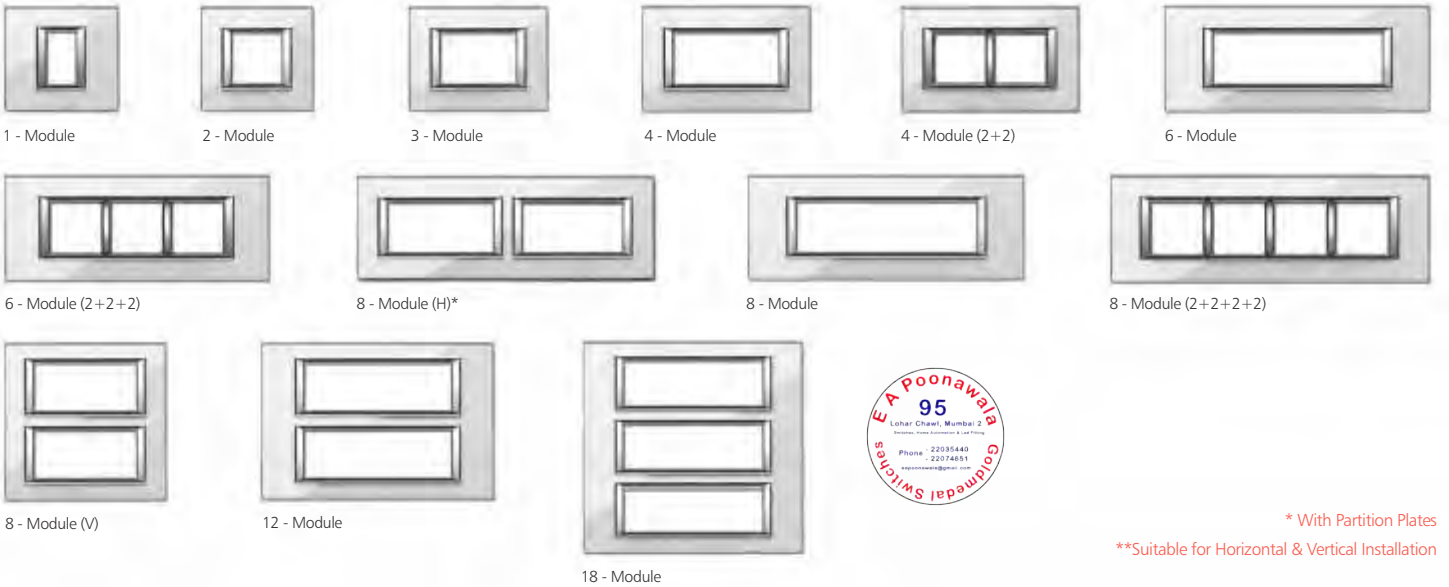

* With Partition Plates
**Suitable for Horizontal & Vertical Installation

QUORRA MOUNTING FRAME - Horizontal & Vertical Distance for Screwing (Dimensions in mm)

Quorra Frame →	2M	3M	4M	4M*	6M	6M*	8M (H)*	8M	8M	8M (V)	12M	18M
				(H&V)**		(H&V)**			(H&V)**			
MRP ₹ →	53.00	64.00	74.00	78.00	107.00	116.00	134.00	134.00	145.00	134.00	172.00	233.00
CODE →	50202	53302	50402	50404	50602	50604	50802	52802	50804	58802	51202	51802
Outer/Master →	25/750	25/750	25/500	25/500	20/240	20/240	20/240	20/240	20/240	20/240	20/160	10/80

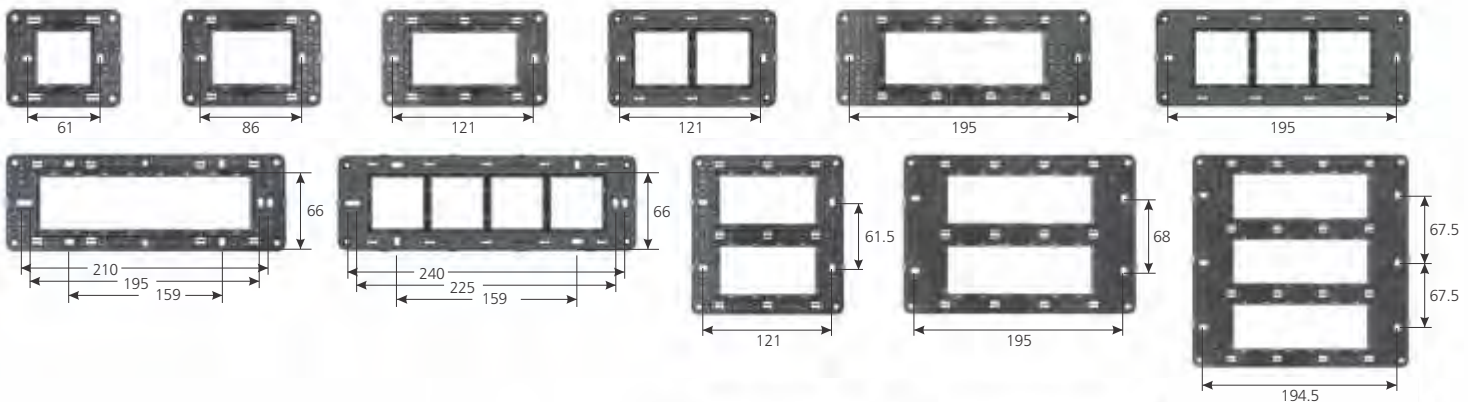



Xtreme Brushed Silver Plate with Nixon Digital Silver Step Marker

QUORRA

Fashioned from wood, glass, metal, chrome, stone and wool, the Quorra Xtreme cover frames are distinguished by their sleek chrome encasing. Visible from the sides as well as the front, the chrome border creates an aura of luxury and sophistication around the frames. While the Quorra Xtreme is superlative in every respect, the Quorra Xtreme is the epitome of flawless grandeur; diamond cut and polished to perfection. Painstakingly crafted, Quorra cover frames symbolizes the absolute pinnacle of luxurious living.

XTREME

Xtreme Brushed Silver Plate with 3M Bluetooth FM Player



QUORRA CRYSTALLIGHT / DIAMOND COVER PLATES

PLATES →	1M	2M	3M	4M	4M*	6M	6M*	8M	8M*	8M (V)	12M	18M
					(H&V)**		(H&V)**		(H&V)**			
COLOURS ↓	MRP ₹	MRP ₹	MRP ₹	MRP ₹	MRP ₹	MRP ₹	MRP ₹	MRP ₹	MRP ₹	MRP ₹	MRP ₹	MRP ₹
Glass (diamond cut)	530.00	530.00	747.00	984.00	1082.00	1406.00	1492.00	1579.00	1644.00	1579.00	1773.00	2174.00
Diamond (studded)	-	-	4619.00	-	-	-	-	-	-	-	-	-

QUORRA XTREME COVER PLATES

Wood	443.00	443.00	636.00	840.00	925.00	1193.00	1289.00	1366.00	1425.00	1366.00	1567.00	1919.00
Steel	534.00	534.00	761.00	1011.00	1112.00	1431.00	1550.00	1650.00	1710.00	1650.00	1874.00	2306.00
Aluminum	534.00	534.00	761.00	1011.00	1112.00	1431.00	1550.00	1650.00	1710.00	1650.00	1874.00	2306.00
CODE →	50101	50201	53301	50401	50403	50601	50603	52801	50803	58801	51201	51801
Outer/Master →	10/200	10/200	10/200	10/150	10/150	5/100	5/100	5/100	5/100	5/100	5/75	5/40
SIZE(mm) →	106x91	106x91	128x91	152x91	152x91	226x91	226x91	251x91	269x91	152x157	226x157	226x224



1 - Module



2 - Module



3 - Module



4 - Module



4 - Module (2+2)



6 - Module



6 - Module (2+2+2)



8 - Module



8 - Module (2+2+2+2)



8 - Module (V)



12 - Module



18 - Module



* With Partition Plates

**Suitable for Horizontal & Vertical Installation

QUORRA XTREME COVER PLATES



1 - Module



2 - Module



3 - Module



4 - Module



4 - Module (2+2)



6 - Module



6 - Module (2+2+2)



8 - Module



8 - Module (2+2+2+2)



8 - Module (V)



12 - Module



18 - Module





Grazia Basic Moughal Teak Plate with Nixon Digital Silver Switches

grazia

Grazia, the thinnest, most stylish cover frames you can imagine, are available in Basic and Premium options. Both Basic and Premium cover frames accentuate the style quotient of your rooms with their distinctively slender appearance. The Grazia Premium has an additional chrome side casing which highlights the delightful slimness of these cover frames. Choose from either of these options to make a style statement that will always be in.



Grazia Premium Italian Espresso Plate with Digital Silver Key Tag



GRAZIA BASIC COVER PLATES WITH MOUNTING FRAMES

PLATES →	1M	2M	3M	3M*	4M	4M*	6M	6M*	8M	8M*	8M	9M*	12M	12M*	12M*	16M	18M
						(H&V)**		(H&V)**		(H&V)**	(V)				(H&V)**		
COLOURS ↓	MRP ₹	MRP ₹	MRP ₹	MRP ₹	MRP ₹	MRP ₹	MRP ₹	MRP ₹	MRP ₹	MRP ₹	MRP ₹	MRP ₹	MRP ₹	MRP ₹	MRP ₹	MRP ₹	MRP ₹
Pure Glossy	85.00	85.00	105.00	105.00	130.00	130.00	185.00	185.00	232.00	232.00	232.00	249.00	266.00	266.00	266.00	295.00	337.00
Metallic	123.00	123.00	160.00	160.00	195.00	195.00	267.00	267.00	334.00	334.00	334.00	358.00	391.00	391.00	391.00	429.00	432.00
Wood	164.00	164.00	223.00	223.00	273.00	273.00	372.00	372.00	508.00	508.00	508.00	512.00	521.00	521.00	521.00	572.00	608.00

GRAZIA PREMIUM COVER PLATES WITH MOUNTING FRAMES

Pure Glossy	100.00	100.00	123.00	123.00	150.00	150.00	215.00	215.00	273.00	273.00	273.00	292.00	312.00	312.00	312.00	351.00	397.00
CODE →	60101	60201	60301	60303	60401	60404	60601	60604	60801	60804	68801	60901	61201	61204	61207	61601	61801
Outer/Master	10/400	10/400	10/300	10/300	10/300	10/300	5/150	5/150	5/150	5/150	5/150	5/150	5/120	5/120	5/120	5/90	5/80
SIZE(mm) →	101x93	101x93	124x93	124x93	148x93	154x93	221x93	226x93	247x93	280x93	148x159	280x93	222x160	226x160	226x160	246x159	222x226

* With Partition Plates

**Suitable for Horizontal & Vertical Installation

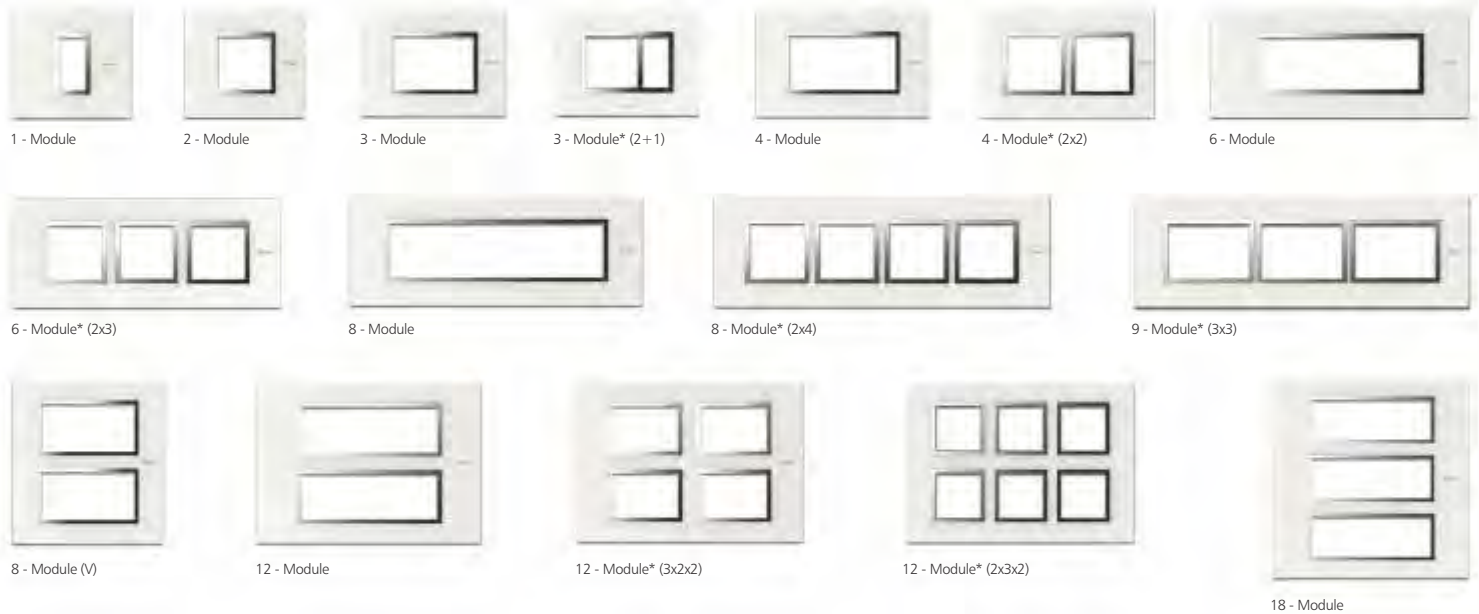

GRAZIA MOUNTING FRAMES - Horizontal & Vertical Distance for Screwing (Dimensions in mm)

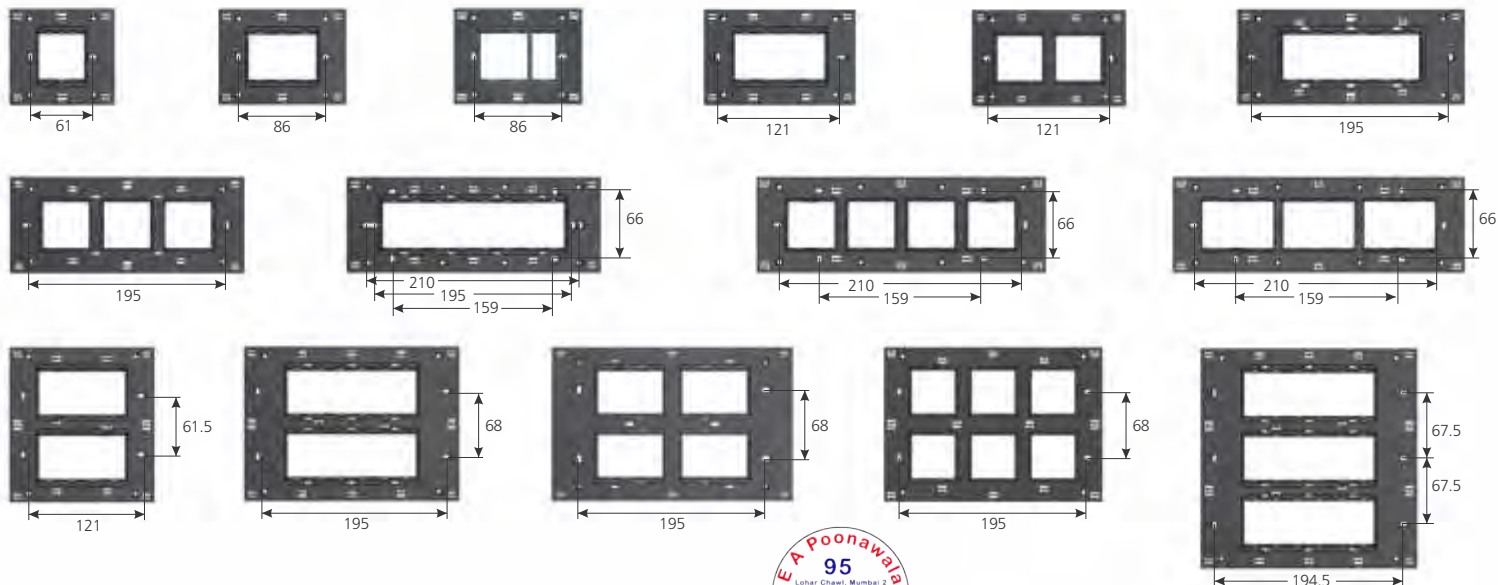



Classio Black Glossy Plate with Digital Silver I-touch Bellpush

GLASSIO

The Glassio is without doubt a classical beauty – exhibiting a smooth, glossy frontage, with soft, rounded edges and a demeanour that’s sophisticated yet warm and welcoming. The elegantly flared corners reflect and absorb light in a manner that adds depth and character to the cover plate. This interplay of light and shadow also creates a sinuous effect that makes Glassio the definitive artefact on your wall.



Classio Black Glossy Plate with Digital Silver RF I-touch Switches



GLASSIO COVER PLATES WITH MOUNTING FRAMES

PLATES →	1M	2M	3M	4M	4M*	6M	6M*	8M	8M*	8M	9M*	12M	12M*	16M*	18M
					(H&V)**		(H&V)**		(H&V)**	(V)			(H&V)**		
COLOURS ↓	MRP ₹	MRP ₹	MRP ₹	MRP ₹	MRP ₹	MRP ₹	MRP ₹	MRP ₹	MRP ₹	MRP ₹	MRP ₹	MRP ₹	MRP ₹	MRP ₹	MRP ₹
Pure Glossy	100.00	100.00	123.00	150.00	150.00	215.00	215.00	273.00	273.00	273.00	292.00	312.00	312.00	351.00	397.00
Metallic	135.00	135.00	176.00	215.00	215.00	294.00	294.00	368.00	368.00	368.00	396.00	431.00	431.00	485.00	518.00
Metal Krome	202.00	202.00	281.00	341.00	341.00	458.00	458.00	615.00	615.00	615.00	627.00	632.00	632.00	694.00	732.00
VelvetTouch	196.00	196.00	268.00	330.00	330.00	441.00	441.00	604.00	604.00	604.00	612.00	618.00	618.00	678.00	720.00
Wood	180.00	180.00	245.00	299.00	299.00	408.00	408.00	561.00	561.00	561.00	569.00	573.00	573.00	635.00	670.00
CODE →	120101	120201	120301	120401	120404	120601	120604	120801	120804	128801	120901	121201	121204	121601	121801
Outer/Master →	10/500	10/500	10/400	10/400	10/400	5/200	5/200	5/200	5/200	5/200	5/200	5/120	5/120	5/90	5/80
SIZE(mm) →	92x90	92x90	120x90	146x90	152x90	219x90	219x90	244x90	264x90	152x168	280x90	219x156	219x156	244x156	219x223

* With Partition Plates

**Suitable for Horizontal & Vertical Installation

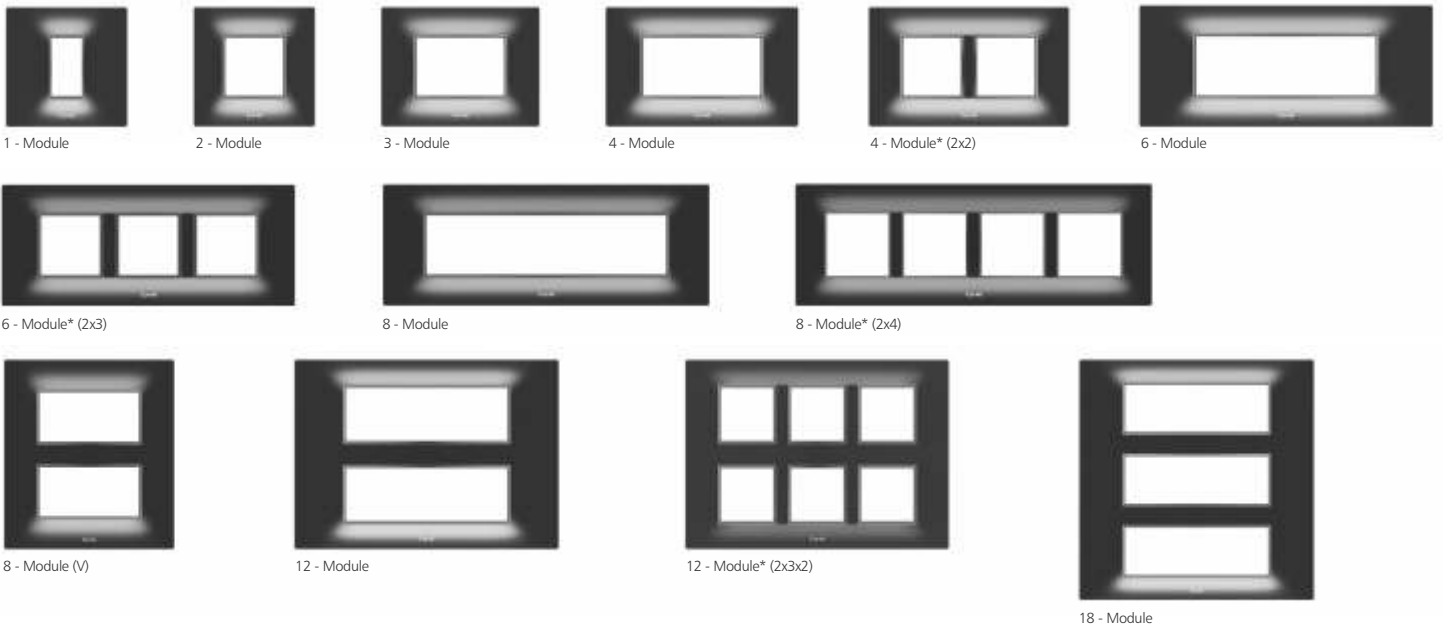

GLASSIO MOUNTING FRAMES - Horizontal & Vertical Distance for Screwing (Dimensions in mm)

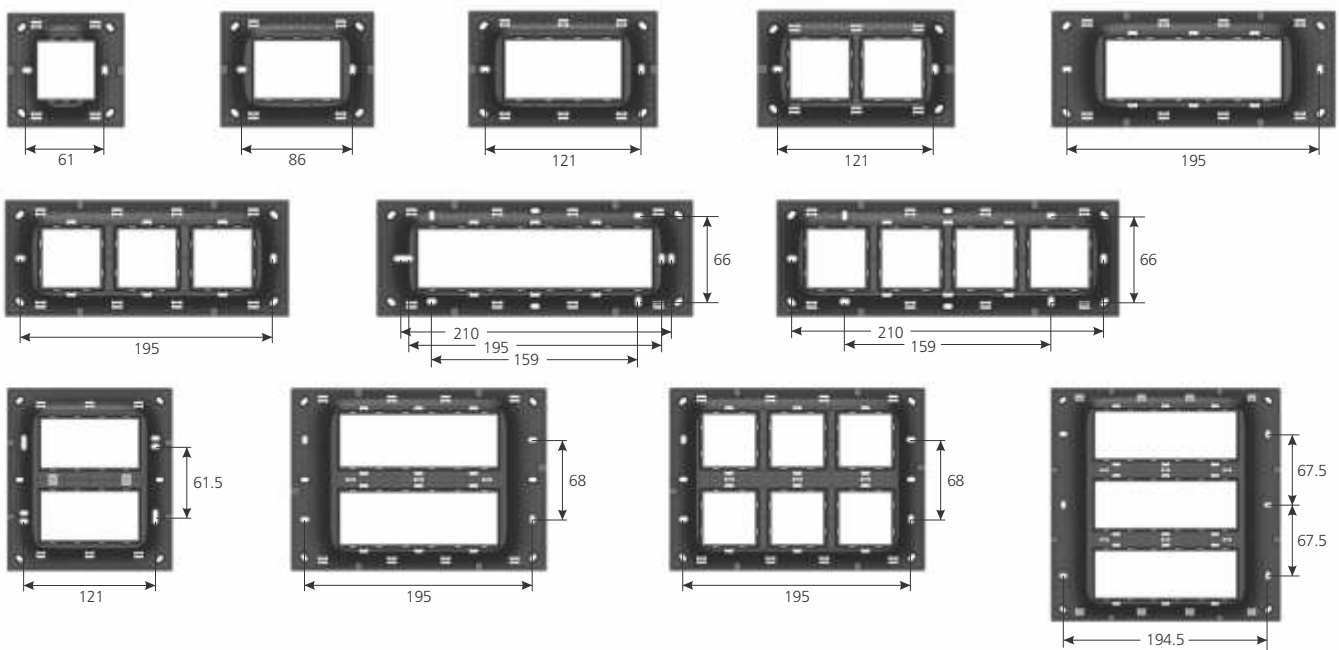



Wega Junglee Wenge Plate with Titanium Grey G-dip Switches

WEGA

Unconventional yet perfectly symmetrical, bold yet elegant - the Wega cover plates are stunning in every way. An example of imagination and engineering precision of the highest order, the Wega, with its distinctive appearance stands out from the clutter with ease. Its undulating shape creates a magical interplay of light that adds to its visual appeal. The colours appear dazzling, mesmerizing and even playful, depending on the prevailing light conditions.

Wega Dark Espresso Plate with Titanium Grey Step Marker



NEW

WEGA COVER PLATES WITH MOUNTING FRAMES

PLATES →	1M	2M	3M	4M	4M (H&V)**	6M	6M* (H&V)**	8M	8M* (H&V)**	8M (V)	12M	18M
COLOURS ↓	MRP ₹	MRP ₹	MRP ₹	MRP ₹	MRP ₹	MRP ₹	MRP ₹	MRP ₹	MRP ₹	MRP ₹	MRP ₹	MRP ₹
Pure Glossy	-	168.00	221.00	268.00	268.00	336.00	320.00	415.00	399.00	415.00	483.00	725.00
Metallic	-	252.00	294.00	357.00	357.00	410.00	394.00	504.00	488.00	504.00	683.00	872.00
VelvetTouch	-	347.00	399.00	483.00	483.00	567.00	551.00	719.00	704.00	719.00	945.00	1250.00
Wood	-	289.00	336.00	399.00	399.00	473.00	457.00	599.00	583.00	599.00	788.00	1040.00
CODE →	200101	200201	200301	200401	200403	200601	200603	200801	200803	208801	201201	201801
Outer/Master →	10/400	10/400	10/300	10/300	10/300	5/150	5/150	5/150	5/150	5/150	5/120	5/80
SIZE(mm) →	94x92	94x92	122x92	148x92	154x92	221x92	221x92	246x92	266x92	154x170	221x159	221x225

* With Partition Plates

**Suitable for Horizontal & Vertical Installation

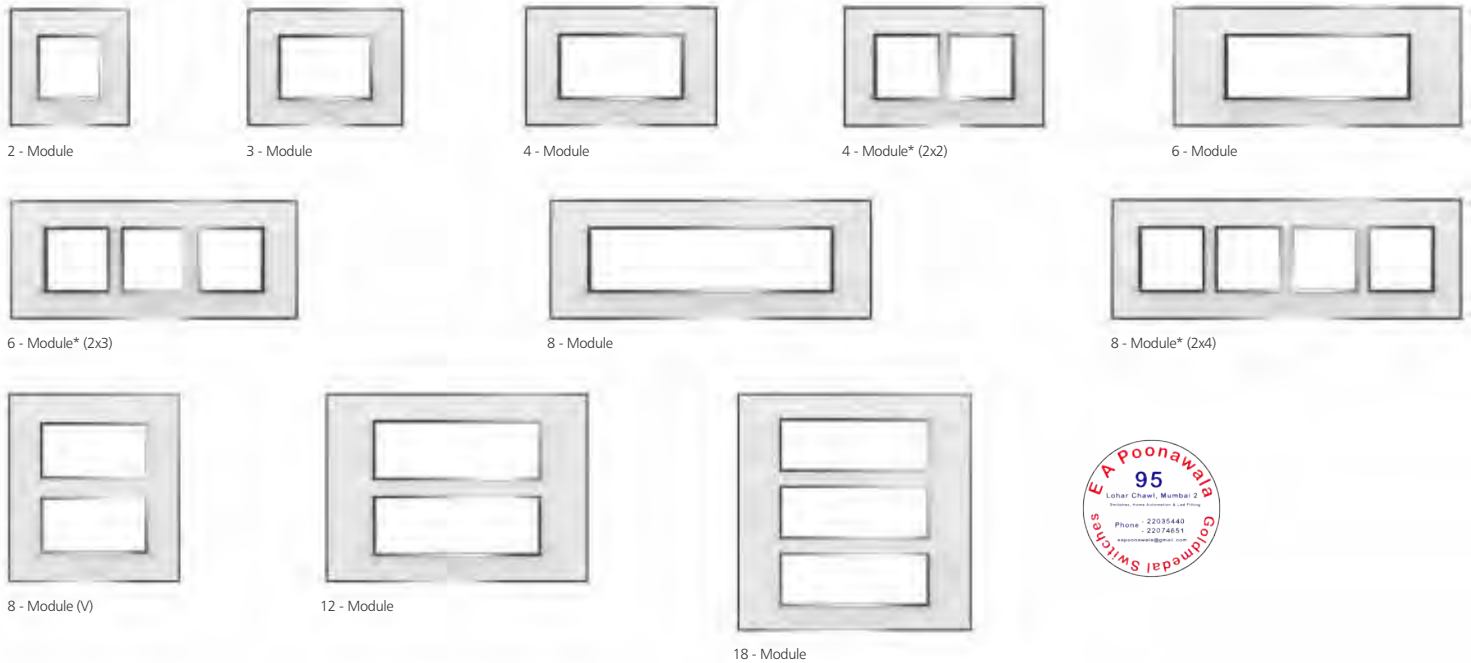

WEGA MOUNTING FRAMES - Horizontal & Vertical Distance for Screwing (Dimensions in mm)

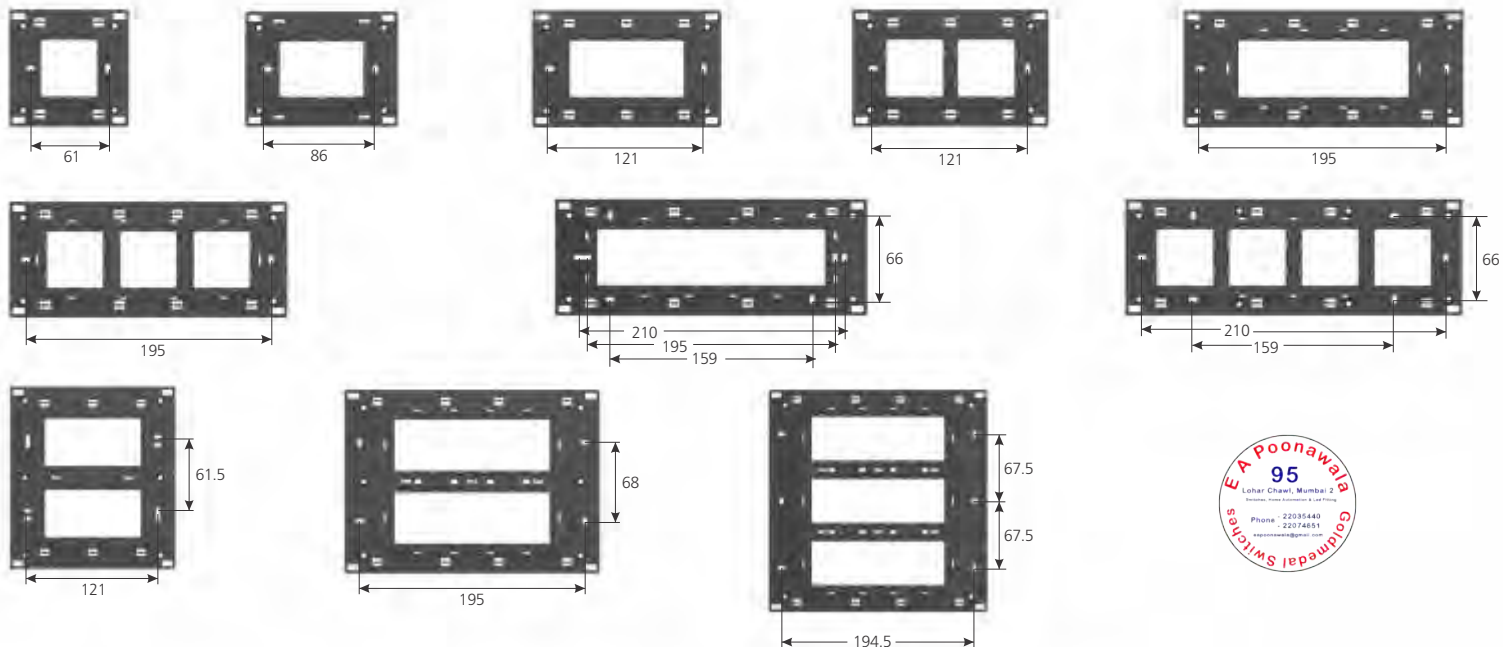



COLOURS OF COVER PLATES

PURE GLOSSY



01 - Absolute White

METALLIC



05 - Champagne Gold



06 - Titanium Silver



07 - Titanium Grey

WOOD



11 - Jungle Wenge



12 - Dark Espresso



Colours shown may not match actual product colours due to printing limitations.

COLOURS OF COVER PLATES

bella

WHITE JAZZ



01 - White Jazz

METALIK



06 - Spirit Gold



07 - Silver Streak



08 - Copper

BELLESOFT



09 - Digital Chrome



16 - Pepper Leaf



17 - Deep Currant



18 - Blu Caspian

ANTIK



21 - Voltage Grey



31 - Antik Copper



41 - African Wenge



44 - Burma Teak

BELLEWOOD

MEMORIO



01 - Memorio



Barbie

WHITE JAZZ



02 - White Jazz



Cristallo

TWIXOS



12 - Valentine Wine



13 - Herbal Spa



14 - Plum Island



15 - Ice Grey

Metalik



21 - Ocean Pearl



22 - Gold



23 - Silver

Wood



26 - Fumed Oak

COLOURS OF COVER PLATES

PURE GLOSSY



01- Absolute White



02 - Black Glossy



03- Ivory Gold

METALLIC



06- Gold Mist*



07 - Digital Silver*



08 - Digital Chrome*

METAL KROME



11- Hyper Chrome



12- Satin Chrome*



13- Miami Gold*



14- Copper Cola*



15- French Wine*



16- Toronto Red*



17- Charcoal Brown*



VELVET TOUCH



21- Apple Green*



22- Mexican Peach*



23- Cherry Red*



24- Black Grape*

WOOD



31- Black Walnut



32- Italian Espresso*



33 - Zebra Wood*



34- Moughal Teak



COLOURS OF COVER PLATES

PURE GLOSSY



01- Absolute White



02 - Black Glossy*

basic

METALLIC



06- Gold Mist*



07 - Digital Silver

WOOD



11- Wild Wenge*



12- Italian Expresso



13 - Zebra Wood



14 - Moughal Teak*

PURE GLOSSY



20- Absolute White



21 - Black Glossy*

premium





COLOURS OF COVER PLATES

GLASS



01 - Snow White



02 - Red Wine



03 - Green Ice



04 - Rich Black

EXCLUSIVE

CORIAN®



05 - Hot Red



11 - Glacier White



12 - Lava Grey



13 - Berry Red

BASIC



16 - Satin White

METALLIC



17 - Digital Silver

BASIC WOOD



18 - Fumed Oak

basic



GLASS



21 - Snow White



22 - Red Wine



23 - Green Ice



24 - Rich Black

premium



25 - Hot Red



Divinity



36 - Snow White*



37 - Hot Red*

Available only in 3 Module & 6 Module



COLOURS OF COVER PLATES

Crystallight

GLASS



41 - Mint Ice



42 - Honey Sapphire



43 - Black Diamond*



44 - Ruby Red*



45 - Magic Mirror



46 - Honey Mint



47 - Grey Ghost



PLUS



101 - Honey Dew



DIAMOND Crystal Studded



49 - Star Shine*



50 - Night Sky*

Available only in 3 Module

WOOD



56 - Wenge*



57 - Sycamore*



58 - Zebrano*

XTREME

STEEL



81 - Brushed Steel*



82 - Signature Steel*

ALUMINIUM



86 - Brushed Black



87 - Brushed Silver

FLUSH MOUNTING METAL GANG BOXES (GALVANIZED)

GANG BOX →	1 & 2M	3M	4M	6M	8M(H)	8M(V)	12M	16M	18M
MRP ₹ ↓	64.00	84.00	104.00	129.00	168.00	168.00	211.00	259.00	297.00
CODE	70201	70302	70403	70604	70805	78806	71207	71608	71809
Outer/Master	10/120	10/120	10/120	5/80	5/80	5/60	5/45	5/40	5/40
SIZE (WxHxL) mm	75x73x51	100x73x51	135x73x51	208x73x51	230x73x51	135x130x60	209x130x60	230x144x60	209x200x60

METAL GANG BOXES

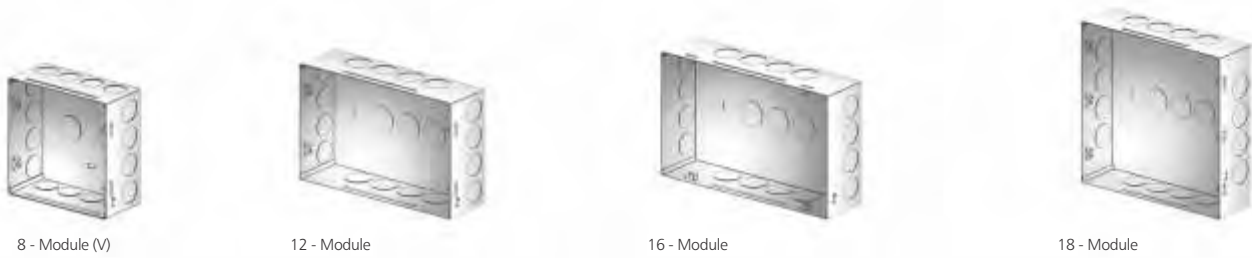
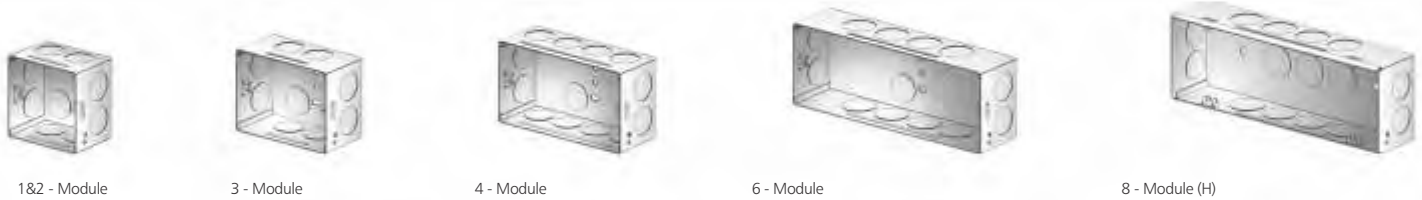

FLUSH MOUNTING PLASTIC GANG BOXES (FIRE RESISTANT)

GANG BOX →	1 & 2M	3M	4M	6M	8M(H)	8M(V)	12M	16M	18M
MRP ₹ ↓	58.00	67.00	80.00	105.00	121.00	121.00	168.00	197.00	239.00
CODE	80201	80302	80403	80604	80805	88806	81207	81608	81809
Outer/Master	10/120	10/120	10/120	5/80	5/80	5/60	5/45	5/40	5/40
SIZE (WxHxL) mm	79x82x50	104x82x50	139x82x50	213x82x50	263x86x55	141x142x55	213x143x55	249x150x55	214x211x58

PLASTIC GANG BOXES

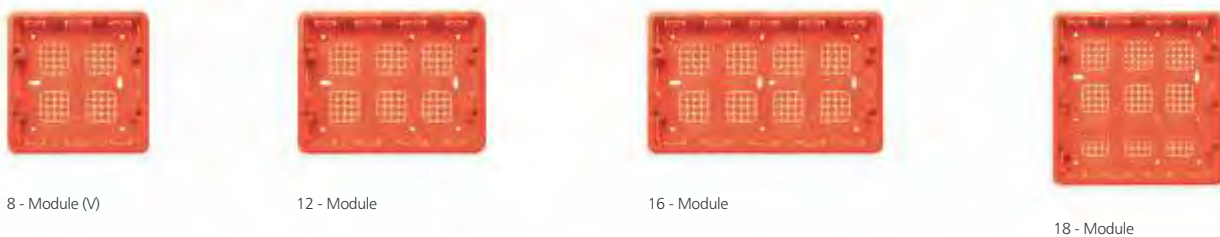
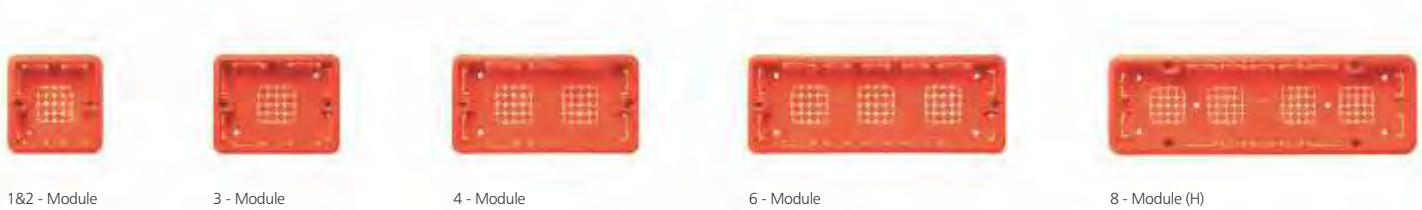

SURFACE MOUNTING PLASTIC GANG BOXES (FIRE RESISTANT)

GANG BOX →	1 & 2M	3M	3M	4M	6M	8M(H)	8M(V)	12M	16M	18M
MRP ₹ ↓	59.00	86.00	86.00	92.00	116.00	147.00	147.00	187.00	208.00	248.00
CODE	90201	90302	93303	90404	90605	90806	98807	91208	91609	91810
Outer/Master	10/120	10/120	10/120	10/120	5/80	5/80	5/60	5/45	5/40	5/40
SIZE (WxHxL) mm	92x85x48	124x85x48	118x85x48	150x85x48	218x85x48	267x85x48	153x154x48	219x154x48	267x154x48	224x227x48

PLASTIC SURFACE GANG BOXES

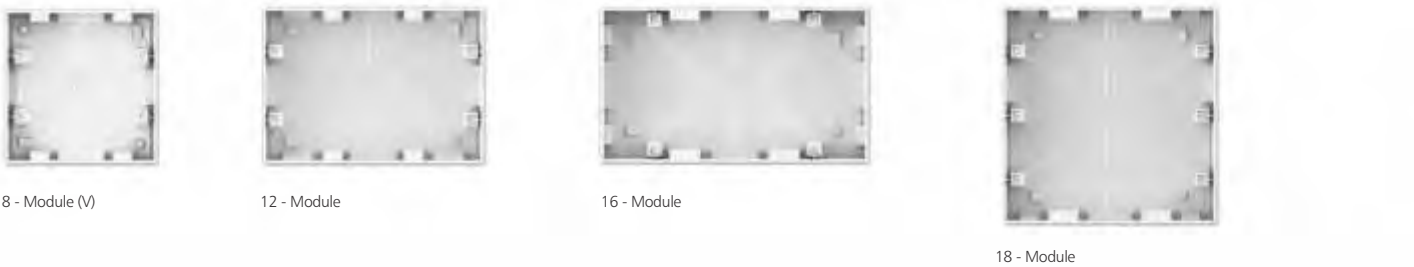

G- SURFACE MOUNTING PLASTIC GANG BOXES (FIRE RESISTANT) Suitable for Grazia & Glassio

GANG BOX →	1 & 2M	3M	4M	4M (HV)	6M	8M(H)	8M(HV)	8M (V)	9M	12M	16M	18M
MRP ₹ ↓	64.00	97.00	107.00	107.00	136.00	177.00	177.00	177.00	200.00	218.00	253.00	295.00
CODE	100201	100302	100403	100404	100605	100806	100807	108808	100909	101212	101611	101812
Outer/Master	10/120	10/120	10/120	10/120	5/80	5/80	5/80	5/60	5/80	5/45	5/40	5/40
SIZE (WxHxL) mm	91x89x48	119x89x48	145x89x48	150x89x48	218x89x48	243x89x48	263x89x48	154x155x48	279x89x48	218x155x48	243x155x48	218x222x48

PLASTIC SURFACE GANG BOXES

Note: Not suitable for Grazia 8M (V) Plate





FLAT REDEFINED

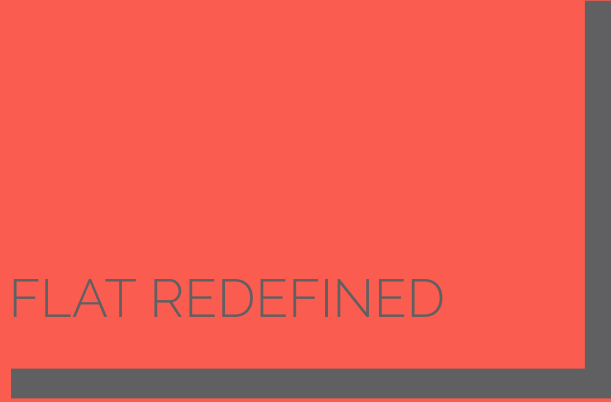

MODULAR COVERFRAMES



■ Air A3 Modular Plate with Aero Switches

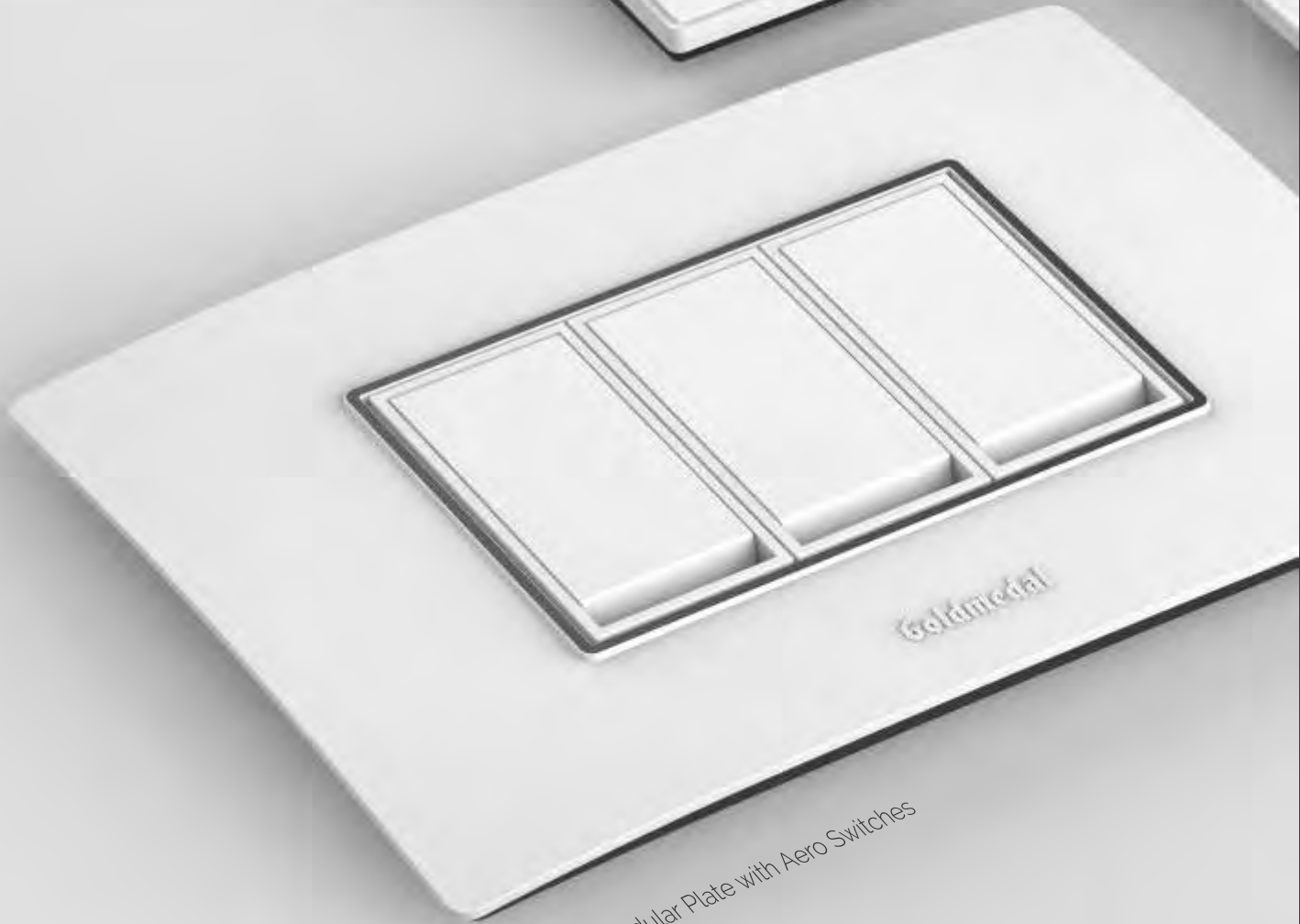

■ Air A5 Modular Plate with Aero Switches



Air-A7 Modular Plate with Aero Switches

Air



Flat. Flawless. Flamboyant.

Artio

The Artio is a delightfully simple and minimalistic expression of the Air range. Embodying reductionism and refinement, which are hallmarks of a sleek, modern and urbane lifestyle, the Artio is truly contemporary in every sense.



Artio
Delightfully simple
minimalistic and flat -
at OFF position

Aero

The Aero redefines flat switches. Styled to remain absolutely flush with the cover plate, the Aero emphasizes the minimalistic design of the Air range. Manufactured using the very best in raw materials and processes, the Aero is both functionally and aesthetically a class apart!



Aero
Completely flat -
at OFF position



Arc

The Arc switches by Air symbolizes minimalistic elegance. Easy on the eye as well as a pleasure to use, the Arc can be the perfect accessory in stylish homes with graceful settings. Crafted to perfection using the very best in technology and materials, the Arc adds a new dimension to your interiors.

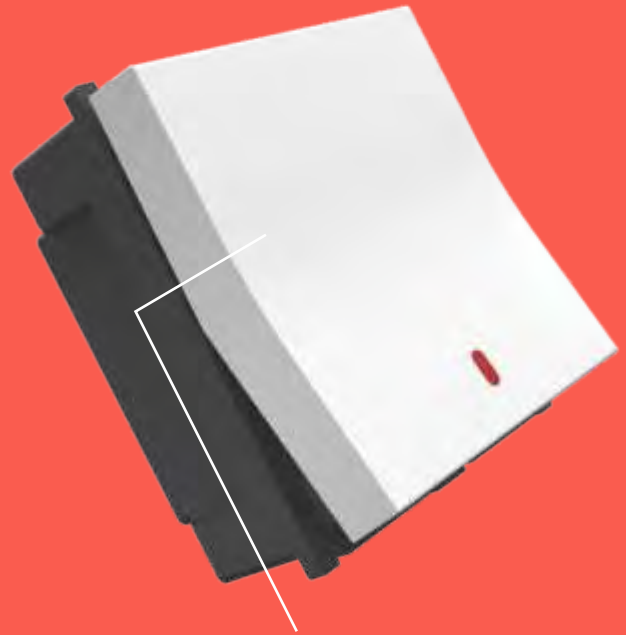

Arc
Add a new dimension to your interiors

Aura

The Aura has a forceful presence that commands attention. With its perfect, crisp lines and distinct shape, the Aura highlights the precision and style that defines the Air range. The Aura is the perfect choice for interiors that are practical yet modern.

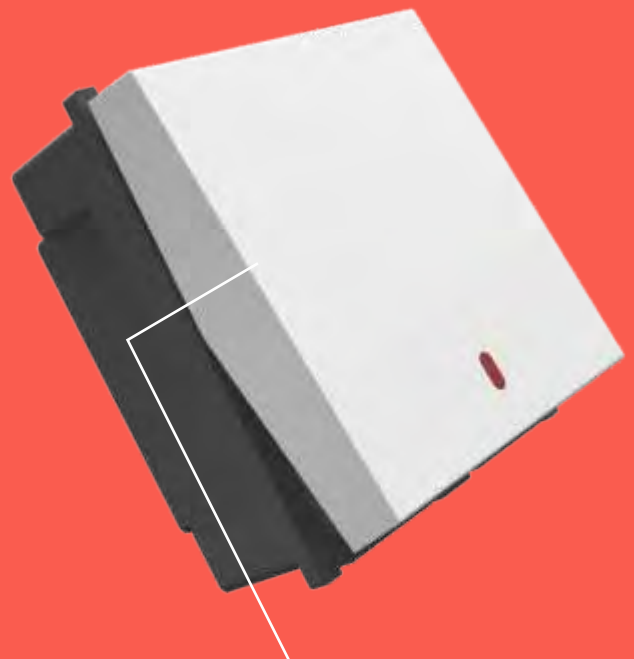

Aura
Perfect crisp lines that define the Air range

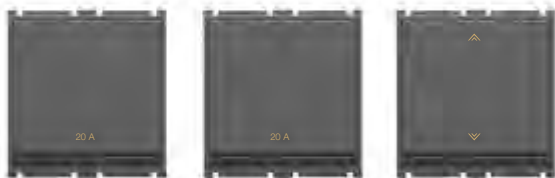

Code	Item	MRP ₹		Pkg.
		Absolute White	Digital Silver Titanium Grey	

AERO 10AX SWITCHES 240V~ (1 Module)

181001	10X 1 Way Switch	60.00	-	20/600
181002	10X 1 Way Switch with Ind. (LED)	97.00	-	20/600
181003	10X 2 Way Switch	97.00	-	20/600
181004	10X Bell Push Switch	109.00	-	20/600
181005	10X Bell Push Switch with Ind. (LED)	123.00	-	20/600

AERO 10AX SWITCHES 240V~ (2 Module)

182010	10X 1 Way Switch	119.00	-	10/300
182011	10X 1 Way Switch with Ind. (LED)	149.00	-	10/300
182012	10X 2 Way Switch	149.00	-	10/300
182014	10X Bell Push Switch with Ind. (LED)	162.00	-	10/300

AERO 20 / 25AMP SWITCHES 240V~ (1 Module)

181020	20A 1 Way Switch	125.00	-	20/600
181021	20A 1 Way Switch with Ind. (LED)	153.00	-	20/600
181022	20A 2 Way Switch	153.00	-	20/600
181023	25A 1 Way Switch	167.00	-	20/600

AERO 20AMP SWITCHES 240V~ (2 Module)

182025	20A 1 Way Switch	161.00	-	10/300
182026	20A 1 Way Switch with Ind. (LED)	183.00	-	10/300
182027	20A 2 Way Switch	193.00	-	10/300

AERO 32AMP DP SWITCH 240V~ (2 Module)

182031	32A DP Switch with Indicator (LED)	285.00	-	10/300
--------	------------------------------------	--------	---	--------



Code	Item	MRP ₹		Pkg.
		Absolute White	Digital Silver Titanium Grey	

ARC 10AX SWITCHES 240V~ (1 Module)

181401	10X 1 Way Switch	55.00	64.00	20/600
181402	10X 1 Way Switch with Ind. (LED)	90.00	106.00	20/600
181403	10X 2 Way Switch	90.00	106.00	20/600
181404	10X Bell Push Switch	99.00	117.00	20/600
181405	10X Bell Push Switch with Ind. (LED)	111.00	131.00	20/600

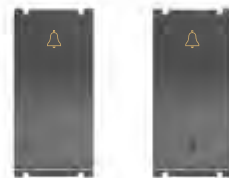

ARC 10AX SWITCHES 240V~ (2 Module)

182410	10X 1 Way Switch	107.00	126.00	10/300
182411	10X 1 Way Switch with Ind. (LED)	132.00	156.00	10/300
182412	10X 2 Way Switch	132.00	156.00	10/300
182414	10X Bell Push Switch with Ind. (LED)	141.00	167.00	10/300

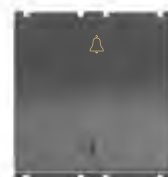

ARC 20 / 25AMP SWITCHES 240V~ (1 Module)

181420	20A 1 Way Switch	111.00	131.00	20/600
181421	20A 1 Way Switch with Ind. (LED)	144.00	170.00	20/600
181422	20A 2 Way Switch	144.00	170.00	20/600
181423	25A 1 Way Switch	158.00	186.00	20/600



ARC 20AMP SWITCHES 240V~ (2 Module)

182425	20A 1 Way Switch	140.00	165.00	10/300
182426	20A 1 Way Switch with Ind. (LED)	161.00	190.00	10/300
182427	20A 2 Way Switch	170.00	200.00	10/300



ARC 32AMP DP SWITCH 240V~ (2 Module)

182431	32A DP Switch with Indicator (LED)	258.00	304.00	10/300
--------	------------------------------------	--------	--------	--------



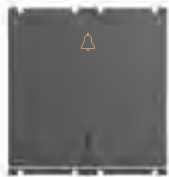

Code	Item	MRP ₹		Pkg.
		Absolute White	Digital Silver Titanium Grey	
AURA 10AX SWITCHES 240V~ (1 Module)				
181501	10X 1 Way Switch	55.00	64.00	20/600
181502	10X 1 Way Switch with Ind. (LED)	90.00	106.00	20/600
181503	10X 2 Way Switch	90.00	106.00	20/600
181504	10X Bell Push Switch	99.00	117.00	20/600
181505	10X Bell Push Switch with Ind. (LED)	111.00	131.00	20/600
AURA 10AX SWITCHES 240V~ (2 Module)				
182510	10X 1 Way Switch	107.00	126.00	10/300
182511	10X 1 Way Switch with Ind. (LED)	132.00	156.00	10/300
182512	10X 2 Way Switch	132.00	156.00	10/300
182514	10X Bell Push Switch with Ind. (LED)	141.00	167.00	10/300
AURA 20 / 25AMP SWITCHES 240V~ (1 Module)				
181520	20A 1 Way Switch	111.00	131.00	20/600
181521	20A 1 Way Switch with Ind. (LED)	144.00	170.00	20/600
181522	20A 2 Way Switch	144.00	170.00	20/600
181523	25A 1 Way Switch	158.00	183.00	20/600
AURA 20AMP SWITCHES 240V~ (2 Module)				
182525	20A 1 Way Switch	140.00	165.00	10/300
182526	20A 1 Way Switch with Ind. (LED)	161.00	190.00	10/300
182527	20A 2 Way Switch	170.00	200.00	10/300
AURA 32AMP DP SWITCH 240V~ (2 Module)				
182531	32A DP Switch with Indicator (LED)	258.00	304.00	10/300



Code	Item	MRP ₹		Pkg.
		Absolute White	Digital Silver Titanium Grey	

6AMP / 13AMP SOCKETS 240V~

181035	6A 2 Pin Socket (1M) with safety shutter	81.00	96.00	20/600
182037	6A 2x1 Socket (2M) with safety shutter	97.00	114.00	10/450
182039	10A International Socket (2M) with safety shutter	163.00	193.00	10/450
182040	6A Universal Socket (2M) with mobile socket & safety shutter	112.00	133.00	10/450

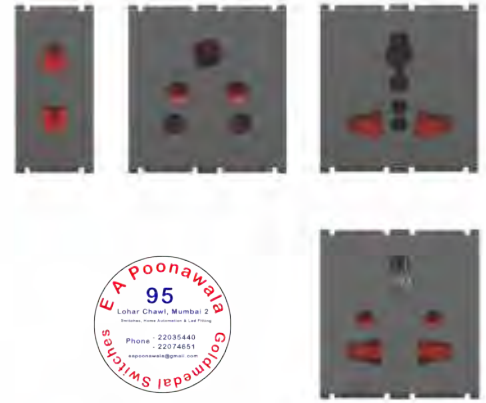

6&16AMP / 6&25AMP SOCKETS 240V~ (2 Module)

182041	6&16A Universal Socket with safety shutter	180.00	212.00	10/450
182042	6&25A Universal Socket with safety shutter	198.00	234.00	10/450
182043	6&16A Universal Raised Socket with safety shutter	180.00	212.00	10/450
182044	6&16A Universal Socket with flap, indicator & safety shutter	259.00	306.00	10/450

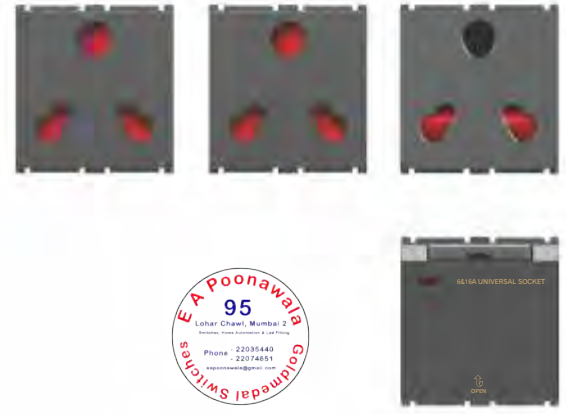

DIMMER / FAN REGULATOR 240V~ (1 Module)

181045	Dimmer - 450W	239.00	282.00	20/600
181051	4 Step Regulator (Regulator Supplied in ISI & Non ISI)	332.00	391.00	20/600

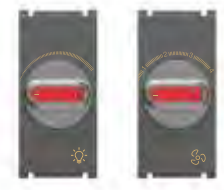

FULL ROTARY FAN REGULATOR 240V~ (2 Module)

182052	Tri-Star 5 Step Regulator NEW	394.00	465.00	10/300
182053	Orion 5 Step Regulator NEW	394.00	465.00	10/300
182054	5 Step Regulator (Regulator Supplied in ISI & Non ISI)	394.00	465.00	10/300

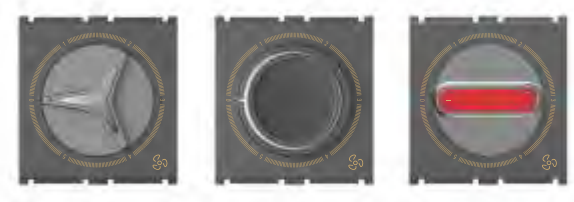

MOTOR STARTER (SP) 240V~ 50-60Hz (2 Module)

182057	16A Motor Starter Switch	501.00	591.00	10/300
182058	20A Motor Starter Switch	501.00	591.00	10/300
182059	25A Motor Starter Switch	501.00	591.00	10/300





Code	Item	MRP ₹		Pkg.
		Absolute White	Digital Silver Titanium Grey	
TV SOCKET / RJ-11 TELEPHONE JACKS / EDP SOCKET (1 Module)				
181062	TV Socket Coaxial 40-862 Mhz Socket	105.00	123.00	20/900
181068	Telephone Jack - RJ 11	106.00	125.00	20/600
181074	EDP Socket Outlet - RJ 45 (Cat 6e) Category 6e, Universal wiring T568A, insulating-piercing terminal	513.00	606.00	20/600

SINGLE POLE MCB 240/450V~ (1 Module)				
181077	C6 SP MCB	286.00	338.00	20/600
181078	C10 SP MCB	286.00	338.00	20/600
181079	C16 SP MCB	286.00	338.00	20/600
181080	C20 SP MCB	286.00	338.00	20/600
181081	C25 SP MCB	286.00	338.00	20/600
181082	C32 SP MCB	286.00	338.00	20/600
240/450V~ 50-60Hz 3kA Breaking Capacity				

DOUBLE POLE MCB 240/450V~ (2 Module)				
182083	C6 DP MCB	591.00	697.00	10/300
182084	C10 DP MCB	591.00	697.00	10/300
182085	C16 DP MCB	591.00	697.00	10/300
182086	C20 DP MCB	591.00	697.00	10/300
182087	C25 DP MCB	591.00	697.00	10/300
182088	C32 DP MCB	591.00	697.00	10/300
240/450V~ 50-60Hz 3kA Breaking Capacity				

INDICATOR / FUSE UNIT / BLANK MODULE (1 Module)				
181093	Indicator with LED & Red Diffuser	89.00	105.00	20/600
181094	Indicator with LED & Red Diffuser	89.00	105.00	20/600
181098	Fuse Carrier (10Amp/16Amp) with miniature fuse dia 6.3x28	125.00	148.00	20/600
181125	Blank Module	27.00	30.00	50/2000

STEP MARKER 240V~				
182105	Step Marker (2M) Supply voltage 240V~ 50-60Hz with high-efficiency 5x0.2W LED	464.00	548.00	10/300
183106*	Step Marker (3M) Supply voltage 240V~ 50-60Hz with high-efficiency 3x0.5W LED	NEW 556.00	657.00	5/100

* introducing shortly

Code	Item	MRP ₹		Pkg.
		Absolute White	Digital Silver Titanium Grey	

ELECTRONIC BELL 240V~ (2 Module)

182139	Electronic Bell 240V~50-60Hz	315.00	348.00	10/300
--------	---------------------------------	--------	--------	--------

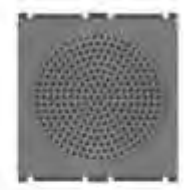

32A MAIN SWITCH (2 Module)

182163	32A DP Operated by Key Tag 240V~, LED Supplied with Key Tag	396.00	468.00	10/300
182164	Only Key Tag with Name Plate	93.00	109.00	100/2000



DND/MAKE MY ROOM (2 Module)

182168	Do Not Disturb/Make My Room 240V~ 50-60Hz - Inside Room	387.00	456.00	10/300
182169	Do Not Disturb/Make My Room 240V~ 50-60Hz - Outside Room	413.00	487.00	10/300



USB CHARGER 240V~

181172	USB Charger (1M) Supply voltage 160-240V~ 50-60Hz Output - 5V DC, 1A (Total)	865.00	953.00	10/300
182173	USB Charger with 2 USB ports (2M) Supply voltage 160-240V~ 50-60Hz Output - 5V DC, 2A (Total)	1020.00	1123.00	10/300



STEP MARKER 240V~ (4 Module)

184107	Footlight Supply voltage 240V~ 50-60Hz with high-efficiency 5x0.2W LED	683.00	749.00	5/120
--------	--	--------	--------	-------



Air



Artio

The Artio is a delightfully simple and minimalistic expression of the Air range. Embodying reductionism and refinement, which are hallmarks of a sleek, modern, and urbane lifestyle, the Artio makes a contemporary statement in every sense. Embedded within a square frame, the Artio switches can be installed as a single switch or as a combination of multiple switches to form a complete circle. The elegance, harmony and compositional unity that Artio represents gives it a truly timeless appeal.

NEW ARRIVAL
SWITCHES



Code	Item	MRP ₹		Pkg.
		Absolute White	Digital Silver Titanium Grey	

ARTIO 10AX SWITCHES 240V~ (2 Module)

NEW

182301*	10X 1 Way Switch (2 Switch)	108.00	127.00	10/300
182303*	10X 2 Way Switch (2 Switch)	175.00	206.00	10/300
182306*	10X 1 Way Switch (3 Switch)	145.00	171.00	10/300



ARTIO 10AX SWITCHES 240V~ (2 Module)

NEW

182310*	10X 1 Way Switch (1 Switch)	98.00	115.00	10/300
182312*	10X 2 Way Switch (1 Switch)	154.00	181.00	10/300
182313*	10X Bell Push Switch (1 Switch)	126.00	149.00	10/300



ARTIO 20AMP SWITCHES 240V~ (2 Module)

NEW

182320*	20A 1 Way Switch (2 Switch)	190.00	224.00	10/300
182321*	20A 1 Way Switch with Indicator -LED (2 Switch)	240.00	283.00	10/300



ARTIO 20AMP SWITCHES 240V~ (2 Module)

NEW

182325*	20A 1 Way Switch (1 Switch)	165.00	195.00	10/300
182326*	20A 1 Way Switch with Indicator - LED (1 Switch)	195.00	230.00	10/300



ARTIO 32AMP DP SWITCH 240V~ (2 Module)

NEW

182331*	32A DP Switch with Indicator (LED)	310.00	366.00	10/300
---------	------------------------------------	--------	--------	--------



* introducing shortly

Air



Air A3 Absolute White Plate with Titanium Grey Aero Switch, Orion Regulator

A3

If you thought practical was dull and boring then you've been looking at the wrong designs. The A3 cover plates will surprise you with their unique combination of practical utility and premium look. Super slim, flat, yet extremely durable, the A3 modular cover plates can easily be the first choice for modern interiors. The distinctive chrome border raises the style quotient of these plates to a higher level! So say yes to practical style that's never boring!

Air A3 Absolute White Plate with Titanium Grey Aero Switch, Tri-Star Regulator



A3 COVER PLATES WITH MOUNTING FRAMES

PLATES →	1M	2M	3M	3M*	4M	4M*	6M	6M*	8M	8M*	8M*	12M*	16M	18M	18M*
COLOURS ↓	MRP ₹	MRP ₹	MRP ₹	MRP ₹	MRP ₹	MRP ₹	MRP ₹	MRP ₹	MRP ₹	MRP ₹	MRP ₹	MRP ₹	MRP ₹	MRP ₹	MRP ₹
Pure Glossy	72.00	7200	96.00	96.00	120.00	120.00	179.00	163.00	247.00	224.00	224.00	256.00	280.00	362.00	328.00
CODE →	180101	180201	180301	180303	180401	180403	180601	180603	180801	180803	188803	181203	181601	181801	181803
Outer/Master →	10/500	10/500	10/400	10/400	10/400	10/400	5/200	5/200	5/200	5/200	5/200	5/120	5/90	5/80	5/80
SIZE(mm) →	98x91	98x91	121x91	121x91	152x91	152x91	220x91	220x91	245x91	245x91	152x168	220x157	245x157	220x222	220x222

* With Partition Plates

**Suitable for Horizontal & Vertical Installation

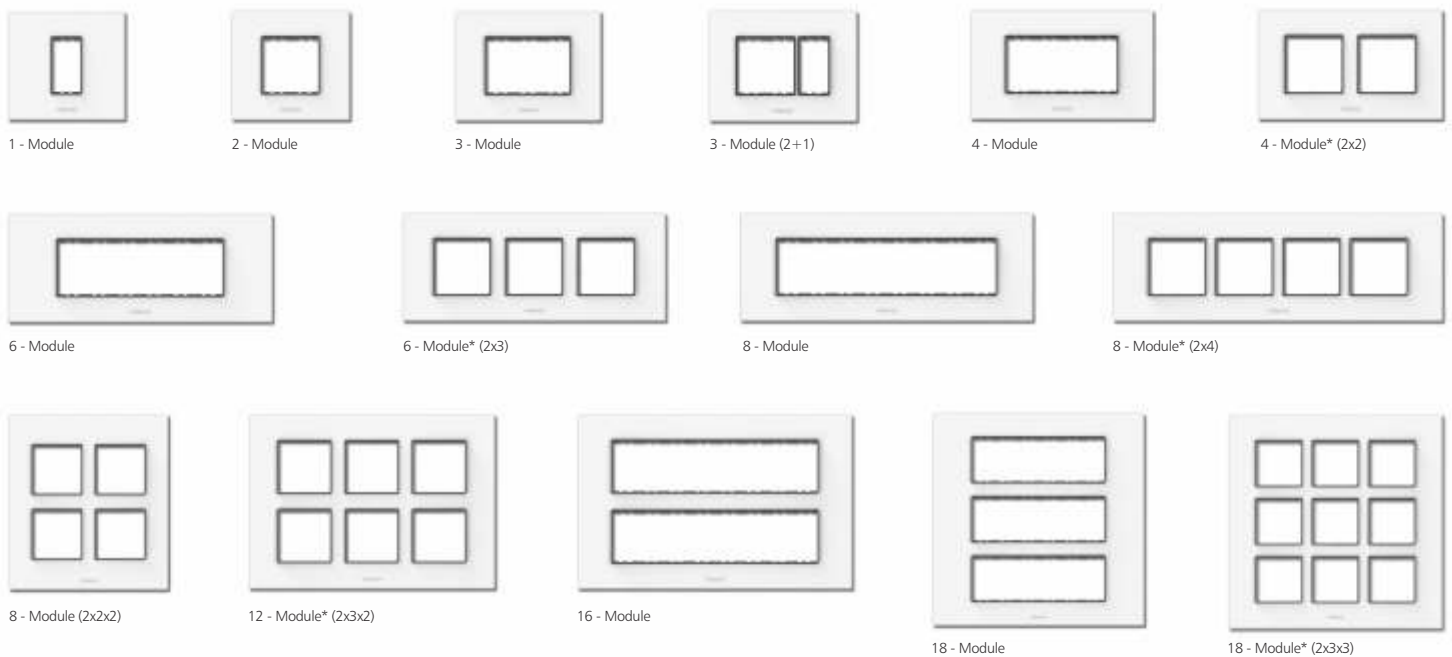

A3 MOUNTING FRAMES - Horizontal & Vertical Distance for Screwing (Dimensions in mm)

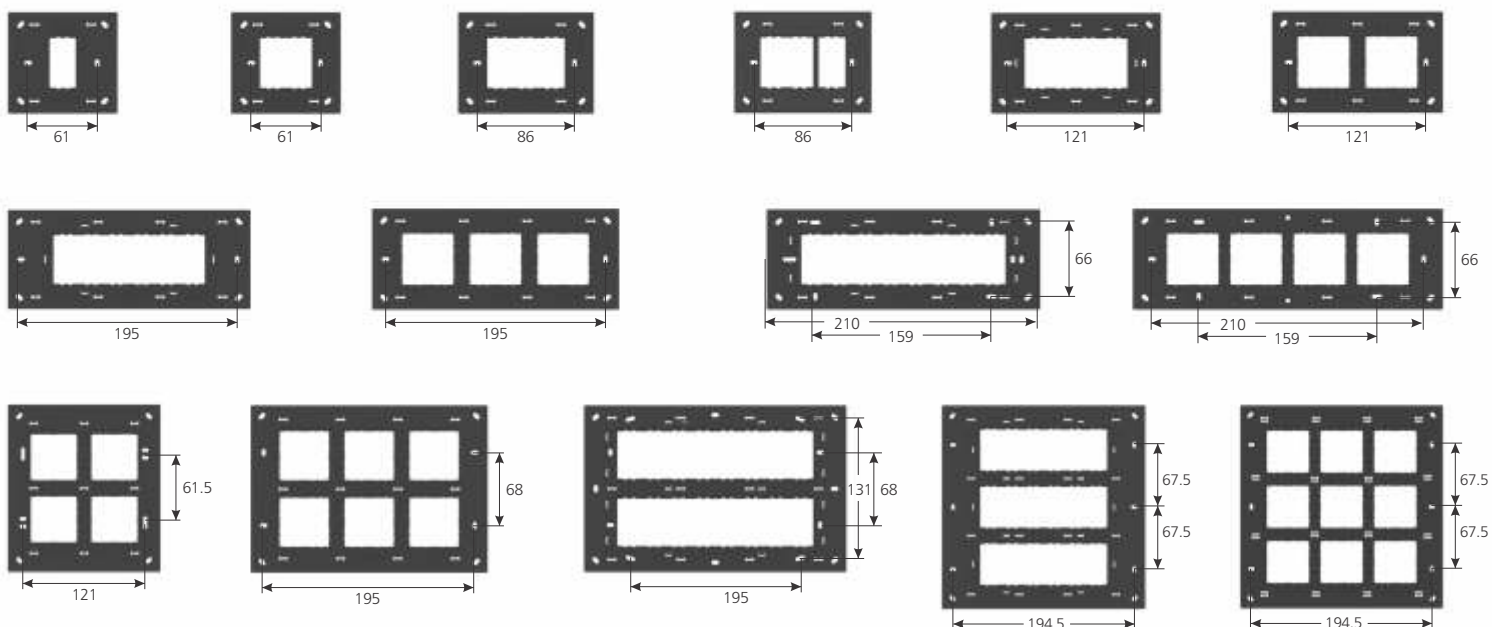

Air



Air A5 White Jazz Plate With Aero Titanium Grey Switches

A5

The new A5 cover plate is a mix of playful elegance and contemporary styling. Gently curved with rounded corners and a sleek chrome border around the inner frame, the A5 is a refreshingly clean and modern design with a dash of added fun. Like other AIR cover plates, the A5 is restrained in a quiet, refined manner without being dull and boring. Introduce A5 to your interiors to exhibit that rare combination of elegance and charming playfulness!

Air A5 Absolute White Plate With Titanium Grey Arc Switch, Regulator



A5 BASIC COVER PLATES WITH MOUNTING FRAMES NEW

PLATES →	1M	2M	3M	4M	4M*	6M	6M*	8M	8M*	8M*	12M*	16M	18M	18M*
					(H&V)**		(H&V)**		(H&V)**	(V)**	(H&V)**			(H&V)**
COLOURS ↓	MRP ₹	MRP ₹	MRP ₹	MRP ₹	MRP ₹	MRP ₹	MRP ₹	MRP ₹	MRP ₹	MRP ₹	MRP ₹	MRP ₹	MRP ₹	MRP ₹
Pure Glossy	63.00	63.00	84.00	105.00	105.00	158.00	142.00	215.00	194.00	194.00	221.00	263.00	315.00	284.00

A5 PREMIUM COVER PLATES WITH MOUNTING FRAMES

Pure Glossy	67.00	67.00	89.00	111.00	111.00	166.00	152.00	230.00	208.00	208.00	236.00	278.00	336.00	305.00
CODE →	220101	220201	220301	220401	220403	220601	220603	220801	220803	228803	221203	221601	221801	221803
Outer/Master →	10/500	10/500	10/400	10/400	10/400	5/200	5/200	5/200	5/200	5/200	5/120	5/90	5/80	5/80
SIZE(mm) →	98x91	98x91	121x91	152x91	152x91	220x91	220x91	245x91	245x91	152x168	220x157	245x157	220x222	220x222

* With Partition Plates

**Suitable for Horizontal & Vertical Installation

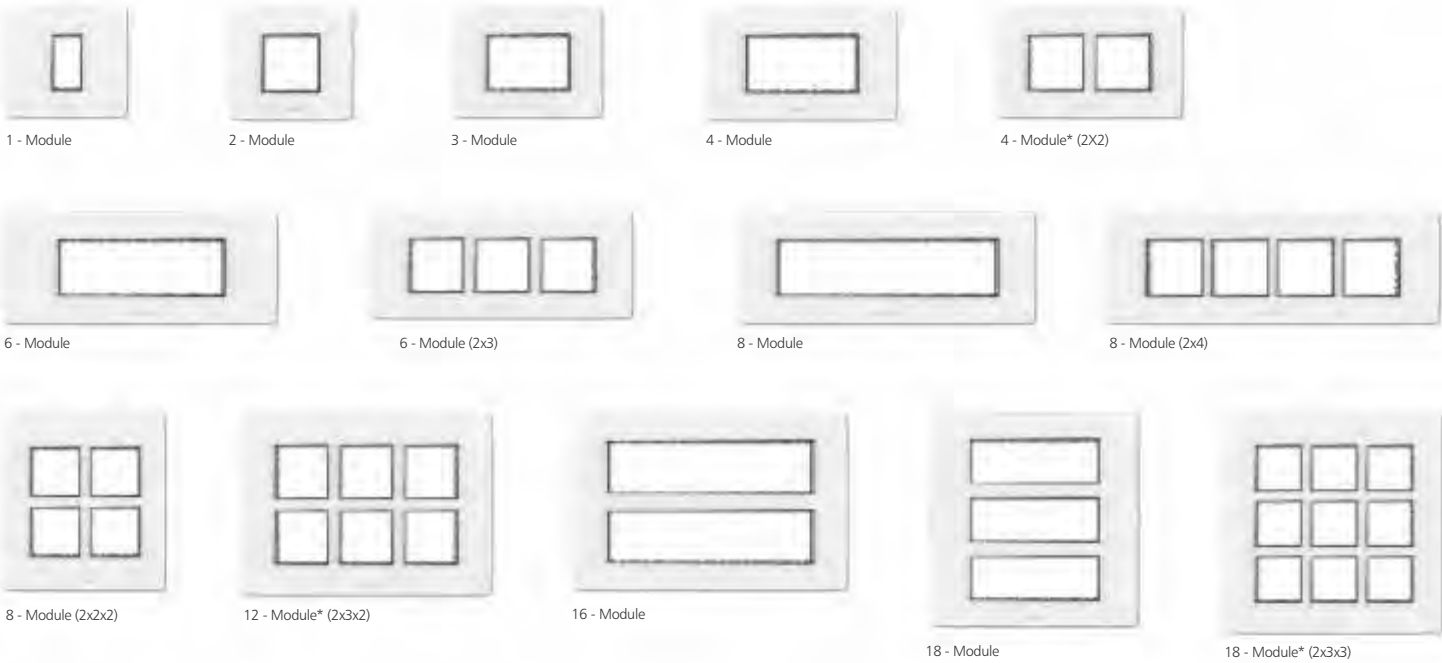

A5 MOUNTING FRAMES - Horizontal & Vertical Distance for Screwing (Dimensions in mm)

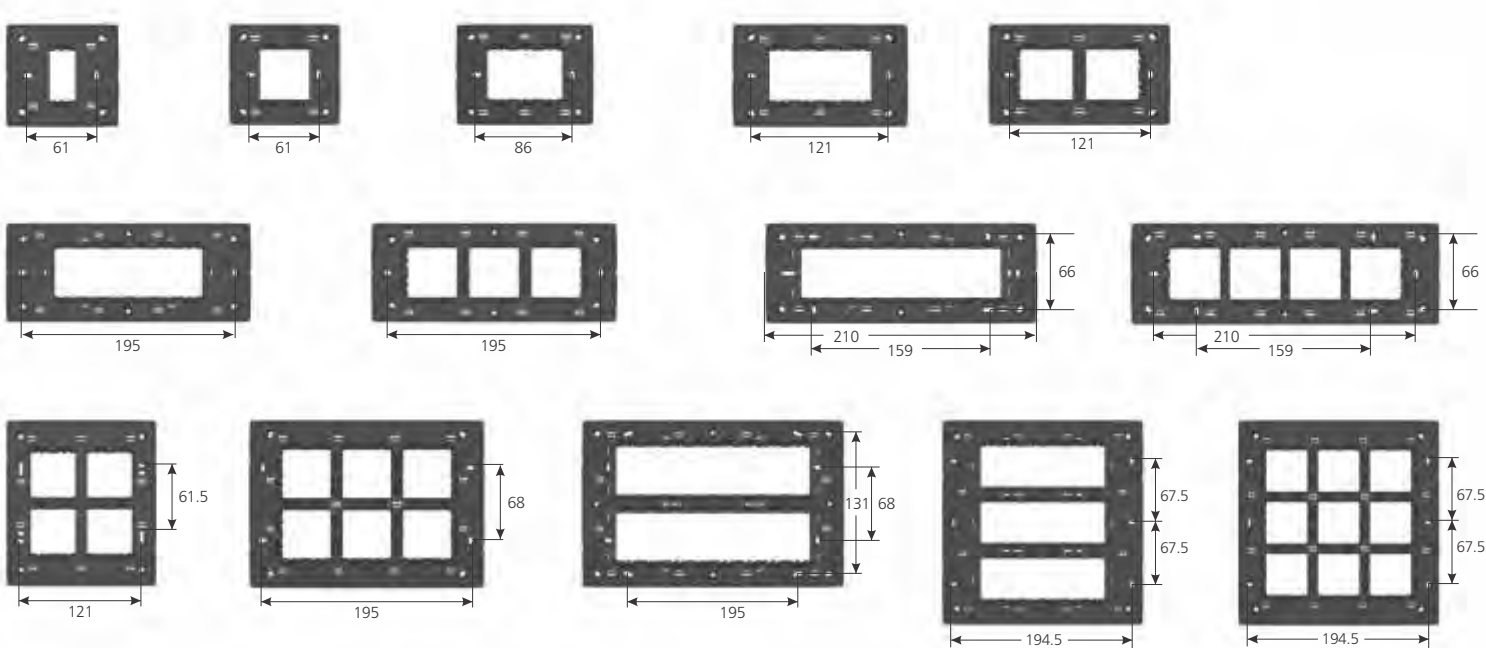

Air



Air A7 Absolute White Plate with Titanium Grey Step Marker

A7

The AIR A7 cover plate is a wonderful example of contemporary minimalistic design with sophisticated functionality. This is an ultra-flat plate with softly rounded corners and sleek chrome border around the inner frame. Characterised by AIR's familiar austere yet elegant looks, the A7 offers a quiet and reserved presence without appearing mundane or boring.. A quintessential modern-day switch plate, the A7 adds a touch of elegance with convincing functionality to every setting.

Air A7 Absolute White Plate With Titanium Grey Aero Switch, Step Marker



A7 PREMIUM COVER PLATES WITH MOUNTING FRAMES **NEW**

PLATES →	1M	2M	3M	3M*	4M	4M*	6M	6M*	8M	8M*	8M*	12M*	16M	18M*
COLOURS ↓	MRP ₹	MRP ₹	MRP ₹	MRP ₹	MRP ₹	MRP ₹	MRP ₹	MRP ₹	MRP ₹	MRP ₹	MRP ₹	MRP ₹	MRP ₹	MRP ₹
Pure Glossy	67.00	67.00	89.00	89.00	111.00	111.00	166.00	152.00	230.00	208.00	208.00	236.00	278.00	305.00
CODE →	230101	230201	230301	230303	230401	230403	230601	230603	230801	230803	238803	231203	231603	231803
Outer/Master →	10/500	10/500	10/400	10/400	10/400	10/400	5/200	5/200	5/200	5/200	5/200	5/120	5/90	5/80
SIZE(mm) →	98x91	98x91	123x91	123x91	152x91	152x91	225x91	225x91	250x91	275x91	152x168	225x158	250x158	225x225

* With Partition Plates

**Suitable for Horizontal & Vertical Installation



1 - Module



2 - Module



3 - Module



3 - Module (2+1)



4 - Module

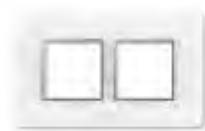

4 - Module* (2x2)

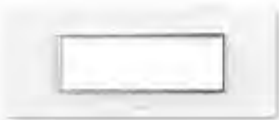

6 - Module



6 - Module* (2x3)

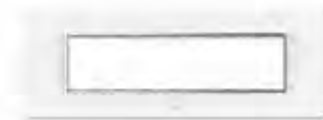

8 - Module



8 - Module* (2x4)



8 - Module (2x2x2)



12 - Module* (2x3x2)

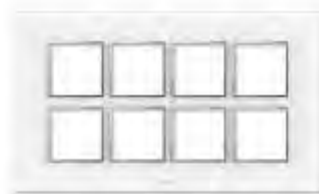

16 - Module



18 - Module* (2x3x3)

A7 MOUNTING FRAMES - Horizontal & Vertical Distance for Screwing (Dimensions in mm)

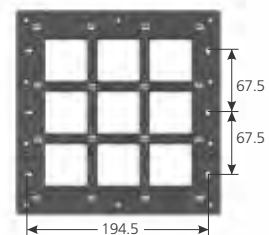
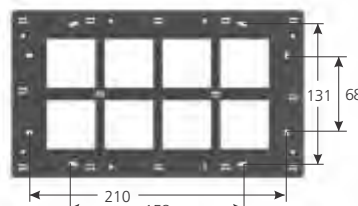
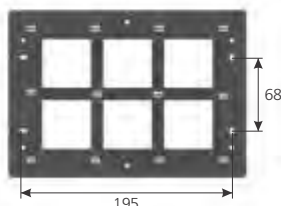
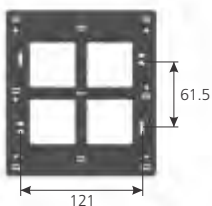
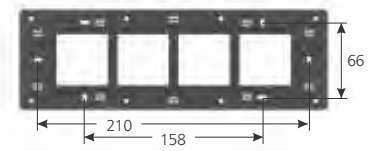
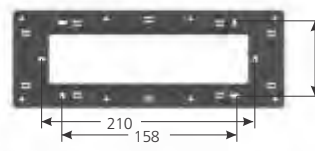
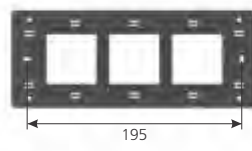
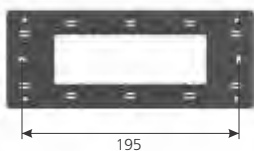
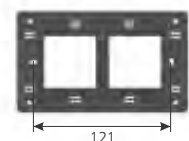
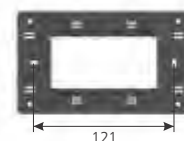
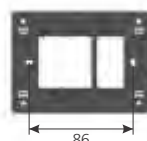
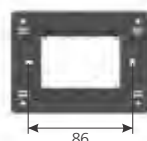
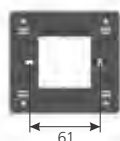
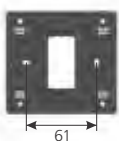

A6 WOODEN MODULAR PLATES - SUITABLE FOR WOODEN & METAL BOXES

PLATES →	1M	2M	3M	4M	4M*	6M	6M*	6M	8M*
					(H&V)**		(H&V)**		(V)
COLOURS ↓	MRP ₹	MRP ₹	MRP ₹	MRP ₹	MRP ₹	MRP ₹	MRP ₹	MRP ₹	MRP ₹
Pure Glossy	81.00	81.00	102.00	139.00	122.00	195.00	176.00	194.00	231.00
Metallic	126.00	126.00	159.00	215.00	189.00	299.00	274.00	299.00	357.00
Wood	158.00	158.00	198.00	269.00	237.00	373.00	342.00	373.00	447.00
CODE →	190101	190201	190301	190401	190403	190601	190603	190605	198803
Outer/Master →	10/300	10/300	10/300	10/240	10/240	10/200	10/200	10/200	5/120
SIZE(inch) →	4.5x4.5	4.5x4.5	4.5x4.5	4.5x6.5	4.5x7.5	4.5x8.5	4.5x8.5	4.5x8.5	6.5x6.5
Module Format →	-	-	-	-	2x2	-	2x3	3x2	2x2x2

* With Partition Plates

**Suitable for Horizontal & Vertical Installation



1 - Module

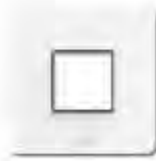

2 - Module

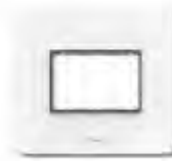

3 - Module



4 - Module

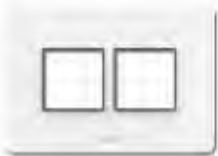

4 - Module** (2x2)

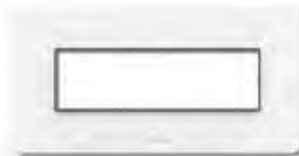

6 - Module

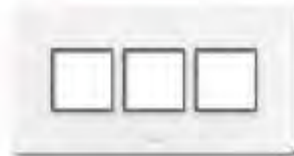

6 - Module** (2x3)



6 - Module* (3x2)

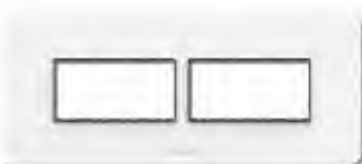

8 - Module** (4x2)



10 - Module* (3+4+3)



12 - Module** (H) (2x6)



8 - Module** (2x2x2)

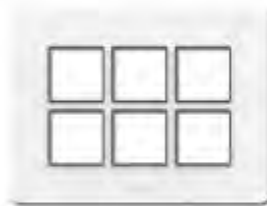

12 - Module** (2x3x2)

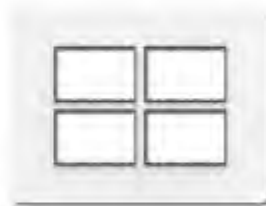

12 - Module* (3x2x2)



16 - Module** (2x4x2)



20 - Module** (2x5x2)



18 - Module** (2x3x3)

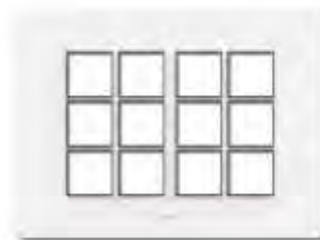

24 - Module** (2x4x3)

A6 WOODEN MODULAR PLATES - SUITABLE FOR WOODEN & METAL BOXES

8M*	10M	12M [#]	12M	12M	16M*	18M*	20M [#]	24M [#]
	(H)*	(H&V)**	(V)**	(V)*	(H&V)**	(H&V)**	(H&V)**	(H&V)**
MRP ₹	MRP ₹	MRP ₹	MRP ₹	MRP ₹	MRP ₹	MRP ₹	MRP ₹	MRP ₹
231.00	268.00	303.00	340.00	303.00	324.00	389.00	488.00	606.00
357.00	415.00	470.00	527.00	470.00	503.00	602.00	756.00	939.00
447.00	520.00	588.00	658.00	588.00	629.00	752.00	945.00	1174.00
190805	191001	191201	191203	191205	191601	191801	192001	192401
10/200	10/120	10/120	5/120	5/120	5/90	5/80	5/60	5/40
4.5x10.5	4.5x12.5	4.5x15.5	6.5x8.5	6.5x8.5	7.5x10.5	8.5x10.5	7.5x12.5	9.5x12.5
4x2	3+4+3	2x6	2x3x2	3x2x2	2x4x2	2x3x3	2x5x2	2x4x3

* With Partition Plates

**Suitable for Horizontal & Vertical Installation

A6 MOUNTING FRAMES - Horizontal & Vertical Distance for Screwing (Dimensions in mm)

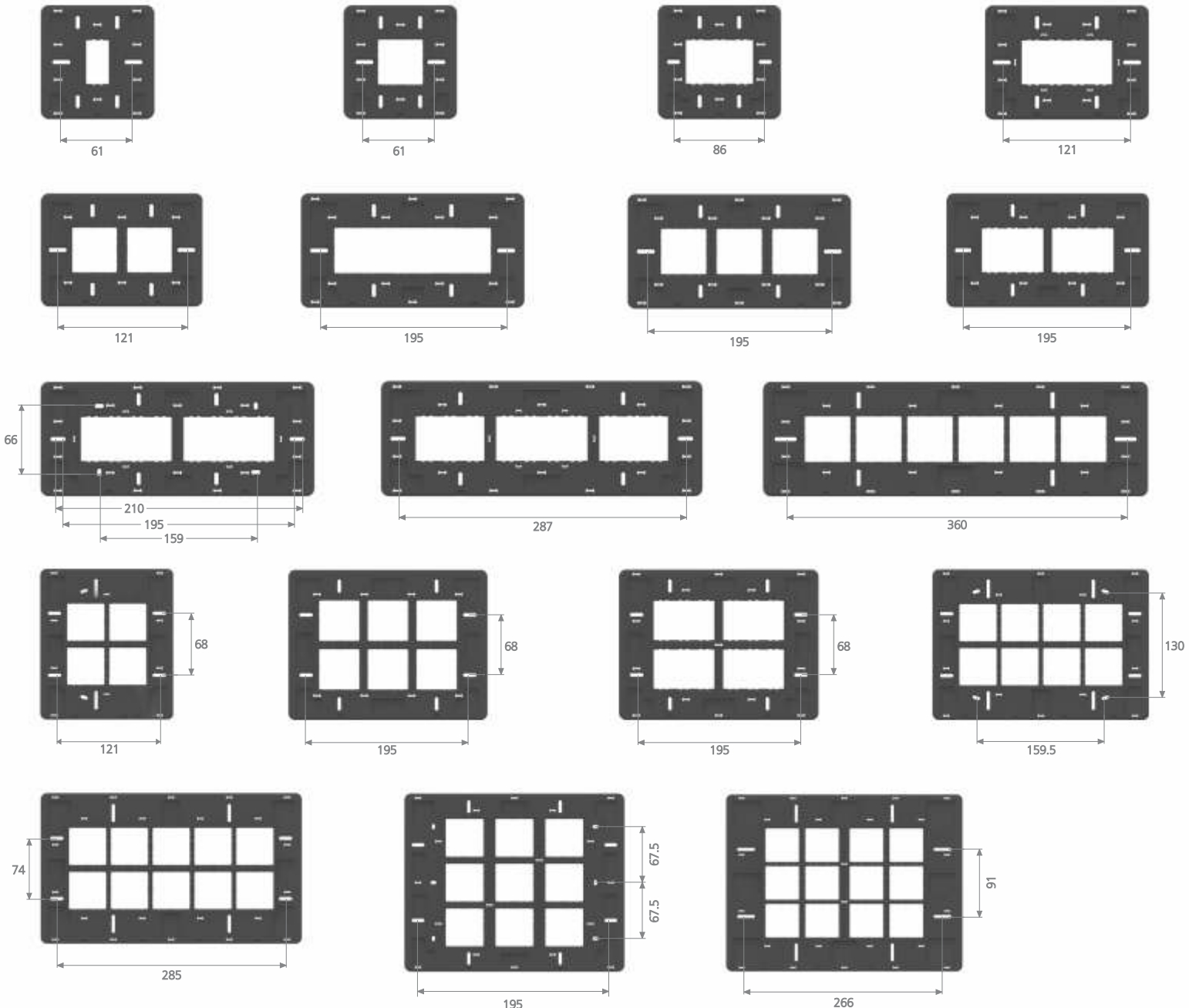

Not Suitable for Metal Box

World's Slimmest Modular COVERFRAMES
A7, A3, A5 & A6



DEFINE YOUR WORLD WITH COLOURS

A3
PLATES

PURE GLOSSY



01- Absolute White

A5
PLATES

BASIC - PURE GLOSSY



01- Absolute White

PREMIUM - PURE GLOSSY



01- Absolute White

A7
PLATES

PREMIUM - PURE GLOSSY



01- Absolute White

A6
PLATES

PREMIUM - PURE GLOSSY



01- Absolute White

METALLIC



07- Titanium Grey

WOOD



21- Volcanic Ash



22- Coffee Magic



23- Wild Wenge



Ultimate Sophistication



The GIFA range of modular inserts is minimalistic not just for aesthetic purposes but as a design philosophy. Represented by clear straight lines, crisp finishes and minimum flourishes, these inserts are perfectly streamlined for optimum functionality. Deep thought has been given to the configuration and purpose of each product. The end result is an effortless symphony of form with function and class with comfort that will surprise and delight you on an every day basis.

GIFA®
live innovative

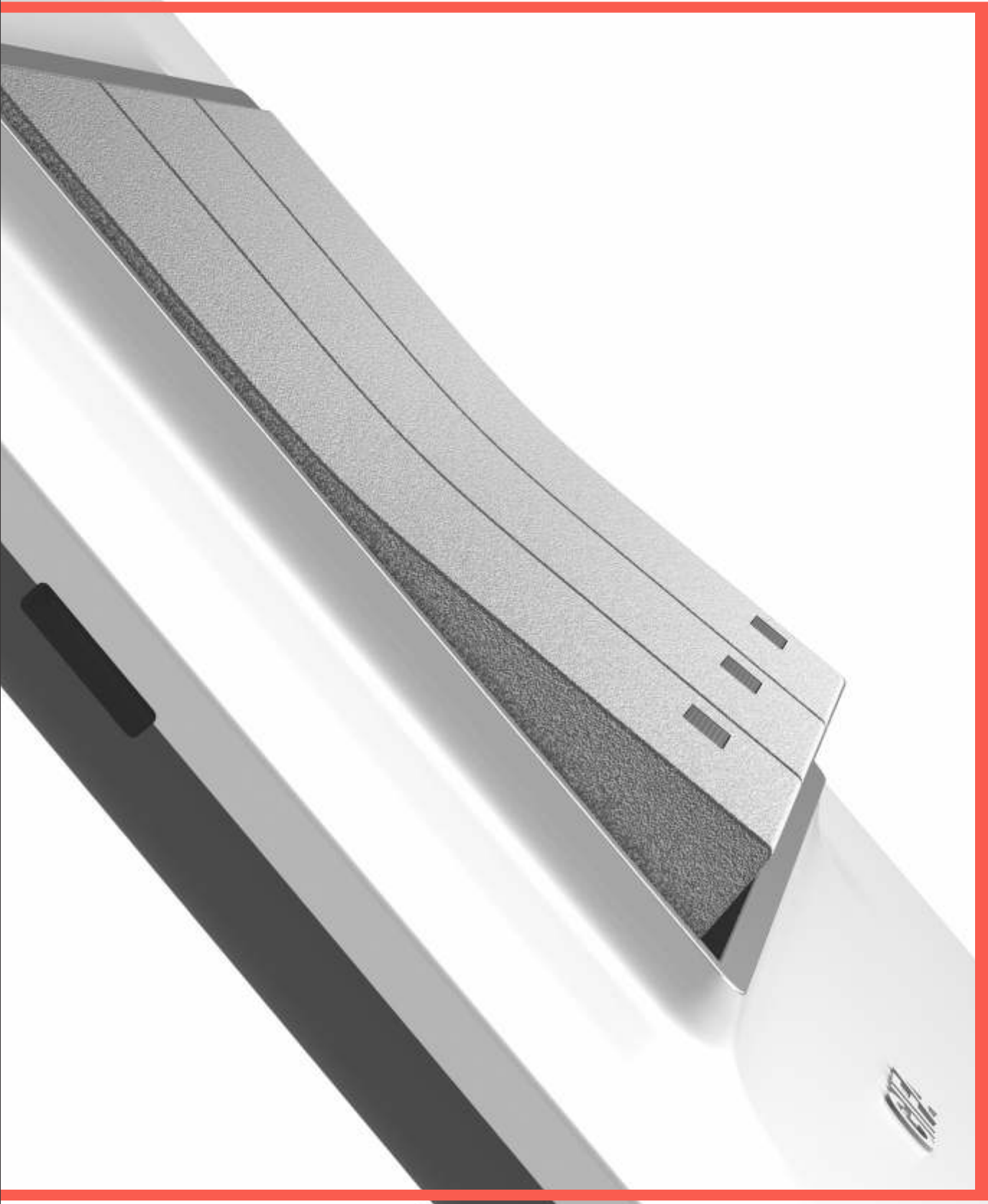

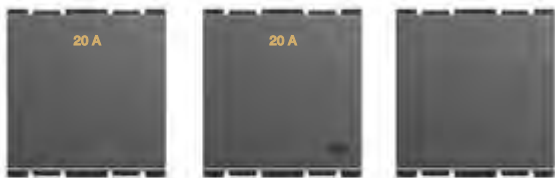

Code	Item	MRP ₹		Pkg.
		Absolute White	Digital Silver Titanium Grey	

10AX SWITCHES 240V~ (1 Module) GLINE

GF011001	1 Way Switch	65.00	71.00	20/600
GF011002	1 Way Switch with Indicator (LED)	114.00	127.00	20/600
GF011003	2 Way Switch	114.00	127.00	20/600
GF011004	Bell Push Switch	121.00	133.00	20/600
GF011005	Bell Push Switch with Indicator (LED)	139.00	152.00	20/600

10AX SWITCHES 240V~ (2 Module) GLINE

GF012010	1 Way Switch	137.00	150.00	10/300
GF012011	1 Way Switch with Indicator (LED)	154.00	170.00	10/300
GF012012	2 Way Switch	171.00	188.00	10/300
GF012013	Bell Push Switch	161.00	177.00	10/300
GF012014	Bell Push Switch with Indicator (LED)	183.00	202.00	10/300
GF012015	Bell Push Switch with Luminous Name Plate	250.00	275.00	10/300

240V~ 50-60Hz LED circuit with diffuser

20AMP / 25AMP SWITCHES 240V~ (1 Module) GLINE

GF011020	20A 1 Way Switch	153.00	170.00	20/600
GF011021	20A 1 Way Switch with Ind. (LED)	172.00	188.00	20/600
GF011022	20A 2 Way Switch	172.00	188.00	20/600
GF011023	25A 1 Way Switch	185.00	205.00	20/600

20AMP / 25AMP SWITCHES 240V~ (2 Module) GLINE

GF012025	20A 1 Way Switch	189.00	209.00	10/300
GF012026	20A 1 Way Switch with Ind. (LED)	210.00	230.00	10/300
GF012027	20A 2 Way Switch	227.00	250.00	10/300
GF012028	25A 1 Way Switch	238.00	261.00	10/300

32AMP DP SWITCHES 240V~ (2 Module) GLINE

GF012031	32A DP Switch with Indicator (LED)	307.00	338.00	10/300
----------	------------------------------------	--------	--------	--------

Code	Item	MRP ₹		Pkg.
		Absolute White	Digital Silver Titanium Grey	
10AX SWITCHES 240V~ (1 Module) GSLIDE				
GF011401*	1 Way Switch	65.00	71.00	20/600
GF011402*	1 Way Switch with Indicator (LED)	111.00	123.00	20/600
GF011403*	2 Way Switch	111.00	123.00	20/600
GF011404*	Bell Push Switch	117.00	129.00	20/600
GF011405*	Bell Push Switch with Indicator (LED)	135.00	148.00	20/600

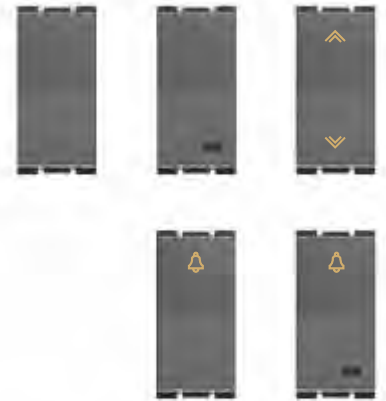

10AX SWITCHES 240V~ (2 Module) GSLIDE				
GF012410*	1 Way Switch	132.00	146.00	10/300
GF012411*	1 Way Switch with Indicator (LED)	150.00	165.00	10/300
GF012412*	2 Way Switch	166.00	183.00	10/300
GF012413*	Bell Push Switch	156.00	172.00	10/300
GF012414*	Bell Push Switch with Indicator (LED)	177.00	195.00	10/300

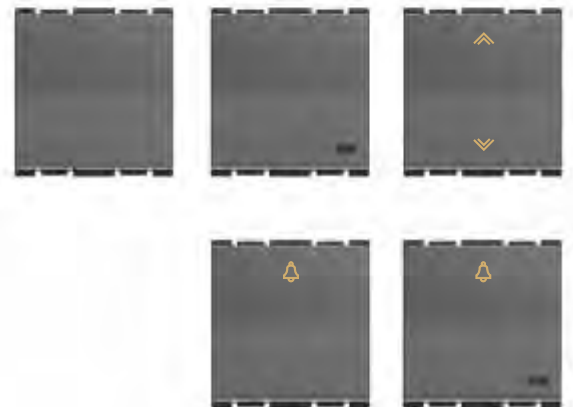

20AMP / 25AMP SWITCHES 240V~ (1 Module) GSLIDE				
GF011420*	20A 1 Way Switch	150.00	165.00	20/600
GF011421*	20A 1 Way Switch with Indicator	167.00	183.00	20/600
GF011422*	20A 2 Way Switch	167.00	183.00	20/600
GF011423*	25A 1 Way Switch	180.00	199.00	20/600



20AMP / 25AMP SWITCHES 240V~ (2 Module) GSLIDE				
GF012425*	20A 1 Way Switch	180.00	199.00	10/300
GF012426*	20A 1 Way Switch with Ind. (LED)	199.00	219.00	10/300
GF012427*	20A 2 Way Switch	216.00	238.00	10/300
GF012428*	25A 1 Way Switch	227.00	249.00	10/300

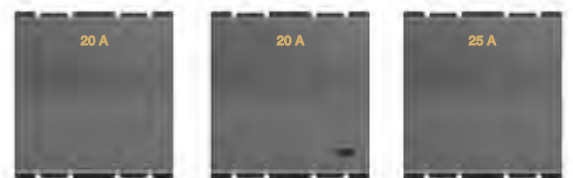

32AMP DP SWITCHES 240V~ (2 Module) GSLIDE				
GF012431*	32A DP Switch with Indicator (LED)	298.00	327.00	10/300



* introducing shortly

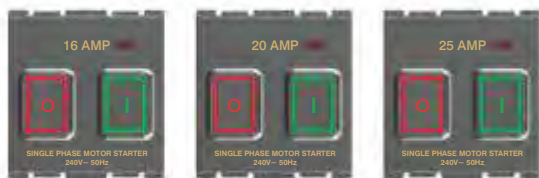

Code	Item	MRP ₹		Pkg.
		Absolute White	Digital Silver Titanium Grey	

6AMP / 10AMP SOCKETS 240V~

GF011035	6A 2 Pin Socket (1M) with safety shutter	103.00	113.00	20/600
GF012037	6A 2x1 Socket (2M) with safety shutter	128.00	141.00	10/450
GF012039	10A International Socket (2M) with safety shutter	212.00	233.00	10/450
GF012040	6A Universal Socket (2M) with mobile socket & safety shutter	152.00	168.00	10/450

6&16AMP / 6&25AMP SOCKETS 240V~ (2 Module)

GF012041	6&16A Universal Socket with safety shutter	233.00	255.00	10/450
GF012042	6&25A Universal Socket with safety shutter	240.00	264.00	10/450
GF012044	6&25A Universal Socket with flap & Indicator	323.00	355.00	10/450

DIMMER / FAN REGULATOR 240 V~ (1 Module)

GF011045	Dimmer 240V 50-60Hz 300-450W	291.00	320.00	20/600
GF011049	Step Regulator 4 Step, 240V 50-60 Hz	442.00	487.00	20/600

GALAXY FAN REGULATOR 240V~ (2 Module)

GF012050	Fan Regulator - Half Rotary	478.00	-	10/300
GF012051	Fan Regulator - Full Rotary	478.00	-	10/300
GF012052	Fan Regulator - Half Rotary (Chr. Knob)	-	542.00	10/300
GF012053	Fan Regulator - Full Rotary (Chr. Knob)	-	542.00	10/300

5 Step, 240V 50-60 Hz

MOTOR STARTER (SP) 240V~ 50-60Hz (2 Module)

GF012058	10A Motor Starter Switch	562.00	617.00	10/300
GF012059	16A Motor Starter Switch	562.00	617.00	10/300
GF012060	20A Motor Starter Switch	562.00	617.00	10/300
GF012061	25A Motor Starter Switch	562.00	617.00	10/300

TV SOCKET / RJ-11 TELEPHONE JACKS / EDP SOCKET (1 Module)

GF011066	TV Socket Coaxial 40-862 Mhz Socket	123.00	135.00	20/900
GF011068	Telephone Jack - RJ 11	134.00	147.00	20/600
GF011072	EDP Socket Outlet - RJ 45 (Cat 5e) Category 5e, Universal wiring T568A, insulating-piercing terminal	233.00	257.00	20/600
GF011074	EDP Socket Outlet - RJ 45 (Cat 6e) Category 6e, Universal wiring T568A, insulating-piercing terminal	589.00	649.00	20/600

Code	Item	MRP ₹		Pkg.
		Absolute White	Digital Silver Titanium Grey	

AUDIO - VIDEO SOCKET (1 Module) NEW

GF011075	Triple RCA Socket (Audio & Video)	660.00	720.00	5/150
GF011076	HDMI Socket	1000.00	1102.00	5/150



SINGLE POLE MCBS 240/450V~ (1 Module)

GF011077	C6 SP MCB	292.00	332.00	20/600
GF011078	C10 SP MCB	292.00	332.00	20/600
GF011079	C16 SP MCB	292.00	332.00	20/600
GF011080	C20 SP MCB	292.00	332.00	20/600
GF011081	C25 SP MCB	292.00	332.00	20/600
GF011082	C32 SP MCB	292.00	332.00	20/600

240/450V~ 50-60Hz 3.0kA Breaking Capacity



DOUBLE POLE MCBS 240/450V~ (2 Module)

GF012084	C6 DP MCB	589.00	649.00	10/300
GF012085	C10 DP MCB	589.00	649.00	10/300
GF012086	C16 DP MCB	589.00	649.00	10/300
GF012087	C20 DP MCB	589.00	649.00	10/300
GF012088	C25 DP MCB	589.00	649.00	10/300
GF012089	C32 DP MCB	589.00	649.00	10/300

240/450V~ 50-60Hz 3.0kA Breaking Capacity



INDICATOR / FUSE UNIT / BLANK MODULE (1 Module)

GF011093	Indicator with LED & Red Diffuser	105.00	116.00	20/600
GF011098	Fuse Carrier (10Amp/16Amp) with miniature fuse dia 6.3x28	144.00	158.00	20/600
GF011125	Blank Module	28.00	32.00	50/2000



STEP MARKER

GF012104	LED Step Marker (2M) Supply voltage 240V~ 50-60Hz	509.00	562.00	5/100
GF012105	i-Push Step Marker (2M) Supply voltage 240V~ 50-60Hz with high-efficiency 2x0.5W LED	1122.00	1234.00	5/100
GF013106	Step Marker (3M) Supply voltage 240V~ 50-60Hz with high-efficiency 2x0.5W LED	588.00	646.00	5/100

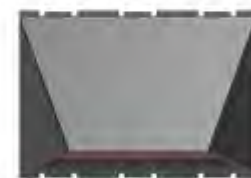

LIGHTING FITTING WITH EMERGENCY FUNCTION

GF012110	Lighting Fitting with Emergency Function (2M) with High Efficiency 2x0.5W LED & 3 Steps	1042.00	1146.00	5/100
GF013111	Lighting Fitting with Emergency Function (3M) with High Efficiency 3x0.5W LED & 3 Steps	1469.00	1615.00	5/100

Dimming Switch 240V~ 50Hz
when battery is inserted, the device will function as an emergency light
- Battery not included (101124)





Code	Item	MRP ₹		Pkg. Outer/ Master
		Absolute White	Digital Silver Titanium Grey	
EMERGENCY LIGHT BATTERY				
101124	Battery Li-ion, 3.6V 600mAH 2/3A (A Curve Modular Product)	249.00	-	20/600
ELECTRONIC BELL 240V~ (2 Module)				
GF012139	Electronic Bell 240V~50-60Hz	363.00	399.00	10/300
32A MAIN SWITCH (2 Module)				
GF012163	32A DP Operated by Key Tag 240V~, LED Supplied with Key Tag	523.00	575.00	10/300
GF012164	Only Key Tag with Name Plate	107.00	118.00	N.A.
25A ELECTRONIC BADGE SWITCH (3 Module)				
GF013165	Electronic Switch with Smart Card 25A 240V~ 50-60Hz with indicator (LED) & Integral relay having exit delay.	1754.00	1928.00	5/100
GF013166	Smart Card Customizable Smart Card	135.00	-	N.A.
DND/MAKE MY ROOM (2 Module)				
GF012168	Do Not Disturb/Make My Room 240V~ 50-60Hz - Inside Room	512.00	563.00	10/300
GF012169	Do Not Disturb/Make My Room 240V~ 50-60Hz - Outside Room	547.00	602.00	10/300
UNIVERSAL USB CHARGER 240V~				
GF 011172	USB Charger (1M) Supply voltage 160-240V~ 50-60Hz Output - 5V DC, 1000mA or 1A	865.00	952.00	20/600
GF012173	Dual Port USB Charger (2M) Supply voltage 160-240V~ 50-60Hz Output - 5V DC, 2000mA or 2A	1030.00	1135.00	5/100
GF013174	Dual Port USB Charger with Ind. & 10A International Socket (3M) Supply voltage 160-240V~ 50-60Hz Output - 5V DC, 2000mA or 2A	1475.00	1622.00	5/100
I-WAVE SWITCH 240V~ (2 Module)				
GF012201	I-Wave Switch Electronic Sensor switch Supply voltage 160-240V~ 6A relay output Allows to control lights by simply passing the hand in front of it (Max distance 50mm). Upto 5 Switches can be combined to control the same lighting circuit.	4531.00	5046.00	5/100

Code	Item	MRP ₹		Pkg.
		Absolute White	Digital Silver Titanium Grey	

SMART PASSIVE INFRARED DETECTOR (2 Module)

GF012212	Smart Passive Infrared Detector with infrared sensor, auto on/off, adjustable dusk/dawn sensor threshold and time delay cycle, supply voltage 240V~50-60Hz 6A relay output	1783.00	1968.00	5/100
----------	--	---------	---------	-------

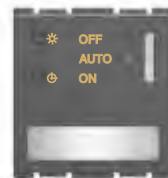

I - DOCK PLAYER (4 Module)

NEW

GF014280	I-Dock Player Supply voltage 240V~, Inbuilt stereo amplifier : 2 x 4W, charging function for Iphone 5, 5S, 5C, 6, 6S, 6Plus, I-pod Touch & I-Pad Air, Gesture control for music & cell phone communication, SIRI enabled. Can be connected to any music system, home audio system, speakers i.e ceiling or inwall through amplifier via Line out (Aux out) Audio input - 3.5mm jack, I-pod, I-phone & Bluetooth Enable devices. Audio output - Stereo Line out, 2 Speaker out 4W each (Amplifier supplied separately - 101320 A Curve Modular Product) - (Page No. 36)	7100.00	7800.00	5/50
----------	---	---------	---------	------



GALAXY DOCK PLAYER (4 Module)

NEW

GF014281	Galaxy Dock Player Supply voltage 240V~, Inbuilt stereo amplifier : 2 x 4W, charging function for Samsung S2 and above compatible with charger. Gesture control for music & cell phone communication, S-Voice enabled. Can be connected to any music system, home audio system, speakers i.e ceiling or inwall through amplifier via Line out (Aux out) Audio input - 3.5mm jack, Android devices & Bluetooth Enable devices. Audio output - Stereo Line out, 2 Speaker out 4W each (Amplifier supplied separately - 101320 A Curve Modular Product) - (Page No. 36)	7100.00	7800.00	5/50
----------	---	---------	---------	------



STEREOPHONIC SPEAKER (2 Module)

NEW

GF012306	Stereophonic Speaker - 2piece set Stereophonic loud Speaker Output : 3W Impedance : 4 ohms	1549.00	1719.00	10/100
----------	--	---------	---------	--------

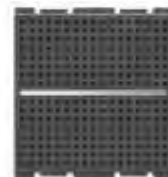

ROUTER + EXTENDER (3 Module)

NEW

GF013322	Wi-Fi Router + Extender 300 MBPS wi-fi wireless router with Ethernet port, In-built USB port for internet connectivity and charging devices. Also support 4G dongle.	4500.00	5000.00	5/100
----------	--	---------	---------	-------



FLUSH MOUNTING METAL GANG BOXES (GALVANIZED)

GANG BOX →	1 & 2M	3M	4M	6M	8M(H)	8M(V)	12M	16M	18M
MRP ₹ ↓	65.00	86.00	106.00	131.00	171.00	171.00	215.00	265.00	303.00
CODE	GF70201	GF70302	GF70403	GF70604	GF70805	GF78806	GF71207	GF71608	GF71809
Outer/Master →	10/120	10/120	10/120	5/80	5/80	5/60	5/45	5/40	5/40
SIZE (WxHxL) mm	75x73x51	100x73x51	135x73x51	208x73x51	230x73x51	135x130x60	209x130x60	230x144x60	209x200x60

METAL GANG BOXES

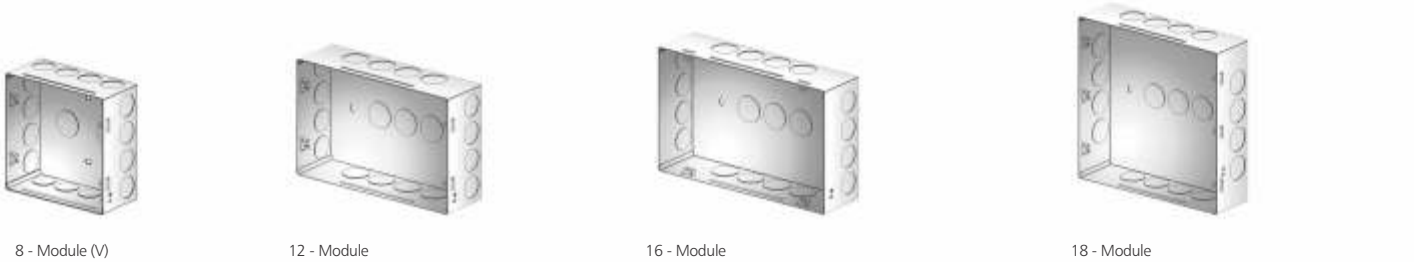
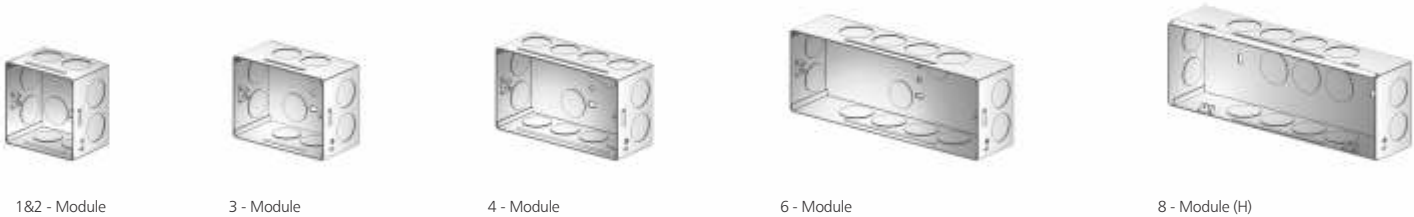

F9 COVER PLATES WITH MOUNTING FRAMES

PLATES →	1M	2M	3M	3M*	4M	4M*	6M	6M*	8M	8M*	8M	8M*	12M	12M*	16M*	18M
						(H&V)**		(H&V)**		(H&V)**	(V)	(H&V)		(H&V)**		
COLOURS ↓	MRP ₹	MRP ₹	MRP ₹	MRP ₹	MRP ₹	MRP ₹	MRP ₹	MRP ₹	MRP ₹	MRP ₹	MRP ₹	MRP ₹	MRP ₹	MRP ₹	MRP ₹	MRP ₹
Pure Glossy	88.00	88.00	109.00	109.00	133.00	133.00	190.00	190.00	242.00	242.00	242.00	242.00	276.00	276.00	312.00	353.00
Metallic	138.00	138.00	179.00	179.00	217.00	217.00	297.00	297.00	373.00	373.00	373.00	373.00	435.00	435.00	492.00	526.00
Wood	187.00	187.00	255.00	255.00	312.00	312.00	425.00	425.00	584.00	584.00	584.00	584.00	629.00	629.00	663.00	697.00
CODE →	GF30101	GF30201	GF30301	GF30303	GF30401	GF30403	GF30601	GF30603	GF30801	GF30803	GF38801	GF38803	GF31201	GF31203	GF31601	GF31801
Outer/Master →	10/400	10/400	10/300	10/300	10/300	10/300	5/150	5/150	5/150	5/150	5/150	5/150	5/120	5/120	5/90	5/80
SIZE(mm) →	98x91	98x91	121x91	121x91	146x91	152x91	220x91	220x91	245x90	275x90	152x168	152x168	220x157	220x157	245x157	220x222

* With Partition Plates

** Suitable for Horizontal & Vertical Installation

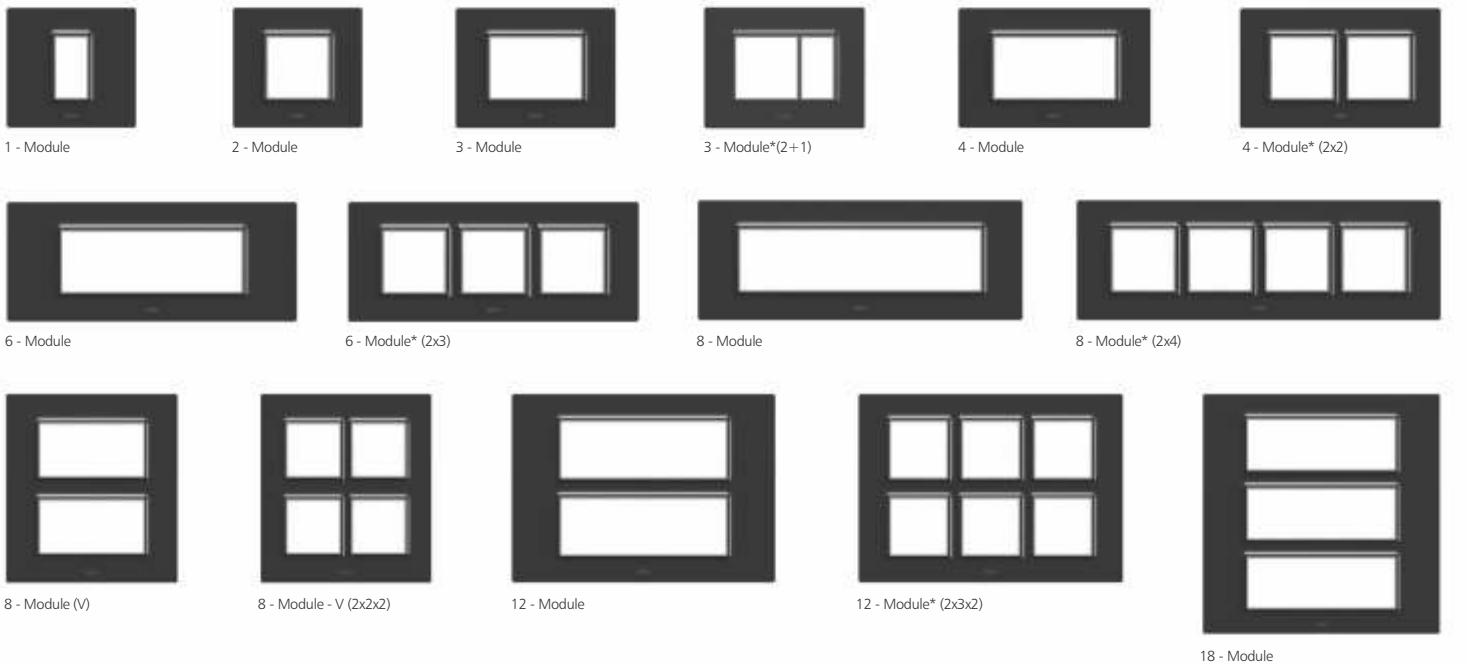

F9 MOUNTING FRAMES - Horizontal & Vertical Distance for Screwing (Dimensions in mm)

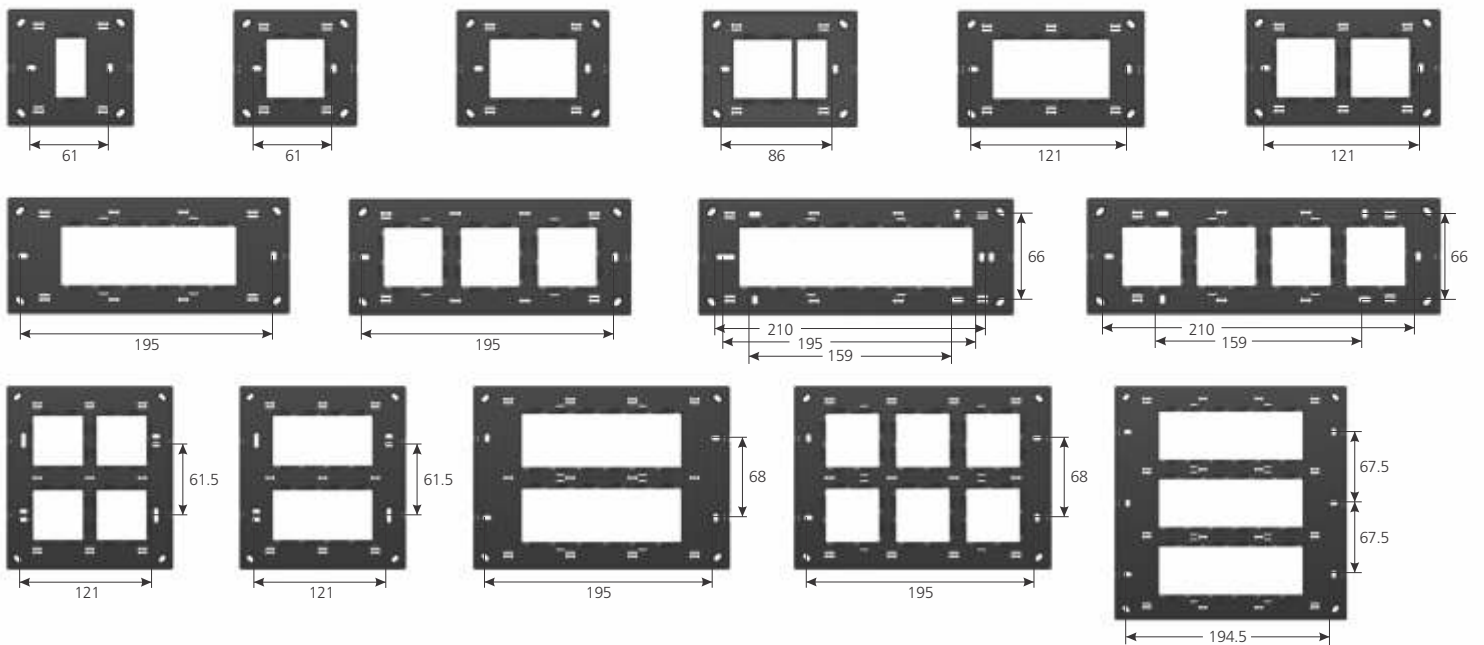



A9



Gifa AG Mountain Dew Plate with Titanium Grey G-Line Switch, Regulator

The colours of the Ag cover plates are modern yet delicate and almost ethereal in many ways. The tone is muted, relaxed and calm to ensure that these cover plates create a warm, welcoming environment around them. The choice of colours and texture allows the Ag cover plates to coexist peacefully with almost any type of ambience. Complement it with light interiors to create an air of purity and elegance or contrast it with dark interiors to create a rich, plush setting!

Gifa Ag French Wine Plate with Titanium Grey G-Line Switch, Emergency Light



NEW

A9 GLASS COVER PLATES

A9 PLATES →	2M	3M	4M*	6M	6M*	8M*	8M (V)	12M	12M*	18M
			(H&V)**		(H&V)**	(H&V)**	(H&V)**		(H&V)**	
COLOURS ↓	MRP ₹	MRP ₹	MRP ₹	MRP ₹	MRP ₹	MRP ₹	MRP ₹	MRP ₹	MRP ₹	MRP ₹
Glass (diamond cut)	530.00	747.00	1082.00	1406.00	1492.00	1644.00	1644.00	1773.00	1880.00	2174.00
CODE →	GF50201	GF50301	GF50403	GF50601	GF50603	GF50803	GF58803	GF51201	GF51203	GF51801
Outer/Master →	10/200	10/200	10/150	5/100	5/100	5/100	5/100	5/75	5/75	5/40
SIZE(mm) →	108x94	130x94	154x94	228x94	228x94	280x94	156x173	228x160	228x160	228x228

* With Partition Plates

**Suitable for Horizontal & Vertical Installation



2 - Module



3 - Module



4 - Module* (2x2)



6 - Module



6 - Module* (2x3)



8 - Module* (2x4)



8 - Module - V (2x2x2)



12 - Module



12 - Module* (2x3x2)



18 - Module

A9 MOUNTING FRAMES - Horizontal & Vertical Distance for Screwing (Dimensions in mm)

A9 Frame →	2M	3M	4M	6M	6M	8M	8M (V)	12M	12M	18M
			(H&V)**		(H&V)**	(H&V)**	(H&V)**		(H&V)**	
MRP ₹ →	53.00	64.00	78.00	107.00	116.00	145.00	145.00	172.00	183.00	233.00
CODE →	GF50202	GF50302	GF50404	GF50602	GF50604	GF50804	GF58804	GF51202	GF51204	GF51802
Outer/Master →	25/750	25/750	25/500	20/240	20/240	20/240	20/240	20/160	20/160	10/80

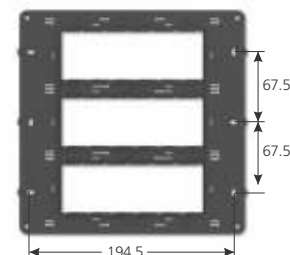
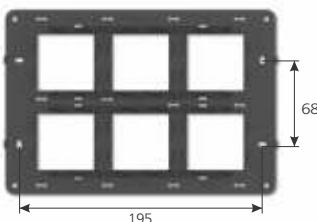
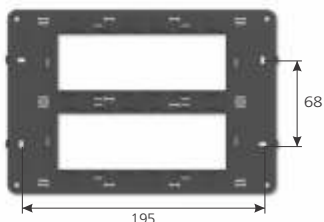
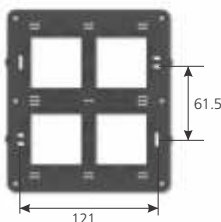
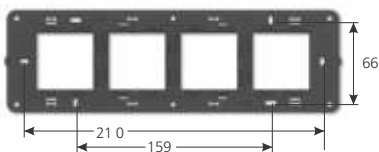
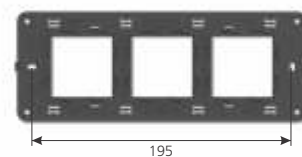
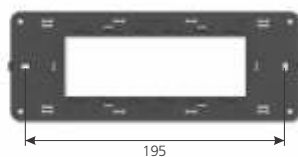
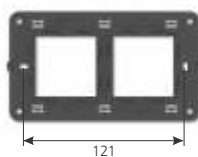
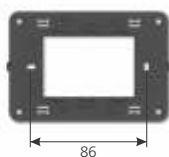
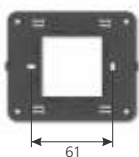



Gifa X9 Absolute White Plate with Titanium Grey G-Slide Switch, Regulator

X9

It's the cover plate with the X-factor. Shaped like an eye-catching curved TV, the X9 cover plate exhibits the aesthetics of an artistic centerpiece. Mount it on the wall and its curved shape lends this cover plate a floating look that appears ultra premium in any setting. Another unique feature is the raised chrome frame at the centre which elevates the design to a whole new level. Available in a variety of finishes, the X9 is a cover plate that's distinctly a cut above the rest.

Gifa X9 Absolute White Plate with Titanium Grey G-Slide Switch, Key Tag



NEW

X9 COVER PLATES WITH MOUNTING FRAMES

PLATES →	2M	3M	4M	6M	8M	8M	12M	16M	18M
						(V)			
COLOURS ↓	MRP ₹	MRP ₹	MRP ₹	MRP ₹	MRP ₹	MRP ₹	MRP ₹	MRP ₹	MRP ₹
Pure Glossy	126.00	168.00	199.00	289.00	341.00	315.00	436.00	510.00	604.00
Metallic	179.00	236.00	283.00	404.00	478.00	441.00	609.00	714.00	845.00
Wood	215.00	283.00	341.00	446.00	541.00	541.00	683.00	814.00	971.00
CODE →	GF60201	GF60301	GF60401	GF60601	GF60801	GF68801	GF61201	GF61601	GF61801
Outer/Master →	10/400	10/300	10/300	5/150	5/150	5/150	5/120	5/90	5/80
SIZE(mm) →	106x92	130x92	154x92	228x92	254x92	160x168	228x158	254x158	228x222



2 - Module



3 - Module



4 - Module



6 - Module



8 - Module



8 - Module (V)



12 - Module

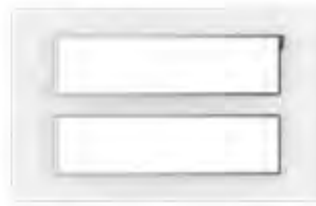

16 - Module



18 - Module

X9 MOUNTING FRAMES - Horizontal & Vertical Distance for Screwing (Dimensions in mm)

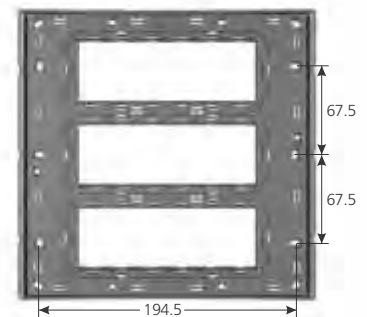
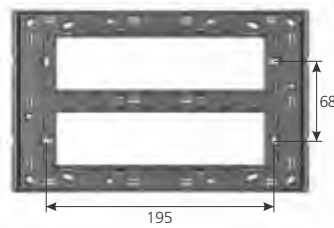
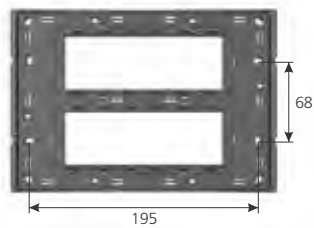
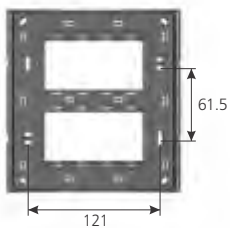
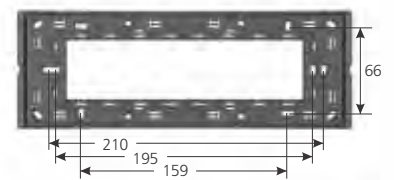
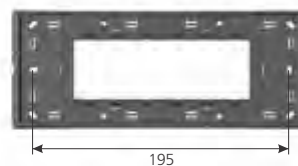
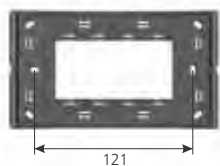
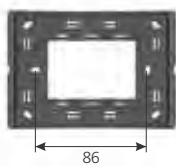
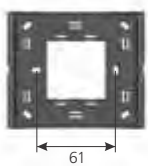



From the symbolic to the subliminal, colours shape the world we live in. Seek the colours that speak to you and evoke the feelings that you desire.



F9
PLATES

DEFINE YOUR WORLD WITH COLOURS

PURE GLOSSY



01 - Absolute White



02 - Black Glossy

METALLIC



06 - Titanium Silver



07 - Titanium Grey



08 - Champagne Gold



09 - Copper Silk



10 - Android Green*



11 - Air Force Blue



12 - Ferrari Red

WOOD



31 - Fuzzy Brown



32 - Dark Apricot



33 - Chocolate Wood

PURE GLOSSY



01 - Absolute White

X9
PLATES

A9
GLASS PLATE



01 - Black Jack



02 - Blue Witch



03 - French Wine



04 - Mountain Dew

* Introducing shortly



NOW
THERE'S SOUND
IN SPACE!

G SPACE



HERE
THEY ALL COME
TOGETHER

BUZY BEE





THE
SEA HAS
MANY SECRETS.
REVEAL ONE ON
YOUR WALL.



ADD
ANOTHER
DIMENSION TO
YOUR FOUR WALLS.

GHEXO





203048



203049



203050



203051



203052

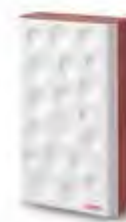

203053



204061



204062



204063



204064



204065



204066



204070



204072



204073



204074



204075



204078

Code	Item	MRP ₹	Pkg. Out/Master
------	------	-------	--------------------

DING DONG DOOR BELL

203048	Ocean Stereophonic Ding Dong	182.00	5/100
203049	Aqua Stereophonic Ding Dong	182.00	5/100
203050	Snowwhite Stereophonic Ding Dong	182.00	5/100
203051	Belaton Stereophonic Ding Dong	182.00	5/100
203052	Woofier Stereophonic Ding Dong	222.00	5/100
203053	G-Spot Stereophonic Ding Dong	218.00	5/100

ELECTRONIC DOOR BELL

204061*	G-Shell - Multitune NEW with selectable tunes & flashing Light	427.00	5/60
204062	G-Space - Stereophonic NEW 4 mode selection - Big B songs tunes, Big B songs tunes with POD, Big ben chime, Ding Dong Melody	459.00	5/60
204063	G-Hexo - Polyphonic NEW 4 mode selection - Hindi midi tune, English midi tune, Big ben chime, Ding Dong melody	459.00	5/60
204064	G-Oxi - Polyphonic NEW 4 mode selection & flashing Light Hindi songs tunes, Hindi songs piano mode with POD, Hindi songs piano mode, Big ben chime	481.00	5/60
204065	Buzy-Bee - Stereophonic NEW 4 mode selection - Big B songs tunes, Big B songs tunes with POD, Big ben chime, Ding Dong Melody	553.00	5/60
204066*	G-Astro - Polyphonic NEW 4 mode selection & flashing Light 4 mode selection - 28 melodies, 28 melodies & POD, Bigben, Ding Dong Melody	541.00	5/60

ELECTRONIC DOOR BELL

204070	Welcome - Multitune with flashing Light	446.00	5/60
204072	Pulse - Multitune with flashing Light	446.00	5/60
204073	Musac Door Bell 32 selectable melodies & volume control	957.00	5/60
204074	IQ Door Bell 32 selectable melodies & volume control	880.00	5/60
204075	MyMusic Door Bell - Polyphonic 32 selectable melodies, volume control and shuffle function	1029.00	5/60
204078	Zyro (Mp3 Door Bell) In-built 128 MB storage, Pre-Recorded Mantras and Melodies, Volume Control & shuffle function Customize & store your own Music. (Supplied with USB Cable for file Transfer)	2089.00	5/60

* introducing shortly





204077



204079



204080A



204080B



204080C

Code	Item	MRP ₹	Pkg. Out/Master
------	------	-------	--------------------

MANTRA DOOR BELL

204077	Mantras (Mp3 Door Bell) In-built 128 MB storage, Pre-Recorded Mantras and Melodies, Volume Control & shuffle function Customize & store your own Music. (Supplied with USB Cable for Recording)	1533.00	5/60
204079	Ek Mantra - Gayatri Mantra	348.00	5/60
204080 A	Ekaant - Mantra Bell with 4 selectable mantras & flashing light (4 mode selection - Jain Stuti, Gurubani, Maha Laxmi & Tirupati Balaji Mantra)	435.00	5/60
204080 B	Ekaant - Mantra Bell with 4 selectable mantras & flashing light (4 mode selection - Guru Mantra, Maha Mritunjaya, Ganeshji & Sainath Mantra)	435.00	5/60
204080 C	Ekaant - Mantra Bell with 4 selectable mantras & flashing light (4 mode selection - Sri Krishna, Ding Dong, Azaan & Gayatri Mantra)	435.00	5/60

ELECTRONIC DOOR BELL

204081	Red Star Multitune with 4 selectable tune & flashing light	478.00	5/60
204082	Red Dot Polyphonic with Selectable Melodies, volume control shuffle function & flashing light 4 mode selection - 28 melodies, 28 melodies & POD, Bigben, Ding Dong Melody	708.00	5/60
204083	Salsa Polyphonic with Selectable Melodies & flashing light 4 mode selection - 28 melodies, 28 melodies & POD, Bigben, Ding Dong Melody	515.00	5/60



204081



204082



204083



204086



204087



204088



204089



204090



204091



204092



204093



204094

Code	Item	MRP ₹	Pkg. Out/Master
------	------	-------	--------------------

WIRELESS DOOR BELLS

204086	Gloria 2 Pin Plug In Wireless with remote, 32 selectable melodies & volume control function with Night Lamp	1152.00	5/60
204087	Erika 2 Pin Plug In Wireless with remote, 32 selectable melodies & volume control function	1230.00	5/60
204088	Musac Wireless with remote, 32 selectable melodies & volume control function	1425.00	5/60
204089	IQ Wireless with remote, 32 selectable melodies & volume control function	1425.00	5/60
204090	MyMusic Wireless - Polyphonic 32 selectable melodies, volume control & shuffle function	1484.00	5/60
204091	Wireless Mantras (Mp3 Door Bell) In-built 128 MB storage, Pre-Recorded Mantras & Melodies, Volume Control & shuffle function	2075.00	5/60
204092	Plug In Wireless with remote, 32 selectable melodies, volume control & shuffle function. direct AC (no battery required for bell, battery required only for remote).	1175.00	5/60
204093	G-Flow Wireless with remote, 32 selectable melodies, and flashing light	1185.00	5/60
204094	G-Guide Wireless with remote, 32 selectable melodies, and flashing light	1185.00	5/60

AS INVITING AS YOUR SMILE!



Curvē **plus**



205100



205104



205106



205108



205109



Code	Item	MRP ₹	Pkg. Out/Master
------	------	-------	--------------------

HIGH GRADE ADAPTORS 240V~

205101	i-Strip LED Spike Guard 6 Outlet international Socket, Master Switch, Indicator with surge protector - 2 Mtr Cables	1010.00	5/30
--------	---	---------	------

POWER STRIP 240V~

205102	i-Design 4x1 Power Strip 4 Outlet international Socket with Master Switch & Indicator	580.00	5/30
205103	i-Design 4x4 Power Strip 4 Outlet international Socket with Individual Switch & Indicator	885.00	5/30
205107	i-Design 4x4 Power Strip with USB with 3 Outlet international Socket, Individual Switch, Indicator & Dual USB Port - Output 2100mA. - 2 Mtr Cables	1420.00	5/30



360° HIGH GRADE ADAPTORS 240V~

205100	360° Power Strip 6 Outlet international Socket, Master Switch, Indicator	720.00	5/30
205104	360° Spike Guard 5 Outlet international Socket, Master Switch, Indicator with surge protector	885.00	5/30
205106	360° Spike Guard with USB 4 Outlet international Socket, Master Switch, Indicator with surge protector & Dual USB Port - Output 2100mA. - 2 Mtr Cables	1455.00	5/30





HIGH GRADE ADAPTORS SPIKE GUARD 240V~

205108	G-Trix 4x1 Spike Guard NEW 4 Outlet international Socket with Master Switch, Indicator & surge protector	560.00	5/30
205109*	G-Trix 4x1 Spike Guard with USB NEW 3 Outlet international Socket, with Master Switch, Indicator & Dual USB Port - Output 2100mA. with surge protector	1120.00	5/30



* introducing shortly

Code	Item	MRP ₹	Pkg. Out/Master
POWER CUBE SPIKE GUARD 240V~			
205110	Power Cube Original 5 Power outlets with surge protector	799.00	5/60
205111	Power Cube Extended with 1.5 MTR wire, 5 Power outlets with surge protector	1049.00	5/60
205112	Power Cube Original USB 4 Power outlets 2 USB ports with surge protector	1399.00	5/60
205113	Power Cube Extended USB with 1.5 MTR wire, 4 Power outlets 2 USB ports with surge protector	1699.00	5/60
	 reddot award 2014 winner		
	 USB CHARGER		



205110



205111



205112



205113

HIGH GRADE ADAPTORS SPIKE GUARD 240V~			
205211	G-Xpress 4x1 Spike Guard NEW 4 Outlet international Socket with Master Switch, Indicator & surge protector	670.00	5/30
205212	G-Xpress 4x1 Spike Guard with USB NEW 3 Outlet international Socket, with Master Switch, Indicator & Dual USB Port - Output 2100mA. with surge protector	1230.00	5/30
205213*	Logica 4x1 Spike Guard NEW 4 Outlet international Socket with Master Switch, Indicator & surge protector	569.00	5/30
205214*	Logica 4x1 Spike Guard with USB NEW 3 Outlet international Socket, with Master Switch, Indicator & Dual USB Port - Output 2100mA. with surge protector	1049.00	5/30
	 USB CHARGER		



205211



205212



205213



205214

HIGH GRADE 16A EXTENSION CORD / DECORATIVE WIRE LINK			
205131	Twister 16A 3 Pin 3.5 Mtr Cable with 6/16A uni. socket, international socket, 2 Pin socket & Indicator	840.00	5/30
205132	G-Expert 16A 3 Pin 3.5 Mtr Cable with 6/16A uni. socket, international socket, 2 Pin socket, Indicator & Tripper	895.00	5/30
205149	Decorative Wire Link 5 Mtr. with 2 pin plug & pendant holder	189.00	5/60



205131



205132



205149



205116



205117



205118



205119



205120



205121



205122



205123



205124



205125



205126



205127



205128



205129



205133



205134



205135



205136



205139



205140



205141

Code	Item	MRP ₹	Pkg. Out/Master
------	------	-------	--------------------

EXTENSION CORDS 240V~

205116	Sliq 2 Pin 5 Mtr Cable with handle, indicator & international socket	379.00	5/60
205117	Sliq 3 Pin 4 Mtr Cable with handle, indicator & international socket	470.00	5/60
205118	Quord 2 Pin 5 Mtr Cable with handle, indicator & international socket	380.00	5/60
205119	Quord 3 Pin 4 Mtr Cable with handle, indicator & international socket	488.00	5/60
205120	Dazzle 2 Pin 5 Mtr Cable with indicator & international socket	353.00	5/60
205121	Dazzle 3 Pin 4 Mtr Cable with indicator & international socket	440.00	5/60
205122	Twister 2 Pin 5 Mtr Cable with indicator & international socket	351.00	5/60
205123	Twister 3 Pin 4 Mtr Cable with indicator & international socket	454.00	5/60
205124	G-Smart 2 Pin 5 Mtr Cable Indicator & international socket	367.00	5/60
205125	G-Smart 3 Pin 4 Mtr Cable with indicator & international socket	483.00	5/60
205126	G-Expert 2 Pin 5 Mtr Cable with handle, indicator & international socket	426.00	5/60
205127	G-Expert 3 Pin 4 Mtr Cable with handle, indicator & international socket	548.00	5/60
205128	G-Dial 2 Pin 5 Mtr Cable with indicator & international socket	353.00	5/60
205129	G-Dial 3 Pin 4 Mtr Cable with indicator & international socket	441.00	5/60
205133	Gio 2 Pin 2.5 Mtr Cable with indicator & international socket	356.00	5/60
205134	Gio 3 Pin 1.5 Mtr Cable with indicator & international socket	431.00	5/60
205135	Krysta 2 Pin 5 Mtr Cable NEW with indicator & 2 international socket	437.00	5/60
205136	Krysta 3 Pin 4 Mtr Cable NEW with indicator & 2 international socket	504.00	5/60
205138	Plano 2 Pin 5 Mtr Cable with indicator & international socket	405.00	5/60
205139	Plano 3 Pin 4 Mtr Cable with indicator & international socket	522.00	5/60
205140	Infino 2 Pin 5 Mtr Cable NEW with indicator & 2 international socket	476.00	5/60
205141	Infino 3 Pin 4 Mtr Cable NEW with indicator & 2 international socket	532.00	5/60

EASY
TO HOLD.
HARD TO
LET GO.



Curvè plus



206151



206152



206161



206162



206163



203164



203165



206169



206170 A



206170 B



206170 C



206170 D



206170 E



206170 F



06325

Code	Item	MRP ₹	Pkg. Out/Master
------	------	-------	--------------------

LED NIGHT LAMPS

206151	Hot Shot Night Lamp with LED	103.00	10/300
--------	------------------------------	--------	--------

206152	Desire Night Lamp with LED	94.00	10/300
--------	----------------------------	-------	--------

Available colour: Blue, Yellow & Orange

EDGE GLOW LED / NIGHT LAMPS

206161	Divine Glow - Shri Parashwanath edge glow night lamp with LED	199.00	10/300
--------	---	--------	--------

206162	Divine Glow - Lord Ganesha edge glow night lamp with LED	199.00	10/300
--------	--	--------	--------

206163	Divine Glow - Maha Laxmi edge glow night lamp with LED	199.00	10/300
--------	--	--------	--------

206164	Divine Glow - Tirupati Balaji edge glow night lamp with LED	199.00	10/300
--------	---	--------	--------

206165	Divine Glow - Guru Nanak edge glow night lamp with LED	199.00	10/300
--------	--	--------	--------

206166	Divine Glow - Azaan edge glow night lamp with LED	199.00	10/300
--------	---	--------	--------

206169	G-Focus Night Lamp G-focus night lamp with LED	235.00	10/300
--------	---	--------	--------

206170 A*	G-Divine Shri Parashwanath edge glow night lamp with LED	NEW 230.00	5/100
-----------	--	-------------------	-------

206170 B*	G-Divine Lord Ganesha edge glow night lamp with LED	NEW 230.00	5/100
-----------	---	-------------------	-------

206170 C*	G-Divine Maha Laxmi edge glow night lamp with LED	NEW 230.00	5/100
-----------	---	-------------------	-------

206170 D*	G-Divine Tirupati Balaji edge glow night lamp with LED	NEW 230.00	5/100
-----------	--	-------------------	-------

206170 E*	G-Divine Guru Nanak edge glow night lamp with LED	NEW 230.00	5/100
-----------	---	-------------------	-------

206170 F*	G-Divine Azaan edge glow night lamp with LED	NEW 230.00	5/100
-----------	--	-------------------	-------

SELF ADHESIVE PVC ELECTRICAL INSULATION TAPE

06325	PVC Electrical Insulation Tap Size: 0.13mm x 18mm x 7mtr.	18.20	30/600
-------	--	-------	--------

* introducing shortly

MORE WAYS TO POWER YOUR DREAMS!



Spice
3 Pin Universal Travel Adaptor
with indicator



Fusion 16A 3 Pin Plug
LDS System & safe gripper



Avian 16A 3 Pin Plug
LDS System & safe gripper



Ecco Angle Holder
Advanced interlock configuration



Ecco Batten Holder
Advanced interlock configuration



Curve plus



202021



202022

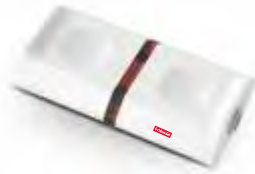

202024



202026



202027



202028



202029



202030



202031



202037



202038



202039/40



202042



202043



202044



202047



201001



201002



201003



201004

Code	Item	MRP ₹	Pkg. Out/Master
------	------	-------	--------------------

PLUG TOPS 240V~

202021	6A 2 Pin plug LDS System & safe gripper	24.00	20/1200
202022	G-mint 6A 2 Pin plug LDS System & safe gripper	27.00	20/1200
202024	G-mint 6A 2 Pin Male Female LDS System & safe gripper	48.00	20/800

PLUG TOPS 240V~

202026	Avian 6A 3 Pin Plug LDS System & safe gripper	67.00	20/600
202027	Avian 16A 3 Pin Plug LDS System & safe gripper	80.00	10/300
202028	Fusion 6A 3 Pin Plug LDS System & safe gripper	69.00	20/600
202029	Fusion 16A 3 Pin Plug LDS System & safe gripper	82.00	10/300
202030	G-grip 6A 3 Pin Plug with LED LDS System & safe gripper	82.00	20/600
202031	G-grip 16A 3 Pin Plug with LED LDS System & safe gripper	96.00	10/300

UNIVERSAL TRAVEL ADAPTOR 240V~

202037	i-Link 16A 3 Pin Universal Travel Adaptor with Mobile Socket	183.00	10/120
202038	Sliq 2 Pin Conversion plug	24.00	30/1200
202039	Sliq 3 Pin Universal Travel Adaptor with Indicator*	73.00	20/300
202040	Sliq 3 Pin Universal Travel Adaptor with Indicator & surge protector*	130.00	20/300
202042	Spice 3 Pin Universal Travel Adaptor with Indicator	123.00	10/300
202043	G-cube 2 Pin Universal Travel Adaptor with surge protector	158.00	20/300
202044	G-dot 2 Pin Universal Travel Adaptor with surge protector	170.00	20/300
202045	G-cube 2 Pin Universal Travel Adaptor	76.00	20/300
202046	G-dot 2 Pin Universal Travel Adaptor	87.00	20/300
202047	Genius USB Travel Adaptor 2 USB Port with 3 International Plug	918.00	10/120

* Suitable for all kinds of plugs used around the world

LAMP HOLDER 240V~

201001	Oro Angle Holder Advanced interlock configuration	53.00	20/400
201002	Oro Batten Holder Advanced interlock configuration	53.00	20/400
201003	Ecco Angle Holder Advanced interlock configuration	54.00	20/400
201004	Ecco Batten Holder Advanced interlock configuration	54.00	20/400

Code	Item	MRP ₹	Pkg. Out/Master
------	------	-------	--------------------

LAMP HOLDER 240V~

201005	Angle Holder Advanced interlock configuration	45.00	20/400
201006	Batten Holder Advanced interlock configuration	45.00	20/400
201007	Jumbo Batten Holder Advanced interlock configuration	53.00	20/400
201008	Ecco Gama Batten Holder Advanced interlock configuration	64.00	20/400
201010	Gzifa Angle Holder Advanced interlock configuration	56.00	20/400
201011	Gzifa Batten Holder Advanced interlock configuration	56.00	20/400
201012	Oval Angle Holder Advanced interlock configuration	68.00	10/300
201013	Oval Batten Holder Advanced interlock configuration	68.00	10/300
201009	Glassio Angle Holder Advanced interlock configuration	68.00	10/300
201014	Glassio Batten Holder Advanced interlock configuration	69.00	10/300
201019	Euro Angle Holder Advanced interlock configuration	73.00	10/300
201020	Euro Batten Holder Advanced interlock configuration	73.00	10/300



CEILING ROSE 240V~

201016	Pilot Ceiling Rose Auto safe lock	39.00	20/600
201017	Jumbo Ceiling Rose Auto safe lock	47.00	20/400
201018	Glassio Ceiling Rose Auto safe lock	59.00	20/400



GIFA LAMP HOLDER / CELING ROSE 240V~

GF02101	Zuloo Angle Holder (Plastic) Advanced interlock configuration	53.00	20/400
GF02102	Zuloo Batten Holder (Plastic) Advanced interlock configuration	53.00	20/400
GF02103	Igloo Angle Holder (Metal) Advanced interlock configuration	54.00	20/400
GF02104	Igloo Batten Holder (Metal) Auto safe lock	54.00	20/400
GF02116	Pilot Ceiling Rose Auto safe lock	39.00	20/600
GF02117	Jumbo Ceiling Rose Auto safe lock	47.00	20/400





GIFA[®]
live innovative



Add a bit of the natural world to your interiors with these cover plates in wood accents. Whether it's light or dark wood, adding a bit of this wondrous material makes any interior feel warmer and inviting. The African Wenge wood cover plate has a majestic, luxurious appeal to it while the Fumed Oak and Rose Wood cover plates are modern and cheerful in their appearances. Combine them with the inserts of your choice to create that distinctive look for your interiors.



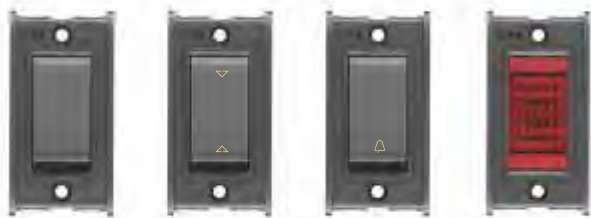

Code	Item	MRP ₹		Pkg.
		White	Metallic/Grey Out/Master	

10AX SWITCHES / 6A INDICATOR

GF 14101	1 Way Switch	18.00	20.00	20/1200
GF 14102	2 Way Switch	30.00	33.00	20/1200
GF 14103	Bell Push Switch	30.00	33.00	20/1200
GF 14104	Indicator (LED)	30.00	33.00	20/1200

6AMP BELL PUSH 240V~

GF 14116	Bell Push with Luminous Name Plate 240V~ 50-60Hz LED circuit with diffuser	132.00	146.00	10/600
----------	---	--------	--------	--------

6A & 10A SOCKETS / 13A INTERNATIONAL SOCKET

GF 14118	6A 2 Pin Socket with safety shutter	33.00	36.00	20/600
GF 14119	10A 2 In One Socket	39.00	43.00	10/600
GF 14121	10A International Socket with safety shutter	58.00	63.00	10/600

TV ANTENNA SOCKETS

GF 14125	Mini TV Antenna Socket with card-grip configuration	48.00	53.00	20/1200
GF 14126	Medium TV Antenna Socket with card-grip configuration	51.00	56.00	20/1000

ELECTRONIC DIMMER / GALAXY REGULATOR 240V~

GF 14129	300W Mini Dimmer	170.00	187.00	10/600
GF 14130	300W Medium Dimmer	185.00	203.00	10/300
GF 14131	EME 4 Step Fan Regulator	260.00	285.00	10/600
GF 14132	Galaxy 5 Step Fan Regulator - Full Rotary	285.00	315.00	10/300
GF 14133	Galaxy 5 Step Fan Regulator - Half Rotary	285.00	315.00	10/300

GALAXY REGULATOR WITH CHROME KNOB 240V~

GF 14134	Galaxy 5 Step Fan Regulator - Full Rotary	295.00	325.00	10/300
GF 14135	Galaxy 5 Step Fan Regulator - Half Rotary	295.00	325.00	10/300

Code	Item	MRP ₹		Pkg.
		White	Metallic/Grey Out/Master	
RJ-11 TELEPHONE JACK / RJ-45 MODEM JACK				
GF 14138	RJ-11 2 Line Telephone Jack	70.00	77.00	20/1200
GF 14139	RJ-11 4 Line Telephone Jack	94.00	103.00	10/600
GF 14140	RJ-45 Outlet for Computer (Cat 6e) Category 6e, Universal wiring T568A, insulating-piercing terminal	240.00	264.00	10/600
KIT-KAT FUSE / LED NIGHT LAMP				
GF 14144	Kit-Kat Fuse (Suitable for both 10A & 16A)	57.00	62.00	10/600
GF 14150	Night Lamp (LED)	132.00	145.00	10/600
10AMP SWITCH SOCKET COMBINED 240V~				
GF 14151*	10A Switch Socket Combined (with indicator)	72.00	78.00	5/200
GF 14152*	10A Switch Socket Combined with Junction Box (with indicator)	94.00	102.00	10/200
20AMP SWITCHES / GAMA SWITCHES 240V~				
GF 14153	20A 1 Way Switch	99.00	109.00	10/300
GF 14154	20A 2 Way Switch	112.00	122.00	10/300
GF 14155	20A Gama 1 Way Switch with indicator	112.00	122.00	10/300
GF 14156	20A Gama 2 Way Switch	133.00	146.00	10/300
10AX GAMA BELL PUSH / 6&16A SOCKET 240V~				
GF 14157	10AX Gama Bell Push with indicator	82.00	90.00	10/300
GF 14158	6&16A Universal Socket with safety shutter	105.00	115.00	10/300
32AMP DP SWITCH 240V~				
GF 14161	32AMP DP Switch with indicator	180.00	198.00	10/300



*introducing shortly



Code	Item	MRP ₹		Pkg.
		White	Metallic/Grey Out/Master	
6&16A 3 IN ONE COMBINED 240V~				
GF 14165	6&16A 3 In One Switch Socket Combined	191.00	210.00	5/150
GF 14166	6&16A 3 In One Switch Socket Combined with junction box with safety shutter	220.00	240.00	5/150
6&16A 5 IN ONE COMBINED 240V~				
GF 14167	6&16A 5 In One Switch Socket Combined with fuse & indicator	239.00	260.00	5/100
GF 14168	6&16A 5 In One Combined with junction box with safety shutter	275.00	302.00	5/100

Code	Item	MRP ₹	Pkg.
------	------	-------	------

White/Grey/Out/Master

10AX SWITCH COVER PLATES

GF 14175	Platina	4.25	100/8000
GF 14176	Metaliq	6.75	100/8000
GF 14177	Wood	7.25	100/8000

SUITABLE FOR:
10AX Switches, Indicator, Mini Jack, Mini Dimmer,
Mini Step Regulator & Fuse Unit etc.



10A SOCKET COVER PLATES

GF 14181	Platina	5.75	100/6000
GF 14182	Metaliq	8.50	100/6000
GF 14183	Wood	9.25	100/6000

SUITABLE FOR :
10A Sockets, Bell Push, Night Lamp, Med Dimmer,
5 Step Regulator & 4 Line Telephone Jack etc.



10A S S COMBINED COVER PLATES

GF 14184*	Platina	25.00	50/1200
GF 14185*	Metaliq	32.00	50/1200
GF 14186*	Wood	36.00	50/1200

SUITABLE FOR : 10 Switch Socket Combined



20A SWITCH COVER PLATES

GF 14187	Platina	17.50	50/3000
GF 14188	Metaliq	24.00	50/3000
GF 14189	Wood	27.00	50/3000

SUITABLE FOR : 20A Switches



16A SOCKET COVER PLATES

GF 14193	Platina	20.00	50/2400
GF 14194	Metaliq	27.00	50/2400
GF 14195	Wood	30.00	50/2400

SUITABLE FOR :
20A Gama Switch, 10AX Gama Bell Push &
32A DP Switch etc.



3 IN ONE COVER PLATES

GF 14199	Platina	29.00	25/1500
GF 14200	Metaliq	37.00	25/1500
GF 14201	Wood	41.00	25/1500

SUITABLE FOR : 3 In One Combined



5 IN ONE COVER PLATES

GF 14205	Platina	39.00	25/1200
GF 14206	Metaliq	52.00	25/1200
GF 14207	Wood	60.00	25/1200

SUITABLE FOR : 5 In One Combined



AVAILABLE COLOURS IN BASE :
Digital Silver, White Jazz & Carbon Grey

AVAILABLE COLOURS IN PLATES

Platina : White Jazz & Ivory

MetaliQ : Gold, Digital Silver, Olive Green & Copper Cola

wood : Fumed Oak, African Wenge & Rose Wood

*introducing shortly



BREAK
AWAY
FROM THE
PAST.
SWITCH
TO THE
FUTURE!

GEN. NEXT MINI MODULAR



There comes a time when the tide changes. When the old makes for the new. Gzifa marks the beginning of this transition in the world of mini modular switches and accessories.

With its radical new styling and a host of exciting features, Gzifa promises to be the new benchmark in mini modular products.

Gzifa. It's a sign of the changing times.

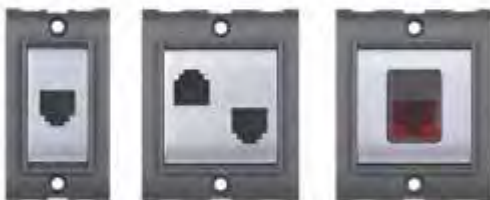

Code	Item	MRP ₹		Pkg.
		White/Grey	D.Silver	

10AX SWITCHES / 6A INDICATOR

14101	1 Way Switch	18.00	20.00	20/1200
14102	2 Way Switch	30.00	33.00	20/1200
14103	Bell Push Switch	30.00	33.00	20/1200
14104	Indicator (LED)	30.00	33.00	20/1200

6AMP BELL PUSH 240V~

14116	Bell Push with Luminous Name Plate 240V~ 50-60Hz LED circuit with diffuser	132.00	146.00	10/600
-------	---	--------	--------	--------

6A & 10A SOCKETS / 13A INTERNATIONAL SOCKET

14118	6A 2 Pin Socket with safety shutter	33.00	36.00	20/1200
14119	10A 2 In One Socket	39.00	43.00	10/600
14121	10A International Socket with safety shutter	58.00	63.00	10/600

TV ANTENNA SOCKETS

14125	Mini TV Antenna Socket with card-grip configuration	48.00	53.00	20/1200
14126	Medium TV Antenna Socket with card-grip configuration	51.00	56.00	20/1000

ELECTRONIC DIMMER / REGULATOR 240V~

14129	300W Mini Dimmer	170.00	187.00	10/600
14130	300W Medium Dimmer	185.00	203.00	10/300
14131	EME 4 Step Fan Regulator	260.00	285.00	10/600
14132	EME 5 Step Fan Regulator - Regulator Supplied in ISI & Non ISI	285.00	315.00	10/300

RJ-11 TELEPHONE JACK / RJ-45 MODEM JACK

14138	RJ-11 2 Line Telephone Jack	70.00	77.00	20/1200
14139	RJ-11 4 Line Telephone Jack	94.00	103.00	10/600
14140	RJ-45 Outlet for Computer (Cat 6e) Category 6e, Universal wiring T568A, insulating-piercing terminal	240.00	264.00	10/600

KIT-KAT FUSE / LED NIGHT LAMP

14144	Kit-Kat Fuse (Suitable for both 10A & 16A)	57.00	62.00	10/600
14150	Night Lamp (LED)	132.00	145.00	10/600

Code	Item	MRP ₹		Pkg.
		White/Grey	D.Silver	

10AMP SWITCH SOCKET COMBINED 240V~

14151	10A Switch Socket Combined (with indicator)	72.00	78.00	10/200
14152	10A Switch Socket Combined with Junction Box (with indicator)	94.00	102.00	10/200



20AMP SWITCHES / GAMA SWITCHES 240V~

14153	20A 1 Way Switch	99.00	109.00	10/300
14154	20A 2 Way Switch	112.00	122.00	10/300
14155	20A Gama 1 Way Switch with indicator	112.00	122.00	10/300
14156	20A Gama 2 Way Switch	133.00	146.00	10/300



10AX GAMA BELL PUSH / 6&16A SOCKET 240V~

14157	10AX Gama Bell Push with indicator	82.00	90.00	10/300
14158	6&16A Universal Socket with safety shutter	105.00	115.00	10/300



32AMP DP SWITCH 240V~

14161	32AMP DP Switch with indicator	180.00	198.00	5/300
-------	-----------------------------------	--------	--------	-------



6&16A 3 IN ONE COMBINED 240V~

14165	6&16A 3 In One Switch Socket Combined	191.00	210.00	5/150
14166	6&16A 3 In One Switch Socket Combined with junction box with safety shutter	220.00	240.00	5/150



6&16A 5 IN ONE COMBINED 240V~

14167	6&16A 5 In One Switch Socket Combined with fuse & indicator	239.00	260.00	5/100
14168	6&16A 5 In One Combined with junction box with safety shutter	275.00	302.00	5/100





AVAILABLE
COLOURS
IN PLATES

Platina : White Jazz & Ivory
Metaliq : Gold, Digital Silver, Forest Green, Copper Cola, Dark Night & Pearl Grey
wood : Fumed Oak, African Wenge & Rose Wood

Note: The wood cover plates may differ in their shades as they reflect a natural look.

Code	Item	MRP ₹	Pkg. Out/Master
------	------	-------	--------------------

10AX SWITCH COVER PLATES

14175	Platina	4.25	100/8000
14176	Metaliq	6.75	100/8000
14177	Wood	7.25	100/8000

SUITABLE FOR:
10AX Switches, Indicator, Mini Jack, Mini Dimmer,
Mini Step Regulator & Fuse Unit etc.

10A SOCKET COVER PLATES

14181	Platina	5.75	100/6000
14182	Metaliq	8.50	100/6000
14183	Wood	9.25	100/6000

SUITABLE FOR :
10A Sockets, Bell Push, Night Lamp, Med Dimmer,
5 Step Regulator & 4 Line Telephone Jack etc.

10A S S COMBINED COVER PLATES

14184	Platina	25.00	50/1200
14185	Metaliq	32.00	50/1200
14186	Wood	36.00	50/1200

SUITABLE FOR : 10A Switch Socket Combined

20A SWITCH COVER PLATES

14187	Platina	17.50	50/3000
14188	Metaliq	24.00	50/3000
14189	Wood	27.00	50/3000

SUITABLE FOR : 20A Switches

16A SOCKET COVER PLATES

14193	Platina	20.00	50/2400
14194	Metaliq	27.00	50/2400
14195	Wood	30.00	50/2400

SUITABLE FOR :
20A Gama Switch, 10AX Gama Bell Push &
32A DP Switch etc.

3 IN ONE COVER PLATES

14199	Platina	29.00	25/1500
14200	Metaliq	37.00	25/1500
14201	Wood	41.00	25/1500

SUITABLE FOR : 3 In One Combined

5 IN ONE COVER PLATES

14205	Platina	39.00	25/1200
14206	Metaliq	52.00	25/1200
14207	Wood	60.00	25/1200

SUITABLE FOR : 5 In One Combined

AVAILABLE COLOURS IN BASE :
Digital Silver, White Jazz & Monsoon Grey



More choices for elegant homes.

Essenza presents economy polycarbonate switches and accessories in three pleasing, options: Vanilla, iCube and Valley. Designed without compromise in a rich, off-white shade, these options can be the ideal choice for elegant homes. The Vanilla switches with their distinct rounded shape presents a gentle profile while iCube and Valley, with their angular shapes, make a classical yet stylish statement.

essenza
Switches Redefined

Manufactured from polycarbonate by
SABIC Innovative Plastic USA





Code	Item	MRP ₹	Pkg.
------	------	-------	------

White/Brown Sugar Out/Master

ESSENZA 10AX VANILLA SWITCHES

09101	1 Way Switch	24.00	20/1200
09102	2 Way Switch	32.00	20/1200
09103	Bell Push	33.00	20/1200
09104	Indicator	32.00	20/1200

ESSENZA 10AX iCUBE SWITCHES

09105	1 Way Switch	23.00	20/1200
09106	2 Way Switch	30.00	20/1200
09107	Bell Push	30.00	20/1200
09108	Indicator	30.00	20/1200

ESSENZA 10AX VALLEY SWITCHES

09109	1 Way Switch	23.00	20/1200
09110	2 Way Switch	30.00	20/1200
09111	Bell Push	30.00	20/1200
09112	Indicator	30.00	20/1200

ESSENZA 6A / 10A SOCKETS

09124	2 Pin Socket with safety shutter	34.00	20/1200
09125	6A 2 In 1 Socket	39.00	10/600
09126	10A International Socket with safety shutter	61.00	10/600
09127	6A 5 Pin Socket	47.00	10/600

ESSENZA TV SOCKETS

09130	Mini TV Socket	45.00	20/1200
09131	Medium TV Socket	41.00	20/800

ESSENZA DIMMER / REGULATOR

09134	Mini Dimmer	228.00	10/600
09135	Medium Dimmer	244.00	10/300
09136	4 Step Regulator	314.00	10/600
09137	5 Step Regulator	347.00	10/300

- Regulator Supplied in ISI & Non ISI

ESSENZA G-STAR DIMMER / REGULATOR

09138	G-star Medium Dimmer	239.00	10/300
09139	G-star 4 Step Regulator	314.00	10/600
09140	G-star 5 Step Regulator	347.00	10/300

- Regulator Supplied in ISI & Non ISI

Code	Item	MRP ₹	Pkg.
------	------	-------	------

White/Brown Sugar Out/Master

ESSENZA TEL. JACK / KIT-KAT FUSE

09143	Mini Tel Jack	77.00	20/1200
09144	Medium 4 Line Tel Jack	77.00	20/800
09147	Kit-Kat Fuse (Suitable for both 10A & 16A)	61.00	20/800



ESSENZA 6A / 10A S. S. COMBINED

09151	10A 8x1 S.S. Combined with Indicator (with junction box)	238.00	5/100
09152	10A S.S. Combined with Indicator	84.00	10/200
09153	10A S.S. Combined with Indicator (with junction box)	112.00	10/200



ESSENZA NANO 20A SWITCH (PORCELAIN BASE)

09154	Nano 20A 1 Way Switch	116.00	10/200
09155	Nano 20A 2 Way Switch with Porcelain Base	134.00	10/200



ESSENZA 20A SWITCH / 16A SOCKET (PORCELAIN BASE)

09156	20A 1 Way Switch	116.00	10/200
09157	20A 2 Way Switch	134.00	10/200
09158	20A Gama Switch with Indicator	138.00	10/200
09159	20A Gama 2 Way Switch	158.00	10/200
09160	Gama 10A Bellpush with Indicator	102.00	10/200
09161	6 & 16A Universal Socket with safety shutter & Porcelain Base	116.00	10/200



ESSENZA SURFACE GANG BOXES / 32A DP SWITCH

09164	16A Surface Box (Suitable for Switch/Socket/DP/Gama Switch)	34.00	10/200
09174	32A DP Switch with Indicator with Porcelain Base	218.00	10/200



ESSENZA 3 IN 1 COMBINED (PORCELAIN BASE)

09178	3 In 1 S.S. Combined with safety shutter	180.00	5/150
09179	3 In 1 S.S. Combined with Junction Box (with safety shutter)	224.00	5/150



ESSENZA 5 IN 1 COMBINED (PORCELAIN BASE)

09183	5 In 1 S.S. Combined with Fuse & Indicator (with safety shutter)	250.00	5/80
09184	5 In 1 S.S. Combined with Fuse, Indicator & Junction Box (with safety shutter)	305.00	5/80





Code	Item	MRP ₹	Pkg.
------	------	-------	------

White/Brown Square/Master

ESSENZA NANO 20A SWITCH

09154A	Nano 20A 1 Way Switch	116.00	10/200
09155A	Nano 20A 2 Way Switch	134.00	10/200

ESSENZA 20A SWITCH / 16A SOCKET

09156A	20A 1 Way Switch	116.00	10/200
09157A	20A 2 Way Switch	134.00	10/200
09158A	20A Gama Switch with Indicator	138.00	10/200
09159A	20A Gama 2 Way Switch	158.00	10/200
09160A	Gama 10A Bellpush with Indicator	102.00	10/200
09161A	6 & 16A Universal Socket with safety shutter	116.00	10/200

ESSENZA SURFACE GANG BOXES / 32A DP SWITCH

09164A	16A Surface Box (Suitable for Switch/Socket/DP/Gama Switch)	36.00	10/200
09174A	32A DP Switch with Indicator	218.00	10/200

ESSENZA 3 IN 1 COMBINED

09178A	3 In 1 S.S. Combined with safety shutter	180.00	5/150
09179A	3 In 1 S.S. Combined with Junction Box (with safety shutter)	224.00	5/150

ESSENZA 5 IN 1 COMBINED

09183A	5 In 1 S.S. Combined with Fuse & indicator (with safety shutter)	250.00	5/80
09184A	5 In 1 S.S. Combined with Fuse, Indicator & Junction Box (with safety shutter)	305.00	5/80

ESSENZA 6 IN 1 COMBINED

09185	6 In 1 S.S. Combined with Fuse & indicator with safety shutter	276.00	5/90
09186	6 In 1 S.S. Combined with Fuse, Indicator & Junction Box (with safety shutter)	332.00	5/90

ESSENZA LAMP HOLDER / BED SWITCH

09188	Angle Holder	43.00	20/400
09189	Batten Holder	43.00	20/400
09190	Bed Switch	50.00	20/1200
09191	Skirt Pendant Holder	36.00	30/600

Advanced interlock configuration

Code	Item	MRP ₹	Pkg.
------	------	-------	------

ESSENZA CEILING ROSE			
09192	Pilot Ceiling Rose (3 parts)	35.00	20/600
09193	Jumbo Ceiling Rose Auto safe lock	41.00	20/400



ESSENZA 32A VANILLA D. P. SWITCH			
09195	Surface D. P. Switch With Indicator (Unbreakable)	210.00	5/100
09196	Flush D. P. Switch With Indicator (Unbreakable)	210.00	5/100
09197	Nano Surface D. P. Switch With Indicator	199.00	5/100



ESSENZA EXTENSION CORDS 240V~			
09201	Flexi 2 Pin 5 Mtr Cable master switch, indicator & international socket	351.00	5/60
09202	Flexi 2 Pin 7.5 Mtr Cable master switch, indicator & international socket	444.00	5/60
09203	Flexi 3 Pin 4 Mtr Cable master switch, indicator & international socket	444.00	5/60



ESSENZA POWER STRIP 240V~			
09207	Plugged-IN 4x4 Power Strip with USB outlet 3 outlet international sockets & Dual USB charger with individual switch & indicator	1372.00	5/30
09208	Plugged-IN 4x1 Power Strip 4 Outlet Socket Adapter master switch, indicator & international socket	572.00	5/30
09209	Plugged-IN 4x4 Power Strip 4 Outlet Socket Adapter individual switch, indicator & international socket	865.00	530
09210	Plugged-IN 4x1 Power Strip 4 Outlet Socket Adapter with 5 Mtrs Cable master switch, indicator & international socket	937.00	5/30



ESSENZA SPIKE GUARD 240V~			
09211	Plugged-IN 6x1 Spike Guard 6 Outlet Socket Adapter master switch, indicator, Surge Protector & international socket	919.00	5/30



ESSENZA PLUG TOPS 240V~			
09226	Unite 6A 2 Pin Plug LDS System & safe gripper	24.00	20/1200
09227	Unite 6A 2 Pin Male Female LDS System & safe gripper	47.00	20/800



Gazelle Wood panels provide all the flexibility you need to install switches and other electrical modules. Its snap - fix frame is easy to use and available in three colors to match your interiors. Designed for durability, the Gazelle Wood panels deliver outstanding performance and reliability.



gazelle
WOOD PLATES



True beauty that delights
the heart, the mind and the soul.



You love your home. We love to help.

CUB / CAPSULE / SUMO



Code	Item	MRP ₹	Pkg. Out/Master
------	------	-------	--------------------

6A CUB SWITCH / INDICATOR

GL101	1 Way Switch	23.00	20/1200
GL102	2 Way Switch	30.00	20/1200
GL104	Bell Push	30.00	20/1200
GL105	Indicator	30.00	20/1200

6A CAPSULE SWITCH / INDICATOR

GL106	1 Way Switch	23.00	20/1200
GL107	2 Way Switch	30.00	20/1200
GL109	Bell Push	30.00	20/1200
GL110	Indicator	30.00	20/1200

6A SOCKET

GL119	2 Pin Socket	29.00	20/1200
GL120	2-in-1 Socket	43.00	10/600

KIT-KAT FUSE

GL123	Cub 10A Kit-Kat Fuse	51.00	20/600
GL125	Cub 16A Kit-Kat Fuse	58.00	10/300

T.V. ANTENNA SOCKET

GL133	Mini T. V. Antenna Socket	34.00	20/600
-------	---------------------------	-------	--------

TELEPHONE JACK

GL139	Mini 2 Line Tel. Jack (modular)	70.00	20/600
-------	-----------------------------------	-------	--------

CUB ELECTRONIC DIMMER/FAN REGULATOR

GL144	300W Mini Dimmer	212.00	10/450
GL145	300W Medium Dimmer	223.00	10/300
GL146	4 step Fan Regulator (switch type)	312.00	10/300
GL147	5 Step Fan Regulator (socket type)	338.00	10/300

- Regulator Supplied in ISI & Non ISI

Code	Item	MRP ₹	Pkg. Out/Master
16A SWITCH / 6 & 16A. SOCKET			
GL150	Cub 1 Way Switch	103.00	10/200
GL151	Cub 2 Way Switch	114.00	10/200
GL152	Capsule 1 Way Switch	102.00	10/200
GL153	Capsule 2 Way Switch	114.00	10/200
GL154	6 & 16A Universal Socket	107.00	10/200



3-IN-ONE / WITH J. BOX			
GL155	Cub 3-in-One Universal Switch Socket Combined	164.00	5/100
GL156	Capsule 3-in-One Universal Switch Socket Combined	164.00	5/100
GL157	Cub / Capsule 3 in one with J. Box	201.00	5/100



5-IN-ONE / WITH J. BOX			
GL158	Cub 5-in-one Uni. Switch Socket Combined with Fuse & Indicator	229.00	5/60
GL159	Capsule 5-in-one Uni. Switch Socket Combined with Fuse & Indicator	229.00	5/60
GL160	Cub /Capsule 5 in one with J. Box	279.00	5/60



32 AMP. DELUXE D. P. SWITCH			
GL187	Deluxe Surface D. P. Switch with Indicator (unbreakable)	217.00	5/100
GL188	Deluxe Flush D. P. Switch with Indicator (unbreakable)	217.00	5/100
suitable for Cub, Capsule, Sumo & Olive series.			



CEILING ROSE / ADAPTOR			
GL191	Pilot Ceiling Rose (2 plate)	29.00	40/600
GL193	Jumbo Ceiling Rose (2 plate)	35.00	20/400
GL195	Adaptor	25.00	30/720



CAPSULE SKIRT LAMP HOLDER			
GL204	Capsule Angle Holder	35.00	20/400
GL205	Capsule Batten Holder	35.00	20/400
GL206	Skirt Pendent Holder	30.00	30/720



3 PIN PLUG TOP			
GL213	Cub 6A 3 Pin Top	60.00	20/600
GL214	Cub 16A 3 Pin Top	87.00	10/300





Code	Item	MRP ₹	Pkg. Out/Master
------	------	-------	--------------------

3 PIN PLUG TOP (POLYCARBONATE)

GL219	Glow 6A 3 Pin Top	65.00	20/600
GL220	Glow 16A 3 Pin Top	92.00	10/300

6A SUMO SWITCH / INDICATOR

GL231	1 Way Switch	27.00	20/1200
GL232	2 Way Switch	33.00	20/1200
GL233	Bell Push	33.00	20/1200
GL234	Indicator	33.00	20/1200

6A SUMO SOCKET

GL239	2 Pin Socket	30.00	20/1200
GL240	2-in-one Socket	44.00	10/600

SUMO KIT-KAT / TV ANTENNA SOCKET

GL243	10A Kit-Kat Fuse	49.00	20/600
GL244	16A Kit-Kat Fuse	63.00	10/300
GL247	Mini TV Antenna Socket	39.00	20/600

SUMO TELEPHONE JACK

GL252	Mini 2 Line Tel. Jack (Modular)	67.00	20/600
-------	-----------------------------------	-------	--------

SUMO ELECTRONIC DIMMER / FAN REG.

GL256	300W Mini Dimmer	218.00	10/450
GL257	300W Medium Dimmer	227.00	10/300
GL258	4 Step Fan Regulator (switch type)	320.00	10/300
GL259	5 Step Fan Regulator (socket type)	350.00	10/300
- Regulator Supplied in ISI & Non ISI			

16A SUMO SWITCH / 6 & 16A UNI. SOCKET

GL262	16A 1 Way Switch with Indicator	117.00	10/200
GL263	16A 2 Way Switch with Indicator	129.00	10/200
GL264	6 & 16A Universal Socket	118.00	10/200

Code	Item	MRP ₹	Pkg. Out/Master
------	------	-------	--------------------

SUMO 5-IN-ONE / WITH J. BOX

GL267	5-in-One Universal Switch Socket Combined with Fuse & Indicator	229.00	5/60
GL268	5-in-One with J. Box	279.00	5/60



SUMO SKIRT LAMP HOLDER

GL269	Angle Holder	36.00	20/400
GL270	Batten Holder	36.00	20/400



6A WA-WAH SWITCH / INDICATOR

GL273	1 Way Switch	27.00	20/1200
GL274	2 Way Switch	33.00	20/1200
GL276	Bell Push	33.00	20/1200
GL277	Indicator	33.00	20/1200



6A WA-WAH SOCKET

GL282	2 Pin Socket	30.00	20/1200
GL283	2-in-One Socket	44.00	10/600



WA-WAH KIT-KAT FUSE/TV ANTENNA SOCKET

GL286	10A Kit-Kat Fuse	49.00	20/600
GL287	16A Kit-Kat Fuse	63.00	10/300
GL288	Mini TV Antenna Socket	39.00	20/600



WA-WAH TELEPHONE JACK

GL291	Mini 2 Line Tel. Jack (modular)	69.00	20/600
-------	-----------------------------------	-------	--------



WA-WAH ELECTRONIC DIMMER / FAN REG.

GL296	300W Mini Dimmer	219.00	10/450
GL297	300W Medium Dimmer	230.00	10/300
GL299	5 Step Fan Regulator	354.00	10/300



- Regulator Supplied in ISI & Non ISI



Code	Item	MRP ₹	Pkg. Out/Master
------	------	-------	--------------------

16A WA-WAH SWITCH / 6 & 16A. SOCKET

GL302	16A 1 Way Switch	111.00	10/200
GL303	16A 2 Way Switch	123.00	10/200
GL304	6 & 16A Universal Socket	116.00	10/200

WA-WAH 3-IN-ONE/ WITH J. BOX

GL305	3-in-One Universal Switch Socket Combined	181.00	5/100
GL306	3-in-One with J. Box	222.00	5/100

WA-WAH 5-IN-ONE/ WITH J. BOX

GL307	5-in-One Universal Switch Socket Combined with Fuse & Indicator	235.00	5/60
GL308	5-in-One with J. Box	290.00	5/60

16A EURO SWITCH / 6 & 16A. SOCKET

GL352	16A 1 Way Switch	120.00	10/120
GL353	16A 2 Way Switch	131.00	10/120
GL354	6 & 16A Universal Socket	126.00	10/120

EURO 3-IN-ONE / 5-IN-ONE

GL355	3-in-One Universal Switch Socket Combined	206.00	5/60
GL356	5-in-One Universal Switch Socket Combined with Fuse & Indicator	293.00	5/60

3 IN ONE / 5 IN ONE WITH J. BOX

GL357	3-in-One Junction Box	64.00	5/60
GL358	5-in-One Junction Box	68.00	5/60
GL359	Euro 3-in-one with Junction Box	258.00	5/60
GL360	Euro 5-in-one with Junction Box	352.00	5/60

TUBE - LIGHT STARTER / ROTER HOLDER

GL369	Darling Starter with Heavy Duty Cap.	15.00	100/2400
GL376	16A Iron Connector (Porcelain Base)	89.00	20/200

16A PILOT SWITCH / SOC./ ROUND TOP

GL384	16A Surface 3Pin Socket (Round Black)	111.00	10/160
GL385	16A 3 Pin Top (Round Black)	101.00	20/240

Code **Item** **MRP ₹** **Pkg.**
Out/Master

2 PIN TOP / MALE FEMALE / MULTI PLUG

GL386	Flat 2 Pin Top	19.00	40/1800
GL387	Flat 2 Pin Male Female	33.00	40/960
GL392	Mak 6A 2 Pin Multi Plug	22.00	20/1000
GL393	Mak 6A 3 Pin Multi Plug	67.00	20/600



FLEX BOX

GL403	Round 2 Pin Flex Box 4 Mtr.	342.00	5/80
GL404	Round Safe 2 Pin Flex Box 8 Mtr.	449.00	5/80
GL405	Round Safe 3 Pin Flex Box 5 Mtr.	449.00	5/80



DING DONG BELL

GL422	Angel Ding Dong Bell	165.00	5/150
-------	----------------------	--------	-------



ELECTRONIC BIRD CHIME BELL

GL461	Cuckoo Bird Chime	259.00	5/60
GL462	Parrot Bird Chime	289.00	5/100
GL464	Buzzer	58.00	10/300
GL465	Mini Parrot Bird Chime	246.00	10/120



FOOT LIGHT PLATE

GL479	Moonlite (modular) New LED based multipurpose lighting system	595.00	5/80
-------	--	--------	------



MOUNTING JUNCTION BOX

GL484	16A Switch / Soc. J. Box	37.00	20/200
GL485	3-in-One J. Box	53.00	5/200
GL486	5-in-One J. Box	57.00	10/100
GL487	Sumo 4-in-One J. Box	56.00	10/100
GL488	Sumo 5-in-One J. Box	64.00	10/100



AC, MCB JUNCTION BOX

GL489	Round Junction Plate	11.00	50/2000
GL489A	Round Junction Plate (Dummy)	11.00	50/2000
GL490	Fansheet	36.00	50/400
GL491	Med Round Junction Plate	14.00	50/1000
GL502	MCB Enclosure (1-2 Plate)	55.00	10/200
GL503	MCB Enclosure (3-4 Plate)	80.00	5/100



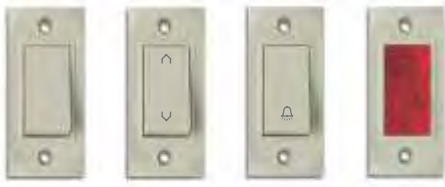

Code	Item	MRP ₹	Pkg. Out/Master
------	------	-------	--------------------

6A OLIVE SWITCH / INDICATOR

GL601	1 Way Switch	27.00	20/1200
GL602	2 Way Switch	35.00	20/1200
GL603	Bell Push	35.00	20/1200
GL604	Indicator	35.00	20/1200

6A OLIVE SOCKETS

GL609	2 Pin Socket	33.00	20/1200
GL610	2 in 1 Socket	44.00	10/600

OLIVE TV ANTENNA SOCKETS

GL613	Mini TV Antenna with cord-grip configuration	41.00	20/600
-------	---	-------	--------

OLIVE ELECTRONIC DIMMER / FAN REGULATOR

GL615	Mini Dimmer	215.00	10/450
GL616	Medium Dimmer	227.00	10/300
GL617	4 Step Fan Regulator <small>switch type</small>	320.00	10/300
GL618	5 Step Fan Regulator <small>socket type</small>	352.00	10/300

- Regulator Supplied in ISI & Non ISI

OLIVE TELEPHONE JACK

GL621	Mini 2 Line Tel. Jack <small>with enclosure</small>	71.00	20/600
-------	---	-------	--------

OLIVE KIT-KAT FUSE

GL625	10A Kit-kat Fuse	56.00	20/600
GL626	16A Kit-kat Fuse	64.00	10/300

16A OLIVE SWITCH / 6 & 16A. UNI. SOCKET

GL627	16A 1 Way Switch <small>with indicator</small>	121.00	10/200
GL628	16A 2 Way Switch <small>with indicator</small>	132.00	10/200
GL629	6 & 16 A Universal Socket <small>With Safety Shutter</small>	122.00	10/200

CAPS TO HIDE THE SCREW

Code	Item	MRP ₹	Pkg. Out/Master
------	------	-------	--------------------



16A OLIVE 4 IN ONE			
GL630	4-in-one Universal Switch Socket Combined with Indicator with safety shutter	206.00	5/100
GL631	4-in-one with Junction Box	248.00	5/100



16A OLIVE 5 IN ONE			
GL632	5-in-one Universal Switch Socket Combined with Fuse & Indicator (with safety shutter)	243.00	5/60
GL633	5-in-one with Junction Box	292.00	5/60



32A OLIVE D. P. SWITCH			
GL634	Surface D. P. Switch with indicator (unbreakable)	217.00	5/100
GL635	Flush D. P. Switch with indicator (unbreakable)	217.00	5/100



OLIVE SKIRT HOLDER / CEILING ROSE			
GL636	Angle Holder	35.00	20/400
GL637	Batten Holder	35.00	20/400
GL640	Pilot Ceiling Rose Unbreakable (3 Plate)	31.00	20/600
GL641	Jumbo Ceiling Rose Unbreakable (3 Plate)	34.00	20/400



POWER STRIP / SPIKE GUARD			
GL655	4 Outlet Power Strip (with international socket outlet)	542.00	5/60
GL656	6 Outlet Spike Adapter With Switch & Lamp (surge & spike protection with international socket outlet)	871.00	5/40

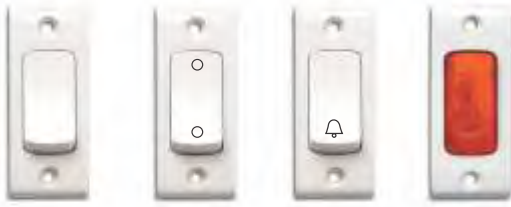

Code	Item	MRP ₹	Pkg. Out/Master
------	------	-------	--------------------

6A VAASTU SWITCH / INDICATOR

GL701	1 Way Switch	24.00	20/1200
GL702	2 Way Switch	30.00	20/1200
GL703	Bell Push	30.00	20/1200
GL704	Indicator	30.00	20/1200

6A INNOVA SWITCH / INDICATOR

GL705	1 Way Switch	23.00	20/1200
GL706	2 Way Switch	30.00	20/1200
GL707	Bell Push	30.00	20/1200
GL708	Indicator	30.00	20/1200

6A GENIUS SWITCH / INDICATOR

GL709	1 Way Switch	23.00	20/1200
GL710	2 Way Switch	28.00	20/1200
GL711	Bell Push	28.00	20/1200
GL712	Indicator	28.00	20/1200

6A EIKON SOCKETS

GL724	2 Pin Socket	32.00	20/1200
GL725	2-in-1 Socket	40.00	10/600

EIKON TV ANTENNA SOCKETS

GL731	Mini TV Antenna With Cord-grip Configuration	40.00	20/600
-------	---	-------	--------

EIKON ELECTRONIC DIMMER / FAN REGULATOR

GL735	Mini Dimmer	215.00	10/450
GL736	Medium Dimmer	227.00	10/300
GL737	4 Step Fan Regulator Switch Type	312.00	10/300
GL738	5 Step Fan Regulator Socket Type	343.00	10/300

- Regulator Supplied in ISI & Non ISI

EIKON TELEPHONE JACK

GL742	Mini 2 Line Tel. Jack With Enclosure	67.00	20/600
-------	---	-------	--------

Code	Item	MRP ₹	Pkg. Out/Master
EIKON KIT-KAT FUSE / 6A S S COMBINED			
GL746	10A Kit-Kat Fuse	48.00	20/600
GL747	16A Kit-Kat Fuse	61.00	10/300
GL749	6A S. S. Combine with Indicator & Junction Box	100.00	10/160
16A EIKON SWITCH / 6 & 16A UNI. SOCKET			
GL750	16A 1 Way Switch	114.00	10/200
GL751	16A 2 Way Switch	134.00	10/200
GL752	6 & 16A Universal Socket with Safety Shutter	118.00	10/200
16A EIKON 3 IN ONE / WITH J. BOX			
GL753	3-in-one Universal Switch Socket Combined with Safety Shutter	176.00	5/100
GL754	3-in-one with Junction Box	211.00	5/100
16A EIKON 5 IN ONE / WITH J. BOX			
GL755	5-in-one Universal Switch Socket Combined With Fuse & Indicator with Safety Shutter	244.00	5/60
GL756	5-in-one With Junction Box	288.00	5/60
EIKON SKIRT LAMP HOLDER			
GL770	Angle Holder (Unbreakable)	37.00	20/400
GL771	Batten Holder (Unbreakable)	37.00	20/400
GL772	Vaastu Angle Holder	28.00	20/400
GL773	Vaastu Batten Holder	28.00	20/400
EIKON CEILING ROSE			
GL774	Pilot Ceiling Rose Unbreakable (3 Plate)	35.00	20/600
GL775	Jumbo Ceiling Rose Unbreakable (3 Plate)	39.00	20/400





With **GOLDMEDAL**, you are in safe hands!

Safeguards human life
and property against
the hazards of electrical
mishaps.





Goldmedal
SWITCH TO THE AMAZING





Code	Item	Module	MRP ₹	Pkg. Out/Master
------	------	--------	-------	-----------------

ALLESSIO MINIATURE CIRCUIT BREAKER - 10kA C' CURVE - SP

02301	6A MCB	1	225.00	10/200
02302	10A MCB	1	225.00	10/200
02303	16A MCB	1	225.00	10/200
02304	20A MCB	1	225.00	10/200
02305	25A MCB	1	225.00	10/200
02306	32A MCB	1	225.00	10/200
02307	40A MCB	1	275.00	10/200
02308	63A MCB	1	340.00	10/200

ALLESSIO MINIATURE CIRCUIT BREAKER - 10kA C' CURVE - SPN

02311	6A MCB	2	494.00	6/120
02312	10A MCB	2	494.00	6/120
02313	16A MCB	2	494.00	6/120
02314	20A MCB	2	494.00	6/120
02315	25A MCB	2	494.00	6/120
02316	32A MCB	2	494.00	6/120
02317	40A MCB	2	665.00	6/120
02318	63A MCB	2	722.00	6/120

ALLESSIO MINIATURE CIRCUIT BREAKER - 10kA C' CURVE - DP

02320	6A MCB	2	530.00	6/120
02321	10A MCB	2	530.00	6/120
02322	16A MCB	2	530.00	6/120
02323	20A MCB	2	530.00	6/120
02324	25A MCB	2	530.00	6/120
02325	32A MCB	2	530.00	6/120
02326	40A MCB	2	699.00	6/120
02327	63A MCB	2	799.00	6/120

ALLESSIO MINIATURE CIRCUIT BREAKER - 10kA C' CURVE - TP

02330	6A MCB	3	795.00	4/80
02331	10A MCB	3	795.00	4/80
02332	16A MCB	3	795.00	4/80
02333	20A MCB	3	795.00	4/80
02334	25A MCB	3	795.00	4/80
02335	32A MCB	3	795.00	4/80
02336	40A MCB	3	1092.00	4/80
02337	63A MCB	3	1255.00	4/80

ALLESSIO MINIATURE CIRCUIT BREAKER - 10kA C' CURVE - TPN

02340	6A MCB	4	1022.00	3/60
02341	10A MCB	4	1022.00	3/60
02342	16A MCB	4	1022.00	3/60
02343	20A MCB	4	1022.00	3/60
02344	25A MCB	4	1022.00	3/60
02345	32A MCB	4	1022.00	3/60
02346	40A MCB	4	1403.00	3/60
02347	63A MCB	4	1486.00	3/60

Code	Item	Module	MRP ₹	Pkg.
------	------	--------	-------	------

Out/Master

ALLESSIO MINIATURE CIRCUIT BREAKER - 10kA C' CURVE - FP

02350	6A MCB	4	1109.00	3/60
02351	10A MCB	4	1109.00	3/60
02352	16A MCB	4	1109.00	3/60
02353	20A MCB	4	1109.00	3/60
02354	25A MCB	4	1109.00	3/60
02355	32A MCB	4	1109.00	3/60
02356	40A MCB	4	1450.00	3/60
02357	63A MCB	4	1750.00	3/60

IS/IEC:60898



ALLESSIO ISOLATOR - DP

02360	40A ISOLATOR	2	375.00	6/120
02361	63A ISOLATOR	2	487.00	6/120
02362	100A ISOLATOR	2	639.00	6/120

IS/IEC:60898



ALLESSIO ISOLATOR - TP

02368	40A ISOLATOR	3	561.00	4/80
02369	63A ISOLATOR	3	688.00	4/80
02370	100A ISOLATOR	3	932.00	4/80

IS/IEC:60898



ALLESSIO ISOLATOR - FP

02376	40A ISOLATOR	4	760.00	3/60
02377	63A ISOLATOR	4	880.00	3/60
02378	100A ISOLATOR	4	1146.00	3/60

IS/IEC:60898



AUTOMATIC CHANGEOVER WITH CURRENT LIMITER - SPN (ACCL)

NEW

02451	Mains 63A, Genset 1.5A - 300W	4	2399.00	3/30
02452	Mains 63A, Genset 2.5A - 500W	4	2399.00	3/30
02453	Mains 63A, Genset 3A - 600W	4	2399.00	3/30
02454	Mains 63A, Genset 4A - 800W	4	2399.00	3/30
02455	Mains 63A, Genset 5A - 1000W	4	2399.00	3/30
02456	Mains 63A, Genset 6A - 1200W	4	2399.00	3/30
02457	Mains 63A, Genset 9A - 1800W	4	2399.00	3/30
02458	Mains 63A, Genset 12A - 2400W	4	2399.00	3/30
02459	Mains 63A, Genset 15A - 3000W	4	2399.00	3/30
02460	Mains 63A, Genset 20A - 3000W	4	2399.00	3/30
02461	Mains 63A, Genset 30A - 6000W	4	2799.00	3/30





IS/IEC:60898



Code	Item	No of Modules			MRP ₹	Pkg. Out/Master
		Incomer	Sub Incomer	Outgoing		

ALLESSIO RCCB - DP

02400	25A RCCB 30mA			2	1950.00	6/120
02401	25A RCCB 100mA			2	1975.00	6/120
02402	25A RCCB 300mA			2	2000.00	6/120
02403	40A RCCB 30mA			2	2125.00	6/120
02404	40A RCCB 100mA			2	2175.00	6/120
02405	40A RCCB 300mA			2	2200.00	6/120
02406	63A RCCB 30mA			2	2700.00	6/120
02407	63A RCCB 100mA			2	2750.00	6/120
02408	63A RCCB 300mA			2	2800.00	6/120

ALLESSIO RCCB - FP

Module

02412	25A RCCB 30mA			4	2400.00	3/60
02413	25A RCCB 100mA			4	2550.00	3/60
02414	25A RCCB 300mA			4	2650.00	3/60
02415	40A RCCB 30mA			4	2550.00	3/60
02416	40A RCCB 100mA			4	2600.00	3/60
02417	40A RCCB 300mA			4	2700.00	3/60
02418	63A RCCB 30mA			4	2900.00	3/60
02419	63A RCCB 100mA			4	3000.00	3/60
02420	63A RCCB 300mA			4	3100.00	3/60

ALLESSIO 32A DP MCB WITH ENCLOSURE

02426	32A DP MCB with Enclosure				399.00	5/100
-------	---------------------------	--	--	--	--------	-------

ALLESSIO ROTARY SWITCH

02433	3 Ways - 40A				1080.00	1/40
02434	3 Ways - 63A				1120.00	1/40

ALLESSIO MINIATURE CIRCUIT BREAKER - 10kA B' CURVE - SP

NEW

02501	6A MCB			1	225.00	10/200
02502	10A MCB			1	225.00	10/200
02503	16A MCB			1	225.00	10/200
02504	20A MCB			1	225.00	10/200
02505	25A MCB			1	225.00	10/200
02506	32A MCB			1	225.00	10/200
02507	40A MCB			1	275.00	10/200
02508	63A MCB			1	340.00	10/200

Code	Item	No of Modules			MRP ₹	Pkg. Out/Master
		Incomer	Sub Incomer	Outgoing		

ALLESIO DOUBLE DOOR DB's - PLASTIC WITH METAL BASE						
04152	4 - 6 Ways	2	-	4	1432.00	1/10
04153	7 - 9 Ways	2	-	7	1706.00	1/10
04154	10 - 12 Ways	2	-	10	2020.00	1/10
04155	13 - 16 Ways	3	-	13	2403.00	1/5
04156	16 - 20 Ways	4	-	16	2806.00	1/5

Fireproof Plastic with transparent grey cover



ALLESIO SINGLE DOOR (METAL) DISTRIBUTION BOARD - IP30 - SPN						
04191	4 Ways	2	-	2	1055.00	1/12
04192	8 Ways	2	-	6	1320.00	1/9
04193	12 Ways	2	-	10	1565.00	1/9
04194	16 Ways	2	-	14	1950.00	1/6

- Conforms to IS 8623-1 & 3, IEC 61439-1 & 3 • IP-30.
- Suitable for Surface & Flush mounting. •Enclosure is made up of CRCA Sheet steel, RAL 9003 Powder coated, •with din rail, removable bus –bar, shrouded neutral/earth link with Conditional Short Circuit Rating of 15kA in SPN DB provided with isolable neutral link to carry out isolation test, also with high integrity/Clean Earth kit as accessory for electronic/IT installation to meet international safety standard DBs design with ample space for wiring. •There is a provision for DP MCB /Isolator/ RCCB/RCBO as incomer & SP MCBs as outgoing.



ALLESIO DOUBLE DOOR (METAL) DISTRIBUTION BOARD - IP43 - SPN						
04201	4 Ways	2	-	2	1550.00	1/9
04203	8 Ways	2	-	6	2000.00	1/6
04204	12 Ways	2	-	10	2400.00	1/6
04205	12 Ways	2	-	14	3000.00	1/6

- Conforms to IS 8623-1 & 3, IEC 61439-1 & 3 •Reversible Door for IP-43 & IK-09 Dbs. •Suitable for Surface & Flush mounting.
- Enclosure is made up of CRCA Sheet steel, RAL 9003 Powder coated, •with din rail, removable bus –bar, shrouded neutral/earth link with Conditional Short Circuit Rating of 15kA in SPN DB provided with isolable neutral link to carry out isolation test, also with high integrity/Clean Earth kit as accessory for electronic/IT installation to meet international safety standard DBs design with ample space for wiring. •There is a provision for DP MCB /Isolator/ RCCB/RCBO as incomer & SP MCBs as outgoing.



ALLESIO DOUBLE DOOR (METAL) DISTRIBUTION BOARD - IP43 - TPN						
04215	4 Ways	8	-	4+4+4	3650.00	1/6
04216	6 Ways	8	-	6+6+6	4450.00	1/6
04217	8 Ways	8	-	8+8+8	5350.00	1/3
04218	12 Ways	8	-	12+12+12	8000.00	1/1

- Conforms to IS 8623-1 & 3, IEC 61439-1 & 3 •Reversible door for IP-43 & IK-09 Dbs. •Suitable for Surface & Flush mounting.
- Enclosure is made up of CRCA Sheet steel, RAL 9003 Powder coated, •with din rail, removable bus –bar, shrouded neutral/earth link with Conditional Short Circuit Rating of 15kA in TPN DB provided with isolable neutral link to carry out isolation test, also with high integrity/Clean Earth kit as accessory for electronic/IT installation to meet international safety standard DBs design with ample space for wiring. •There is a provision for FP MCB /Isolator/ RCCB/RCBO as incomer & SP/TP MCBs as outgoing.





IS/IEC:60898



IS/IEC:60898



IS/IEC:60898



IS/IEC:60898



IS/IEC:60898



Code	Item	Module	MRP ₹	Pkg. Out/Master
ATLANTIC MINIATURE CIRCUIT BREAKER - 10kA C' CURVE - SP				
04301	6A MCB	1	210.00	10/200
04302	10A MCB	1	210.00	10/200
04303	16A MCB	1	210.00	10/200
04304	20A MCB	1	210.00	10/200
04305	25A MCB	1	210.00	10/200
04306	32A MCB	1	210.00	10/200
04307	40A MCB	1	235.00	10/200
04308	63A MCB	1	275.00	10/200
ATLANTIC MINIATURE CIRCUIT BREAKER - 10kA C' CURVE - SPN				
04311	6A MCB	2	360.00	6/120
04312	10A MCB	2	360.00	6/120
04313	16A MCB	2	360.00	6/120
04314	20A MCB	2	360.00	6/120
04315	25A MCB	2	360.00	6/120
04316	32A MCB	2	360.00	6/120
04317	40A MCB	2	500.00	6/120
04318	63A MCB	2	595.00	6/120
ATLANTIC MINIATURE CIRCUIT BREAKER - 10kA C' CURVE - DP				
04320	6A MCB	2	395.00	6/120
04321	10A MCB	2	395.00	6/120
04322	16A MCB	2	395.00	6/120
04323	20A MCB	2	395.00	6/120
04324	25A MCB	2	395.00	6/120
04325	32A MCB	2	395.00	6/120
04326	40A MCB	2	535.00	6/120
04327	63A MCB	2	630.00	6/120
ATLANTIC MINIATURE CIRCUIT BREAKER - 10kA C' CURVE - TP				
04330	6A MCB	3	647.00	4/80
04331	10A MCB	3	647.00	4/80
04332	16A MCB	3	647.00	4/80
04333	20A MCB	3	647.00	4/80
04334	25A MCB	3	647.00	4/80
04335	32A MCB	3	647.00	4/80
04336	40A MCB	3	809.00	4/80
04337	63A MCB	3	1035.00	4/80
ATLANTIC MINIATURE CIRCUIT BREAKER - 10kA C' CURVE - TPN				
04340	6A MCB	4	890.00	3/60
04341	10A MCB	4	890.00	3/60
04342	16A MCB	4	890.00	3/60
04343	20A MCB	4	890.00	3/60
04344	25A MCB	4	890.00	3/60
04345	32A MCB	4	890.00	3/60
04346	40A MCB	4	1070.00	3/60
04347	63A MCB	4	1290.00	3/60

* introducing shortly

Code	Item	Module	MRP ₹	Pkg.	Out/Master
------	------	--------	-------	------	------------

ATLANTIC MINIATURE CIRCUIT BREAKER - 10kA C' CURVE - FP					
04350	6A MCB	4	945.00	3/60	
04351	10A MCB	4	945.00	3/60	
04352	16A MCB	4	945.00	3/60	
04353	20A MCB	4	945.00	3/60	
04354	25A MCB	4	945.00	3/60	
04355	32A MCB	4	945.00	3/60	
04356	40A MCB	4	1100.00	3/60	
04357	63A MCB	4	1300.00	3/60	

IS/IEC:60898



ATLANTIC ISOLATOR - DP					
04360	40A Isolator	2	330.00	6/120	
04361	63A Isolator	2	399.00	6/120	
04362	100A Isolator	2	580.00	6/120	

IS/IEC:60898



ATLANTIC ISOLATOR - TP					
04368	40A Isolator	3	490.00	4/80	
04369	63A Isolator	3	590.00	4/80	
04370	100A Isolator	3	790.00	4/80	

IS/IEC:60898



ATLANTIC ISOLATOR - FP					
04376	40A Isolator	4	699.00	3/60	
04377	63A Isolator	4	799.00	3/60	
04378	100A Isolator	4	899.00	3/60	

IS/IEC:60898



ATLANTIC RCCB - DP					
04400	25A RCCB 30mA	2	1950.00	6/120	
04401	25A RCCB 100mA	2	1975.00	6/120	
04402	25A RCCB 300mA	2	2000.00	6/120	
04403	40A RCCB 30mA	2	2125.00	6/120	
04404	40A RCCB 100mA	2	2175.00	6/120	
04405	40A RCCB 300mA	2	2200.00	6/120	
04406	63A RCCB 30mA	2	2700.00	6/120	
04407	63A RCCB 100mA	2	2750.00	6/120	
04408	63A RCCB 300mA	2	2800.00	6/120	



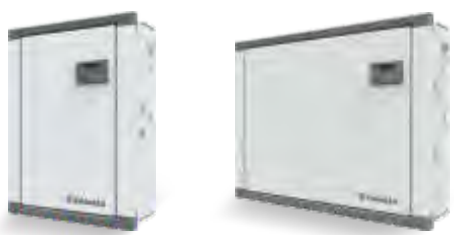

Code	Item	No of Modules			MRP ₹	Pkg. Out/Master
		Incomer	Sub Incomer	Outgoing		
ATLANTIC RCCB - FP					Module	
04412	25A RCCB 30mA			4	2400.00	3/60
04413	25A RCCB 100mA			4	2550.00	3/60
04414	25A RCCB 300mA			4	2650.00	3/60
04415	40A RCCB 30mA			4	2550.00	3/60
04416	40A RCCB 100mA			4	2600.00	3/60
04417	40A RCCB 300mA			4	2700.00	3/60
04418	63A RCCB 30mA			4	2900.00	3/60
04419	63A RCCB 100mA			4	3000.00	3/60
04420	63A RCCB 300mA			4	3100.00	3/60
ATLANTIC CHANGEOVER - DP					Module	
04430	25A Changeover			2	1215.00	6/120
04431	32A Changeover			2	1350.00	6/120
04432	40A Changeover			2	1485.00	6/120
ATLANTIC CHANGEOVER - FP					Module	
04435	25A Changeover			4	2295.00	3/60
04436	32A Changeover			4	2520.00	3/60
04437	40A Changeover			4	2745.00	3/60
ATLANTIC DOUBLE DOOR DISTRIBUTION BOARD - PLASTIC BASE						
04116	5 - 7 Ways	2	-	5	1096.00	1/16
04117	7 - 9 Ways	2	-	7	1285.00	1/16
04118	10 - 12 Ways	2	-	10	1549.00	1/10
04119	14 - 16 Ways	2	-	14	2085.00	1/10
04120	17 - 19 Ways	2	-	17	2318.00	1/10
ATLANTIC DOUBLE DOOR (METAL) DB (SPN) - IP42						
04451	4 Ways	2	-	2	1021.00	1/12
04455	6 Ways	2	-	4	1160.00	1/12
04452	8 Ways	2	-	6	1407.00	1/8
04453	12 Ways	2	-	10	1840.00	1/8
04454	16 Ways	2	-	14	2179.00	1/6

•Conforms to IS 8623-1 & 3, IEC 61439-1 & 3 •Reversible Door for IP-42 & IK-09 Dbs.
 •Suitable for Surface & Flush mounting. •Enclosure is made up of CRCA Sheet steel, RAL 7035 Powder coated, •with din rail, removable bus-bar, shrouded neutral/earth link with Conditional Short Circuit Rating of 15kA in SPN DB provided with isolable neutral link to carry out isolation test, also with high integrity/Clean Earth kit as accessory for electronic/IT installation to meet international safety standard DBs design with ample space for wiring. •There is a provision for DP MCB /Isolator/ RCCB/RCBO as incomer & SP MCBs as outgoing.

Code	Item	No of Modules			MRP ₹	Pkg. Out/Master
		Incomer	Sub Incomer	Outgoing		

ATLANTIC DOUBLE DOOR (METAL) DB (TPN) - IP42

04465	4 Ways	4	-	4+4+4	2850.00	1/4
04466	6 Ways	4	-	6+6+6	3400.00	1/4
04467	4 Ways	8	-	4+4+4	3000.00	1/4
04468	6 Ways	8	-	6+6+6	3450.00	1/4
04469	8 Ways	8	-	8+8+8	4070.00	1/3
04470	12 Ways	8	-	12+12+12	5650.00	1/1

•Conforms to IS 8623-1 & 3, IEC 61439-1 & 3 •Reversible door for IP-42 & IK-09 Dbs.
•Suitable for Surface & Flush mounting. •Enclosure is made up of CRCA Sheet steel, RAL 7035 Powder coated, •with din rail, removable bus –bar, shrouded neutral/earth link with Conditional Short Circuit Rating of 15kA in TPN DB provided with isolable neutral link to carry out isolation test, also with high integrity/Clean Earth kit as accessory for electronic/IT installation to meet international safety standard DBs design with ample space for wiring. •There is a provision for FP MCB /Isolator/ RCCB/RCBO as incomer & SP/TP MCBs as outgoing.



ATLANTIC DOUBLE DOOR (METAL) DB TPN PHASE SELECTOR 40A - IP-42

04479	4 Ways	8	-	4+4+4	9000.00	1/1
04480	6 Ways	8	-	6+6+6	9200.00	1/1
04481	8 Ways	8	-	8+8+8	9700.00	1/1
04482*	12 Ways	8	-	12+12+12	13000.00	1/1



ATLANTIC DOUBLE DOOR (METAL) DB TPN PHASE SELECTOR 63A - IP-42

04492	4 Ways	8	-	4+4+4	9800.00	1/1
04493	6 Ways	8	-	6+6+6	10000.00	1/1
04494	8 Ways	8	-	8+8+8	10400.00	1/1
04495*	12 Ways	8	-	12+12+12	13100.00	1/1

•Conforms to IS 8623-1 & 3, IEC 61439-1 & 3 •Reversible Door for IP-42 & IK -09 Dbs.
•Suitable for Surface & flush mounting. •Enclosure is made up of CRCA Sheet steel, RAL 7035 Powder coated, •DB has two separate compartments for MCB & Phase selector Switches, which includes 3 Nos. of (40A or 63A) rotary switches, 3 Nos. of Rocker Switches for Phase identification, 100A insulated Phase Bus-bar, Shrouded Neutral /Earth bar with Conditional Short Circuit Rating. This DB's kit includes high integrity accessories like Cement spill protector sheet, Colour-coded inter connecting wire set, Cable ties, Blank Module, Sticking saddles, Circuit identification labels. •There is a provision for FP MCB/Isolator /RCCB/RCBO as incomer & SP/TP MCBs as outgoing.



ATLANTIC - DOUBLE DOOR (METAL)TV/TEL DB (SPN) - IP42

NEW

04502	6 Way	2	-	4	2999.00	1/6
04503	8 Way	2	-	6	3099.00	1/6
04504	12 Way	2	-	10	3499.00	1/6
04505	16 Way	2	-	14	4399.00	1/3



ATLANTIC - DOUBLE DOOR (METAL)TV/TEL DB (TPN) - IP42

NEW

04511	4 Way	8	-	4+4+4	5349.00	1/3
04512	6 Way	8	-	6+6+6	5799.00	1/3
04513	8 Way	8	-	8+8+8	6399.00	1/3

•Conforms to IS 8623-1 & 3, IEC 61439-1 & 3 •Reversible Door for IP-42 & IK -09 Dbs.
•Suitable for Surface & Flush Mounting. •Enclosure is made up of CRCA Sheet steel, RAL 7035 Powder coated, •Ready to use DBs- includes 100A insulated Phase Bus-bar, Shrouded Neutral /Earth bar with Conditional Short Circuit Rating & having Telephone socket & TV axial socket. This DB's kit includes high integrity accessories like Cement spill protector sheet, Colour-coded inter connecting wire set, Cable ties, Blank Module, Sticking Saddles, Circuit identification labels. •There is a provision for-
1)SPN: DP MCB /Isolator/ RCCB/RCBO as incomer & SP MCBs as outgoing.
2)TPN:FP MCB /Isolator/RCCB/RCBO as incomer & SP/TP MCBs as outgoing.



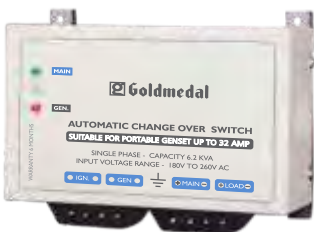

Code	Item	No of Modules			MRP ₹	Pkg. Out/Master
		Incomer	Sub Incomer	Outgoing		

PORCELAIN KIT-KAT FUSE

05101	16A / 240V. Pilot				72.00	10/120
05102	16A / 415V. Excell				118.00	5/80
05103	32A / 415V.				192.00	5/45
05104	63A / 415V.				440.00	1/24
05105	100A / 415V.				885.00	1/8
05106	200A / 415V.				1458.00	1/6
05107	300A / 415V with Lugs				2199.00	1/3
05108	500A / 415V with Lugs				2623.00	1/3

SHEET METAL MAIN - REWIRABLE SWITCH FUSE UNITS

05125	16A / 240V - DP / SPN				608.00	1/18
05126	32A / 240V - DP / SPN				1298.00	1/8
05127	16A / 415V - TP				1500.00	1/6
05128	32A / 415V - TP				1955.00	1/4
05129	63A / 415V - TP				5405.00	1/2
05130	100A / 415V - TP				9111.00	1/1
05131	200A / 415V - TP				13303.00	1/1

L. T. CONTROL REVERSE FORWARD SWITCHES

05147	16A / 240 V.				421.00	1/24
05148	25A / 415 V.				654.00	1/18

CHANGEOVER WITH SHEET ENCLOSURES

05159	16A / 240V - 2 Pole				880.00	1/12
05160	32A / 240V - 2 Pole				1377.00	1/8
05171	16A / 415V - 3 Pole				1431.00	1/6
05172	32A / 415V - 3 Pole				1760.00	1/4
05183	16A / 415V - 4 Pole				1936.00	1/6
05184	32A / 415V - 4 Pole				2144.00	1/4
05185	63A / 415V - 4 Pole				6167.00	1/2
05186	100A / 415V - 4 Pole				9693.00	1/1
05187	200A / 415V - 4 Pole				18204.00	1/1

•High grade porcelain carrier fitted with tinned copper fuse wire
•Switchgear enclosure made of CRCA sheet steel duly pre-treated and powder coated. •Hard bright tin plated contacts for high conductivity & longer life. •Quick make and break operating mechanism.

AUTOMATIC CHANGEOVER SWITCH

05201	32A / 240V - 2 Pole				2400.00	1/8
-------	---------------------	--	--	--	---------	-----

•High grade porcelain carrier fitted with tinned copper fuse wire
•Switchgear enclosure made of CRCA sheet steel duly pre-treated and powder coated. •Hard bright tin plated contacts for high conductivity & longer life. •Quick make and break operating mechanism.

Factory built service : Goldmedal can save your time and money by pre-assembling consumer units as per your requirements



Code	Item	No of Modules			MRP ₹	Pkg. Out/Master
		Incomer	Sub Incomer	Outgoing		
AC METAL PLUG & SOCKETS DB						
		No of Pins	No of Modules			
03206	Deluxe- 20A 2Pin+SC ^	P+N	1		546.00	1/24
	SP & N enclosure with Two Pole and earth metal Plug and Socket for incorporating SP MCBs					



CAM OPERATED ROTARY SWITCH

03232	3 Ways - 25A	324.00	1/40
03233	3 Ways - 32A	340.00	1/40
03234	3 Ways - 40A	613.00	1/40
03235	3 Ways - 63A	628.00	1/40

- Modular construction
- Enhanced life
- High Reliability
- Aesthetic design
- Temperature withstand capability
- Voltage Impulse test





Code	Item	No of Modules			MRP ₹	Pkg. Out/Master
		Incomer	Sub Incomer	Outgoing		

AIR SINGLE DOOR (METAL) DB - IP30 - SPN

07001	4 Way	2	-	2	801.00	1/16
07002	6 Way	2	-	4	981.00	1/16
07003	8 Way	2	-	6	1017.00	1/12
07004	12Way	2	-	10	1224.00	1/12
07005	16 Way	2	-	14	1539.00	1/9
07006	18 Way	2	-	16	1773.00	1/9

AIR SINGLE DOOR (METAL) DB - IP30 - TPN

07011	4 Way	4	-	4+4+4	2097.00	1/6
07012	6 Way	4	-	6+6+6	2727.00	1/6
07013	4 Way	8	-	4+4+4	2322.00	1/6
07014	6 Way	8	-	6+6+6	3024.00	1/6
07015	8 Way	8	-	8+8+8	3609.00	1/6
07016	12 Way	8	-	12+12+12	4995.00	1/3
07017	16 Way	8	-	16+16+16	5981.00	1/3

- Conforms to IS 8623-1 & 3, IEC 61439-1 & 3 •IP-30 for Single Door. •Suitable for Surface & Flush mounting. •Enclosure is made up of CRCA Sheet steel, RAL 9002 Powder coated,
- Ready to use DBs - includes 100A insulated Phase Bus-bar, Shrouded Neutral/Earth bar with Conditional short circuit Rating. This DB's kit includes high integrity accessories like Cement spill protector sheet, Colour-coded inter connecting wire set, Cable ties, Blank Module, Sticking saddles, Circuit identification labels. •There is a provision for- 1)SPN: DP MCB /Isolator/ RCCB/RCBO as incomer & SP MCBs as outgoing. 2)TPN: FP MCB /Isolator/ RCCB/RCBO as incomer & SP/TP MCBs as outgoing.

AIR SINGLE DOOR (METAL) 63A TPN PHASE SELECTOR DB - IP-30

07021	4 Ways	8	-	4+4+4	7200.00	1/1
07022	6 Ways	8	-	6+6+6	7655.00	1/1
07023	8 Ways	8	-	8+8+8	8483.00	1/1
07024	12 Ways	8	-	12+12+12	9311.00	1/1

- Conforms to IS 8623-1 & 3, IEC 61439-1 & 3 •IP-30 for single door. •Suitable for Surface & flush mounting. •Enclosure is made up of CRCA Sheet steel, RAL 9002 Powder coated, •DB has two separate compartments for MCB & Phase selector Switches, which includes 3 Nos. of 63A rotary switches, 3 Nos. of Rocker Switches for Phase identification, 100A insulated Phase Bus-bar, Shrouded Neutral/Earth bar with Conditional Short Circuit Rating. This DB's kit includes high integrity accessories like Cement spill protector sheet, Colour-coded inter connecting wire set, Cable ties, Blank Module, Sticking saddles, Circuit identification labels. •There is a provision for FP MCB /Isolator/RCCB/RCBO as incomer & SP/TP MCBs as outgoing.

NEW

AIR SINGLE DOOR (METAL) 63A TPN PHASE SELECTOR ENCLOSURE DB - IP-30

07025	Phase Selector Enclosure with 1 Rotary Switch	-	-	-	2199.00	1/10
07026	Phase Selector Enclosure with 3 Rotary Switch	-	-	-	6799.00	1/4

- Conforms to IS 8623-1 & 3, IEC 61439-1 & 3 • IP-30 for single door. • Suitable for Surface & flush mounting. • Available in CRCA Sheet steel. RAL9003 powder coated, • Ready to use DBs Phase selector Enclosure which includes 3 Nos. & 1 Nos. of 63A rotary Switches, 3 Nos. of Indicator for phase identification.

AIR AC (METAL) PLUG & SOC. DB No. of Pins Modules

07032	20A 2 Pin	-	P+N	1	582.00	1/24
07033	20A 2 Pin	-	P+N	2	680.00	1/24
07034	20A 3 Pin	-	3P	4	1292.00	1/16
07035	32A 3 Pin	-	3P	4	1840.00	1/8
07036	63A 5 Pin	-	3P+N+E	4	8495.00	1/6

- Conforms to IS 8623-1 & 3, IEC 61439-1 & 3
- Suitable for Surface & Flush mounting.
- Enclosure is made up of CRCA sheet steel, RAL 9002 powder coated.
- Loose Metal & Plastic Plugs & Sockets confirms to IS 8804 in single phase & three phase.

Code	Item	No of Modules			MRP ₹	Pkg. Out/Master
		Incomer	Sub Incomer	Outgoing		
AIR AC (PLASTIC) PLUG & SOC. DB						
		No. of Pins	Modules			
07041	16A 3 Pin	-	P+N+E	4	2025.00	1/16
07042	32A 3 Pin	-	P+N+E	4	3015.00	1/16
07043	32A 5 Pin	-	3P+N+E	8	3555.00	1/10
07044	63A 5 Pin	-	3P+N+E	8	9896.00	1/8



AIR AC (PLASTIC) PLUG & SOCKET DB (WITH PLASTIC COVER)						
07045	20A 2 Pin	-	P+N	1	679.00	1/24
07046	20A 2 Pin	-	P+N	2	679.00	1/24
<ul style="list-style-type: none"> •Confirms to IS 8623-1 & 3, IEC 61439-1 & 3 •Suitable for Surface & Flush mounting. •Enclosure is made up of CRCA sheet steel, RAL 9002 powder coated. •Loose Metal & Plastic Plugs & Sockets confirms to IS 8804 in single phase & three phase. 						



AIR (METAL) ENCLOSER IP-30						
07051	2 Way	-	2	-	306.00	1/24
07052	4 Way	-	4	-	396.00	1/24
07053	6 Way	-	6	-	495.00	1/24
07054	8 Way	-	8	-	603.00	1/24
<ul style="list-style-type: none"> •Confirms to IS 8623-1 & 3, IEC 61439-1 & 3 •Suitable for Surface & Flush mounting. •Enclosure is made up of CRCA sheet steel, RAL 9002 powder coated. •There is a provision to mount MCB as Isolator, RCCB/RCBO & other modular devices. 						



AIR DOUBLE DOOR (METAL) DB - IP43 - SPN						
07056	4 Way	2	-	2	1224.00	1/12
07057	6 Way	2	-	4	1494.00	1/12
07058	8 Way	2	-	6	1602.00	1/8
07059	12 Way	2	-	10	2061.00	1/8
07060	16 Way	2	-	14	2547.00	1/6
07061	18 Way	2	-	16	2969.00	1/6



AIR DOUBLE DOOR (METAL) DB - IP43 - TPN						
07066	4 Way	4	-	4+4+4	2835.00	1/4
07067	6 Way	4	-	6+6+6	3672.00	1/4
07068	4 Way	8	-	4+4+4	3204.00	1/4
07069	6 Way	8	-	6+6+6	4005.00	1/4
07070	8 Way	8	-	8+8+8	4977.00	1/4
07071	12 Way	8	-	12+12+12	7065.00	1/1
07072	16 Way	8	-	16+16+16	8523.00	1/1



- Confirms to IS 8623-1 & 3, IEC 61439-1 & 3
- Reversible Door for IP-43 & IK-09 Dbs.
- Suitable for Surface & Flush mounting.
- Enclosure is made up of CRCA Sheet steel, RAL 9002 Powder coated.
- Ready to use DBs- includes 100A insulated Phase Bus-bar, Shrouded Neutral /Earth bar with Conditional short circuit Rating. This DB's kit includes high integrity accessories like Cement spill protector sheet, Colour-coded inter connecting wire set, Cable ties, Blank Module, Sticking saddles, Circuit identification labels.
- There is a provision for-
 - 1) SPN: DP MCB /Isolator/ RCCB/RCBO as incomer & SP MCBs as outgoing.
 - 2) TPN: FP MCB /Isolator/ RCCB/RCBO as incomer & SP/TP MCBs as outgoing.



Code	Item	No of Modules			MRP ₹	Pkg. Out/Master
		Incomer	Sub Incomer	Outgoing		

AIR DOUBLE DOOR (METAL) DB - IP43- TPN HORIZONTAL PPI

07076	4+2 Way	8	2+2+2	4+4+4	6138.00	1/4
07077	6+2 Way	8	2+2+2	6+6+6	7533.00	1/4
07078	8+2 Way	8	2+2+2	8+8+8	8919.00	1/4
07079	12+2 Way	8	2+2+2	12+12+12	9810.00	1/1
07080	16+2 Way	8	2+2+2	16+16+16	10790.00	1/1

AIR DD (METAL) DB - IP43- TPN TIER PPI

07086	4+2 Way	8	2+2+2	4+4+4	5355.00	1/1
07087	6+2 Way	8	2+2+2	6+6+6	7272.00	1/1
07088	8+2 Way	8	2+2+2	8+8+8	9000.00	1/1
07089	10+2 Way	8	2+2+2	10+10+10	10350.00	1/1
07090	12+2 Way	8	2+2+2	12+12+12	10566.00	1/1
07091	16+2 Way	8	2+2+2	16+16+16	11250.00	1/1

•Conforms to IS 8623-1 & 3, IEC 61439-1 & 3 •Reversible double door for IP-43 & IK-09 Dbs. •Suitable for Surface & Flush Mounting. •Enclosure is made up of CRCA Sheet steel, RAL 9002 Powder coated, •Ready to use DBs- includes 100A insulated Phase Bus-bar, Shrouded Neutral / Earth bars with conditional Short Circuit Rating. This DB's Kit includes high integrity accessories like Cement spill protector sheet, Colour-coded inter connecting wire set, Cable ties, Blank Module, Sticking Saddles, Circuit identification labels. •There is a provision for FP MCB /Isolator/RCCB/RCBO as incomer & DPRCCB/RCBO as sub-comer, SP MCBs as outgoing.

*suitable for 3P/4P MCCB as incomer

AIR DD (METAL) DB - IP43- TPN PHASE SEGREGATED- 7 SEGMENT

07096	4 Way	8	4+4+4	4+4+4	7893.00	1/1
07097	6 Way	8	4+4+4	6+6+6	8919.00	1/1
07098	8 Way	8	4+4+4	8+8+8	10250.00	1/1
07099	12 Way	8	4+4+4	12+12+12	12816.00	1/1

•Conforms to IS 8623-1 & 3, IEC 61439-1 & 3 IP-43 & IK-09 for double door. •Suitable for Surface & Flush mounting. •Separate compartment for Incomer, Sub-incomer & Outgoing device. •Enclosure is made up of CRCA Sheet steel, RAL 9002 Powder coated, •Ready to use DBs- includes 100A insulated Phase Bus-bar, Shrouded Neutral / Earth bar with Conditional short circuit Rating. This DB's kit includes high integrity accessories like Cement spill protector sheet, Colour-coded inter connecting wire set, Cable ties, Blank module, Sticking Saddles, Circuit identification labels. •There is a provision for-

- 1) Modular Incomer - FP MCB/Isolator as incomer, DP RCCB/RCBO as sub-incomer & SP MCBs as outgoing.
- 2) MCCB Incomer -TP/FP MCCB as incomer, DP RCCB/RCBO as Sub-incomer & SP MCBs as outgoing.

AIR DD (METAL) DB - IP43- VERTICAL TPN MCB IC

07106	4 Way	8	-	4+4+4	8559.00	1/1
07107	6 Way	8	-	6+6+6	10251.00	1/1
07108	8 Way	8	-	8+8+8	10764.00	1/1
07109	12 Way	8	-	12+12+12	13527.00	1/1
07110	16 Way	8	-	16+16+16	16875.00	1/1

•Conforms to IS 8623-1 & 3, IEC 61439-1 & 3 •Reversible Door for IP-43 & IK -09 Dbs. •Suitable for Surface & Flush mounting. •Enclosure is made up of CRCA Sheet steel, RAL 9002 Powder coated, •Ready to use DB includes insulated Vertical Phase Bus-bar, Shrouded Neutral / Earth bar with Conditional Short Circuit Rating. This DB's kit includes high integrity accessories like Cement spill protector sheet, Colour-coded inter connecting wire set, Cable ties, Blank Module, Sticking Saddles, Circuit identification labels. •There is a provision for-

- 1)MCB IC : FP MCB/Isolator/RCCB/RCBO as incomer & SP/TP MCBs as outgoing.
- 2)MCCC IC : MCCB as incomer & SP/TP MCBs as outgoing,

*suitable for 3 pole / 4 pole MCCB as incomer.

* introducing shortly

Code	Item	No. of Modules			MRP ₹	Pkg. Out/Master
		Incomer	Sub Incomer	Outgoing		

AIR DD (METAL) DB - IP43- FLEXI ROW					Modules Per Row	
07126	2 Row	-	-	14	4617.00	1/1
07127	3 Row	-	-	14	5490.00	1/1
07128	4 Row	-	-	14	6102.00	1/1
07129	4 Row	-	-	16	6660.00	1/1

•Conforms to IS 8623-1 & 3, IEC 61439-1 & 3 •Reversible Door for IP-43 & IK -09 Dbs.
•Suitable for Surface & Flush mounting. •Enclosure is made up of CRCA Sheet steel, RAL 9002 Powder coated, •Ready to use DB includes Shrouded Neutral /Earth bar with Conditional Short Circuit Rating. Bus bar to be selected as per distribution requirements. This DB's kit includes high integrity accessories like Cement spill protector sheet, Cable ties, Blank Module, Sticking Saddles, Circuit identification labels. •There is a provision to mount modular devices as per requirement.



AIR DD (METAL) DB IP-43 TPN 63A PHASE SELECTOR						
07131	4 Way	8	-	4+4+4	10980.00	1/1
07132	6 Way	8	-	6+6+6	11457.00	1/1
07133	8 Way	8	-	8+8+8	12438.00	1/1
07134	12 Way	8	-	12+12+12	14013.00	1/1

•Conforms to IS 8623-1 & 3, IEC 61439-1 & 3 •Reversible Door for IP-43 & IK -09 Dbs. •Suitable for Surface & flush mounting. •Enclosure is made up of CRCA Sheet steel, RAL 9002 Powder coated, •DB has two separate compartments for MCB & Phase selector Switches, which includes 3 Nos. of 63A rotary switches, 3 Nos. of Rocker Switches for Phase identification, 100A insulated Phase Bus-bar, Shrouded Neutral /Earth bar with Conditional Short Circuit Rating. This DB's kit includes high integrity accessories like Cement spill protector sheet, Colour-coded inter connecting wire set, Cable ties ,Blank Module, Sticking saddles, Circuit identification labels. •There is a provision for FP MCB /Isolator/RCCB/RCBO as incomer & SP/TP MCBs as outgoing.



AIR DD (METAL) DB IP-43 TV/TEL. SPN						
07141	4 Way	2	-	2	2519.00	1/6
07142	6 Way	2	-	4	2968.00	1/6
07143	8 Way	2	-	6	3861.00	1/4
07144	12 Way	2	-	10	4356.00	1/4
07145	16 Way	2	-	14	5084.00	1/4



AIR DD (METAL) DB IP-43 TV/TEL. TPN						
07151	4 Way	8	-	4+4+4	6174.00	1/3
07152	6 Way	8	-	6+6+6	6561.00	1/3
07153	8 Way	8	-	8+8+8	7272.00	1/3
07154	12 Way	8	-	12+12+12	7956.00	1/3

•Conforms to IS 8623-1 & 3, IEC 61439-1 & 3 •Reversible Door for IP-43 & IK -09 Dbs. •Suitable for Surface & Flush Mounting. •Enclosure is made up of CRCA Sheet steel, RAL 9002 Powder coated, •Ready to use DBs- includes 100A insulated Phase Bus-bar, Shrouded Neutral /Earth bar with Conditional Short Circuit Rating & having telephone socket & TV co-axial socket. This DB's kit includes high integrity accessories like Cement spill protector sheet, Colour-coded inter connecting wire set, Cable ties ,Blank Module, Sticking Saddles, Circuit identification labels. •There is a provision for-
1)SPN:DP MCB /Isolator/ RCCB/RCBO as incomer & SP MCBs as outgoing.
2)TPN:FP MCB /Isolator/ RCCB/RCBO as incomer & SP/TP MCBs as outgoing.



AIR DBS ACCESSORIES					No. of Pins	Modules
07037	20A 2 Pin Soc.	-	P + N	-	117.00	10/100
07038	20A 2 Pin Plug	-	P + N	-	112.00	10/100
07201	Blanking Plate	-	-	1	16.00	50/500



AIR DD (METAL) DB IP-43 BUS BAR CHAMBER					NEW	
07171	32A/415V	-	-	4	1710.00	1/5
07172	63A/415V	-	-	4	2610.00	1/5
07173	100A/415V	-	-	4	4050.00	1/3
07174	200A/415V	-	-	4	7110.00	1/2
07175	320A/415V	-	-	4	8999.00	1/1
07176	400A/415V	-	-	4	14399.00	1/1
07177	630A/415V	-	-	4	20699.00	1/1



Connections for an **AMAZING** future.



Rigid PVC pipes & electrical conduits fittings

Established in 1979, Goldmedal is one of India's most innovative companies in the wiring and switch industry. The company has now set up a state-of-the-art manufacturing plant in Vijayawada, Andhra Pradesh for the production of PVC Conduits, Fittings and Accessories. Equipped with the latest systems and processes, these pipes and accessories are manufactured under stringent quality conditions using the finest grade of raw materials from leading suppliers. Testing is done as per the specifications in IS: 9537 Part: 3 of the Indian Bureau of Standards. The Rigid PVC Conduit Pipes are being currently manufactured in three categories: Light, Medium and Heavy in standard 3 meter length.

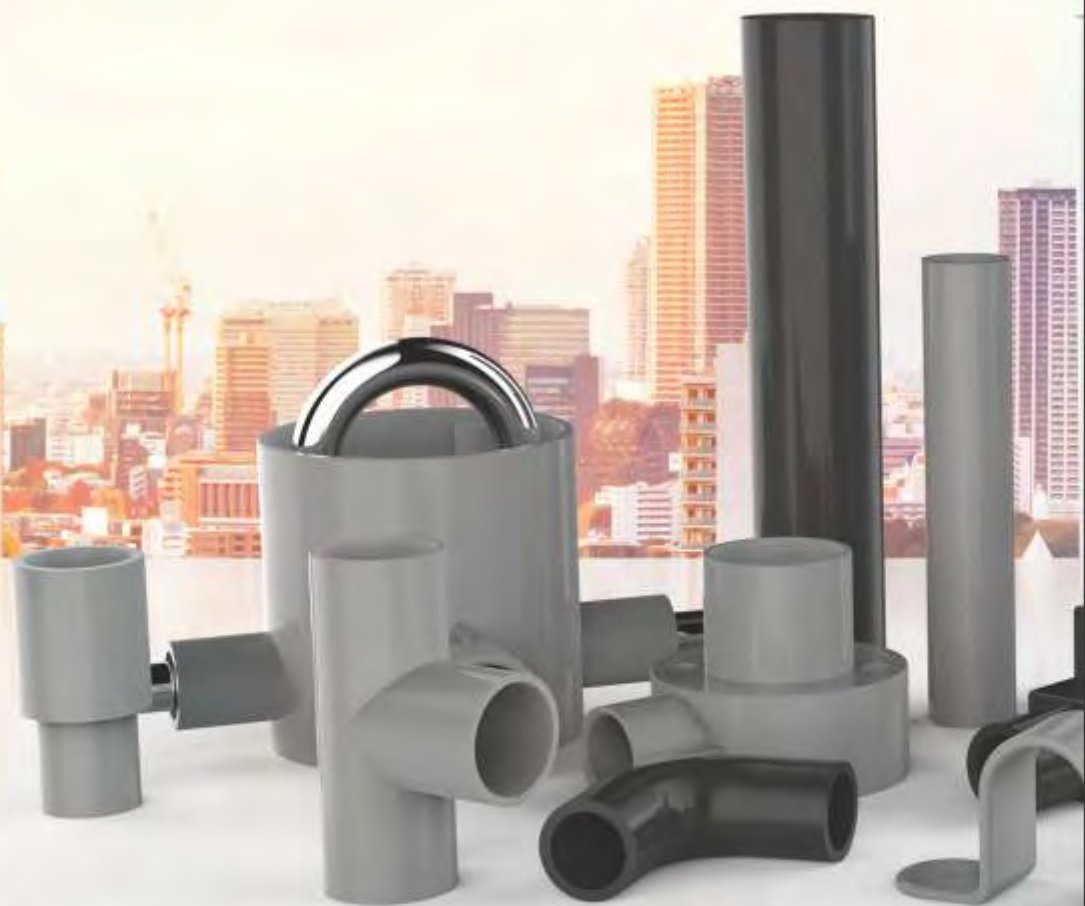



GOLDMEDAL
WIREMAN



A wire is not just a wire. It can prove to be life-saving in case of an adversity.

As a user, it's really difficult to judge the quality of a wire. They all look the same.

How, for example, can you make out the quality of the copper used? Do they use superior copper of electrolytic grade 99.97%? Does it have the ISI mark of quality: IS 694 Part I, to be specific? How about the insulation – is it fire resistant and emit low smoke in case it burns? Does it have the highest possible melting threshold – of at least 100° C?

You may try to get all these information while buying your wires... or you could simply check for the Goldmedal Wireman on the wire packaging you buy!





WIRED
FOR SAFETY

The Goldmedal Wireman makes choosing the highest quality wires so much easier!

Goldmedal is aware that a major reason for most fire accidents are the use of low-quality wires and cables with inferior quality insulation or conductor. Like most accidents, the majority of these electrical incidents are preventable – if high quality wires and cables are used! The Wireman is the symbol of the high standards adhered by Goldmedal. Consider him your safety shield. A symbol that you can rely on!

Change to
Goldmedal
Wires.
Switch to the
Wireman.

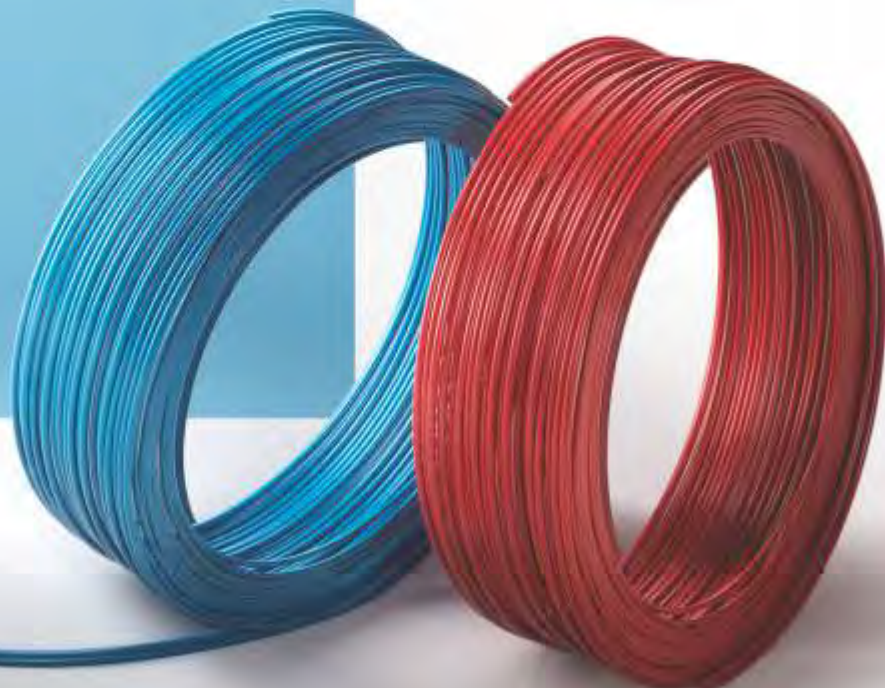



The LED lights by Goldmedal are designed to set new benchmarks in performance and aesthetics. Engineered for quick, cost-effective installation and easy retrofitting, these LED lights and panels are packed with features and benefits. All LED lights are also available in three basic colours: warm white, natural white and cool white. Select the colour that best suits your preference. Stylish in appearance, each of these lighting devices are durable enough to last years of use.





a gush of fresh **air** arriving shortly

Excellent airflow, silent operation, energy efficiency and high quality looks are just some of the parameters of the new **Goldmedal** range of fans. Arriving shortly, at a store near you!



THE COURAGE TO WIN
THE DESIRE TO WIN
HEART OF EVERY INNOVATOR
TO TAKE RISKS
OUTSIDE YOUR COMPANY
COURAGE TO ADDRESS
YOU PERCENTAGE OF
GOLDMEDAL IS OUR
WINNING PRODUCTS FOR
THAT THEY CAN EVOLVE
EVERY YEAR THE NUMBER
WON BY GOLDMEDAL
PROOF OF THE SUCCESS





INNOVATE CONTINUOUSLY.
WIN CONSISTENTLY. AT THE
HEART OF EVERY INNOVATION IS THE COURAGE
TO TAKE RISKS. THE COURAGE TO STAND
OUTSIDE YOUR COMFORT ZONE. THE COURAGE TO
ADDRESS A NEED THAT ONLY YOU PERCEIVE OF.
DRIVING THIS APPROACH AT GOLDMEDAL IS
OUR DESIRE TO CREATE WINNING PRODUCTS
FOR OUR END USERS. SO THAT THEY CAN
EVOLVE TO A BETTER LIFESTYLE EVERY TIME.
THE NUMEROUS ACCOLADES WON BY
GOLDMEDAL FOR ITS PRODUCTS IS PROOF OF
THE SUCCESS OF THIS PHILOSOPHY.

THE COURAGE TO INNOVATE CONTINUOUSLY. THE DESIRE TO WIN CONSISTENTLY. AT THE HEART OF EVERY INNOVATION IS THE COURAGE TO TAKE RISKS. THE COURAGE TO STAND OUTSIDE YOUR COMFORT ZONE. THE COURAGE TO ADDRESS A NEED THAT ONLY YOU PERCEIVE OF. DRIVING THIS APPROACH AT GOLDMEDAL IS OUR DESIRE TO CREATE WINNING PRODUCTS FOR OUR END USERS. SO THAT THEY CAN EVOLVE TO A BETTER LIFESTYLE EVERY TIME. THE NUMEROUS ACCOLADES WON BY GOLDMEDAL FOR ITS PRODUCTS IS PROOF OF THE SUCCESS OF THIS PHILOSOPHY.