



**Curve** | **Nixon**  
ILLUMINATING IDEAS



# Switch to the amazing

EA Poonawala  
95 Lohar Chawl  
Ph - 22035440, 22074651  
eapoonawala@gmail.com

[www.goldmedalindia.com](http://www.goldmedalindia.com)

EA Poonawala  
95 Lohar Chawl  
Ph - 22035440, 22074651  
eapoonawala@gmail.com



**DESIGNED**  
TO BE THE CENTRE OF  
EVERYONE'S ATTENTION.

A quick glance at the Ringo and you'll realize that it breaks all conventions for modular cover plates and accessories. With a unique circular slot for inserts and perfectly formed annular inserts to match, the Ringo is the choice for hard core stylists. **People who believe in following their own rules!**

EA Poonawala  
95 Lohar Chawl  
Ph - 22035440, 22074651  
eapoonawala@gmail.com



RINGO   
THE CENTRE OF ATTRACTION

EA Poonawala  
95 Lohar Chawl  
Ph - 22035440, 22074651  
eapoonawala@gmail.com

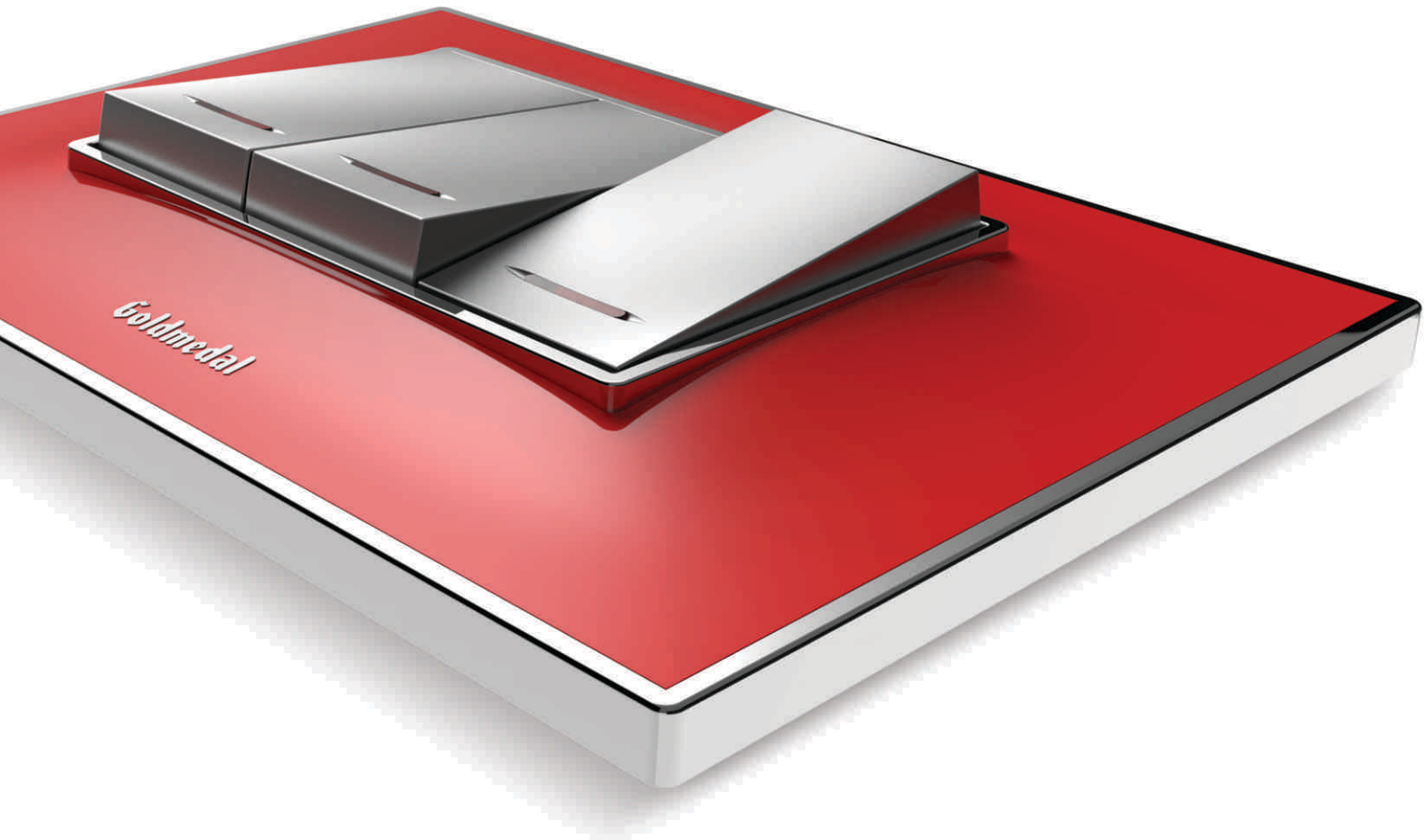

# WEGA

LOOKS GOOD FROM ANY ANGLE.

THE WEGA, WITH ITS SYMMETRICAL PEAKS AND SLOPES ON ALL FOUR SIDES, IS ANOTHER UNIQUE COVER PLATE FROM GOLDMEDAL. THE UNDULATING SHAPE CREATES AN INTERPLAY OF LIGHT THAT'S A DELIGHT TO THE SENSES. PLACE IT IN ANY SETTING AND IT'S SURE TO CATCH EVERYONE'S ATTENTION. FROM ANY ANGLE.

WEGA. GET READY TO BE MESMERIZED!

EA Poonawala  
95 Lohar Chawl  
Ph - 22035440, 22074651  
eapoonawala@gmail.com

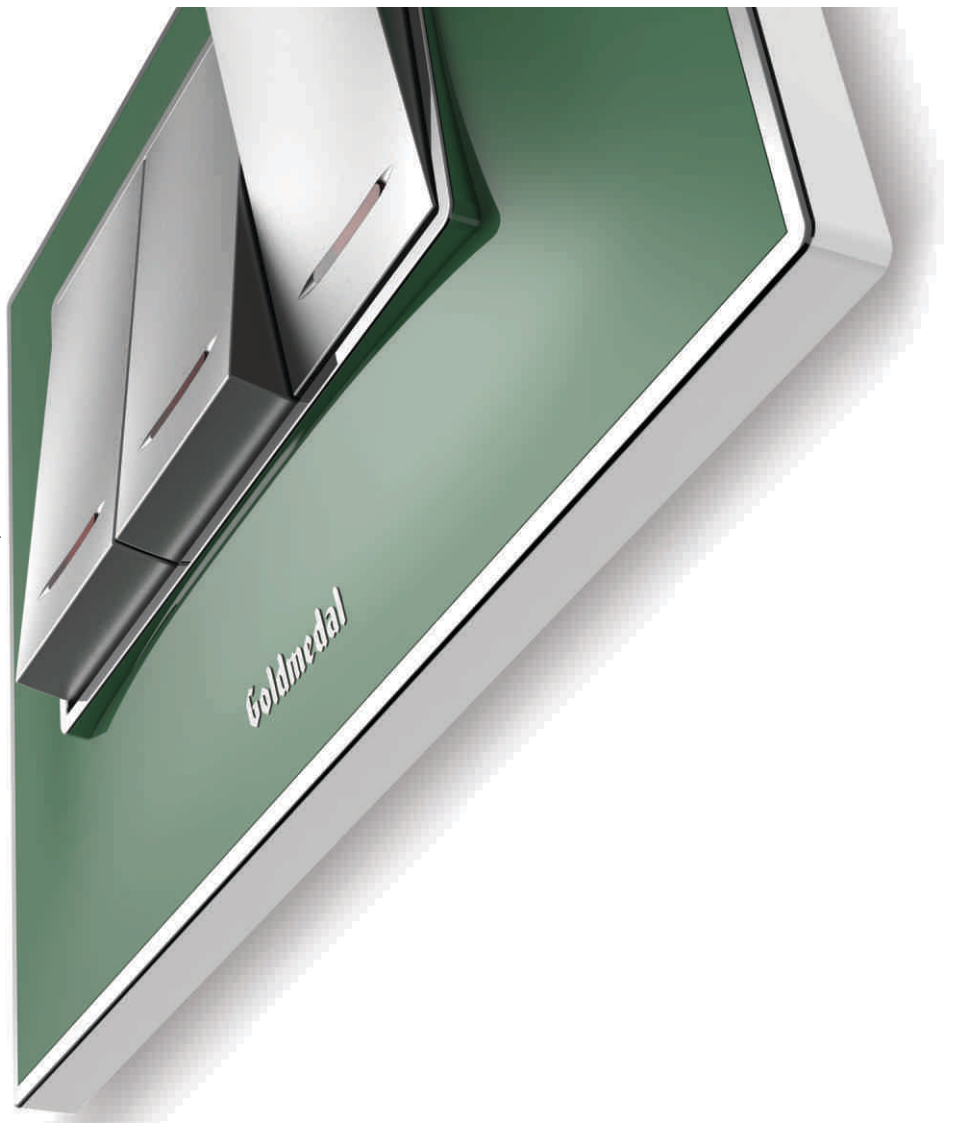

EA Poonawala  
95 Lohar Chawl  
Ph - 22035440, 22074651  
eapoonawala@gmail.com

# Curv̄e

ILLUMINATING IDEAS

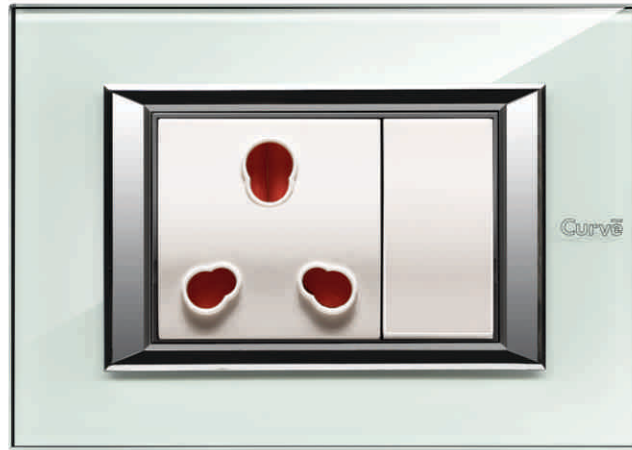

WHITE JAZZ

THE INSERTS GARBED IN WHITE JAZZ BRING IN A SOFT SOOTHING TONE TO THEIR FACADE. APART FROM UNLEASHING A CHASTE WHOLESOME AURA, THE GLOSSY SURFACE LAVISHES A MINIMALISTIC FEEL TO THE PRODUCT, MAKING IT BLEND SEAMLESSLY WITH THE SURROUNDINGS. ITS SUBTLE CHARM TOUCHES THE SIMPLICITY IN YOU, CREATING A DELIGHTFULLY SERENE FEELING. OPT FOR THESE INSERTS IF AUSTERITY IS YOUR FORTE.

EA Poonawala  
 95 Lohar Chawl  
 Ph - 22035440, 22074651  
 eapoonawala@gmail.com





DIGITAL CHROME

DIGITAL CHROME REPRESENTS A NEW IDIOM IN EXPRESSIVE LIVING. A REVOLUTIONARY SHADE, DIGITAL CHROME INSERTS PULSATE WITH A LUMINOSITY THAT MESMERISES THE SENSES. IDEAL FOR HOMES THAT EXHIBIT THE LATEST IN MODERN COMFORTS, THESE INSERTS POSSESS AN UNMISTAKABLE, ENDURING AURA. SAY YES TO THESE GILDED WORKS OF ART; EMBRACE THIS NEW PARADIGM THAT WILL SET THE TREND FOR THE FUTURE.

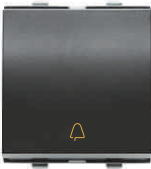

VOLTAGE GREY

VOLTAGE GREY, WITH ITS SOMBRE TONE, IMPARTS A REALISTIC FEEL TO YOUR INTERIORS. COUPLED WITH A DISTINCT SILKY TEXTURE THAT'S EMBELLISHED WITH A MATTE FINISH, THIS URBANE LINE OF ELECTRICAL FITTINGS EXUDES TECHNOLOGICAL AND AESTHETIC REFINEMENT. DESIGNED IN A SHADE THAT'S SUBTLE YET UNMISTAKABLY UNIQUE, VOLTAGE GREY BRINGS IN A RARE ENERGY TO YOUR DWELLINGS.

	Code	Item	MRP ₹		Pkg.
			White	Metallic/Grey	
<b>10AX SWITCHES 240V~ ( 1 Module )</b>					
	101001	10AX 1 Way Switch	55.00	63.00	20
	101002	10AX 1 Way Switch with Ind. (LED)	103.00	114.00	20
	101003	10AX 2 Way Switch	103.00	114.00	20
	101004	10AX Bell Push Switch	112.00	122.00	20
	101005	10AX Bell Push Switch with Ind. (LED)	128.00	139.00	20
					
					
<b>6AMP SWITCHES 240V~ ( 1 Module )</b>					
	101001A	6A 1 Way Switch	55.00	63.00	20
	101002A	6A 1 Way Switch with Ind. (LED)	103.00	114.00	20
	101003A	6A 2 Way Switch	103.00	114.00	20
	101004A	6A Bell Push Switch	112.00	122.00	20
	101005A	6A Bell Push Switch with Ind. (LED)	128.00	139.00	20
<b>10AX SWITCHES 240V~ ( 2 Module )</b>					
	102010	10AX 1 Way Switch	114.00	125.00	10
	102011	10AX 1 Way Switch with Ind. (LED)	129.00	141.00	10
	102012	10AX 2 Way Switch	143.00	155.00	10
	102013	10AX Bell Push Switch	143.00	155.00	10
	102014	10AX Bell Push Switch with Ind. (LED)	159.00	173.00	10
					
					
<b>6AMP SWITCHES 240V~ ( 2 Module )</b>					
	102010A	6A 1 Way Switch	114.00	125.00	10
	102011A	6A 1 Way Switch with Ind. (LED)	129.00	141.00	10
	102012A	6A 2 Way Switch	143.00	155.00	10
	102013A	6A Bell Push Switch	143.00	155.00	10
	102014A	6A Bell Push Switch with Ind. (LED)	159.00	173.00	10
<b>6AMP BELL PUSH 240V~ ( 2 Module )</b>					
	102015	Bell Push with Luminous Name Plate 240V~ 50-60Hz LED circuit with diffuser	207.00	207.00	10
<b>10AX SWITCHES 240V~ ( 3 Module )</b>					
	103017	1 Way Switch	119.00	129.00	10
	103018	2 Way Switch	134.00	146.00	10
	103019	Bell Push Switch	140.00	152.00	10
<b>6AMP SWITCHES 240V~ ( 3 Module )</b>					
	103017A	6A 1 Way Switch	119.00	129.00	10
	103018A	6A 2 Way Switch	134.00	146.00	10
	103019A	6A Bell Push Switch	140.00	152.00	10
<b>20AMP / 25 AMP SWITCHES 240V~ ( 1 Module )</b>					
	101020	20A 1 Way Switch	138.00	149.00	20
	101021	20A 1 Way Switch with Ind. (LED)	155.00	169.00	20
	101022	20A 2 Way Switch	155.00	169.00	20
	101023	25A 1 Way Switch	169.00	184.00	20

















EA Poonawala  
95 Lohar Chawl  
Ph - 22035440, 22074651  
eapoonawala@gmail.com





Code	Item	MRP ₹		Pkg.	
		White	Metalllc/Grey		
<b>20AMP / 25AMP SWITCHES 240V~ ( 2 Module )</b>					
102025	1 Way Switch	161.00	176.00	10	
102026	1 Way Switch with Indicator (LED)	177.00	193.00	10	
102027	2 Way Switch	186.00	209.00	10	
102028	25A 1 Way Switch	202.00	220.00	10	
<b>20AMP SWITCHES 240V~ ( 3 Module )</b>					
103029	1 Way Switch	155.00	170.00	10	
103030	2 Way Switch	168.00	184.00	10	
<b>32AMP DP SWITCHES 240V~</b>					
102031	DP Switch with Indicator (LED) - 2M	267.00	296.00	10	
103033	DP Switch -3M	278.00	306.00	10	
<b>6AMP / 6&amp;16AMP SOCKETS 240V~</b>					
101035	6A 2 Pin Socket (1M) with safety shutter	92.00	100.00	20	
102036	6A 3 Pin Multi Socket (2M) with safety shutter	100.00	110.00	10	
102037	6A 2x1 Socket (2M) with safety shutter	109.00	120.00	10	
102039	10A International Socket (2M) with safety shutter	179.00	202.00	10	
102040	6A Universal Socket (2M) with mobile socket & safety shutter	119.00	131.00	10	
102041	6&16A Universal Socket (2M) with safety shutter	199.00	221.00	10	
<b>25AMP / 6&amp;16AMP SOCKETS 240V~</b>					
102042	25A 3 Pin Socket (2M) with safety shutter	219.00	239.00	10	
103043	6&16A Universal Socket (3M) with safety shutter	220.00	230.00	10	
<b>DIMMERS 240 V~</b>					
101045	Dimmer (1M) 240V 50-60Hz 300-450W	234.00	254.00	20	
102046	Dimmer (2M) 240V 50-60Hz 300-450W	317.00	344.00	10	
102047*	Dimmer (2M) 240V 50-60Hz 300-1000W	465.00	505.00	10	
<b>FAN REGULATOR 240V~</b>					
101051	Step Regulator (1M) 4 Step, 240V 50-60 Hz	370.00	405.00	20	
102052	Step Regulator (2M) 5 Step, 240V 50-60 Hz	400.00	432.00	10	
102052	Step Regulator - Full Rotary (2M) 5 Step, 240V 50-60 Hz - Regulator Supplied in ISI & Non ISI	400.00	432.00	10	

\* introducing shortly







	Code	Item	MRP ₹		Pkg.
			White	Metallic/Grey	
<b>MOTOR STARTER (SP) 240V~ 50-60Hz ( 2 Module )</b>					
	102056	10A Starter Switch	482.00	538.00	10
	102057	16A Starter Switch	482.00	538.00	10
	102058	20A Starter Switch	482.00	538.00	10
	102059	25A Starter Switch	482.00	538.00	10
<b>TV SOCKET / RJ-11 TELEPHONE JACKS ( 1 Module )</b>					
	101062	TV Socket Coaxial 40-862 Mhz Socket	112.00	124.00	20
	101068	RJ-11 Single Telephone Jack with shutter & Name Plate	120.00	128.00	20
	101069	RJ-11 Single Telephone Jack with Screw Terminal & Name Plate	107.00	116.00	20
	101070	RJ-11 Double Telephone Jack with Screw Terminal	135.00	149.00	20
<b>EDP SOCKET OUTLET RJ-45 WITH NAME PLATE ( 1 Module )</b>					
	101072	EDP Socket Outlet - RJ 45 (Cat 5e) Category 5e, Universal wiring T568A, insulating-piercing terminal with shutter	195.00	215.00	20
	101074	EDP Socket Outlet - RJ 45 (Cat 6e) Category 6e, Universal wiring T568A, insulating-piercing terminal with shutter	513.00	550.00	20
<b>SINGLE POLE MCBS 240/450V~ ( 1 Module )</b>					
	101077	C6 SP MCB	243.00	267.00	20
	101078	C10 SP MCB	243.00	267.00	20
	101079	C16 SP MCB	243.00	267.00	20
	101080	C20 SP MCB	243.00	267.00	20
	101081	C25 SP MCB	243.00	267.00	20
	101082	C32 SP MCB 240/450V~ 50-60Hz 1.5kA Breaking Capacity	243.00	267.00	20
<b>DOUBLE POLE MCBS 240/450V~ ( 2 Module )</b>					
	102083	C6 DP MCB	502.00	544.00	10
	102084	C10 DP MCB	502.00	544.00	10
	102085	C16 DP MCB	502.00	544.00	10
	102086	C20 DP MCB	502.00	544.00	10
	102087	C25 DP MCB	502.00	544.00	10
	102088	C32 DP MCB 240/450V~ 50-60Hz 1.5kA Breaking Capacity	502.00	544.00	10
<b>INDICATOR, FUSE UNITS ( 1 Module )</b>					
	101093	Indicator with LED & Red Diffuser	93.00	102.00	20
	101098	10 AMP Fuse Carrier with miniature fuse dia 6.3x28	130.00	142.00	20

EA Poonawala  
95 Lohar Chawl  
Ph - 22035440, 22074651  
eapoonawala@gmail.com

Code	Item	MRP ₹		Pkg.	
		White	Metallic/Grey		
<b>STEP MARKER LAMP ( 2 Module )</b>					
102105	Step Marker Supply voltage 240V~ 50-60Hz with high-efficiency 1W LED & adjustable beam on three levels	482.00	530.00	5	
EA Poonawala 95 Lohar Chawl Ph - 22035440, 22074651 eapoonawala@gmail.com					
					
<b>FLOOR &amp; STEP LIGHT 240~ ( 4 Module )</b>					
120405	G-Focus Light ( Blue LED)	651.00	716.00	5	
120406	G-Focus Light Trio (LED) Fully recessed floor & step light with support frame & glassio cover plate with 3 color inbuilt LED Supply voltage 240V~50-60Hz	711.00	776.00	5	
					
<b>ELECTRONIC HAND LAMP 240V~ ( 2 Module )</b>					
102114	TORCIA Electronic hand lamp with high-efficiency 0.5W LED, automatic emergency device, rechargeable & replaceable Ni-MH battery, 2 hours operating range - Battery included (102115)	999.00	1099.00	5	
102115	Ni-MH 4.8V 80 mAh Battery (Spare parts)	229.00		10	
101123	AAA Ni-MH 1.2V 1100 mAh without "memory" effect interchangeable - 3 Batteries set ( Spare parts )	379.00		10	
 					
<b>LIGHTING FITTING WITH EMERGENCY FUNCTION 240V~</b>					
102119	Lighting Fitting with Emergency Function (2M) with High Efficiency 2x0.5W LED	1022.00	1122.00	5	
103121	Lighting Fitting with Emergency Function (3M) with High Efficiency 3x0.5W LED Supply voltage 240V~ 50Hz 3 Steps Dimming Switch 240V~ 50Hz When battery is inserted, the device will function as an emergency light - Batteries supplied separately (101124)	1375.00	1515.00	5	
 					
<b>EMERGENCY LIGHT BATTERY</b>					
101124	Battery Li-ion, 3.6V 600mAh 2/3A	249.00	-	10	
					
<b>BLANK MODULE/CORD GRIPPER/MOSQUITO REPELLENT ( 1M )</b>					
101125	Blank Module	25.00	27.00	50	
101127	Cord Gripper (Output $\phi$ 9mm)	61.00	67.00	20	
 					

	Code	Item	MRP ₹		Pkg.
			White	Metallic/Grey	
	<b>ELECTRONIC BUZZERS ( 2 Module )</b>				
	102138	Electronic Cuckoo Buzzer 240V~ 50-60Hz ( LED )	175.00	193.00	10
	102139	Electronic Bell 240V~ 50-60Hz ( LED )	300.00	331.00	10
	<b>32A MAIN SWITCH ( 2 Module )</b>				
	102163	32A DP Operated by Key Tag 240V~, LED Supplied with Key Tag	468.00	507.00	10
	102164	Only Key Tag with Name Plate	97.00	102.00	20
	<b>25A ELECTRONIC BADGE SWITCH ( 3 Module )</b>				
	103165	Electronic Switch with Smart Card 25A, 160-240V~ 50-60Hz with indicator (LED) & Integral relay having exit delay.	1365.00	1499.00	5
	103166	Smart Card Customizable Smart Card	115.00	-	20
	<b>DND / MAKE MY ROOM</b>				
	102168A	Do Not Disturb/Make My Room-2M 240V~ 50-60Hz - Outside Room	415.00	455.00	10
	102169A	Do Not Disturb/Make My Room-2M 240V~ 50-60Hz - Inside Room	445.00	489.00	10
	<b>SHAVER SOCKET ( 4 Module )</b>				
	104171	Shaver Socket (4 Module) 240V~ 50-60Hz with isolating transformer output 110/240V~	1099.00	1209.00	5
	<b>USB CHARGER 240V~ ( 2 Module )</b>				
	102173	USB Charger - Single Port Supply voltage 160-240V~ 50-60Hz Output - 5V DC, 1A with inbuilt switch & dual colour LED indicator	1000.00	1102.00	5
	102174	USB Charger - Double Port Supply voltage 160-240V~ 50-60Hz Output - 5V DC, 2A (Total)	1240.00	1355.00	5
	<b>CRISTALLO SWITCH MEMORIO KNOB</b>				
	101540	1 Module Switch Knob	11.00	-	50
	102541	2 Module Switch Knob	19.00	-	30
	103542	3 Module Switch Knob (with support knob)	29.00	-	20

Code	Item	MRP ₹		Pkg.		
		White	Metalllc/Grey			
<b>RF TOUCH SWITCHES</b>						
101206	RF 6A Touch Switch (1M) Supply voltage 160-240V~ 6A relay output Operating load (CFL & LED): 100W Max	1459.00	1599.00	5		
102213	RF 6A Touch 2 Switch (2M) <b>NEW</b> Supply voltage 160-240V~, 6A relay output Operating load (CFL & LED): 100W Max (per switch)	1899.00	2099.00	5		
102207	RF 20A Touch Switch (2M) Supply voltage 160-240V~ 20A relay output Operating load (CFL & LED): 200W Max Air conditioner: 2 ton  Radio Frequency : 433.92 Mhz Can also be operated by Remote control-103268 or web/mobile application via Gateway-101646	1679.00	1800.00	5		
<b>RF TOUCH DIMMER / FAN REGULATOR ( 2 Module )</b>						
102208	RF Touch Fan Regulator Supply voltage 160-240V~ Triac technology with 9 steps & digital display Operating load (Fan) : 100W	2015.00	2160.00	5		
102214*	RF Touch Dimmer <b>NEW</b> Supply voltage 160-240V~, Triac Technology with soft end & soft start function Operating load (LED) : 80W (Max) Incandescent Light: 40-450W <b>Not suitable for Fan</b>  Radio Frequency : 433.92 Mhz Can also be operated by Remote control-103268 or web/mobile application via Gateway-101646	2015.00	2160.00	5		
<b>RF TOUCH DRAPE CONTROLLER ( 2 Module )</b>						
102209	RF Drape Controller Supply voltage 160-240V~ 2.5A relay output Electronic RF Drape Controller suitable for AC Motor  Radio Frequency : 433.92 Mhz Can also be operated by Remote control-103268 or web/mobile application via Gateway-101646	2465.00	2630.00	5		
					EA Poonawala 95 Lohar Chawl Ph - 22035440, 22074651 eapoonawala@gmail.com	
<b>PASSIVE INFRARED DETECTOR</b>						
101210	Passive Infrared Detector (1M) with infrared sensor, adjustable dusk/dawn sensor threshold and time delay cycle, supply voltage 240V~ 50-60Hz, 6A relay output	1099.00	1209.00	5		
<b>SMART PASSIVE INFRARED DETECTOR ( 2 Module )</b>						
102212	Smart Passive Infrared Detector with infrared sensor, auto on/off, adjustable dusk/dawn sensor threshold and time delay cycle, supply voltage 240V~ 50-60Hz, 6A relay output	1469.00	1615.00	5		
<b>LPG / METANO GAS DETECTOR 240V~ ( 3 Module )</b>						
103225	LPG / Metano Gas Detector Detector with acoustic and optical signaling and control on a solenoid valve, supply voltage 240V~50-60Hz  #please refer page no. 14 for wiring diagram & technical details.  * introducing shortly	2599.00	2799.00	5		

	Code	Item	MRP ₹		Pkg.
			White	Metallic/Grey	
	<b>i-TOUCH RF BELL PUSH</b>				
	102238	i-Touch Bell Push Switch (2M) <b>NEW</b> Supply voltage 160-240V~ 2A relay output	2300.00	2500.00	5
	103245	i-Touch Bell Push Switch (3M) Supply voltage 160-240V~ 2A relay output	3800.00	4500.00	5
	<b>i-TOUCH RF 20A SWITCH</b>				
	102239	i-Touch 20A Switch (2M) <b>NEW</b> Supply voltage 160-240V~, 20A relay output	3600.00	4000.00	5
	103246	i-Touch 20A Switch (3M) Supply voltage 160-240V~, 20A relay output Operating load (CFL & LED): 200W Max Air Conditioner: 2 ton Radio Frequency : 433.92 Mhz Can also be operated by Remote control-103268 or web/mobile application via Gateway-101646	5400.00	6200.00	5
	<b>i-TOUCH RF SWITCHES ( 3 Module )</b>				
	103244	i-Touch 4 Switch with Master Supply voltage 160-240V~ 6A relay output Operating load (CFL & LED):100W Max (per switch) Radio Frequency: 433.92 Mhz Can also be operated by Remote control-103268 or web/mobile application via Gateway-101646	5900.00	6900.00	5
	<b>i-TOUCH RF LIGHT DIMMER ( 3 Module )</b>				
	103248	i-Touch 2 Dimmer with Master Supply voltage 160-240V~, Triac Technology with soft end & soft start function Operating load (LED): 80W (per dimmer) Incandescent Light: 40-450W (per dimmer) Radio Frequency : 433.92 Mhz <b>Not suitable for Fan</b> Can also be operated by Remote control-103268 or web/mobile application via Gateway-101646	4800.00	5500.00	5
	<b>i-TOUCH RF SWITCHES &amp; FAN REGULATOR ( 3 Module )</b>				
	103249	i-Touch 2 Switch + 1 Fan Regulator with Master Supply voltage 160-240V~ Switch: 6A relay output Operating load (CFL & LED): 100W Max (per switch) Fan Regulator: Variable Capacitance based 5 steps speed Operating load (Fan): 100W Radio Frequency : 433.92 Mhz Can also be operated by Remote control-103268 or web/mobile application via Gateway-101646	6700.00	7600.00	5
	<b>i-TOUCH RF DRAPE CONTROLLER ( 3 Module )</b>				
	103252	i-Touch Drape Controller (2 Curtain) Supply voltage 160-240V~ 2.5A relay output (per chanel) Electronic RF Drape Controller suitable for AC Motor Radio Frequency : 433.92 Mhz Can also be operated by Remote control-103268 or web/mobile application via Gateway-101646	4900.00	5700.00	5
	<b>RF REMOTE</b>				
	103268	RF Remote 2 Nos AAA 1.5V Battery Radio Frequency : 433.92 Mhz All scene setting can be done through the Remote. - Battery not included  #please refer page no.14 for i-touch wiring diagram & technical details.  * introducing shortly	-	1999.00	5

EA Poonawala  
95 Lohar Chawl  
Ph - 22035440, 22074651  
eapoonawala@gmail.com

## RF i-TOUCH / RF i-FEEL / RF TOUCH SYSTEMS

Installing i-Touch, i-Feel or Touch Switches does not require any new holes to be drilled or any additional wiring to be done. Simply plug them into your existing wiring. All i-Touch, i-Feel & Touch devices are designed with Switched Mode Power Supply (SMPS) for improved reliability, over current and over voltage protection. (For specific installation and technical details, please refer to the Technical Sheet provided within the product packaging). In case you need to upgrade, these electronic Touch devices can easily replace your existing Curve/Nixon modular switches.

### RF I-Touch 4 Switch + Master Switch (Wiring Diagram)

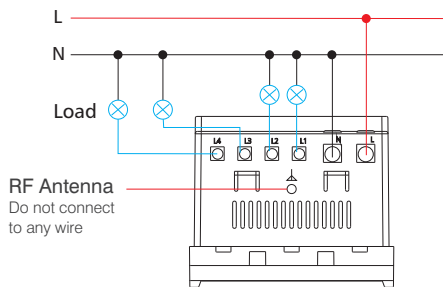

103244

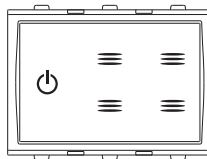

#### Technical Specifications

- Rated Voltage: 160-240V~ 50-60Hz
- Rated Load per Switch :
- a) Capacitive Load - CFL & LED (PF>0.8) : 100W
- b) Resistive Load - Incandescent & Halogen Lights: 1000 W
- c) Inductive Load - Fan and Motor : 800W
- Service Life: 50,000 Operations

### RF I-Touch 2 Switch + Fan Regulator (Wiring Diagram)

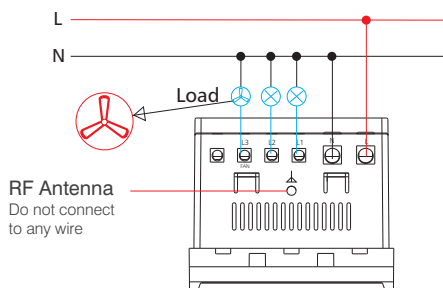

103249

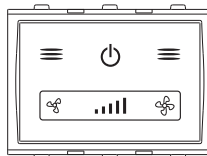

#### Technical Specifications

- Rated Voltage: 160-240V~ 50Hz
- Rated Load per switch:
- a) Capacitive Load - CFL & LED (PF>0.8) : 100W
- b) Resistive Load - Incandescent & Halogen Lights: 1000 W
- c) Inductive Load - Fan and Motor - 800 W
- Rated Load: Fan Regulator - Max 100 W
- 5-Level Speed Selection with Indicator
- Service Life: 50,000 Operations

### RF Touch Switch (Wiring Diagram)

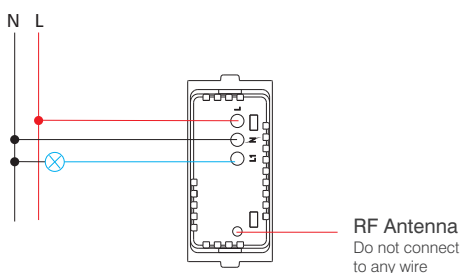

101206



#### Technical Specifications

- Rated Voltage: 160-240V~ 50-60Hz
- Rated Load:
- a) Capacitive Load - CFL & LED (PF>0.8) : 100W
- b) Resistive Load - Incandescent & Halogen Lights: 1000 W
- c) Inductive Load - Fan and Motor : 800W
- Service Life: 50,000 Operations

### RF Touch Fan Regulator (Wiring Diagram)

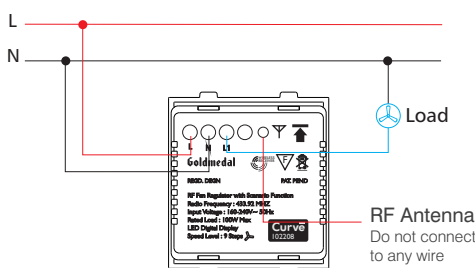

102208

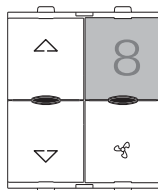

#### Technical Specifications

- Rated Voltage: 160-240V~ 50Hz
- Rated Load: Max 100 W.
- 9 Level Speed Selection
- 7 Segment Digital Display for Indicating Speed Level of the Fan.
- Service Life: 50,000 Operations

Wire colour codes: ■ Red (live),  
■ Black (neutral),  
■ Blue (load).

	Code	Item	MRP ₹		Pkg.
			White	Metallic/Grey	
 <p>EA Poonawala 95 Lohar Chawl Ph - 22035440, 22074651 eapoonawala@gmail.com</p>	<b>MP4 PLAYER DETACHABLE ( 4 Module )</b>				
	104271*	<b>Mp4 Player Detachable</b> Supply voltage 240V~ 2.8" wide screen TFT LCD Display, Feather Touch interface integrated with 8GB flash memory. Rechargeable lithium battery with audio playtime 20 hrs. Digital video playback, Music Player, FM Radio, E-book & Photos  USB cable & stereo earphone included	-	8400.00	5
	<b>BLUETOOTH PLAYER</b>				
	102273	<b>Bluetooth Player (2M)</b> Supply voltage 240V~ Bluetooth player with transmitter & receiver. Multi colour LED to display different status  Audio input - 3.5mm jack, Bluetooth (Rx mode)  Audio output - Can be connected to bluetooth speaker or headphones in Tx mode (Input - Aux in) - Can be connected to any music system, home audio system, speakers i.e ceiling or inwall through amplifier via Line out  Amplifier supplied separately - 101320	4900.00	5600.00	5
	<b>BLUETOOTH &amp; FM PLAYER ( 8 Module )</b>				
	108274	<b>Bluetooth &amp; FM Player with Speaker</b> Supply voltage 240V~ Mode selection -Aux (Line 1), Aux (Line 2), FM & Bluetooth. Audio input - 3.5 jack (Front), Line In (Back), Bluetooth Audio output - Inbuilt Stereophonic Speaker 3W x 2 - Can be connected to any music system, home audio system, speakers i.e ceiling or inwall through amplifier via Line out  Amplifier supplied separately - 101320	5999.00	6499.00	5
	<b>JUKE BOX ( 4 Module )</b>				
	104277*	<b>Juke Box with Remote</b> Supply voltage 240V~ Touch Screen interface with inbuilt FM Radio, TFT with Multi Colour LCD display Micro SD Card slot, USB Drive 2.0 High speed. Audio input & output - 3.5mm jack Audio output - Stereo Line out, 2 Speaker out 3W each - Can be connected to any music system, home audio system, speakers i.e ceiling or inwall through amplifier via Line out (Aux out)  Amplifier supplied separately - 101320	7200.00	8300.00	5



Code	Item	MRP ₹		Pkg.
------	------	-------	--	------

White Metallic/Grey

**i - DOCK PLAYER ( 4 Module )**

104281	<p><b>i-Dock Player</b> Supply voltage 240V~ Inbuilt stereo amplifier : 2 x 4W, charging function for i-pod &amp; i-phone. Audio input - 3.5mm jack, i-pod, i-phone &amp; via Bluetooth Receiver (101283)</p> <p>Audio output - Stereo Line out, 2 Speaker out 4W each - Can be connected to any music system, home audio system, speakers i.e ceiling or inwall through amplifier via Line out (Aux out)</p> <p>- Amplifier supplied separately - 101320 - Bluetooth Receiver supplied separately - 101283</p> <p>Unit supplied with infrared Remote</p>	6100.00	6699.00	5
--------	---	---------	---------	---



EA Poonawala  
95 Lohar Chawl  
Ph - 22035440, 22074651  
eapoonawala@gmail.com

**BLUETOOTH RECEIVER (PORTABLE)**

101283	<p><b>Bluetooth Receiver ( Portable )</b> Made for i-pod &amp; i-phone docking Can be operated by any bluetooth device i.e. i-pod, i-phone, i-pad, Laptop, Mobile etc.</p>	-	2200.00	5
--------	--	---	---------	---



**STEREOPHONIC SPEAKER**

102306	<p><b>Stereophonic Speaker - 2piece set (2M)</b> Stereophonic loud Speaker Load rating : 4W Impedance : 4 ohms</p>	1399.00	1599.00	10
103307*	<p><b>Stereophonic Speaker (3M)</b> Stereophonic loud Speaker Load rating : 3W Impedance : 4 ohms</p>	799.00	899.00	5



\* introducing shortly

EA Poonawala  
95 Lohar Chawl  
Ph - 22035440, 22074651  
eapoonawala@gmail.com



# Nix





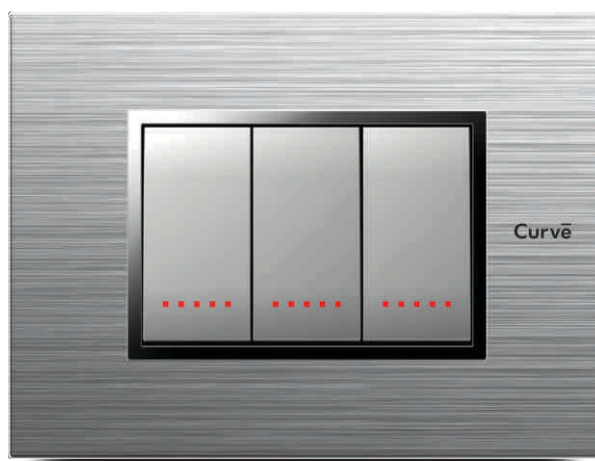

EA Poonawala  
95 Lohar Chawl  
Ph - 22035440, 22074651  
eapoonawala@gmail.com

# dm



CLASSY AND MINIMALISTIC, THE NIXON RANGE OF MODULAR INSERTS PROJECTS A SLEEK, ELEGANT PRESENCE ON YOUR WALLS. MAGNIFYING THE SLEEKNESS ARE INSERTS IN DIGITAL SILVER, A REVOLUTIONARY NEW FINISH THAT PULSATES WITH LUMINOUS ENERGY. NIXON ALSO INTRODUCES A RANGE OF HIGH QUALITY LIFESTYLE PRODUCTS THAT WILL CHANGE THE WAY YOU LOOK AT MODULAR SWITCHES AND ACCESSORIES. ALL NIXON PRODUCTS ARE COMPATIBLE WITH CURVE MODULAR PLATES, MAKING THE POSSIBILITIES FOR FORM, FINISH AND COLOURS, SIMPLY ENDLESS.







Above shown product: Digital Silver Switches in Grazia Premium coverframe

			Code	Item	MRP ₹		Pkg.	
					White	Digital Silver		
	<b>10AX SWITCHES 240V~ ( 1 Module )</b>							
	101401	10AX 1 Way Switch	56.00	64.00	20			
	101402	10AX 1 Way Switch with Ind. (LED)	107.00	119.00	20			
	101403	10AX 2 Way Switch	107.00	119.00	20			
	101404	10AX Bell Push Switch	114.00	125.00	20			
	101405	10AX Bell Push Switch with Ind. (LED)	130.00	144.00	20			
	<b>6A SWITCHES 240V~ ( 1 Module )</b>							
	101401A	6A 1 Way Switch	56.00	64.00	20			
	101402A	6A 1 Way Switch with Ind. (LED)	107.00	119.00	20			
	101403A	6A 2 Way Switch	107.00	119.00	20			
	101404A	6A Bell Push Switch	114.00	125.00	20			
	101405A	6A Bell Push Switch with Ind. (LED)	130.00	144.00	20			
	<b>10AX SWITCHES 240V~ ( 2 Module )</b>							
	102410	10AX 1 Way Switch	120.00	132.00	10			
	102411	10AX 1 Way Switch with Ind. (LED)	136.00	151.00	10			
	102412	10AX 2 Way Switch	151.00	164.00	10			
	102413	10AX Bell Push Switch	151.00	164.00	10			
	102414	10AX Bell Push Switch with Ind. (LED)	168.00	184.00	10			
	102415	10AX Bell Push Switch with Luminous Name Plate	220.00	243.00	10			
			240V~ 50-60Hz LED circuit with diffuser					
	<b>6A SWITCHES 240V~ ( 2 Module )</b>							
	102410A	6A 1 Way Switch	120.00	132.00	10			
	102411A	6A 1 Way Switch with Ind. (LED)	136.00	151.00	10			
	102412A	6A 2 Way Switch	151.00	164.00	10			
	102413A	6A Bell Push Switch	151.00	164.00	10			
	102414A	6A Bell Push Switch with Ind. (LED)	168.00	184.00	10			
	102415A	6A Bell Push Switch with Luminous Name Plate	220.00	243.00	10			
			240V~ 50-60Hz LED circuit with diffuser					
	<b>20AMP / 25AMP SWITCHES 240V~ ( 1 Module )</b>							
	101420	20A 1 Way Switch	144.00	159.00	20			
	101421	20A 1 Way Switch with Indicator	162.00	179.00	20			
	101422	20A 2 Way Switch	162.00	179.00	20			
	101423	25A 1 Way Switch	175.00	189.00	20			
	<b>20AMP / 25AMP SWITCHES 240V~ ( 2 Module )</b>							
	102425	20A 1 Way Switch	167.00	184.00	10			
	102426	20A 1 Way Switch with Ind. (LED)	185.00	204.00	10			
	102427	20A 2 Way Switch	200.00	221.00	10			
	102428	25A 1 Way Switch	212.00	234.00	10			

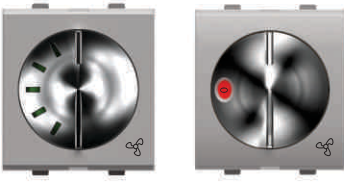
EA Poonawala  
 95 Lohar Chawl  
 Ph - 22035440, 22074651  
 eapoonawala@gmail.com

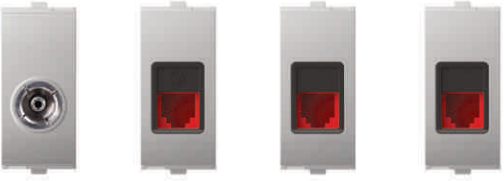
Code	Item	MRP ₹		Pkg.	
		White	Digital Silver		
<b>32AMP DP SWITCHES 240V~ ( 2 Module )</b>					
102431	32A DP Switch with Indicator (LED)	287.00	316.00	10	
<b>6AMP / 13AMP SOCKETS 240V~</b>					
101435	6A 2 Pin Socket (1M) with safety shutter	94.00	105.00	20	
102437	6A 2x1 Socket (2M) with safety shutter	116.00	129.00	10	
102439	13A International Socket (2M) with safety shutter	190.00	210.00	10	
102440	6A Universal Socket (2M) with mobile socket & safety shutter	129.00	140.00	10	
<b>6&amp;16AMP / 6&amp;25AMP SOCKETS 240V~</b>					
102441	6&16A Universal Socket (2M) with safety shutter	213.00	230.00	10	
102442	6&25A Universal Socket (2M) with safety shutter	230.00	254.00	10	
103443	6&16A Universal Socket (3M) with safety shutter	234.00	256.00	10	
<b>6 &amp; 16AMP SOCKET WITH FLAP - ( 2 Module )</b>					
102444	6&16A Universal Socket (2M) with flap & Indicator - 240V~ <b>NEW</b>	280.00	305.00	10	
<b>DIMMER / FAN REGULATOR 240 V~</b>					
101445	Dimmer 240V 50-60Hz 300-450W	271.00	299.00	20	
101451	Basic Step Regulator (1M) 4 Step, 240V 50-60 Hz	412.00	455.00	20	
102452	Basic Step Regulator (2M) 5 Step, 240V 50-60 Hz - Regulator Supplied in ISI & Non ISI	438.00	482.00	10	
<b>FAN REGULATOR 240V~ ( 2 Module )</b>					
102453	Galaxy Step Regulator - Half Rotary (Pure White) 5 Step, 240V 50-60 Hz	438.00	-	10	
102454	Galaxy Step Regulator - Full Rotary (Pure White) 5 Step, 240V 50-60 Hz - Regulator Supplied in ISI & Non ISI	438.00	-	10	

EA Poonawala  
95 Lohar Chawl  
Ph - 22035440, 22074651  
eapoonawala@gmail.com

		Code	Item	MRP ₹		Pkg.
				White	Digital Silver	
						
<b>FAN REGULATOR 240V~ ( 2 Module )</b>						
102453A	Galaxy Step Regulator - Half Rotary (Chrome Knob) 5 Step, 240V 50-60 Hz	450.00	491.00	10		
102454A	Galaxy Step Regulator - Full Rotary (Chrome Knob) 5 Step, 240V 50-60 Hz - Regulator Supplied in ISI & Non ISI	450.00	491.00	10		
						
<b>MOTOR STARTER (SP) 240V~ 50-60Hz ( 2 Module )</b>						
102456	10A Motor Starter Switch	516.00	563.00	10		
102457	16A Motor Starter Switch	516.00	563.00	10		
102458	20A Motor Starter Switch	516.00	563.00	10		
102459	25A Motor Starter Switch	516.00	563.00	10		
						
<b>TV SOCKET / RJ-11 TELEPHONE JACKS / EDP SOCKET ( 1 Module )</b>						
101462	TV Socket Coaxial 40-862 Mhz Socket	114.00	125.00	20		
101468	Telephone Jack - RJ 11	124.00	136.00	20		
101472	EDP Socket Outlet - RJ 45 (5e) Category 5e, Universal wiring T568A, insulating-piercing terminal	215.00	237.00	20		
101474	EDP Socket Outlet - RJ 45 (6e) Category 6e, Universal wiring T568A, insulating-piercing terminal	543.00	593.00	20		
						
<b>SINGLE POLE MCBS 240/450V~ ( 1 Module )</b>						
101477	C6 SP MCB	259.00	282.00	20		
101478	C10 SP MCB	259.00	282.00	20		
101479	C16 SP MCB	259.00	282.00	20		
101480	C20 SP MCB	259.00	282.00	20		
101481	C25 SP MCB	259.00	282.00	20		
101482	C32 SP MCB	259.00	282.00	20		
240/450V~ 50-60Hz 3kA Breaking Capacity						
						
<b>DOUBLE POLE MCBS 240/450V~ ( 2 Module )</b>						
102483	C6 DP MCB	512.00	558.00	10		
102484	C10 DP MCB	512.00	558.00	10		
102485	C16 DP MCB	512.00	558.00	10		
102486	C20 DP MCB	512.00	558.00	10		
102487	C25 DP MCB	512.00	558.00	10		
102488	C32 DP MCB	512.00	558.00	10		
240/450V~ 50-60Hz 3kA Breaking Capacity						
						
<b>G-POWER 25A UNIT ( 4 Module )</b>						
104491	G-Power 25A Unit (Metal Box) with Concealed Metal Junction Box (4M Plate with 25A MCB, 25A Socket & 16A G-grip Top)	839.00	929.00	5		
104492	G-Power 25A Unit (Plastic Box) with G-surface Plastic Gang Box (4M Plate with 25A MCB, 25A Socket & 16A G-grip Top)	809.00	889.00	5		
240/450V~ 50-60Hz 3kA Breaking Capacity						







EA Poonawala  
95 Lohar Chawl  
Ph - 22035440, 22074651  
eapoonawala@gmail.com

Code	Item	MRP ₹		Pkg.
		White	Digital Silver	
<b>INDICATOR / FUSE UNIT / BLANK MODULE ( 1 Module )</b>				
101493	Indicator with LED & Red Diffuser	97.00	108.00	20
101498	Fuse Carrier (10Amp/16Amp) with miniature fuse dia 6.3x28	132.00	146.00	20
101525	Blank Module	27.00	29.00	50
<b>STEP MARKER</b>				
102505	Step Marker (2M) <span style="color:red">NEW</span> Supply voltage 240V~ 50-60Hz with high-efficiency 0.5W LED	482.00	529.00	5
103506	Step Marker with Dimmable Function (3M)	1007.00	1107.00	5
102507	Step Marker with Dimmable Function (2M) <span style="color:red">NEW</span> Supply voltage 240V~ 50-60Hz with high-efficiency 2x0.5W LED & 3 level dimmable function	745.00	820.00	
<b>LIGHTING FITTING WITH EMERGENCY FUNCTION</b>				
102510	Lighting Fitting with Emergency Function (2M) with High Efficiency 2x0.5W LED	1040.00	1119.00	5
103511	Lighting Fitting with Emergency Function (3M) with High Efficiency 3x0.5W LED Supply voltage 160-240V~ 50Hz Dimmable function (3 Level) The device will function as an emergency light if battery is inserted - Battery supplied separately (101124)	1466.00	1583.00	5
<b>EMERGENCY LIGHT BATTERY</b>				
101124	Battery Li-ion, 3.6V, 600mAH 2/3A <span style="color:red">NEW</span>	249.00	-	20
<b>ELECTRO MECHANICAL BUZZER / ELECTRONIC BUZZER 240V ~</b>				
101530*	Electro Mechanical Buzzer (1M) 240V~50-60Hz	156.00	171.00	20
102539	Electronic Bell (2M) <span style="color:red">NEW</span> 240V~50-60Hz	361.00	397.00	10
<b>ELECTRONIC DOOR BELLS ( 4 Module )</b>				
104541*	Electronic Multi Tune Bell <span style="color:red">NEW</span> with 4 selectable melodies & Connectivity for multiple rooms. Supply voltage 240V~ 50-60Hz,	1034.00	1150.00	5

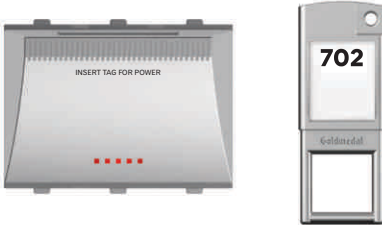

EA Poonawala  
95 Lohar Chawl  
Ph - 22035440, 22074651  
eapoonawala@gmail.com

\* introducing shortly

		Code	Item	MRP ₹		Pkg.
				White	Digital Silver	
		<b>i-TOUCH RF SWITCHES / BELL PUSH ( 2 Module )</b>				
	102544	<b>i-Touch 2 Switch</b> Supply voltage 160-240V~, 6A relay output Operating load (CFL & LED): 100W Max (per switch) Radio Frequency : 433.92 Mhz Can also be operated by Remote control-103268 or web/mobile application via Gateway-101646	3500.00	3900.00	5	
	102545	<b>i-Touch Universal Switch</b> Supply voltage 240V~, - Can be paired wirelessly with any Goldmedal RF switch, fan regulator, dimmer etc. (Touch, i-Touch and i-Feel) as a two way switch - Can be configured as a switch for any particular scene or All ON or All OFF command	3900.00	4300.00	5	
		<b>i-TOUCH RF 20A SWITCH ( 2 Module )</b>				
	102548	<b>i-Touch Bell Push Switch</b> Supply voltage 160-240V~ 2A relay output	2300.00	2500.00	5	
	102550	<b>i-Touch 20A Switch</b> Supply voltage 160-240V~, 20A relay output Operating load (CFL & LED): 200W Max Air conditioner: 2 ton Radio Frequency : 433.92 Mhz Can also be operated by Remote control-103268 or web/mobile application via Gateway-101646	3600.00	4000.00	5	
		<b>i-TOUCH RF DIMMER/FAN REGULATOR/DRAPE CONTROLLER ( 2M )</b>				
	102553*	<b>i-Touch Light Dimmer</b> <span style="background-color: red; color: white; padding: 2px;">NEW</span> Supply voltage 160-240V~, Triac Technology with soft end & soft start function Operating load (LED) : 80W (Max) Incandescent Light: 40-450W <span style="color: red;">Not suitable for Fan</span>	3500.00	3800.00	5	
	102554	<b>i-Touch Fan Regulator</b> Supply voltage 160-240V~ Variable Capacitance based 4 step regulator Operating load (Fan) : 100W	3500.00	3800.00	5	
	102556	<b>i-Touch Drape Controller</b> Supply voltage 160-240V~ 2.5A relay output Electronic RF Drape Controller suitable for AC Motor Radio Frequency : 433.92 Mhz Can also be operated by Remote control-103268 or web/mobile application via Gateway-101646	3800.00	4200.00	5	
		<b>i-TOUCH DO NOT DISTURB/MAKE MY ROOM ( 2 Module )</b>				
	102560	<b>i-Touch DND / Make My Room / Please Wait (Inside Room)</b>	2100.00	2500.00	5	
	102561	<b>i-Touch DND / Make My Room / Please Wait with Bell Push Switch (Outside Room)</b> Supply voltage 160-240V~ (Inside & outside unit are connected to each other)	2300.00	2700.00	5	
		<b>32A MAIN SWITCH ( 3 Module )</b>				
	103562	<b>32A DP Operated by Key Tag</b> 240V~, LED Supplied with Key Tag For key tag please refer Curve product 102164	539.00	592.00	5	
		<b>25A ELECTRONIC BADGE SWITCH ( 3 Module )</b>				
	103565	<b>Electronic Switch with Smart Card</b> 25A, 160-240V~ 50-60Hz with indicator (LED) & Integral relay having exit delay. For smart card please refer Curve product 103166	1529.00	1679.00	5	

EA Poonawala  
95 Lohar Chawl  
Ph - 22035440, 22074651  
eapoonawala@gmail.com





Code	Item	MRP ₹		Pkg.
		White	Digital Silver	
<b>BELL INDICATOR ( 6 Module )</b>				
106567	Bell Indicator for Call Display 6 Way with Name Plate 240V~ <b>NEW</b>	1699.00	1899.00	5
<b>DND/MAKE MY ROOM 240~ ( 2 Module )</b>				
102568	Do Not Disturb/Make My Room 240V~ 50-60Hz - Inside Room	439.00	479.00	10
102569	Do Not Disturb/Make My Room 240V~ 50-60Hz - Outside Room	469.00	509.00	10
<b>USB CHARGER 240~</b>				
101572	USB Charger - (1M) Supply voltage 160-240V~ 50-60Hz	1000.00	1102.00	10
102573	USB Charger - Double Port (2M) Supply voltage 160-240V~ 50-60Hz Output - 5V DC, 2A (Total)	1240.00	1355.00	5
103574	USB Charger & 10A Int. Socket (3M) Supply voltage 160-240V~ 50-60Hz Output - 5V DC, 2A (Total)	1425.00	1565.00	5
<b>AUDIO - VIDEO SOCKET</b>				
101577	HDMI Socket - (1M)	1000.00	1102.00	10
<b>i-SENSE RF SWITCHES / DIMMER ( 2 Module )</b>				
102585*	i-Sense 4 Switch Feather Touch Electronic RF Switch 6A 240V~ relay output	-	6500.00	5
102587*	i-Sense 2 Switch + 1 Dimmer Feather Touch Electronic RF Switch & Dimmer 6A 240V~ relay output Triac Technology with soft end & soft start function Operating load : 300-450W Radio Frequency : 433 Mhz <b>NEW</b> Supply voltage 240V~ Can also be operated by Remote control-103268 or web/mobile application via Gateway-101646	-	6800.00	5
<b>i-SENSE RF FAN REGULATOR / DRAPE CONTROLLER ( 2 Module )</b>				
102589*	i-Sense 2 Switch + 1 Fan Regulator Feather Touch Electronic RF Switch & Regulator 6A 240V~ relay output Moftset Technology with 5 steps fan coil speed Operating load (fan) : 100W	-	7300.00	5
102591*	i-Sense Drape Controller (2Curtain) Feather Touch Electronic RF Drape Controller 6A 240V~ relay output Radio Frequency : 433 Mhz <b>NEW</b> Supply voltage 240V~ Can also be operated by Remote control-103268 or web/mobile application via Gateway-101646	5700.00		5



EA Poonawala  
95 Lohar Chawl  
Ph - 22035440, 22074651  
eapoonawala@gmail.com

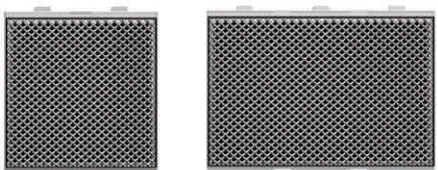
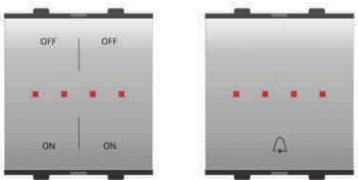

\* introducing shortly

		Code	Item	MRP ₹	Pkg.
				White	Digital Silver
					
<b>i-SENSE HOME STATION &amp; TFT COLOUR DISPLAY ( 2 Module )</b>					
102596*	<b>i-Sense Home Station</b>	-	8999.00	5	
Feather Touch Electronic Home Station Switching Lights, Operating Door, Call acceptance, Volume control of ringing tone.					
102597*	<b>i-Sense TFT Colour Display</b>	-	10999.00	5	
TFT Colour display with high quality picture even viewed at an angle Colour display switches on automatically when bell is actuated & can also be switch on manually Supply voltage 240V~ <b>NEW</b>					
<b>CAMERA / IP CAMERA</b>					
102598*	<b>Camera (2M)</b>	-	8999.00	5	
Automatic day/night switching, Camera can be manually swivelled 20° horizontally & vertically Automatic background lighting compensation. Automatic gain control (AGC) Protection type IP 44					
103599*	<b>IP Camera (3M)</b>	-	14400.00	5	
Automatic day/night switching, Camera can be manually swivelled 20° horizontally & vertically Automatic background lighting compensation. Automatic gain control (AGC) Supply voltage 160-240V~ <b>NEW</b>					
EA Poonawala 95 Lohar Chawl Ph - 22035440, 22074651 eapoonawala@gmail.com					
					
<b>i-SENSE SENSO SWITCH ( 2 Module )</b>					
102601	<b>i-Sense Senso Switch</b>	<b>NEW</b>	3999.00	4399.00	5
Supply voltage 160-240V~ 6A relay output Allows to control lights by simply passing the hand in front of it (Max distance 50mm). 2 units can be combined to control the same light (2 way function).					
<b>i-SENSE FM RADIO / BLUETOOTH PLAYER</b>					
102603*	<b>i-Sense FM Radio (2M)</b>	-	6100.00	5	
Feather touch FM radio with digital display 87-50 MHZ, 30 Station Memory with scanner					
103604	<b>i-Sense FM Radio / Bluetooth (3M)</b>	7500.00	-	5	
FM & Bluetooth player Mode selection : FM & Bluetooth. <b>NEW</b> Audio output - Stereo Line out - Can be connected to any music system, home audio system, speakers i.e ceiling or inwall through amplifier via Line out, Supply voltage 240V~ - Amplifier supplied separately - 101320					
					
<b>STEREOPHONIC SPEAKER</b>					
102610*	<b>Stereophonic Speaker (2M)</b>	-	850.00	5	
103611*	<b>Stereophonic Speaker (3M)</b>	-	980.00	5	
Stereophonic Loud Speaker Load rating : 4W Impedance : 4 ohms					
					
<b>i-FEEL RF SWITCHES / BELL PUSH SWITCH ( 2 Module )</b>					
102626	<b>i-Feel 2 Switch</b>	4500.00	5000.00	5	
Supply voltage 160-240V~, 6A relay output Operating load (CFL & LED): 100W Max (per switch) Radio Frequency : 433.92 Mhz - Can also be operated by Remote control-103268 or web/mobile application via Gateway-101646					
102630	<b>i-Feel Bell Push Switch</b>	3000.00	3300.00	5	
Supply voltage 160-240V~ 2A relay output					
					
*introducing shortly					

Code	Item	MRP ₹		Pkg.
------	------	-------	--	------

White Digital Silver

**i-FEEL RF 20A SWITCH ( 2 Module )**

102632	<b>i-Feel 20A Switch</b> Supply voltage 160-240V~, 20A relay output Operating load (CFL & LED): 200W Max Air Conditioner: 2 ton Radio Frequency : 433.92 Mhz  Can also be operated by Remote control-103268 or web/mobile application via Gateway-101646	4700.00	5800.00	5
--------	---	---------	---------	---

EA Poonawala  
95 Lohar Chawl  
Ph - 22035440, 22074651  
eapoonawala@gmail.com

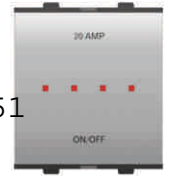

**i-FEEL RF DIMMER / FAN REGULATOR ( 2 Module )**

102634*	<b>i-Feel Light Dimmer</b> Supply voltage 160-240V~, Triac Technology with soft end & soft start function Operating load LED: 80W Incandescent Light: 40-450W <b>NEW</b> Not suitable for Fan	4500.00	5000.00	5
102636	<b>i-Feel Fan Regulator</b> Supply voltage 160-240V~ Variable Capacitance based 4 step regulator Operating load (Fan) : 100W Radio Frequency: 433.92 Mhz  Can also be operated by Remote control-103268 or web/mobile application via Gateway-101646	4500.00	5000.00	5

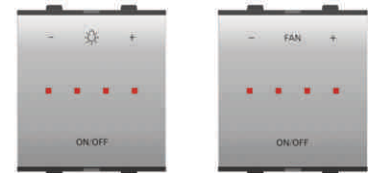

**i-FEEL RF DRAPE CONTROLLER ( 2 Module )**

102638	<b>i-Feel Drape Controller</b> Supply voltage 160-240V~ 2.5A relay output Electronic RF Drape Controller suitable for AC Motor Radio Frequency : 433.92 Mhz  Can also be operated by Remote control-103268 or web/mobile application via Gateway-101646	4600.00	5000.00	5
--------	--	---------	---------	---



**i-HOME AUTOMATION**

101646	<b>i-Home Gateway</b> - Compatible with RF Touch, i-Touch & i-Feel products. - Connects electrical functions through a router. - Control from anywhere using your smartphone / tablet / laptop / desktop. - Individual device control as well as scene settings. - Schedule individual devices as well as scenes.	15999.00	-	1
--------	--	----------	---	---

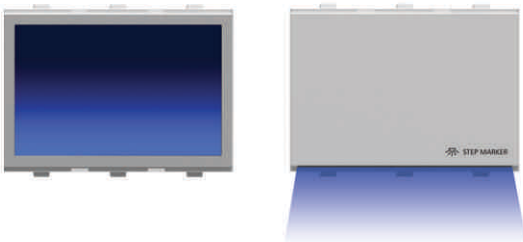
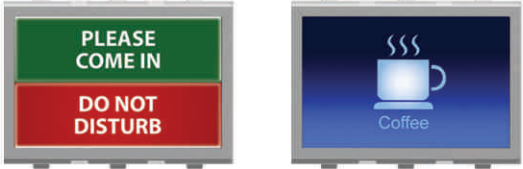
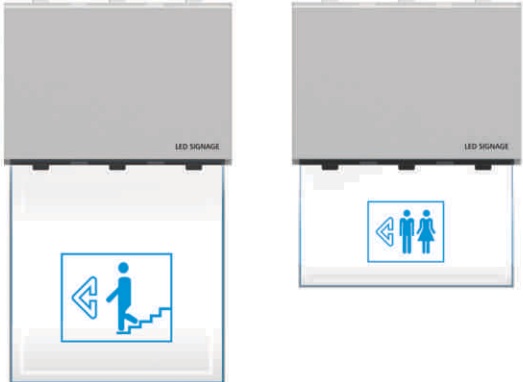

EA Poonawala  
95 Lohar Chawl  
Ph - 22035440, 22074651  
eapoonawala@gmail.com

		Code	Item	MRP ₹		Pkg.
				White	Digital Silver	
		<b>SIGNAGE 240V~ 50-60Hz - ( 3 Module )</b>				
		103647	Foot Light (LED) Supply voltage 240V~ 50-60Hz	569.00	639.00	5
		103648	Step Marker (LED) Supply voltage 240V~ 50-60Hz	506.00	567.00	5
		103649	LED Indicator Supply voltage 240V~ 50-60Hz	515.00	570.00	5
		103650	LED Signage Supply voltage 240V~ 50-60Hz	515.00	570.00	5
		<b>EDGE GLOW LED SIGNAGE 240V~ 50-60 Hz - ( 3 Module )</b>				
		103652	Edge Glow LED Signage* Supply voltage 240V~ 50-60Hz	445.00	490.00	5
		103653	Edge Glow Square Slide customizable symbol	205.00	-	5
		103654	Edge Glow Rectangle Slide customizable symbol	225.00	-	5
		103655	Edge Glow L Type Slide customizable symbol	255.00	-	5
		* Edge Glow Slide Supplied Separately				

**SYMBOLS FOR CUSTOMIZABLE SLIDE OF EDGE GLOW LED SIGNAGE (LASER ENGRAVING)**

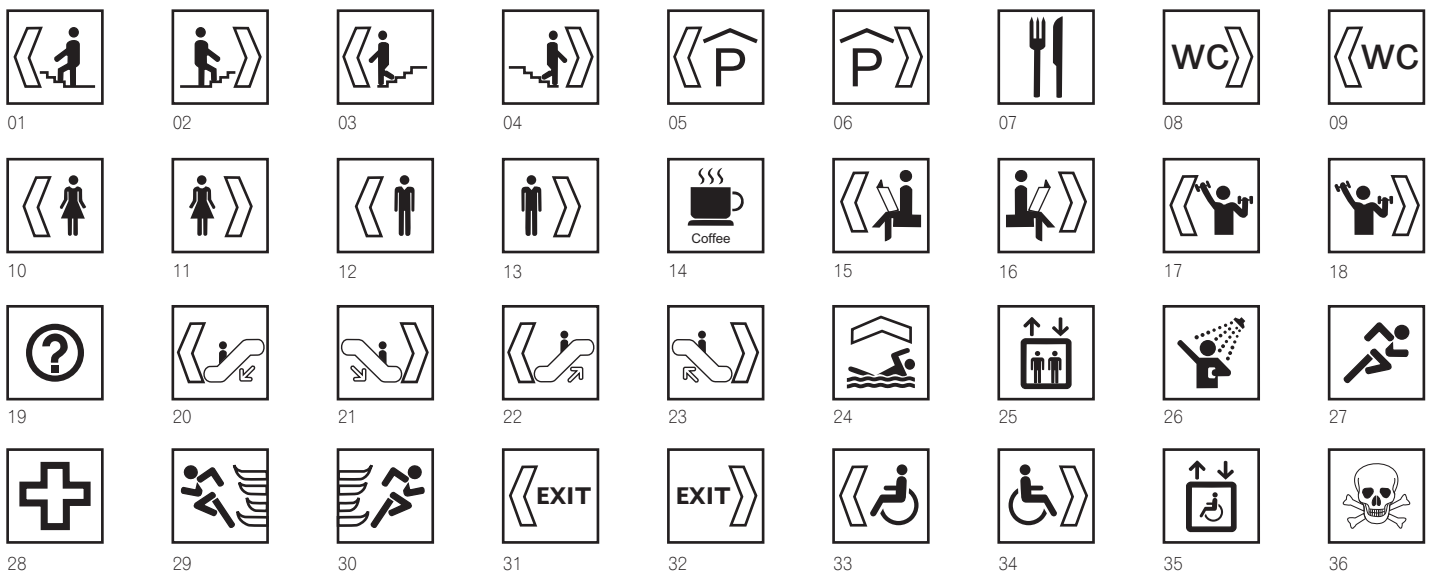

EA Poonawala  
 95 Lohar Chawl  
 Ph - 22035440, 22074651  
 eapoonawala@gmail.com







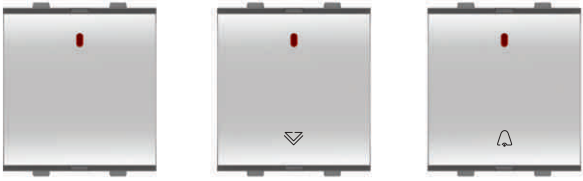

QUORRA XTREME BRUSHED ALUMINIUM  
WITH I-PUSH SWITCHES

THE I-PUSH IS A CONTEMPORARY TAKE ON CONVENTIONAL MECHANICAL SWITCHES WHERE YOU EXERT GENTLE PRESSURE TO OPERATE A SWITCH. UNLIKE ORDINARY SWITCHES, HOWEVER, THE I-PUSH SPRINGS BACK TO POSITION AND REMAINS FLUSH WITH THE COVER PLATE IN BOTH ON AND OFF POSITION. THE DISTINCT BUT SUBTLE CHANGE IN THE INDICATOR INFORMS THE USER ABOUT THE PREVAILING STATE OF THE SWITCH. SMART STYLING, LED AS WELL AS MECHANICAL INDICATORS, AND EXCITING SHADES MAKE THE I-PUSH RANGE A DELIGHT ON YOUR WALLS!

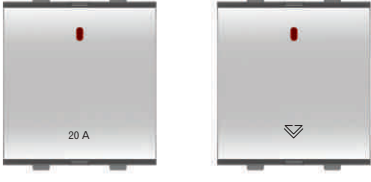

QUORRA XTREME BRUSHED ALUMINIUM  
WITH I-PUSH DP SWITCH

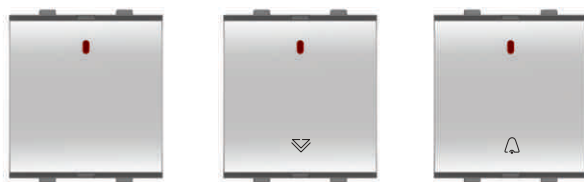
			Code	Item	MRP ₹		Pkg.
					White	Metallic/Grey	
	<b>6AX / 10AX i-PUSH SWITCHES 240V~ ( 1 Module )</b> <span style="background-color: red; color: white; padding: 2px;">NEW</span>						
	101681	1 Way Switch	86.00	95.00	20		
	101682	2 Way Switch	113.00	124.00	20		
	101683	Bell Push Switch	119.00	131.00	20		
	<b>6AX / 10AX i-PUSH SWITCHES 240V~ ( 2 Module )</b> <span style="background-color: red; color: white; padding: 2px;">NEW</span>						
	102687	1 Way Switch	129.00	142.00	10		
	102688	2 Way Switch	157.00	173.00	10		
	102689	Bell Push Switch	149.00	164.00	10		
	<b>20AMP i-PUSH SWITCHES 240V~ ( 1Module )</b> <span style="background-color: red; color: white; padding: 2px;">NEW</span>						
	101693	1 Way Switch	145.00	160.00	20		
	101694	2 Way Switch	161.00	177.00	20		
<p>EA Poonawala 95 Lohar Chawl Ph - 22035440, 22074651 eapoonawala@gmail.com</p>							
	<b>20AMP i-PUSH SWITCHES 240V~ ( 2 Module )</b> <span style="background-color: red; color: white; padding: 2px;">NEW</span>						
	102697	1 Way Switch	172.00	189.00	10		
	102698	2 Way Switch	202.00	222.00	10		
	<b>32AMP i-PUSH DP SWITCH 240V~ ( 2 Module )</b> <span style="background-color: red; color: white; padding: 2px;">NEW</span>						
102701	32A DP Switch	315.00	347.00	10			

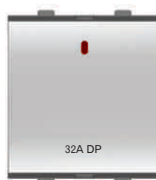
Code	Item	MRP ₹		Pkg.	
		White	Metallic/Grey		
<b>6AX / 10AX i-PUSH LED SWITCHES 240V~ ( 1 Module )</b>					
			<b>NEW</b>		
101705*	1 Way Switch with Indicator (LED)	99.00	109.00	20	
101706*	2 Way Switch with Indicator (LED)	130.00	143.00	20	
101707*	Bell Push Switch with Indicator (LED)	137.00	151.00	20	
<b>6AX / 10AX i-PUSH LED SWITCHES 240V~ ( 2 Module )</b>					
			<b>NEW</b>		
102711*	1 Way Switch with Indicator (LED)	148.00	163.00	10	
102712*	2 Way Switch with Indicator (LED)	181.00	199.00	10	
102713*	Bell Push Switch with Indicator (LED)	171.00	188.00	10	
<b>20AMP i-PUSH LED SWITCHES 240V~ ( 1 Module )</b>					
			<b>NEW</b>		
101717*	1 Way Switch with Indicator (LED)	167.00	184.00	20	
101718*	2 Way Switch with Indicator (LED)	185.00	204.00	20	
EA Poonawala 95 Lohar Chawl Ph - 22035440, 22074651 eapoonawala@gmail.com					
<b>20AMP i-PUSH LED SWITCHES 240V~ ( 2 Module )</b>					
			<b>NEW</b>		
102721*	1 Way Switch with Indicator (LED)	198.00	218.00	10	
102722*	2 Way Switch with Indicator (LED)	232.00	255.00	10	
<b>32AMP i-PUSH LED DP SWITCH 240V~ ( 2 Module )</b>					
102725*	32A DP Switch with Indicator (LED)	362.00	398.00	10	
* introducing shortly					

EA Poonawala  
95 Lohar Chawl  
Ph - 22035440, 22074651  
eapoonawala@gmail.com

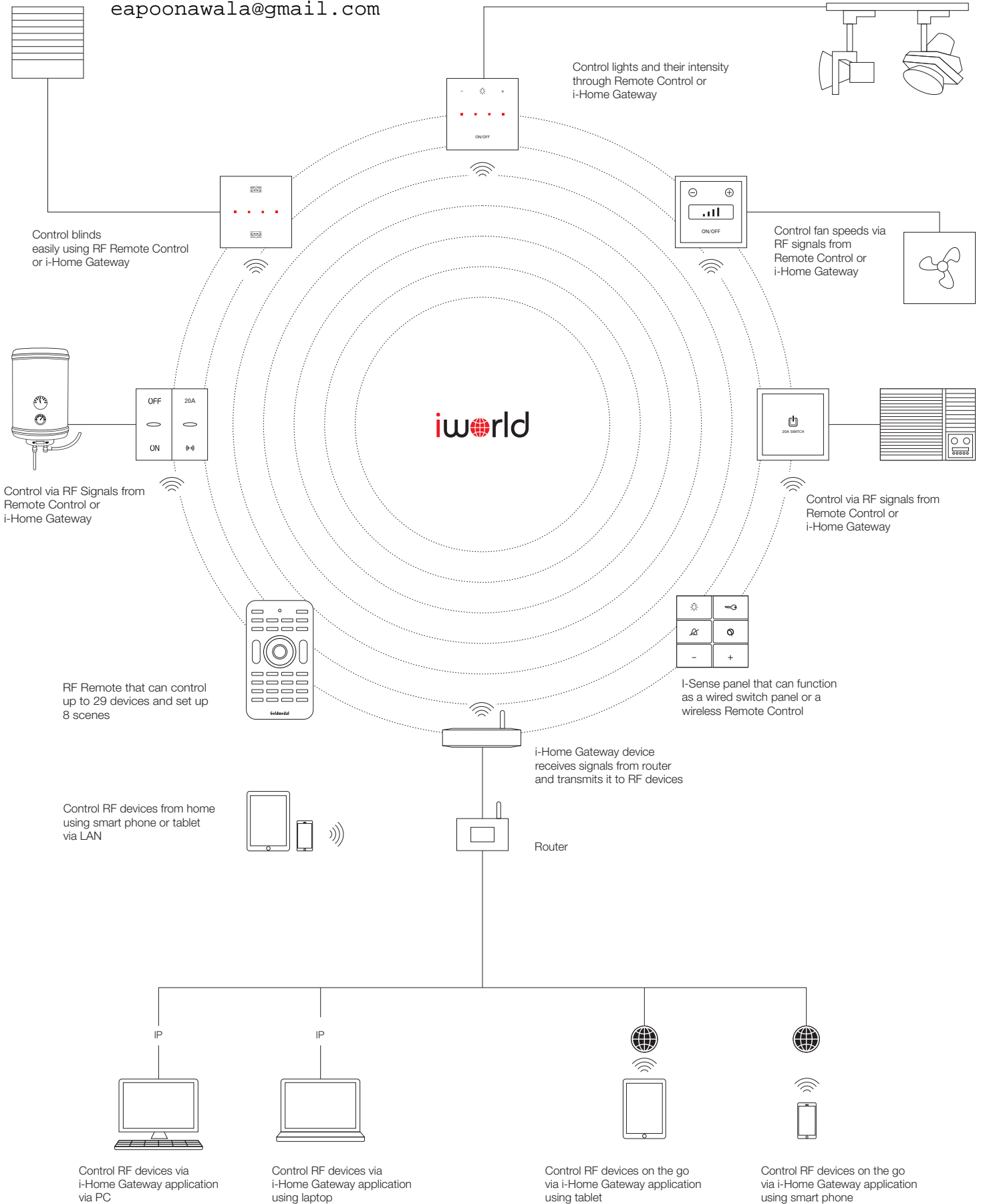





# i-HOME Automation

INTELLIGENT GATEWAY  
EA Poonawala

95 Lohar Chawl

Ph - 22035440, 22074651

eapoonawala@gmail.com



## YOUR WORLD. YOUR WAY.

WELCOME TO YOUR NEW, **INTELLIGENT** HOME!

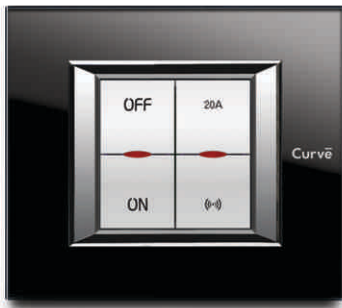

Touch Products

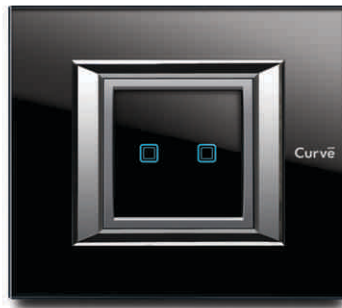

i-Touch Products



i-Feel Products

You have installed the latest Touch technology from Goldmedal in your home. Now, take it to the next level with the i-Home Gateway! From lights to fans to drapes and other functions, you can control individual devices, set scenes or even schedule the operations of scenes and devices using your smartphone, tablet, desktop or any smart mobile device ... from anywhere in the world.



### I-HOME GATEWAY

The i-Home Gateway Router connects to your network in a few simple steps. Once connected, it captures commands from your smartphone, tablet, laptop or PC from anywhere in the world. The commands are then relayed to the relevant RF devices in the premises.

### SMARTPHONE

Access the i-Home Gateway Application on the move on your Smart Phone, Tablet or PC. The intuitive interface enables you to set scenes, create timers and schedule devices as per your need!

## Goldmedal i-Home

Download the Goldmedal i-Home App on your smart device to control your RF Switches from anywhere in the world. Download now!



Scan with your smartphone to download the user manual

	Code	Item	MRP ₹	Pkg.
	<b>GALAXY RGB LED SPEAKER</b>			
	101311	<b>Galaxy RGB LED Speaker</b> Load rating: 25W Impedance: 8 ohms  - Toughened glass for maximum safety - Amplifier supplied separately - Supplied with wireless RGB LED Controller - Supplied with touch RF remote.	10399.00	1
	<b>2 CHANNEL AMPLIFIER</b>			
	101320	<b>2 Channel Amplifier</b> Power supply 110-240V~ Amplifier type BTL (class D) Output power max RL=4 ohms 35W per channel Treble (@20KHz) +- 12 db Bass (@40Hz) +- 12 db Frequency (-3 db) 25Hz-20KHz	4999.00	1
	<b>GIFA AUDIO HUB</b>			
	GTX 501	<b>Audio Hub</b> (Wireless docking station + LED Lamp Speaker)  - Charging and Playback iPod models and iPhone - Plays MP3/WMA music through USB/SD/MMC card - Composite video out for iPod and iPhone - Aux in jack for Mp3 playback - DC-in Jack with AC/DC adaptor included - Docking station for iPod and iPhone - 2.4GHz wireless transmission - 85 white LED light - Back house with standard lamp E27 screw - 2.25" x 1 full range speaker - Control up to 8 group wireless devices  (Supplied with wireless LED lamp speaker GRX 501)	11599.00	1
	<b>GIFA AUDIO LIGHT</b>			
	GRX 501	<b>Audio Light</b> ( Wireless LED Lamp Speaker )  Music power: 20W Lighting power: 5W 2.25" x 1 full range speaker Digital Amplifier - 2.4GHz wireless transmission - 85 white LED light burns upto 30,000 hrs. - Back house with standard lamp E27 connector - Semi transparent cover with metal grill - Can be paired upto 8 group wireless devices  (Combine with GIFA Wireless docking GTX 501)	5999.00	1
	<b>I-ROCK BLUETOOTH SPEAKER</b>			
	101351	<b>I-Rock Wireless Bluetooth Speaker</b> Bluetooth frequency: 2.40GHz-2.480 Ghz Operating Distance: 10 meters, class II Two speakers can be paired Working time: 16 hours (one speaker) Working time: 8 hours (When two speaker use together) Charging input: DC 12V  (12V DC Power adaptor included)	5999.00	1

EA Poonawala  
 95 Lohar Chawl  
 Ph - 22035440, 22074651  
 eapoonawala@gmail.com

Code	Item	MRP ₹	Pkg.
------	------	-------	------

**KBSOUND® DOCK**

KB 50902	<p><b>KBSOUND DOCK</b> Wireless accessories for use with KBSOUND SPACE and KBSOUND ISELECT kit.</p> <p>Contents: Dock (52591), Wireless Module (52592), RF Antenna and 5V power supply with interchangeable plugs for different countries</p> <p>(When integrated with KBSOUND ISELECT you can enjoy the radio or listen to the music from your iPod, iPhone or additional sound source using a 3.5mm jack)</p>	9999.00	1
----------	---	---------	---



**KBSOUND® SPACE**

KB 50398	<p><b>KBSOUND SPACE</b> An open-ended model that allows you to freely choose your loudspeaker and amplifier to fulfil your specific design requirement.</p> <p>Contents: <b>REMOTE CONTROL</b> - IR Remote control with display screen that shows RDS information and iPod/iPhone playing list. - Keypad to access different sound sources such as FM, iPod, Audio IN and DAB. - Allows you to control the volume, bass and treble levels, together with scanning and storing stations in the memory. <b>ELECTRONIC MODULE (52398)</b> - Designed to incorporate the radio frequency device that permits integration with the KBSOUND DOCK. - Includes an improved antenna (RF) connector for better FM reception. <b>IR RECEIVER / TRANSMITTER</b> - A separate IR bi-directional receiver/transmitter to communicate with the remote.</p>	11800.00	1
----------	---	----------	---



**KBSOUND® ISELECT KIT**

KB 50302	<p><b>KBSOUND ISELECT (KIT)</b> A perfect sound system that allows you to hear FM radio and music from iPod/iPhone or 3.5mm Line IN when integrated with KBSOUND DOCK.</p> <p>Contents: <b>REMOTE CONTROL</b> - IR Remote control with display screen that shows RDS information. - Keypad to access different sound sources such as FM, iPod, Audio IN and DAB. (when integrated with KBSOUND DOCK) - Allows you to control the volume, bass and treble levels, together with scanning and storing stations in the memory. <b>ELECTRONIC MODULE (52391)</b> - Designed to incorporate any radio frequency device that permits integration with the KBSOUND DOCK. - Includes an improved antenna (RF) connector for better FM reception. <b>TWO 2.5" LOUDSPEAKER</b> - 1.5W + 1.5W stereo output - IR receiver/transmitter built-in to loudspeaker grille <b>ANTENNA WIRE (76cm)</b> <b>PARALLEL LOUDSPEAKER CABLING (10M)</b></p>	10999.00	1
----------	--	----------	---



**LOUDSPEAKERS i500 SERIES**

KB 50301*	<p><b>Loudspeakers (Active &amp; Passive Speaker)</b></p> <p><b>ACTIVE SPEAKER (55101)</b> - Data and sound (four channels) input line from the central unit. - 5 + 5W Sound Amplifier. - 8 Ohm two-way loudspeaker. - 8 Ohm output for Passive Loudspeaker. - Line output for an Auxiliary Active Loudspeaker. - Supply voltage 110-240V~ - Load rating 20W</p> <p><b>PASSIVE LOUDSPEAKER (55301)</b> - Two-way 8 ohm loudspeaker.</p>	-	1
-----------	---	---	---

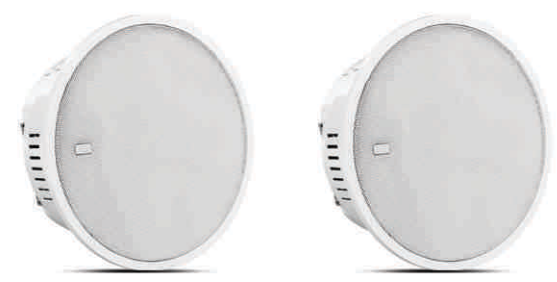

\* Introducing shortly

**BELLA COVER PLATES WITH MOUNTING FRAMES**

PLATES →	1M	2M	3M	3M*	4M	6M	7M*	8M(H)	8M*	8M (V)	8M(V)**	12M	16M	18M
COLOURS ↓	MRP ₹	MRP ₹	MRP ₹	MRP ₹	MRP ₹	MRP ₹	MRP ₹	MRP ₹	MRP ₹	MRP ₹	MRP ₹	MRP ₹	MRP ₹	MRP ₹
White Jazz	68.00	68.00	84.00	84.00	98.00	132.00	162.00	166.00	190.00	166.00	166.00	208.00	229.00	270.00
Metalik	97.00	97.00	126.00	126.00	143.00	186.00	239.00	243.00	266.00	243.00	243.00	306.00	310.00	338.00
Belle Soft	106.00	106.00	138.00	138.00	162.00	209.00	263.00	266.00	290.00	266.00	266.00	338.00	345.00	370.00
Antik	127.00	127.00	159.00	159.00	185.00	247.00	327.00	333.00	356.00	333.00	333.00	373.00	427.00	472.00
Belle Wood	127.00	127.00	159.00	159.00	185.00	247.00	327.00	333.00	356.00	333.00	333.00	373.00	427.00	472.00
CODE →	30101	30201	30301	33301	30401	30601	30701	30801	32801	38801	39801	31201	31601	31801
PKG →	10	10	10	10	10	5	5	5	5	5	5	5	5	5
SIZE(mm) →	93x86	93x86	119x86	125x86	151x86	219x86	219x86	268x86	246x86	154x155	152x168	220x155	268x155	225x224

COVER PLATES

\* Without Partition \*\*8 Module Vertical Big Size

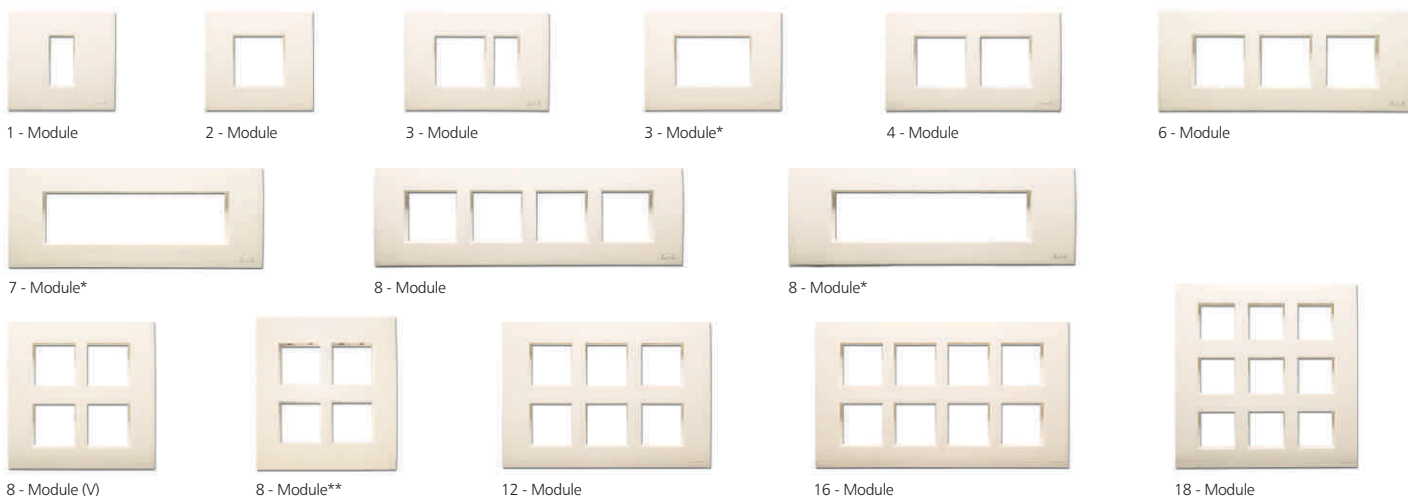

**CRISTALLO COVER PLATES WITH MOUNTING FRAMES**

PLATES →	1M	2M	3M	3M*	4M	6M	8M (H)	8M*	8M (V)	12M	16M	18M
COLOURS ↓	MRP ₹	MRP ₹	MRP ₹	MRP ₹	MRP ₹	MRP ₹	MRP ₹	MRP ₹	MRP ₹	MRP ₹	MRP ₹	MRP ₹
White Jazz	65.00	65.00	81.00	81.00	93.00	125.00	160.00	182.00	160.00	203.00	223.00	258.00
Memorio	169.00	169.00	203.00	203.00	245.00	313.00	426.00	426.00	426.00	469.00	563.00	642.00
Twixos/Metalik	145.00	145.00	187.00	187.00	215.00	265.00	320.00	320.00	320.00	390.00	435.00	499.00
Wood	170.00	170.00	221.00	221.00	258.00	304.00	375.00	375.00	375.00	457.00	508.00	569.00
CODE →	40101	40201	40301	43301	40401	40601	40801	42801	48801	41201	41601	41801
PKG →	10	10	10	10	10	5	5	5	5	5	5	5
SIZE(mm) →	92x86	92x86	115x86	122x86	150x86	222x86	264x86	248x86	150x151	222x151	264x151	223x217

COVER PLATES

\* Without Partition

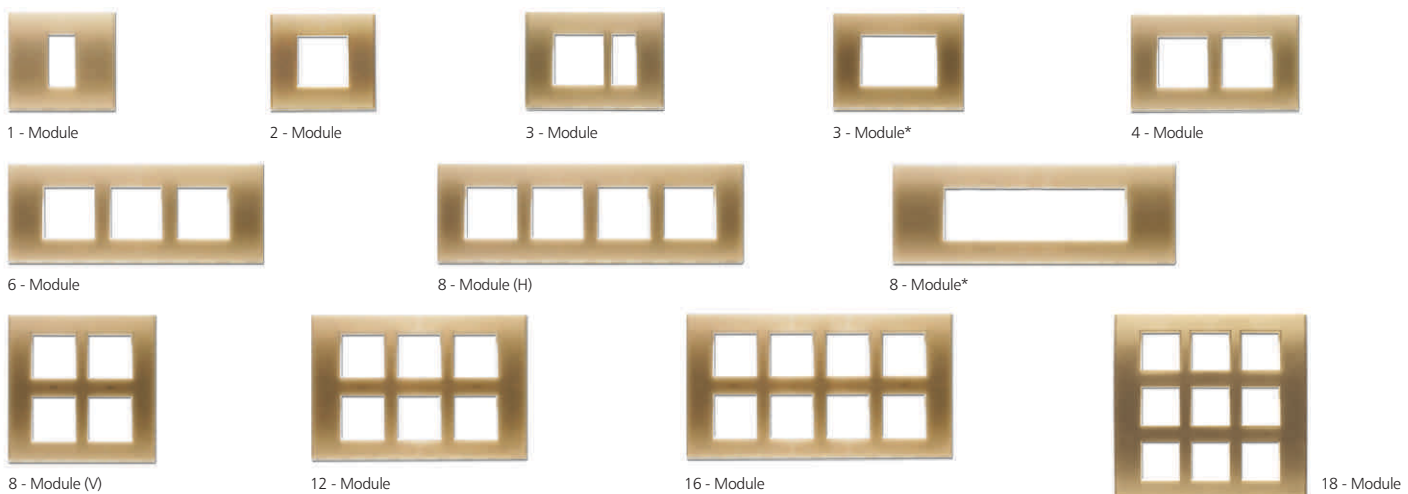

NEW

NEW

NEW

**QUORRA BASIC COVER PLATES**

PLATES →	1M	2M	3M	4M	4M*	6M	6M*	8M (H)*	8M	8M*	8M (V)	12M	18M
					(H&V)**		(H&V)**			(H&V)**			
COLOURS ↓	MRP ₹	MRP ₹	MRP ₹	MRP ₹	MRP ₹	MRP ₹	MRP ₹	MRP ₹	MRP ₹	MRP ₹	MRP ₹	MRP ₹	MRP ₹
Satin White	-	102.00	129.00	160.00	-	207.00	-	248.00	248.00	-	248.00	314.00	438.00
Metallic	-	168.00	186.00	219.00	-	263.00	-	318.00	318.00	-	318.00	439.00	538.00
Wood	-	197.00	219.00	274.00	-	318.00	-	395.00	395.00	-	395.00	538.00	714.00

**QUORRA EXCLUSIVE COVER PLATES**

Glass	-	339.00	488.00	649.00	-	914.00	-	994.00	994.00	-	994.00	1199.00	1469.00
SIZE(mm) →	-	101x87	124x87	148x87	-	222x87	-	271x87	248x87	-	148x154	222x154	222x220

**QUORRA PREMIUM COVER PLATES**

Glass	435.00	435.00	615.00	810.00	890.00	1090.00	1200.00	-	1230.00	1350.00	1230.00	1455.00	1765.00
CODE →	50101	50201	53301	50401	50403	50601	50603	50801	52801	50803	58801	51201	51801
PKG →	10	10	10	10	10	5	5	5	5	5	5	5	5
SIZE(mm) →	106x91	106x91	128x91	152x91	152x91	226x91	226x91	-	251x91	269x91	152x157	226x157	226x224

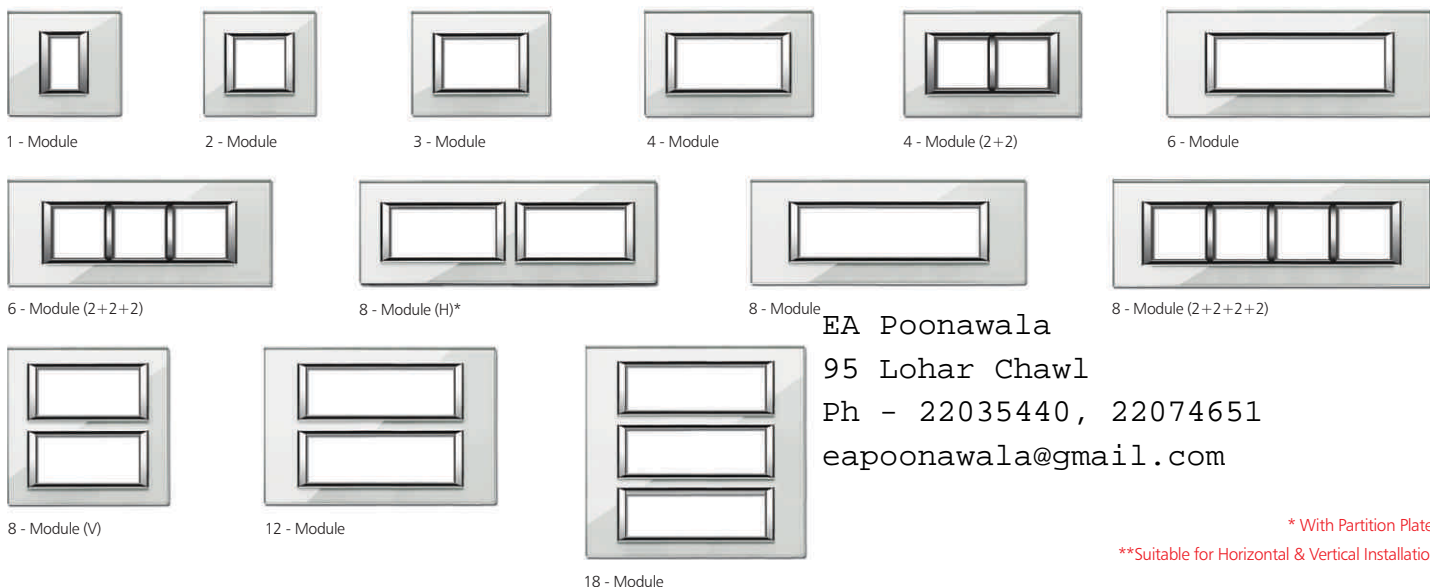

EA Poonawala  
95 Lohar Chawl  
Ph - 22035440, 22074651  
eapoonawala@gmail.com

\* With Partition Plates  
\*\* Suitable for Horizontal & Vertical Installation

**QUORRA MOUNTING FRAME - Horizontal & Vertical Distance for Screwing ( Dimensions in mm )**

Quorra Frame →	2M	3M	4M	4M	6M	6M	8M (H)*	8M	8M	8M (V)	12M	18M
				(H&V)**		(H&V)**			(H&V)**			
MRP ₹ →	45.00	54.00	62.00	66.00	91.00	98.00	114.00	114.00	123.00	114.00	146.00	198.00
CODE →	50202	53302	50402	50404	50602	50604	50802	52802	50804	58802	51202	51802
PKG →	25	25	25	25	20	20	20	20	20	20	20	10

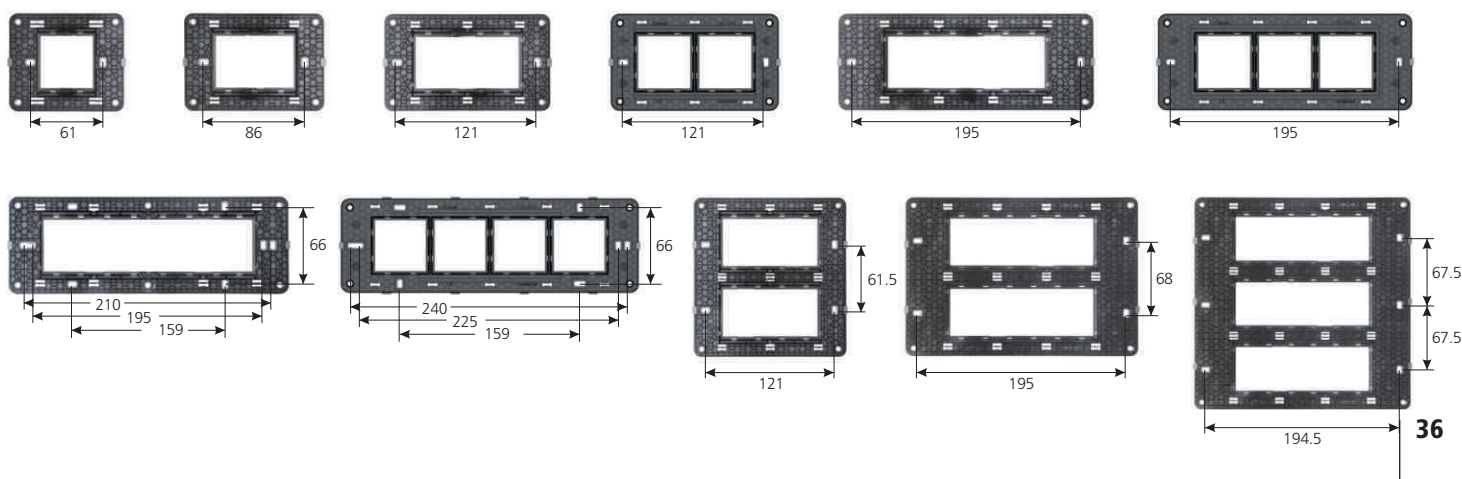

NEW

NEW

NEW

**QUORRA CRYSTALLIGHT / DIAMOND COVER PLATES**

PLATES →	1M	2M	3M	4M	4M* (H&V)**	6M	6M* (H&V)**	8M	8M* (H&V)**	8M (V)	12M	18M
COLOURS ↓	MRP ₹	MRP ₹	MRP ₹	MRP ₹	MRP ₹	MRP ₹	MRP ₹	MRP ₹	MRP ₹	MRP ₹	MRP ₹	MRP ₹
Glass (diamond cut)	490.00	490.00	690.00	910.00	1000.00	1300.00	1380.00	1460.00	1520.00	1460.00	1640.00	2010.00
Diamond (studded)	-	-	4399.00	-	-	-	-	-	-	-	-	-

**QUORRA XTREME COVER PLATES**

Wood	410.00	410.00	588.00	777.00	855.00	1103.00	1192.00	1263.00	1317.00	1263.00	1449.00	1775.00
Steel	494.00	494.00	704.00	935.00	1028.00	1323.00	1433.00	1525.00	1582.00	1525.00	1733.00	2132.00
Aluminum	494.00	494.00	704.00	935.00	1028.00	1323.00	1433.00	1525.00	1582.00	1525.00	1733.00	2132.00
CODE →	50101	50201	53301	50401	50403	50601	50603	52801	50803	58801	51201	51801
PKG →	10	10	10	10	10	5	5	5	5	5	5	5
SIZE(mm) →	106x91	106x91	128x91	152x91	152x91	226x91	226x91	251x91	269x91	152x157	226x157	226x224



1 - Module



2 - Module



3 - Module



4 - Module



4 - Module (2+2)



6 - Module



6 - Module (2+2+2)



8 - Module



8 - Module (2+2+2+2)



8 - Module (V)



12 - Module



18 - Module

EA Poonawala  
95 Lohar Chawl  
Ph - 22035440, 22074651  
eapoonawala@gmail.com

\* With Partition Plates  
\*\*Suitable for Horizontal & Vertical Installation

**QUORRA XTREME COVER PLATES**



1 - Module



2 - Module



3 - Module



4 - Module



4 - Module (2+2)



6 - Module



6 - Module (2+2+2)



8 - Module



8 - Module (2+2+2+2)



8 - Module (V)



12 - Module



18 - Module

EA Poonawala  
95 Lohar Chawl  
Ph - 22035440, 22074651  
eapoonawala@gmail.com

**NEW**

**GRAZIA BASIC COVER PLATES WITH MOUNTING FRAMES**

PLATES →	1M	2M	3M	4M	4M*	6M	6M*	8M	8M*	8M	9M*	12M	12M*	12M*	16M	18M
					(H&V)**		(H&V)**		(H&V)**	(V)				(H&V)**		
COLOURS ↓	MRP ₹	MRP ₹	MRP ₹	MRP ₹	MRP ₹	MRP ₹	MRP ₹	MRP ₹	MRP ₹	MRP ₹	MRP ₹	MRP ₹	MRP ₹	MRP ₹	MRP ₹	MRP ₹
Pure Glossy	73.00	73.00	90.00	111.00	111.00	158.00	158.00	199.00	199.00	199.00	213.00	228.00	228.00	228.00	253.00	289.00
Metallic	114.00	114.00	148.00	181.00	181.00	247.00	247.00	309.00	309.00	309.00	331.00	361.00	361.00	361.00	397.00	399.00
Wood	151.00	151.00	206.00	252.00	252.00	344.00	344.00	470.00	470.00	470.00	474.00	482.00	482.00	482.00	529.00	562.00

**NEW**

**GRAZIA PREMIUM COVER PLATES WITH MOUNTING FRAMES**

Pure Glossy	80.00	80.00	99.00	121.00	121.00	173.00	173.00	219.00	219.00	219.00	235.00	250.00	250.00	250.00	282.00	319.00
CODE →	60101	60201	60301	60401	60404	60601	60604	60801	60804	68801	60901	61201	61204	61207	61601	61801
PKG →	10	10	10	10	10	5	5	5	5	5	5	5	5	5	5	5
SIZE(mm) →	101x93	101x93	124x93	148x93	154x93	221x93	226x93	247x93	280x93	148x159	280x93	222x160	226x160	226x160	246x159	222x226

\* With Partition Plates

\*\*Suitable for Horizontal & Vertical Installation



1 - Module



2 - Module



3 - Module



4 - Module



4 - Module\* (2+2)



6 - Module



6 - Module\* (2+2+2)



8 - Module



8 - Module\* (2+2+2+2)



9 - Module\* (3+3+3)



8 - Module (V)



12 - Module



12 - Module\* (3+3+3+3)

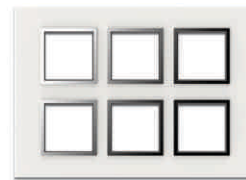

12 - Module\* (2+2+2+2+2+2)



18 - Module

**GRAZIA MOUNTING FRAMES - Horizontal & Vertical Distance for Screwing ( Dimensions in mm )**

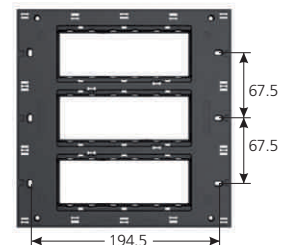
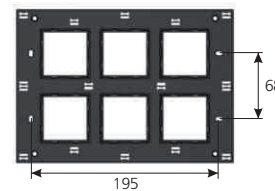
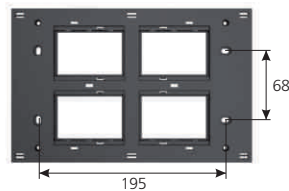
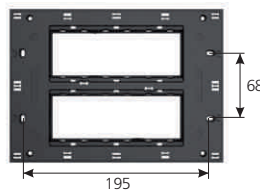
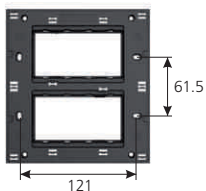
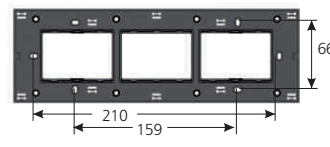
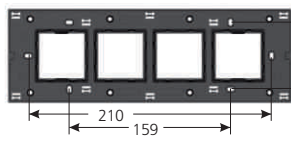
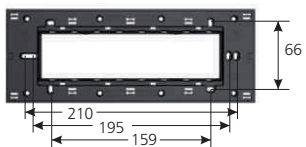
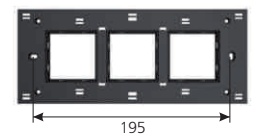
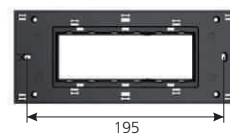
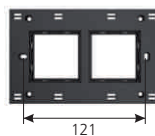
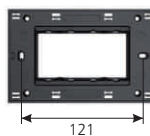
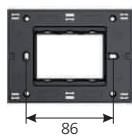
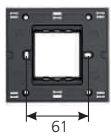

**GLASSIO COVER PLATES WITH MOUNTING FRAMES** NEW NEW

PLATES →	1M	2M	3M	4M	4M*	6M	6M*	8M	8M*	8M	9M*	12M	12M*	16M*	18M
					(H&V)**		(H&V)**		(H&V)**	(V)			(H&V)**		
COLOURS ↓	MRP ₹	MRP ₹	MRP ₹	MRP ₹	MRP ₹	MRP ₹	MRP ₹	MRP ₹	MRP ₹	MRP ₹	MRP ₹	MRP ₹	MRP ₹	MRP ₹	MRP ₹
Pure Glossy	80.00	80.00	99.00	121.00	121.00	173.00	173.00	219.00	219.00	219.00	235.00	250.00	250.00	282.00	319.00
Metallic	125.00	125.00	163.00	199.00	199.00	272.00	272.00	340.00	340.00	340.00	366.00	398.00	398.00	449.00	479.00
Metal Krome	186.00	186.00	260.00	316.00	316.00	423.00	423.00	569.00	569.00	569.00	580.00	584.00	584.00	642.00	677.00
VelvetTouch	182.00	182.00	248.00	305.00	305.00	408.00	408.00	558.00	558.00	558.00	566.00	572.00	572.00	627.00	666.00
Wood	166.00	166.00	226.00	277.00	277.00	378.00	378.00	518.00	518.00	518.00	526.00	530.00	530.00	587.00	619.00
CODE →	120101	120201	120301	120401	120404	120601	120604	120801	120804	128801	120901	121201	121204	121601	121801
PKG →	10	10	10	10	10	5	5	5	5	5	5	5	5	5	5
SIZE(mm) →	92x90	92x90	120x90	146x90	152x90	219x90	219x90	244x90	264x90	152x168	280x90	219x156	219x156	244x156	219x223

\* With Partition Plates

\*\*Suitable for Horizontal & Vertical Installation



1 - Module



2 - Module



3 - Module



4 - Module



4 - Module\* (2+2)



6 - Module



6 - Module\* (2+2+2)



8 - Module



8 - Module\* (2+2+2+2)



8 - Module (V)



12 - Module

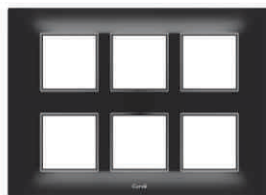

12 - Module\* (2+2+2+2+2)

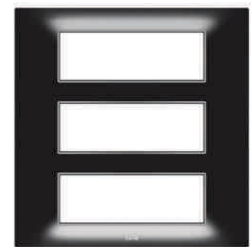

18 - Module

EA Poonawala  
95 Lohar Chawl  
Ph - 22035440, 2207  
eapoonawala@gmail.com

**GLASSIO MOUNTING FRAMES - Horizontal & Vertical Distance for Screwing (Dimensions in mm)**

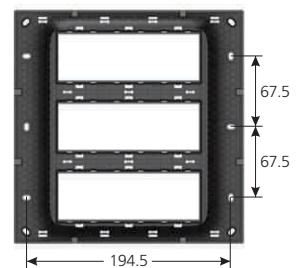
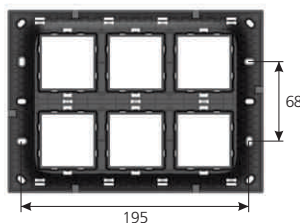
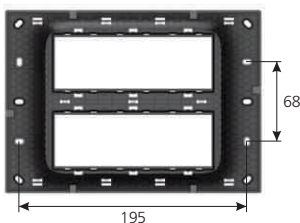
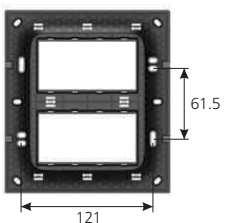
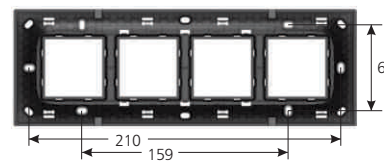
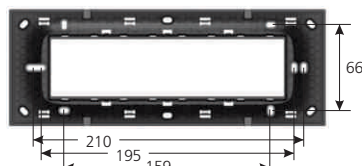
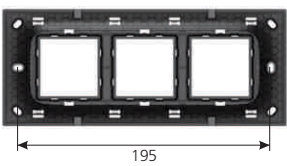
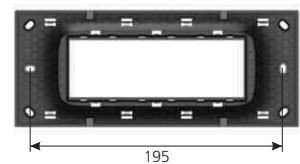
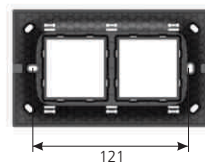
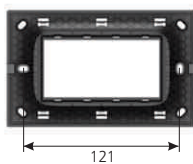
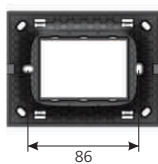



## COLOURS OF COVER PLATES

**bella**

### WHITE JAZZ



01 - White Jazz

### METALIK



06 - Spirit Gold



07 - Silver Streak



08 - Copper

### BELLESOFT

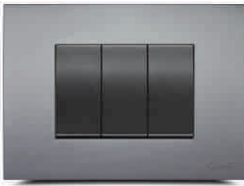

09 - Digital Chrome



16 - Pepper Leaf



17 - Deep Currant



18 - Blu Caspian

### ANTIK



21 - Voltage Grey



31 - Antik Copper



41 - African Wenge



44 - Burma Teak

### BELLEWOOD

**Cristallo**

### MEMORIO



01 - Memorio



Barbie

### WHITE JAZZ



02 - White Jazz

### TWIXOS



12 - Valentine Wine



13 - Herbal Spa

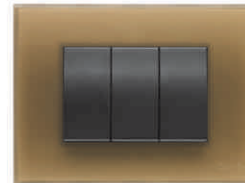

14 - Plum Island



15 - Ice Grey

### Metalik



21 - Ocean Pearl



22 - Gold



23 - Silver

### Wood



26 - Fumed Oak

## COLOURS OF COVER PLATES

### PURE GLOSSY



01- Absolute White



02 - Black Glossy



03- Ivory Gold\*

### METALLIC



06- Gold Mist\*



07 - Digital Silver\*



08 - Digital Chrome\*

### METAL KROME



11- Hyper Chrome\*



12- Satin Chrome\*



13- Miami Gold\*



14- Copper Cola\*



15- French Wine\*



16- Toronto Red\*



17- Charcoal Brown\*

### VELVET TOUCH



21- Apple Green\*



22- Mexican Peach\*



23- Cherry Red\*



24- Black Grape\*

### WOOD



31- Wild Wenge\*



32- Italian Espresso\*



33 - Zebra Wood\*



34- Moughal Teak\*

EA Poonawala  
95 Lohar Chawl  
Ph - 22035440, 22074651  
eapoonawala@gmail.com

COLOURS OF COVER PLATES

PURE GLOSSY



01- Absolute White



02 - Black Glossy\*

**basic**

METALLIC



06- Gold Mist\*



07 - Digital Silver

WOOD



11- Wild Wenge\*



12- Italian Expresso



13 - Zebra Wood



14 - Moughal Teak\*

PURE GLOSSY



20- Absolute White



21 - Black Glossy\*

**premium**

COLOURS OF COVER PLATES

GLASS

EXCLUSIVE



01 - Snow White



02 - Red Wine



03 - Green Ice



04 - Rich Black

CORIAN®



05 - Hot Red



11 - Glacier White



12 - Lava Grey



13 - Berry Red

BASIC

basic



16 - Satin White

METALLIC



17 - Digital Silver

BASIC WOOD



18 - Fumed Oak

GLASS

premium



21 - Snow White



22 - Red Wine



23 - Green Ice



24 - Rich Black

EA Poonawala  
 95 Lohar Chawl  
 Ph - 22035440, 22074651  
 eapoonawala@gmail.com



25 - Hot Red

Available only in 3 Module & 6 Module

Divinity



36 - Snow White\*



37 - Hot Red\*

Note: The wood cover plates may differ in their shades as they reflect a natural look.

## COLOURS OF COVER PLATES

### GLASS

Crystallight



41 - Mint Ice



42 - Honey Sapphire



43 - Black Diamond\*



44 - Ruby Red\*



45 - Magic Mirror

### PLUS



101 - Honey Dew

EA Poonawala  
95 Lohar Chawl  
Ph - 22035440, 22074651  
eapoonawala@gmail.com

### DIAMOND Crystal Studded



49 - Star Shine\*

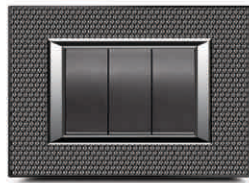

50 - Night Sky\*

Available only in 3 Module

### WOOD

XTREME



56 - Wenge\*



57 - Sycamore\*



58 - Zebrano\*

### STEEL



81 - Brushed Steel\*



82 - Signature Steel\*

### ALUMINIUM



86 - Brushed Black



87 - Brushed Silver

**FLUSH MOUNTING METAL GANG BOXES (GALVANIZED)**

GANG BOX →	1 & 2M	3M	4M	6M	8M(H)	8M(V)	12M	16M	18M
MRP ₹ ↓	59.00	78.00	96.00	119.00	155.00	155.00	195.00	240.00	275.00
CODE	70201	70302	70403	70604	70805	78806	71207	71608	71809
PKG	10	10	10	5	5	5	5	5	5
SIZE (WxHxL) mm	75x73x51	100x73x51	135x73x51	208x73x51	230x73x51	135x130x60	209x130x60	230x144x60	209x200x60

**METAL GANG BOXES**

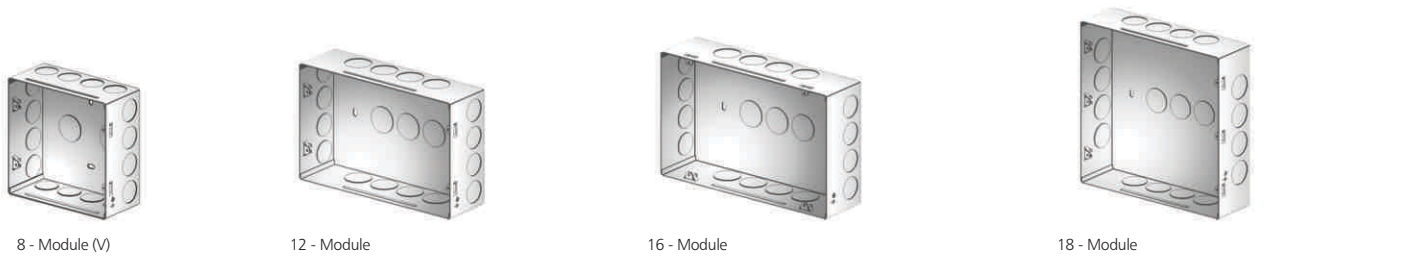
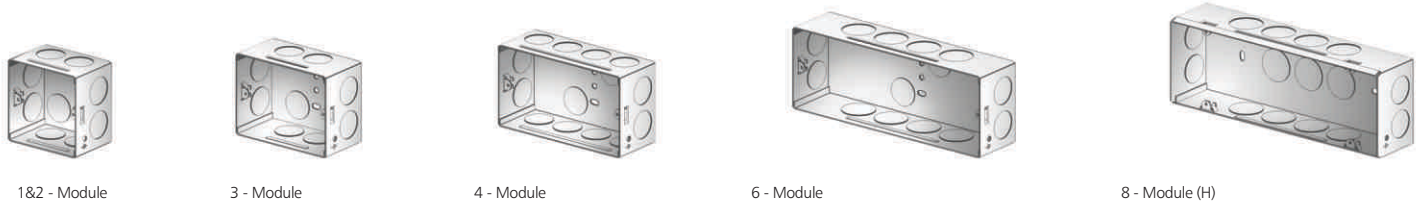

**FLUSH MOUNTING PLASTIC GANG BOXES (FIRE RESISTANT)**

GANG BOX →	1 & 2M	3M	4M	6M	8M(H)	8M(V)	12M	16M	18M
MRP ₹ ↓	46.00	54.00	64.00	84.00	97.00	97.00	135.00	158.00	192.00
CODE	80201	80302	80403	80604	80805	88806	81207	81608	81809
PKG	10	10	10	5	5	5	5	5	5
SIZE (WxHxL) mm	79x82x50	104x82x50	139x82x50	213x82x50	263x86x55	141x142x55	213x143x55	249x150x55	214x211x58

**PLASTIC GANG BOXES**

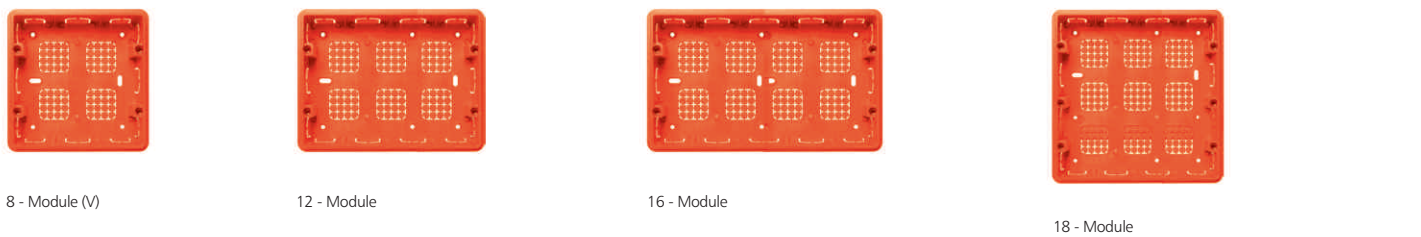
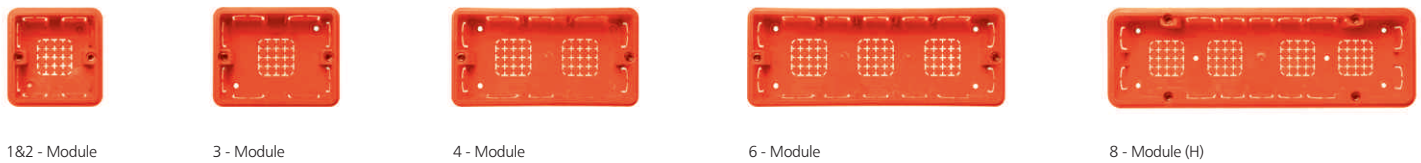

EA Poonawala  
95 Lohar Chawl  
Ph - 22035440, 22074651  
eapoonawala@gmail.com

**SURFACE MOUNTING PLASTIC GANG BOXES (FIRE RESISTANT)**

GANG BOX →	1 & 2M	3M	3M	4M	6M	8M(H)	8M(V)	12M	16M	18M
MRP ₹ ↓	47.00	70.00	70.00	74.00	93.00	118.00	118.00	150.00	167.00	199.00
CODE	90201	90302	93303	90404	90605	90806	98807	91208	91609	91810
PKG	10	10	10	5	5	5	5	5	5	5
SIZE (WxHxL) mm	92x85x48	124x85x48	118x85x48	150x85x48	218x85x48	267x85x48	153x154x48	219x154x48	267x154x48	224x227x48

PLASTIC SURFACE GANG BOXES



1&2 - Module



3 - Module



3 - Module\*



4 - Module



6 - Module



8 - Module (H)



8 - Module (V)

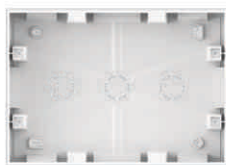

12 - Module



16 - Module

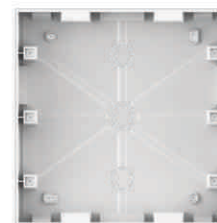

18 - Module

**G- SURFACE MOUNTING PLASTIC GANG BOXES (FIRE RESISTANT) Suitable for Grazia & Glassio**

**NEW**

GANG BOX →	1 & 2M	3M	4M	4M (HV)	6M	8M(H)	8M(HV)	8M (V)	9M	12M	16M	18M
MRP ₹ ↓	51.00	78.00	86.00	86.00	109.00	142.00	142.00	142.00	161.00	175.00	203.00	237.00
CODE	100201	100302	100403	100404	100605	100806	100807	108808	100909	101212	101611	101812
PKG	10	10	10	5	5	5	5	5	5	5	5	5
SIZE (WxHxL) mm	91x89x48	119x89x48	145x89x48	150x89x48	218x89x48	243x89x48	263x89x48	154x155x48	279x89x48	218x155x48	243x155x48	218x222x48

PLASTIC SURFACE GANG BOXES

Note: Not suitable for Grazia 8M (V) Plate



1&2 - Module



3 - Module



4 - Module



4 - Module(H&V)



6 - Module



8 - Module



8 - Module (H&V)



9 - Module



8 - Module (V)



12 - Module



16 - Module (H&V)

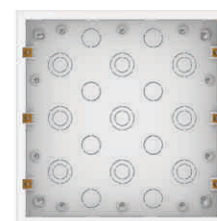

18 - Module

# G-Max

**THE  
POWER TO ILLUMINATE.  
THE PASSION TO  
INNOVATE.**

EA Poonawala  
95 Lohar Chawl  
Ph - 22035440, 22074651  
eapoonawala@gmail.com



**G-MAX** FIXED  
MODULAR COB LED LIGHT

WANT TO FOCUS YOUR LIGHT AT A SPECIFIC AREA THAT YOU DESIRE? YOU CAN DO IT WITH EASE USING THE G-MAX COB DOWNLIGHTS. ITS UNIQUE SWIVEL MECHANISM ENABLES YOU TO AIM THE G-MAX PRECISELY WHERE YOU NEED TO FOCUS ON. IN ADDITION, THE G-MAX CAN BE CUSTOMIZED TO YOUR AESTHETIC REQUIREMENTS: INSERT A DETACHABLE RING TO CREATE A RECESSED DOWNLIGHT OR REMOVE THE DETACHABLE RING FOR THE LED TO REMAIN FLUSH WITH THE SURFACE. THE G-MAX IS ALSO AVAILABLE IN A FIXED FORMAT WITHOUT DETACHABLE RING.





**G-MAX TILT**  
MODULAR COB LED LIGHT  
WITH RING

EA Poonawala  
95 Lohar Chawl  
Ph - 22035440, 22074651  
eapoonawala@gmail.com



**G-MAX TILT**  
MODULAR COB LED LIGHT  
WITHOUT RING



AVAILABLE IN COOL DAY LIGHT, NATURAL WHITE & WARM WHITE

EA Poonawala  
95 Lohar Chawl  
Ph - 22035440, 22074651  
eapoonawala@gmail.com

**Note:**

Reprinting and photomechanical reproduction is permitted only with our express approval. The aim of this catalogue is to inform you without any legal binding. Due to limitations of printing, images and illustrations of the products displayed may not be entirely accurate in terms of their colours, dimensions and individual components. Goldmedal reserves the right to make any changes as it deems fit to improve the functionality and performance of these products. Unless otherwise specified, the products illustrated in this catalog have been designed by Goldmedal and are covered by one or more international patents.

EA Poonawala  
95 Lohar Chawl  
Ph - 22035440, 22074651  
eapoonawala@gmail.com



For more information SMS  
**GWORLD to 56161**

Date of issue: April 2017.

Goldmedal Electricals Pvt. Ltd.  
Bldg. No. 2,  
Shripal Industrial Estate,  
Valliv Road, Vasai East,  
Palghar - 401208,  
Maharashtra,  
India.

**www.goldmedalindia.com**  
**info@goldmedalindia.com**

**Customer care toll free:**  
**1800 209 0234**



[www.facebook.com/  
goldmedalindia](http://www.facebook.com/goldmedalindia)



[www.twitter.com/  
goldmedalindia](http://www.twitter.com/goldmedalindia)



[www.youtube.com/  
goldmedalelectricals](http://www.youtube.com/goldmedalelectricals)