

Infinity M Power System

Dual Voltage, Rack Mounted Power System



The GE Infinity M DC energy system is a modular power plant that supports dual voltage (+24V/-48V) operation through the use of a comprehensive range of advanced rectifiers and DC-DC converters. Primary voltage is supported by rectifiers and battery reserve, while secondary voltage is supported by DC-DC converter modules. Primary voltage can be -48V or +24V.

The Infinity M Power System has primary voltage capacity for +24V and -48V power up to 1,600A; secondary voltage capacity is up to 600A per expansion module.

Shelf / Bay Options

Infinity M systems may be equipped in a 7ft 23" relay rack; a half height rack for mounting on battery stands; indoor or outdoor power cabinets; or mounting rails for field install applications. The distribution module is 14U (24.5") tall and accommodates up to 80 single voltage or selectable voltage bullet breaker positions. Universal shelves are 1U tall with four slots that accept any Infinity series rectifier or converter interchangeably in any power slot. This allows the available slots to be filled with the mix of power modules desired.

The only restriction is whether AC power is applied to the shelf. This gives extreme flexibility in the provisioning of power modules within the system.

Infinity Rectifier and Converter Family

The Infinity Series offers DC rectifiers and converters for both +24V to -48V and -48V to +24V applications. For easy module selection, the rectifiers and converters are color coded to quickly identify voltage, module type and input voltage type (AC or DC).

Galaxy Pulsar* Plus Controller

The Galaxy Pulsar Plus is used throughout many of the GE DC Power products including Infinity, CP, and SPS with the only differentiator being the form factor which is scaled to meet the nature of the application. The controller utilizes standard network management protocols allowing for advanced network supervision with SNMP communications to deliver extensive monitoring and control features with both local and remote access.

Features and Benefits

Reliability

- Distributed fault tolerance
- Proven field performance
- Controller continuity

Intelligence

- Industry leading controller features
- Ethernet interface for remote access
- Centralized network management

Investment Protection

- Module Compatibility
- Power Shelf Growth
- Secondary Voltage flexibility +24V / -48V
- Flexible Upgrade Options

- *ECO Priority Source** Ready
- Dual Voltage power system with ultimate flexibility
- -48V up to 1,600A (86KW) or +24V up to 1,600A (44KW)
- Secondary Voltage Load capacity up to 600A
- High availability wireless telecom applications
- Telecom service providers
- Efficiency approaching 97%



Infinity Rectifiers and Converters



- **Compact** – 1RU form factor providing high power density (24 W/in³)
- **Dual Voltage compatibility** – the unique connector pin designation allows the rectifier to be used in a “universal” power shelf, alongside rectifiers or DC-DC converters with different output voltages.
- **Plug and Play** – installation of the rectifier in a shelf connected to a compatible system controller initializes all set up parameters automatically. No adjustments are needed.
- **Extended service life** – parallel operation with automatic load sharing ensures that parallel units are not unduly stressed even when a unit fails or is removed.
- **Monitoring / control** – the built in microprocessor controls and monitors all critical rectifier functions and communicates with the system controller using the built in Galaxy Protocol serial interface.
- **Fail safe performance** – hot insertion capabilities allow for converter replacement without system shutdown; soft start and inrush current protection prevent nuisance tripping of upstream breakers.

Applications

- Telecommunications Networks
- Digital Subscriber Line (DSL)
- Indoor/Outdoor Wireless
- Routers/Switches
- Fiber in the Loop
- Transmission
- Data Networks
- Distributed Antenna Systems
- Off-Grid/On-Grid Renewable Energy Sites

Key Features

- Extended temperature range
- Redundant fan cooling
- Front panel LED indicators
- 1U height, hi power density
- 220/110V AC input
- Digital load sharing
- Hot pluggable
- RoHS compliant
- Direct solar input (no inverter required)

Specifications

Input	NE100AC24ATEZ NE100ECO24ATEZ	NE050AC48ATEZ NE050ECO48ATEZ	NE075AC48ATEZ ¹	NE030DC48A	NE040DC48AZ ¹	NE075DC24A
Voltage Range	95-275Vac	95-275Vac	95-275Vac	21-30Vdc	21-30Vdc	42-60Vdc
Input Current	15-12A @ 100-120Vac 15-12A @ 200-240Vac	15-12A @ 100-120Vac 15-12A @ 200-240Vac	15-12A @ 100-120Vac 22-18A @ 200-240Vac	63A @ 27Vdc 81A @ 21Vdc	94A @ 27Vdc 108A @ 21Vdc	41A @ 54.5Vdc 54A @ 42Vdc
Input Frequency	45 – 66Hz	45 – 66Hz	45 – 66Hz	-	-	-
Power Factor	0.98 at>50% load	0.98 at>50% load	0.98 at>50% load	-	-	-
Efficiency	> 95% (Peak 95.6%)	> 96% (Peak 96.9%)	> 96% (Peak 96.9%)	-	-	-
Total Harmonic Distortion	<5% @loads over 50%	<5% @loads over 50%	<5% @loads over 50%	-	-	-
Output						
Voltage Adjust Range	21-29Vdc	42-58Vdc	42-58Vdc	46-57Vdc	46-57Vdc	23-28Vdc
Voltage Nominal	27.25V	54.5V	54.5V	52.0V	52.0V	27.2V
Regulation (with controller)	±0.5%	±0.5%	±0.5%	±0.5%	±0.5%	±0.5%
Ripple	100mVrms	100mVrms	100mVrms	100mVrms	100mVrms	100mVrms
Output Current - High-Line	114A @24V	57A @48V	85A@48V	30A @52.0V	40A @52.0V	75A @27.2V
- Low-Line	100A @27.25V 44A @27.25V	50A @54.5V 22A @54.5V	75A @54.5V 22A @54.5V	-	-	-
Heat Dissipation @ max out	174W / 594 BTU/hr	158W / 539 BTU/hr	249W / 850 BTU/hr	154W / 525 BTU/hr	205W / 700 BTU/hr	202W / 689 BTU/hr

¹ For systems built prior to December 1, 2013, the NE075 rectifier and NE040 converter output will automatically de-rate to 60A and 30A respectively. All systems built beyond this date will allow operation at full capacity.

Environmental	
Operating Temperature	-40°C to +75°C (-40°F to 167°F) Full capacity up to 55°C; output derates 2%/°C from 55°C to 75°C
Storage Temperature	-40°C to +85°C (-40°F to 185°F)
Humidity	< 95% non-condensing
Altitude	4000M (for altitudes above 2000M, peak operating temperature de-rates 0.656° C /100M; 4000M peak temperature rating is 62° C
Mechanical	
Length (inch/mm)	13.85 / 351.8
Width (inch/mm)	5.23 / 133
Height (inch/mm)	1.63 / 42
Weight (lb/Kg)	5.05 / 2.2
Safety and Standards Compliance	
NEBs Level 3	Evaluated by independent NRTL test lab to Telcordia GR63, Issue 3 & GR 1089, Issue 5
Safety	CE mark to Low Voltage Directive 2006/95/EC and EMC Directive 2004/108/E (Rectifiers only) UL 60950-1, 2nd Ed. Recognized CSA C22.2 No. 60950-1-03 Certified
RoHS	Compliant to RoHS EU Directive 2002/95/EC; RoHS 6/6 models with Z suffix (RoHS 5/6 all other models)
EMC	European Directive 2004/108/EC; EN55022, Class A; EN55024; FCC, Class A; GR1089-CORE, Issue 5
ESD	EN61000-4-2, Level 4

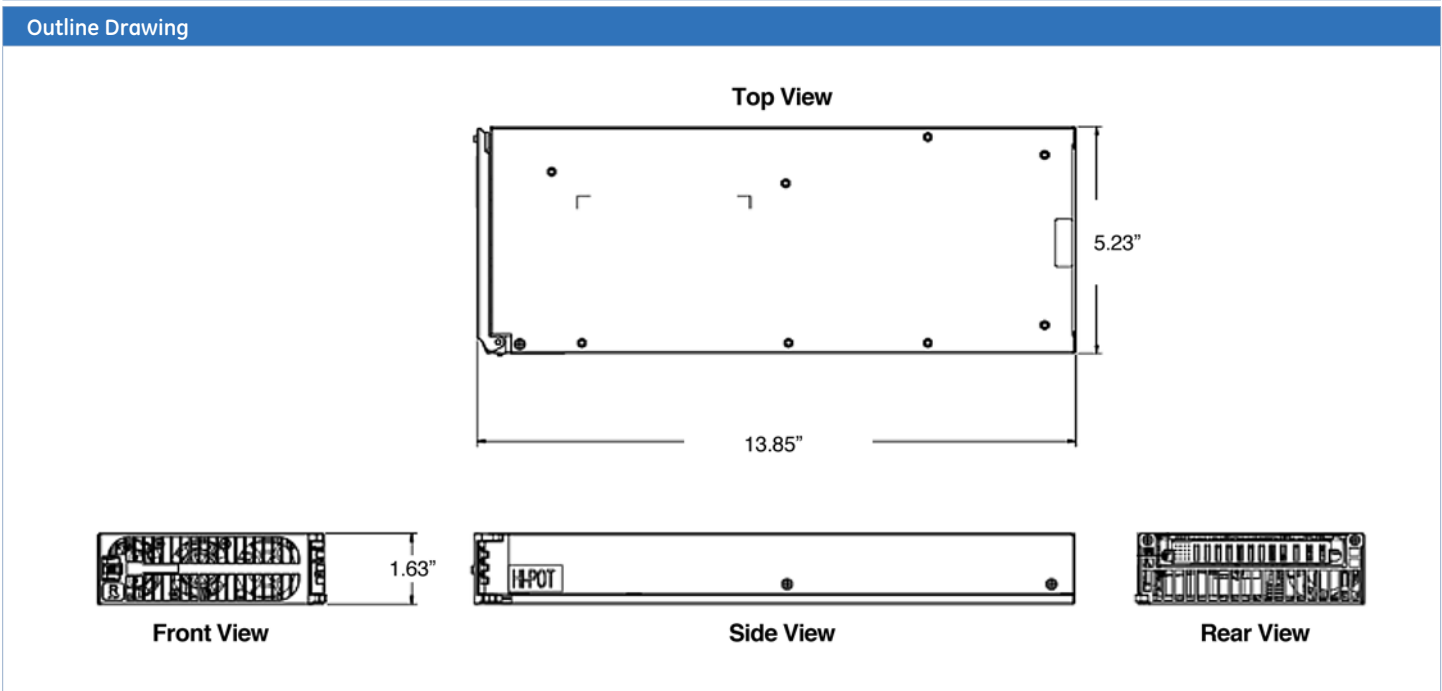

Pulsar Plus Controller



The Pulsar Plus family of controllers provides system monitoring and control features for Infinity, CP, and other power systems. These controllers monitor and control system components including rectifiers, converters, and distribution modules via a multi-drop RS485 digital communications bus. System status, parameters, settings, and alarm

thresholds can be viewed and configured from the controller's front panel display. Assignment and configuration of alarm inputs and output relays can be performed from a laptop computer connected to a local RS-232 or Ethernet port, or by remote access is through a network connection to the World Wide Web (internet) or your enterprise network (intranet). An optional modem is also available.

This controller utilizes standard network management protocols allowing for advanced network supervision. The

GE Galaxy Manager™ software is the centralized visibility and control component of a comprehensive power management system designed to meet engineering, operations and maintenance needs. The Galaxy Manager client-server architecture enables remote access to system controllers across the power network, featuring **ECO Priority** advanced monitoring features which provides detailed energy source analysis to help better customize your renewable energy resources.

Applications

- Telecommunications Networks
- Digital Subscriber Line (DSL)
- Indoor/Outdoor Wireless
- Routers/Switches
- Fiber in the Loop
- Transmission
- Data Networks
- PBX
- Off-Grid/On-Grid Renewable Energy Sites

Key Features

Remote Access and Features

- Integrated 10/100Base-T Ethernet Network
 - TCP/IP
 - SNMP V2c for management
 - SMTP for email
 - Telnet for command line interface
 - DHCP for plug-n-play
 - FTP for rapid backup and upgrades
 - HTTP for standard web pages and browsers
 - Compatible with Galaxy Manager and other management packages
 - Shielded RJ-45 interface referenced to chassis ground
- Password protected security levels: User, Super-User, Administrator for all access
- Ground-referenced RS232 system port
- ANSI T1.317 command-line interface
- Modem access support
 - Remote via external modem
 - Callback security
- EasyView2, Windows-based GUI software for local terminal or Modem access
- **ECO Priority** controls and features
 - Advanced generator controls to help minimize fuel consumption for off grid applications
 - ECO Energy Management allowing for non-ECO sources outputs to be minimized while ECO resources are available
 - Source and load trend logging

Standard System Features

- Monitor and control of more than 40 connected devices
 - Robust RS485 system bus
- Standard and user defined alarms
 - Alarm test
 - Assignable alarm severity: Critical, Major, Minor, Warning, and record-only
 - 10 alarm relays (7 user assigned)
- Rectifier management features
 - Automatic rectifier restart
 - Active Rectifier Management ARM (energy efficiency)
 - Remote rectifier (on/off)
 - Reserve Operation
 - Automatic rectifier sequence control
 - N + X redundancy check
- Multiple Low Voltage Load and Low Voltage Battery Disconnect thresholds
- Configuration, statistics, and history
 - All stored in non-volatile memory
 - Remote/local backup and restore of configuration data
- Industry standard defaults
 - Customer specific configurations available
- Remote/ local software upgrade
- Basic, busy hour, and trend statistics
- Detailed event history
- User defined events and derived channels

Standard Battery Management Features

- Float/boost mode control
 - Manual boost
 - Manual timed boost locally, T1.317, and remotely initiated
 - Auto boost terminated by time or current
- Battery discharge testing
 - Manual (local/remote)
 - Periodic
 - Plant Battery Test (PBT) input driven
 - Configurable threshold or 20% algorithm
 - Graphical discharge data
 - Rectifiers on-line during test
- Slope thermal compensation
 - High temperature
 - Low temperature
 - Step temperature
 - STC Enable/Disable, low temperature Enable/Disable
 - Configurable mV/°C slopes
- State of charge indication
- High temperature disconnect setting
- Reserve-time prediction
- Recharge current limit
- Emergency Power-Off input

Integrated Monitoring Inputs/Outputs

- System plant voltage (accuracy $\pm 0.5\%$, resolution 0.01V)
- One system shunt (accuracy $\pm 0.5\%$ full scale, resolution 1A)
 - Battery or load
 - Mounted in the return side of DC bus
- Up to 15 binary inputs
 - Six inputs close/open to battery
 - 9 input close/open to return
 - User assignable
- Up to 7 Form-C output alarms (60VDC @ .5A)
 - User assignable
- 1-Wire™ bus devices
 - Up to 16 temperature probes (QS873)
 - Up to 6 mid-string monitors (ES771)

General	
Operating Voltage	± 24 Vdc, ± 48 Vdc (Range: ± 18 to ± 60 Vdc)
Input Power	Less than 7W
Operating Temperature Range	-40°C to +75°C (-40°F to 167°F)
Operating Relative Humidity	0 - 95% (non-condensing)
Storage Temperature Range	-40°C to +85°C (-40°F to 185°F)
Physical Specifications	Sizes vary by packaging option
Display	8-line by 40-character with alarm context sensitive backlit LCD

The image shows three overlapping LCD display screens. The top screen is red and displays '-54.48V, 100A' with 'CHARGE' and 'Menu' buttons. The middle screen is yellow and displays '-54.48V, 100A' with 'CHARGE' and 'Menu' buttons. The bottom screen is green and displays '-54.48V, 100A' with 'Float', 'No Alarms', and 'Menu' buttons. Labels 'Amber' and 'Red' are placed below the middle and top screens respectively, and 'Green' is placed below the bottom screen.

Galaxy Manager Compatible

- Centralized web server and database with multiple user access to live or managed data with drill down to problem details
- Monitor and control of more than 40 connected devices
- Management information from polling or alarms received from alarm traps from multiple sites are available on one screen via the inter/intranet
- Trend user selected data over time
- Automatic or manual report generation
- Standard engineering tools like reserve time calculators and cable voltage drop analyzer

Safety and Standards Compliance	
NEBs	Evaluated by independent NRTL test lab to Telcordia GR63, Issue 3 and GR1089-CORE, Issue 5
Safety	CSA C22.2 No. 60950-1-03 Certified for Canada and U.S.; UL60950-1 1st Ed.
RoHS	Compliant to RoHS EU Directive 2002/95/EC RoHS 5/6
EMC	European Directive 2004/108/EC; EN55022, Class A, EN55024; FCC, Class A; GR1089-CORE, Issue 5

Agency Certifications	
NEBs Level 3	Evaluated by independent NRTL test lab to Telcordia GR63, Issue 3 and GR1089-CORE, Issue 5
EMC	European Directive 2004/108/EC; EN55022, (CISPR22) Class A, EN55024 (CISPR24)
Safety	Underwriters Laboratories (UL) Listed per Subject Letter 1801: Power Distribution Center for Communications Equipment, and cUL Certified (CSA 22.2 950): Safety of Information Technology Equipment

Infinity M System



Infinity M may be configured as a +24V or -48V single voltage power system or as a dual voltage power system that supports rectifiers and converters. The primary voltage is supported by +24V or -48V rectifiers and battery reserve, while secondary voltage is supported by DC-DC converters. Infinity-M includes dedicated 24V, 48V and return buses. The primary voltage capacity is 1,600A at 24V and 1,600A at 48V. Secondary voltage capacity is up to 600A. The system includes low voltage battery disconnect option for the primary voltage. A low voltage load disconnect option can be used for load shedding to maintain critical loads.

Applications

- Wireless Telecom Networks
- Central Office
- Indoor/Outdoor Wireless
- Remote Radio Sites
- Data Networks
- Off-Grid/On-Grid Renewable Energy Sites

Key Features

- Dual Voltage Flexibility
- Redundant fan cooling
- Front panel LED indicators
- 1U height, high power density
- 220/110 V AC input
- Digital load sharing
- Hot pluggable
- RoHS compliant
- **ECO Priority** ready

Specifications

Input	Min	Typ	Max
Voltage Range			
- High-Line	175Vac	220Vac	275Vac
- Low-Line	85Vac	110Vac	140Vac
Frequency	45Hz	60Hz	66Hz
Power Factor	98%	99.5%	
Total Harmonic Distortion			5%
Primary Output			
Nominal Voltage	24Vdc		-48Vdc
Output Current	1,600A		1,600A
Vo Setpoint (factory)	27.2Vdc±1%		-54.5Vdc±1%
Vo Range	+21Vdc to +29Vdc		-42Vdc to -58Vdc
Regulation	±0.5%		
Secondary Output			
Nominal Voltage	-48Vdc		24Vdc
Output Current	600A		600A
Vo Setpoint (factory)	-54.5Vdc±1%		27.2Vdc±1%
Vo Range	-42Vdc to -58Vdc		+21Vdc to +29Vdc
Regulation	±0.5%		
Mechanical			
Height (in. /mm)	31.5 / 800 (Base system with 4 power shelves)		
Width (in. /mm)	23 / 584.2 (Standard Frame)		
Depth (in. /mm)	21 / 533.4		
Weight (lb / Kg)	350 / 159 (Base System with 4 power shelves and 7ft frame, no rectifiers)		

Environmental	
Operating Temperature	-40°C to +75°C (-40°F to 167°F)
Storage Temperature	-40°C to +85°C (-40°F to 185°F)
Relative Humidity	95% max, non-condensing
Altitude	4000M (for altitudes above 2000M, peak operating temperature de-rates 0.656° C /100M; 4000M peak temperature rating is 62° C)

Safety and Standards Compliance	
NEBs	Evaluated by independent NRTL test lab to Telcordia GR63, Issue 3 and GR1089-CORE, Issue 5
Safety	CSA C22.2 No. 60950-1-03 Certified for Canada and U.S.; UL60950-1 1st Ed.
RoHS	Compliant to RoHS EU Directive 2002/95/EC RoHS 5/6
EMC	European Directive 2004/108/EC; EN55022, Class A; EN55024; FCC, Class A; GR1089-CORE, Issue 5

Agency Certifications	
CSA	CSA C22.2 No 60950-1-03 and UL 60950-1 1st Ed
EMI/EMC	European Directive 2004/108/EC; EN55022 (CISPR22) Class A; EN55024 (CISPR24)
NEBS LEVEL 3	GR1089-CORE, Issue 5

Outline Drawing (for visual reference only)

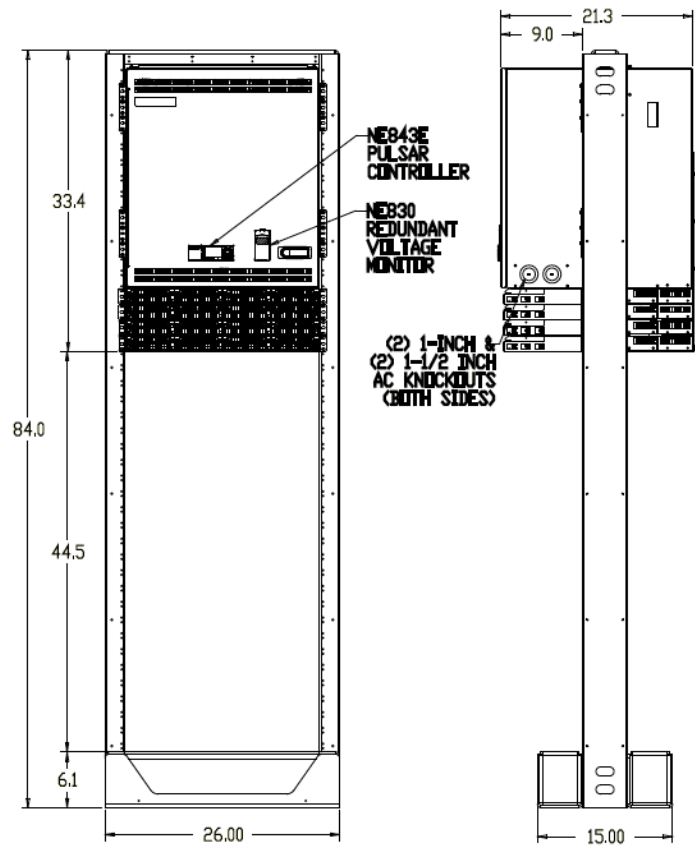

Ordering Information – Infinity M Power System

Ordering Guide

Infinity M may be configured as a +24V or -48V single voltage power system or as a “dual voltage” power system that supports rectifiers and converters. The primary voltage is supported by +24V or -48V rectifiers and battery reserve, while secondary voltage is supported by DC-DC converters. The primary voltage capacity is 1,600A at 24V and 1,600A at 48V. Secondary voltage capacity is up to 600A.

Infinity M systems may be equipped in a 7ft framework, a half height (42”) frame for mounting on battery stands, or supplied frameless for field install applications.

Features

- Infinity Series Rectifiers for +24V and -48V applications.
- Dual Voltage Bus architecture for easy growth and voltage migration
- DC-DC Converter support for dual voltage systems
- DC Distribution for both voltages, with Selectable Voltage panel availability
- Temperature hardened harsh environments. (-40°C to +75°C)
- Compact size: Base System with 4 power shelves occupies 18 RU (31.5 in) of 23” wide rack space (21” depth)
- Frame options – Factory installed in 7ft or 42” tall, 23” wide frame or field installed in user supplied frame
- Battery connections, LVBD and LVLD options.
- Plug-N-Play Pulsar Plus controller with Web based interface for local and remote (LAN) access.
- Distribution options include 3A-250A bullet style circuit breakers, large G-J breakers to 600A and GMT fuses



Additional Information









Product Documentation

- H5692448: Ordering Guide
A copy of the appropriate installation manuals below ship with each system.
- CC848815325: H5692448 Installation Guide
- CC848815341: Advanced Features User Guide for the Pulsar Plus Controller, 167-792-183

Step 1: Select the Base Power System

-48V Primary Voltage Systems				
Output	Ordering Code	Model	Frame	Picture
 800A	CC109152220	800A -48V single voltage system, includes 65 bullet breaker positions, plus 8 positions for large breakers, 4 Universal power shelves in 7ft Zone 4 frame, Door Mounted Pulsar 843C Controller, NO LVBD	7ft x 23" (Approx 34" open at bottom) System Width 23"	
 1200A	CC109152212	1,200A -48V single voltage system, includes 65 bullet breaker positions, plus 8 positions for large breakers, 6 Universal power shelves in 7ft Zone 4 frame, Door Mounted Pulsar 843C Controller, NO LVBD	7ft x 23" (Approx 30" open at bottom) System Width 23"	
 1200A	CC109159224	1,200A -48V single voltage system, includes 65 bullet breaker positions, plus 8 positions for large breakers, 6 Universal power shelves in 7ft Zone 4 frame, Door Mounted Millennium 2 Controller, NO LVBD	7ft x 23" (Approx 30" open at bottom) System Width 23"	
-48V Primary Voltage Systems with +24V Converters				
Output	Ordering Code	Model	Frame	Picture
 48V, 800A 24V, 300A	CC109146610	800A 48V system, includes 80 cb positions (65 positions primary voltage and 15 positions selectable voltage), 4 Universal Power shelves, in 7ft Zone 4 frame (maximum 1200 lbs.), Door Mounted Pulsar 843C Controller, NE830 Voltage Monitor, LVBD	7ft x 23" (Approx 34" open at bottom) System Width 23"	
 48V, 1000A 24V, 300A	CC109136917	1,000A 48V system, includes 55 cb positions (40 positions primary voltage and 15 positions selectable voltage), 5 Universal Power shelves, in 42", half height frame, Door Mounted Pulsar 843C Controller, NE830 Voltage Monitor, NO LVBD	42" x 23" System Width 23"	
 48V, 1200A 24V, 300A	CC109142007	1,200A 48V system, includes 80 cb positions (65 positions primary voltage and 15 positions selectable voltage), 6 Universal power shelves, in 7ft Zone 4 frame, Door Mounted Pulsar 843C Controller, NE830 Voltage Monitor, No LVBD	7ft x 23" (Approx 30" open at bottom) System Width 23"	

Step 1: Select the Base Power System

+24V Primary Voltage Systems with -48V Converters				
Output	Ordering Code	Model	Frame	Picture
 24V, 1200A 48V, 120A	CC109141974	1,200A (1,600A max) 24V system, includes 80 cb positions (65 positions primary voltage and 15 positions selectable voltage), 4 Universal Power shelves, LVBD, 7ft Zone 4 frame, Door Mounted Pulsar 843C Controller, NE830 Voltage Monitor, LVBD	7ft x 23" (Approx 34" open at bottom)	
		H5692448, G103, G843C, G830, G210, G618, G622(2), 600N	System Width 23"	
 24V, 1600A 48V, 120A	CC109141990	1,600A 24V system, includes 80 cb positions (65 positions primary voltage and 15 positions selectable voltage), 6 universal power shelves & 1 dedicated converter shelf in 7ft Zone 4 frame (maximum 1200 lbs.), Door Mounted Pulsar 843C Controller, NE830 Voltage Monitor, NO LVBD	7ft x 23" (Approx 34" open at bottom)	
		H5692448, G104, G843C, G830, G210, G618, G622(2), G300(2), G700	System Width 23"	
 24V, 1200A 48V, 120A	CC109141966	1,200A (1,600A max) 24V system, includes 80 cb positions (65 positions primary voltage and 15 positions selectable voltage), 4 Universal Power shelves, in 7ft Zone 4 frame (maximum 1200 lbs.), Door Mounted Pulsar 843C Controller, NE830 Voltage Monitor, NO LVBD	7ft x 23" (Approx 34" open at bottom)	
		H5692448, G104, G843C, G830, G210, G618, G622(2)	System Width 23"	
 24V, 1200A 48V, 120A	150021839	1,200A (1,600A max) 24V system, includes 80 cb positions (50 positions primary voltage and 30 positions selectable voltage), 4 Universal Power shelves, in 7ft Zone 4 frame (maximum 1200 lbs.), Door Mounted Pulsar 843C Controller, NE830 Voltage Monitor, LVBD	7ft x 23" (Approx 34" open at bottom)	
		H5692448, G104, G843C, G830, G210, G619, G622(2), G600N	System Width 23"	

Step 2: Select Rectifiers and Converters

Rectifiers			
	Ordering Code	Model	Photo
 100A	CC109160834	95 - 145Vac input, 24V, 44A output (max. 50A@24V) 175 - 275Vac input, 24V, 100A output (max. 114A @24V) 145 - 175 linear output increase from 44A to 100A NE100AC24ATEZ	
 100A	150025075	95 - 145Vac input, 24V, 44A output (max. 50A@24V) 175 - 275Vac input, 24V, 100A output (max. 114A @24V) 145 - 175 linear output increase from 44A to 100A 100 - 310 VDC input from Solar resource with full power above 250VDC. NE100ECO24ATEZ	
 75A	CC109163473	95 - 145Vac input, 48V, 22A output (max. 25A@48V) 175 - 275Vac input, 48V, 75A output (max. 85A@48V) 145 - 175 linear output increase from 22A to 75A NE075AC48ATEZ	
 50A	CC109158878	95 - 145Vac input, 48V, 22A output (max. 25A @48V) 175 - 275Vac input, 48V, 50A output (max. 57A @48V) 145 - 175 linear output increase from 22A to 50A NE050AC48ATEZ	
 50A	150025074	95 - 145Vac input, 48V, 22A output (max. 25A @48V) 175 - 275Vac input, 48V, 50A output (max. 57A @48V) 145 - 175 linear output increase from 22A to 50A 100 - 310 VDC input from Solar resource with full power above 250VDC. NE050ECO48ATEZ	
Converters			
	Ordering Code	Model	Photo
 30A	CC109112471	21-30Vdc input, 48V, 30A output NE030DC48A	
 40A	150023619	21-30Vdc input, 48V, 40A output NE040DC48AZ	
 75A	CC109142881	42-60Vdc input, 24V, 75A output NE075DC24A	



Step 3: Select Alarm Cables



Alarm Cables		
Ordering Code	Model	Photo
CC848865980	15ft Auxiliary input alarm cable for Pulsar Plus Controller	
CC848817651	50ft Auxiliary input alarm cable for Pulsar Plus Controller	
CC848817668	150ft Auxiliary input alarm cable for Pulsar Plus Controller	
CC109157442	15ft alarm cable for Pulsar Plus Controller	
CC848817635	50ft alarm cable for Pulsar Plus Controller	
CC848817643	150ft alarm cable for Pulsar Plus Controller	

Step 4: Select Distribution Components



Bullet Style Load Circuit Breakers				
Ordering Code	Amperage	CB Positions (Poles)	Min Wire Gauge	Photo
407998137	3	1	10	
407998145	5	1	10	
407998152	10	1	10	
407998160	15	1	10	
407998178	16	1	10	
407998186	20	1	10	
407998194	25	1	10	
407998202	30	1	10	
408213486	40	1	8	
407998210	45	1	8	
407998228	50	1	6	
407998236	60	1	6	
407998244	70	1	2	
407998251	80	1	2	
407998269	90	1	2	
407998277	100	1	2	
CC848808551	100	2	2	
408185353	125	2	2	
408185346	150	2	1/0	
408564941	200	3	2/0	
CC408573975	225	3	4/0	
408535752	250	3	4/0	
CC848756916	2-pole Adapter bus for 100-150A breakers (order 2 per 2 pole breaker to accommodate load and return lugs)			
850021775	2-pole Adapter bus for 100-150A breakers; used for 3/8" on 1" lugs (order 2 per 2 pole breaker to accommodate load and return lugs)			
CC848756924	3-pole Adapter bus for 200-250A breakers (order 2 per 3 pole breaker to accommodate load and return lugs)			
850021955	3-pole Adapter bus for 200-250A breakers; centered connection (order 2 per 3 pole breaker to accommodate load and return lugs)			



Step 4: Select Distribution Components (cont.)

KS22012 GJ Style Breaker Kits for Field Installation of Group 617 / 614 Distributions		
Ordering Code	Description	Photo
CC109127635	150A Single Pole Breaker	
CC109127627	250A Single Pole Breaker	
CC109127486	400A Two Pole Breaker	
CC109151767	600A Three Pole Breaker	

Bullet Style Fuse Holder and TPS Fuses				
Ordering Code	Amperage	WP-92461 List	Min Wire Gauge	Photo
406700567	3	100	10	
406700583	5	101	10	
406700591	6	102	10	
406700609	10	103	10	
406700617	15	104	10	
406700625	20	105	10	
406700633	25	106	10	
406700641	30	107	10	
406700658	40	108	10	
406700674	50	109	8	
406700682	60	110	6	
406700690	70	111	6	
402328926	0.18 Alarm Fuse			
408548944	Bullet Fuse Holder, TFD-101-011-09 (Alarms on Blown Fuse or Fuse Head Removal)			
CC408617410	Bullet Fuse Holder, TFD-101-011-10 (Alarms on Blown Fuse Only)			

Step 4: Select Distribution Components (cont.)

Bullet Style GMT Fuse Holder and GMT Fuses				
Ordering Code	Amperage	WP-92461 List	Min Wire Gauge	Photo
405006222	0.25A			
3150439	0.5A			
405673146	1.33A			
405181983	2A			
406976985	3A			
406159061	5A			
405725433	7.5A			
406159236	10A			
407845197	12A			
406473959	15A			
CC109103157	6-pos GMT Bullet Fuse Holder (Requires 2 bullet positions)			
408515823	Fuse Puller			
402099436	Dummy Fuse			

Terminal Lugs for Bullet Style Breakers and TPS Fuses (1/4" bolt on 5/8" centers)				
Ordering Code	STR Wire GA (Class B)	Flex Wire GA (Class I)	WP-91412 List	Photo
406021626	8	8	75	
405347519	6	6	3	
405347576	4	4	5	
405348202	2	-	54	
405347683	-	2	8	
Terminal Lugs for Battery and Large Breakers (3/8" bolt on 1" centers)				
406338665	2	-	-	
405348228	1/0	-	-	
405348236	2/0	1/0	-	
406021725	-	2/0	-	
405348251	4/0	-	-	
405347923	-	4/0	-	
Terminal Lugs for Battery and Large Breakers (3/8" bolt on 1" centers) – Large Wire Lugs				
407890763	350	-	-	
407890748	-	350	-	
406335141	750	-	-	
407890730	-	750	-	

Step 5: Select Remote Peripheral Monitoring Options (Millennium 2 Controller only)

Ordering Code	Description			Photo
	Modules	# Inputs	# Temp	
108469461	J85501G1L21 RPM Shunt Monitoring (221F)	6	1	
108469479	J85501G1L22 RPM Voltage 0-200VDC (221D)	6	1	
108469495	J85501G1L23 RPM Transducers (221J)	6	1	
108298431	J85501G1L24 RPM Voltage 0-3VDC (221A)	6	1	
108298498	J85501G1L25 RPM Voltage 0-16VDC (221B)	6	1	
108469503	J85501G1L26 RPM Voltage 0-70VDC (221C)	6	1	
108298449	J85501G1L27 RPM Binary (222A)	6	1	
108483538	J85501G1L28 RPM Temperature (223T)	0	7	
108298456	J85501G1L9 RPM Control Relay (214A)	3	0	
Supporting Material				
407377704	Connecting Cable for RPMs (Order by foot)			
848535332	Blue panel for mounting 6 modules above a GPS cabinet			
848412367	White panel for mounting 6 modules in a 23-inch frame inside GPS bay			
847307410	12' Cable to be used with Temperature Probes			
847917879	½" Diameter Ring Terminal Temperature Probe (Cable Required)			
848528881	5/16" Diameter Ring Terminal Temperature Probe (Cable Required)			
405298308	Termination Resistor (1 per bus)			
406712968	Ferrite Bead (1 per bus)			
403607955	Monitor Channel cable KS13385 22AWG stranded pair, R&Bk (order by the foot)			
108984477	23" grey panel, 6 RPM mounting panel for Lorain plants			

Millennium Remote Monitoring

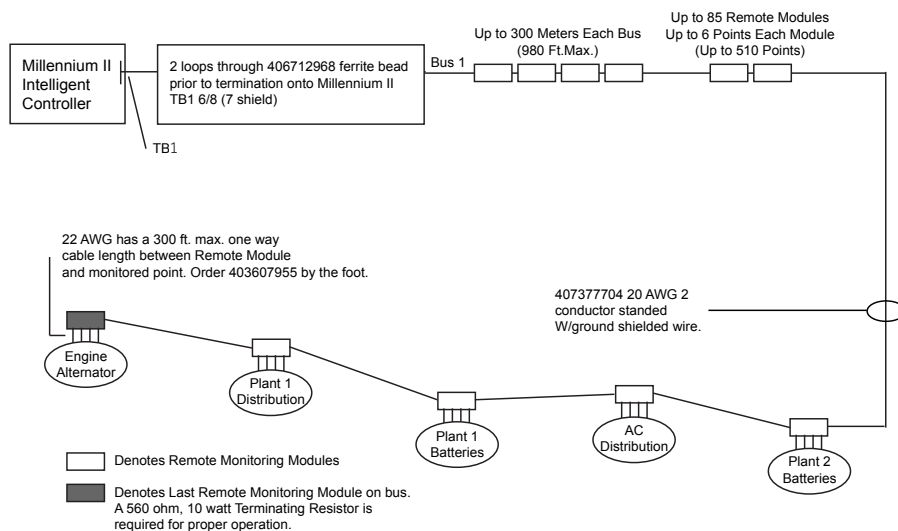

Step 6: Select Battery Monitoring

Ordering Code	Description	Photo
CC109142980	QS873A Thermal Probe (A)	
150026698	QS873B Ambient Thermal Probe (A)	
CC848817024	10 ft wire set (B: thermal probe to controller)	
CC109157434	20 ft wire set (B: thermal probe to controller)	
CC848822560	1 ft wire set (C: thermal probe to thermal probe)	
848719803	5 ft wire set (C: thermal probe to thermal probe)	
CC848822321	10 ft wire set (C: thermal probe to thermal probe)	
850027334	20 ft wire set (C: thermal probe to thermal probe)	
108958422	ES771A Battery Voltage Monitor Card	
CC848791517	2-1/2 ft wire set (D: ES771A to thermal probe)	
CC848797290	6 ft wire set (D: ES771A to thermal probe)	
848719829	10 ft wire set (D: ES771A to thermal probe)	
CC848791500	4 ft wire set (G: ES771A to ES771A or controller)	
848652947	10 ft wire set (G: ES771A to ES771A or controller)	
555052-1	In-Line Coupler (for extending item G above)	

Temperature/Voltage probes are needed for battery monitoring. They are connected to each battery or battery string to provide slope thermal compensation, temperature alarms and voltage imbalance alarms.

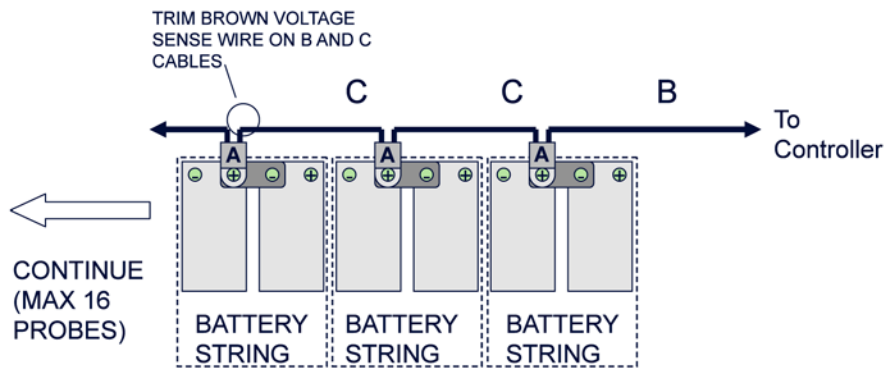

Temperature Measurement

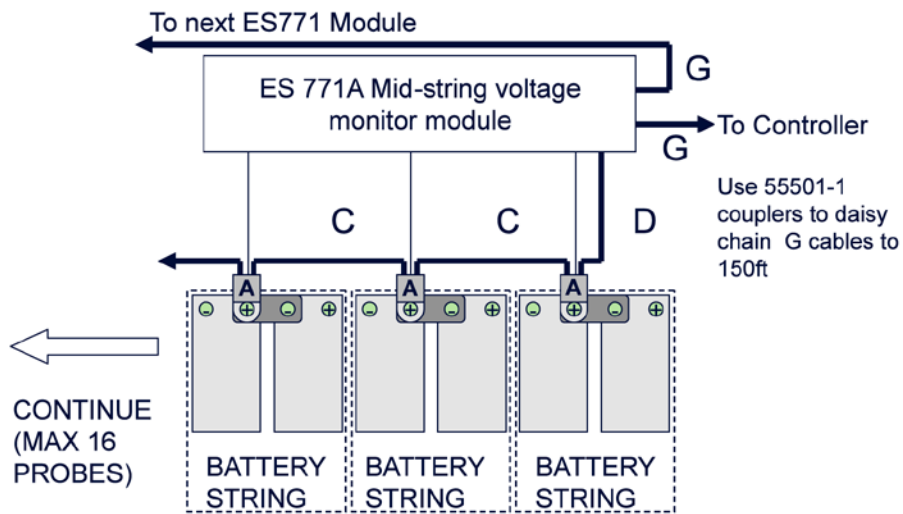

Temperature and Voltage Measurement

Management Visibility

Galaxy Manager* software is the centralized visibility and control component of a comprehensive power management system designed to meet engineering, operations and maintenance needs. The Galaxy Manager client-server architecture enables remote access to system controllers across the power network.

- Dashboard display with one-click access to management information database
- Trend analysis
- Scheduled or on demand reports
- Fault, configuration, asset, and performance management

Training

GE offers on-site and classroom training options based on certification curriculum. Technical training can be tailored to individual customer needs. Training enables customers and partners to more effectively manage and support the power infrastructure. We have built our training program on practical learning objectives that are relevant to specific technologies or infrastructure design objectives.

Service & Support

GE field service and support personnel are trusted advisors to our customers – always available to answer questions and help with any project, large or small. Our certified professional services team consists of experts in every aspect of power conversion with the resources and experience to handle large turnkey projects along with custom approaches to complex challenges. Proven systems engineering and installation best practices are designed to safely deliver results that exceed our customers' expectations.

Warranty

GE is committed to providing quality products and solutions. We have developed a comprehensive warranty that protects you and provides a simple way to get your products repaired or replaced as soon as possible.

For full warranty terms and conditions please go to www.gecriticalpower.com.



imagination at work

GE Critical Power

601 Shiloh Road, Plano, TX 75074
+1 877 546 3243 (toll-free in North America)
+1 972 244 9288 (direct number)
info.criticalpower@ge.com
GECriticalPower.com
24/7 Technical Support
pe.techsupport@ge.com