

Infinity D™ Power System

Dual Voltage, Modular Power System



- Modular DC power system enables low initial investment with future expansion potential
- -48V up to 1,600A (87KW) or +24V up to 1,600A (44KW)
- DC Power Plant with 24V and 48V DC dual voltage flexibility
- High availability wireless telecom applications
- Telecom service providers and OEMs
- Efficiency approaching 97%

Overview

The GE Energy Infinity D™ DC energy system is a modular power plant that supports dual voltage (+24V/- 48V) operation through the use of a comprehensive range of state of the art rectifiers and DC-DC converters. Primary voltage is supported by rectifiers and battery reserve, while secondary voltage is supported by DC-DC converter modules. Primary voltage can be -48V or +24V.

The Infinity D Power System has primary voltage capacity for +24V and -48V power up to 1,600A; secondary voltage capacity is up to 300A per expansion module.

Shelf Options

The Infinity D Power System is built upon a modular architecture that consists of 8" (203mm) tall system modules. The system modules are complete "mini systems" which can be combined to form larger systems. Since each system module is an optimized combination of power and distribution there is minimal unnecessary capacity and cost is minimized. As the system is expanded, additional optimized combinations of capacity

are added, again minimizing incremental cost. System modules are added to achieve up to 1,600A capacity.

Infinity Rectifier and Converter Family

The Infinity D offers DC rectifiers and converters for both +24V to -48V and -48V to +24V applications. Rectifiers and converters are color coded to quickly identify both the voltage and whether it is a rectifier or converter (orange for +24V and blue for -48V).

Rectifier and Converter Options:

- NE100AC24ATEZ Rectifier, 100A/24V Output
- NE050AC48ATEZ Rectifier, 50A/48V Output
- NE075DC24 Converter, 75A/24V Output
- NE030DC48 Converter, 30A/48V Output

Pulsar Plus Controller

The Infinity D utilizes the industry leading Pulsar Plus controller with Ethernet and SNMP communications to deliver extensive monitoring and control features with remote access.

Benefits

Reliability

- Distributed fault tolerance
- Proven field performance
- Controller continuity

Intelligence

- Industry leading controller features
- Ethernet interface for remote access
- Centralized network management

Investment Protection

- Module compatibility
- Modular expansion allows growth as needed
- Efficient operation
- Secondary Voltage flexibility +24V / -48V

On Time Delivery

- Standard building blocks
- 4 - 6 week availability
- 24/7 emergency support

Total Efficiency

The GE Energy Total Efficiency™ (TE) architecture reduces energy loss and lowers cooling costs by 50-70%. TE products will prioritize sustainable energy sources like solar, wind, water and fuel cells over traditional utility grid or diesel generator sources - and they will intelligently respond to smart grid information to reduce consumption during peak demand periods. Active Rectifier Management™ (ARM) and Battery Charging Optimization™ (BCO) features increase efficiency on current and legacy power infrastructures. The Total Efficiency architecture addresses issues end-to-end based on our proven experience and expertise in batteries, power distribution, DC energy systems, AC-DC power supplies, and DC-DC board mounted power to deliver a solution that is more safe, reliable and energy efficient than alternatives from our competitors.



Infinity Rectifiers and Converters



- **Compact** – 1RU form factor providing high power density (24 W/in³)
- **Dual Voltage compatibility** – the unique connector pin designation allows the rectifier to be used in a “universal” power shelf, alongside rectifiers or DC-DC converters with different output voltages.
- **Plug and Play** – installation of the rectifier in a shelf connected to a compatible system controller initializes all set up parameters automatically. No adjustments are needed.
- **Extended service life** – parallel operation with automatic load sharing ensures that parallel units are not unduly stressed even when a unit fails or is removed.
- **Monitoring / control** – the built in microprocessor controls and monitors all critical rectifier functions and communicates with the system controller using the built in Galaxy Protocol serial interface.
- **Fail safe performance** – hot insertion capabilities allow for converter replacement without system shutdown; soft start and inrush current protection prevent nuisance tripping of upstream breakers.

Applications

- Telecommunications networks
- Digital subscriber line (DSL)
- Indoor/outdoor wireless
- Routers/switches
- Fiber in the loop
- Transmission
- Data networks
- PBX

Key Features

- Extended temperature range
- Redundant fan cooling
- Front panel LED indicators
- 1U height, hi power density
- 220/110V AC input
- Digital load sharing
- Hot pluggable
- RoHS compliant

Specifications

Input	NE100AC24ATEZ	NE050AC48ATEZ	NE030DC48	NE075DC24
Voltage Range	95-275Vac	95-275Vac	21-30Vdc	42-60Vdc
Input Current	15-12A @ 100-120Vac 15A @ 200-240Vac	15-12A @ 100-120Vac 15A @ 200-240Vac	63A @ 27Vdc 81A @ 21Vdc	41A @ 54.5Vdc 54a @ 42Vdc
Input Frequency	45 – 66Hz	45 – 66Hz	-	-
Power Factor	0.98 at>50% load	0.98 at>50% load	-	-
Efficiency	> 95% (Peak 95.6%)	> 96% (Peak 96.9%)	-	-
Total Harmonic Distortion	<5% @loads over 50%	<5% @loads over 50%	-	-
Output				
Voltage Adjust Range	21-29Vdc	42-58Vdc	46-57Vdc	23-28Vdc
Voltage Nominal	27.25V	54.5V	52.0V	27.2V
Regulation (with controller)	±0.5%	±0.5%	±0.5%	±0.5%
Ripple	100mVrms	100mVrms	100mVrms	100mVrms
Output Current				
- High-Line	100A @27.25V	50A @54.5V	30A @52.0V	75A @27.2V
- Low-Line	44A @27.25V	22A @54.5V	-	-
Heat Dissipation @ max out	174W / 594 BTU/hr	158W / 539 BTU/hr	154W / 525 BTU/hr	202W / 689 BTU/hr

Environmental	
Operating Temperature	-40°C to +75°C (-40 to 167°F)
Storage Temperature	-40°C to +85°C (-40 to 185°F)
Humidity	< 95% non-condensing
Altitude	2000M max
Mechanical	
Length (inch/mm)	13.85 / 351.8
Width (inch/mm)	5.23 / 133
Height (inch/mm)	1.63 / 42
Weight (lb/Kg)	5.05 / 2.2
Safety and Standards Compliance	
NEBs Level 3	Evaluated by independent NRTL test lab to Telcordia GR63, Issue 3 & GR 1089, Issue 5
Safety	CE mark to Low Voltage Directive 2006/95/EC and EMC Directive 2004/108/E (Rectifiers only) UL 60950-1, 2nd Ed. Recognized CSA C22.2 No. 60950-1-03 Certified
RoHS	Compliant to RoHS EU Directive 2002/95/EC; RoHS 6/6
EMC	European Directive 2004/108/EC; EN55022, Class A; EN55024; FCC, Class A; GR1089-CORE, Issue 5
ESD	EN61000-4-2, Level 4

Outline Drawing

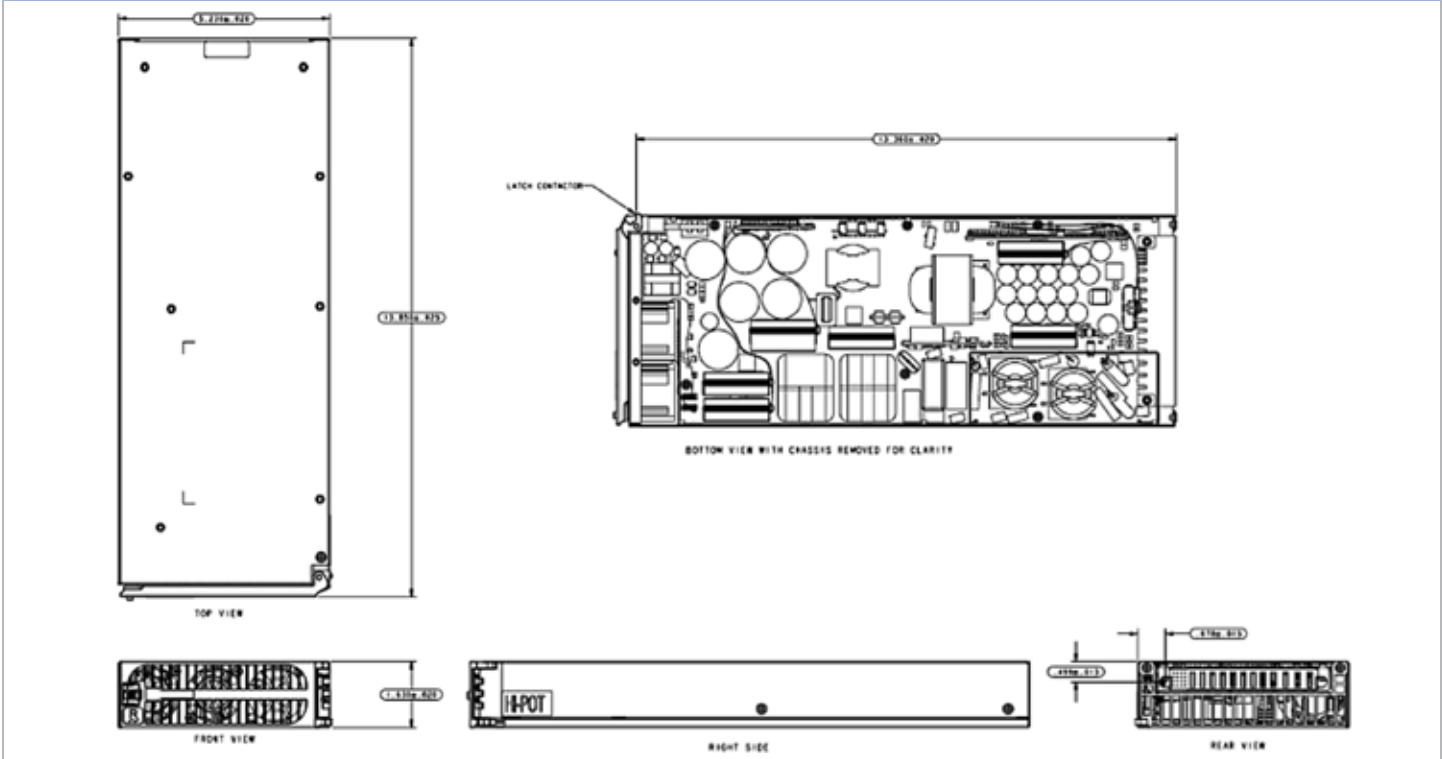

Pulsar Plus Controller



The Pulsar Plus family of controllers provides system monitoring and control features for Infinity, CP, and other power systems. These controllers monitor and control system components including rectifiers, converters, and distribution modules via a multi-drop RS485 digital communications bus. System status, parameters, settings, and alarm thresholds can be viewed and configured from the controller's front panel display. Assignment and configuration of alarm inputs and output relays can be performed from a laptop computer connected to a local RS-232 or Ethernet port, or by remote access is through a network connection to the

World Wide Web (internet) or your enterprise network (intranet). An optional modem is also available.

This controller utilizes standard network management protocols allowing for advanced network supervision. The GE Energy Galaxy Manager™ software is the centralized visibility and control component of a comprehensive power management system designed to meet engineering, operations and maintenance needs. The Galaxy Manager client-server architecture enables remote access to system controllers across the power network.

Applications

- Telecommunications networks
- Digital subscriber line (DSL)
- Indoor/outdoor wireless
- Routers/switches
- Fiber in the loop
- Transmission
- Data networks
- PBX

Key Features

Remote Access and Features

- Integrated 10/100Base-T Ethernet Network
 - TCP/IP
 - SNMP V2c for management
 - SMTP for email
 - Telnet for command line interface
 - DHCP for plug-n-play
 - FTP for rapid backup and upgrades
 - HTTP for standard web pages and browsers
 - Compatible with Galaxy Manager and other management packages
 - Shielded RJ-45 interface referenced to chassis ground
- Password protected security levels: User, Super-User, Administrator for all access
- Ground-referenced RS232 system port
- ANSI T1.317 command-line interface
- Modem access support
 - Remote via external modem
 - Callback security
- EasyView2, Windows-based GUI software for local terminal or Modem access

Standard System Features

- Monitor and control of more than 40 connected devices
 - Robust RS485 system bus
- Standard and user defined alarms
 - Alarm test
 - Assignable alarm severity: Critical, Major, Minor, Warning, and record-only
 - 10 alarm relays (7 user assigned)
- Rectifier management features
 - Automatic rectifier restart
 - Active Rectifier Management ARM (energy efficiency)
 - Remote rectifier (on/off)
 - Reserve Operation
 - Automatic rectifier sequence control
 - N + X redundancy check
- Multiple Low Voltage Load and Low Voltage Battery Disconnect thresholds
- Configuration, statistics, and history
 - All stored in non-volatile memory
 - Remote/local backup and restore of configuration data
- Industry standard defaults
 - Customer specific configurations available
- Remote/ local software upgrade
- Basic, busy hour, and trend statistics
- Detailed event history
- User defined events and derived channels

Standard Battery Management Features

- Float/boost mode control
 - Manual boost
 - Manual timed boost locally, T1.317, and remotely initiated
 - Auto boost terminated by time or current
- Battery discharge testing
 - Manual (local/remote)
 - Periodic
 - Plant Battery Test (PBT) input driven
 - Configurable threshold or 20% algorithm
 - Graphical discharge data
 - Rectifiers on-line during test
- Slope thermal compensation
 - High temperature
 - Low temperature
 - Step temperature
 - STC Enable/Disable, low temperature Enable/Disable
 - Configurable mV/°C slopes
- State of charge indication
- High temperature disconnect setting
- Reserve-time prediction
- Recharge current limit
- Emergency Power-Off input

Integrated Monitoring Inputs/Outputs

- System plant voltage (accuracy $\pm 0.5\%$, resolution 0.01V)
- One system shunt (accuracy $\pm 0.5\%$ full scale, resolution 1A)
 - Battery or load
 - Mounted in the return side of DC bus
- Up to 15 binary inputs
 - Six inputs close/open to battery
 - 9 input close/open to return
 - User assignable
- Up to 7 Form-C output alarms (60VDC @ .5A)
 - User assignable
- 1-Wire™ bus devices
 - Up to 16 temperature probes (QS873)
 - Up to 6 mid-string monitors (ES771)

General	
Operating Voltage	± 24 Vdc, ± 48 Vdc (Range: ± 18 to ± 60 Vdc)
Input Power	Less than 7W
Operating Temperature Range	-40°C to +75°C (-40 to 167°F)
Operating Relative Humidity	0 - 95% (non-condensing)
Storage Temperature Range	-40°C to +85°C (-40 to 185°F)
Physical Specifications	Sizes vary by packaging option
Display	8-line by 40-character with alarm context sensitive backlit LCD

Galaxy Manager Compatible

- Centralized web server and database with multiple user access to live or managed data with drill down to problem details
- Monitor and control of more than 40 connected devices
- Management information from polling or alarms received from alarm traps from multiple sites are available on one screen via the inter/intranet
- Trend user selected data over time
- Automatic or manual report generation
- Standard engineering tools like reserve time calculators and cable voltage drop analyzer

Safety and Standards Compliance	
NEBs	Evaluated by independent NRTL test lab to Telcordia GR63, Issue 3 and GR1089-CORE, Issue 5
Safety	CSA C22.2 No. 60950-1-03 Certified for Canada and U.S.; UL60950-1 1st Ed.
RoHS	Compliant to RoHS EU Directive 2002/95/EC RoHS 5/6
EMC	European Directive 2004/108/EC; EN55022, Class A, EN55024; FCC, Class A; GR1089-CORE, Issue 5

Agency Certifications	
NEBs Level 3	Evaluated by independent NRTL test lab to Telcordia GR63, Issue 3 and GR1089-CORE, Issue 5
EMC	European Directive 2004/108/EC; EN55022, (CISPR22) Class A, EN55024 (CISPR24)
Safety	Underwriters Laboratories (UL) Listed per Subject Letter 1801: Power Distribution Center for Communications Equipment, and cUL Certified (CSA 22.2 950): Safety of Information Technology Equipment

Ordering Information – Infinity D Power System

Dual Voltage, Modular Power System

Infinity-D may be configured as a +24V or -48V single voltage power system or as a “dual voltage” power system that supports rectifiers and converters. The primary voltage is supported by +24V or -48V rectifiers and battery reserve, while secondary voltage is supported by DC/DC converters. The primary voltage capacity is 1,600A at both 24V and 48V. Secondary voltage capacity is up to 300A per system expansion module.

Infinity-D systems may be equipped in 19”, 23” or 26” wide 7ft frameworks, a half height frame for mounting on battery stands, or supplied frameless for field install applications including outside cabinets.

Features

- Infinity Rectifiers for +24V and -48V applications.
- Modular architecture for easy growth and low cost
- DC/DC converter support for dual voltage systems
- DC distribution in each system module for efficient scalability
- Temperature hardened harsh environments. (-40°C to +75°C)
- Compact size: 8” (203mm) high, 16.9” (429mm) deep.
- Adjustable frame mounting for 19”, 23” and 26” applications
- Battery panel for battery connection and LVBD option.
- Plug-N-Play Pulsar Plus controller with Web based interface for local and remote (CO-LAN) access.
- Distribution options include 3A-400A bullet style circuit breakers and GMT fuses



Outline Drawing

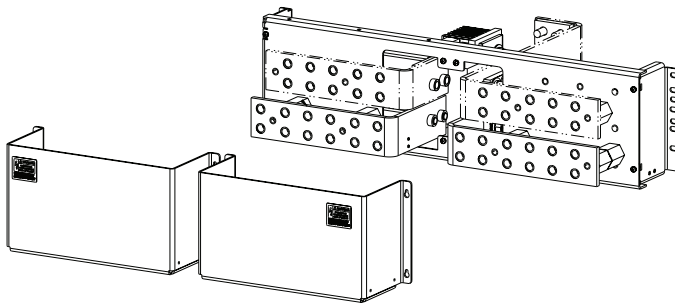

23" BATTERY CONNECTION PANEL
ALL CONNECTIONS 3/8" BOLTS ON 1" CENTERS



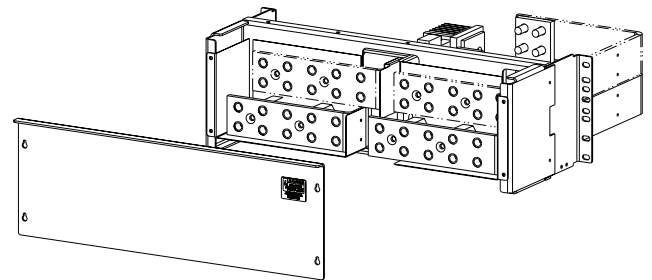



19" BATTERY CONNECTION PANEL
ALL CONNECTIONS 3/8" BOLTS ON 1" CENTERS

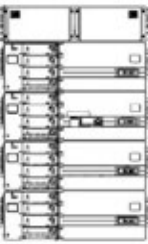





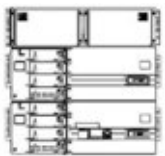

Step 1: Select the Base Power Bays

-48V Primary voltage systems				
Output	Ordering Code	Model	Frame	Picture
		-48V, 400A Infinity D System with 2 power shelves, each shelf is equipped with 4 rectifier slots and 10 bullet breaker positions. Includes 800A battery connection panel with LVBD contactor. Equipped with Pulsar Plus controller with Ethernet communications. Suitable for frame or cabinet mounting (not included).	No Frame	
	400A	CC109146115	H2007001 G003, G020D, G021D, G202C, G801	
	150022232	H2007001 G003, G020F, G021F, G202E, G801	System width 19"	
		-48V, 800A Infinity D System with 4 power shelves, each shelf is equipped with 4 rectifier slots and 10 bullet breaker positions. Includes 800A battery connection panel with LVBD contactor. Equipped with Pulsar Plus controller with Ethernet communications. Mounted in a 7ft relay rack frame.	7ft x 23"	
	800A	CC109146123	H2007001 G005, G020D(3), G021D, G202C, G801(3)	
	150021706	H2007001 G007, G020F(3), G021F, G202E, G801(3)	System width 19"	

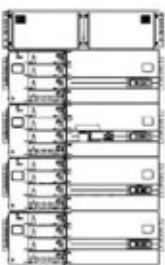

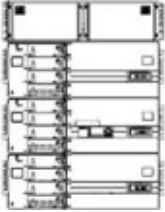

-48V Primary voltage systems with +24V converters				
Output	Ordering Code	Model	Frame	Picture
		-48V, 400A Infinity D System with 3 power shelves, 2 shelves are equipped with 4 rectifier slots and 10 bullet breaker positions, third shelf is equipped with 4 converter slots and 10 bullet breaker positions. Includes 800A battery connection panel with LVBD contactor. Equipped with Pulsar Plus controller with Ethernet communications. Suitable for frame or cabinet mounting (not included).	No Frame	
	48V, 400A 24V, 300A	CC109146131	H2007001 G003, G020D, G021D, G040C, G202C, G801, G802	
	150021705	H2007001 G003, G020F, G021F, G040E, G202E, G801, G802	System width 19"	
		-48V, 800A Infinity D System with 5 power shelves, 4 shelves are equipped with 4 rectifier slots and 10 bullet breaker positions, 5th shelf is equipped with 4 converter slots and 10 bullet breaker positions. Includes 800A battery connection panel with LVBD contactor. Equipped with Pulsar Plus system controller with Ethernet communications. Mounted in a 7ft relay rack frame.	7ft Frame	
	48V, 800A 24V, 300A	CC109146148	H2007001 G005, G020D(3), G021D, G040C, G202C, G801(3), G802	
	150022233	H2007001 G007, G020F(3), G021F, G040E, G202E, G801(3), G802	System width 19"	

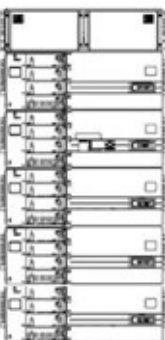

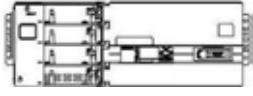

Step 1: Select the Base Power Bays (cont.)

+24V Primary voltage systems				
Output	Ordering Code	Model	Frame	Picture
 +24V 800A	CC109146073	H2007001 G003, G010D, G011D, G202C, G801	No Frame	
	150022234	H2007001 G003, G010F, G011F, G212E, G801	System width 19"	
 +24V 1600A	CC109146081	H2007001 G005, G010D(3), G011D, G212C, G801(3)	7ft Frame	
	150022235	H2007001 G007, G010F(3), G011F, G212E, G801(3)	System width 19"	

+24V Primary voltage systems with -48V converters				
Output	Ordering Code	Model	Frame	Picture
 +24V -48V 24V, 800A 48V, 120A	CC109146098	H2007001 G003, G020D, G021D, G040C, G202C, G801, G802	No Frame	
	150022236	H2007001 G003, G010F, G011F, G030E, G212E, G801, G802	System width 19"	
 +24V -48V 24V, 1600A 48V, 120A	CC109146107	H2007001 G005, G010D(3), G011D, G030C, G211C, G801(3), G802	7ft Frame	
	150022237	H2007001 G007, G010F(3), G011F, G030E, G212E, G801(3), G802	System width 19"	

Step 1: Select the Base Power Bays (cont.)

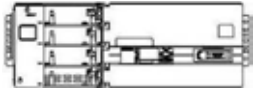
Stand Alone DC-DC Converter Systems				
Output	Ordering Code	Model	Frame	Picture
	CC109161956	-48V, 120A Single Shelf, stand alone converter system. +24V in, -48V out. Universal DC inputs allow for individual converter inputs, dual inputs, or a single input for the entire shelf. Infinity D System with equipped with 4 converter slots, 10 bullet breaker positions, and Pulsar Plus controller with Ethernet communications. Includes 19" door for field modification. Suitable for frame or cabinet mounting (not included).	No Frame	
120A		H2007001 G031C	System width 23" or 19"	
	CC109164876	-48V, 120A Single Shelf, stand alone converter system. +24V in, -48V out. Universal DC inputs allow for individual converter inputs, dual inputs, or a single input for the entire shelf. Infinity D System with equipped with 4 converter slots, 20 bullet breaker positions, and Pulsar Plus controller with Ethernet communications. Suitable for frame or cabinet mounting (not included). Not available in 19" version.	No Frame	
120A		H2007001 G031C G052	System width 23"	
	CC109149893	+24V, 300A Single Shelf, stand alone converter system. -48V in, +24V out. Universal DC inputs allow for individual converter inputs, dual inputs, or a single input for the entire shelf. Infinity D System with equipped with 4 converter slots and 10 bullet breaker positions. Equipped with Pulsar Plus controller with Ethernet communications. Includes 19" door for field modification. Suitable for frame or cabinet mounting (not included).	No Frame	
300A		H2007001 G041C	System width 23" or 19"	

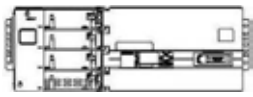
Stand Alone Single Shelf Rectifier Systems (Cannot be expanded)				
Output	Ordering Code	Model	Frame	Picture
		-48V, 200A Infinity D System, 1x48V System Module with integral battery connection, 10 breaker positions and LVBD, 23" width, no frame. Equipped with Pulsar Plus system controller with Ethernet communications. Suitable for frame or cabinet mounting (not included)	No Frame	
200A	CC109151107	H2007001 G003, G021D, G223	System width 23"	
	CC109150100	H2007001 G003, G021F, G223	System width 19"	
	CC109151288	-48V, 200A Infinity D System, 1x48V System Module with integral battery connection, 20 Breaker positions, and LVBD, 23" width, no frame. Equipped with Pulsar Plus controller with Ethernet communications. Suitable for frame or cabinet mounting (not included). Not available in 19" version.	No Frame	
200A		H2007001 G003, G021D, G051, G223	System width 23"	
		+24V, 400A Infinity D System, 1x24V System Module with integral battery connection and LVBD, 23" width, no frame. Equipped with Pulsar Plus system controller with Ethernet communications. Suitable for frame or cabinet mounting (not included)	No Frame	
400A	CC109153648	H2007001 G003, G011D, G223	System width 23"	
	CC109149662	H2007001 G003, G011F, G223	System width 19"	

Step 2: Select Mounting Frame & Battery Trays

Note: Small systems above are configured WITHOUT a mounting frame to facilitate use in cabinets or frames. Large systems come pre-mounted in a 7ft relay rack frame. The following frame options are available for the small systems.

Ordering Code	Description
CC848828938	7ft high relay rack for mounting 23" wide equipment (Zone 4 to 1800 lbs.)
CC848852186	7ft high relay rack for mounting 19" wide equipment (Zone 4 to 1800 Lbs.)
848751132	42" high relay rack for mounting 23" wide equipment on a 1/2 height battery stand or battery stack

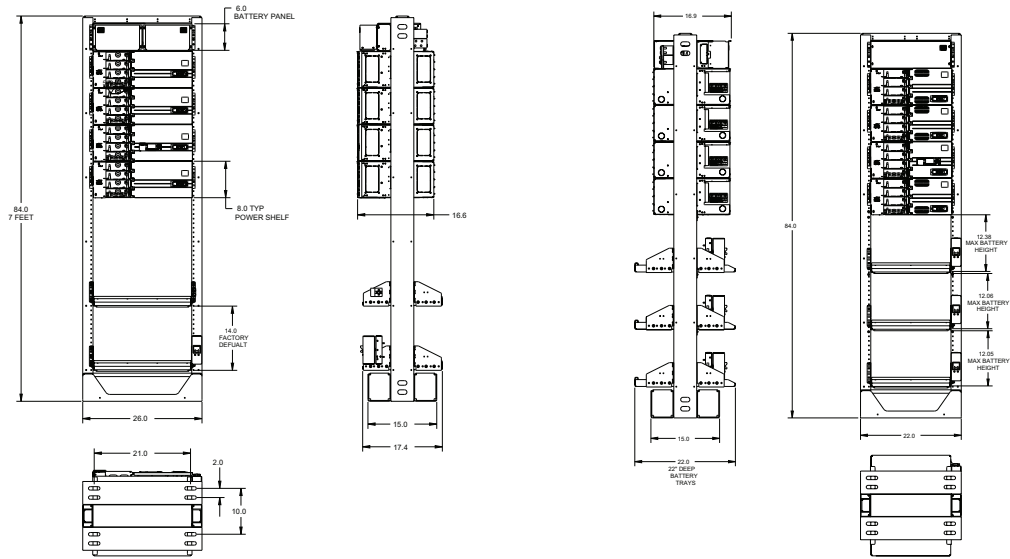

7ft High relay rack for mounting 23" wide equipment

7ft relay rack for mounting 19" wide equipment

23 INCH HALF HEIGHT FRAME

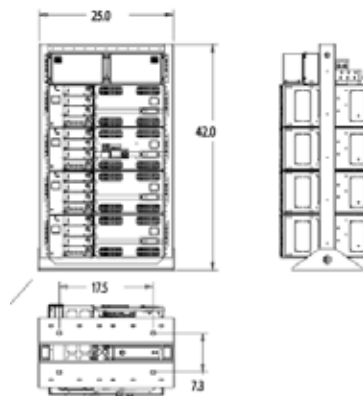

42" high relay rack for mounting 23" wide equipment on a 1/2 height battery stand or battery stack



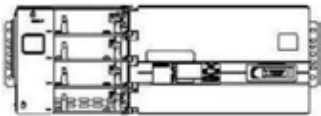
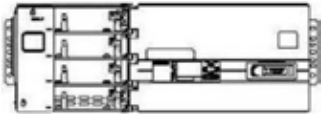

Ordering Code	Description	Picture
CC848842955	23" Battery Tray (22" Depth) Typically Batteries include: East Penn (12A150FT, 12A170FT) Energys (12V155FS, 12V170F) NorthStar (NSB110FT, NSB170FT)	
CC848849942	23" Battery Tray (17" Depth) Typically Batteries include: Energys (SBS C11) NorthStar (NSB90FT, NSB100FT) Two IR150 Batteries, 2 Strings IR40s (23"wide)	
CC848850033	19" Battery Tray (17" Depth) Typically Batteries include: Energys (SBS C11) NorthStar (NSB90FT, NSB100FT) Two IR150 Batteries, 2 Strings IR40s (23"wide)	
CC848849950	19" Battery Tray (22" Depth) Typically Batteries include: East Penn (12A100FT) Energys (12V125F) Gnb(M12V125F)	
CC848848481	23" Battery Tray (15" Depth) Typically Batteries include: 2 Strings of IR30s Energys RKU100-V52-C100 Lithium Ion Battery	
CC848861360	23" Battery Tray (24" Depth) Typically Batteries include: 1 string of IR150 Batteries (3 front, 1 back) Energys RKU100-V52-C180 Lithium Ion Battery	
CC109147501	J2008002L007: 100A Battery Disconnect Breaker Assembly equipped with 10 ft of 2 gauge red and black wire	
CC109149778	J2008002L008: 200A Battery Disconnect Breaker Assembly equipped with 10 ft of 2/0 gauge red and black wire	
848724971	2 gauge, 10ft battery cable kit with Anderson Disconnect	
CC848922633	2/0 gauge, 10ft battery cable kit with Anderson Disconnect	
CC848809104	2 gauge, 10ft battery cable kit (includes terminal lugs)	
CC848860734	2/0 gauge, 10ft battery cable kit (includes terminal lugs)	
CC109155371	Bulk Battery Termination Panel Power Bus and Return Bus both have the following landings: 1 dual hole bulk landing (3/8 on 1" centers) 8 dual hole landings (1/4-20 on 5/8" centers) Includes Lexan Cover	

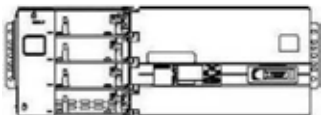
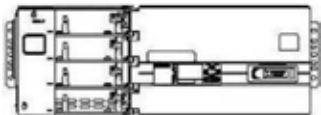



Step 3: Select any Power System expansion shelves

System Expansion - Rectifier Shelves				
Output	Ordering Code	Model	Mounting	Picture
+24V		Supplemental 24V rectifier shelf with connection kit; supports 4 x rectifiers with 10 bullet circuit breaker positions.		
	400A	CC109146156	H2007001 G010D, G801	
	150022238	H2007001 G010F, G801	System width 19"	
-48V		Supplemental 48V rectifier shelf with connection kit; supports 4 x rectifiers with 10 bullet circuit breaker positions.		
	200A	CC109146164	H2007001 G020D, G801	
	150022239	H2007001 G020F, G801	System width 19"	

System Expansion - Converter Shelves				
Output	Ordering Code	Model	Mounting	Picture
+24V		Supplemental 48V to 24V converter shelf with connection kit; supports 4 x NE075DC24 converters with 10 bullet circuit breaker positions.		
	300A	CC109145851	H2007001 G040C, G802	
	150022240	H2007001 G040E, G802	System width 19"	
-48V		Supplemental 24V to 48V converter shelf with connection kit; supports 4 x NE030DC48 converters with 10 bullet circuit breaker positions.		
	120A	CC109145843	H2007001 G030C, G802	
	150022241	H2007001 G030E, G802	System width 19"	

Step 4: Select Rectifiers and Converters

Rectifiers			
Output	Ordering Code	Model	Photo
	CC109160834	95 - 145Vac input, 24V, 44A Output, 175 - 275Vac input, 24V, 100A output; 145 - 175 linear output increase from 44A to 100A	
100A		NE100AC24TEZ	
	CC109158878	95 - 145Vac input, 48V, 22A Output, 175 - 275Vac input, 48V, 50A output; 145 - 175 linear output increase from 22A to 50A	
50A		NE050AC48TEZ	

Converters			
Output	Ordering Code	Model	Photo
	CC109112471	21-29 Vdc input, 48V, 30A output	
30A		NE030DC48	
	CC109142881	42-58 Vdc input, 24V, 75A output	
75A		NE075DC24	

Step 5: Select Alarm Cables

Alarm Cables		
Ordering Code	Model	Photo
CC848865980	15ft Auxiliary input alarm cable for Pulsar Plus Controller	
CC848817651	50ft Auxiliary input alarm cable for Pulsar Plus Controller	
CC848817668	150ft Auxiliary input alarm cable for Pulsar Plus Controller	
CC109157442	15ft alarm cable for Pulsar Plus Controller	
CC848817635	50ft alarm cable for Pulsar Plus Controller	
CC848817643	150ft alarm cable for Pulsar Plus Controller	

Step 6: Select Distribution Components





Note: Infinity D shelves each support 10 plug-in (bullet style) breakers or fuse modules. To minimize the cost of surplus material, the cable termination adapters are supplied separately. These are listed below (on top of Page 16) and must be selected and ordered to match the breakers to be installed. On the 5 pole, 400A breaker the adapter is supplied attached to the breaker, so it does not have to be ordered separately.



Bullet Style Load Circuit Breakers				
Ordering Code	Amperage	CB Positions (Poles)	Min Wire Gauge	Photo
407998137	3	1	10	
407998145	5	1	10	
407998152	10	1	10	
407998160	15	1	10	
407998178	16	1	10	
407998186	20	1	10	
407998194	25	1	10	
407998202	30	1	10	
408213486	40	1	8	
407998210	45	1	8	
407998228	50	1	6	
407998236	60	1	6	
407998244	70	1	2	
407998251	80	1	2	
407998269	90	1	2	
CC848808551	100	2	2	
408185353	125	2	2	
408185346	150	2	1/0	
408564941	200	3	2/0	
408573975	225	3	4/0	
408535752	250	3	4/0	
CC109147063	400	5	2x2/0	

Step 6: Select Distribution Components (cont.)

Bullet Style Fuse Holder and TPS Fuses				
Ordering Code	Amperage	WP-92461 List	Min Wire Gauge	Photo
406700567	3	100	10	
406700583	5	101	10	
406700591	6	102	10	
406700609	10	103	10	
406700617	15	104	10	
406700625	20	105	10	
406700633	25	106	10	
406700641	30	107	10	
406700658	40	108	10	
406700674	50	109	8	
406700682	60	110	6	
406700690	70	111	6	
402328926	0.18 Alarm Fuse			
408548944	Bullet Fuse Holder, TFD-101-011-09 (Alarms on Blown Fuse or Fuse Head Removal)			
CC408617410	Bullet Fuse Holder, TFD-101-011-10 (Alarms on Blown Fuse Only)			
GMT Fuses				
405006222	0.25A			
406976894	0.5A			
405673146	1.33A			
405181983	2A			
406976985	3A			
406159061	5A			
405725433	7.5A			
406159236	10A			
407845197	12A			
406473959	15A			
CC109145983	6-pos GMT Bullet Fuse Holder (Requires 2 bullet postions)			
408515823	Fuse Puller			

Step 6: Select Distribution Components (cont.)

Bus Adapters		
Ordering Code	Description	Photo
CC109143814	Single Pole Breaker or Fuse Holder Termination (one is required for each single pole breaker or fuse holder) (For ¼" on 5/8" ctrs Lugs)	
CC109143822	Dual Pole Breaker Termination (one is required for each 2-pole breaker) (For 3/8" on 1" ctrs Lugs)	
CC109143830	Three Pole Breaker Termination (one is required for each 3-pole breaker) (For 3/8" on 1" ctrs Lugs)	
CC848847723	Dual Return Bus adapter – turns two ¼" on 5/8" ctrs positions in to one 3/8" on 1" ctrs 2-hole lug position	
CC848850652	Quad Return Bus adapter – turns four ¼" on 5/8" ctrs positions in to two 3/8" on 1" ctrs 2-hole lug position	

Terminal Lugs for Bullet Style Breakers and TPS Fuses (1/4" bolt on 5/8" centers)				
Ordering #	STR Wire GA (Class B)	Flex Wire GA (Class I)	WP-91412 List	Photo
406021626	8	8	75	
405347519	6	6	3	
405347576	4	4	5	
405348202	2	-	54	
405347683	-	2	8	
Terminal Lugs for Battery and Large Breakers (3/8" bolt on 1" centers)				
406338665	2	-	-	
405348228	1/0	-	-	
405348236	2/0	1/0	-	
406021725	-	2/0	-	
405348251	4/0	-	-	
405347923	-	4/0	-	
407890763	350	-	-	
407890748	-	350	-	
406335141	750	-	-	
407890730	-	750	-	

Step 7: Select Battery Monitoring

Ordering Code	Description	Photo
CC109142980	QS873A Thermal Probe (A)	
CC848817024	10 ft wire set (B: thermal probe to controller)	
CC109157434	20 ft wire set (B: thermal probe to controller)	
CC848822560	1 ft wire set(C: thermal probe to thermal probe)	
848719803	5 ft wire set (C: thermal probe to thermal probe)	
CC848822321	10 ft wire set (C: thermal probe to thermal probe)	
108958422	ES771A Battery Voltage Monitor Card	
CC848791517	2-1/2 ft wire set (D: ES771A to thermal probe)	
CC848797290	6 ft wire set (D: ES771A to thermal probe)	
848719829	10 ft wire set (D: ES771A to thermal probe)	
CC848791500	4 ft wire set(G: ES771A to ES771A or controller)	
848652947	10 ft wire set (G: ES771A to ES771A or controller)	
555052-1	In-Line Coupler (for extending item G above)	

Temperature/Voltage probes are needed for battery monitoring. They are connected to each battery or battery string to provide slope thermal compensation, temperature alarms and voltage imbalance alarms.

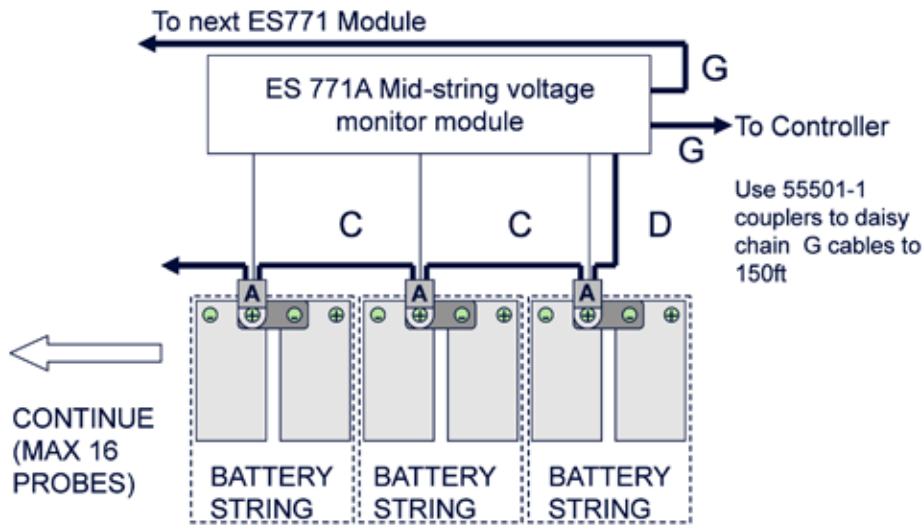
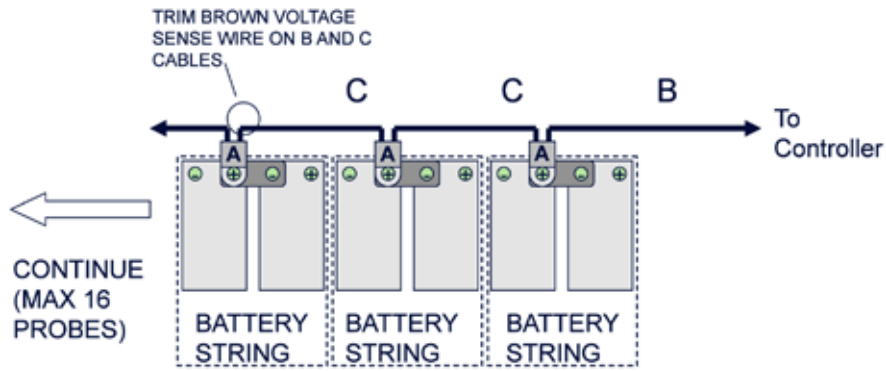

Shelf Specifications

Mechanical	
Height	8 inches (203mm) – Single shelf only
Width (with mounting ears)	19 inches (483mm) or 23 inches (584mm) or 26 inches (660mm)
Depth	16.6 inches (422mm)
Weight (without modules)	30lbs/13.6kg – Single shelf only
Environmental	
Operating Temperature	-40°C to +75°C (-40 to 167°F)
Storage Temperature	-40°C to +85°C (-40 to 185°F)
Humidity	< 95% non-condensing
Altitude	2000M max
Safety and Standards Compliance	
NEBs Level 3	Evaluated by independent NRTL test lab to Telcordia GR63, Issue 3 & GR 1089, Issue 5
Safety	CSA C22.2 No. 60950-1-03 Certified for Canada and U.S.; UL 60950-1 1st Ed.
RoHS	Compliant to RoHS EU Directive 2002/95/EC; RoHS 6/6
EMC	European Directive 2004/108/EC; EN55022, Class A; EN55024; FCC, Class A; GR1089-CORE, Issue 5
Agency Certifications	
CSA	CSA C22.2 No. 60950-1-03 and UL 60950-1 1st Ed.
EMI/EMC	European Directive 2004/108/EC; EN55022, Class A; EN55024; FCC, Class A; GR1089-CORE, Issue 5
NEBs Level 3	Evaluated by independent NRTL test lab to Telcordia GR63, Issue 3 & GR 1089, Issue 5

Additional Information

Product Documentation

H2007001: Ordering Guide

A copy of the appropriate installation manuals below ship with each system.

- CC848845223: Infinity D Installation Manual (+24V Rectifier Systems, -48V Converters)
- CC848853515: Infinity D Installation Manual (-48V Rectifier Systems, +24V Converters)
- CC848864834: Infinity D Single Shelf Power Plant Installation Guide (+24V and -48V Systems)
- CC848862433: Infinity D Stand Alone Converter Plant Installation Guide (+24V to -48V System)

Management Visibility

Galaxy Manager™ software is the centralized visibility and control component of a comprehensive power management system designed to meet engineering, operations and maintenance needs. The Galaxy Manager client-server architecture enables remote access to system controllers across the power network.

- Dashboard display with one-click access to management information database
- Trend analysis
- Scheduled or on demand reports
- Fault, configuration, asset, and performance management

Training

GE Energy offers on-site and classroom training options based on certification curriculum. Technical training can be tailored to individual customer needs. Training enables customers and partners to more effectively manage and support the power infrastructure. We have built our training program on practical learning objectives that are relevant to specific technologies or infrastructure design objectives.

Service & Support

GE Energy field service and support personnel are trusted advisors to our customers – always available to answer questions and help with any project, large or small. Our certified professional services team consists of experts in every aspect of power conversion with the resources and experience to handle large turnkey projects along with custom approaches to complex challenges. Proven systems engineering and installation best practices are designed to safely deliver results that exceed our customers' expectations.

Warranty

GE Energy is committed to providing quality products and solutions. We have developed a comprehensive warranty that protects you and provides a simple way to get your products repaired or replaced as soon as possible.

For full warranty terms and conditions please go to www.ge.com/powerelectronics.



GE Energy

Contact Us

For more information, call us toll free at **+1 877 546 3243**, or +1 972 244 9288 and visit us on the web at www.ge.com/powerelectronics