

# LED Linear High Bay CCT Selectable Series

Wattage: 130W, 170W, 255W, 300W, 400W

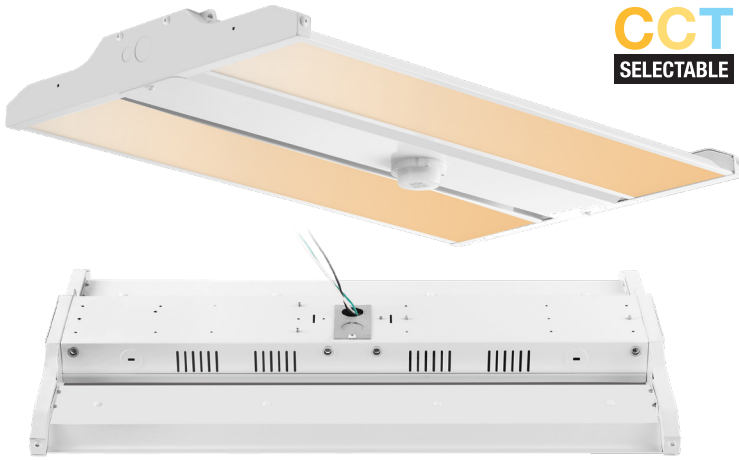

**CCT**  
SELECTABLE

The Linear High Bay with its all-in-one, lightweight and slim with multiple mounting situations available put it at the top of the list for any high ceiling area where super bright light is needed. The LED Linear High bay Light Series can be widely used for indoor excellent for warehouse, industry building, factories, fitness center, and many other applications.



**MESH RANGE**

60ft node-to-node and 500ft node-to-Gateway (Commissioning)

## FEATURES

- Optical design, greatly improved the light utilization an evenness.
- High efficiency LED Driver, voltage AC120-277 and 277V-480V.
- Rugged galvanized rolled iron plate housing, better cooling, light quality, LED Tj < 85°C.
- 0-10V dim to 10% then to off.
- Field install plug and play Bi-Level Sensor.



**Bluetooth**  
(Option)

Easy field-install motion sensor

## SPECIFICATION

	130W	170W	255W	300W	400W
<b>WATTAGE</b>	130W	170W	255W	300W	400W
<b>LUMEN</b>	17680 lm	23120 lm	34680 lm	40800 lm	54000 lm
<b>EFFICACY</b>	135 lm/W	136 lm/W	136 lm/W	136 lm/W	135 lm/W
<b>CCT</b>	4000K/5000K				
<b>CRI</b>	80				
<b>INPUT VOLTAGE</b>	AC120-277V and 277V-480V				
<b>LIGHT ANGLE</b>	105°				
<b>POWER FACTOR</b>	0.98				
<b>DRIVER EFFICACY</b>	90%				
<b>DIMMING</b>	0-10V will be dim to 0%				
<b>LIFE SPAN</b>	over 75,000 hrs				
<b>WORKING TEMPERATURE</b>	-22°F ~ 113°F				
<b>STORAGE TEMPERATURE</b>	-40°F ~ 176°F				
<b>PROTECTION LEVEL</b>	Dry location				
<b>CABLE</b>	Input connect, No cable				
<b>WARRANTY</b>	5 year limited				

# LED Linear High Bay CCT Selectable Series

Wattage: 130W, 170W, 255W, 300W, 400W

## DIMENSION

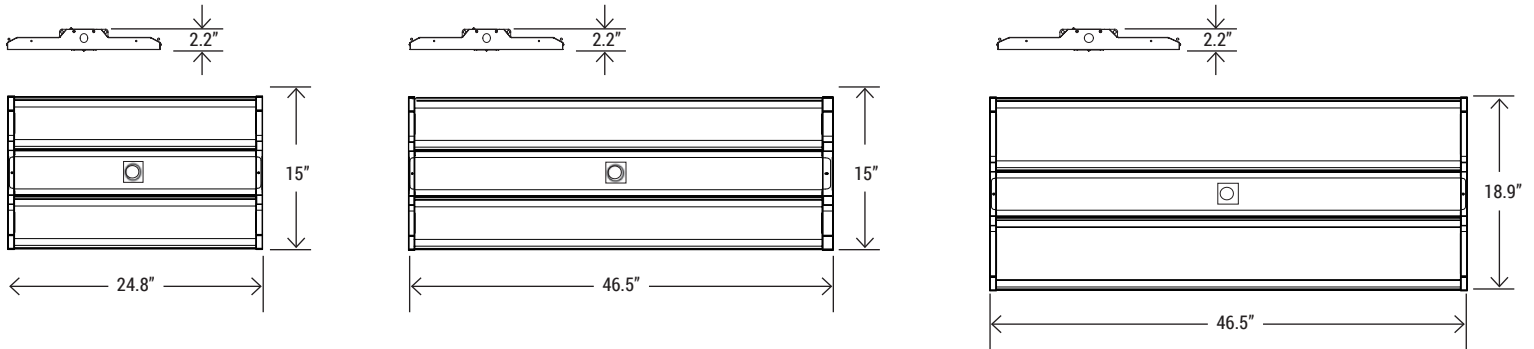

<b>WATTAGE</b>	130W, 170W
<b>GR. WEIGHT</b>	10.36 lbs/11.24 lbs
<b>BOX DIM.</b>	25.9" x 15.4" x 2.6"

<b>WATTAGE</b>	255W
<b>GR. WEIGHT</b>	17.9 lbs
<b>BOX DIM.</b>	47.6" x 15.4" x 2.6"

<b>WATTAGE</b>	300W, 400W
<b>GR. WEIGHT</b>	19.84 lbs
<b>BOX DIM.</b>	47.6" x 19.3" x 2.6"

## EMERGENCY BACK-UP (SOLD SEPARATELY)

## CONTROL (SOLD SEPARATELY)



**BLD-CM20N-480800-15W**  
15W Emergency Backup  
Battery LED Driver



**BLD-CM20D-480800-20W**  
20W Emergency Backup  
Battery LED Driver



**ANT-5-4T-BLE\***  
Bluetooth  
Microwave  
Motion Sensor



**BRI-PP01\***  
Bluetooth  
Fixture Controller for  
Bluetooth Sensor  
(See full details)



**ANT-5-4T**  
Microwave  
Motion Sensor



**ANT-6-4T**  
PIR Motion  
Sensor



**RC**  
Remote  
Controller

**\*MESH RANGE**

60ft node-to-node and 500ft node-to-Gateway (Commissioning)

**LPT**

PRODUCT

**2F**

SIZE

2F (2-foot)

4F (4-foot)

**130W**

WATTAGE

130W - (130W)  
170W - (170W)

255W - (255W)  
300W - (300W)  
400W - (400W)

**27**

VOLTAGE

27 (AC120-277V)  
48 (AC277-480V)

**4050K**

CCT

4050K - (4000K/5000K)

**GEN2**

UPDATE

Second  
generation  
product

# LED Linear High Bay CCT Selectable Series

Wattage: 130W, 170W, 255W, 300W, 400W

## WIRE GUARD (SOLD SEPARATELY)

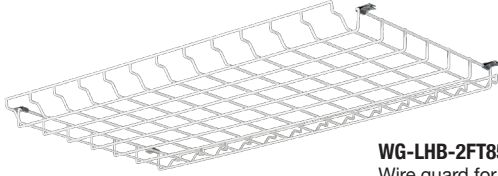

**WG-LHB-2FT85W-130W-170W**  
Wire guard for 85W/130W/170W

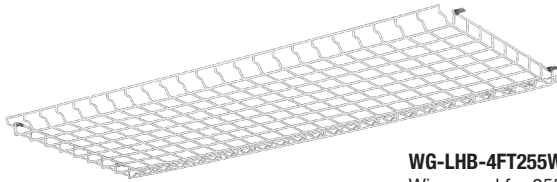
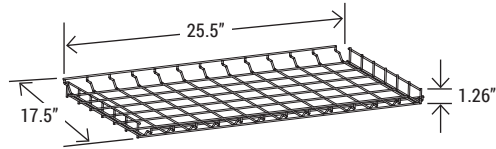

**WG-LHB-4FT255W**  
Wire guard for 255W

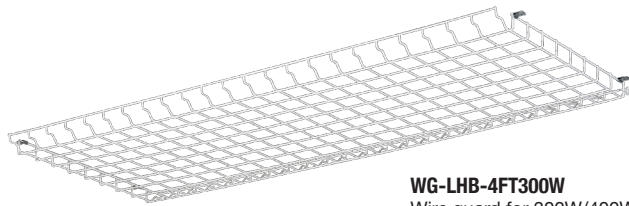
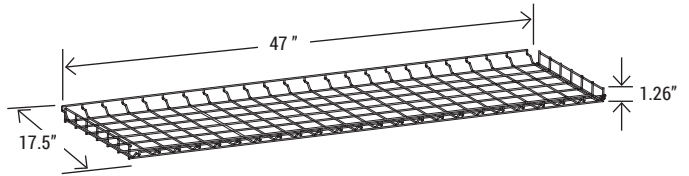

**WG-LHB-4FT300W**  
Wire guard for 300W/400W

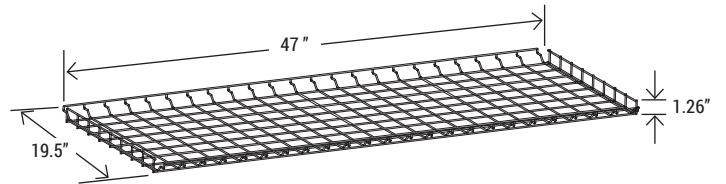

## INCLUDED IN THE PACKAGE

## MOUNTING OPTION

## SURFACE MOUNT KIT (SOLD SEPARATELY)

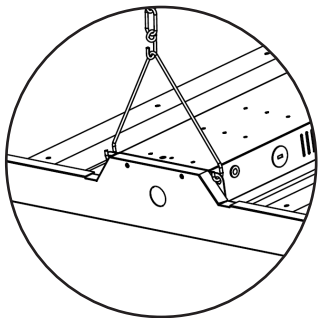

CHAINS/HOOK

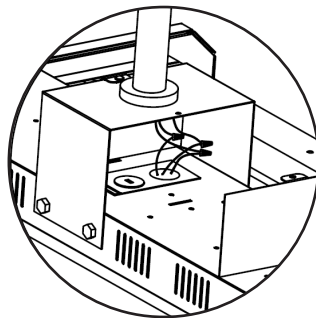

J-BOX OPTION

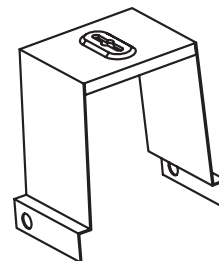

**SURFACE MOUNT KIT-LHBG2**  
Surface mount kit

# LED Linear High Bay CCT Selectable Series

Wattage: 130W, 170W, 255W, 300W, 400W



## ANT-5-4T-BLE

Plug and Play Network BLE Nodes and Sensor

The Bluetooth Lighting Control provides automated individual and group control of light fixtures using on sensors and Bluetooth mesh technology. The ANT-5-4T-BLE mounted in an Commercial lighting fixture and provides multi-level control solution based on motion and or daylight harvesting contribution.

## FEATURES

- Lighting controls meet design lights consortium (DLC) networked lighting control system technical requirements (Version NLC5 June 23, 2020).
- Quick connect and adjust different sensor angle.
- Easy commissioning with Tuya/Sharkward App (Available in IOS and Android).
- Bluetooth network with Saas working by computer
- Individual addressability and/or grouping.
- Time clock scheduling for individual lights, groups or scenes.
- Multi-level dimming: manual ON/OFF automatic ON/OFF, and automatic partial ON/OFF, daylight harvesting control capability.

## DIMENSION

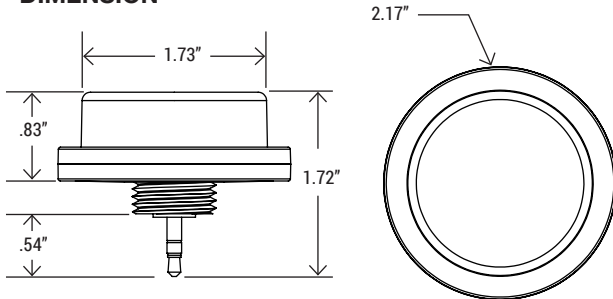

## COVERAGE

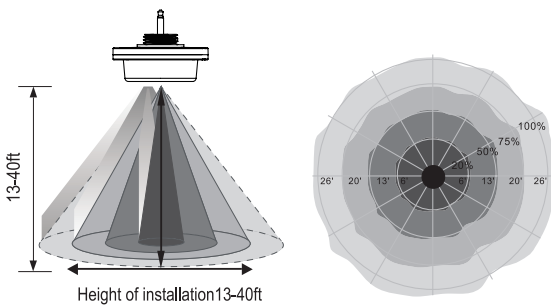

## SPECIFICATION

NETWORK BLE MESH	Yes
DAYLIGHT HARVESTING	Yes
MICROWAVE MOTION SENSOR	Yes
DETECTION MODE	Occupancy/Vacancy/Bi-level in 1 Unit
OPERATING VOLTAGE	12-24V DC
OPERATING CURRENT	>50mA
SINKING CURRENT	max. 25mA
CONTROL OUTPUT	0-10V
RADIO FREQUENCY	2.4GHz ± 75MHz
WIRELESS STANDARD	BLE 4.2 MESH IEEE 802.15.1
PROGRAMMING	Tuya/Sharkward App mobile app (IOS and android) or Saas
CYBERSECURITY	UL 1376
ENCRYPTION	AES 128-bit
MESH RANGE	60ft node-to-node and 500ft node-to-device (Commissioning)
SAFETY	cULus Listed
FCC	FCC ID:2AVMOANT-5-X
OPERATING TEMP.	-40°F - +158°F (-40°C - +70°C)
IP RATING	IP65
WARRANTY	5 year limited

## MICROWAVE SENSOR FEATURES

DAYLIGHT HARVESTING	On/Off
MOTION SENSING	On/Off
FIRST TIME DELAY	1-59 mins/infinite
SECOND TIME DELAY	0-59 mins/infinite
DIM LEVEL	0-100%
MOUNTING HEIGHT	13-40ft
DETECTION RANGE	up to 52ft diameter
DETECTION: HORIZONTAL	360°
DETECTION: VERTICAL	90°

## COMMISSIONING

Tuya/Sharkward mobile App makes it easy to pair devices, create groups, set scenes/schedules, customize dimming levels, and adjust high trim based on application needs.



# LED Linear High Bay CCT Selectable Series

Wattage: 130W, 170W, 255W, 300W, 400W

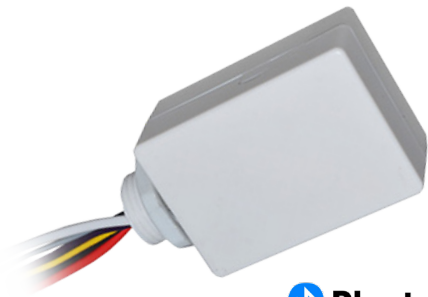

## DIMENSION

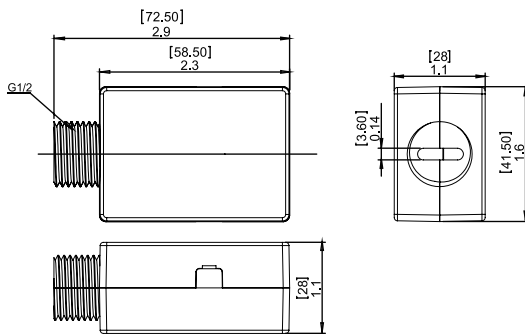

## COMMISSIONING

Tuya/Sharkward mobile App makes it easy to pair devices, create groups, set scenes/schedules, customize dimming levels, and adjust high trim based on application needs.



## BRI-PP01

Fixture Controller for Bluetooth Sensor

The Bluetooth Lighting Control provides automated individual and group control of light fixtures using on sensors and Bluetooth sigmesh technology. The BRI-PP01 mounted in an Indoor lighting fixture and provides multi-level control solution based on motion and or daylight harvesting contribution.

## FEATURES

- Lighting controls meet design lights consortium (DLC) networked lighting control system technical requirements (Version NLC5)
- Quick connect and adjust different sensor angle
- Easy commissioning with Tuya/Sharkward App (Available in IOS and Android)
- Bluetooth network with Saas working by computer
- Individual addressability and/or grouping
- Time clock scheduling for individual lights, groups or scenes
- Multi-level dimming: manual

SPECIFICATION	
OPERATING VOLTAGE	120-277VAC, 50-60Hz
MAXIMUM LOAD	5A, 600W Max. for LED driver only
CONTROL OUTPUT	2-channel 0-10V output signals, 1 for dimming, 1 for CCT
SINKING CURRENT	max. 25mA
RADIO FREQUENCY	2.4GHz ± 75MHz
WIRELESS STANDARD	BLE 4.2 MESH IEEE 802.15.1
PROGRAMMING	Tuya/Sharkward App mobile app (IOS and Android) or Saas
CYBER SECURITY	UL 1376
ENCRYPTION	AES 128-bit
MESH RANGE	60ft node-to-node and 500ft node-to-device (Commissioning)
SAFETY	cULus Listed
FCC	FCC ID
OPERATING TEMP.	-40°F - +158°F (-40°C - +70°C)
WARRANTY	5 year limited

## WIRING DIAGRAM

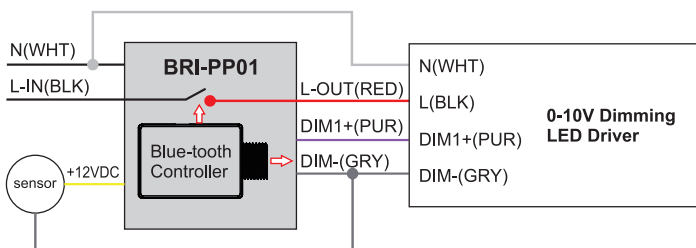

One-channel Brightness Dimming Application

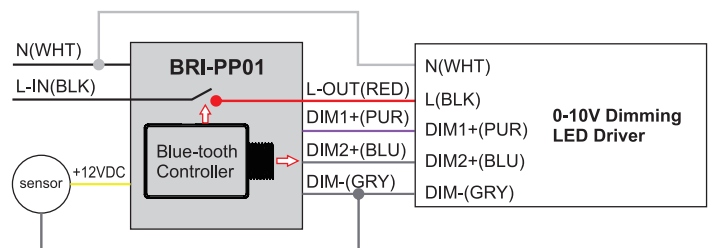

Two-channel Color Tuning Application

# LED Linear High Bay CCT Selectable Series

Wattage: 130W, 170W, 255W, 300W, 400W

## GATEWAY REMOTE CONTROL

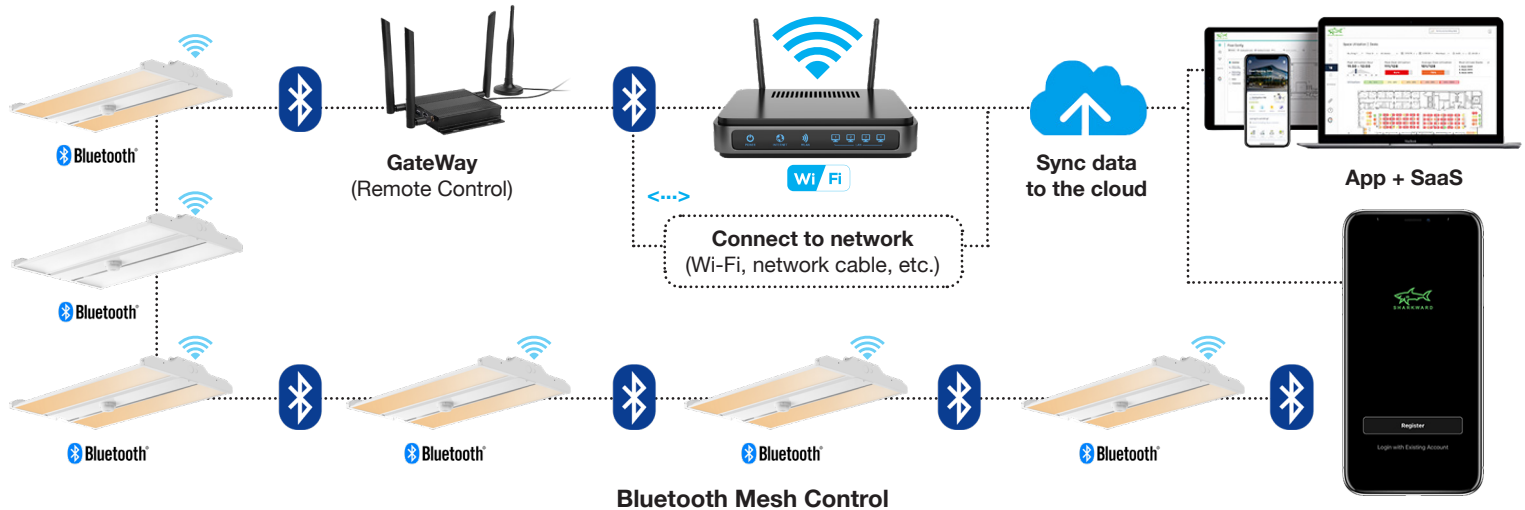

## Bluetooth Mesh Control

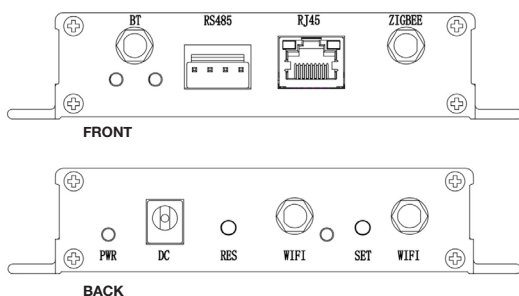

## INDUSTRIAL GATEWAY

### SK18WG

Smart Engineering Gateway

- One gateway can control max. 200pcs Bluetooth Motion sensors.
- This distance is for reference only, the construction site conditions are different, and the distance may deviate.
- The gateway can cover up to 500ft distance.
- Bluetooth between Bluetooth communication up to 60ft.

Consult factory for more details.

### SPECIFICATION

INPUT VOLTAGE	100-240VAC, 50-60Hz
OUTPUT VOLTAGE	5V= 2000MA
WORKING TEMPERATURE	-10°C ~ 45°C
STORAGE TEMPERATURE	-20°C ~ 60°C
WORKING HUMIDITY	10%-90%RH (No condensation)
STORAGE HUMIDITY	5%-90%RH (No condensation)
DIMENSIONS	4.25"x5.18"x1.07" (LxWxH)
WEIGHT	0.81 lbs

### RF CHARACTERISTICS

	WIFI	BLUETOOTH	ZIGBEE
WIRELESS FREQUENCY	2.400 ~2.4835 GHz	2.400 ~ 2.4835 GHz	2.400 ~ 2.480 GHz
NETWORK STANDARD	WIFI 802.11 b/g/n	IEEE 802.15	IEEE 802.15.4
TRANSMIT POWER	20dBm	8dBm	Nominal 10dBm, up to 19dBm
CHANNELS	CH1-CH14	CH0 - CH39	CH11-CH26
TRANSFER SPEED	11b:1,2,5,5, 11 (Mbps) 11g:6,9,12,18,24,36,48,54 (Mbps) 11n:HT20 MCS0~7 11n:HT40 MCS0~7	1Mbps/2Mbps	250Kbps



# LED Linear High Bay CCT Selectable Series

Wattage: 130W, 170W, 255W, 300W, 400W

## PHOTOMETRICS

For complete IES files, please visit our website.

### LHB-2F130W27-4050K

LUMINOUS INTENSITY DISTRIBUTION DIAGRAM

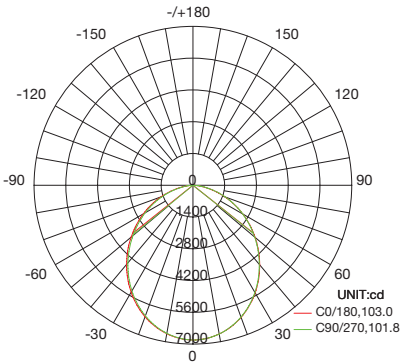

C0 PLANE ISOLUX DIAGRAM (UNIT:lx)

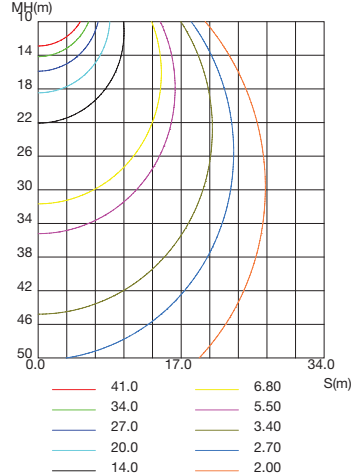

ISOLUX DIAGRAM

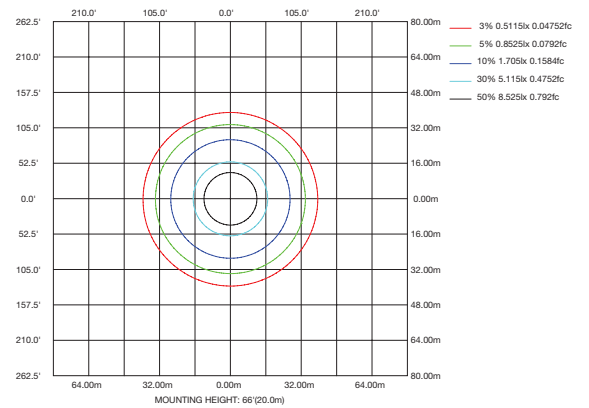

### LHB-2F170W27-4050K

LUMINOUS INTENSITY DISTRIBUTION DIAGRAM

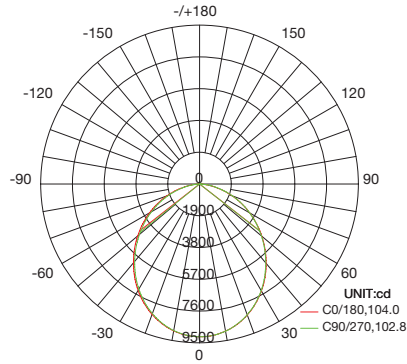

C0 PLANE ISOLUX DIAGRAM (UNIT:lx)

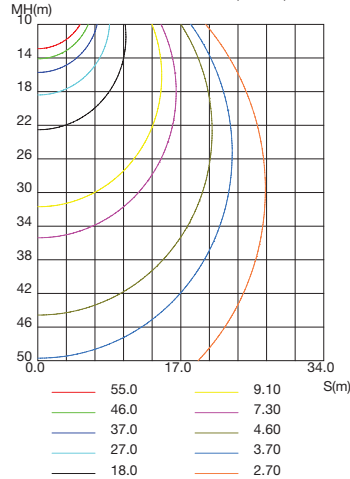

ISOLUX DIAGRAM

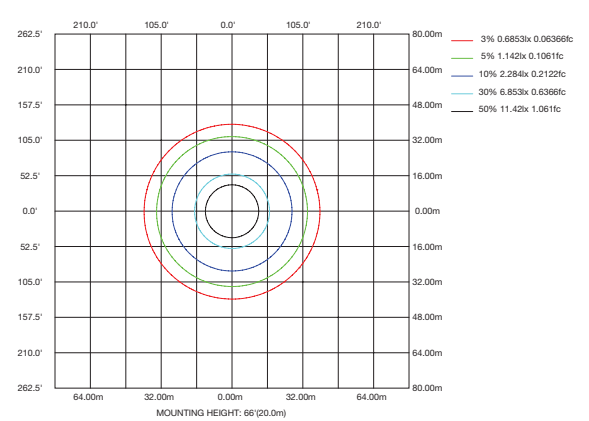

### LHB-4F255W27-4050K

LUMINOUS INTENSITY DISTRIBUTION DIAGRAM

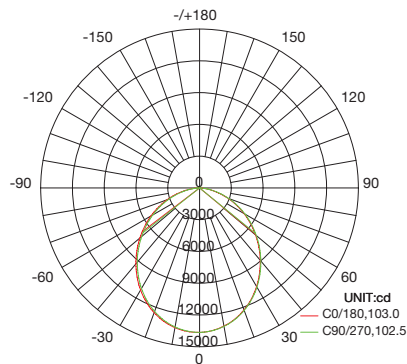

C0 PLANE ISOLUX DIAGRAM (UNIT:lx)

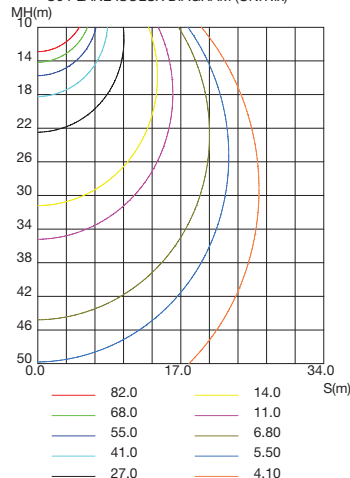

ISOLUX DIAGRAM

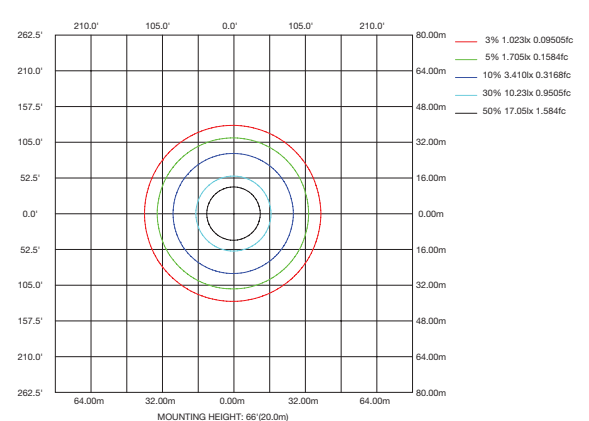

# LED Linear High Bay CCT Selectable Series

Wattage: 130W, 170W, 255W, 300W, 400W

## PHOTOMETRICS

For complete IES files, please visit our website.

### LHB-4F300W27-4050K

LUMINOUS INTENSITY DISTRIBUTION DIAGRAM

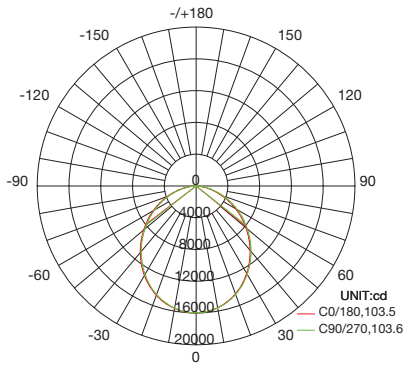

AVERAGE BEAM ANGLE(50%):103.6 DEG

C0 PLANE ISOLUX DIAGRAM (UNIT:lx)

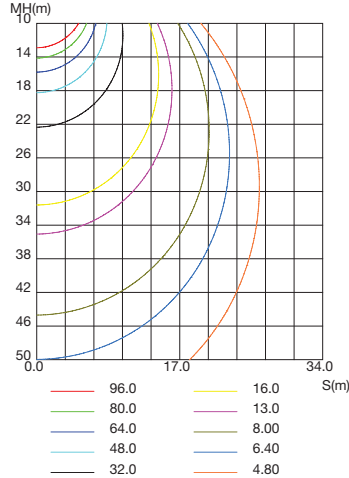

ISOLUX DIAGRAM

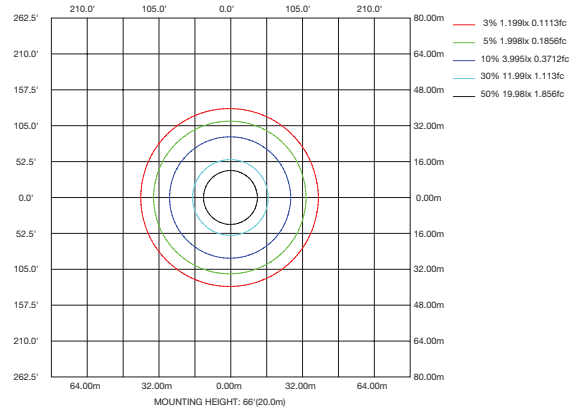

### LHB-4F400W27-4050K

LUMINOUS INTENSITY DISTRIBUTION DIAGRAM

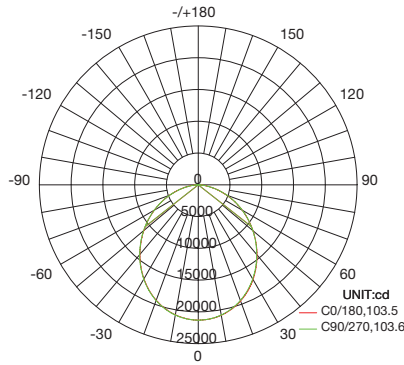

AVERAGE BEAM ANGLE(50%):103.6 DEG

C0 PLANE ISOLUX DIAGRAM (UNIT:lx)

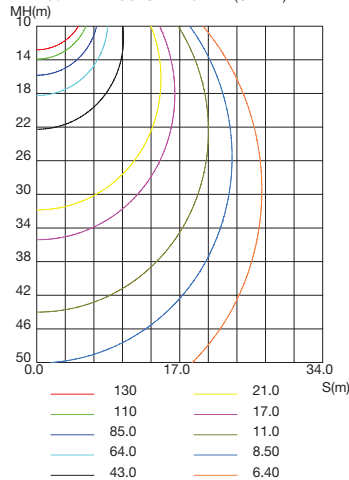

ISOLUX DIAGRAM

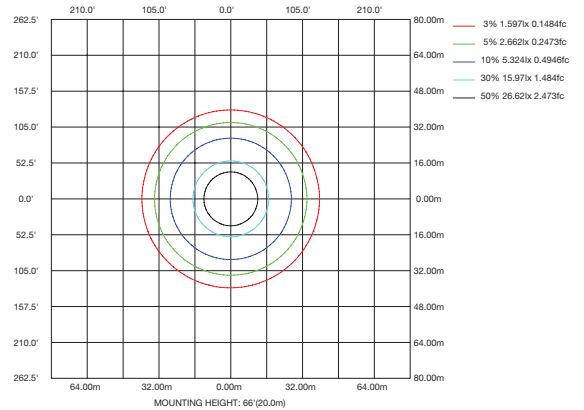

## Sharkward Lighting Control System



Google Play



Android



iOS