

MAINTENANCE OF HYDRAULIC SYSTEMS

BY: **RICKY SMITH,
CMRP, CMRT, CRL**



MAINTENANCE OF HYDRAULIC SYSTEMS

BY RICKY SMITH, CMRP

IN PARTNERSHIP WITH:
THE MAINTENANCE COMMUNITY BY UPKEEP

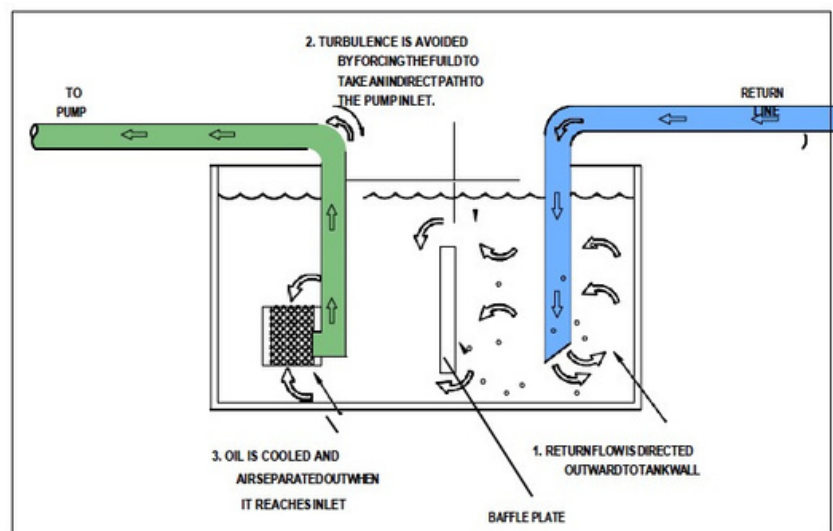

Most companies spend a lot of money training their maintenance personnel to troubleshoot a hydraulic system. If we focused on preventing system failure then we could spend less time and money on troubleshooting a hydraulic system. We normally expect hydraulic system failure rather than deciding not to expect hydraulic failure as the norm. Let's spend the time and money to eliminate hydraulic failure rather than preparing for failure.

I worked for Kendall Company in the 1980's and we changed our focus from reactive to proactive maintenance on our hydraulic systems and thus eliminating unscheduled hydraulic failure. We will talk about the right way to perform maintenance on a hydraulic system utilizing the "Maintenance Best Practices".

Lack of effective maintenance of hydraulic systems is the leading cause of component and system failure yet most maintenance personnel don't understand proper maintenance techniques of a hydraulic system. The basic foundation to perform proper maintenance on a hydraulic system has two areas of concern. The first area is Preventive Maintenance which is key to the success of any maintenance program whether in hydraulics or any equipment which we need reliability. The second area is corrective maintenance, which in many cases can cause additional hydraulic component failure when it is not performed to standard.

Lack of a Repeatable Procedure with specification will ensure a large number is human induced failures.

PM Procedure Example

Step	Description	Craft	# of Crafts	Clock Hours	Craft Index
1	Inspect Hydraulic System Rating • Does the Pressure fluctuate more than 5psi? (See 1.1.1) • Number of Hydraulic Leaks	Weld	2	5	1.0
2	Clean Hydraulic Reservoir • Clean inside Reservoir with Light Free Soap	Weld	2	1.0	1.0
3	Inspect Hydraulic Filter (1) • Replace Filter on Filter Patches In (1)	Weld	1	0.5	0.5
4	Replace 2-in. Fluids in Water-Cooled Heat Exchanger	Weld	1	0	0
5	Inspect 2 Hydraulic Pumps for wear or leaks • Inspect 1.1 • Inspect 1.2 • Inspect 1.3 • Inspect 1.4	Weld	2	1	2
6	Inspect Hydraulic Cylinder for Leaks • Inspect Seal for Leaks (Check One) • The Leaks • Whipping Oil • Oil Spraying	Weld	1	0.5	0.5
7	Inspect all work after production is up to rate • Do not have equipment until production is up to rate? • 100% Insure	Weld	2	8	1.0

PREVENTIVE MAINTENANCE OF A HYDRAULIC SYSTEM

Preventive Maintenance of a hydraulic system is extremely basic and simple and if followed properly can eliminate most hydraulic component failure. Preventive Maintenance is a discipline and must be followed as such to obtain results. We must view a PM program as a performance oriented and not activity oriented. Many organizations have good PM procedures but do not require maintenance personnel to

follow them or hold them accountable for the proper execution of these procedures. In order to develop a preventive maintenance program for your system you must follow these steps:

1 - Identify the system operating condition.

Does the system operate 24 hours a day, 7 days a week?

- Does the system operate at maximum flow and pressure 70% or better during operation?

Is the system located in a dirty or hot environment?

2 - What requirements does the Equipment Manufacturer state for Preventive Maintenance on the hydraulic system?

3 - What requirements and operating parameters does the component manufacturer state concerning the hydraulic fluid ISO particulate?

4 - What requirements and operating parameters does the filter company state concerning their filters ability to meet this requirement?

5 - What equipment history is available to verify the above procedures for the hydraulic system?

As in all Preventive Maintenance Programs we must write procedures required for each PM Task. Steps or procedures must be written for each task focused on the failure modes of that part, component, and equipment. These tasks must be accurate and understandable by all maintenance personnel from entry level to master.

Preventive Maintenance procedures must be a part of the PM Job Plan which includes:

Tools or special equipment required performing the task.

- Parts or material required performing the procedure with store room number.

Safety precautions for this procedure.

Environmental concerns or potential hazards.

Specifications and standards

-

A list of Typical Preventive Maintenance Task for a Hydraulic System:

1 - Replace Hydraulic Filter (could be the return or pressure filter)

Failure Mode – Hydraulic Valve Fails to Function

Cause – Contaminated Fluid

2.- Obtain a Hydraulic Fluid Sample

- Failure Mode – Contaminant Particles Degrade Valves and Pump Flow / Pressure

Cause – Contaminated Fluid

3.- Check Hydraulic Actuators for External Rod Leakage

Failure Mode – Cylinder Rod Seal Leaking Fluid

Cause – Cylinder not in alignment

4.- Clean the Inside of a Hydraulic Reservoir

Failure Mode – Hydraulic Valves not Functioning to Requirements

Cause – Reservoir Air breathers Failed to keep out contamination

5.- Clean Outside of a Hydraulic Reservoir

Failure Mode – Viscosity of Oil Decreasing due to abnormal Heat

Cause – Outside reservoir dirty with dust and oil, holding heat

6.- Check and Record hydraulic pressures

Failure Mode: Internal Pump Wear

Cause – Contamination

7.- Take Vibration Reading on AC Induction Motor

Part – Bearing

Failure Mode – Abrasion

Cause – Improper Installation

Cause – Improper Lubrication

•

Preventive Maintenance is the core support that a hydraulic system must have in order to maximize component and life and reduce system failure. Preventive Maintenance procedures that are properly written and followed properly will allow equipment to operate to its full potential and life cycle. Preventive Maintenance allows a maintenance department to control a hydraulic system rather than the

system controlling the maintenance department.

In order to validate your preventive maintenance procedures, you must have a good understanding and knowledge of “Best Maintenance Practices” for hydraulic systems. We will convey these practices to you.

Best Maintenance Practices for Hydraulic Systems			
Component	Component Knowledge	Best Practices	Frequency
Hydraulic Fluid Filter	There are two types of filters on a hydraulic system. 1.) Pressure Filter - Pressure filters come in collapsible and non-collapsible types. Preferred filter is the non-collapsible type. 2.) Return Filter - Typically has a bypass, which will allow contaminated oil to bypass the filter before indicating the filter needs to be changed.	<ol style="list-style-type: none"> 1. Clean the filter cover or housing with a cleaning agent and clean rags. 2. Remove the old filter with clean hands and install new filter into the filter housing or screw into place. <p>CAUTION: NEVER allow your hand to touch a filter cartridge. Open the plastic bag and insert the filter without touching the filter with your hand.</p>	Preferred: based on historical trending of oil samples. Least Preferred: Based on equipment manufacture's recommendations.
Reservoir Air Breather	The typical screen breather should not be used in a contaminated environment. A filtered air breather with a rating of 10 micron is preferred because of the introduction of contaminants to a hydraulic system.	<ol style="list-style-type: none"> 1. Remove and throw away the filter. 	Preferred: Based on historical trending of oil samples. Least Preferred: Based on equipment manufacture's recommendations
Hydraulic Reservoir	A reservoir is used to: <ol style="list-style-type: none"> 1. Remove contamination. 2. Dissipate heat from the fluid. 3. Store a volume of oil. 	<ol style="list-style-type: none"> 1. Clean the outside of the reservoir to include the area under and around the reservoir. 2. Remove the oil by a filter pump into a clean container, which has not had other types of fluid in it before. 3. Clean the insides of the reservoir by opening the reservoir and cleaning the reservoir with a "Lint Free" rag. 4. Afterwards spray clean hydraulic fluid into the reservoir and drain out of the system. 	If any of the following conditions are met. <ol style="list-style-type: none"> 1. A hydraulic pump fails. 2. If the system has been opened for major work. 3. If an oil analysis states excessive contamination
Hydraulic Pumps	A maintenance person needs to know the type of pump they have in the system and determine how it operates in their system. Example: What is the flow and pressure of the pump during a given operating cycle. This information allows a maintenance person to trend potential pump failure and troubleshoots a system problem quickly.	<ol style="list-style-type: none"> 1. Check and record flow and pressure during specific operating cycles. 2. Review graphs of pressure and flow. 3. Check for excessive fluctuation of the hydraulic system. (designate the fluctuation allowed) 	Pressure checks: Preferred - Daily Least Preferred: Weekly Flow & Pressure checks: Preferred- Two weeks Least preferred Monthly

<p>Hydraulic Pumps</p>	<p>A maintenance person needs to know the type of pump they have in the system and determine how it operates in their system.</p> <p>Example: What is the flow and pressure of the pump during a given operating cycle.</p> <p>This information allows a maintenance person to trend potential pump failure and troubleshoots a system problem quickly.</p>	<ol style="list-style-type: none"> 1. Check and record flow and pressure during specific operating cycles. 2. Review graphs of pressure and flow. 3. Check for excessive fluctuation of the hydraulic system. (designate the fluctuation allowed) 	<p>Pressure checks: Preferred - Daily Least Preferred: Weekly</p> <p>Flow & Pressure checks: Preferred- Two weeks Least preferred Monthly</p>
-------------------------------	---	--	---

Maintenance Best Practices for Hydraulic Systems

HYDRAULIC KNOWLEDGE

People say knowledge is power. Well this is also true in hydraulic maintenance. Many maintenance organizations do not know what their maintenance personnel should know. I believe in an industrial maintenance organization that we should divide the hydraulic skill necessary into two groups.

- One is the hydraulic troubleshooter; they must be your experts in hydraulics and this should be as a rule of thumb 10% or less of your maintenance workforce.
- The other 90% + would be your general hydraulic maintenance personnel. They are the personnel that provide the preventive maintenance expertise using.

The percentages I gave you are based on a company developing a true Preventive / Proactive maintenance approach to their hydraulic systems. Let's talk about what the hydraulic troubleshooter needs in terms of knowledge and skills.

Hydraulic Troubleshooting:

Knowledge:

Mechanical Principles / force, work, rate, simple machines

Maths/ basic math, complex math equations

- Hydraulic Components / application and function of all hydraulic system components.

Hydraulic Schematic Symbols / understanding all symbols and their

Maintenance of Hydraulic Systems

- relationship to a hydraulic system.
- Calculate flow, pressure, and speed.
 - Calculate the system filtration necessary to achieve the system's proper ISO particulate code.
- Skill:
 - Trace a hydraulic circuit to 100% proficiency.
 - Set the pressure on a pressure compensated pump.
 - Tune the voltage on an amplifier card.
 - Null a servo valve.
 - Troubleshoot a hydraulic system and utilize "Root Cause Failure Analysis".
 - Replace any system component to manufacturer's specification.
 - Develop a PM Program for a hydraulic system.
 - Flush a hydraulic system after a major component failure.

General Hydraulic:

Knowledge:

- Filters / function, application, installation techniques
- Reservoirs / function, application
- Basic hydraulic system operation
- Cleaning of hydraulic systems
- Hydraulic lubrication principles
- Proper PM techniques for hydraulics

Skills:

- Change a hydraulic filter and other system components.
- Clean a hydraulic reservoir.
- Perform PM on a hydraulic system.
- Change a strainer on a hydraulic pump.
- Add filtered fluid to a hydraulic system.
- Identify potential problems on a hydraulic system.
- Change a hydraulic hose, fitting or tubing.

MEASURING SUCCESS

1 - Track hydraulic system fluid analysis. Track the following from the results. / take samples once a month for...

Copper content

Silicon content

H₂O

Iron content

ISO particulate count

Fluid condition (Viscosity, additives, and oxidation)

2 - When the tracking process begins you need to trend the information that can be trended. This allows management the ability to identify trends that can lead to positive or negative consequences.

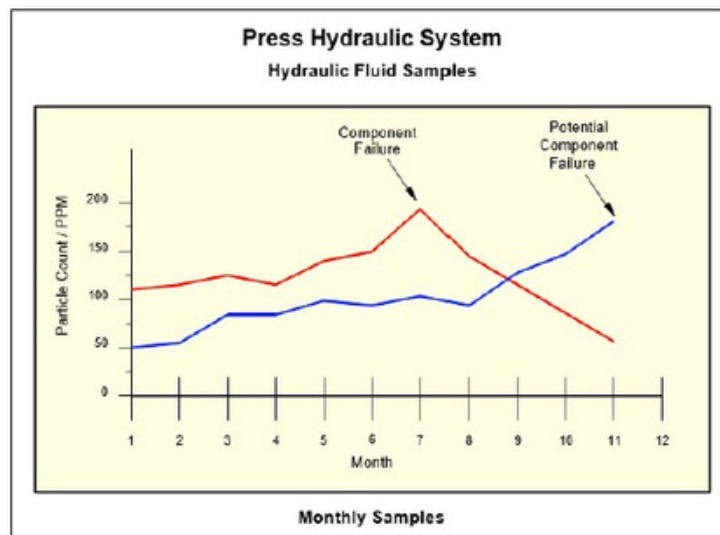

Hydraulic Fluid Sample Example

Fluid analysis proved the need for better filtration. The addition of a 3-micron absolute return line filter to supplement the “kidney loop” filter solved the problem.

Many organizations do not know where to find the method for tracking and trending

the information you need accurately. An effective Computerized Maintenance Management System (CMMS) can track and trend most of this information for you and allow Maintenance Technicians in the field to identify parts, material, etc. effectively and efficiently using cell phones.

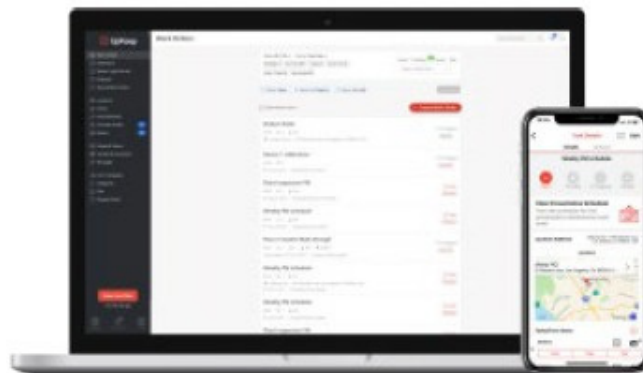

UpKeep CMMS Screenshot

RECOMMENDED MAINTENANCE MODIFICATIONS TO AN EXISTING HYDRAULIC SYSTEM

Modifications to an existing hydraulic system need to be accomplished professionally. A modification to a hydraulic system in order to improve the maintenance efficiency is important to a company's goal of maximum equipment reliability and reduced maintenance cost.

1 - Filtration pump with accessories: (CRITICAL)

Objective: The objective of this pump and modification is to reduce contamination that is introduced into an existing hydraulic system through the addition of new fluid and the device used to add oil to the system.

Additional Information: Hydraulic fluid from the distributor is usually not filtered to the requirements of an operating hydraulic system. Typically, this oil is strained to a

mesh rating and not a micron rating unless it ordered to a specific micron. How clean is clean? Typically, hydraulic fluid must be filtered to 10 microns absolute or less for most hydraulic system, 25 microns is the size of a white blood cell, and 40 microns is the lower limit of visibility with the unaided eye.

There are still many maintenance organizations add hydraulic fluid to a system through a contaminated funnel and may even use a bucket that has had other types of fluids and lubricants in them previously, without cleaning them.

Recommended equipment and parts:

Portable Filter Pump with a filter rating of 3 microns absolute.



Filter Pump Unit Example

Quick disconnects that meet or exceeds the flow rating of the Portable Filter Pump.

- A 3/4" pipe long enough to reach the bottom of a hydraulic container your fluids are delivered in from the distributor.
- A reducer bushing to 3/4" NPT to fit into the 55-gallon drum, if you receive your fluid by the drum. Otherwise, mount the filter buggy to the double wall "tote" tank supports, if you receive larger quantities.

2 - Modify the Hydraulic Reservoir



Objective: The objective is to eliminate the introduction of contamination through oil

being added to the system or contaminants being added through the air intake of the reservoir. A valve needs to be installed for oil sampling.

Additional Information: The air breather strainer should be replaced with a 10-micron filter if the hydraulic reservoir cycles.

A quick disconnect should be installed on the bottom of the hydraulic unit and at the $\frac{3}{4}$ level point on the reservoir with valves to isolate the quick disconnects in case of failure. This allows the oil to added from a filter pump as previously discussed and would allow for external filtering of the hydraulic reservoir oil if needed. Install a petcock valve on the front of the reservoir that will be used for consistent oil sampling.

Equipment and parts needed:

- Quick disconnects that meet or exceeds the flow rating of the Portable Filter Pump.

Two gate valves with pipe nipples.

One 10-micron filter breather.

WARNING: Do not weld on a hydraulic a reservoir to install the quick disconnects or air filter.

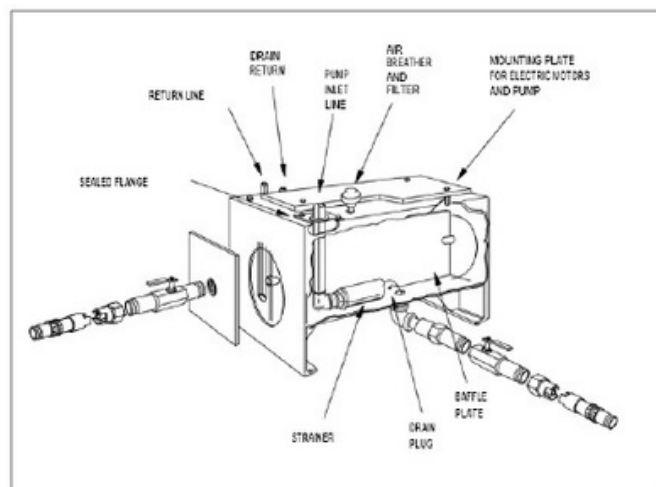

HYDRAULIC SYSTEM ROOT CAUSE FAILURE ANALYSIS

As in any proactive maintenance organization you must perform Root Cause Failure Analysis in order to eliminate future component failures. Most maintenance problems or failures will repeat themselves without someone identifying what caused the failure and proactively eliminate it. A preferred method is to inspect and analyze all component failures. Identify the following:

Component Type and Part Number

Location of component at the time of failure.

Sequence or activity the system was operating at when the failure occurred.

What was the Root Cause of the failure?

How will the failure be prevented from happening again?

Failures are not caused by an unknown factor like “bad luck” or “it just happened” or “the manufacturer made a bad part”. We have found most failures can be analyzed and prevention taken to prevent their reoccurrence. Establishing teams to review each failure can pay off in major ways.

To summarize, maintenance of a hydraulic system is the first line of defense to prevent component failure and thus improve equipment reliability. As spoken about earlier, discipline is the key to the success of any proactive maintenance program.

Join me for a three-day workshop on 'Best Maintenance Technician Practices' - more info below.



Preventive Maintenance Best Practices plus, PM Optimization Workshop "March 23-25"



"Virtual" via ZOOM (internet) or Live at Southern Wesleyan University
(4 miles from Clemson, SC and 30 miles from GSP Airport)

Reasons why you should attend...

1. Learn and Practice in the workshop how to write an effective PM Procedure in a "Hands On" Exercise (1 of 20 exercises)
2. Practice "How to Optimize your PMs" in a "Hands On" Exercise" (bring your PMs which we can Optimize in the Workshop)
3. Create an Action Plan using the crawl, walk, methodology to implement when you return
4. ...and so much more

Interested? Questions? – Contact us at rsmith@worldclassmaintenance.org
or go to www.worldclassmaintenance.org

#1 Software for Maintenance & Reliability Teams

UpKeep is a service-first company that builds software designed to make maintenance easier for technicians and managers everywhere. Reduce downtime up to 18% by switching over to a preventative maintenance solution!

www.upkeep.com

Our Products



Mobile-first maintenance management and collaboration across all location, assets, and teams

With nearly 340 different machines in our work environment, it's an impossible task to manually assign and track PM's. **With UpKeep we can schedule regular maintenance without overlapping tasks with other critical jobs."**

★★★★★ Paul D, Health and Safety Coordinator

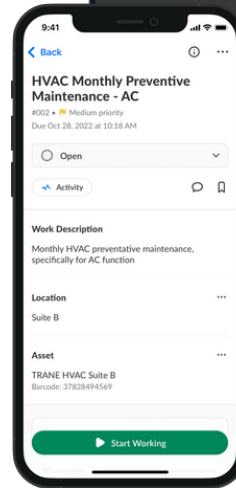
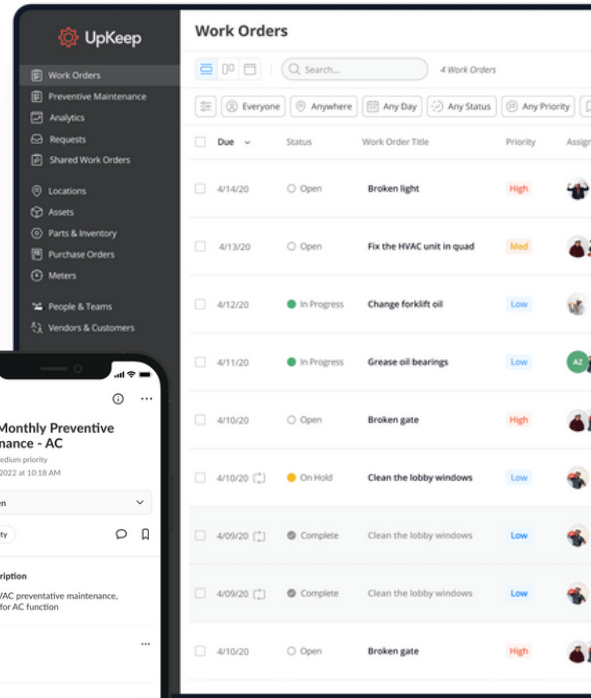

An end-to-end solution for remote condition-based monitoring

Connected and secure IoT sensors for real-time remote condition asset monitoring



Integrated & Centralized Data Ecosystem for World Class Asset Operations

The only purpose built Asset Data Platform. Asset Focused ELT Solution for advanced analytics and integrated, real-time asset data.

The Maintenance Community Coalition was founded on the belief that working together will benefit everyone within our community

Committed to helping each other thrive in our individual professional journeys by sharing resources and expertise, granting scholarships, hosting events, and unlocking knowledge – always at no cost.

