

AD/A066 579

RELIABILITY-CENTERED MAINTENANCE

F.S. Nowlan, et al

United Airlines
San Francisco, California

December 1978

REPRODUCED BY
U.S. DEPARTMENT OF COMMERCE
NATIONAL TECHNICAL
INFORMATION SERVICE
SPRINGFIELD, VA 22161



Unclassified

SECURITY CLASSIFICATION OF THIS PAGE (When Data Entered)

REPORT DOCUMENTATION PAGE		READ INSTRUCTIONS BEFORE COMPLETING FORM
1. REPORT NUMBER AD-A066-579	2. GOVT ACCESSION NO.	3. RECIPIENT'S CATALOG NUMBER
4. TITLE (and Subtitle) Reliability-Centered Maintenance	5. TYPE OF REPORT & PERIOD COVERED Final	
	6. PERFORMING ORG. REPORT NUMBER	
7. AUTHOR(s) F. Stanley Nowlan Howard F. Heap	8. CONTRACT OR GRANT NUMBER(s) MDA 903-75-C-0349	
9. PERFORMING ORGANIZATION NAME AND ADDRESS United Airlines San Francisco International Airport San Francisco, Ca 94128	10. PROGRAM ELEMENT, PROJECT, TASK AREA & WORK UNIT NUMBERS	
11. CONTROLLING OFFICE NAME AND ADDRESS Office of Assistant Secretary of Defense (Manpower, Reserve Affairs and Logistics) Washington, DC 20301	12. REPORT DATE December 29, 1978	
	13. NUMBER OF PAGES 476	
14. MONITORING AGENCY NAME & ADDRESS (if different from Controlling Office)	15. SECURITY CLASS. (of this report) Unclassified	
	15a. DECLASSIFICATION/DOWNGRADING SCHEDULE	
16. DISTRIBUTION STATEMENT (of this Report) Approved for public release; distribution unlimited. Copies may be obtained from the National Technical Information Service or the Defense Documentation Center.		
17. DISTRIBUTION STATEMENT (of the abstract entered in Block 20, if different from Report)		
18. SUPPLEMENTARY NOTES This work was performed by United Airlines under the sponsorship of the Office of Assistant Secretary of Defense (Manpower, Reserve Affairs and Logistics)		
19. KEY WORDS (Continue on reverse side if necessary and identify by block number) Actuarial analysis Aircraft maintenance Cost effectiveness Decision theory Evaluation Failure effects Flight safety Logistics Maintenance program Mechanical safety Preventive maintenance Product improvement Reliability Scheduled maintenance System effectiveness		
20. ABSTRACT (Continue on reverse side if necessary and identify by block number) This book explains basic concepts, principles, definitions, and applications of a logical discipline for development of efficient scheduled (preventive) maintenance programs for complex equipment, and the on-going management of such programs. Such programs are called reliability-centered maintenance (RCM) programs because they are centered on achieving the inherent safety and reliability capabilities of		

Unclassified

SECURITY CLASSIFICATION OF THIS PAGE (When Data Entered)

Unclassified

SECURITY CLASSIFICATION OF THIS PAGE (When Data Entered)

20. ABSTRACT (Continued)

equipment at a minimum cost. A U.S. Department of Defense objective in sponsoring preparation of this document was that it serve as a guide for application to a wide range of different types of military equipment.

There are essentially only four types of tasks in a scheduled maintenance program. Mechanics can be asked to:

- Inspect an item to detect a potential failure
- Rework an item before a maximum permissible age is exceeded
- Discard an item before a maximum permissible age is exceeded
- Inspect an item to find failures that have already occurred but were not evident to the equipment operating crew

A central problem addressed in this book is how to determine which types of scheduled maintenance tasks, if any, should be applied to an item and how frequently assigned tasks should be accomplished. The use of a decision diagram as an aid in this analysis is illustrated. The net result is a structured, systematic blend of experience, judgment, and operational data/information to identify and analyze which type of maintenance task is both applicable and effective for each significant item as it relates to a particular type of equipment. A concluding chapter emphasizes the key importance of having a mutually supportive partnership between the personnel responsible for equipment design and the personnel responsible for equipment maintenance if maximum RCM results are to be achieved.

Appendices are included as follows:

- Procedures for auditing the development and implementation of an RCM program
- A historical review of equipment maintenance evolution
- Techniques of performing actuarial analyses
- An annotated bibliography

AD/A066 579

RELIABILITY-CENTERED MAINTENANCE

reliability-centered

il

maintenance

F. STANLEY NOWLAN

Director, Maintenance Analysis
United Airlines

HOWARD F. HEAP

Manager, Maintenance Program Planning
United Airlines

Produced by Dolby Access Press

**Designer Nancy Clark, illustrators David A. Strassman
and Evanell Towne, compositor Jonathan D. Peck,
printer Braun-Brumfield, Inc.**

preface

THIS VOLUME provides the first full discussion of reliability-centered maintenance as a logical discipline for the development of scheduled-maintenance programs. The objective of such programs is to realize the inherent reliability capabilities of the equipment for which they are designed, and to do so at minimum cost. Each scheduled-maintenance task in an RCM program is generated for an identifiable and explicit reason. The consequences of each failure possibility are evaluated, and the failures are then classified according to the severity of their consequences. Then for all significant items—those whose failure involves operating safety or has major economic consequences—proposed tasks are evaluated according to specific criteria of applicability and effectiveness. The resulting scheduled-maintenance program thus includes all the tasks necessary to protect safety and operating reliability, and only the tasks that will accomplish this objective.

Up to this point the only document describing the use of decision diagrams for developing maintenance programs has been MSG-2, the predecessor of RCM analysis. MSG-2 was concerned primarily with the development of prior-to-service programs and did not cover the use of operating information to modify the maintenance program after the equipment enters service or the role of product improvement in equipment development. The chief focus was on the identification of a set of tasks that would eliminate the cost of unnecessary maintenance without compromising safety or operating capability. There was no mention of the problem of establishing task intervals, of consolidating the tasks into work packages, or of making decisions where the necessary information is unavailable. The treatment of structure programs was sketchy, and zonal and other general inspection programs were not discussed at all.

The difficulty that many people experienced in attempting to apply the concepts of MSG-2 indicated the need for changes and additions simply to clarify many of the points. It was also abundantly clear, however, that the scope of the material should be expanded to cover the topics that had not been discussed in that document. This volume includes a major expansion of the discussion on the problem of identifying functionally and structurally significant items. The RCM decision diagram itself is quite different from the one used for MSG-2. Instead of beginning with the evaluation of proposed maintenance tasks, the decision logic begins with the factor that determines the maintenance requirements of each item — the consequences of a functional failure — and then an evaluation of the failure modes that cause it. This new diagram also recognizes the four basic maintenance tasks that mechanics can perform (instead of three maintenance processes), thereby clarifying the treatment of items with hidden functions. The role of a hidden-function failure in a sequence of multiple independent failures is stressed, and it is also shown that the consequences of a possible multiple failure are explicitly recognized in the definition of the consequences of the first failure.

Another important aspect of the RCM decision logic is that it includes a default strategy for making initial maintenance decisions in the absence of full information. There is a full discussion of the problem of assigning task intervals, particularly those for first and repeat on-condition inspections. The role of age exploration and the use of information derived from operating experience, both to modify the initial maintenance program and to initiate product improvement, is discussed at length. The content of scheduled-maintenance programs developed by experienced practitioners of MSG-2 techniques may be quite similar to the programs resulting from RCM analysis, but the RCM approach is more rigorous, and there should be much more confidence in its outcome. The RCM technique can also be learned more quickly and is more readily applicable to complex equipment other than transport aircraft.

Part One of this volume presents a full explanation of the theory and principles of reliability-centered maintenance, including a discussion of the failure process, the criteria for each of the four basic tasks, the use of the decision logic to develop an initial program, and the age-exploration activities that result in a continuing evolution of this program after the equipment enters service. Part Two describes the application of these principles to the analysis of typical items in the systems, powerplant, and structure division of an airplane; the considerations in packaging the RCM tasks, along with other scheduled tasks, for actual implementation; and the information systems necessary for management of the ongoing maintenance program. The concluding chapter discusses the relationship of scheduled maintenance to operating safety, the design-maintenance partnership, and the application of

RCM analysis both to in-service fleets and to other types of complex equipment.

The text is followed by four appendices. Appendix A outlines the principles of auditing a program-development project and discusses some of the common problems that arise during analysis. This material provides an excellent check list for the analyst as well as the auditor and should be especially useful as a teaching aid for those conducting training groups in RCM methods. Appendix B is a historical review of the changes in maintenance thinking in the airline industry. Appendix C is a discussion of the engineering procedures and techniques used in actuarial analysis of reliability data. Appendix D, written by Dr. James L. Dolby, is a discussion of the literature in reliability theory, information science, decision analysis, and other areas related to RCM analysis and provides an annotated guide to this literature as well as to the specific literature on reliability-centered maintenance. Dr. Howard L. Resnikoff has written an accompanying mathematical treatment of the subject, titled *Mathematical Aspects of Reliability-Centered Maintenance*.

A book of this nature is the result of many efforts, only a few of which can be acknowledged here. First of all, we wish to express our gratitude to the late W. C. Mentzer, who directed the pioneering studies of maintenance policy at United Airlines, and to the Federal Aviation Administration for creating the environment in which this work was developed over the last twenty years. We also thank Charles S. Smith and Joseph C. Saia of the Department of Defense, who defined the content of the present text and counseled us throughout its preparation. James L. Dolby of San Jose State University, in addition to preparing the bibliography, contributed his expertise to the text. In particular, he helped to develop the concept of partitioning to identify significant items and the concept of default answers as part of the decision logic, as well as advising us on the actuarial appendix. Nancy Clark edited our efforts and organized them for clear exposition. Her logical thought processes resulted in numerous major improvements throughout and made possible the successful translation of our manuscript to textbook form.

Much help on specific areas of the text has come from friends and coworkers in the industry. We especially wish to thank Mel Stone of Douglas Aircraft for his extensive help with the structure chapter, John F. McDonald of the Flying Tiger Line for his comments on the theoretical chapters, and John F. Pirtle of General Electric for his comments on the powerplant chapter. Of the many others whose contributions influenced the text in some important respect, we give particular thanks to Thomas M. Edwards of United Airlines, Thomas D. Matteson of United Airlines, Ernest Boyer of the Federal Aviation Administration, Captain L. Ebbert of the U.S. Navy, Edward L. Thomas of the Air Transport Association, and Robert Gard of the University of Missouri.

We are also grateful to the many people at United Airlines who provided us with specific help and assistance. The manuscript itself would not have materialized without the efforts of Marie Tilson, who cheerfully typed and retyped the material through many drafts. We also thank Claudia Tracy, whose artwork made the draft manuscript more readable, and J. Douglas Burch, whose efforts throughout the project helped bring it to completion. Finally, we would like to thank the management of United Airlines for its patience and our wives for their encouragement over the many long months of authorship and publication.

*F. Stanley Nowlan
Howard F. Heap*

contents

PREFACE *vii*

A MAINTENANCE PHILOSOPHY *xvi*

CHAPTER ONE **rcm: a maintenance discipline** 2

- 1-1 THE EVOLUTION OF RCM ANALYSIS 4
- 1-2 THE BASIS OF RCM DECISION LOGIC 6
- 1-3 RELIABILITY PROBLEMS IN COMPLEX EQUIPMENT 9
- 1-4 AN OVERVIEW OF MAINTENANCE ACTIVITY 11

PART ONE THEORY AND PRINCIPLES 15

CHAPTER TWO **the nature of failure** 16

- 2-1 THE DEFINITION OF FAILURE 17
- 2-2 THE DETECTION OF FAILURES 20
- 2-3 THE CONSEQUENCES OF FAILURE 25
- 2-4 MULTIPLE FAILURES 28
- 2-5 THE FAILURE PROCESS 31
- 2-6 FAILURE IN COMPLEX ITEMS 37

2·7 QUANTITATIVE DESCRIPTIONS OF FAILURE 39

2·8 AGE-RELIABILITY CHARACTERISTICS 45

CHAPTER THREE the four basic maintenance tasks 50

3·1 SCHEDULED ON-CONDITION TASKS 51

3·2 SCHEDULED REWORK TASKS 56

3·3 SCHEDULED DISCARD TASKS 58

3·4 SCHEDULED FAILURE-FINDING TASKS 61

3·5 CHARACTERISTICS OF THE BASIC TASKS 65

3·6 THE DIMENSIONS OF A SCHEDULED-MAINTENANCE PROGRAM 71

3·7 PRODUCT IMPROVEMENT AS PREVENTIVE MAINTENANCE 75

CHAPTER FOUR developing the initial program 78

4·1 THE NATURE OF SIGNIFICANT ITEMS 80

4·2 THE RCM DECISION PROCESS 86

4·3 USE OF THE RCM DECISION DIAGRAM 91

4·4 DETERMINING COST EFFECTIVENESS 100

4·5 AGE EXPLORATION 106

4·6 PACKAGING THE MAINTENANCE TASKS 109

CHAPTER FIVE evolution of the rcm program 112

5·1 THE USES OF OPERATING DATA 113

5·2 REACTING TO SERIOUS FAILURES 116

5·3 REFINING THE MAINTENANCE PROGRAM 121

5·4 REVISIONS IN MAINTENANCE REQUIREMENTS 126

5·5 THE PRODUCT-IMPROVEMENT PROCESS 128

5·6 RCM PROGRAMS FOR IN-SERVICE EQUIPMENT 137

PART TWO APPLICATIONS 139

CHAPTER SIX applying rcm theory to aircraft 140

- 6-1 A SUMMARY OF RCM PRINCIPLES 141
- 6-2 ORGANIZATION OF THE PROGRAM-DEVELOPMENT TEAM 145
- 6-3 BEGINNING THE DECISION PROCESS 147
- 6-4 THE INFORMATION FLOW IN DECISION MAKING 153

CHAPTER SEVEN rcm analysis of systems 158

- 7-1 CHARACTERISTICS OF SYSTEMS ITEMS 159
- 7-2 ASSEMBLING THE REQUIRED INFORMATION 161
- 7-3 ANALYSIS OF TYPICAL SYSTEMS ITEMS 166
- 7-4 ESTABLISHING TASK INTERVALS 192

CHAPTER EIGHT rcm analysis of powerplants 194

- 8-1 CHARACTERISTICS OF POWERPLANT ITEMS 195
- 8-2 ASSEMBLING THE REQUIRED INFORMATION 199
- 8-3 FAILURES OF THE BASIC ENGINE FUNCTION 205
- 8-4 FAILURES OF SECONDARY ENGINE FUNCTIONS 217
- 8-5 THE ROLE OF AGE EXPLORATION 224

CHAPTER NINE rcm analysis of structures 228

- 9-1 CHARACTERISTICS OF STRUCTURAL ITEMS 229
- 9-2 THE STRUCTURAL INSPECTION PLAN 238
- 9-3 ASSEMBLING THE REQUIRED INFORMATION 247
- 9-4 RCM ANALYSIS OF STRUCTURAL ITEMS 252
- 9-5 ESTABLISHING INITIAL INSPECTION INTERVALS 256
- 9-6 STRUCTURAL AGE EXPLORATION 273

CHAPTER TEN completing the maintenance program 276

10-1 OTHER SCHEDULED-MAINTENANCE TASKS 277

10-2 PACKAGING THE MAINTENANCE WORKLOAD 284

CHAPTER ELEVEN the use of operating information 292

11-1 TYPICAL INFORMATION SYSTEMS 293

11-2 TYPICAL TYPES OF ROUTINE ANALYSIS 301

11-3 MODIFYING THE MAINTENANCE PROGRAM 307

11-4 INTERVALS: AN INFORMATION PROGRAM 324

11-5 RESOLVING DIFFERENCES OF OPINION 325

11-6 PURGING THE PROGRAM 328

CHAPTER TWELVE the role of scheduled maintenance 330

12-1 SAFETY, RELIABILITY, AND SCHEDULED MAINTENANCE 331

12-2 AIR-TRANSPORT SAFETY LEVELS 337

12-3 THE DESIGN-MAINTENANCE PARTNERSHIP 341

12-4 RCM PROGRAMS FOR IN-SERVICE FLEETS 343

12-5 EXPANSION OF RCM APPLICATIONS 347

PART THREE APPENDICES 349

APPENDIX A auditing rcm program development 350

A-1 AUDITING THE PROGRAM-DEVELOPMENT PROJECT 351

A-2 AUDITING THE DECISION PROCESS 354

A-3 AUDITING ANALYSIS OF THE EQUIPMENT 362

A-4 AUDITING THE ONGOING PROGRAM 367

A-5 AUDITING NEW PROGRAMS FOR IN-SERVICE FLEETS 368

APPENDIX B the history of rcm programs 370

- B-1 THE HARD-TIME PARADOX 371**
- B-2 CHANGING PERCEPTIONS OF THE HARD-TIME POLICY 376**
- B-3 THE INTRODUCTION OF ON-CONDITION MAINTENANCE 383**
- B-4 THE AIR TRANSPORT ASSOCIATION MSG-1 AND MSG-2 PROGRAMS 385**
- B-5 THE RELATIONSHIP OF SCHEDULED MAINTENANCE TO OPERATING SAFETY 387**

APPENDIX C actuarial analysis 390

- C-1 ANALYSIS OF LIFE-TEST DATA 391**
- C-2 ANALYSIS OF DATA FROM A DEFINED CALENDAR PERIOD 395**
- C-3 THE SMOOTHING PROBLEM 402**
- C-4 ANALYSIS OF A MIXED POPULATION 408**
- C-5 USEFUL PROBABILITY DISTRIBUTIONS 411**
- C-6 A SPECIAL USE OF THE EXPONENTIAL DISTRIBUTION 417**

APPENDIX D bibliography 420

- D-1 HISTORICAL DEVELOPMENT 422**
- D-2 RELIABILITY THEORY AND ANALYSIS 425**
- D-3 INFORMATION SCIENCE AND DECISION ANALYSIS 427**
- D-4 MAINTENANCE THEORY AND PHILOSOPHY 430**
- D-5 MAINTENANCE APPLICATIONS 436**
- D-6 A GUIDE TO OTHER SOURCES 438**

GLOSSARY 453

INDEX 467

Executive Summary 480

XV

a maintenance philosophy

An operator's maintenance program has four objectives:

- ▶ To ensure realization of the inherent safety and reliability levels of the equipment
- ▶ To restore safety and reliability to their inherent levels when deterioration has occurred
- ▶ To obtain the information necessary for design improvement of those items whose inherent reliability proves inadequate
- ▶ To accomplish these goals at a minimum total cost, including maintenance costs and the costs of residual failures

Reliability-centered maintenance is based on the following precepts:

- ▶ A failure is an unsatisfactory condition. There are two types of failures: *functional failures*, usually reported by operating crews, and *potential failures*, usually discovered by maintenance crews.
- ▶ The consequences of a functional failure determine the priority of maintenance effort. These consequences fall into four categories:
 - ▶ Safety consequences, involving possible loss of the equipment and its occupants
 - ▶ Operational consequences, which involve an indirect economic loss as well as the direct cost of repair
 - ▶ Nonoperational consequences, which involve only the direct cost of repair
 - ▶ Hidden-failure consequences, which involve exposure to a possible multiple failure as a result of the undetected failure of a hidden function

- ▶ Scheduled maintenance is required for any item whose loss of function or mode of failure could have safety consequences. If preventive tasks cannot reduce the risk of such failures to an acceptable level, the item must be redesigned to alter its failure consequences.
- ▶ Scheduled maintenance is required for any item whose functional failure will not be evident to the operating crew, and therefore reported for corrective action.
- ▶ In all other cases the consequences of failure are economic, and maintenance tasks directed at preventing such failures must be justified on economic grounds.
- ▶ All failure consequences, including economic consequences, are established by the design characteristics of the equipment and can be altered only by basic changes in the design:
 - ▶ Safety consequences can in nearly all cases be reduced to economic consequences by the use of redundancy.
 - ▶ Hidden functions can usually be made evident by instrumentation or other design features.
 - ▶ The feasibility and cost effectiveness of scheduled maintenance depend on the inspectability of the item, and the cost of corrective maintenance depends on its failure modes and inherent reliability.
- ▶ The inherent reliability of the equipment is the level of reliability achieved with an effective maintenance program. This level is established by the design of each item and the manufacturing processes that produced it. Scheduled maintenance can ensure that the inherent reliability of each item is achieved, but no form of mainte-

nance can yield a level of reliability beyond that inherent in the design.

A reliability-centered maintenance program includes only those tasks which satisfy the criteria for both applicability and effectiveness. The *applicability* of a task is determined by the characteristics of the item, and its *effectiveness* is defined in terms of the consequences the task is designed to prevent.

- ▶ There are four basic types of tasks that mechanics can perform, each of which is applicable under a unique set of conditions. The first three tasks are directed at preventing functional failures of the items to which they are assigned and the fourth is directed at preventing a multiple failure involving that item:
 - ▶ On-condition inspections of an item to find and correct any potential failures
 - ▶ Rework (overhaul) of an item at or before some specified age limit
 - ▶ Discard of an item (or one of its parts) at or before some specified life limit
 - ▶ Failure-finding inspections of a hidden-function item to find and correct functional failures that have already occurred but were not evident to the operating crew
- ▶ A *simple item*, one that is subject to only one or a very few failure modes, frequently shows a decrease in reliability with increasing operating age. An age limit may be useful in reducing the overall failure rate of such items, and safe-life limits imposed on a single part play a crucial role in controlling critical failures.
- ▶ A *complex item*, one whose functional failure may result from many different failure modes, shows little or no decrease in overall reliability with increasing age unless there is a dominant failure mode. Age limits imposed on complex components and systems (including the equipment itself) therefore have little or no effect on their overall failure rates.

The RCM decision diagram provides a logical tool for determining which scheduled tasks are either necessary or desirable to protect the safety and operating capability of the equipment.

- ▶ The resulting set of RCM tasks is based on the following considerations:
 - ▶ The consequences of each type of functional failure

- ▶ The visibility of a functional failure to the operating crew (evidence that a failure has occurred)
- ▶ The visibility of reduced resistance to failure (evidence that a failure is imminent)
- ▶ The age-reliability characteristics of each item
- ▶ The economic tradeoff between the cost of scheduled maintenance and the benefits to be derived from it
- ▶ A multiple failure, resulting from a sequence of independent failures, may have consequences that would not be caused by any one of the individual failures alone. These consequences are taken into account in the definition of the failure consequences for the first failure.
- ▶ A default strategy governs decision making in the absence of full information or agreement. This strategy provides for conservative initial decisions, to be revised on the basis of information derived from operating experience.

A scheduled-maintenance program must be dynamic. Any prior-to-service program is based on limited information, and the operating organization must be prepared to collect and respond to real data throughout the operating life of the equipment.

- ▶ Management of the ongoing maintenance program requires an organized information system for surveillance and analysis of the performance of each item under actual operating conditions. This information is needed for two purposes:
 - ▶ To determine the refinements and modifications to be made in the initial maintenance program (including the adjustment of task intervals)
 - ▶ To determine the needs for product improvement
- ▶ The information derived from operating experience has the following hierarchy of importance:
 - ▶ Failures that could affect operating safety
 - ▶ Failures that have operational consequences
 - ▶ The failure modes of units removed as a result of failures
 - ▶ The general condition of unfailed parts in units that have failed
 - ▶ The general condition of serviceable units inspected as samples

- ▶ At the time an initial program is developed information is available to determine the tasks necessary to protect safety and operating capability. However, the information required to determine optimum task intervals and the applicability of age limits can be obtained only from age exploration after the equipment enters service.
- ▶ With any new equipment there is always the possibility of unanticipated failure modes. The first occurrence of any serious unanticipated failure immediately sets in motion the following product-improvement cycle:
 - ▶ An on-condition task is developed to prevent recurrences while the item is being redesigned.
 - ▶ The operating fleet is modified to incorporate the redesigned part.
 - ▶ After the modification has proved successful, the special task is eliminated from the maintenance program.
- ▶ Product improvement, based on identification of the actual reliability characteristics of each item through age exploration, is part of the normal development cycle of all complex equipment.

RELIABILITY-CENTERED MAINTENANCE

reliability-centered maintenance

THE TERM *reliability-centered maintenance* refers to a scheduled-maintenance program designed to realize the inherent reliability capabilities of equipment. For years maintenance was a craft learned through experience and rarely examined analytically. As new performance requirements led to increasingly complex equipment, however, maintenance costs grew accordingly. By the late 1950s the volume of these costs in the airline industry had reached a level that warranted a new look at the entire concept of preventive maintenance. By that time studies of actual operating data had also begun to contradict certain basic assumptions of traditional maintenance practice.

One of the underlying assumptions of maintenance theory has always been that there is a fundamental cause-and-effect relationship between scheduled maintenance and operating reliability. This assumption was based on the intuitive belief that because mechanical parts wear out, the reliability of any equipment is directly related to operating age. It therefore followed that the more frequently equipment was overhauled, the better protected it was against the likelihood of failure. The only problem was in determining what age limit was necessary to assure reliable operation.

In the case of aircraft it was also commonly assumed that all reliability problems were directly related to operating safety. Over the years, however, it was found that many types of failures could not be prevented no matter how intensive the maintenance activities. Moreover, in a field subject to rapidly expanding technology it was becoming increasingly difficult to eliminate uncertainty. Equipment designers were able to cope with this problem, not by preventing failures, but by

preventing such failures from affecting safety. In most aircraft all essential functions are protected by redundancy features which ensure that, in the event of a failure, the necessary function will still be available from some other source. Although fail-safe and "failure-tolerant" design practices have not entirely eliminated the relationship between safety and reliability, they have dissociated the two issues sufficiently that their implications for maintenance have become quite different.

A major question still remained, however, concerning the relationship between scheduled maintenance and reliability. Despite the time-honored belief that reliability was directly related to the intervals between scheduled overhauls, searching studies based on actuarial analysis of failure data suggested that the traditional hard-time policies were, apart from their expense, ineffective in controlling failure rates. This was not because the intervals were not short enough, and surely not because the teardown inspections were not sufficiently thorough. Rather, it was because, contrary to expectations, for many items the likelihood of failure did not in fact increase with increasing operating age. Consequently a maintenance policy based exclusively on some maximum operating age would, no matter what the age limit, have little or no effect on the failure rate.

At the same time the FAA, which is responsible for regulating airline maintenance practices, was frustrated by experiences showing that it was not possible for airlines to control the failure rate of certain types of engines by any feasible changes in scheduled-overhaul policy. As a result, in 1960 a task force was formed, consisting of representatives from both the FAA and the airlines, to investigate the capabilities of

scheduled maintenance. The work of this group led to an FAA/Industry Reliability Program, issued in November 1961. The introduction to that program stated:*

The development of this program is towards the control of reliability through an analysis of the factors that affect reliability and provide a system of actions to improve low reliability levels when they exist. . . . In the past, a great deal of emphasis has been placed on the control of overhaul periods to provide a satisfactory level of reliability. After careful study, the Committee is convinced that reliability and overhaul time control are not necessarily directly associated topics; therefore, these subjects are dealt with separately. Because the propulsion system has been the area of greatest concern in the recent past, and due to powerplant data being more readily available for study, programs are being developed for the propulsion system first as only one system at a time can be successfully worked out.

This approach was a direct challenge to the traditional concept that the length of the interval between successive overhauls of an item was an important factor in its failure rate. The task force developed a propulsion-system reliability program, and each airline involved in the task force was then authorized to develop and implement reliability programs in the area of maintenance in which it was most interested. During this process a great deal was learned about the conditions that must obtain for scheduled maintenance to be effective.† It was also found that in many cases there was no effective form of scheduled maintenance.

1·1 THE EVOLUTION OF RCM ANALYSIS

development of decision-
diagram techniques
predecessor programs:
MSG-1 and MSG-2

At United Airlines an effort was made to coordinate what had been learned from these various activities and define a generally applicable approach to the design of maintenance programs. A rudimentary decision-diagram technique was devised in 1965 and was refined over the next few years.† This technique was eventually embodied in a docu-

**FAA/Industry Reliability Program*, Federal Aviation Agency, November 7, 1961, p. 1.

†*Handbook for Maintenance Control by Reliability Methods*, FAA Advisory Circular 120-17, December 31, 1964.

‡H. N. Taylor and F. S. Nowlan, Turbine Engine Reliability Program, FAA Maintenance Symposium on Continued Reliability of Transport-type Aircraft Propulsion Systems, Washington, D.C., November 17-18, 1965. T. D. Matteson and F. S. Nowlan, Current Trends in Airline Maintenance Programs, AIAA Commercial Aircraft Design and Operations Meeting, Los Angeles, June 12-14, 1967. F. S. Nowlan, The Use of Decision Diagrams for Logical Analysis of Maintenance Programs, United Airlines internal document, August 2, 1967.

ment published under the title *Handbook: Maintenance Evaluation and Program Development*, generally known as MSG-1.* MSG-1 was used by special teams of industry and FAA personnel to develop the initial program issued by the FAA Maintenance Review Board for the Boeing 747. As described by the FAA, these teams

... sorted out the potential maintenance tasks and then evaluated them to determine which must be done for operating safety or essential hidden function protection. The remaining potential tasks were evaluated to determine whether they were economically useful. These procedures provide a systematic review of the aircraft design so that, in the absence of real experience, the best [maintenance] process can be utilized for each component and system.

The Boeing 747 maintenance program so developed was the first attempt to apply reliability-centered maintenance concepts. This program has been successful.

Subsequent improvements in the decision-diagram approach led in 1970 to a second document, *MSG-2: Airline/Manufacturer Maintenance Program Planning Document*, which was used to develop the scheduled-maintenance programs for the Lockheed 1011 and the Douglas DC-10.† These programs have been successful. MSG-2 has also been applied to tactical military aircraft such as the McDonnell F4J and the Lockheed P-3, and a similar document prepared in Europe was the basis of the initial scheduled-maintenance programs for such recent aircraft as the Airbus Industrie A-300 and the Concorde.

The objective of the techniques outlined by MSG-1 and MSG-2 was to develop a scheduled-maintenance program that assured the maximum safety and reliability of which the equipment was capable and would meet this requirement at the lowest cost. As an example of the economic benefits achieved with this type of program, under traditional maintenance policies the initial program for the Douglas DC-8 included scheduled overhaul for 339 items, whereas the initial program for the DC-10, based on MSG-2, assigned only seven items to overhaul. One of the items no longer subject to an overhaul limit in the later program was the turbine engine. Elimination of this scheduled task not only led to major reductions in labor and materials costs, but also reduced the spare-engine inventory required to cover shop activities by more than 50 percent. Since engines for larger airplanes now cost upwards of \$1 million each, this is a respectable saving.

*747 Maintenance Steering Group, *Handbook: Maintenance Evaluation and Program Development (MSG-1)*, Air Transport Association, July 10, 1968.

†*Federal Aviation Administration Certification Procedures*, May 19, 1972, par. 3036.

‡*Airline/Manufacturer Maintenance Program Planning Document: MSG-2*, Air Transport Association, R & M Subcommittee, Marcy 25, 1970.

As another example, under the initial program developed for the Boeing 747 it took United Airlines only 66,000 manhours on major structural inspections to reach an inspection interval of 20,000 hours. In contrast, traditional maintenance policies led to an expenditure of over 4 million manhours before the same interval was attained for structural inspections on the smaller and less complex Douglas DC-8. Cost reductions on this scale are of obvious importance to any organization responsible for maintaining large fleets of complex equipment. More important, they are achieved with no decrease in the reliability of the equipment; in fact, a clearer understanding of the failure process has actually improved operating reliability by making it easier to pinpoint signs of an imminent failure.

The specific developments that led to RCM concepts as a fundamental approach to maintenance planning are described in detail in Appendix B. Although MSG-1 and MSG-2 were short working papers, intended for use by a small number of people with extensive backgrounds in aircraft maintenance, further clarification of the basic principles has resulted in a logical discipline that applies to maintenance programs for any complex equipment.

1·2 THE BASIS OF RCM DECISION LOGIC

the nature of failure
identification of
significant items
evaluation of failure
consequences
selection of applicable and
effective tasks
the role of age exploration

The principles of reliability-centered maintenance stem from a rigorous examination of certain questions that are often taken for granted:

- ▶ How does a failure occur?
- ▶ What are its consequences?
- ▶ What good can preventive maintenance do?

One of the chief drawbacks of the old hard-time approach to scheduled maintenance is that the resulting teardown inspections provided no real basis for determining when serviceable parts were likely to fail—that is, there was no objective means of identifying reduced resistance to failure. More than any other single factor, recognition of the specific need to identify potential-failure conditions has been responsible for the change from scheduled overhauls to on-condition inspections for signs of imminent failure.

Unfortunately, not all items can be protected by this type of maintenance task. In some cases the failure mechanism is imperfectly understood, in others it is random, and in yet others the cost of such inspections exceeds the benefits they might provide. In fact, preventive maintenance is not possible for many items of modern complex equipment. Nor, in all cases, is it necessary. Failures which could jeopardize the safety of the equipment or its occupants must be prevented. Under

modern design practices, however, very few items fall into this category, either because an essential function is provided by more than one source or because operating safety is protected in some other way. Similarly, hidden functions must be protected by scheduled maintenance, both to ensure their availability and to prevent exposure to the risk of a multiple failure.

In all other cases the consequences of failure are economic, and the value of preventive maintenance must be measured in economic terms. In some cases these consequences are major, especially if a failure affects the operational capability of the equipment. Whenever equipment must be removed from service to correct a failure, the cost of failure includes that loss of service. Thus if the intended use of the equipment is of significant value, the delay or abandonment of that use will constitute a significant loss—a fact that must be taken into account in evaluating the benefit of preventive maintenance. Other failures will incur only the cost of correction or repair, and such failures may well be tolerable, in the sense that it is less expensive to correct them as they occur than to invest in the cost of preventing them.

In short, the driving element in all maintenance decisions is not the failure of a given item, but the consequences of that failure for the equipment as a whole. Within this context it is possible to develop an efficient scheduled-maintenance program, subject to the constraints of satisfying safety requirements and meeting operational-performance goals. However, the solution of such an optimization problem requires certain specific information which is nearly always unavailable at the time an initial program must be developed. Hence we also need a basic strategy for decision making which provides for optimum maintenance decisions, given the information available at the time. The process of developing an initial RCM program therefore consists of the following steps:

- ▶ Partitioning the equipment into object categories to identify those items that require intensive study
- ▶ Identifying significant items, those whose failure would have safety or major economic consequences for the equipment as a whole, and all hidden functions, which require scheduled maintenance regardless of their significance
- ▶ Evaluating the maintenance requirements for each significant item and hidden function in terms of the failure consequences and selecting only those tasks which will satisfy these requirements
- ▶ Identifying items for which no applicable and effective task can be found and either recommending design changes if safety is involved or assigning no scheduled-maintenance tasks to these items until further information becomes available

- ▶ Selecting conservative initial intervals for each of the included tasks and grouping the tasks in maintenance packages for application
- ▶ Establishing an age-exploration program to provide the factual information necessary to revise initial decisions

The first of these steps is intended, as a purely practical matter, to reduce the problem of analysis to manageable size and to focus it according to areas of engineering expertise. The next three steps are the crux of RCM analysis. They involve a specific sequence of decision questions, worded to indicate the information required for a yes/no answer in each case. Where this information is not available, a default answer specifies the action that will best protect the equipment until there is a basis for some other decision. This decision-diagram technique, described in full in Chapter 4, not only provides an orderly basis for making decisions with limited information, but also results in a clear audit trail for later review.

In the airline industry all scheduled-maintenance programs are, of course, subject to FAA review and approval. The initial program for each new type of equipment is promulgated by the FAA Maintenance Review Board. This document, developed in conference with the equipment manufacturers and the purchasing airlines, forms the basis of the initial program submitted by each airline for FAA approval. Organizations operating other equipment in the civilian and military spheres may define their initial maintenance programs differently, but some comparable review procedure is usually involved.

Because any initial scheduled-maintenance program must be developed and implemented in advance of actual operational data, an important element of RCM programs is age exploration, a procedure for systematic gathering of the information necessary to determine the applicability of some maintenance tasks and evaluate the effectiveness of others. As this information accumulates, the same decision diagram provides a means of revising and refining the initial program. Much of this information is already available, of course, for equipment that has been in service for some time. Although the specific data needed may have to be retrieved from several different information systems, and the remaining useful life of the equipment will be a factor in certain decisions, RCM analysis under these circumstances will result in fewer default decisions, and hence a near-optimum program at the outset. Such programs usually include a larger number of on-condition inspections than the programs arrived at under older policies, and fewer of the scheduled rework tasks which had been included simply because there was no evidence that they should not be done.

An effective scheduled-maintenance program will realize all the reliability of which the equipment is capable. However, no form of preventive maintenance can alter characteristics that are inherent in the

design. The residual failures that occur after all applicable and effective preventive tasks have been implemented reflect the inherent capability of the equipment, and if the resulting level of reliability is inadequate, the only recourse is engineering redesign. This effort may be directed at a single component to correct for a dominant failure mode or it may be directed at some characteristic that will make a particular preventive technique feasible. Product improvement of this kind takes place routinely during the early years of operation of any complex equipment. Thus, although reliability-centered maintenance is concerned in the short run with tasks based on the actual reliability characteristics of the equipment, it is also concerned with improvements that will ultimately increase delivered reliability.

1-3 RELIABILITY PROBLEMS IN COMPLEX EQUIPMENT

Failures are inevitable in any complex equipment, although their consequences can be controlled by careful design and effective maintenance. The reason for this failure incidence is apparent if we consider some basic differences between simple and complex equipment. Simple equipment is asked to perform very few different functions. Such equipment therefore consists of only a few systems and assemblies, and these in turn may be so simple that some are exposed to only one possible failure mode. In most cases this simplicity extends to the structural elements as well, and both the structure and the various items on the equipment are relatively accessible for inspection.

failure possibilities in
complex equipment
performance requirements
and reliability
the role of design in reducing
failure consequences

As a result, simple equipment has certain distinct failure characteristics. Because it is exposed to relatively few failure possibilities, its overall reliability tends to be higher. For the same reason, these failures tend to be age-related; each type of failure tends to concentrate around some average age, and since only a few types of failure are involved, they govern the average age at failure. However, in the absence of redundancy and other protective features, such failures may have fairly serious consequences. Thus simple equipment is often protected by "overdesign"; components are heavier and bulkier than necessary, and familiar materials and processes are used to avoid the uncertainty associated with more complex high-performance equipment.

All in all, the traditional idea that failures are directly related to safety and that their likelihood varies directly with age is often true for simple equipment. In any case, it is fairly easy to make an exhaustive study of such equipment to determine its scheduled-maintenance requirements.

The situation is quite different with the complex equipment in use today. The general-aviation aircraft of the 1930s usually had a simple

SECTION 1-3 9

Reproduced from
best available copy. 

reciprocating engine, a fixed-pitch propeller, fixed landing gear, and no wing flaps. The modern airplane may have several turboprop or turbojet powerplants, retractable landing gear, movable high-lift devices, an airframe anti-icing system, pressure- and temperature-control systems for the cabin, extensive communications and navigation equipment, complex cockpit instrumentation, and complex ancillary systems to support all these additional items. This increased complexity has greatly expanded the safe operational capability of the aircraft. The simple airplane of the 1930s was restricted to trips of a few hundred miles under reasonably favorable weather conditions. The higher performance capability demanded of modern equipment, however, has greatly increased not only the number of items that can fail, but the types of failure that can occur.

Each new design of any high-performance equipment is essentially an attempt to make earlier designs technologically obsolete, with the usual measure of improvement being potential operating capability (including operating costs). In other words, this is the operating capability expected in the absence of any failures that might change the circumstances. The basis for evaluating new aircraft designs usually includes performance factors such as the following.

- ▶ The maximum payload (military or commercial) that can be carried over a given distance
- ▶ The maximum distance over which a given payload can be carried
- ▶ The minimum size of the vehicle that can carry a given payload over a given distance
- ▶ The highest speed that can be attained under defined payload/range conditions
- ▶ Special capabilities, such as the ability to traverse rough terrain, operate from short runways, or withstand punishment

In some cases these factors are weighed against the anticipated direct operating costs (including maintenance costs) associated with attaining such capabilities, since a major objective may be to achieve the minimum cost per unit of payload transported. In other cases performance takes precedence over cost. This is true not only of military equipment, but of certain types of civilian equipment, where there is an adequate market for specialized capability despite its cost.

Another aspect of performance demands, of course, is the trend toward increasing automation. Examples are everywhere—automatic flight-control systems in aircraft, including automatic approach and landing equipment; automatic transmissions in automobiles; automated traffic-control systems for rapid-transit trains; and automatic aperture-setting devices in cameras.

The design of complex equipment, therefore, is always a tradeoff between achieving the required performance capability and acceptable reliability. This tradeoff entails an intentional compromise between the lightness and compactness required for high performance and the weight and bulk required for durability. Thus it is neither economically nor technologically feasible to produce complex equipment that can sustain trouble-free operation for an indefinite period of time. Although the reliability of certain items that perform single functions may be improving, the number of such items has been vastly multiplied. It is therefore inevitable that failures will occur—that is, that certain parts of the equipment will lose the capability of performing their specified functions.

Our concern is not with the number of these failures, but with the consequences of a given failure for the equipment as a whole. Will the loss of a particular function endanger the equipment or its occupants? If not, is it necessary to abort the mission or take the equipment out of service until repairs can be made? Or can unrestricted operation continue and the repair be deferred to a convenient time and place? The ability to defer failure consequences depends largely on the design of the equipment. One strategy is the use of redundancy and fail-safe construction. Another strategy is failure substitution, the use of a minor failure to preempt a major one, as in the use of fuses and circuit breakers. This latter concept extends to maintenance activities in which potential failures are used to preempt functional failures. Thus the design may include various instrumentation to give some warning of an impending failure or other features which facilitate inspection for possible deterioration. All these features actually increase the number of failure possibilities in the sense that they add more items that could fail. However, they greatly reduce the consequences of any single failure.

1.4 AN OVERVIEW OF MAINTENANCE ACTIVITY

The activities of a maintenance organization include both the scheduled work that is performed to avoid failures and the corrective work that is performed after failures have occurred. Our present concern is with *preventive maintenance*, the program of scheduled tasks necessary to ensure safe and reliable operation of the equipment. The complete collection of these tasks, together with their assigned intervals, is termed the *scheduled-maintenance program*. This program includes only the tasks that are scheduled in advance—servicing and lubrication, inspection, and scheduled removal and replacement of items on the equipment. Exhibit 1.1 lists some typical tasks in such a program.

In order to accomplish the anticipated corrective and scheduled maintenance, an operating organization must establish an overall sup-

corrective and scheduled
maintenance
scheduled-maintenance
program
maintenance stations
line maintenance and shop
maintenance

EXHIBIT 1-1 Typical scheduled-maintenance tasks for various items on aircraft. Some scheduled tasks are performed on the aircraft at line-maintenance stations and others are performed at the major maintenance base, either as part of a larger maintenance package or as part of the shop procedure whenever a failed unit is sent to the maintenance base for repair.

nature of item	scheduled-maintenance task	task interval
SYSTEMS ITEMS		
Fuel-pump assembly (Douglas A4)	On-condition (on aircraft): Inspect filter for contamination	60 operating hours
	On-condition (on aircraft): Inspect drive shaft for spline wear	1,000 operating hours
Brake assembly, main landing gear (Douglas DC-10)	On-condition (on aircraft): Inspect brake wear indicators	During overnight stops and walkaround checks
	On-condition (in shop): Test automatic brake adjuster	Whenever brake assembly is in shop
POWERPLANT ITEMS		
Compressor rear frame (General Electric CF6-6)	On-condition (on aircraft): Inspect front flange for cracks emanating from bolt holes	500 flight cycles or phase check (134 days), whichever is first
Nozzle guide vanes (Pratt & Whitney JT8D-7)	On-condition (on aircraft): Perform borescope inspection for burning, cracking, or bowing of guide vanes	1,000 operating hours
Tenth-stage compressor blades (Pratt & Whitney JT4)	Scheduled rework: Shot-peen blade dovetail and apply antigalling compound	6,000 operating hours
Stage 3 turbine disk (Pratt & Whitney JT9D)	Scheduled discard: Replace turbine disk with new part	15,000 flight cycles or 30,000 operating hours, whichever is first
STRUCTURAL ITEMS		
Rear spar at bulkhead intersection (Douglas DC-10)	On-condition (on aircraft): Inspect specified intersections in zones 531, 631, 141, 142 for cracks and corrosion	Primary strength-indicator areas 5,000 operating hours, internal fuel-tank areas 20,000 hours
Shock strut, main landing gear (Boeing 737)	On-condition (in shop): Strip cadmium plate and inspect for cracks and corrosion	19,500 operating hours

port plan which includes the designation of maintenance stations, staffing with trained mechanics, provision of specialized testing equipment and parts inventories, and so on. The overall maintenance plan of an airline is typical of that for any transportation system in which each piece of equipment operates through many stations but has no unique home station.

A large proportion of the failures that occur during operation are first observed and reported by the operating crew. Some of these must be corrected after the next landing, and a few are serious enough to require a change in flight plan. The correction of many other failures, however, can be deferred to a convenient time and location. Those line stations with a high exposure to the need for immediate corrective work are designated as *maintenance stations* and are equipped with trained mechanics, spare-parts inventory, and the facilities necessary to carry out such repairs. United Airlines serves 91 airline stations with 19 such maintenance stations.

The decision to designate a particular station as a maintenance station depends chiefly on the amount of traffic at that station and the reliability of the aircraft involved. A station at which the greatest volume of repairs is expected is the logical first choice. However, other considerations may be the frequency with which the operating schedule provides overnight layovers, the relative ease of routing other aircraft to that station, the availability of mechanics and parts to support other types of aircraft, the planned volume of scheduled-maintenance work, and so on.

Line-maintenance stations themselves vary in size and complexity. The facilities needed for immediate corrective work establish the minimum resources at any given maintenance station, but operating organizations generally consolidate the bulk of the deferrable work at a few of these stations for greater economy. To simplify the control of scheduled maintenance, individual tasks are grouped into a fairly small number of maintenance packages for execution. Like deferrable corrective work, these scheduled-maintenance packages can be assigned to any convenient maintenance station. Thus the more involved work is generally assigned to those line stations already equipped with the staff and inventories for extensive corrective work.

Not all scheduled-maintenance tasks can be carried out at line stations. Major structural inspections, scheduled rework, and inspections which entail extensive disassembly are best handled at a major maintenance base equipped with shop facilities. The major base also repairs failed units that are removed from aircraft at the line stations. Few such maintenance bases are needed, and reliability considerations generally determine their size and manpower requirements, rather than their location. Many large airlines operate efficiently with only one maintenance base. The work performed at a maintenance base is generally

termed *shop maintenance* to differentiate it from *line maintenance*, which consists primarily of replacing failed units rather than repairing them.

The entire process by which a detailed support plan is developed is beyond the scope of this volume. Suffice it to say that a detailed plan is necessary in order to implement a scheduled-maintenance program. Our concern here is with the development of such a program — or rather, with the principles underlying its development. In the following chapters we will examine the nature of failures, the basis on which their consequences are evaluated, and the specific criteria that determine the applicability and effectiveness of a given type of preventive task. With this framework established, we will consider the decision logic that results in a scheduled-maintenance program based on the actual reliability characteristics of the equipment. This reliability-centered approach ensures that the inherent safety and operating capability of the equipment will be realized at the minimum cost, given the information available at any time.

The chapters in Part Two illustrate the application of RCM decision logic to specific hardware examples and discuss some of the information processes involved in the continuing evolution of the maintenance program after the equipment enters service. All these illustrations are drawn from commercial-aircraft applications. However, it should be clear from the discussion in Part One that the basic principles of RCM programs extend not just to other operating contexts, but to maintenance programs for any complex equipment.

PART ONE

theory and principles

the nature of failure

THE PARTS of any mechanical equipment are subject to wear, corrosion, and fatigue which inevitably result in some deviation from the conditions that existed when the equipment was new. Ultimately the deviation will become great enough that the equipment, or some item on it, no longer meets the required performance standards—that is, it fails. The role of scheduled maintenance is to cope with the failure process. For years, however, the chief focus has been on anticipating the age at which things were likely to fail, rather than on how they fail and the consequences of such failures. As a result, there has been insufficient attention to the failure process itself, and even less attention to the question of precisely what constitutes a failure.

One reason for this lack of attention has been the common assumption that all equipment “wears out” and inevitably becomes less reliable with increasing operating age. This assumption led to the conclusion that the overall failure rate of an item will always be reduced by an age limit which precludes operation at ages where the likelihood of failure is greater. In accordance with this hard-time policy, all units were taken out of service when they reached a specified age and were sent to the major maintenance base for complete disassembly and overhaul, a procedure intended to restore each part to its original condition.

It is now known that the reliability of most complex items does not vary directly with operating age, at least not in such a way as to make hard-time overhaul a useful concept. Procedures directed at obtaining some precise evidence that a failure is imminent are frequently a far superior weapon against failure. However, to understand the specific nature of such procedures as they pertain to an RCM program, it is necessary to take a closer look at the entire concept of failure. Without a precise definition of what condition represents a failure, there is no

way either to assess its consequences or to define the physical evidence for which to inspect. The term *failure* must, in fact, be given a far more explicit meaning than "an inability to function" in order to clarify the basis of reliability-centered maintenance.

In this chapter we will examine the problem of defining failures and some of the implications this has for the analysis of failure data. We will also see how failure consequences are evaluated, both in terms of single failures and in terms of multiple failures. Finally, we will discuss the process of failure itself and see why complex items, unlike simple items, do not necessarily wear out.

2·1 THE DEFINITION OF FAILURE

Each of us has some intuitive notion of what constitutes a failure. We would all agree that an automobile engine, a fuel pump, or a tire has failed if it ceases to perform its intended function. But there are times when an item does continue to function, although not at its expected level. An automobile engine may run powerfully and smoothly, but its oil consumption is high; a fuel pump may pump fuel, but sluggishly; a tire may hold air and support the car, but its bald tread indicates that it will do neither much longer.

Have these items failed? If not, how bad must their condition become before we would say a failure has occurred? Moreover, if any of these conditions is corrected, the time required for unanticipated repairs might force a change in other plans, such as the delay or cancellation of a trip. In this event could it still be argued that no failure had occurred?

failure
functional failure
potential failure

To cover all these eventualities we can define a failure in broad terms as follows:

A failure is an unsatisfactory condition.

In other words, a failure is any identifiable deviation from the original condition which is unsatisfactory to a particular user. The determination that a condition is unsatisfactory, however, depends on the consequences of failure in a given operating context. For example, high oil consumption in an aircraft engine may pose no problem on short- or medium-range flights, whereas on long-range flights the same rate of consumption would exhaust the oil supply. Similarly, engine-instrument malfunctions that would not disrupt operations on multi-engine equipment would be clearly unsatisfactory on a single-engine plane, and performance that is acceptable in a land-based environment might not be good enough for carrier operation.

In short, the exact dividing line between satisfactory and unsatisfactory conditions will depend not only on the function of the item in question, but on the nature of the equipment in which it is installed and the operating context in which that equipment is used. The determination will therefore vary from one operating organization to another. Within a given organization, however, it is essential that the boundaries between satisfactory and unsatisfactory conditions be defined for each item in clear and unmistakable terms.

FUNCTIONAL FAILURE

The judgment that a condition is unsatisfactory implies that there must be some condition or performance standard on which this judgment can be based. As we have seen, however, an unsatisfactory condition can range from the complete inability of an item to perform its intended function to some physical evidence that it will soon be unable to do so. For maintenance purposes, therefore, we must classify failures further as either *functional failures* or *potential failures*:

A functional failure is the inability of an item (or the equipment containing it) to meet a specified performance standard.

A complete loss of function is clearly a functional failure. Note, however, that a functional failure also includes the inability of an item to function at the level of performance that has been specified as satisfactory. This definition thus provides us with an identifiable and measurable condition, a basis for identifying functional failures.

To define a functional failure for any item we must, of course, have a clear understanding of its functions. This is not a trivial consideration. For example, if we say that the function of the braking system on an airplane is to stop the plane, then only one functional failure is possible – inability to stop the plane. However, this system also has the functions of providing modulated stopping capability, providing differential braking for maneuvering on the ground, providing antiskid capability, and so on. With this expanded definition it becomes clear that the braking system is in fact subject to a number of different functional failures. It is extremely important to determine all the functions of an item that are significant in a given operating context, since it is only in these terms that its functional failures can be defined.

POTENTIAL FAILURE

Once a particular functional failure has been defined, some physical condition can often be identified which indicates that this failure is imminent. Under these circumstances it may be possible to remove the item from service before the point of functional failure. When such conditions can be identified, they are defined as *potential failures*:

A potential failure is an identifiable physical condition which indicates a functional failure is imminent.

The fact that potential failures can be identified is an important aspect of modern maintenance theory, because it permits maximum use of each item without the consequences associated with a functional failure. Units are removed or repaired at the potential-failure stage, so that potential failures preempt functional failures.

For some items the identifiable condition that indicates imminent failure is directly related to the performance criterion that defines the functional failure. For example, one of the functions of a tire tread is to provide a renewable surface that protects the carcass of the tire so that it can be retreaded. This function is not the most obvious one, and it might well be overlooked in a listing of tire functions; nevertheless, it is important from an economic standpoint. Repeated use of the tire wears away the tread, and if wear continues to the point at which the carcass cannot be retreaded, a functional failure has occurred. To prevent this particular functional failure, we must therefore define the potential failure as some wear level that does not endanger the carcass.

The ability to identify either a functional or a potential failure thus depends on three factors:

- ▶ Clear definitions of the functions of an item as they relate to the equipment or operating context in which the item is to be used

- ▶ A clear definition of the conditions that constitute a functional failure in each case
- ▶ A clear definition of the conditions that indicate the imminence of this failure

In other words, we must not only define the failure; we must also specify the precise evidence by which it can be recognized.

2·2 THE DETECTION OF FAILURES

the role of the operating crew
evident and hidden functions
verification of failures
interpreting failure data

Both functional failures and potential failures can be defined in terms of identifiable conditions for a given operating context. In evaluating failure data, however, it is important to take into account the different frames of reference of several sets of failure observers—the operating crew, the line mechanic, the shop mechanic, and even passengers. Understanding how and when the observer sees a failure and how he interprets it is crucial both to operating reliability and to effective preventive maintenance.

The detection and reporting of failures depends on two principal elements:

- ▶ The observer must be in a position to detect the failure. This “right” position may be a physical location, a particular moment in time, or access to the inspection equipment that can reveal the condition.
- ▶ The observer must have standards that enable him to recognize the condition he sees as a failure, either functional or potential.

THE ROLE OF THE OPERATING CREW

Members of the operating crew are the only people in a position to observe the dynamic operation of the equipment in its normal environment. Whereas an airplane in a maintenance facility is in a static environment, during flight its systems are activated and the whole machine is subjected to airloads and to both low atmospheric pressure and low outside temperatures. As a result, the operating crew will be the first to observe many functional failures. Such failures are often detected at the time a crew member calls on a function and finds that it is impaired.

In most complex equipment the crew’s ability to observe failures is further enhanced by extensive instrumentation, warning lights, or other monitoring devices. In some cases these indicators make failures evident at the moment they occur, when otherwise they might go undetected until the function was needed. Such early warning provides more time for changes in operating strategy to offset the consequences

of the failure. For example, certain engine malfunctions may require the shutdown of one engine and perhaps the selection of an alternate landing field, or an auxiliary hydraulic pump may have to be turned on after one of the main ones fails. Even when the flight can be continued without incident, the crew is required to record the failure as accurately as possible in the flight log so the condition can be corrected at the earliest opportunity.

This instrumentation also permits the crew to determine whether items that are still operative are functioning as well as they should. In some cases reduced performance is an indication of an imminent failure, and these conditions would also be examined later to see whether a potential failure exists.

Not surprisingly, the operating crew plays a major role in detecting failure conditions. This is illustrated by a study of the support costs on a fleet of Boeing 747's over the first ten months of 1975 (a total of 51,400 operating hours). In this case 66.1 percent of all failure reports while the plane was away from the maintenance base originated with the operating crew, and these failures accounted for 61.5 percent of the total man-hours for corrective line maintenance. The other 33.9 percent of the reported failures included potential failures detected by line mechanics, along with other failures not normally evident to the operating crew.

HIDDEN-FUNCTION ITEMS

Although most functional failures are first detected by the operating crew, many items are subject to failures that the crew is not in a position to observe. The crew duties often include special checks of certain hidden-function items, but most such failures must be found by inspections or tests performed by maintenance personnel. To ensure that we will know when a failure has occurred, we must know that the observer is in a position to detect it. Hence for maintenance purposes a basic distinction is made between *evident* and *hidden functions* from the vantage point of the operating crew:

An evident function is one whose failure will be evident to the operating crew during the performance of normal duties.

A hidden function is one whose failure will not be evident to the operating crew during the performance of normal duties.

An item may have several functions, any one of which can fail. If the loss of one of these functions would not be evident, the item must be classified from the maintenance standpoint as a hidden-function item.

Hidden functions may be of two kinds:

- ▶ A function that is normally active but gives no indication to the operating crew if it ceases
- ▶ A function that is normally inactive, so that the crew cannot know whether it will be available when it is needed (usually the demand follows some other failure)

The fire-detection system in an aircraft powerplant falls into the first category. This system is active whenever the engine is in use, but its sensing function is hidden unless it detects a fire; thus if it fails in some way, its failure is similarly hidden. The fire-extinguishing system that backs up this unit has the second kind of hidden function. It is not activated unless a fire is detected, and only when it is called upon to operate does the crew find out whether it works.

In addition to inspecting for potential failures, maintenance personnel also inspect most hidden-function items for functional failures. Thus the operating crew and the maintenance crew complement one another as failure observers.

VERIFICATION OF FAILURES

Operating crews occasionally report conditions which appear unsatisfactory to them, but which are actually satisfactory according to the defined standards for condition and performance. This is a basic principle of prevention. The operating crew cannot always know when a particular deviation represents a potential failure, and in the interests of safety the crew is required to report anything questionable. In most airlines the operating crew can communicate directly with a central group of maintenance specialists, or controllers, about any unusual conditions observed during flight. The controllers can determine the consequences of the condition described to them and advise the crew whether to land as soon as possible or continue the flight, with or without operating restrictions. The controllers are also in a position to determine whether the condition should be corrected before the plane is dispatched again. This advice is particularly important when a plane is operating into a station which is not a maintenance station.

Once the plane is available for maintenance inspection, the maintenance crew is in a better position to diagnose the problem and determine whether a failure condition actually does exist. Thus the suspect item may be replaced or repaired or marked "OK for continued operation." The fact that failure observers have different frames of reference for interpreting the conditions they see often makes it difficult to evaluate failure reports. For example, a broken seat recliner is recognizable to any observer as a failure. Frequently a passenger will notice the con-

dition first and complain about it to the flight attendant. The line mechanic at the next maintenance station will take corrective action, usually by replacing the mechanism and sending the failed unit to the maintenance base, where the shop mechanic will record the failure and make the repair. In this case all four types of observer would have no difficulty recognizing the failure.

The situation is somewhat different with an in-flight engine shutdown as a result of erratic instrument readings. Although the passengers would not be aware that a failure had occurred, the operating crew would report an engine failure. However, the line mechanic might discover that the failure was in the cockpit instruments, not the engine. He would then replace the faulty instrument and report an instrument failure. Thus the crew members are the only ones in a position to observe the failure, but they are not in a position to interpret it. Under other circumstances the situation may be reversed. For example, on certain engines actual separation of the turbine blades—a functional failure—is preceded by a perceptible looseness of one or more blades in their mounts. If the blades separate, both the operating crew and the passengers may become abruptly aware of the functional failure, but since the engine functions normally with loose blades, neither crew nor passengers have any reason to suspect a potential failure. In this case the crew members might be able to interpret the condition as a potential failure, but they are not in a position to observe it.

The line mechanic who inspects the engine as part of scheduled maintenance will check for loose blades by slowly rotating the turbine assembly and feeling the blades with a probe (typically a length of stiff rubber or plastic tubing). If he finds any loose blades, he will report a failure and remove the engine. The mechanics in the engine-repair shop are in an even better position for detailed observation, since they must go inside the engine case to get at the faulty blades. (On occasion they may be the first to observe loose blades in an engine removed for other reasons.) If they confirm the line mechanic's diagnosis, they will report the failure as verified.

Of course, the situation is not always this clear cut. Often there are no precise troubleshooting methods to determine exactly which component or part is responsible for a reported malfunction. Under these circumstances the line mechanic will remove several items, any one of which might have caused the problem. This practice is sometimes referred to as "shotgun" troubleshooting. Many of these suspect items will show normal performance characteristics when they are tested at the maintenance base. Thus, although they are reported as failures at the time they are removed from the equipment, from the shop mechanic's frame of reference they are unverified failures. By the same token, differences between the testing environment and the field environment

will sometimes result in unverified failures for items that are actually suffering functional failures in the field.

Units removed from equipment either as potential failures or because of malfunctions are termed *premature removals*. This term came into use when most equipment items had a fixed operating-age limit. A unit removed when it reached this limit was "time-expired," whereas one removed because it had failed (or was suspected of having failed) before this age limit was a "premature" removal.

INTERPRETING FAILURE DATA

The problem of interpreting failure data is further complicated by differences in reporting policy from one organization to another. For example, one airline might classify an engine removed because of loose turbine blades as a failure (this classification would be consistent with our definition of a potential failure). This removal and all others like it would then be counted as failures in all failure data. Another airline might classify such removals as "precautionary," or even as "scheduled" (having discovered a potential failure, they would then schedule the unit for removal at the earliest opportunity). In both these cases the removals would not be reported as failures.

Similar differences arise as a result of varying performance requirements. The inability of an item to meet some specified performance requirement is considered a functional failure. Thus functional failures (and also potential failures) are created or eliminated by differences in the specified limits; even in the same piece of equipment, what is a failure to one organization will not necessarily be a failure to another. These differences exist not only from one organization to another, but within a single organization over a long calendar period. Procedures change, or failure definitions are revised, and any of these changes will result in a change in the reported failure rate.

Another factor that must be taken into account is the difference in orientation between manufacturers and users. On one hand, the operating organization tends to view a failure for any reason as undesirable and expects the manufacturer to improve the product to eliminate all such occurrences. On the other hand, the manufacturer considers it his responsibility to deliver a product capable of performing at the warranted reliability level (if there is one) under the specific stress conditions for which it was designed. If it later develops that the equipment must frequently be operated beyond these conditions, he will not want to assume responsibility for any failures that may have been caused or accelerated by such operation. Thus manufacturers tend to "censor" the failure histories of operating organizations in light of their individual operating practices. The result is that equipment users, with some confusion among them, talk about what they actually saw, while the manufacturer talks about what they should have seen.

2.3 THE CONSEQUENCES OF FAILURE

While failure analysis may have some small intrinsic interest of its own, the reason for our concern with failure is its consequences. These may range from the modest cost of replacing a failed component to the possible destruction of a piece of equipment and the loss of lives. Thus all reliability-centered maintenance, including the need for redesign, is dictated, not by the frequency of a particular failure, but by the nature of its consequences. Any preventive-maintenance program is therefore based on the following precept:

safety consequences
operational consequences
nonoperational consequences
hidden-failure consequences

The consequences of a failure determine the priority of the maintenance activities or design improvement required to prevent its occurrence.

The more complex any piece of equipment is, the more ways there are in which it can fail. All failure consequences, however, can be grouped in the following four categories:

- ▶ Safety consequences, involving possible loss of the equipment and its occupants
- ▶ Operational consequences, which involve an indirect economic loss as well as the direct cost of repair
- ▶ Nonoperational consequences, which involve only the direct cost of repair
- ▶ Hidden-failure consequences, which have no direct impact, but increase the likelihood of a multiple failure

SAFETY CONSEQUENCES

The first consideration in evaluating any failure possibility is safety:

Does the failure cause a loss of function or secondary damage that could have a direct adverse effect on operating safety?

Suppose the failure in question is the separation of a number of turbine blades on an aircraft engine, causing the engine to vibrate heavily and lose much of its thrust. This functional failure could certainly affect the safety of a single-engine aircraft and its occupants, since the loss of thrust will force an immediate landing regardless of the terrain below. Furthermore, if the engine is one whose case cannot contain ejected blades, the blades may be thrown through the engine case and cause unpredictable, and perhaps serious, damage to the

plane itself. There is also danger from hot gases escaping from the torn engine case. In a multiengine plane the loss of thrust would have no direct effect on safety, since the aircraft can maintain altitude and complete its flight with one engine inoperative. Hence the loss of function is not in itself cause for alarm. However, both plane and passengers will still be endangered by the possible secondary damage caused by the ejected blades. In this case, therefore, the secondary effects are sufficient reason to classify the failure as critical.

A *critical failure* is any failure that could have a direct effect on safety. Note, however, that the term *direct* implies certain limitations. The impact of the failure must be immediate if it is to be considered direct; that is, the adverse effect must be one that will be felt before planned completion of the flight. In addition, these consequences must result from a single failure, not from some combination of this failure with one that has not yet occurred. An important fact follows from this:

- ▶ All critical failures will be evident to the operating crew. If a failure has no evident results, it cannot, by definition, have a direct effect on safety.

It may be necessary to remove a plane from service to correct certain failures before continuing operation, and in some cases it may even be advisable to discontinue the flight. However, as long as the failure itself has no immediate safety consequences, the need for these precautionary measures does not justify classifying this failure as critical.

Not every critical failure results in an accident; some such failures, in fact, have occurred fairly often with no serious consequences. However, the issue is not whether such consequences are inevitable, but whether they are possible. For example, the secondary effects associated with ejected turbine blades are unpredictable. Usually they do not injure passengers or damage a vital part of the plane—but they can. Therefore this failure is classified as critical. Similarly, any failure that causes an engine fire is critical. Despite the existence of fire-extinguishing systems, there is no guarantee that a fire can be controlled and extinguished. Safety consequences are always assessed at the most conservative level, and in the absence of proof that a failure *cannot* affect safety, it is classified by default as critical.

In the event of any critical failure, every attempt is made to prevent a recurrence. Often redesign of one or more vulnerable items is necessary. However, the design and manufacture of new parts and their subsequent incorporation in in-service equipment takes months, and sometimes years. Hence some other action is needed in the meantime. In the case of turbine-blade failure an identifiable physical condition—loose blades—has been found to occur well in advance of actual separation of the blades. Thus regular inspection for this condition as part of scheduled maintenance makes it possible to remove engines at the

potential-failure stage, thereby forestalling all critical functional failures. Note that this preventive-maintenance task does not prevent failures; rather, by substituting a potential failure for a functional failure, it precludes the consequences of a functional failure.

OPERATIONAL CONSEQUENCES

Once safety consequences have been ruled out, a second set of consequences must be considered:

Does the failure have a direct adverse effect on operational capability?

Whenever the need to correct a failure disrupts planned operations, the failure has operational consequences. Thus operational consequences include the need to abort an operation after a failure occurs, the delay or cancellation of other operations to make unanticipated repairs, or the need for operating restrictions until repairs can be made. (A critical failure can, of course, be viewed as a special case of a failure with operational consequences.) In this case the consequences are economic: they represent the imputed cost of lost operational capability.

A failure that requires immediate correction does not necessarily have operational consequences. For example, if a failed item on an aircraft can be replaced or repaired during the normal transit time at a line station, then it causes no delay or cancellation of subsequent flights, and the only economic consequence is the cost of corrective maintenance. In contrast, the plane may be operational, but its reduced capability will result in such costs as high fuel consumption. The definition of operational consequences will therefore vary from one operating context to another. In all cases, however, the total cost of an operational failure includes the economic loss resulting from the failure as well as the cost of repairing it. If a failure has no operational consequences, the cost of corrective maintenance is still incurred, but this is the only cost.

If a potential failure such as loose turbine blades were discovered while the plane was in service, the time required to remove this engine and install a new one would involve operational consequences. However, inspections for this potential failure can be performed while the plane is out of service for scheduled maintenance. In this case there is ample time to remove and replace any failed engines (potential failures) without disrupting planned operations.

NONOPERATIONAL CONSEQUENCES

There are many kinds of functional failures that have no direct adverse effect on operational capability. One common example is the failure of a navigation unit in a plane equipped with a highly redundant navigation system. Since other units ensure availability of the required func-

tion, the only consequence in this case is that the failed unit must be replaced at some convenient time. Thus the costs generated by such a failure are limited to the cost of corrective maintenance.

As we have seen, potential failures also fall in this category. The purpose of defining a potential failure that can be used to preempt a functional failure is to reduce the failure consequences in as many cases as possible to the level of direct cost of replacement and repair.

HIDDEN-FAILURE CONSEQUENCES

Another important class of failures that have no immediate consequences consists of failures of hidden-function items. By definition, hidden failures can have no direct adverse effects (if they did, the failure would not be hidden). However, the ultimate consequences can be major if a hidden failure is not detected and corrected. Certain elevator-control systems, for example, are designed with concentric inner and outer shafts so that the failure of one shaft will not result in any loss of elevator control. If the second shaft were to fail after an undetected failure of the first one, the result would be a critical failure. In other words, the consequence of any hidden-function failure is increased exposure to the consequences of a *multiple failure*.

2·4 MULTIPLE FAILURES

probability of a multiple failure
evaluation of multiple-failure
consequences

Failure consequences are often assessed in terms of a sequence of independent events leading to a multiple failure, since several successive failures may result in consequences that no one of the failures would produce individually. The probability of a multiple failure is simple to calculate. Suppose items *A* and *B* in Exhibit 2.1 both have a probability of 0.99 of surviving a given two-hour flight (this would correspond to one failure per 100 flights, which is in fact a very high failure rate). If items *A* and *B* are both functioning at takeoff time, there are only four possible outcomes:

- ▶ Item *A* survives and item *B* survives: $P = 0.99 \times 0.99 = 0.9801$
- ▶ Item *A* survives and item *B* fails: $P = 0.99 \times 0.01 = 0.0099$
- ▶ Item *A* fails and item *B* survives: $P = 0.01 \times 0.99 = 0.0099$
- ▶ Item *A* fails and item *B* fails: $P = 0.01 \times 0.01 = 0.0001$

In other words, the probability that *A* and *B* will both fail during the same flight is only 0.0001, or an average of once in 10,000 flights. If we were considering a multiple failure of three items, the average occurrence, even with the high failure rate we have assumed here, would be once every million flights.

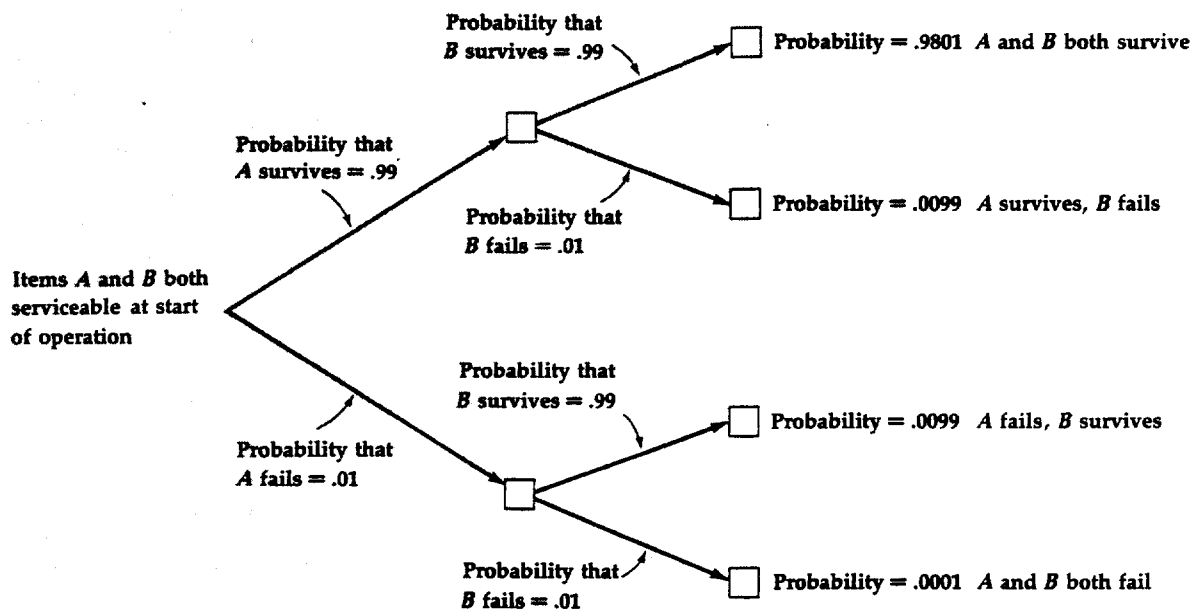

EXHIBIT 2-1 Tree diagram showing the probability of a multiple failure of two items during the same flight when both items are serviceable at takeoff.

Note the difference, however, if item *A* is in a failed state when the flight begins. The probability that *B* will fail is .01; thus the probability of a multiple failure of *A* and *B* depends only on the probability of the second failure— .01, or an average of one occurrence every 100 flights. This becomes a matter of concern if the combination has critical consequences. Because of the increased probability of a multiple failure, hidden-function items are placed in a special category, and all such items that are not subject to other maintenance tasks are scheduled for failure-finding tasks. Although this type of task is intended to discover, rather than to prevent, hidden failures, it can be viewed as preventive maintenance because one of its objectives is to reduce exposure to a possible multiple failure.

To illustrate how the consequences of a multiple failure might be evaluated, consider a sequence of failures all of which are evident. If the first failure has safety consequences, there is no need to assess the consequences of a second failure. This first critical failure is the sole concern, and every effort is made to prevent its occurrence. When the first loss of function is not critical, then the consequences of a second

nature of failure consequences				
first failure	second failure	third failure	fourth failure	effect on previous failures in sequence
Critical				The critical nature of the first failure supersedes the consequences of a possible second failure.
Operational	Critical			A second failure would be critical; the first failure must be corrected before further dispatch and therefore has operational consequences.
Nonoperational	Operational	Critical		A third failure would be critical; the second failure must be corrected before further dispatch, but correction of the first failure can be deferred to a convenient time and location.
Nonoperational	Nonoperational	Operational	Critical	A fourth failure would be critical; the third failure must be corrected before further dispatch, but correction of both the first and second failures can be deferred.

EXHIBIT 2-2 The consequences of a single failure as determined by the consequences of a possible multiple failure. A failure that does not in itself affect operating capability acquires operational consequences if a subsequent multiple failure would be critical.

loss of function must be investigated. If the combined effect of both failures would jeopardize safety, then this multiple failure must be prevented by correcting the first failure as soon as possible. This may entail an unscheduled landing and will at least require taking the equipment out of service until the condition has been repaired. In this case, therefore, the first failure has operational consequences.

Note in Exhibit 2.2 that multiple-failure consequences need be assessed only in terms of two successive failure events. If a third loss of function would be critical, the second failure has operational consequences. However, the first failure in such a sequence can be deferred to a convenient time and place; thus it has no operational consequences. Hidden-function failures are assessed on the same basis. If the first failure under consideration is a hidden one, scheduled maintenance is necessary to protect against a multiple failure. The intensity of this maintenance, however, is dictated by the consequences of the possible multiple failure. If the combination of this failure with a second failure

would be critical, every effort is made to ensure that the hidden function will be available.

What we are doing, in effect, is treating any single failure as the first in a succession of events that could lead to a critical multiple failure. It is this method of assessing failure consequences that permits us to base a maintenance program on the consequences of single failures.

2.5 THE FAILURE PROCESS

FAILURE IN SIMPLE ITEMS

One reason for identifying unsatisfactory conditions at the potential-failure stage is to prevent the more serious consequences of a functional failure. Another reason, however, is that the removal of individual units on the basis of their condition makes it possible to realize most of the useful life of each unit. To see how this procedure works, consider a simple item such as the airplane tire in Exhibit 2.3. Although a tire has other functions, here we are concerned with its retread capability. Hence we have defined a functional failure as the point at which the

failure in simple items
a model of the failure process
the age at failure

EXHIBIT 2.3 Tire tread wear as an illustration of the failure process in a simple item. The potential-failure condition is defined in this case as the tread depth at point A. At point B, when the tire is smooth, it can still be removed as a potential failure, but if wear continues to point C the carcass will no longer be suitable for retreading, and the loss of this function will constitute a functional failure.

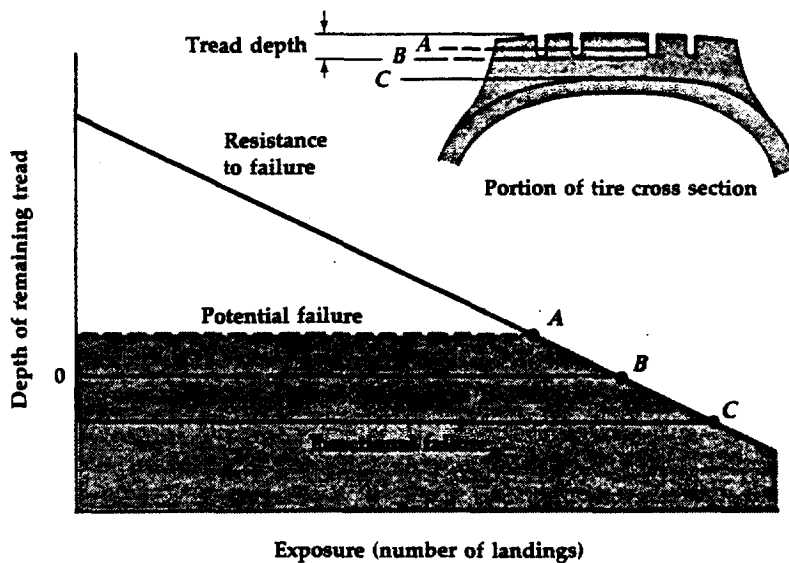

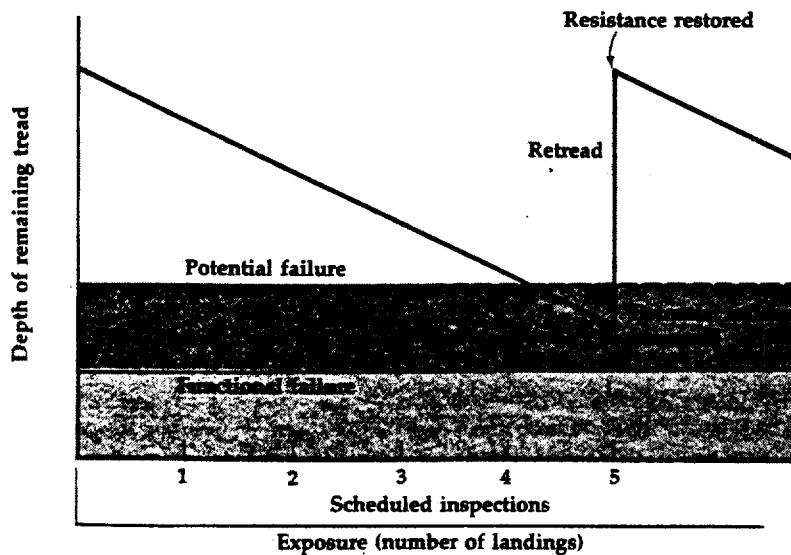

EXHIBIT 2-4 The use of potential failures to prevent functional failures. When tread depth reaches the potential-failure stage, the tire is removed and retreaded (recapped). This process restores the original tread, and hence the original failure resistance, so that the tire never reaches the functional-failure stage.

carcass plies are exposed so that the carcass is no longer suitable for retreading. The remaining tread is thus the tire's *resistance to failure* at any given moment. The *stresses* to which the tire is subjected during each landing reduce this resistance by some predictable amount, and the number of landings is a measure of the total *exposure* to stress. With increasing exposure in service, the failure resistance is gradually reduced until eventually there is a functional failure—visible plies.

Because the reduction in failure resistance is visible and easily measured, it is usual maintenance practice to define a potential failure as some wear level just short of this failure point. The tires are inspected periodically, usually when the aircraft is out of service, and any tire worn beyond the specified level is replaced. To allow for periodic inspections, the condition we choose as the potential-failure stage must not be too close to the functional-failure condition; that is, there must be a reasonable interval in which to detect the potential failure and take action. Conversely, setting the potential-failure limit too high would mean replacing tires that still had substantial useful life.

Once the optimum potential-failure level has been defined, inspections can be scheduled at intervals based on the expected amount of

tread wear over a given number of landings. Exhibit 2.4 shows a smooth tread noticed at inspection 5. At this point the tire is replaced, and if its carcass is sound, it will be retreaded. Retreading restores the original tread, and hence the original resistance to failure, and a new service cycle begins.

Failure resistance, as we are using the concept here, is somewhat analogous to the structural engineering practice of determining the stresses imposed by an applied load and then adding a safety factor to determine the design strength of a structural member. The difference between the applied load and the design strength is then the resistance to failure. The same principle extends to servicing and lubrication requirements, for example, where a specified oil quantity or lubrication film represents a resistance to functional failure. Similarly, loose turbine blades are taken as a marked reduction in failure resistance. There is a subtle difference, however, between this latter situation and the tire example. In the case of the tire the decline in failure resistance is visible and the approximate unit of stress (average tread wear per landing) is known. In the case of turbine blades the unit of stress is unknown and the decline in failure resistance is not apparent until the resistance has become quite low.

A MODEL OF THE FAILURE PROCESS

So far we have discussed a reduction in failure resistance that is evidenced by some visible condition. The more general failure process involves a direct interaction between stress and resistance, as shown in Exhibit 2.5. The measure of exposure may be calendar time, total operating hours, or number of flight or landing cycles, depending on the item. Because the measurable events occur over time, it is common to refer to total exposure as the *age* of an item. Possible measures for the stress scale are even more varied. Stresses may include temperature and atmospheric conditions, vibration, abrasion, peak loads, or some combination of these factors. It is often impossible to separate all the stress factors that may affect an item; hence exposure to stress is usually generalized to include all the stresses to which the item is subjected in a given operating context.

The primary age measure for most aircraft equipment is operating hours, usually "off-to-on" (takeoff to landing) flying hours. Some failure modes, however, are related to the number of ground-air-ground stress cycles, and in these cases age is measured as number of landings or flight cycles. Flight cycles are important, for example, in determining the number of stress cycles experienced by the aircraft structure and landing gear during landing. They are also of concern for powerplants. Engines undergo much more stress during takeoff and climb than during cruise, and an engine that experiences more takeoffs in the same number of operating hours will deteriorate more rapidly.

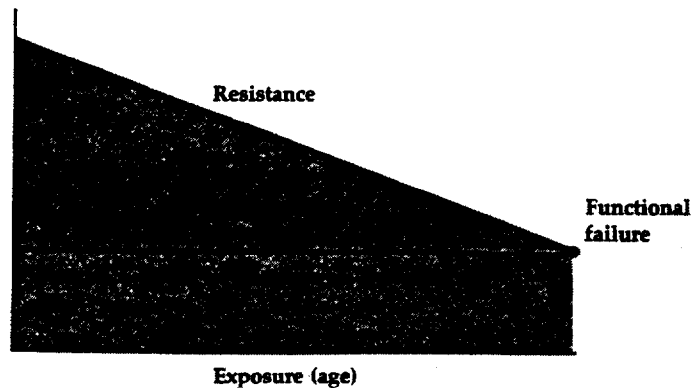

EXHIBIT 2-5 Generalized model of the failure process. Resistance to failure is assumed to decline steadily with exposure to stress, measured over time as operating age, flight cycles, and so on. A functional failure occurs when the amount of stress exceeds the remaining failure resistance. In reality both stress and resistance can fluctuate, so that there is no way to predict the exact age at which the failure point will be reached.

For this reason all aircraft equipment is monitored in terms of both operating hours and flight cycles, usually on the basis of total flying time and total flight cycles for the entire aircraft. Thus if an engine is installed in a plane that has accumulated 1,000 operating hours and is removed at 1,543 hours, the engine has aged 543 hours since installation. If that engine was 300 hours old when it was installed, its age at removal is 843 hours.

Some military aircraft are equipped with acceleration recorders which also monitor the number of times the structure is stressed beyond a certain number of *G*'s during operation. The loads can be counted and converted to an equivalent number of flight hours at the plane's designed operating profile. Like operating hours or flight cycles, these "spectrum hours" provide a basis for estimating the reduction in resistance to a particular failure mode.

A functional failure occurs when the stress and resistance curves intersect—that is, when the stress exceeds the remaining resistance to failure. Either of these curves may take a variety of different shapes, and the point at which they intersect will vary accordingly (see Exhibit 2.6). Until they do intersect, however, no functional failure occurs. In practice this failure model can be applied only to *simple items*—those subject to only one or a very few failure modes—and to individual failure modes in complex items. The reason for such a limitation be-

comes apparent if we consider some of the variables in just a single failure mode.

THE AGE AT FAILURE

Our examples thus far imply that any given component, such as a tire, has a well-defined initial resistance to failure and that the rate of decline in this resistance is more or less known and predictable. It follows that the time of failure should be predictable. In reality, however, even nominally identical parts will vary both in their initial failure resistance and in the rate at which this resistance declines with age. Suppose we have two nominally identical units of a simple item, or perhaps two identical parts in a complex item. To simplify matters further, let us say they are exposed to only one type of stress and are subject to only one type of failure. On this basis we might expect their failure resistance to decline at the same rate and therefore expect both units to fail at approx-

EXHIBIT 2-6 Variability of stress, failure resistance, and the age at failure. In example *A* the resistance remains constant over time, but a sudden peak in stress causes failure to occur. In *B* the stress and resistance curves do not intersect, but the peak in stress has permanently lowered the remaining failure resistance. In *C* the reduction in failure resistance caused by the peak stress is temporary. In *D* the peak stress has accelerated the rate at which the remaining resistance will decline with age.

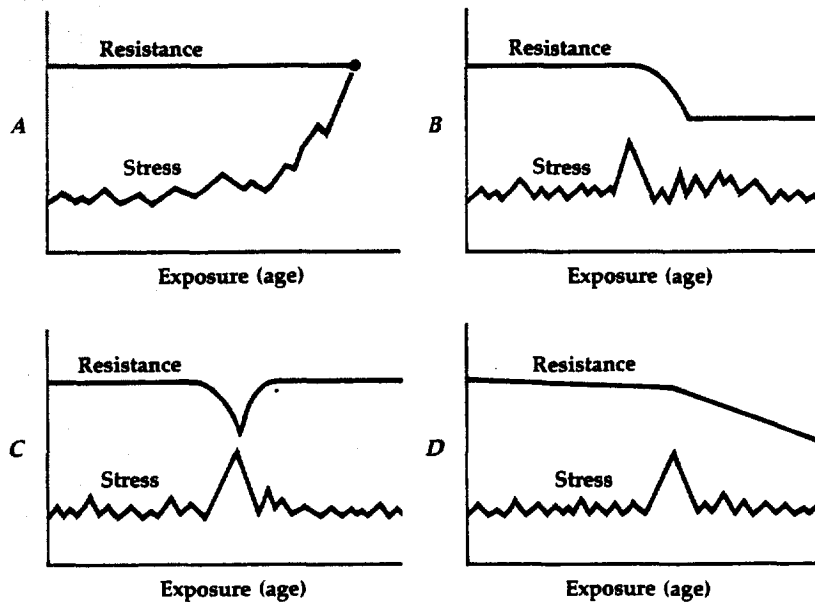

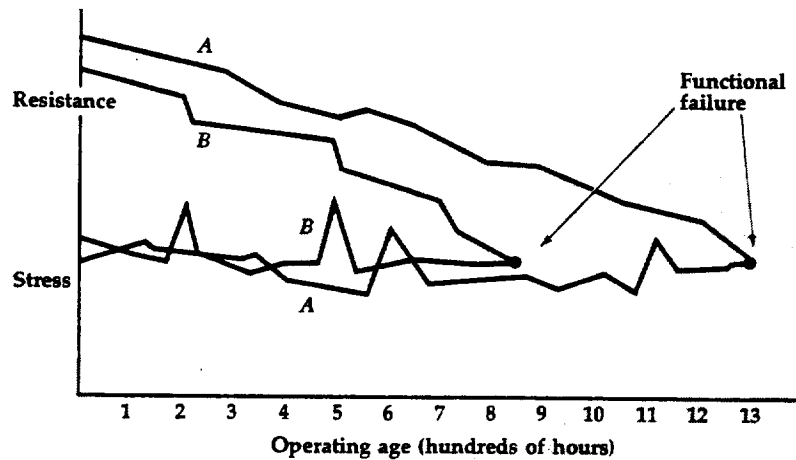

EXHIBIT 2·7 The difference in failure age of two nominally identical parts subjected to similar stress patterns. The two units begin their service lives with comparable initial resistance to failure, but unit *B* is exposed to greater stress peaks and reacts to them consistently. Unit *A* behaves less accountably; its resistance is unaffected by stress peaks at 600 and 1,120 hours but declines rapidly between 1,200 and 1,300 hours. As a result, one unit fails at 850 hours and the other at 1,300 hours.

imately the same age. However, all manufactured components are produced to specified tolerance limits, which results in a variation in initial resistance. These variations are insignificant from a performance standpoint, but the result is that the two units will begin their service lives with slightly different capacities to resist stress, and these capacities may decline at somewhat different rates.

Stress also varies from moment to moment during operation, sometimes quite abruptly. For example, the different loads exerted on an aircraft structure by atmospheric turbulence can vary markedly even in the course of a short flight. Moreover, the effect of these stresses will be further influenced by the condition of the item at the particular moment it is stressed. As a result, each component will encounter a different stress pattern even if both are operating as part of the same system. Although the variations in either stress or resistance may be slight, their interaction can make a substantial difference in the length of time a given component will operate before failing. Units *A* and *B* in Exhibit 2.7 are relatively alike in their initial resistance, and the stress placed on each does not vary much from the constant stress assumed in the generalized model. However, the time of failure is the point at which the stress and resistance curves intersect; thus unit *B* failed at an age of 850 hours, whereas unit *A* survived until 1,300 hours.

Despite the variation in the failure ages of individual units, if a large number of nominally identical units are considered, their failures will tend to concentrate about some average age. For purposes of reliability analysis, however, it is necessary to employ statistical techniques that describe the variation about this average age.

It is also important to recognize that the actual age at failure depends on the stress the unit experiences. The wing-to-fuselage joints of an aircraft will stand up to normal air turbulence for a very long time, but perhaps not to the loads encountered during a tornado. The fan blades of a turbine engine can withstand thousands of hours of normal stress, but they may not be able to tolerate the ingestion of a single goose. In nearly all cases random stress peaks markedly above the average level will lower the failure resistance. This reduction may be permanent, as when damage to several structural members lowers the failure resistance of a wing, or resistance may be affected only at the time the stress exceeds a certain level. In some cases resistance may change with each variation in stress, as with metal fatigue. From the standpoint of preventive maintenance, however, the important factor is not a prediction of *when* an item is likely to fail, but whether or not the reduction in failure resistance can be identified by some physical evidence that permits us to recognize an imminent failure.

Many functional failures are evident at the time they occur, and in these cases the exact age at failure is known. Unless a failure is evident to the operating crew, however, it is impossible to determine precisely when it occurred. A potential failure detected by mechanics is known only to have occurred some time between the last inspection and the inspection at which it is observed. Similarly, although there is some exact age at which a hidden function fails, the only age we can pinpoint is the time at which the failure is discovered. For this reason the *age at failure* is defined, by convention, as the age at which a failure is observed and reported.

2.6 FAILURE IN COMPLEX ITEMS

A *complex item* is one that is subject to many different failure modes. As a result, the failure processes may involve a dozen different stress and resistance considerations, and a correspondingly tangled graphic representation. However, each of these considerations pertains to a single *failure mode*—some particular type or manner of failure. For instance, a bearing in a generator may wear; this causes the unit to vibrate, and ultimately the bearing will seize. At this point the generator will suffer a functional failure, since it can no longer rotate and produce electric power. Generators can also fail for other reasons, but the failure mode in this case is bearing seizure.

Of course, the bearing itself is also subject to more than one failure

failure modes
dominant failure modes
failure age of a complex item

mode. It may wear as a result of abrasion or crack as a result of excessive heat. From the standpoint of the generator both conditions lead to the same failure, bearing seizure. However, the maintenance analyst must know the physical circumstances leading to a particular failure in order to define an identifiable potential-failure condition. The manufacturer also needs to know that the bearing is prone to failure and that a modification is needed to improve the reliability of the generator. Such a design modification is obviously desirable if one particular failure mode is responsible for a significant proportion of all the failures of the item. Such failure modes are called *dominant failure modes*.

As with failures in simple items, the failure ages for a single failure mode tend to concentrate about an average age for that mode. However,

EXHIBIT 2-8 Experience with 50 newly installed Pratt & Whitney JT8D-7 engines over the first 2,000 operating hours. The 21 units that failed before 2,000 hours flew a total of 18,076 hours, so the total operating time for all 50 engines was 18,076 hours plus 58,000 hours for the surviving engines, or 76,076 hours. The mean time between failures was therefore $76,076/21$, or 3,622 hours. The average age of the failed engines, however, was only 861 hours. (United Airlines)

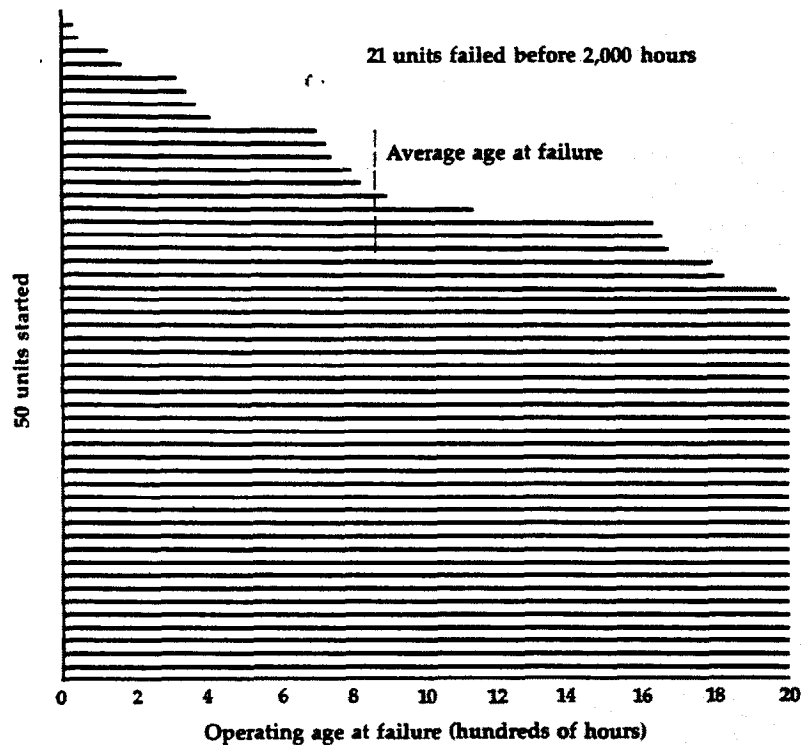

the average ages for all the different modes will be distributed along the exposure axis. Consequently, unless there is a dominant failure mode, the overall failure ages in complex items are usually widely dispersed and are unrelated to a specific operating age. This is a unique characteristic of complex items. A typical example is illustrated in Exhibit 2.8. In a sample of 50 newly installed Pratt & Whitney JT8D-7 engines, 29 survived beyond 2,000 operating hours. The disparate failure ages of the 21 units that failed, however, do not show any concentration about the average failure age of 861 hours.

Nevertheless, even in complex items, no matter how numerous the failure modes may be, the basic failure process reduces to the same factor—the interaction between stress and resistance to failure. Whether failures involve reduced resistance, random stress peaks, or any combination of the two, it is this interaction that brings an item to the failure point. This aspect of the failure process was summed up in a 1960 United Airlines report:*

The airplane as a whole, its basic structure, its systems, and the various items in it are operated in an environment which causes stresses to be imposed upon them. The magnitudes, the durations and the frequencies with which specific stresses are imposed are all very variable. In many cases, the real spectrum of environmentally produced stresses is not known. The ability to withstand stress is also variable. It differs from piece to piece of new nominally identical equipment due to material differences, variations in the manufacturing processes, etc. The ability to withstand stress may also vary with the age of a piece of equipment.

It is implied that an instance of environmental stress that exceeds the failure resistance of an item at a particular time constitutes failure of that item at that time.

2·7 QUANTITATIVE DESCRIPTIONS OF FAILURE

Any unanticipated critical failure prompts an immediate response to prevent repetitions. In other cases, however, it is necessary to know how frequently an item is likely to fail in order to plan for reliable operation. There are several common reliability indexes based on the failure history of an item. Methods for deriving certain of these measures

failure rate
mean time between failures
probability of survival
probability density of failure
conditional probability
of failure

*F. S. Nowlan, A Comparison of the Potential Effectiveness of Numerical Regulatory Codes in the Fields of Overhaul Periodicity, Airplane Strength, and Airplane Performance, United Airlines Report POA-32, April 14, 1960. These remarks paraphrase a report prepared by D. J. Davis of the Rand Corporation in 1950, which offered intensive analysis of failure data. For an excellent detailed discussion of the physical processes present in the failure mechanism, see Robert P. Haviland, *Reliability and Long Life Design*. Van Nostrand Company, Inc., New York, 1964.

are discussed in detail in Appendix C, but it is helpful at this point to know what each measure actually represents.

FAILURE RATE

The failure rate is the total number of failures divided by some measure of operational exposure. In most cases the failure rate is expressed as failures per 1,000 operating hours. Thus if six failures have occurred over a period of 9,000 hours, the failure rate is ordinarily expressed as 0.667. Because measures other than operating hours are also used (flight cycles, calendar time, etc.), it is important to know the units of measure in comparing failure-rate data.

The failure rate is an especially valuable index for new equipment, since it shows whether the failure experience of an item is representative of the state of the art. It is also useful in assessing the economic desirability of product improvement. Early product-improvement decisions are based on the performance of units that have been exposed to fairly short individual periods of time in service, and this performance is adequately measured by the failure rate.

MEAN TIME BETWEEN FAILURES

The mean time between failures, another widely used reliability index, is the reciprocal of the failure rate. Thus with six failures in 9,000 operating hours, the mean time between failures would be $9,000/6$, or 1,500 hours. This measure has the same uses as the failure rate. Note that the mean time between failures is not necessarily the same as the average age at failure. In Exhibit 2.8, for example, the average age of the failed engines was 861 hours, whereas the mean time between failures was 3,622 hours.*

PROBABILITY OF SURVIVAL

With more extended operating experience it becomes possible to determine the *age-reliability characteristics* of the item under study—the relationship between its operating age and its probability of failure. At this stage we can plot a survival curve, showing the probability of survival without failure as a function of operating age. This curve relates directly to the generally accepted definition of reliability:

Reliability is the probability that an item will survive to a specified operating age, under specified operating conditions, without failure.

For this reason the survival curve is commonly referred to as the *reliability function*.

*For a further discussion of this distinction, see Appendix C.

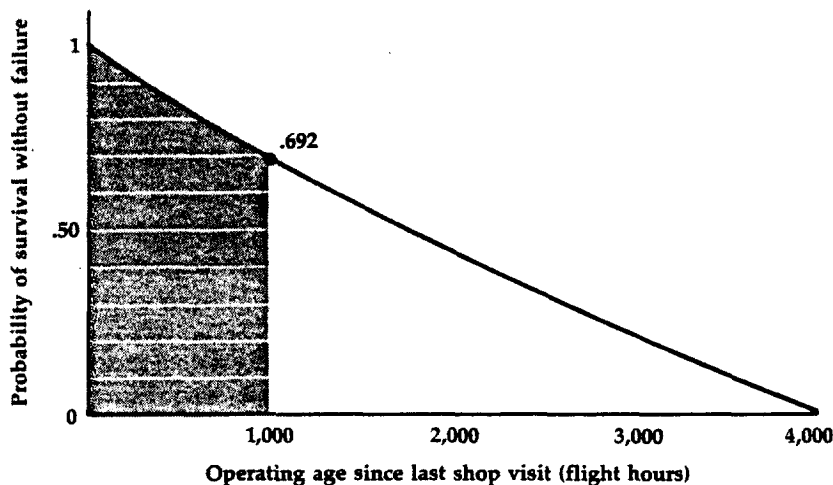

EXHIBIT 2-9 Survival curve for the Pratt & Whitney JT8D-7 engine of the Boeing 737, based on 58,432 total operating hours from May 1 to July 31, 1974. The average life is computed by partitioning along the vertical axis to form small incremental areas whose sum approximates the area under the curve. With an age limit of 1,000 hours, only the shaded area enters into this computation, since no engines can contribute to the survival curve beyond this limit, despite the fact that they would have survived had they been left in service. (United Airlines)

Exhibit 2.9 shows a typical survival curve for an aircraft turbine engine. The curve represents the percentage of installed engines that survived to the time shown on the horizontal axis, and this is usually our best estimate of the probability that any individual engine will survive to that time without failure.

A survival curve is more useful than a simple statement of the failure rate, since it can be used to predict the percentage of units that will survive to some given age. If the engines in Exhibit 2.9 were scheduled for removal at 1,000 hours, for example, 69 percent of them would survive to that age limit, whereas 31 percent could be expected to fail before then. The area under the survival curve can also be used to measure the average life of the item under consideration. If the probability scale is divided into small increments, each of which is projected to intersect the curve, the contribution of each of these incremental areas can be calculated and added to determine the average life. Thus, the triangle at the top is the contribution of the first 10 percent of the units that

fail (90 percent survive beyond this age):

$$[(\text{age at } P = 1) + (\text{age at } P = .90)] \times \frac{.10}{2}$$

The next incremental area represents the contribution to the average life of the next 10 percent of the units that fail:

$$[(\text{age at } P = .90) + (\text{age at } P = .80)] \times \frac{.10}{2}$$

and so on. Completion of this computation for the entire area under the curve would show that, with no age limit, the average life expected for each engine in service would be 1,811 hours.

Note, however, that an age limit of 1,000 hours removes all the surviving units from service at that age. In this case, therefore, the area under the curve represents only the area up to that age limit. The probability of survival to 1,000 hours is .692, so the contribution of any surviving unit to the average life is only 1,000 hours \times .692 = 692 hours. This contribution, added to the incremental contributions above it for the units that failed, yields an average realized life of 838 hours for failed and unfailed engines. Any engines that would have survived to ages higher than 1,000 hours, and thus have added to the average life, do not count. The average lives that would be realized with other age limits in this case are as follows:

<i>age limit</i>	<i>average realized life</i>
1,000 hours	838 hours
2,000 hours	1,393 hours
3,000 hours	1,685 hours
No limit	1,811 hours

PROBABILITY DENSITY OF FAILURE

The probability that an engine in Exhibit 2.9 will survive to 1,000 hours is .692, and the probability that it will survive to 1,200 hours is .639. The difference between these probabilities, .053, is the probability of a failure during this 200-hour interval. In other words, an average of 5.3 out of every 100 engines that enter service can be expected to fail during this particular interval. Similarly, an average of 5.0 engines can be expected to fail during the interval from 1,200 to 1,400 hours. This measure is called the *probability density of failure*.

Exhibit 2.10 shows the probability densities for each 200-hour age interval, plotted from the probabilities of survival at each age. A decreasing percentage of the engines will fail in each successive age interval because a decreasing percentage of engines survives to enter that interval.

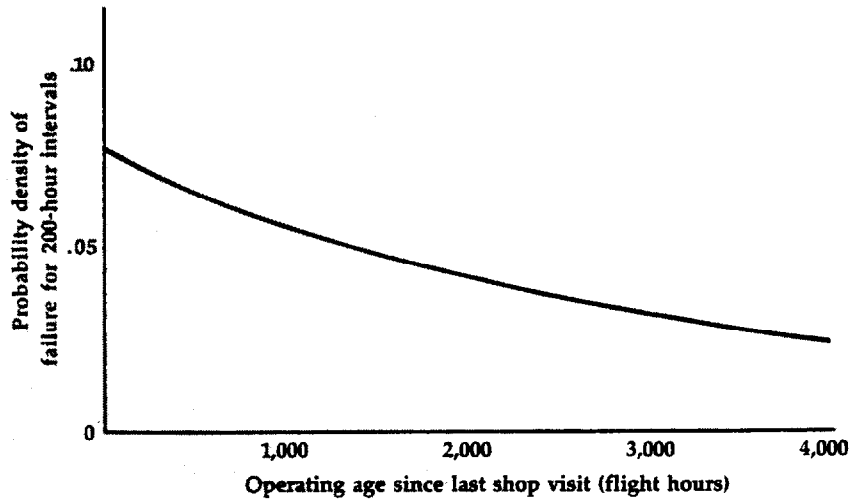

EXHIBIT 2-10 Probability density of failure for the Pratt & Whitney JT8D-7 engine of the Boeing 737. Density values are plotted at the midpoint of each 200-hour interval and represent the probability that a failure will occur during this interval. (United Airlines)

CONDITIONAL PROBABILITY OF FAILURE

The most useful measure of the age-reliability relationship is the probability that an item entering a given age interval will fail during that interval. This measure is usually called the *conditional probability of failure*—the probability of failure, given the condition that the item enters that age interval. Sometimes it is also referred to as the hazard rate or the local failure rate.* The conditional probability is related to both the probability of survival and the probability density. For example, an engine beginning at zero time has a probability of .692 of reaching the age of 1,000 hours; once it has reached this age, the probability density of failure in the next 200-hour interval is .053. Each engine that survives to 1,000 hours therefore has a conditional probability of failure between 1,000 and 1,200 hours of $.053/.692$, or .077. The complete conditional-probability curve for this engine is shown in Exhibit 2.11.

If the conditional probability of failure increases with age, we say that the item shows *wearout characteristics* and immediately wonder if an age limit would be effective in reducing the overall failure rate. (Note

*In some literature these terms are defined in a narrower sense to mean the value obtained by computing the limit of the ratio as the age interval goes to zero.

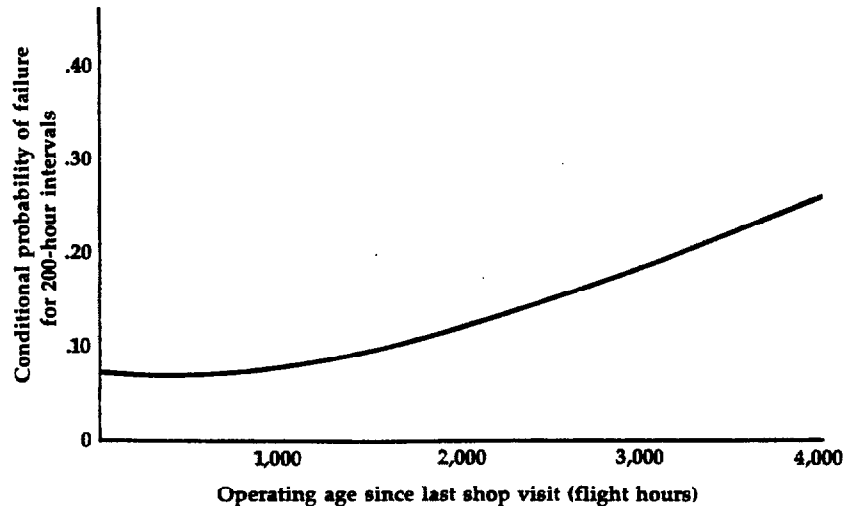

EXHIBIT 2.11 Conditional probability of failure for the Pratt & Whitney JT8D-7 engine of the Boeing 737. Probability values are plotted at the midpoint of each 200-hour interval and represent the average probability that an engine that survives to enter the interval will fail during this interval. (United Airlines)

that the term *wearout* in this context describes the adverse effect of age on reliability; it does not necessarily imply any evident physical change in individual units.) With an age limit of 1,000 hours the average realized life of the engine in question is 838 hours. The probability that an engine will survive to this age is .692, so the failure rate with this limit would be the probability of failure (.308) divided by the average life, or a rate of 0.37 failures per 1,000 hours.

Exhibit 2.12 shows this failure rate plotted as a function of various age limits. If the age limit is raised from 1,000 hours to 2,000 hours, the overall failure rate is 0.42, an increase of only 13.5 percent due to the second thousand hours of operation. However, the conditional probability of failure in the 200-hour interval just before each of these age limits goes up from .075 to .114, an increase of 52 percent. The *rate of increase* in the failure rate falls off with age because it depends on the conditional probability for each interval weighted by the probability of survival to that interval—and there is a continual reduction in the survival probability.

What this means is that the effectiveness of an age limit in controlling failure rates depends not only on large increases in conditional probability at higher ages, but also on a high probability of survival to

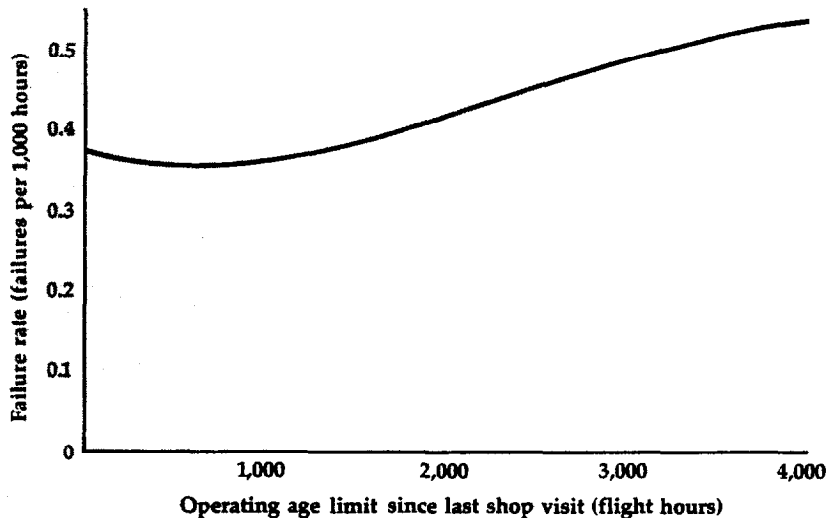

EXHIBIT 2-12 Relationship between the failure rate and various age limits for the Pratt & Whitney JT8D-7 engine of the Boeing 737. (United Airlines)

those ages. It follows that the desirability of an age limit on any item cannot be investigated until there are sufficient operating data to construct survival and conditional-probability curves.

2-8 AGE-RELIABILITY CHARACTERISTICS

At one time it was believed that all equipment would show wearout characteristics, and during the years when equipment overhaul times were being rapidly extended, United Airlines developed numerous conditional-probability curves for aircraft components to ensure that the higher overhaul times were not reducing overall reliability. It was found that the conditional-probability curves fell into the six basic patterns shown in Exhibit 2.13. Pattern *A* is often referred to in reliability literature as the *bathtub curve*. This type of curve has three identifiable regions:

the bathtub curve
age-reliability relationships
of complex items
the "life" of a complex item

- ▶ An *infant-mortality region*, the period immediately after manufacture or overhaul in which there is a relatively high probability of failure

EXHIBIT 2-13 Age-reliability patterns. In each case the vertical axis represents the conditional probability of failure and the horizontal axis represents operating age since manufacture, overhaul, or repair. These six curves are derived from reliability analyses conducted over a number of years, during which all the items analyzed were found to be characterized by one or another of the age-reliability relationships shown. The percentages indicate the percentage of items studied that fell into each of the basic patterns (United Airlines)

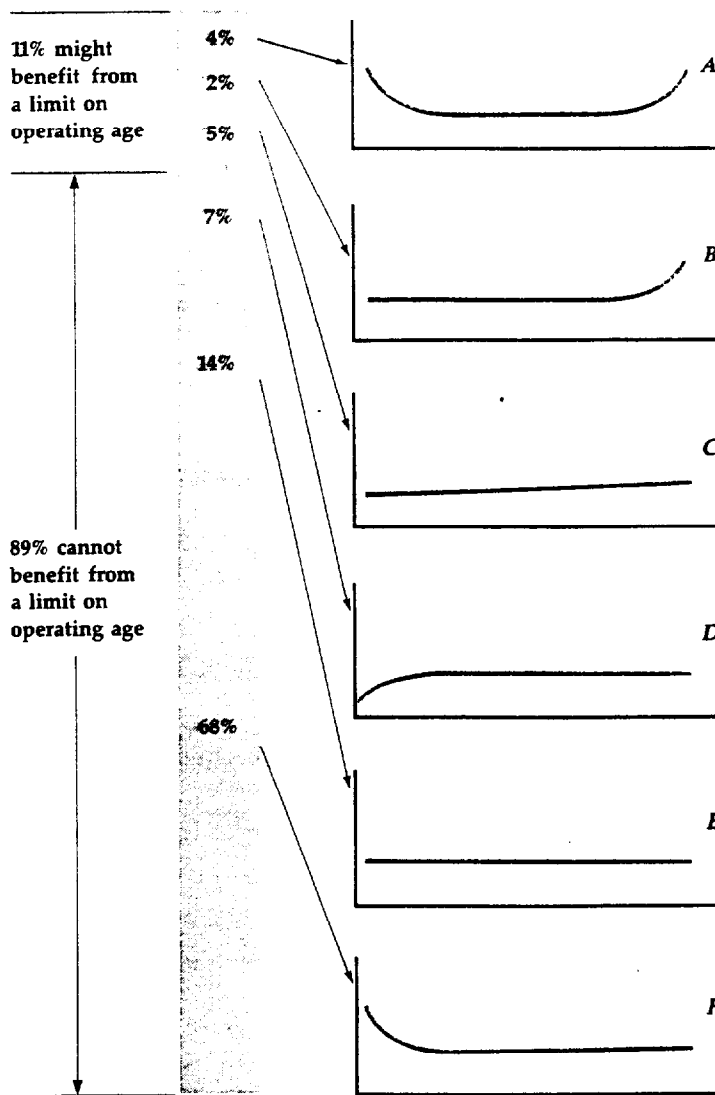

The bathtub curve: infant mortality, followed first by a constant or gradually increasing failure probability and then by a pronounced "wearout" region. An age limit may be desirable, provided a large number of units survive to the age at which wearout begins.

Constant or gradually increasing failure probability, followed by a pronounced wearout region. Once again, an age limit may be desirable (this curve is characteristic of aircraft reciprocating engines).

Gradually increasing failure probability, but with no identifiable wearout age. It is usually not desirable to impose an age limit in such cases (this curve is characteristic of aircraft turbine engines).

Low failure probability when the item is new or just out of the shop, followed by a quick increase to a constant level.

Constant probability of failure at all ages (exponential survival distribution).

Infant mortality, followed by a constant or very slowly increasing failure probability (particularly applicable to electronic equipment).

- ▶ A region of constant and relatively low failure probability
- ▶ A *wearout region*, in which the probability of failure begins to increase rapidly with age

If the failure pattern of an item does in fact fit this curve, we are justified in concluding that the overall failure rate will be reduced if some action is taken just before this item enters the wearout zone. In these cases allowing the item to age well into the wearout region would cause an appreciable increase in the failure rate. Note, however, that such action will not have much effect on the overall rate unless there is a high probability that the item will survive to the age at which wearout appears.

The presence of a well-defined wearout region is far from universal; indeed, of the six curves in Exhibit 2.13, only *A* and *B* show wearout characteristics. It happens, however, that these two curves are associated with a great many single-celled or simple items—in the case of aircraft, such items as tires, reciprocating-engine cylinders, brake pads, turbine-engine compressor blades, and all parts of the airplane structure.

The relative frequency of each type of conditional-probability curve proved especially interesting. Some 89 percent of the items analyzed had no wearout zone; therefore their performance could not be improved by the imposition of an age limit. In fact, after a certain age the conditional probability of failure continued on at a constant rate (curves *D*, *E*, and *F*). Another 5 percent had no well-defined wearout zone (curve *C*) but did become steadily more likely to fail as age increased. For a very few of these items an age limit might prove useful, provided that it was cost-effective.

Only 6 percent of the items studied showed pronounced wearout characteristics (curves *A* and *B*). Although an age limit would be applicable to these items, as we have seen, its effectiveness depends on a high probability that the item will survive to that age. However, the conditional-probability curves make it possible to identify those items that might benefit from such a limit, and the question of effectiveness can then be investigated. Although it is often assumed that the bathtub curve is representative of most items, note that just 4 percent of the items fell into this pattern (curve *A*). Moreover, most complex items had conditional-probability curves represented by curves *C* to *F*—that is, they showed no concentration of failures directly related to operating age.

The basic difference between the failure patterns of complex and simple items has important implications for maintenance. Usually the conditional-probability curve for a complex item will show some infant mortality; often the probability of failure right after installation is fairly

high. Usually, also, the conditional-probability curve shows no marked point of increase with increasing age; the failure probability may increase gradually or remain constant, but there is no age that can be identified as the beginning of a wearout zone. For this reason, unless there is a dominant failure mode, an age limit does little or nothing to improve the overall reliability of a complex item. In fact, in many cases scheduled overhaul actually *increases* the overall failure rate by introducing a high infant-mortality rate in an otherwise stable system.

In contrast, single-celled and simple items frequently do show a direct relationship between reliability and increasing age. This is particularly true of parts subject to metal fatigue or mechanical wear and items designed as consumables. In this case an age limit based on some maximum operating age or number of stress cycles may be highly effective in improving the overall reliability of a complex item. Such limits in fact play a major role in controlling critical-failure modes, since they can be imposed on the part or component in which a given type of failure originates.

It is apparent from our discussion thus far that most statements about the "life" of equipment tell us little about its age-reliability characteristics. For example, the statement that an aircraft engine has a life of 2,000 operating hours might mean any of the following:

- ▶ No engines fail before reaching 2,000 hours.
- ▶ No critical engine failures occur before 2,000 hours.
- ▶ Half the engines fail before 2,000 hours.
- ▶ The average age of failed engines is 2,000 hours.
- ▶ The conditional probability of failure is constant below 2,000 hours.
- ▶ Some part in the engine has a life limit of 2,000 hours.

The definition of reliability is the probability that an item will survive a given operating period, under specified operating conditions, without failure. In discussions of reliability, therefore, it is insufficient to state an operating period alone as the "life" of an item. This statement has no meaning unless a *probability of survival* is associated with it.

It should also be apparent by now why the failure rate plays a relatively unimportant role in maintenance programs: it is too simple a measure. Although the frequency of failures is useful in making cost decisions and in establishing appropriate intervals for maintenance tasks, it tells us nothing about what tasks are appropriate or the consequences that dictate their objective. The effectiveness of a particular maintenance solution can be evaluated only in terms of the safety or economic consequences it is intended to prevent. By the same token, a

maintenance task must be applicable to the item in question in order to have any effect at all. Hence we must now consider the possible forms of preventive maintenance and see how an understanding of the failure process and the age-reliability characteristics of an item permit us to generate maintenance tasks on the basis of explicit criteria.

the four basic maintenance tasks

RCM PROGRAMS consist of specific tasks selected on the basis of the actual reliability characteristics of the equipment they are designed to protect. All these tasks can be described in terms of four basic forms of preventive maintenance, each of which is applicable under a unique set of circumstances:

- ▶ Scheduled inspection of an item at regular intervals to find any potential failures
- ▶ Scheduled rework of an item at or before some specified age limit
- ▶ Scheduled discard of an item (or one of its parts) at or before some specified life limit
- ▶ Scheduled inspection of a hidden-function item to find any functional failures

The first three types of tasks are directed at preventing single failures and the fourth at preventing multiple failures. Inspection tasks can usually be performed without removing the item from its installed position, whereas rework and discard tasks generally require that the item be removed from the equipment and sent to a major maintenance base.

The development of a scheduled-maintenance program consists of determining which of these four tasks, if any, are both applicable and effective for a given item. *Applicability* depends on the failure characteristics of the item. Thus an inspection for potential failures can be applicable only if the item has characteristics that make it possible to define a potential-failure condition. Similarly, an age-limit task will be applicable only if the failures at which the task is directed are related to age. *Effectiveness* is a measure of the results of the task; the task objec-

tive, however, depends on the failure consequences involved. A proposed task might appear useful if it promises to reduce the overall failure rate, but it could not be considered effective if the purpose in applying it was to avoid functional failures altogether.

For inspection tasks the distinction between applicability and effectiveness is usually obvious: the item either does or does not have characteristics that make such a task applicable. For age-limit tasks, however, the distinction is sometimes blurred by the intuitive belief that the task is always applicable and therefore must also be effective. In reality imposing an age limit on an item does not in itself guarantee that its failure rate will be reduced. The issue in this case is not whether the task can be done, but whether doing it will in fact improve reliability.

3·1 SCHEDULED ON-CONDITION TASKS

Scheduled inspections to detect potential failures are commonly termed *on-condition tasks*, since they call for the removal or repair of individual units of an item "on the condition" that they do not meet the required standard. Such tasks are directed at specific failure modes and are based on the feasibility of defining some identifiable physical evidence of a reduced resistance to the type of failure in question. Each unit is inspected at regular intervals and remains in service until its failure resistance falls below a defined level—that is, until a potential failure is discovered. Since on-condition tasks discriminate between units that require corrective maintenance to forestall a functional failure and those units that will probably survive to the next inspection, they permit all units of the item to realize most of their useful lives.

detection of potential failures
applicability criteria
effectiveness criteria
inspection intervals

This type of task is applicable to tires, brakes, many parts of an aircraft powerplant, and much of its structure. Many routine servicing tasks, such as checking oil quantity and tire pressure, are on-condition tasks. The applicability of an on-condition task depends to some extent on both maintenance technology and the design of the equipment. For example, borescope and radioisotope techniques have been developed for inspecting turbine engines, but these techniques are of value chiefly because the engines have been designed to facilitate their use.

If on-condition tasks were universally applicable, all failure possibilities could be dealt with in this way. Unfortunately there are many types of failures in which the failure mode is not clearly understood or is unpredictable or gives insufficient warning for preventive measures to be effective. There are three criteria that must be met for an on-condition task to be applicable:

- ▶ It must be possible to detect reduced failure resistance for a specific failure mode.
- ▶ It must be possible to define a potential-failure condition that can be detected by an explicit task.
- ▶ There must be a reasonably consistent age interval between the time of potential failure and the time of functional failure.

As an example, suppose a visible crack is used as a measure of metal fatigue, as shown in Exhibit 3.1. Such an item is most failure resistant when it is new (point *A*). The resistance drops steadily with increasing age and is already somewhat reduced by the time a crack appears (point *B*). Thereafter it is possible to monitor the growth of the crack and define a potential-failure point *C* far enough in advance to permit removal of the item before a functional failure occurs (point *D*). Once a crack has appeared, the failure resistance drops more rapidly; hence the rate of crack growth in this item must be known in order to establish an inspection interval ΔT that will effectively control this failure mode.

The data for the entire population of this item would define a range of failure ages rather than one specific age. Hence both the defined potential failure and the frequency of inspections depend on the objective of the task. If a functional failure would have safety consequences, then the objective is to prevent all such failures. In this case an on-condition task may be applicable, but it would be considered effective only if it minimized the likelihood of a critical failure. If the failure does not involve safety, then effectiveness is measured in economic terms — that is, the task is effective only if it is *cost-effective*. In the case of operational consequences this means that the cost of finding and correcting potential failures must be less than the combined cost of the operational consequences plus the cost of repairing the failed units. It follows from

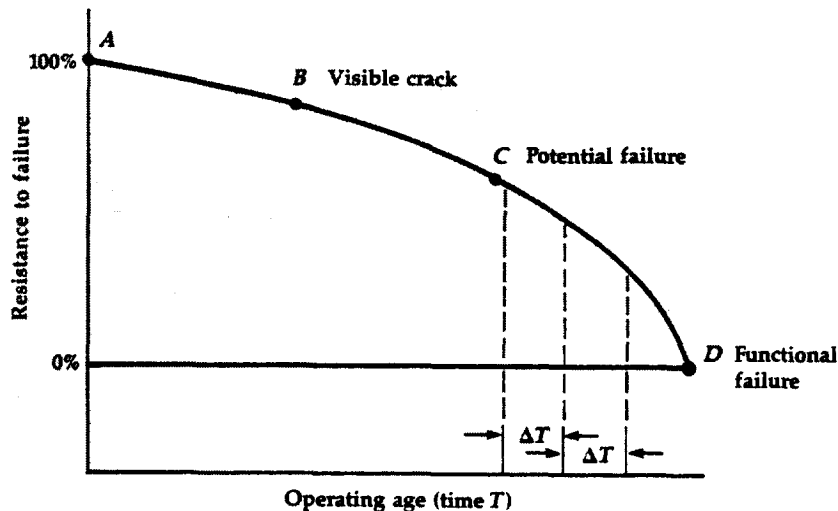

EXHIBIT 3-1 Determining the interval for on-condition inspection of an item subject to metal fatigue. Once the rate of decline in failure resistance has been determined, an inspection interval ΔT is established that provides ample opportunity to detect a potential failure before a functional failure can occur.

this that when an on-condition task is effective in reducing the failure rate, and hence the frequency of operational consequences, it is usually also cost-effective, since the cost of inspection is relatively low.

Exhibit 3.2 shows some typical on-condition tasks for an aircraft. The first example concerns a specific failure mode of an aircraft engine that has a set of 24 tie bolts between the fourth and fifth stages of its turbine to hold an air seal in position (and a similar set of tie bolts between the fifth and sixth stages). Failure of this set of tie bolts would result in a loose air seal and cause major damage to the engine. Lowered resistance to failure is evidenced by the failure of one or more individual bolts. (Note that although this would be a functional failure of the tie bolts, it is a potential failure from the standpoint of the engine.)

The second example concerns the nozzle guide vanes of the same engine. These vanes are subject to burning by the hot exhaust gases of the engine, and also to erosion by hard carbon particles from the combustor. The required borescope inspection is a visual inspection to determine how much damage has occurred on the airfoil and inner platform of the vane. The definition of potential-failure conditions in this case is quite complex; in practice the interval between inspections is reduced as the condition deteriorates, until a point is reached at which the engine must be removed from service.

EXHIBIT 3-2 Examples of on-condition inspection tasks as specified to maintenance mechanics. (United Airlines)

1 LOW-PRESSURE TURBINE SECTION

Check for failed airseal tie bolts.

Note: Airseal tie bolts between fourth- and fifth-stage and sixth-stage rotors (last three stages) are failing. These broken bolts are trapped in the airseal between the rotors and cause a rattling sound as they roll when the turbine is slowly rotated.

- A Have fan rotated 180 degrees very slowly. Repeat 180-degree rotation as often as necessary.
- B Listen at tailcone for rattling sound caused by broken bolts rolling around (do not confuse with clanking sound of blades). Attempt to determine number of broken bolts by counting rattles.
- C Failed-bolt limits.
Three or fewer broken bolts: engine may remain in service.
Four or more broken bolts: engine must be borescoped within 75 hours.
- D Supply the following information:
 - (1) Plane number _____ Engine position _____
Engine time since last shop visit _____
 - (2) Number of broken bolts estimated from "listening" check _____
- E Send DIS-P5106 message giving above information.

2 FIRST-STAGE NOZZLE GUIDE VANES

Borescope inspection (Boeing 747 JT9D powerplant).

- A Perform initial borescope inspection of first-stage nozzle guide vanes at 600 hours. Perform repeat inspections at 600, 200, 75, or 30 hours, depending on conditions found.
- B Distress limits as given in MM/OV 72-00-99:
 - (1) Trailing-edge cracks: maximum of 5 cracks per vane extending to window (slot) leading edge. If distress exceeds this limit, remove engine; otherwise, repeat inspection in 600 hours.
 - (2) Trailing-edge erosion: If burning-surface burn-through does not exceed 1/2 by 1/2 inch, repeat inspection in 600 hours; if burn-through does not exceed 3/4 by 3/4 inch, repeat inspection in 200 hours; if burn-through does not exceed 1 by 1 inch, repeat inspection in 75 hours. If surface burn-through is up to 5/8 inch from leading edge, repeat inspection in 30 hours.

Note: 30-hour limit is a maximum fly-back limit, to be used one time only.

3 FIRE-DETECTOR INSTALLATIONS

Intensified inspection of installations, leads, and connections.

A Check for minimum clearance of 1/16 inch between sensing elements and engine, as well as between various engine components. Provide necessary clearance.

B Check for any signs of wear.

C Wear limits:

Acceptable: Flat spots not exceeding 0.035 inch in width; any length acceptable.

Not acceptable: Flat spots exceeding 0.035 inch in width or worn spot exposing inner conductor or composition material between inner conductor and outer sensing-element shell.

Note: Nominal diameter is 0.070 inch.

4 BRAKE ASSEMBLY, MAIN LANDING GEAR

Check brake-lining wear at each assembly, using small scale.

A Set parking brakes.

B Measure wear-indicator pin extension at both indicator pins.

C Wear limits:

If either pin is less than 0.25 inch in length, replace brake assembly.

Note: Replacement may be deferred, with approval from SFOLM, provided wear-indicator pin measures longer than 13/64 inch. If wear-indicator pin length is 13/64 inch or less, immediate replacement is required.

5 PNEUMATIC DRIVE UNITS, LEADING EDGE FLAP

Check oil level and service as required.

Note: Drive units are numbered from outboard to inboard, 1 to 4, left and right wing.

A Check oil level in proper sight glass. If oil level is visible in sight glass, no service is required.

B If oil is not visible, slowly add oil (OIL 2380) through fill port until sight glass is filled. Use 53769 oil dispenser.

C Allow excess oil to drain out before installing fill plug.

In the third example the potential failure may be either lack of adequate clearance or visible wear on fire-detector sensing elements and leads. The fourth and fifth examples involve less judgment in the inspection process. Exact limits are given for the brake wear-indicator pin in the first case and oil level in the pneumatic unit in the second case. Both require a clearcut response on the part of the inspecting mechanic.

Whenever an on-condition task is applicable, it is the most desirable type of preventive maintenance. Not only does it avoid the premature removal of units that are still in satisfactory condition, but the cost of correcting potential failures is often far less than the cost of correcting functional failures, especially those that cause extensive secondary damage. For this reason on-condition inspection tasks are steadily replacing older practices for the maintenance of airline equipment.

3·2 SCHEDULED REWORK TASKS

applicability criteria
effectiveness criteria
effect of an age limit on
maintenance workload

Many single-celled and simple items display wearout characteristics—that is, the probability of their failure becomes significantly greater after a certain operating age. When an item does have an identifiable wearout age, its overall failure rate can sometimes be reduced by imposing a hard-time limit on all units to prevent operation at the ages of higher failure frequency. If the item is such that its original failure resistance can be restored by rework or remanufacture, the necessary rework task may be scheduled at appropriate intervals.* For example, the airplane tire in Exhibit 2.4 could have been scheduled for rework after a specified number of landings, since retreading restores the original failure resistance. However, this would have resulted in the retreading of all tires at the specified age limit, whether they needed it or not, and would not have prevented functional failures in those tires that failed earlier than anticipated.

Where no potential-failure condition can be defined, on-condition inspection of individual units is not feasible. In such cases a rework task may be applicable, either for a simple item or to control a specific failure mode in a complex item. Although the age limit will be wasteful for some units and ineffective for others, the net effect on the entire population of that item will be favorable. This is not the case, however, for complete rework of a complex item. As we saw in Chapter 2, failures in complex items are the result of many different failure modes, each of

*The term *overhaul* has the connotation that the unit is completely disassembled and remanufactured part by part to restore it as nearly as possible to a "like-new" physical condition. *Rework* refers to a set of maintenance operations considered sufficient to restore the unit's original resistance to failure. Thus rework for specific items may range from replacement of a single part to complete remanufacture.

which may occur at a different average age. Consequently the overall failure rate of such items remains relatively constant; in some cases reliability decreases gradually with age, but there is no particular age that can be identified as a wearout zone. Thus, unless there is a dominant failure mode which is eliminated in the course of rework, complete rework of a complex item will have little or no effect on the overall failure rate.

A rework task can be considered applicable to an item only if the following criteria are met:

- ▶ There must be an identifiable age at which the item shows a rapid increase in the conditional probability of failure.
- ▶ A large proportion of the units must survive to that age.
- ▶ It must be possible to restore the original failure resistance of the item by reworking it.

Because the information required to develop survival and conditional-probability curves for an item is not available when equipment first goes into service, scheduled rework tasks rarely appear in a prior-to-service maintenance program (only seven components were assigned to scheduled rework in the initial program developed for the Douglas DC-10). Often, however, those items subject to very expensive failures are put into an age-exploration program to find out as soon as possible whether they would benefit from scheduled rework.

Even when scheduled rework is applicable to an item, very often it does not meet the conditions for effectiveness. A reduction in the number of expected failures, for example, would not be sufficient in the case of safety consequences, and in the case of economic consequences the task must be cost-effective. Moreover, since an age limit lowers the average realized age of an item, it always increases the total number of units sent to the shop for rework.

As an example, consider the effect scheduled rework would have on the turbine engine discussed in Section 2.7. With no age limit, the failure rate of these engines is 0.552 failures per 1,000 hours. Thus over an operating period of 1 million hours an average of 552.2 failed units ($1,000,000/1,811$) are sent to the shop for repair (see Exhibit 3.3). A rework age limit of 2,000 hours will reduce the failure rate to 0.416; however, it will also reduce the average realized age from 1,811 hours to 1,393 hours. Since 42 percent of the units survive to 2,000 hours, over the same operating period an average of 717.9 units would be sent to the shop—the 416.3 units that failed plus the additional 301.6 scheduled removals. In other words, there would be about 135 fewer failures, but 166 more engines that required rework. On this basis scheduled rework at 2,000-hour intervals would not be cost-effective unless the rework cost for scheduled removals were substantially lower than the cost of

age limit (hours)	failure rate (per 1,000 hours)	percentage of units surviving to age limit	averaged realized engine age (hours)
1,000	0.3681	69.2	838
2,000	0.4163	42.0	1,393
3,000	0.4871	17.9	1,685
None	0.5522	0	1,811

EXHIBIT 3-3 Effect of several rework age limits on shop workload. The total number of engines sent to the shop is computed by dividing the total hours of engine operation by the average realized age for each age limit. The number of scheduled removals is then the percentage of this total that survives to the age limit in question.

repairing failures (in this case the rework cost would have to be less than 135.9/301.6, or 45.1 percent, of the repair cost).

Of course, the direct cost of rework is not the only economic factor to be taken into account. If the failure is one that has operational consequences, the reduction in the number of failures may more than offset the additional cost of rework. Determining the economic desirability of a proposed rework age limit will be discussed in greater detail in the next chapter. In general, however, the effect of at least four possible rework intervals must be analyzed before an optimum limit can be determined — if indeed one does exist. In most cases a rework task will not prove cost-effective unless the item has an unusually expensive failure mode or the cost of a functional failure includes economic losses other than the direct cost of repair.

3-3 SCHEDULED DISCARD TASKS

criteria for safe-life limits
criteria for economic-life limits

The scheduled rework of items at a specified age limit is one type of hard-time task; the other is scheduled discard of items or certain of their parts at some specified operating age. Such tasks are frequently termed *life-limit tasks*. Life limits may be established to avoid critical failures, in which case they are called *safe-life limits*, or they may be established because they are cost-effective in preventing noncritical failures, in which case they are called *economic-life limits*.

SAFE-LIFE LIMITS

A safe-life limit is imposed on an item only when safety is involved and there is no observable condition that can be defined as a potential failure. In this case the item is removed at or before the specified maximum

shop workload per 1,000,000 engine operating hours		
failed engines	scheduled removals	total workload
368.1	825.2	1,193.3
416.3	301.6	717.9
487.1	106.4	593.5
552.2	—	552.2

age and is either discarded or disassembled for discard of a time-expired part. This practice is most useful for simple items or individual parts of complex items, such as pyrotechnic devices in ejection seats, which have a limited shelf life, and turbine-engine disks or nonredundant structural members, which are subject to metal fatigue.

The safe-life limit itself is usually established by the equipment manufacturer on the basis of developmental testing. A component whose failure would be critical is designed to begin with to have a very long life. It is then tested in a simulated operating environment to determine what average life has actually been achieved, and a conservatively safe fraction of this average life is used as the safe-life limit.

Safe-life items are nearly always single-celled parts, and their ages at failure are grouped fairly closely about the average. However, the correlation between a test environment and the actual operating environment is never perfect. Moreover, because testing a long-lived part to failure is both time-consuming and expensive, the volume of test data is often too small to permit us to draw a survival curve with much confidence. For this reason safe-life limits are usually established by dividing the average failure age by a large arbitrary factor—sometimes a factor as large as 3 or 4. The implication is that the conditional probability of failure at this limit is essentially zero; that is, a safe-life limit is based on a 100 percent probability of survival to that age. The difference between a safe-life limit and the average age at failure is illustrated in Exhibit 3.4.

A safe-life discard task is applicable only under the following circumstances:

- ▶ The item must be subject to a critical failure.
- ▶ Test data must show that no failures are expected to occur below the specified life limit.

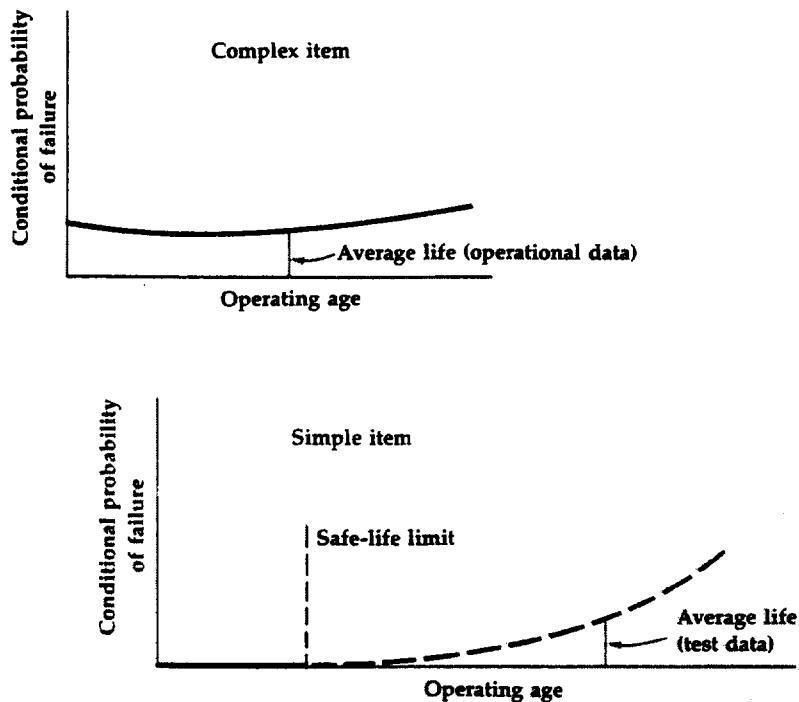

EXHIBIT 3-4 Comparison of the average age at failure (average life) determined from operating data and a safe-life limit determined on the basis of test data.

Since the function of a safe-life limit is to avoid the occurrence of a critical failure, the resulting discard task is effective only if it accomplishes this objective. Thus the only information for assessing effectiveness in this case will be the manufacturer's test data. Sometimes these tests have not been completed at the time the initial program is developed, but until a limit can be established, the available test data must show that the anticipated in-service aging of the item will be safe. An operating organization rarely has the facilities for further simulation testing that might justify increasing a safe-life limit, nor is there usually a reasonable basis for reducing it, unless failures occur.

ECONOMIC-LIFE LIMITS

In some instances extensive operating experience may indicate that scheduled discard of an item is desirable on purely economic grounds. An *economic-life limit*, however, is established in the same manner as an age limit for scheduled rework; that is, it is based on the actual age-reliability relationship of the item, rather than on some fraction of the average age at failure. Whereas the objective of a safe-life limit is

to avoid accumulating any failure data, the only justification for an economic-life limit is cost effectiveness. Thus the failure rate must be known in order to predict how the total number of scheduled removals at various age limits would affect the cost-benefit ratio.

In general, an economic-life task requires the following three conditions:

- ▶ The item must be subject to a failure that has major economic (but not safety) consequences.
- ▶ There must be an identifiable age at which the item shows a rapid increase in the conditional probability of failure.
- ▶ A large proportion of the units must survive to that age.

Although an item that meets the first criterion may be put into an age-exploration program to find out if a life limit is applicable, there are rarely sufficient grounds for including this type of discard task in an initial scheduled-maintenance program.

3·4 SCHEDULED FAILURE-FINDING TASKS

Whenever an item is subject to a functional failure that would not be evident to the operating crew, a scheduled task is necessary to protect the availability of that function. Although hidden-function failures, by definition, have no immediate consequences, failures that are undetected increase the exposure to a possible multiple failure. Hence, if no other type of maintenance task is applicable and effective, hidden-function items are assigned *failure-finding tasks*, scheduled inspections for hidden failures. Although such tasks are intended to locate functional failures rather than potential failures, they can be viewed as a type of on-condition maintenance, since the failure of a hidden-function item can also be viewed as a potential multiple failure. The chief difference is in the level of item considered; a functional failure of one item may be only a potential failure for the equipment as a whole.

Most items supported by failure-finding inspections remain in service until a functional failure is discovered. Some items, however, have several functions, of which only one or a few are hidden. Such items will be removed from service to correct evident failures, and if the removal rate is sufficient to ensure adequate availability of the hidden function, the shop specifications may include a failure-finding inspection at that time. Other items may not require scheduled failure-finding tasks because the operating crew is required to check them periodically. Many hidden functions, especially in systems, are made evident by the addition of instrumentation, so that a separate inspection for hidden failures is unnecessary.

applicability criteria
determining average
availability

A scheduled failure-finding task is applicable to an item under the following two conditions. Note that the second criterion is in fact a default condition:

- ▶ The item must be subject to a functional failure that is not evident to the operating crew during the performance of normal duties.
- ▶ The item must be one for which no other type of task is applicable and effective.

The objective of a failure-finding task is to ensure adequate availability of a hidden function. The level of availability that is needed, however, depends on the nature of the function and the consequences of a possible multiple failure. Some hidden functions, such as the fire-warning system in an aircraft powerplant, are sufficiently important that they are tested before every flight.

Appropriate intervals for failure-finding tasks cannot be determined as exactly as those for other types of tasks. In the case of emergency equipment hidden-function items which are replaced at specified intervals, such as pyrotechnic devices, are tested prior to rework or discard to see if they would have functioned had they been needed. The test results at any given interval provide a basis for increasing or decreasing the interval. In other cases the expected availability of a hidden function can be approximated by assuming that the age-reliability relationship is exponential,* assigning a conservatively high failure rate, and then determining the probability of survival across a given inspection interval.

As an example, suppose some hidden function has an anticipated failure rate of 0.5 per 1,000 hours. The mean time between failures is then 2,000 hours. If the proposed inspection interval is 500 hours, a unit that is serviceable at one inspection will have aged 500 hours by the next inspection. The probability that it will survive this 500-hour interval (one-fourth of the mean time between failures) is .78 on an exponential curve (Exhibit 3.5). The average availability would thus be

$$\frac{1.00 + 0.78}{2} = 0.89$$

or a probability of .89 that the item will function if it is needed. If this degree of reliability is inadequate, the inspection interval must be reduced. Failure-finding tasks are always effective if the inspection interval is short enough.

To be considered effective a failure-finding task must ensure the required level of availability. However, this task must also be cost-

*If the conditional probability of failure is nonincreasing, this is a conservative assumption.

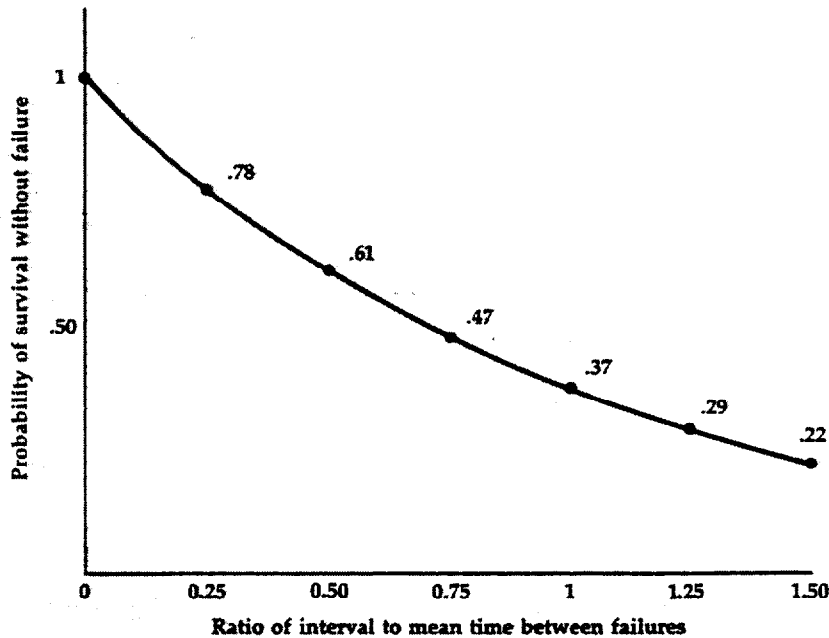

EXHIBIT 3-5 Establishing the interval for a failure-finding inspection. The age-reliability relationship of an item is assumed, in the absence of information, to be exponential over operating age. Thus at an inspection interval equal to one-fourth of the mean time between failures, the probability that the item will survive that interval is .78. This is true of the interval between any two inspections, regardless of the age of the item. On the basis of this inspection interval, the average availability of the unit would be 89 percent. An interval that represented a smaller fraction of the expected mean time between failures would yield a higher average availability.

effective with respect to the three other types of maintenance tasks—that is, it must be the least expensive means of ensuring the necessary level of availability. When a possible multiple failure is not related to safety, an availability goal of 95 percent is often used. Alternatively, the economic consequences of the multiple failure can be balanced against the costs of inspection to determine the most cost-effective interval and availability level.

Exhibit 3.6 shows some typical failure-finding tasks for a commercial aircraft. In each case the scheduled task is designed to identify a functional failure. In the second example the failure might or might not be evident to the operating crew, depending on whether a complaint was received from a passenger.

EXHIBIT 3-6 Examples of failure-finding inspection tasks as specified for airline maintenance mechanics. In this case the mechanic is required only to replace the failed units. (United Airlines)

- 1 SMOKE GOGGLES**
Replace missing or damaged goggles (not repairable) as required by the following conditions:
 - A Plastic-foam face seal not adhering to goggle rim
 - B Lens not retained within goggle groove
 - C Dirt or scratches on lens
 - D Any other detrimental condition

- 2 READING LIGHTS, PASSENGER-SERVICE SYSTEM**
Test lights in zones A to E.
 - A At positions 1, 2, 3, and 4 on right attendant's panel, position switches as follows:
PES-OFF, PSS-OFF, CH-OFF, ATTND CALL-TEST (to illuminate blue)
 - B For zone being checked, rotate reading-light switch to ON position:
 - (1) All reading lights in that zone should illuminate.
 - (2) Master call light should not blink.
 - C Rotate reading-light switch to OFF position:
 - (1) All reading lights in that zone should not be illuminated.
 - (2) Master call light should not blink.
 - D Rotate reading-light switch to SEAT position:
All reading lights in that zone should return to individual seat CTL selector.

- 3 EXTERIOR LIGHTS**
 - A Turn on beacon, navigation, and wing-illumination lights, and at night turn on logo lights.
 - B Walk around exterior of aircraft and check lights.
 - C Turn off lights.

3.5 CHARACTERISTICS OF THE BASIC TASKS

The four types of scheduled-maintenance tasks employed in an RCM program differ both in terminology and in concept from traditional approaches to scheduled maintenance. In the airline industry, for example, it is customary to refer to three "primary maintenance processes": *on-condition*, *hard time*, and *condition monitoring*. All scheduled tasks are considered to be either on-condition or hard-time. On-condition tasks are defined by FAA regulations as:

... restricted to components on which a determination of continued airworthiness may be made by visual inspection, measurement, tests, or other means without a teardown inspection or overhaul. These "On-Condition" checks are to be performed within the time limitations prescribed for the inspection or check.

Although the term *hard time* is not specifically defined, it is implied by a number of FAA requirements. Airline maintenance specifications must include "time limitations, or standards for determining time limitations, for overhauls, inspections and checks of airframes, engines, propellers, appliances, and emergency equipment," and the basic principle for establishing these time limitations is:

... that the inspections, checks, maintenance or overhaul be performed at times well within the expected or proven service life of each component of the aircraft.

terminology differences
the basis of task preference
items that cannot benefit from
scheduled maintenance

EXHIBIT 3-7 Comparison of RCM task terminology and current regulatory usage.

RCM terminology	current regulatory usage
Inspection tasks:	
On-condition tasks (to detect potential failures)	On-condition process
Failure-finding tasks (to detect hidden function failures)	Condition-monitoring process (inspection of hidden-function items)
Removal tasks:	Hard-time process
Scheduled rework	Scheduled overhaul
Scheduled discard	Life limit
Servicing tasks	Servicing
No scheduled maintenance	Condition-monitoring process (no scheduled tasks)

The process termed *condition monitoring* is one that is characterized by the absence of preventive-maintenance tasks. An item is said to be maintained by condition monitoring if it is permitted to remain in service without preventive maintenance until a functional failure occurs. However, since condition monitoring is oriented to after-the-fact detection of failures, this designation may refer in some instances to failure-finding tasks assigned to hidden-function items and in other instances to items assigned to no scheduled maintenance.

Despite the overlap in terminology, there are certain fundamental differences in concept between the tasks performed under traditional maintenance policies and the explicit task definitions required by an RCM program. The hard-time approach was based on the assumption that complex items do have an "expected or proven service life"—that is, that their overall reliability invariably decreases with age. On this premise overhaul specifications usually required that all units which had survived to the specified time limit be disassembled down to their smallest constituent parts and inspected in detail for signs of deterioration. Technical experts examined each part and formed opinions about whether a given component could have continued to operate satisfactorily to a projected new overhaul interval; in other words, they made judgments about the age at which the item was likely to fail.

These teardown inspections might at first appear to qualify as on-condition inspections. However, such inspections were rarely focused on the specific conditions required by an on-condition task. Unfortunately it is usually beyond human capability to look at a used part and determine what its likelihood of failure will be at some later age. As a result, the initial overhaul intervals for new equipment were short and were extended only by very small increments. At one point, in fact, the FAA limited extensions of the interval for engine overhauls to a maximum of 100 hours and required a period of at least three months between successive extensions.

Note that the traditional type of scheduled overhaul also fails to satisfy the criteria for a rework task. Shop specifications calling for the part-by-part remanufacture of complex items to restore them to "like-new" condition were intended to avoid operation in the age period at which failures were expected to be more likely. As we have seen, however, this expectation does not hold for most complex items. Consequently we cannot expect periodic overhaul at any operating age to make a noticeable difference in their reliability. Furthermore, even when a complex item does meet the applicability criteria for a rework task, it is difficult to satisfy the conditions for effectiveness. For this reason complete rework of items such as turbine engines is now relatively rare, and many organizations have abandoned rework of other rotating machinery, which was once considered a prime candidate for scheduled overhaul.

THE BASIS OF TASK PREFERENCE

The applicability of any maintenance task depends on the failure characteristics of the item. However, the characteristics of the tasks themselves suggest a strong order of preference on the basis of their overall effectiveness as preventive measures. The first choice is always an on-condition inspection, particularly if it can be performed without removing the item from the equipment. This type of preventive maintenance has a number of advantages. Because on-condition tasks identify individual units at the potential-failure stage, they are particularly effective in preventing specific modes of failure. Hence they reduce the likelihood both of critical failures and of the operational consequences that would otherwise result from that failure mode. For the same reason, they also reduce the average cost of repair by avoiding the expensive secondary damage that might be caused by a functional failure.

The fact that on-condition tasks identify individual units at the point of potential failure means that each unit realizes almost all of its useful life. Since the number of removals for potential failures is only slightly larger than the number that would result from functional failures, both the repair costs and the number of spare units necessary to support the repair process are kept to a minimum. The scheduling of on-condition inspections at a time when the equipment is out of service concentrates the discovery of potential failures at the maintenance stations that perform the inspections. This fact, together with the lower probability of functional failures, further reduces the inventory of spare units that would otherwise have to be kept available at each line station.

If no applicable and effective on-condition task can be found, the next choice is a scheduled rework task. Scheduled rework of single parts or components leads to a marked reduction in the overall failure rate of items that have a dominant failure mode (the failures resulting from this mode would be concentrated about an average age). This type of task may be cost-effective if the failures have major economic consequences. As with on-condition inspections, the scheduled removals can be concentrated at a few maintenance stations, thus reducing the exposure of all line stations to the need to remove units after they have failed. A rework age limit usually includes no restriction on the remanufacture and reuse of time-expired units; hence material costs are lower than they would be if the entire unit had to be discarded.

Any scheduled rework task, however, has certain disadvantages. Because the age limit applies to all units of an item, many serviceable units will be removed that would otherwise have survived to higher ages. Moreover, as we saw in Section 3.2, the total number of removals will consist of failed units plus scheduled removals. Hence the total workload for this task is substantially greater than it would be with on-condition inspection, and a correspondingly larger number of spare units is needed to support the shop process.

Scheduled discard is economically the least desirable of the three directly preventive tasks, although it does have a few desirable features. A safe-life limit on simple components can prevent critical failures caused by certain failure modes. Similarly, an economic-life limit can reduce the frequency of functional failures that have major economic consequences. However, a discard task is in itself quite costly. The average life realized by an item subject to a safe-life limit is only a fraction of its potentially useful life, and the average life of an item subject to an economic-life limit is much less than the useful life of many indi-

EXHIBIT 3-8 Comparison of various characteristics of the four basic scheduled-maintenance tasks.

characteristic	on-condition task	scheduled rework task
Applicability criteria	Reduced resistance to failure must be detectable; rate of reduction in failure resistance must be predictable.	Conditional probability of failure must increase at an identifiable age; a large proportion of the units must survive to that age.
Effectiveness criteria	For critical failures the task must reduce the risk of failure to an acceptable level; in all other cases the task must be cost-effective.	For critical failures the task must reduce the risk of failure to an acceptable level (a rework task alone is unlikely to meet this requirement); in all other cases the task must be cost-effective.
Usual availability of required information	Applicability prior to service; effectiveness after age exploration.	Applicability after age exploration; effectiveness after age exploration.
Effect on occurrence of functional failures	Failures due to specific failure mode eliminated or greatly reduced in frequency.	Frequency of failures somewhat less than with no scheduled maintenance.
Distribution of removals	Removals for potential failures concentrated at few stations where inspections are performed; removals for functional failures at any station.	Scheduled removals concentrated at a very few stations; removals for functional failures at any station.
Effect on shop volume	Slightly greater than with no scheduled maintenance.	Much greater than with on-condition or no scheduled maintenance.

vidual units. In addition, a discard task involves the cost of replacement; new items or parts must be purchased to replace the time-expired units, since a life limit usually does not permit remanufacture and reuse.

Hidden-function failures have no immediate consequences; hence our interest is in the least expensive means of ensuring the necessary level of availability for the item. When none of the other three tasks is applicable, the default action for hidden-function items is a failure-finding task. Otherwise, the choice of task is determined by cost effectiveness.

scheduled discard task	failure-finding task
<p>For safe-life items conditional probability of failure must be zero below life limit; for economic-life items conditional probability of failure must increase at an identifiable age and a large proportion of units must survive to that age.</p>	<p>The occurrence of a functional failure must not be evident to the operating crew.</p>
<p>A safe-life limit must reduce the risk of failure to an acceptable level; an economic-life limit must be cost-effective.</p>	<p>The task must result in the level of availability necessary to reduce the risk of a multiple failure to an acceptable level.</p>
<p>Safe-life applicability and effectiveness prior to service; economic-life applicability and effectiveness after age exploration.</p>	<p>Applicability prior to service; effectiveness after age exploration.</p>
<p>Failures due to specific failure mode eliminated (safe-life limit) or reduced in frequency (economic-life limit).</p>	<p>No effect on item inspected, but frequency of multiple failures greatly reduced.</p>
<p>Scheduled removals concentrated at a very few stations; removals for functional failures (economic-life limit) at any station.</p>	<p>Removals concentrated at stations where inspections are performed; no removals at other stations.</p>
<p>Not applicable.</p>	<p>Minimal.</p>

ITEMS THAT CANNOT BENEFIT FROM SCHEDULED MAINTENANCE

In the process of evaluating proposed maintenance tasks for an item there will be a number of instances in which no applicable task can be found—that is, items for which there is no evidence that a particular task will improve reliability. There will be far more instances, however, in which an applicable task does not satisfy the conditions for effectiveness. This may be because the failure has such minor consequences that the task is not cost-effective or because it has such major consequences that the task does not reduce the risk of failure to the required level. If safety consequences are involved, the objective of any task is to minimize the probability of a failure, and in this case all applicable tasks are assigned as preventive maintenance. Since most essential functions in well-designed equipment are protected by redundancy, the safety hazard is usually the possible secondary damage. However, the number of failure modes in which this is a factor is relatively small.

When an item cannot benefit from scheduled maintenance, in some cases product improvement may be necessary before the equipment goes into service. More often the chore of determining what preventive maintenance might accomplish for each item helps to clarify specific modifications that would improve reliability in subsequent designs.

Where safety consequences are not involved, any applicable task must be cost-effective, and this condition is usually difficult to satisfy unless the failure has operational consequences. Once again, the design often employs redundancy to limit the number of items subject to such failures. As a result, there are tens of thousands of items on complex equipment for which scheduled maintenance provides no advantage. Since such items cannot benefit from preventive maintenance, they are left in operation until a functional failure occurs. This strategy permits each unit to realize its maximum useful life.

Items that cannot benefit from scheduled maintenance are characterized by two properties:

- ▶ Such items have no hidden functions; hence a failure is evident to the operating crew and will therefore be reported and corrected.
- ▶ The failure is one that has no direct adverse effect on operating safety.

A further characteristic of such items is that many of them are complex. One reason for this is that when there is no evidence that a proposed task will actually improve the reliability of a complex item, there is always the possibility that it will introduce new problems, either by upsetting a stable state or, in some cases, by introducing workmanship problems. Thus where a complex system cannot be protected by on-condition inspections, from a purely practical standpoint the default action would be no scheduled maintenance. This is usually the case, for example, with electrical and electronic systems.

3·6 THE DIMENSIONS OF A SCHEDULED-MAINTENANCE PROGRAM

THE ROLE OF THE BASIC TASKS

The maintenance activities required to support any type of complex equipment include routine servicing, periodic inspections, and the performance of any corrective maintenance necessary when a condition is found to be unsatisfactory. Scheduled tasks are selected, however, on the basis of the ways in which a particular item can fail. In considering all the known or anticipated failure modes of each item we find that many major components cannot benefit from any type of preventive maintenance, some will require a single task, and others will require several different tasks. The maintenance tasks assigned to a complex item such as an aircraft turbine engine, for example, are quite numerous. Following are just a few of the inspection tasks performed while the engine is installed:

- ▶ Oil-screen inspection to detect metal particles
- ▶ Borescope inspection of the combustor to detect signs of metal fatigue
- ▶ "Sniff test" of the fuel manifold to detect fuel odors
- ▶ "Broomstick check" to detect loose turbine blades
- ▶ Inspection of the fan blades and front compressor blades for possible damage
- ▶ Inspection for rattling noise to detect broken tie bolts
- ▶ Radioisotope inspection of nozzle guide vanes for deformation
- ▶ Spectrographic oil analysis to detect metallic indications of wear

Recognition of the criteria for applicability of scheduled rework has led to a great reduction in the number of items removed and sent to the shop for routine overhaul. Items are still removed from equipment and sent to the maintenance base, however, either because they have failed or because they contain parts that require scheduled rework or discard. In this case it is necessary to decide the extent of the work to be done before these items are returned to service. Within the frame of reference dictated by the applicability of rework tasks, there are only four circumstances under which rework would be specified:

- ▶ Single parts may require rework as the result of an inspection for potential failures that can be performed only when an item is disassembled in the shop. This applies to certain types of turbine blades.

the role of the basic tasks
servicing and lubrication tasks
zonal inspections and
walkaround checks
the total maintenance workload

- ▶ Single parts may require rework because their failure characteristics show that they will benefit from an age limit. This is the case with some fuel manifolds.
- ▶ Single parts may have to be discarded because they have reached a specified life limit. This applies to the safe-life limits imposed on most compressor and turbine disks.
- ▶ Single parts may have to be reworked or discarded because shop inspection discloses a functional failure that was not observable when the item was installed on the equipment.

The amount of work specified as part of shop maintenance depends, of course, on the nature of the item. With some the direct cause of a failure is corrected, and if the component can then meet its performance standards, it is returned to service. This practice is sometimes referred to as *conditional overhaul*. Other items, such as turbine engines, may have a great deal of additional work done on them while they are out of service. The work performed, however, is very much less than that done under hard-time overhaul policies. As a result, the RCM approach to rework tasks has substantially decreased engine maintenance costs, not only by reducing the volume of units flowing through the maintenance base, but also by reducing the amount of work required when they are there.

The propulsion system is not the only complex item on an aircraft; however, it is a system closely associated with operating safety, and the largest part of the maintenance costs for any aircraft stem from scheduled or unscheduled work on engines. Because of this, on-condition inspections play a major role in powerplant maintenance programs, and scheduled removals, when they are necessary, are set at the maximum interval that will allow satisfactory operation.

SERVICING AND LUBRICATION

Complex equipment requires numerous scheduled servicing and lubrication tasks to maintain satisfactory operation. There is usually no question about which tasks are required and whether they are applicable and effective. However, it is interesting to review this aspect of maintenance in light of our discussion thus far.

Lubrication, for example, really constitutes scheduled discard of a single-celled item (the old lubrication film). This task is applicable because the film does deteriorate with operating age and show wearout characteristics. Usually the condition of the film cannot be determined; hence conservatively short intervals are assigned for its replacement with new lubricant. Such tasks are also cost-effective. An item is lubricated whether it needs lubrication or not because the cost is minuscule in

comparison to the costs that would result from inadequate lubrication. In fact, the cost of this task is too low to justify studies to determine the most economical task interval. As a result, lubrication is rarely isolated for in-depth analysis in developing a maintenance program.

Whereas lubrication constitutes a discard task, the servicing tasks—checking tire pressure or fluid levels in oil and hydraulic systems—are on-condition tasks. In this case potential failures are represented by pressure or fluid levels below the replenishment level, and this condition is corrected in each unit as necessary.

ZONAL INSPECTIONS AND WALKAROUND CHECKS

In contrast to servicing and lubrication tasks, zonal inspections and walkaround checks of aircraft structures do not fall within the realm of RCM task definition. Walkaround checks are intended to spot accidental damage and fluid leaks and hence might be viewed as combination on-condition and failure-finding inspections. In fact, they do include a few specific on-condition tasks, such as a check of brake wear indicators. However, damage can occur at any time and is unrelated to any definable level of failure resistance. As a result, there is no basis for defining an explicit potential-failure stage or a predictable interval between a potential failure and a functional failure. Similarly, a check for leaks is not based on the failure characteristics of a particular item, but rather is intended to spot any unforeseen exceptions in failure behavior.

Zonal inspections are even less specific. They are not directed at any particular failure mode, but are merely a survey of the general conditions within a given zone, or area, of the equipment. Zonal inspections include a check of all the system assemblies and connecting lines in each zone for security (loose parts), obvious signs of damage or leaks, and normal wear and tear as a result of other maintenance activities. In the powerplant this inspection includes looking into the engine tailpipe and inlet, opening the cowling and examining all the engine-mounted accessories, and so on. Such inspections play an important role in structural maintenance, since they also include a general inspection of the internal structural areas that can be seen with all installations in place. Thus they complement, but are not a substitute for, the program of detailed on-condition inspections developed for structurally significant items.

Although zonal-installation inspections do not meet the applicability criteria for any of the four basic tasks, their cost is such a small part of the total cost of scheduled maintenance that they are economically justified if they result in the discovery of even a few potential failures. For this reason any RCM program is supplemented by a separate program of scheduled zonal inspections.

EXHIBIT 3-9 A breakdown of the total maintenance workload of 18.8 manhours per flight hour on the United Airlines fleet of Boeing 747's. Data are for January–November 1975 and do not include man-hours expended to accomplish modifications. (United Airlines)

location of work performed	scheduled work	corrective work		total manhours per flight hour
		flight-crew reports	mechanic reports	
ON THE AIRPLANE				
At stations				
Below A-check level	— ¹	2.1	0.2	2.3
At A-check level	<u>0.2²</u>	<u>—³</u>	<u>0.2</u>	<u>0.4</u>
	0.2	2.1	0.4	2.7
At main maintenance base				
Phase check (combination of B and C checks)	0.7 ²	—	0.7	1.4
D check (heavy structural inspection)	<u>0.8^{2,4}</u>	<u>—</u>	<u>0.8</u>	<u>1.6</u>
	1.5	—	1.5	3.0
OFF THE AIRPLANE				
At main maintenance base				
Repair of failed engines	—	2.3 ⁵	6.9	9.2
Repair of other failed items	—	<u>3.9</u>	<u>—¹</u>	<u>3.9</u>
	—	6.2	6.9	13.1
	1.7	8.3	8.8	18.8

1 Workload was not significant.

2 Workload at checks was prorated, with one-half assigned to scheduled inspections and servicing and one-half assigned to corrective work.

3 A-check figures were adjusted to include only scheduled-maintenance work and the corrective work it generated. Corrective work resulting from flight-crew reports is aggregated with other below-A-check work.

4 The D check figure is not typical. During the reporting period there were two sample D checks for age-exploration purposes. A longer reporting period would lead to a smaller D check number.

5 The corrective engine work was prorated, with one-quarter assigned to pilot reports and the remainder assigned to mechanic findings.

THE TOTAL MAINTENANCE WORKLOAD

The total maintenance workload required to support complex equipment consists of all the work performed as scheduled maintenance, plus the corrective-maintenance work required to repair failed units. Exhibit 3.9 illustrates the ratio of these two aspects of maintenance for an aircraft supported by a scheduled-maintenance program that is essentially the same as an RCM program. The scheduled tasks comprised somewhat less than 10 percent of the total manhours spent on maintenance, yet these tasks ensured realization of all the reliability of which the equipment was capable. Additional scheduled work would have increased costs, but it would not have improved reliability.

Approximately 75 percent of the corrective work was done at the major maintenance base as a result of the line-maintenance practice of replacing failed units with serviceable ones. About half the corrective work was done on engines. The only way the corrective workload can be reduced is by design changes that improve the inherent reliability of the items that are failing. Such changes are usually directed at dominant failure modes in items whose failure has safety or major economic consequences. In this case the engine failures do have serious economic consequences, and this engine is still undergoing intensive development.

The absolute size of the scheduled workload for this aircraft will not change very much from its 1975 value, but the corrective workload will decrease substantially as product improvement overcomes those problems which require high manhour expenditures. Consequently the relative proportions of the workload components may change in the next several years. At some time in the future both components may increase again as a result of conditions that do not occur until much later ages.

3·7 PRODUCT IMPROVEMENT AS PREVENTIVE MAINTENANCE

Over the years aircraft manufacturers have incorporated a number of design features that have increased the inherent capability of the equipment for reliable operation. In most cases these practices are intended not to prevent failure, but to reduce its consequences to the cost of corrective maintenance. Thus most systems items are designed with a high degree of redundancy to ensure that if one unit fails, the necessary function will still be available. On the same principle, structures are designed with multiple load paths so that they are damage-tolerant. Protective devices may also consist of entirely separate components, as in the case of emergency equipment—fire extinguishers, automatically released oxygen equipment in passenger aircraft, and ejection seats in single-engine military aircraft.

inherent reliability characteristics
methods of coping with the failure process

Another common practice is failure substitution. This may be the substitution of a minor functional failure to preempt a major one, as in the use of automatic shutoff devices. Or it may be a feature included to permit easy identification of a potential failure; for example, the outer skin of an aircraft may be designed to crack before the structural member beneath it fails, so that there is evidence of an imminent failure that can be detected by visual inspection. Inspection features such as bore-scope ports in engines also facilitate the detection of potential failures that would otherwise be difficult to check for.

All these features are important from the standpoint of preventive maintenance, since they determine both the feasibility of certain tasks and the failure consequences by which task effectiveness is measured. On a short-term basis, however, any scheduled-maintenance program must be built around the reliability characteristics of the equipment as it exists. In the case of new equipment, therefore, it is important to bear in mind a basic conflict between certain design goals and reliability goals. This problem is nowhere more apparent than in modern aircraft, where the requirement for lightness and compactness is in direct opposition to the strength and bulk that is necessary for failure resistance. A further difficulty is posed by the rush to new technology, since this means that the designer is often working with new components and even new materials whose reliability has not been proved by experience.

There are several pitfalls here. Designing for lightness, for example, correspondingly reduces the initial margin between resistance and stress. Even with familiar materials, the actual strength of a material may be less than its nominal strength, or the rate at which its failure resistance declines may be greater than expected. With unfamiliar materials and processes the likelihood is increased in both these areas. The design goal of compactness may lead to the same results and to other problems as well. In a more compact area an item that functioned well in a different environment may be exposed to higher temperatures or to vibration from neighboring components. Such items are also likely to be more difficult to reach for inspection or replacement.

Where reliability problems are inherent in the design itself, there are three ways of coping with the failure process:

- ▶ Increasing the initial resistance to failure
- ▶ Reducing the rate at which failure resistance decreases
- ▶ Reducing the stress to which the item is exposed

All three of these effects are shown in Exhibit 3.10.

Reliability improvement in each of these areas can take any number of forms. In some instances the solution may be a modification in operating procedures. For example, the use of more reverse thrust and less braking to slow an airplane after it has landed will reduce the stress on

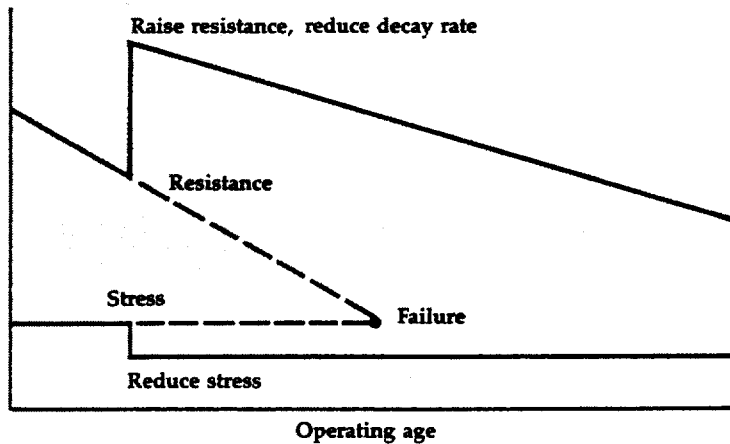

EXHIBIT 3-10 Methods of coping with the failure process. An item may be redesigned to increase its initial failure resistance, to reduce the rate at which failure resistance decays, or both. At the same time, various strategies may be employed to reduce the stress to which the item is exposed. Any or all of these procedures will improve reliability by moving the point of functional failure farther into the future, and thus increasing the mean time between failures.

the brakes (although it increases the cumulative stress on the reverser). Since this procedure will also increase the life of the tires, it has several implications for maintenance. In general, however, when unsatisfactory reliability characteristics result in exposure to critical failures or excessive operational or maintenance costs, the only effective form of prevention is redesign—either to alleviate the problem or to mitigate its consequences.

When a critical-failure mode is involved, and no form of scheduled maintenance can be found that will effectively control it, product improvement is mandatory. Otherwise the desirability of redesign depends on an assessment of the costs involved on both sides. Since this information is ordinarily not available until after the equipment has been in service for some time, items that may ultimately be redesigned on the basis of actual operating costs are often assigned to no scheduled maintenance in a prior-to-service program.

developing the initial program

AN INITIAL scheduled-maintenance program must be developed for new equipment long before it enters service. While it might be possible to obtain a small mountain of test data on every part, assembly, and subsystem, the information about their actual reliability comes only from operating experience. Thus the problem in basing a maintenance program on reliability characteristics might appear to be a lack of the very information that is needed. In reality the problem is not the lack of information; rather, it is knowing what information is necessary in order to make decisions.

The RCM solution to this problem is a structured decision process based, not on an attempt to estimate the reliability of each part, but on the consequences of functional failures for the equipment itself. The decision process thus proceeds from the top down, first to identify those items whose failure is significant at the equipment level and then to determine what scheduled maintenance can do for each of these items. At each step of the analysis the decision is governed by the nature of the failure consequences. This focus establishes the priority of maintenance activity and also permits us to define the effectiveness of proposed maintenance tasks in terms of the results they must accomplish. Once this determination has been made, we are in a position to examine each of the four possible forms of preventive maintenance to see which tasks, if any, are both applicable and effective for the item under consideration.

tasks is facilitated by a decision-diagram technique which employs an ordered set of priorities—in the case of both failure consequences and task selection—with the questions at each level worded to define the information required for that decision. In many cases the answer will be obvious from engineering expertise, the manufacturer's test data, and previous experience with similar items. However, in developing a prior-to-service maintenance program a strategy is required for decision making when the appropriate information is not available. Thus the decision logic also provides for default answers to meet this situation. For an item subject to critical failures, the default path leads ultimately to redesign. Where the consequences of failure are economic, the default decision may be to do nothing (no scheduled maintenance) until operating experience provides the information to justify some other choice.

The result of RCM analysis is a scheduled-maintenance program that includes all scheduled tasks necessary to ensure safety and operating economy, but only those tasks that will do so. Where there is no basis for determining whether a particular task will prove applicable and effective, the default strategy provides the most conservative answer, and as the maintenance program evolves, these initial decisions are systematically modified on the basis of actual operating data. This process continues throughout the service life of the equipment, so that the decision structure provides for an optimal program in terms of the information available at any time. In this chapter we will examine the

decision process as it relates to commercial aircraft. However, the decision logic itself is general and applies to any complex equipment that requires a maintenance support program designed to realize maximum operating reliability at the lowest cost.

4.1 THE NATURE OF SIGNIFICANT ITEMS

identifying significant items
structurally significant items
functionally significant items

A transport plane consists of a vast number of parts and components, all of which have specific functions. All these items can be expected to fail at one time or another, but some of the failures have more serious consequences than others. Certain kinds of failures are a threat to safety, and others have a direct effect on operating capability. However, there are tens of thousands of items whose failure has no immediate impact on the equipment as a whole. The failures are simply corrected soon after they occur, and the only consequence is the cost of repair. These items have no significance from the standpoint of preventive maintenance in the sense that their consequences are tolerable. It is less expensive to leave them in service until they fail than it would be to prevent the failures. Thus the initial decision for these tens of thousands of items is no scheduled maintenance.

The information on which to base this decision ordinarily comes from the manufacturer, who has had to face the problem of failures during the design and development of the equipment. In order to qualify the aircraft for airworthiness, the manufacturer will have conducted a failure modes and effects analysis (FMEA) for all the major assemblies, subsystems, and systems to demonstrate how the equipment will perform when various items fail. In addition, the purchasing airlines will have knowledge of operating experience with similar items in the past, as well as knowledge of the failure consequences in the particular operating context in which the equipment is to be used.

The failures that are of concern are those which have serious consequences. Thus an RCM program directs tasks at a relatively small number of items—those systems, subsystems, and assemblies whose functional failure would be significant at the equipment level, either immediately or downstream in the event of a hidden failure.

IDENTIFYING SIGNIFICANT ITEMS

The first step in the development of a scheduled-maintenance program is a quick, approximate, but conservative identification of a set of *significant items*:

A significant item is one whose failure could affect operating safety or have major economic consequences.

The definition of "major economic consequences" will vary from one operating organization to another, but in most cases it includes any functional failure that has a direct effect on operational capability or involves a failure mode with unusually high repair costs.

So far we have used the term *item* in a very general sense to refer to some component of the equipment. An item can, in fact, be of any size; the entire aircraft might be viewed as an item, as might any one of its parts. However, the larger and more complex the item, the more unwieldy the set of failure possibilities that must be taken into account. To reduce the problem of analysis to manageable size, it is customary to partition the equipment into three major divisions—systems, powerplant, and structure—each of which involves different areas of engineering expertise. Each division is then partitioned in descending order of complexity, with successively fewer failure possibilities at each level.

The chore now is to sort through the functions and failure possibilities of the various components and eliminate all the obviously nonsignificant items. To ensure that borderline cases and items for which information is lacking will always receive further study, any items eliminated at this stage must be demonstrated to be nonsignificant. Items may be classified as nonsignificant because their functions are unrelated to operating capability or because they are replicated, so that a functional failure would not affect operating capability. Many items can be eliminated because their failures can be repaired quickly and therefore involve no operational consequences. Other items may be ruled out later because they are not candidates for on-condition or safe-life tasks and hence cannot benefit from scheduled maintenance (there is usually no information on the applicability of rework tasks at this time). At this stage, however, all the items that might benefit from scheduled maintenance must be listed for further study.

During the process of classifying items as significant or nonsignificant certain items will be identified that have hidden functions. All these items will require scheduled maintenance regardless of their significance. Although the loss of a hidden function has no direct effect on safety or operating capability, an undetected failure exposes the equipment to the risk of a multiple failure which might have serious consequences. Hence hidden-function items are subjected to the same intensive analysis as significant items.

Note that all items will in fact be included by this procedure, since the partitioning process itself has the following properties:

- ▶ Any item containing a significant item is itself significant.
- ▶ Any nonsignificant item is contained in a higher-level significant item.
- ▶ Any lower-level item contained in a nonsignificant item is itself nonsignificant.

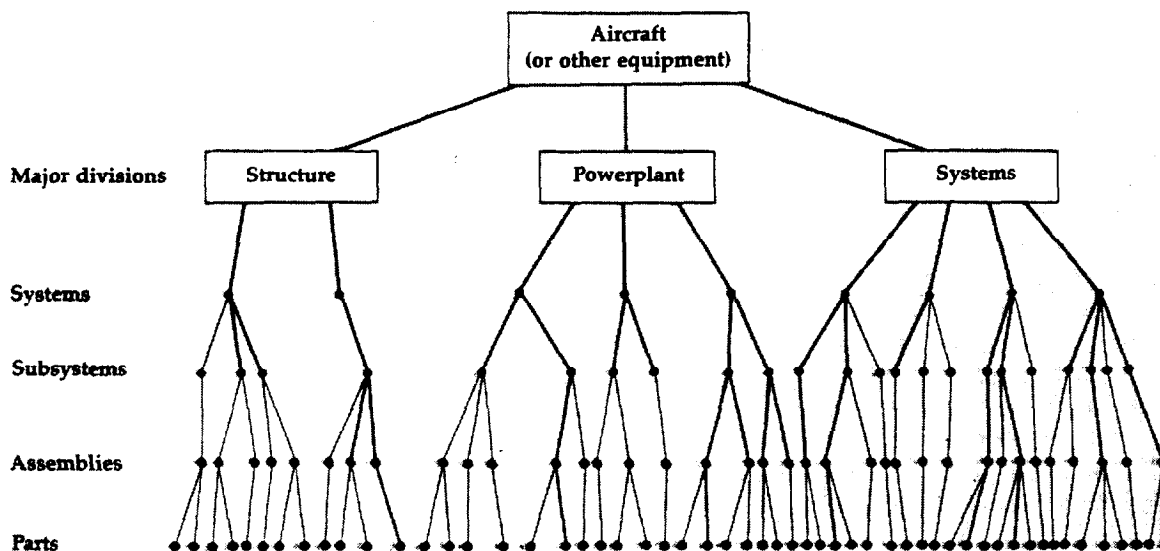
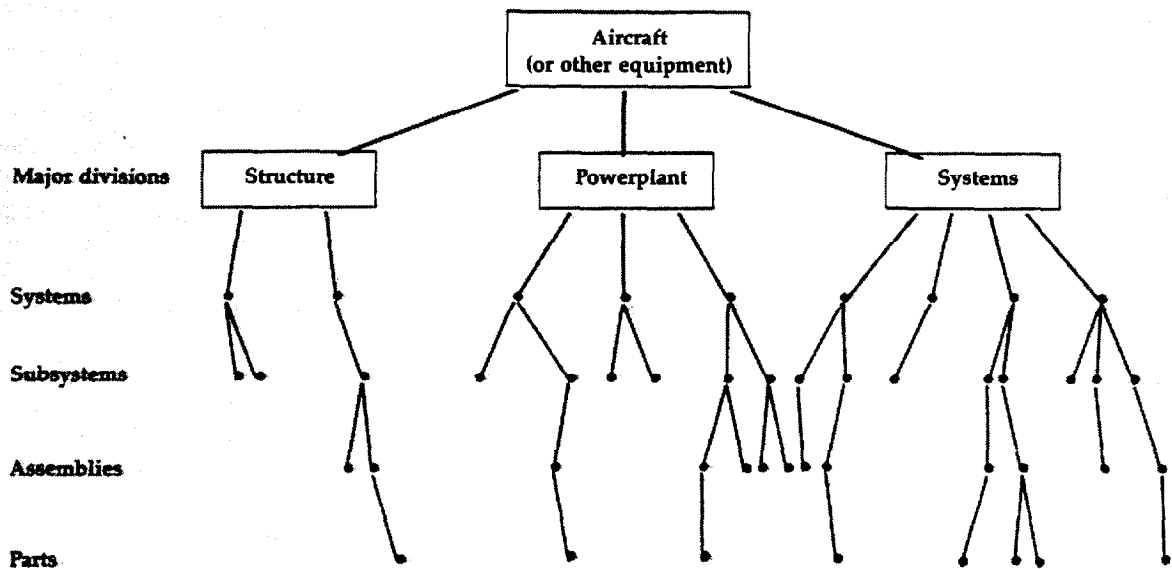

EXHIBIT 4-1 Partitioning an aircraft for preliminary identification of significant items. The equipment is first partitioned to show all items in descending order of complexity. Those items whose failure clearly has no significant consequences at the equipment level are then pruned from the tree, leaving the set of items on which maintenance studies must be conducted. Each significant item will include as failure modes all the failure possibilities it contains.

The objective, however, is to find the most convenient *level* of each system or assembly to classify as significant. The level must be low enough to ensure that no important failure possibilities are overlooked, but high enough for the loss of function to have an impact on the equipment itself, since the consequences of a functional failure are significant only at the equipment level—that is, for the aircraft as a whole.

Once the optimum level of item has been selected for study in each case, we can prune the "tree" back to a set of several hundred potentially significant items with the assurance that any failure possibilities they include at lower levels will be taken into account as failure modes. As an example, consider the engine described in Section 3.1, in which failure of one or more individual tie bolts in a set of 24 was defined as a potential failure. Although this might be viewed as a functional failure of the tie bolt, the failure of a single bolt does not affect engine performance enough to be evident to the operating crew; consequently the tie bolt is not a significant item. It does, however, have a hidden function, and if enough tie bolts failed, the resulting multiple failure



would indeed become evident. The inspection task selected to avoid such a multiple failure would still be the one described in Exhibit 3.2—a check for broken tie bolts. However, viewed from the engine level this is an on-condition task, whereas at the parts level it would be considered a failure-finding task.

In other words, the level of item selected as significant is important only as a frame of reference. Whether we look up at a multiple failure or down at a failure mode, an analysis of all the failure possibilities will ultimately lead to exactly the same preventive task. The chief advantage of the partitioning process is that it allows us to focus intensive study on just a few hundred items instead of many thousands. In an aircraft these items will include some of the parts and assemblies, some subsystems, each of the systems, and each of the major divisions themselves. The parts selected as significant are usually those in which a critical failure mode originates. The structure division represents a special case, since the significant items are specific regions that require scheduled maintenance, rather than whole structural assemblies.

STRUCTURALLY SIGNIFICANT ITEMS

The significant items in each of the major divisions of an aircraft have certain common characteristics which relate to their maintenance requirements. For example, the aircraft structure is a relatively static assemblage of single-celled elements, and except for items such as control surfaces, landing gear, or doors, the only structural movement is deflection under applied loads. However, the structure is subjected to a great many such loads in the course of its operating life. As we saw in Chapter 2, single-celled parts of a mechanism frequently exhibit wear-out characteristics. This is true of metallic structural elements, which are subject to metal fatigue—that is, to a reduction in failure resistance with increasing age.

Another physical process that can lead to the age-related failure of structural elements is corrosion, although the effects of corrosion are much less predictable than those of fatigue. Even minor pitting seriously reduces both static strength and fatigue life, since the loss of load-carrying material correspondingly increases the stress on the rest of the element. Accidental damage has a similar effect in preventing structural components from realizing their inherent fatigue resistance. Thus, although the aircraft structure is designed for a very long fatigue life, it is subject not only to age-related failure in general, but to physical processes that compound the decline in failure resistance with age.

The failure of a major structural assembly which causes the loss of some basic structural function—such as enabling aerodynamic lifting forces to balance the weight of the airplane or providing flight-control surfaces for maneuvering capability—clearly has safety consequences. Moreover, any failures short of a critical failure—failures that do not result in a loss of function to the aircraft—will usually not be evident to the operating crew. The primary consideration in identifying significant structural members, therefore, is the effect that failure of a member has on the residual strength of the remaining assembly, although consideration is also given to susceptibility to corrosion and accidental damage.

The generic term *structurally significant item* (SSI) is used to denote each specific structural region that requires scheduled maintenance to guard against the fracture of a significant member. This region may be defined as a site that includes a number of structural elements, it may be defined as the significant member itself, or it may be a particular region on the member that is the best indicator of its condition. Often such items are the points at which different structural elements are joined; for example, the wing-to-fuselage joint is always listed as a structurally significant item. Most aircraft structure is maintained by on-condition inspections of the regions identified as structurally significant items. These inspections are designed to identify and repair corrosion, fatigue, and other damage at the earliest possible stage, since the replacement of a failed structural element is both difficult and expensive.

FUNCTIONALLY SIGNIFICANT ITEMS

Unlike structural items, most systems are equipped with instrumentation to monitor the performance both of the system as a whole and of individual assemblies within it. As a result, the occurrence of any functional failure in a system is usually evident to the operating crew. Moreover, most systems are designed to be highly redundant, so that the failure of one unit often has no effect on operational capability. Unless a second unit fails, the aircraft is dispatched as usual, and corrective maintenance is simply deferred to a convenient time and location. Thus, although the system as a whole is a *functionally significant item* (FSI), the units that comprise it would be classified as nonsignificant, since their individual failures have no consequences at the equipment level.

Systems items differ in two other ways from structural items. Most systems components are themselves multicelled, or complex; hence their overall reliability shows little or no deterioration with age. Certain metal parts in mechanical systems are subject to fatigue and corrosion, but these are rarely responsible for a dominant failure mode. To meet space and weight requirements, systems components are usually designed with a narrow margin between initial failure resistance and stress. Since they are therefore subject to more frequent failure, the system is usually also designed to facilitate the replacement of failed units. A further distinction between systems and structural items is that certain systems items, such as electrical and electronic components, are characteristically unable to benefit from scheduled maintenance.

Although the powerplant is itself a system, it warrants a category of its own because of its complexity, its high cost, and the critical nature of some of its failure modes. The shutdown of one engine in a multi-engine aircraft has operational, but not safety, consequences. However, the failure of turbine or compressor disks—or any other failures that generate projectiles, cause fires, or leave the engine so that it cannot be shut down—can clearly affect safety. These failure modes are always given careful attention in a maintenance program.

The powerplant can be viewed as a functionally significant item in itself, but the failure characteristics of each of its modules, or major subassemblies, are often quite different from those of the engine as a whole. For example, the collective probabilities of all powerplant failures have little relation to operating age, whereas single important parts may be subject to directly age-related failures. Thus scheduled-maintenance tasks in the powerplant program may include safe-life limits for some items and scheduled rework for others. In as many instances as possible, however, on-condition inspections are employed, both to avoid the consequences of functional failures and to reduce the costs associated with scheduled removals. The powerplant is unique from a maintenance standpoint in that it is designed to permit extensive inspection capability on the aircraft, it can be replaced in a fairly

short time (although unscheduled replacements have operational consequences), and it is subject to extensive shop inspections as well.

In the case of new engines there may be some failure modes that cannot be effectively controlled except by redesign. The occurrence of an unanticipated type of failure in any engine prompts an immediate response on the part of maintenance. The failure consequences are quickly assessed and the engine is examined to determine the cause of the failure. Next, some method is usually devised for inspecting the rest of the engines in service (or the suspect group of engines) for early signs of the same kind of failure. These inspections forestall further failures while the part is being redesigned. The alternative, if the failure is critical and no preventive task can be found, is grounding the fleet until the problem can be solved.

Because items within the powerplant are exposed to many different forms of deterioration, including all those that affect the structure and the various systems, they have no common failure characteristic. Unlike systems items, however, all engine failures have operational consequences and some failure modes have safety consequences. For this reason significant items in the powerplant are identified primarily on the basis of their failure effects. The very complexity of the powerplant results in one further characteristic. Engines are subject to so many failure possibilities that operating data accumulate rapidly, especially with use on multiengine commercial aircraft. This rapid feedback, along with the high cost of corrective maintenance on engines, favors the initial selection of intensive on-condition inspections for powerplant items, since the applicability of age-limit tasks can be investigated before the point at which age-related failures would have any major economic impact.

4·2 THE RCM DECISION PROCESS

evaluation of failure
consequences
evaluation of proposed tasks

The partitioning procedure gives us a conservative first approximation of the items that might benefit from scheduled maintenance. Each of these items must now be examined in detail to determine whether its failure consequences actually qualify it as significant — and if so, whether the item can in fact benefit from scheduled maintenance. Even when the significance of an item is confirmed, there may be no form of preventive maintenance that is applicable and effective. Such items cannot be eliminated from consideration, however, without a full analysis.

EVALUATION OF FAILURE CONSEQUENCES

The consequences of a functional failure depend on both the nature of the function and the nature of the failure. Hence it is necessary to begin the analysis with an accurate list of all the functions demanded of an

item and a clear definition of the conditions that constitute a functional failure in each case. It is also necessary to know the failure modes involved in order to determine the possible effects of each failure. Once this information has been assembled for every item to be examined, we are in a position to evaluate the actual consequences of failure.

As a result of the partitioning process certain items will have been identified that have hidden functions—that is, their failure will not necessarily be evident to the operating crew. The first matter to be ascertained in all cases, however, is whether we will know when a failure has occurred. The following question is necessary, therefore, to ensure that all hidden functions are accounted for:

Is the occurrence of a failure evident to the operating crew during the performance of normal duties?

This question must be asked, not for each item, but for each *function* of the item. The loss of an item's basic function may be evident, but in many cases the item will have secondary or other characteristic functions whose failure will not be evident to the operating crew.

Recall from our discussion in Chapter 2 that any functional failure which has a direct effect on operational capability—including critical failures—will always be evident to the operating crew. If the effects of a failure are not observable, the loss of function has no immediate impact. But by the same token, there is no assurance that the failure will be reported and corrected. Thus if the answer to this first question is no for any function, scheduled maintenance is required for that item. The purpose of the task is not necessarily to prevent failures of the hidden function, but to prevent exposure of the equipment to a multiple failure involving that item.

In the case of a failure that is evident to the operating crew, the consequences might be immediate; we therefore need to know how serious they are likely to be:

Does the failure cause a loss of function or secondary damage that could have a direct adverse effect on operating safety?

This question must be asked for each functional failure and for each *failure mode*. Modern design practices ensure that transport aircraft are exposed to very few critical losses of function. However, certain failure modes, especially in engines, do cause secondary damage that poses a safety hazard. Therefore a yes answer to either aspect of this question means that preventive maintenance is mandatory and can be considered effective only if it prevents all occurrences of this type of failure.

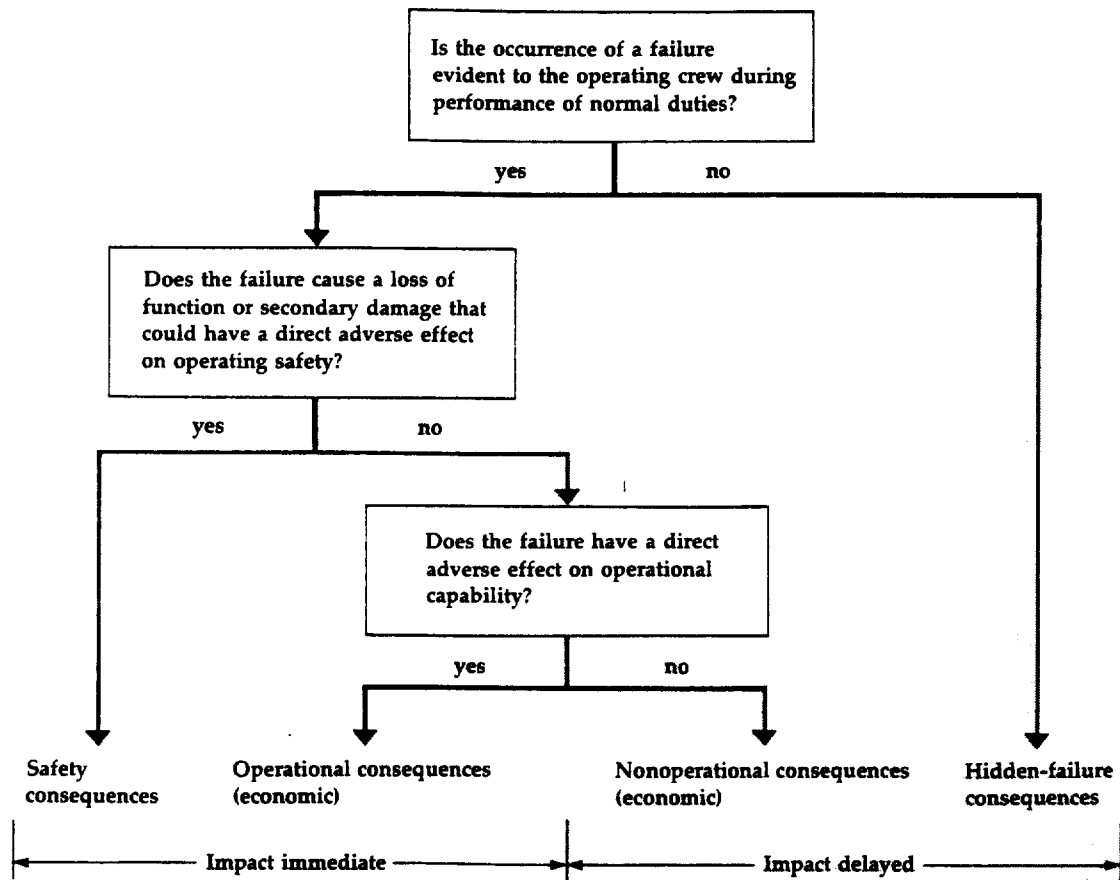

EXHIBIT 4-2 Decision diagram to identify significant items and hidden functions on the basis of failure consequences. Failures that affect safety or operating capability have an immediate impact, since the aircraft cannot be dispatched until they have been corrected. The impact of nonoperational failures and hidden failures is delayed in the sense that correction can be deferred to a convenient time and location.

If the answer to the safety question is no, our next concern is with economic consequences:

Does the failure have a direct adverse effect on operational capability?

The consequences in this case include an immediate interruption of operations, reduced capability if the airplane continues in service, or

the delay or cancellation of subsequent flights to make unscheduled repairs—all of which involve an economic loss beyond the cost of the repairs. In this case, although scheduled maintenance is not required for safety reasons, it may be desirable on economic grounds. Thus if the answer to this question is yes, any applicable preventive tasks must be investigated for cost effectiveness.

If the failure has no direct effect on operational capability, the economic consequences include only the cost of repair. However, certain functional failures may be far more expensive to repair than to prevent, especially in the case of a failure mode that causes extensive damage to surrounding items. Although scheduled maintenance is more likely to prove cost-effective when operational capability is a factor, there are certain failure modes for which it is often desirable to investigate the economic benefits of a preventive task.

The relationship of these three questions and the decision outcomes in each case are illustrated in Exhibit 4.2. This simple decision-diagram approach provides us with the following basic information about each failure possibility:

- ▶ We know whether the failure will be evident, and therefore reported for correction.
- ▶ We know whether its consequences include a possible safety hazard for the equipment or its occupants.
- ▶ We know whether its consequences have a direct effect on operational capability.
- ▶ We know the objective of preventive maintenance in each case, and hence the criterion for evaluating task effectiveness.

With this information we are now in a position to evaluate the maintenance possibilities for each item.

EVALUATING THE PROPOSED MAINTENANCE TASKS

The next phase of RCM analysis involves a systematic study of each failure mode to determine whether one of the four basic maintenance tasks will satisfy both the criteria for applicability and the specific conditions for effectiveness. Since there is a clear order of preference for the first three preventive tasks, we can again use a decision-diagram approach, as shown in Exhibit 4.3.

The first task to be considered for each anticipated failure mode of the item being studied is an on-condition inspection:

Is an on-condition task to detect potential failures both applicable and effective?

If the answer is yes, an on-condition inspection task is put into the program for that failure mode. If we obtain yes answers for all the failure modes of an item, the analysis of that item is complete.

The applicability of an on-condition task can be determined by engineering specialists who are familiar with the design characteristics of the item, the materials used in it, and the inspection technology available. Thus this information will be on hand before the equipment goes into service. At the time an initial maintenance program is developed, however, there may not be enough information to determine whether the task will be effective. In this case we assume that it will be effective and establish the initial inspection intervals according to the

EXHIBIT 4-3 Decision diagram to evaluate proposed scheduled-maintenance tasks. If none of the three directly preventive tasks meets the criteria for applicability and effectiveness, an item whose failures are evident cannot be considered to benefit from scheduled maintenance. If the item has a hidden function, the default action is a scheduled failure-finding task.

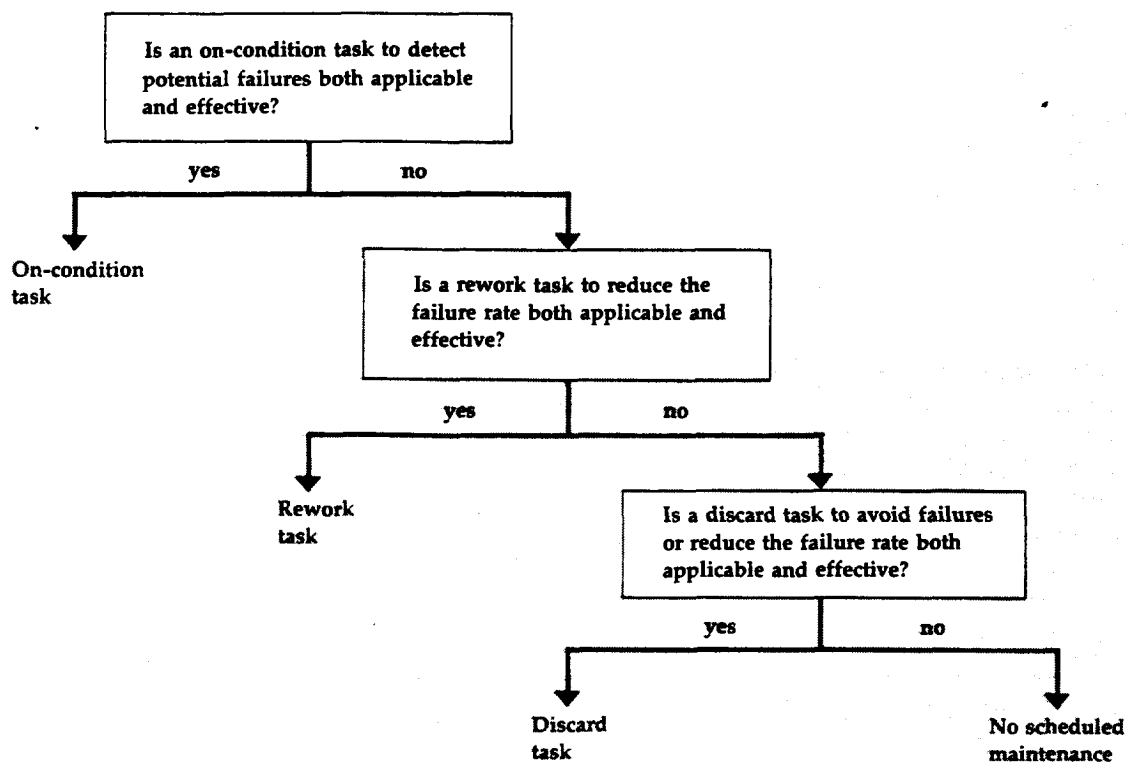

seriousness of the failure consequences. Any applicable inspection task can be made effective in terms of failure prevention if the intervals are short enough, and if operating experience later shows that it is not cost-effective, the task will be deleted from the program at the next review.

If an on-condition task is not applicable for certain failure modes, the next choice is a scheduled rework task:

Is a rework task to reduce the failure rate both applicable and effective?

In this case the question of applicability as well as effectiveness requires an analysis of operating data. Thus, unless the age-reliability characteristics of the item are known from prior experience with a similar item exposed to a similar operating environment, the assumption in an initial program is that an item will *not* benefit from scheduled rework. In the absence of information, the answer to this question is no, and we wait for the necessary information to become available after the equipment goes into service.

A no answer to the rework question brings us to the question of a scheduled discard task:

Is a discard task to avoid failures or reduce the failure rate both applicable and effective?

In an initial maintenance program the only items scheduled for discard will be those for which the manufacturer has specified safe-life limits. The tasks associated with those items are put into the program, but in nearly all other cases the answer at this stage will be no.

4-3 USE OF THE RCM DECISION DIAGRAM

The small decision diagram in Exhibit 4.3 provides the essential mechanism for deciding which, if any, of the preventive-maintenance tasks are both applicable and effective for a particular item. To use this diagram, however, it is necessary to know the failure consequences that determine effectiveness in each case and also dictate the default action to be taken at each decision level.

the full RCM decision diagram
use of the four consequence
branches
the role of the default strategy

THE COMBINED DECISION DIAGRAM

Exhibit 4.4, which brings together the decision questions in Exhibits 4.2 and 4.3, can be used to develop an RCM program either for new equipment or for equipment which is already in service. As we will see in Chapter 5, it can also be used to modify the initial program as new

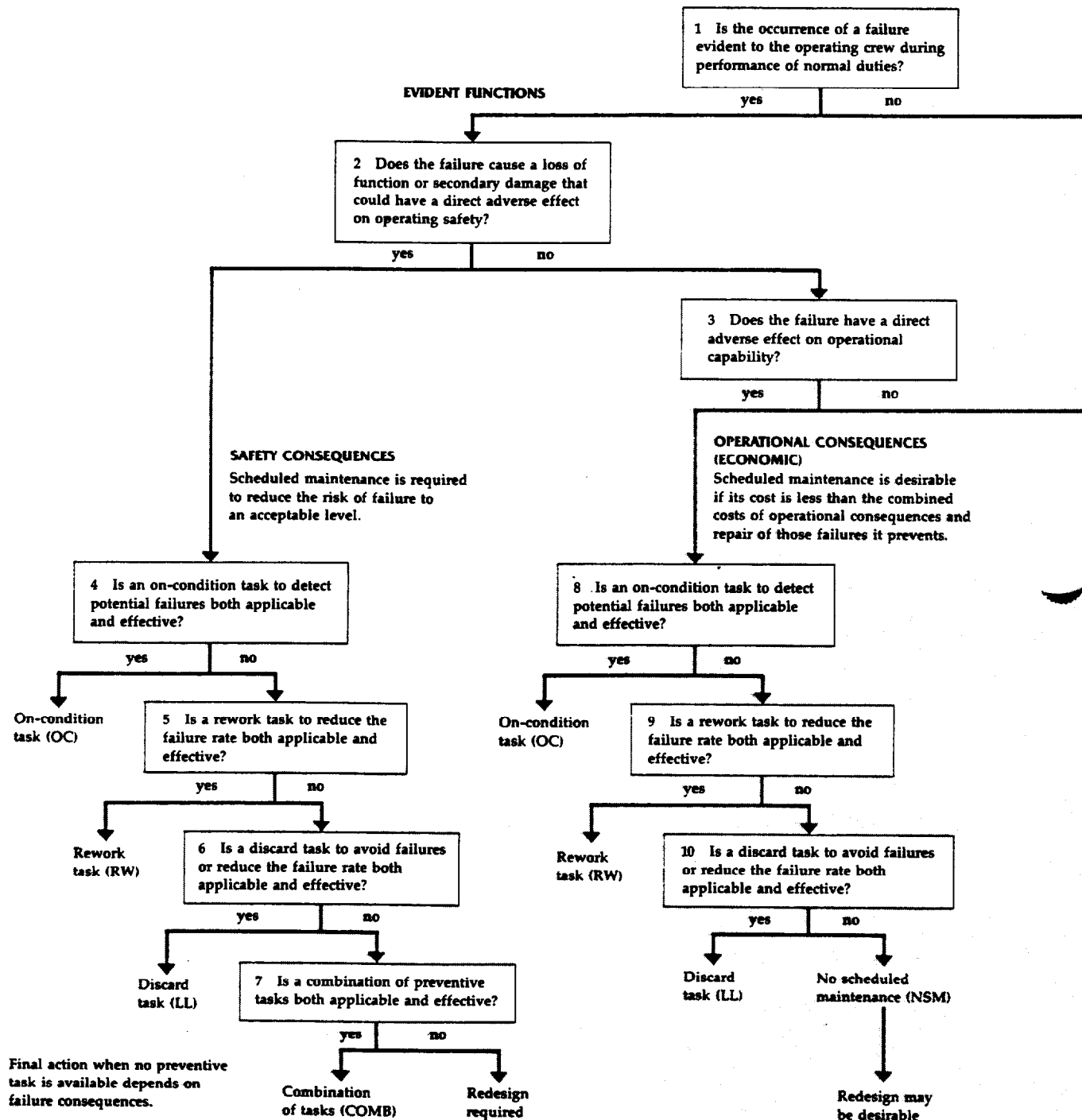
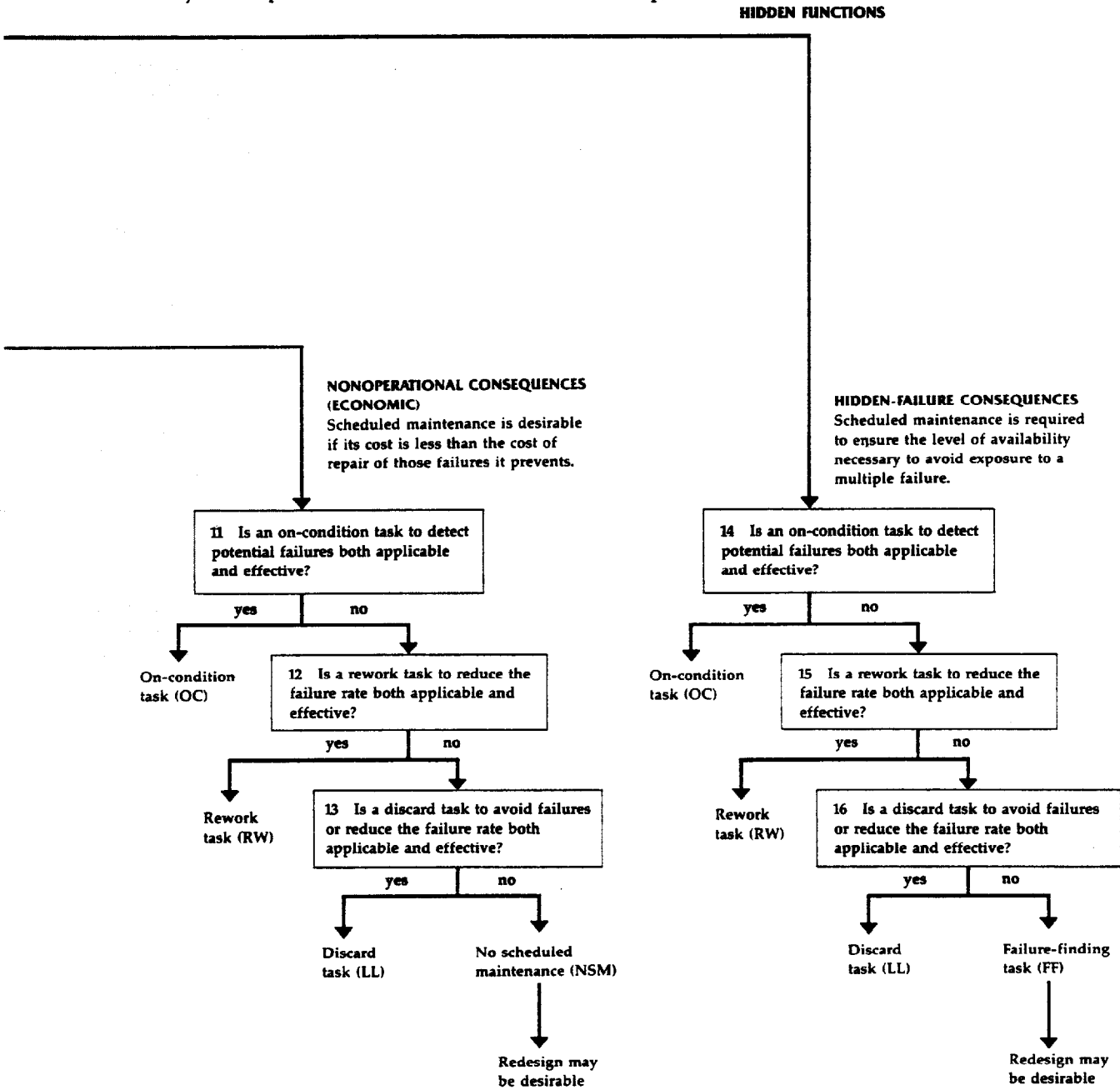

EXHIBIT 4-4 The RCM decision diagram. These questions must be asked for each type of functional failure listed for the item. The first three questions determine the consequences of that failure, and hence the objective of preventive tasks. (F. S. Nowlan and H. F. Heap)



information becomes available. The chapters in Part Two discuss the application of RCM analysis to each of the three major divisions of the aircraft—systems, powerplant, and structures. For the time being, however, let us see how the failure consequences influence the process of task selection.

Consider an item which is subject to a critical failure. The answer to question 1 is yes, since any failure that has a direct adverse effect on operating safety will be evident to the operating crew. (This answer refers, of course, only to a loss of the particular function under consideration.) The answer to question 2 is also yes, since the failure has been stated as critical. All subsequent questions about this failure possibility therefore fall in the safety branch of the diagram. This has two important implications for scheduled maintenance:

- ▶ Scheduled maintenance is *required* if an applicable preventive task can be found.
- ▶ A task can be considered effective only if it reduces the risk of critical failure to an acceptable level.

In the case of transport aircraft the risk must be at a level of extreme improbability to be acceptable, but in the general case an acceptable level does exist. For example, single-engine aircraft are utilized for various civilian and military applications.

Each failure mode that might result in this failure is now examined to determine which of the proposed preventive tasks will accomplish the necessary objective. If an on-condition task is applicable for some failure mode, it can usually be made effective by assigning conservatively short inspection intervals (a yes answer to question 4). If there are failure modes for which on-condition inspection is not applicable, the question of scheduled rework is considered. However, in an initial program the failure data necessary to determine the applicability of such a task are rarely available, and no operating organization can afford the number of critical failures required to provide this information. Thus in the case of a critical-failure mode the answer to question 5 is no.

This brings us to the question of scheduled discard of the item or part in which the critical failure originates—that is, to a safe-life limit. In determining initial program requirements engineering advice may indicate that such a task is applicable. Its effectiveness cannot be evaluated, however, unless a safe-life limit has been established by developmental testing under simulated operating conditions. If a safe-life limit has been established, scheduled discard at this limit is required; if a life limit has not been established for this item, the answer to question 6 is no.

When some failure mode cannot be adequately controlled by any one of the preceding tasks, we have one further recourse:

7 Is a combination of preventive tasks both applicable and effective?

There are occasional circumstances in which a combination of two or more preventive tasks will reduce the risk of critical failure to an acceptable level. In a single-engine aircraft, for example, any and all applicable tasks might be employed to reduce the likelihood of engine failure to the lowest level possible. In most instances, however, this is a stop-gap measure, pending redesign of the vulnerable part. If no combination of tasks can be found that will effectively avoid critical failures in the interim, it may be necessary to restrict operation of the equipment or even to remove it from service.

To return to the top of the decision diagram, suppose the failure of an item has no safety consequences (a no answer to question 2), but it does have operational consequences (a yes answer to question 3). In this event we are concerned only with the *economic* consequences of a functional failure:

- ▶ Scheduled maintenance is *desirable* if its cost is less than the combined costs of operational consequences and repair for those failures it prevents.
- ▶ A task can be considered effective only if it is cost-effective.

In scheduled airlines operational consequences can usually be measured in terms of the inability to deliver service to passengers in a timely fashion. In other operating contexts the cost of lost operational capability might be measured differently. However, a cost can always be imputed to any operational failure in terms of the *opportunity cost* of being unable to use the equipment as planned.

To determine whether a proposed maintenance task is economically desirable, it is necessary to know the imputed cost assigned to the expected operational consequences. In initial programs this will usually be an arbitrary figure based on the benefits anticipated at the time the equipment was purchased. In addition, it is necessary to have some idea of the likelihood of failure, the cost of the proposed task, and the cost of corrective maintenance if the item is allowed to fail. Generally, if the expected failure rate is low and the operational consequences are not excessive, the decision will be to use no scheduled maintenance. As the total cost of failure increases, preventive maintenance becomes more attractive. In most cases it is possible to make a decision without a formal economic-tradeoff study. (Later in the chapter we will examine

a procedure for determining whether an economic-tradeoff study is likely to be worthwhile.)

Where no applicable and cost-effective maintenance task can be found, we must either accept the operational consequences (no scheduled maintenance) or redesign the item to reduce the frequency of failures. This decision ordinarily depends on the seriousness of the operational consequences. If they represent a major economic loss, the default decision is redesign.

If the failure of an item has no operational consequences, the question of task effectiveness is evaluated in direct economic terms:

- ▶ Scheduled maintenance is *desirable* if its cost is less than the cost of repair for those failures it prevents.
- ▶ A task can be considered effective only if it is cost-effective.

Task effectiveness in this case is a simple tradeoff between the cost of prevention and the cost of cure. If both costs are of the same order of magnitude, the decision goes to no scheduled maintenance. The reason for this is that any preventive-maintenance task may disturb the steady-state conditions of the mechanism, and this risk should not be introduced without good cause. Thus a preventive task will be scheduled only where the cost of correcting failed items far outweighs the cost of preventing failures.

Note that many of the items designated for no scheduled maintenance through this decision process might well have been identified at the outset as those which cannot benefit from scheduled maintenance. This branch of the decision diagram, however, permits us to evaluate borderline items which might have benefited from a scheduled task if an applicable one could be found.

In the case of hidden-function items task effectiveness involves two criteria:

- ▶ Scheduled maintenance is *required* to avoid exposure to a possible multiple failure.
- ▶ A task can be considered effective only if it ensures adequate availability of the hidden function.

Some hidden functions are sufficiently important that their availability is protected by periodic checks by the operating crew – that is, they are made evident by defining the normal duties of the crew to cover them. In all other cases, however, scheduled inspections are necessary. Since hidden failures can have no direct effect on safety or operational capability, we can allow such items to fail, but we cannot afford the possible consequences of *undetected* failures. Thus, in the absence of any directly preventive task that is applicable and effective, a specific failure-finding task must always be assigned.

THE ROLE OF THE DEFAULT STRATEGY

The information to be channeled into RCM decisions requires analysis under two different sets of conditions. One is the development of an initial maintenance program on the basis of limited information. The other is modification of these initial requirements as information becomes available from operating experience. As information accumulates, it becomes increasingly easier to make robust decisions. In developing a prior-to-service program, however, there are many areas in which there is insufficient information for a clearcut yes-or-no answer or the study group is unable to reach a consensus. To provide for decision making under these circumstances it is necessary to have a backup default strategy which dictates the course of action in such cases.

The default strategy summarized in Exhibit 4.5 shows for each of the decision questions which answer must be chosen in case of uncertainty. In each case the default answer is based on protection of the equipment against serious consequences. For example, in the process of identifying significant items, if it can be demonstrated that the failure of an item has no effect on safety or operating capability, the item can be classified as nonsignificant and does not warrant further study to see if it can benefit from scheduled maintenance. If there is any doubt, however, it must be classified as significant and cannot be dismissed without further analysis. Similarly, if it is not certain that a loss of function will be evident to the operating crew, it is treated as hidden unless a failure mode involves critical secondary damage.

This default approach can conceivably lead to more preventive maintenance than is necessary. Some tasks will be included as protection against hazards that do not exist, and others may be scheduled far too frequently. The means of eliminating such excessive costs is provided by the age-exploration studies which begin as soon as the equipment goes into service. Through this process the information needed to refine the initial program (and make major revisions where necessary) is gathered systematically for evaluation. We will examine the techniques of age exploration and the nature of the information it provides in the next chapter.

Since an analysis of age-reliability characteristics requires failure data that will not become available until some time after the equipment has been in service, the default strategy will result in a no answer to nearly all questions concerning the applicability and effectiveness of scheduled rework and discard tasks. Consequently, any initial RCM program will consist essentially of on-condition tasks, a few safe-life discard tasks, and failure-finding tasks for hidden-function items, in addition to the usual servicing and lubrication tasks. Scheduled rework or economic-life discard tasks may be added at some later stage, after their applicability and effectiveness can be evaluated, but they rarely appear in an initial program.

EXHIBIT 4-5 The default answers to be used in developing an initial scheduled-maintenance program in the absence of data from actual operating experience.

decision question	default answer to be used in case of uncertainty
IDENTIFICATION OF SIGNIFICANT ITEMS	
Is the item clearly nonsignificant?	No: classify item as significant.
EVALUATION OF FAILURE CONSEQUENCES	
Is the occurrence of a failure evident to the operating crew during performance of normal duties?	No (except for critical secondary damage): classify function as hidden.
Does the failure cause a loss of function or secondary damage that could have a direct adverse effect on operating safety?	Yes: classify consequences as critical.
Does the failure have a direct adverse effect on operational capability?	Yes: classify consequences as operational.
EVALUATION OF PROPOSED TASKS	
Is an on-condition task to detect potential failures applicable?	Yes: include on-condition task in program.
If an on-condition task is applicable, is it effective?	Yes: assign inspection intervals short enough to make task effective.
Is a rework task to reduce the failure rate applicable?	No (unless there are real and applicable data): assign item to no scheduled maintenance.
If a rework task is applicable, is it effective?	No (unless there are real and applicable data): assign item to no scheduled maintenance.
Is a discard task to avoid failures or reduce the failure rate applicable?	No (except for safe-life items): assign item to no scheduled maintenance.
If a discard task is applicable, is it effective?	No (except for safe-life items): assign item to no scheduled maintenance.

stage at which question can be answered		possible adverse consequences of default decision	default consequences eliminated with subsequent operating information
initial program (with default)	ongoing program (operating data)		
X	X	Unnecessary analysis	No
X	X	Unnecessary inspections that are not cost-effective	Yes
X	X	Unnecessary redesign or scheduled maintenance that is not cost- effective	No for redesign; yes for scheduled maintenance
X	X	Scheduled maintenance that is not cost-effective	Yes
X	X	Scheduled maintenance that is not cost-effective	Yes
X	X	Scheduled maintenance that is not cost-effective	Yes
—	X	Delay in exploiting opportunity to reduce costs	Yes
—	X	Unnecessary redesign (safety) or delay in exploiting opportunity to reduce costs	No for redesign; yes for scheduled maintenance
X (safe life only)	X (economic life)	Delay in exploiting opportunity to reduce costs	Yes
X (safe life only)	X (economic life)	Delay in exploiting opportunity to reduce costs	Yes

4·4 DETERMINING COST EFFECTIVENESS

criteria for cost effectiveness
finding a cost-effective interval
the impact of inherent
reliability characteristics

Since a moderate amount of information gathering is necessary for calculations of cost effectiveness, it is helpful to know whether the effort is likely to be fruitful. The decision-diagram approach is also useful in this area. Exhibit 4.6 illustrates one method for deciding whether a detailed assessment of an applicable task might be worthwhile.

Up to this point we have not been concerned about failure rate, since it is not a primary measure of consequences. In the case of critical failures it has no bearing; in fact, the sole objective is to avoid any failures on which to base a rate. Where the consequences are economic, however, the total cost depends on the frequency with which these consequences are likely to occur. The first question in evaluating the cost effectiveness of prevention, therefore, concerns the frequency of functional failures:

Is the functional-failure rate high?

Since it is seldom worthwhile to deal with rare types of noncritical failures, this question rules out items that fail so seldom that the cost of scheduled maintenance would probably be greater than the benefits to be derived from it. The term *high*, of course, is open to interpretation. In airline practice a failure rate greater than 1 per 1,000 hours of flight time is usually considered high, whereas a rate of less than 0.1 per 1,000 hours is usually not considered important. This question is often easier to answer if the failure rate is described in terms of the number of failures per month.

If the failure rate is judged to be high, the next concern is the cost involved. Operational consequences are usually the major cost associated with a high failure rate:

Does the failure involve operational consequences?

Any failure that prevents continued dispatch of the equipment involves operational consequences. However, the extent of the economic loss depends largely on the intended use of the equipment. In a military context, for example, a much higher cost might be imputed to dispatch of an airplane with restrictions on its operating performance than would be the case in a commercial-airline context. If the failure does have operational consequences, the total cost of failure includes the combined cost of these consequences and the cost of repair.

Even when operational consequences are not involved, it may be advantageous to forestall a particularly expensive failure mode:

Does any failure mode cause unusually high repair or operating costs?

This question must be investigated separately, since such failure modes will usually be responsible for only a small fraction of the total number of failures.

EXHIBIT 4-6 Decision diagram for evaluating the probable cost effectiveness of a proposed task when scheduled maintenance is not required to protect operating safety or the availability of hidden functions. The purpose of the decision technique is to reduce the number of formal economic-tradeoff studies that must be performed.

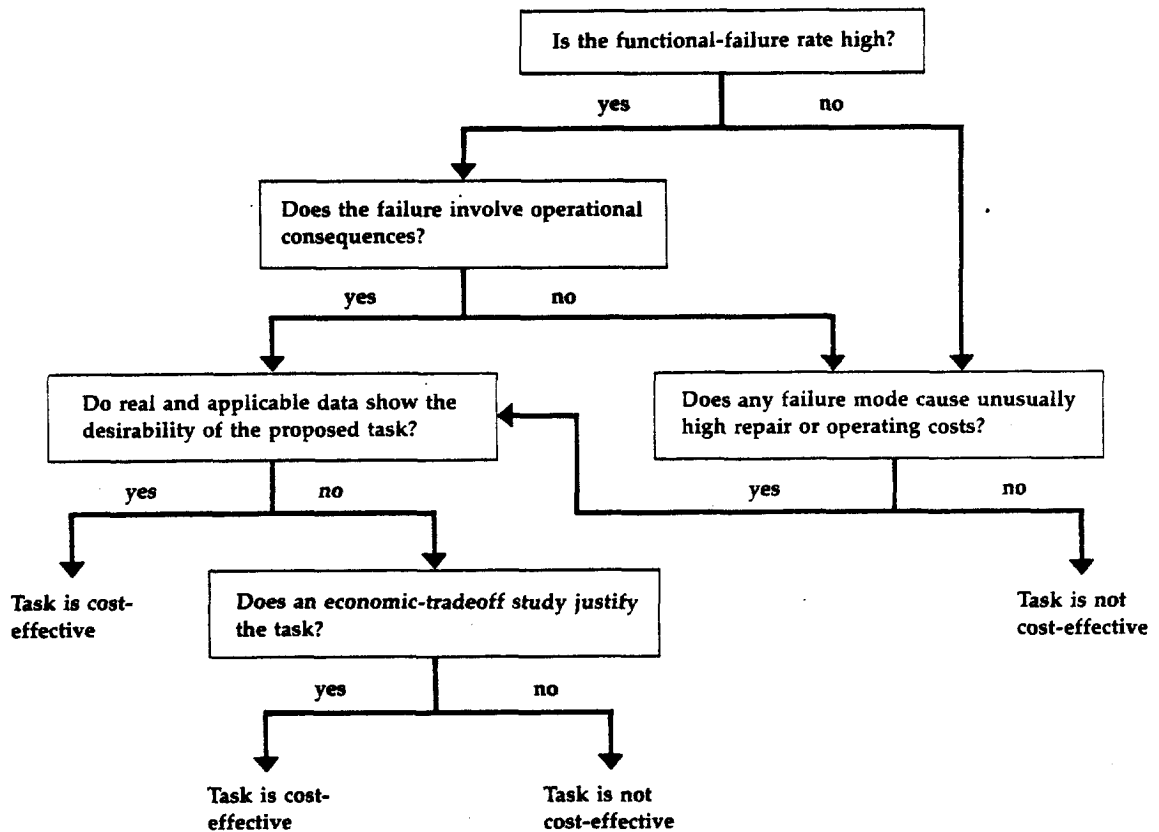

A yes answer to either of the preceding two questions means that we need further information:

Do real and applicable data show the desirability of the proposed task?

It is possible to arrive at a yes answer to this question if there is substantial evidence that this task was cost-effective in the past for this or a similar item. If so, the task can be scheduled without a formal study.

EXHIBIT 4-7 A pro forma for analyzing the support costs associated with scheduled removals for rework. At least four proposed rework intervals must be examined to determine whether a cost-effective interval does exist.

item		
annual volume of operation		
proposed interval		
Number of failures per year ¹	X	
Average base cost of repairing a failed unit ²	<u>\$X</u>	
Annual base cost of repairing failed units		\$X
Number of failures that have operational consequences ³	X	
Average cost of operational consequences after failure	<u>\$X</u>	
Annual cost of operational consequences		\$X
Number of scheduled removals per year	X	
Average base cost for a time-expired unit ⁴	<u>\$X</u>	
Annual base cost for time-expired units		\$X
Number of spare units required to support workload	X	
Cost of unit	<u>\$X</u>	
Annual cost of spare units required		<u>\$X</u>
Total annual support costs ⁴		<u>\$X</u>

- 1 It may be desirable to study a specific expensive failure mode separately.
- 2 Includes cost of removing and installing unit at line station and of transporting it to and from the maintenance base
- 3 The number of failures that have operational consequences may be different from the total number of failures, since not every failure will have such consequences.
- 4 If the change in volume of work at the maintenance base results in changes in facility requirements, the annual cost of such changes should be included in the support costs.

Otherwise the question of economic tradeoff must be evaluated for each of the applicable maintenance tasks:

Does an economic-tradeoff study justify the task?

An economic-tradeoff study involves several steps:

- ▶ An estimate of the incremental effect of the task on the failure rate of the item for several different task intervals
- ▶ A translation of the reduced failure rate into cost reductions
- ▶ An estimate of the cost of performing the proposed task for each of the intervals considered
- ▶ Determination of the interval, if one exists, at which the cost-benefit ratio is the most favorable

Exhibit 4.7 shows a pro forma for evaluating the cost effectiveness of a scheduled rework task. As we saw in Chapter 3, the cost factors for on-condition tasks and scheduled rework tasks are quite different. Scheduled removals increase both the total shop volume and the number of spare units required to replace the units that are undergoing rework. Consequently, unless the frequency of a very expensive failure is materially reduced by an age limit, the total cost of this task will usually outweigh its economic benefits.

In contrast, the total number of potential failures removed as a result of on-condition inspections is not appreciably greater than it would be if each unit were allowed to fail. Moreover, the cost of repairing potential failures is usually less than the cost of repair after a functional failure. As a result, on-condition inspection tasks, when they are applicable, are relatively easy to justify.

The important role of cost effectiveness in RCM decision making helps to clarify the nature of inherent reliability characteristics. The inherent reliability of an item is not the length of time it will survive with no failures; rather, it is the level of reliability the item will exhibit when it is protected by preventive maintenance and adequate servicing and lubrication. The degree of reliability that can be achieved, however, depends on certain characteristics that are a direct result of the design details of the equipment and the manufacturing processes that produced it. These characteristics determine both the need for preventive maintenance and the effectiveness with which it can be provided. Thus from a maintenance standpoint inherent reliability characteristics are decision factors such as those listed in Exhibit 4.8. Note that the answer to each of the questions in Exhibit 4.4 requires a knowledge of at least one of these characteristics.

inherent reliability characteristic	impact on decision making
Failure consequences	Determines significance of items for scheduled maintenance; establishes definition of task effectiveness; determines default strategy when no applicable and effective task can be found
Visibility of functional failure to operating crew	Determines need for failure-finding task to ensure that failure is detected
Ability to measure reduced resistance to failure	Determines applicability of on-condition tasks
Rate at which failure resistance decreases with operating age	Determines interval for on-condition tasks
Age-reliability relationship	Determines applicability of rework and discard tasks
Cost of corrective maintenance	Helps establish task effectiveness, except for critical failures
Cost of preventive maintenance	Helps establish task effectiveness, except for critical failures
Need for safe-life limits to prevent critical failures	Determines applicability and interval of safe-life discard tasks
Need for servicing and lubrication	Determines applicability and interval of servicing and lubrication tasks

EXHIBIT 4-8 Examples of inherent reliability characteristics and their impact on decision making. Each decision question in Exhibit 4.4 requires a knowledge of at least one of these characteristics. In the absence of this knowledge, a default answer must be employed in developing an initial scheduled-maintenance program.

The test of cost effectiveness means that an RCM program will not include some tasks that might reduce the likelihood of noncritical failures. However, when a failure has economic consequences the inclusion of a task that is not cost-effective would merely transfer these consequences from one cost category to another; it would not reduce them. Thus the cost factors on both sides must be considered inherent reliability characteristics, since they dictate the level of reliability that is

feasible for an existing design. Within this framework, RCM analysis ensures all the operating reliability of which the equipment is capable. Moreover, it results in a selection of only those tasks which will accomplish this objective; hence it also provides the required maintenance protection at minimum cost.

Certain of the inherent reliability characteristics of new equipment are unknown at the time a prior-to-service maintenance program is developed. Consequently the initial program is somewhat more expensive than later refinements of it will be (although it is still a minimum-cost program in terms of the information available at the time). This situation is inevitable because of the default decisions necessary to protect the equipment in the absence of full information. It is not too serious a matter, however, because of the relatively slow rate at which fleets of new equipment grow. For example, the Boeing 727 fleet shown in Exhibit 4.9 took six years to reach its maximum size of 150 aircraft. Although the full fleet finally flew more than 400,000 total hours a year, the 20 planes in service by the end of the first year had flown a total of only 34,300 hours. Thus the maintenance costs stemming from these initial default decisions have little overall economic impact and will be materially reduced with the information available by the time the fleet reaches full size.

EXHIBIT 4-9 Examples of fleet growth in a commercial airline. Each purchasing airline has a maximum rate at which it can accept new airplanes, determined by training and staffing requirements. The rate at which new equipment can enter service is highest for large airlines. (United Airlines)

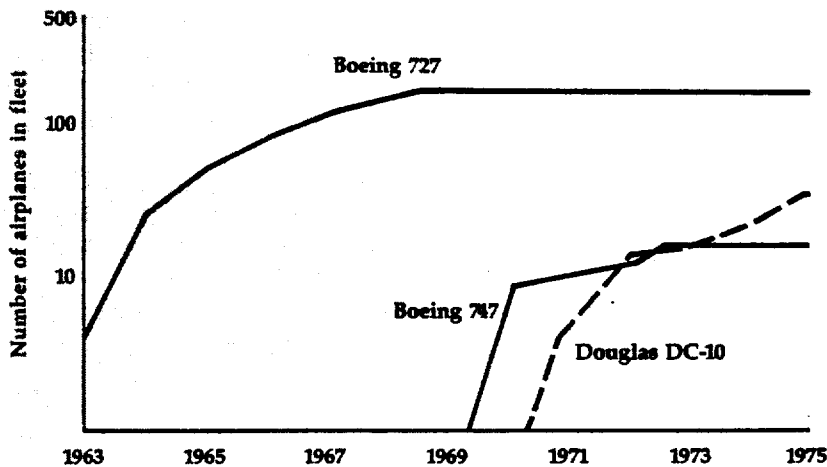

4-5 AGE EXPLORATION

determination of
potential-failure age
opportunity sampling

One of the most important aspects of an initial RCM program is *age exploration* to determine the applicability of certain tasks and the most effective intervals for others. In the case of aircraft this process starts with the manufacturer's certification test flights, during which some of the most frequent types of failures will be identified. If some of these failures have major consequences, product improvement will be initiated before any equipment is delivered to the purchaser. The information obtained during the certification period, however, identifies only those items that have failed—presumably those with a high probability of failure. The entire certification program for a new commercial transport plane requires a total of only 1,500 to 2,000 flight hours accumulated on the five or six planes assigned to the program. The flying time for any one test plane is usually no more than 400 or 500 hours. In contrast, once a plane is put into service, it may fly 300 or more hours a month. At this point we can begin to acquire information on the additional reliability characteristics of the equipment.

As we saw in Section 3.1, the applicability of an on-condition task depends on the ability to measure reduced failure resistance. Its effectiveness, however, depends on the interval between inspections. The same holds true for failure-finding tasks assigned to hidden-function items. For this reason all such tasks are assigned conservatively short intervals in an initial program, and all items whose failure could have safety or major economic consequences are carefully monitored by frequent sample inspections to determine the exact effect of operating age on their condition. The simple metal part illustrated in Exhibit 3.1, for example, would initially be monitored at the intervals shown in Exhibit 4.10 to determine the exact point to be defined as a potential failure, the age at which inspections should start, and the most effective interval between inspections.

Because on-condition inspections play a large role in the maintenance programs for turbine engines, some interesting practices have evolved to reduce the cost of obtaining this information. When an initial program is being developed, experience with earlier types of engines will suggest many parts that might benefit from on-condition tasks, as well as some that might benefit from scheduled rework. Consequently the sample inspections required for age exploration make up a large part of the initial maintenance program for any powerplant.

Some of these inspections can be performed while the engine is installed, but others can be performed only at a major maintenance base after a certain amount of disassembly of the engine. The "on-the-wing"

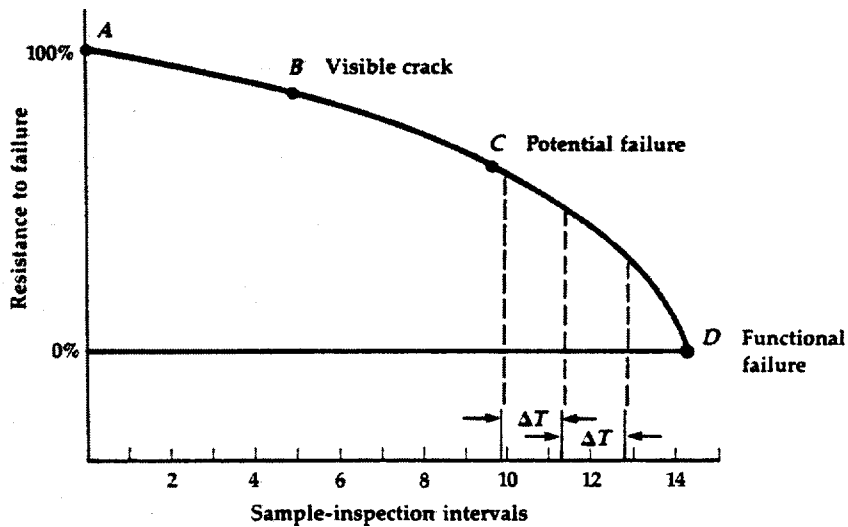

EXHIBIT 4-10 Initial sampling intervals assigned in an age-exploration program to determine the rate at which failure resistance declines. Reduced resistance is not detectable until a visible crack appears; thereafter the rate of crack propagation is monitored to determine the exact point to be defined as a potential failure, the point at which it is necessary to begin on-condition inspections, and the most effective inspection interval to ensure that all failing units will be identified at the potential-failure stage.

inspections are handled by an initial requirement for early inspection of the item on all engines. However, if inspection of the first few engines to reach this limit discloses no unsatisfactory conditions, the limit for the remaining engines is extended. Thus very few engines are actually inspected at any fixed time limit until the point at which it becomes desirable to stop extending the limit.

For those parts that require engine disassembly for inspection, the practice is to define an age limit at which inspection information is considered to be of value. The initial operating age of a part might be limited, for example, to 1,500 hours without inspection, and the threshold age for valid sampling information might be set at 500 hours. This was done for the General Electric CF6-6 engine in the Douglas DC-10. In that case the FAA required inspection of two sets of parts (equivalent to two engines) to justify an increase in the 1,500-hour limit. The initial maintenance program stated that sampling information could be obtained either from one part aged 500 to 1,000 hours and a second part aged 1,000 to 1,500 hours, or else from two parts that were both

aged 1,000 to 1,500 hours. The two sets of part-inspection reports could be based on the inspection of parts in any number of engines.

The reason for this flexibility in scheduling is to take advantage of *opportunity samples*, samples taken from engines that have failed and have been sent back to the main base for repair. Any undamaged parts from these engines can be used to meet the sampling requirements. This procedure makes it unnecessary to schedule engine removals for disassembly solely for the purpose of inspecting parts. Such *forced removals* are necessary only when the required volume of sampling cannot be obtained from opportunity samples. Because new types of engines usually have high failure rates that create abundant opportunity samples, it is possible to make a careful evaluation of the condition of each part before any engines on the aircraft actually age to the initial maximum limit.

On-condition inspections also play the primary role in the maintenance programs for structures. However, unlike powerplants, structure does not provide opportunity samples. The structure is designed as an integral unit, and corrective maintenance on any structural item removes the entire airplane from service. Moreover, because the failure of any major structural assembly is critical, all parts of the structure are designed to survive to very high ages. In the case of structure, therefore, the inspection program itself is the only vehicle for age exploration, and the inspection samples consist of individual airplanes, rather than samples of parts from different airplanes. The initial inspection interval for each structurally significant item is set at only a fraction of the age at which evidence of deterioration is expected to appear, not only to find and correct any conditions that may reduce the anticipated design life, but also to identify the age at which reduced failure resistance first becomes evident.

Whereas powerplant items are continually interchanged and replaced as part of the normal repair cycle, structural members are repaired, but are rarely replaced with new parts. Consequently the age of most parts of a given structure is the same as the total age of the airplane. This makes it possible to concentrate age-exploration activities on the highest total-time airplanes. The first few airplanes to reach the initial limit established for major structural inspections are designated as *inspection samples*. All inspection findings for these airplanes are carefully documented, so that any changes in their condition with age can be identified before younger airplanes reach this age. If there are no signs of deterioration, the starting intervals in the initial program will usually be increased for the remaining airplanes in the fleet.

Age exploration of systems items is conducted on still another basis. Systems items are generally characterized by low reliability; hence they provide abundant opportunity samples. However, because systems failures are rarely critical and so many systems items cannot benefit from

scheduled maintenance, extensive inspection of opportunity samples is usually not justified by the value of the information obtained. In this case the frequency of failures is likely to have greater economic impact than the consequences of individual failures. Thus for systems items age exploration is based primarily on the monitoring and analysis of failure data to determine the cost effectiveness of proposed tasks.

In the following chapter we will examine the many other aspects of the age-exploration process.

4·6 PACKAGING THE MAINTENANCE TASKS

Once each maintenance task in the prior-to-service program has been assigned an appropriate initial interval, either for the purpose of age exploration or on the basis of conservative judgment, the RCM tasks are combined with other scheduled tasks—the servicing and lubrication tasks specified by the manufacturer and the scheduled zonal-installation inspections. All the tasks with similar intervals are then grouped into a number of *maintenance packages*, each with its own interval. The principle is the same as that spelled out in new-car warranties, which specify a certain group of servicing and inspection tasks to be performed every 1,000 miles, another to be performed every 5,000 miles, and so on. For commercial aircraft these intervals range from between-flight checks at every station to major inspections at eight- to ten-year intervals at a maintenance base.

maintenance packages
distribution of maintenance
workload

This grouping results in slightly more frequent performance of some tasks than is strictly necessary, but the additional cost is justified by the increase in maintenance efficiency. Those tasks that are most expensive, both in actual cost and in terms of down time for out-of-service equipment, tend to shape the overall package. Thus if one task must be performed every 1,000 miles and another can be done easily at the same time, they will both be scheduled for that interval. If the second task is required, say, every 2,500 miles, it will be scheduled every other time the first task is done, and so on.

Airlines frequently give each of the major scheduled-maintenance packages an alphabetic designation; hence they are commonly known as *letter checks*. An A check might be performed every 125 hours of flight time, a B check every 900 hours, and so on. Exhibit 4.11 shows the sequence of letter checks as they would occur for an airplane over an operating period of 3,600 hours. The content of a given letter check will not necessarily be the same every time it is performed, since some tasks will come up only at every second or third occurrence of that check. However, the fact that the more extensive packages occur at longer intervals means that as the level of work increases, fewer stations need to be equipped to handle it.

age (flight hours)	work package	age (flight hours)	work package
125	#1 A Check	1,925	#17 A Check
250	#2 A Check	2,050	#18 A Check
375	#3 A Check	2,175	#19 A Check
500	#4 A Check	2,300	#20 A Check
625	#5 A Check	2,425	#21 A Check
750	#6 A Check	2,550	#22 A Check
875	#7 A Check	2,675	#23 A Check
900	#1 B Check ¹	2,700	#3 B Check ³
1,025	#9 A Check	2,852	#25 A Check
1,150	#10 A Check	2,950	#26 A Check
1,275	#11 A Check	3,075	#27 A Check
1,400	#12 A Check	3,200	#28 A Check
1,525	#13 A Check	3,325	#29 A Check
1,650	#14 A Check	3,450	#30 A Check
1,775	#15 A Check	3,575	#31 A Check
1,800	#2 B Check ²	3,600	#1 C Check ⁴

1 Includes #8 A check.

2 Includes #16 A check.

3 Includes #24 A check.

4 Includes #4 B check and #32 A check.

EXHIBIT 4-11 A sample schedule of maintenance packages. Each work package includes all the scheduled tasks to be performed at that interval. The A check includes all tasks scheduled at 125-hour intervals; the B check consists of all tasks scheduled at 900-hour intervals, as well as the A check that would otherwise be performed at that interval; and the C check, scheduled for 3,600-hour intervals, includes all the tasks scheduled for that interval, along with both the A and B checks that would ordinarily take place at that time. The A checks are performed at any of several line-maintenance stations. Planes are routed to a few large maintenance stations for B checks, and C checks are performed at the maintenance base.

for every stop at a line maintenance station, and a #2 service check might be scheduled for every stopover of more than five hours (unless a higher-level package is being performed), and so on.

In addition to the letter checks, which package the expensive or time-consuming tasks, there are a number of smaller service packages. For example, a #1 service check might include those tasks scheduled

The entire scheduled-maintenance program, packaged for actual implementation, must be completed and approved before any new air-

craft can enter service. Up to this point RCM analysis has provided us with a set of tasks based on those reliability characteristics that can be determined from a knowledge of the equipment and the operating context. Once the equipment enters service a whole new set of information will come to light, and from this point on the maintenance program will evolve on the basis of data from actual operating experience. This process will continue throughout the service life of the equipment, so that at every stage maintenance decisions are based, not on an estimate of what the reliability is likely to be, but on the specific reliability characteristics that can be determined at that time.

evolution of the rcm program

IN THE preceding chapters we have examined the framework of RCM analysis and the decision process that leads to the selection of tasks for an initial maintenance program. After the equipment enters service information becomes available about its actual interaction with the operating environment. This information almost certainly contains some surprises—unanticipated types of failures, unexpected failure consequences, unusually high failure rates, or even an absence of anticipated failures. Because the volume of operation is small at first, information is gained at that time about the failures that are likely to occur soonest and with the greatest frequency. As operating time accumulates, the less frequent types of failures are discovered, as well as those that tend to occur at higher operating ages. All this information is used for continuing evolution of the ongoing maintenance program.

Any complex equipment is a failure generator, and failure events will occur throughout its whole operating life. The response to these events depends on the failure consequences. If an unanticipated failure has serious implications for safety, the first occurrence sets in motion an immediate cycle of maintenance and design changes. In other cases waiting until several failures have occurred allows a better assessment of their frequency to determine the economic benefits of preventive tasks, or possibly redesign. Very often waiting until enough failures have occurred to permit an evaluation of age-reliability relationships provides the information necessary to modify the initial maintenance decisions.

Evolution of the scheduled-maintenance program does not consist solely of reactions to unanticipated failures. The information that becomes available—including the absence of failures—is also used for systematic evaluation of all tasks in the initial program. On the basis of actual data, the initial conservative intervals for on-condition inspec-

tions can be adjusted and the applicability of scheduled rework and economic-life tasks can be investigated. Actual operations will frequently confirm the a priori assessments of failure consequences, but occasionally the consequences will be found to be more serious or less serious than anticipated, or a failure thought to be evident to the operating crew is not, and vice versa. The process by which all this information is obtained is called *age exploration*, both because the amount of information is a direct function of the age of the equipment in service and because some of this information relates to the ages of the items themselves.

5·1 THE USES OF OPERATING DATA

It is important to recognize, both in planning a prior-to-service program and at the age-exploration stage, that a fleet of equipment does not materialize overnight. In commercial aviation new planes are delivered to an airline at a rate of one to four a month, and as we saw in Exhibit 4.9, the number of aircraft in service and the associated volume of operations builds up slowly. This allows us to concentrate first on the most frequent failures (since those that occur early will continue to occur early after either delivery or repair) or on those failures with the most serious consequences. As the volume of operations increases, the less frequent failures come to light and can be dealt with later. In a military environment, where operating experience does not accumulate as rapidly, this latter information may be obtained by deliberate heavy use of the first few pieces of equipment—the fleet-leader concept—although the small size of the sample data presents a serious drawback.

the role of age exploration
evolution of the initial program

The reliability information obtained from actual operating experience is quite varied. Although the failure rate plays a role early in operation in pinpointing design problems and evaluating task effectiveness, an age-exploration program is organized to provide the following kinds of information:

- ▶ The types of failures the equipment is actually exposed to, as well as their frequencies
- ▶ The consequences of each failure, ranging from direct safety hazards through serious operational consequences, high repair costs, long out-of-service times for repair, to a deferred need to correct inexpensive functional failures
- ▶ Confirmation that functional failures classified as evident to the operating crew are in fact evident during normal performance of duties
- ▶ Identification of the circumstances of failure to determine whether the failure occurred during normal operation or was due to some external factor, such as bird strike

EXHIBIT 5-1 Summary of the uses of new information in the continuing evolution of the scheduled-maintenance program. After the equipment enters service age exploration and the evaluation of actual operating data continue throughout its entire service life.

refinements of initial maintenance program

results of age exploration

inspection tasks	proposed age-limit tasks	items assigned to no scheduled maintenance
Confirm that reduction in failure resistance is visible.	Determine age-reliability relationship to confirm that conditional probability of failure increases with age.	Monitor and evaluate operational data to see whether some applicable and effective task can be developed.
Determine rate of reduction in failure resistance.		
Confirm or modify defined potential-failure condition.	If failures are age-related, determine whether a cost-effective age limit exists.	
Adjust inspection interval and age for first inspection, if applicable.	If a cost-effective interval can be found, add task to program.	

- ▶ Confirmation that on-condition inspections are really measuring the reduction in resistance to a particular failure mode
- ▶ The actual rates of reduction in failure resistance, to determine optimum inspection intervals
- ▶ The mechanism involved in certain failure modes, to identify new forms of on-condition inspection and parts that require design improvement
- ▶ Identification of tasks assigned as default actions in the initial program which do not prove applicable and effective
- ▶ Identification of maintenance packages that are generating few trouble reports
- ▶ Identification of items that are not generating trouble reports
- ▶ The ages at which failures occur, so that the applicability of scheduled rework and discard tasks can be determined by actuarial analysis

Exhibit 5.1 summarizes the uses of all this information in refining and

major revisions to initial maintenance program		
results of technological change		
unanticipated failure modes or consequences	new or redesigned item	changes in inspection technology
<p>Develop on-condition tasks to prevent critical failures and to prevent or reduce frequency of expensive failures at low ages.</p> <p>Develop design changes necessary for permanent correction of problems.</p> <p>Develop failure-finding tasks for hidden functions not identified in initial program.</p> <p>Develop on-condition or other tasks to control critical or expensive failures at high ages, where product improvement may not be economically justified.</p>	<p>Conduct RCM analysis of item when it first enters service.</p> <p>Refine maintenance requirements through age exploration.</p>	<p>Evaluate applicability and effectiveness of new on-condition techniques.</p>

revising the initial maintenance program. The refinements are useful, but their overall economic impact is usually quite small. The major revisions are associated with unanticipated failures, design modifications, and the exploitation of new inspection technology; in this area far greater economies are realized.

5.2 REACTING TO SERIOUS FAILURES

the preventive-maintenance/
redesign cycle
the improvable failure rate
prediction of reliability
improvement

After new equipment enters service it may experience unanticipated types of failures and failure consequences. The most serious of these are usually in the powerplant and the basic structure. Although such failures can occur at any point in the life of the equipment, they are most likely to occur early in operation. The first failure may have such serious implications for operating safety or economics that all operating organizations and the manufacturer react immediately. Thus there is a structured pattern of events associated with unanticipated failures which results in a characteristic cycle of reliability improvement.

Suppose the unforeseen failure is a critical engine failure. As an immediate step, engineering investigations are undertaken to determine whether some on-condition inspection or other preventive task will be effective. This preventive measure may result in a substantial increase in maintenance costs. With a new engine a large number of engine removals, dictated either by the discovery of potential failures or by scheduled removal of all units, will also make it difficult to provide replacement engines. The next step is action to redesign the parts in which the failure mode originates. When the new parts are available, all the engines in service must then be modified to incorporate the change. Not all design changes are successful, and it may take several attempts over a period of two or three years to correct the problem. Once the problem has been eliminated, the scheduled-maintenance tasks instituted to control this type of failure are no longer necessary and can be discontinued.

Exhibit 5.2 illustrates this cycle. A year after this engine entered service two critical failures occurred during a three-month period. Both failures were found to be caused by notch wear in the third-stage turbine blades. Since this failure mode was also found to be detectable at the potential-failure stage, a line-maintenance on-condition inspection was specified to check for loose turbine blades. Frequent inspection intervals resulted in a large number of engine removals for this condition, but removal of these potential failures prevented any further functional failures. The turbine blade was redesigned, and halfway through the following year modification of the existing engines was started to incorporate the new "low-swirl" blades. The on-condition inspections were continued, but as more and more modified engines

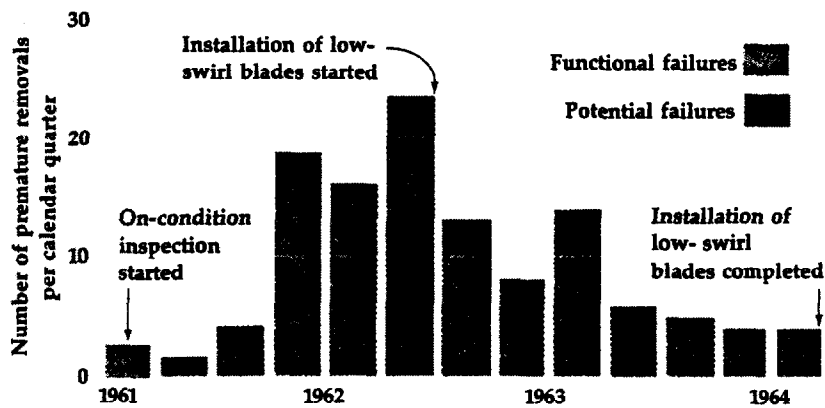

EXHIBIT 5-2 The pattern of events associated with an unanticipated critical failure mode in the Pratt & Whitney JT4 engine. The data represent all engine removals for this failure mode, the first two as functional failures and the rest as potential failures found by an on-condition task developed after the first failure events. These premature removals prevented all further functional failures, and as modified engines entered service, the number of potential failures also decreased. When no further potential failures were found, the on-condition task was deleted from the program. (United Airlines)

entered service, the number of premature removals (potential failures) dropped. Finally, about three years after the first two failures, the on-condition inspections were discontinued.

In new equipment the scheduled-maintenance tasks generated in response to early critical failures are nearly always on-condition inspections. Age-limit tasks are not likely to be feasible, since there are no data for actuarial analysis, and in the case of early failures, taking some fraction of the age at failure as a safe-life limit could easily be ineffective. Moreover, a short safe-life limit might effectively preclude continued operation of the equipment, since it would be difficult to provide the labor and spare parts needed for such intensive maintenance. The definition of an applicable on-condition task, however, may require great ingenuity. The failure mode must be determined, and a specific part that shows physical evidence of reduced failure resistance must be identified. Then some means of inspecting the part while it is still installed must be devised.

Under these circumstances both the potential-failure point and the inspection interval will be established on a very conservative basis. As soon as the on-condition task is implemented, all the equipment in

service is inspected. This first inspection of the fleet often leads to a large number of removals for the newly defined potential failure. The rate of removal after this first inspection will be much lower, of course. It may be low enough to justify increasing the initial conservative inspection interval, but the inspections themselves will be continued until experience has demonstrated that the problem no longer exists.

The cycle for early structural difficulties is similar. Once again, it is necessary to determine the failure mode and devise an on-condition inspection for potential failures. In this case the inspections may be scheduled as often as once every flight cycle or at intervals as long as 2,000 or 3,000 flight cycles. Again, even though the incidence of potential failures turns out to be relatively low after the first fleet inspection, the task itself is continued until the design can be modified.

Serious unanticipated failures do not necessarily occur early in the life of new equipment. At later ages, however, such failures may not lead to design changes. The first response is still the same — the development of new scheduled-maintenance tasks. At this stage the imposition of safe-life limits may be both technically and economically feasible. On-condition tasks may also be applicable, but the inspections can be scheduled to begin at a relatively high age and may have longer intervals. Unless the failure mode is strongly related to age, in which case a life-limit task may be more appropriate, the number of potential failures found by on-condition inspections will be far lower than in relatively new equipment. Depending on the age of the equipment, the cost of redesign may not be warranted, since economic justification depends on the remaining technologically useful life of the equipment.

One further way of coping with failure is to restrict operating procedures to put less stress on a vulnerable component until it can be redesigned. Sometimes the opposite strategy is also useful. When no specific potential-failure condition can be identified, it may be possible to preempt a serious failure by inducing it under other circumstances. In one such case failures of a compressor disk on a tail-mounted turbine engine were occurring at very low ages, and no on-condition inspections were feasible. It was possible to keep the plane in service, however, by requiring the pilot to brake at the end of the runway and apply takeoff thrust with the aircraft stationary. The peak stress on the disk occurred when takeoff thrust was first applied and decreased as the disk warmed up. Thus if the disk did not fail during warmup, it was unlikely to do so during flight. This strategy resulted in several expensive failures, but they were not critical on the ground, whereas the secondary effects of disk failure would have been critical in flight.

A new piece of complex equipment often experiences a high failure rate. Often, too, the majority of these failures result from a small number of failure modes. In the case of aircraft engines the conditional proba-

bilities of such dominant failure modes will frequently increase rapidly with operating age. Exhibit 5.3 shows the results of successive analyses of an engine that entered service in 1964. At that time its initial reliability was poor, the conditional probability of failure was high, and this probability increased rapidly with age. However, the increase was linear and showed no identifiable wearout zone. Within a few months the reliability of this engine was substantially improved by design modifications directed at the dominant failure modes. The initial high failure rate brought the unmodified engines into the shop very frequently, which facilitated fairly rapid incorporation of the modified parts. Consequently the conditional probability of failure continued to drop, and ultimately the reliability of this engine showed no relationship to operating age.

Once the early dominant failure modes in an engine are disposed of, it becomes increasingly difficult to make further improvements. Because of its complexity, the engine will always be subject to many different failure modes, and some may even be dominant. However, the failure probability associated with any given mode is too low to justify further development of the engine. The difference between an item's initial and mature failure rate is its *improvable failure rate* — the

EXHIBIT 5-3 Results of successive age-reliability analyses of the Pratt & Whitney JT8D engine of the Boeing 727. As engineering improvements gradually overcame dominant failure modes, the conditional-probability curve continued to flatten until it eventually showed no relationship of engine reliability to operating age. (United Airlines)

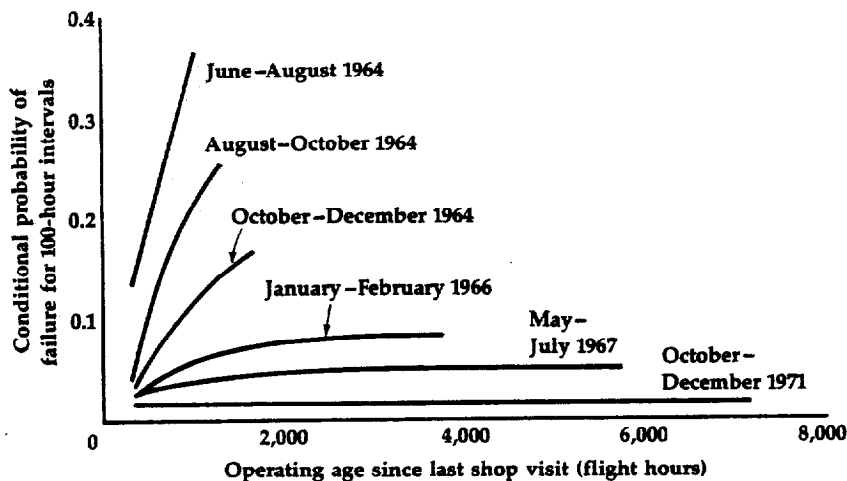

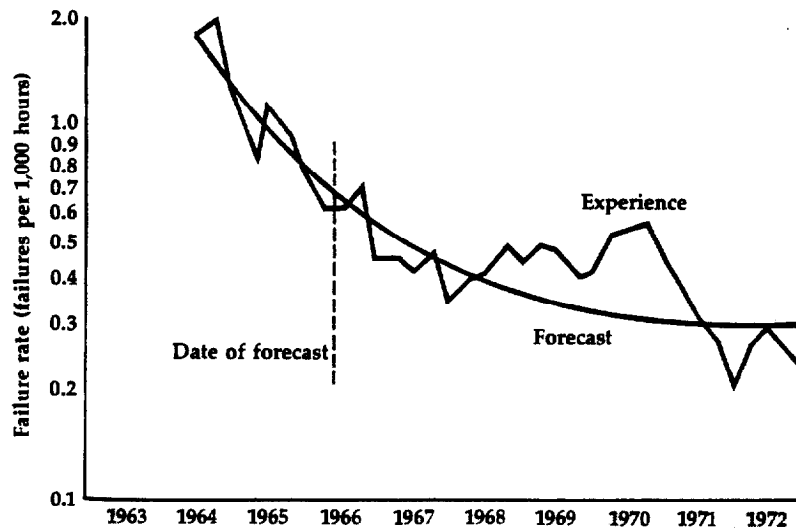

EXHIBIT 5.4 Comparison of actual failure rates of the Pratt & Whitney JT8D engine with a forecast made in December 1965. During initial operation the failure rate based on small samples will show large variations in different calendar periods. However, since reliability improvement is characteristically exponential, it is possible to predict the expected reduction in failure rate over a longer calendar period. The temporary variation from the forecast level in this case was the result of a new dominant failure mode which took several years to resolve by redesign. (United Airlines)

portion that will be eliminated by product improvement. If a particular engine has a failure rate of 2 per 1,000 hours when it first enters service and we anticipate that its failure rate will ultimately drop to 0.3, then the improvable failure rate is 1.7.

In many cases the improvable failure rate declines exponentially over calendar time—that is, the percentage of reduction remains constant, although the amount of reduction becomes smaller as the failure rate is reduced. This percentage has been as much as 40 percent a year for engines in a commercial-airline environment. Such a high degree of improvement is possible only when a large number of engines are in service to generate the failure data required both to direct product improvement and to lower its unit cost. The fact that improvement is characteristically exponential enables us to plot reliability growth in new equipment with a fair degree of success. Exhibit 5.4 shows a comparison of actual failure experience with a forecast that was made in

1965. The forecast was reasonably good until 1968, when a new failure mode became dominant. This problem took nearly three years to resolve, after which the failure rate dropped back to the forecast level.

5·3 REFINING THE MAINTENANCE PROGRAM

The maintenance tasks added in response to unanticipated failures are only one aspect of the age-exploration process. At the time the initial program is developed certain reliability characteristics are unknown. For example, the ability to measure reduced failure resistance can be determined, but there is no information on the actual rate of reduction as various items age in service. Similarly, the information necessary to evaluate cost effectiveness and age-reliability relationships becomes available only after the equipment has been in service for some time. Once the maintenance program goes into effect, the results of the scheduled tasks provide the basis for adjusting the initial conservative task intervals, and as further operating data become available the default decisions made in the absence of information are gradually eliminated from the program.

adjusting task intervals
uses of actuarial analysis

ADJUSTING TASK INTERVALS

As part of the initial program many items are scheduled for frequent sample inspections to monitor their condition and performance, and other tasks are assigned conservatively short initial intervals. All these tasks are then packaged for implementation. If the first few units to reach this check limit show no unsatisfactory conditions, it is safe to assume that the task interval for the remaining units can be extended. Any equipment that has aged to the present check limit is designated a *time-extension sample*.

In many cases, as we saw in Chapter 4, the required number of samples is provided by opportunity samples, units that are available for inspection because they have failed for some reason related to only one failure mode. In the case of engines, for example, the availability of samples of a particular part depends on the number of shop visits occasioned by failures in the section of the engine containing that part. Since a new type of engine is far more likely to experience failures of components in the hot section than in the cold section, the engine data in Exhibit 5.5 show far more opportunity samples for the exit guide-vane assembly than for the compressor assembly. In both cases, however, opportunity sampling provided a means of inspecting these parts as they aged in service. Since there was no great difference between the age of the highest-time installed part and the age of the highest-time sample inspected, it was possible to extend the check limits for both

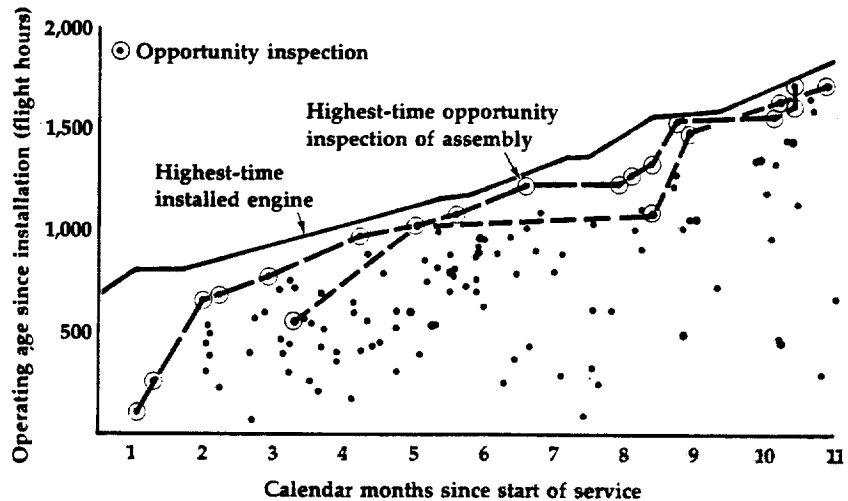

EXHIBIT 5-5 Effectiveness of opportunity sampling of the Pratt & Whitney JT8D engine. Opportunity samples of the exit guide-vane assembly (black) were more abundant than samples of the high-compressor assembly (red), but at every age the highest-time installed unit was only slightly older than the highest-time inspected sample. Thus any unsatisfactory condition detected in the sample would be found before the remaining installed units had reached this age. (United Airlines)

items until the age at which the sample units began to show signs of deterioration.

Task intervals for systems and structural items are ordinarily increased by increasing the interval of the letter-check package in which they have been included. However, if the inspection reports indicate that the interval for some particular task in this package should not be extended, the task must be moved to another package. A task originally assigned to the C-check package, for instance, might be reassigned to the package designated for every second B check. Conversely, there will be tasks whose original intervals now appear far too conservative. In this case the task interval might be increased, say, from C2 to C4 at the same time that the C-check interval itself is being revised upward. The same result can be achieved, of course, by leaving the intervals of all packages fixed and moving all tasks from one package to another.

The management of maintenance packages requires careful planning. First, a schedule is needed for conducting the analysis necessary to support each interval extension. This schedule must allow time for the first few units that have entered service to age to the existing check limit, and also time for the analysis necessary to assess the desirability

of extending the limit. The results of all inspections and corrective work performed on these sample units must be carefully analyzed so that the tasks for which intervals should not be extended can be moved to more compatible packages. Tasks producing marginal results may stay with the original package, but they should be noted for future attention. A hard-time directory is usually maintained to identify tasks for which a maximum interval appears likely. These tasks require closer study than the others, and maintenance planning is facilitated by advance knowledge that they may be moved to a different package in the near future.

USES OF ACTUARIAL ANALYSIS IN AGE EXPLORATION

Whereas serious unanticipated failures prompt an immediate response, action on infrequent failures or those with no major consequences is usually delayed until enough information has been gathered to make a full assessment of possible maintenance remedies. This is particularly true with regard to rework tasks, since these tasks are applicable only if the conditional-probability curve shows that an item has an identifiable wearout zone. Such curves are the result of an actuarial analysis in which the number of failures during various age intervals are measured in terms of the total exposure of the item (total operating time for all units) and the probability of survival to that age interval.

An actuarial analysis does not require hundreds of failure events. A survival curve can be constructed from the data on 20 functional failures, and if necessary, from a sample of 10. However, since it takes several thousand operating hours to accumulate this many occurrences of a given type of failure, there is sometimes concern about a surge of failures as a result of wearout after a certain age. If all the units in service were the same age this might be the case, but because of the slow buildup of a fleet of airplanes, the ages of the units in service are widely distributed. If the item is very reliable at lower ages, and the first failure does not occur until some time after the fleet has reached full strength, the age distribution of the in-service units at that time will be the same as that of the planes in the fleet. This means that there may be a difference of five years or more between the ages of the oldest unit and the newest one. If the item is not that reliable, there will be even fewer high-time units, since many of the units on the older airplanes will be replacements for units that have already failed.

It is this distribution in the ages of in-service units of an item that makes it feasible to use actuarial analysis as a tool for age exploration. If it is found that there is a sharp increase in the likelihood of failure at higher ages, there is ample time to take preventive steps, since very few units are actually approaching the "cliff" when it is discovered. It follows that attention is concentrated on the failure behavior of the oldest units, so that in the event that there is a wearout zone, a rework task

can be added to the maintenance program long before the other units reach this age.

Exhibit 5.6 shows the results of an actuarial analysis conducted to determine whether complete rework of a turbine engine would be an applicable task. The upper curve shows the total conditional probability for all units removed and sent to the shop for corrective work, and the lower curve shows the conditional probability of functional failures as reported by the operating crew. The distance between these two curves at any age represents the conditional probability of potential failures detected by on-condition inspections. It is functional failures that have safety or operational consequences, and the conditional probability of such failures in this case is constant. Since functional failures are independent of the time since engine installation (last shop visit), operating age is not a factor in the failure rate, and a rework task is therefore not applicable.

The conditional-probability curve that includes potential failures does show an increase with increasing age. However, we do not want to reduce the incidence of potential failures except by redesign, since these inspections for potential failures are clearly effective in reducing the number of functional failures. As it is, each engine can remain in operation until a potential failure is detected, and under these conditions

EXHIBIT 5:6 Conditional-probability curves for the General Electric CF6-6 engine of the Douglas DC-10. The upper curve shows the total number of premature removals for both functional and potential failures, and the lower curve shows the number of these units removed as functional failures. Although the rate of potential failures increases with operating age, as a result of effective on-condition inspections the functional-failure rate is kept in check and shows no increase with age. (United Airlines)

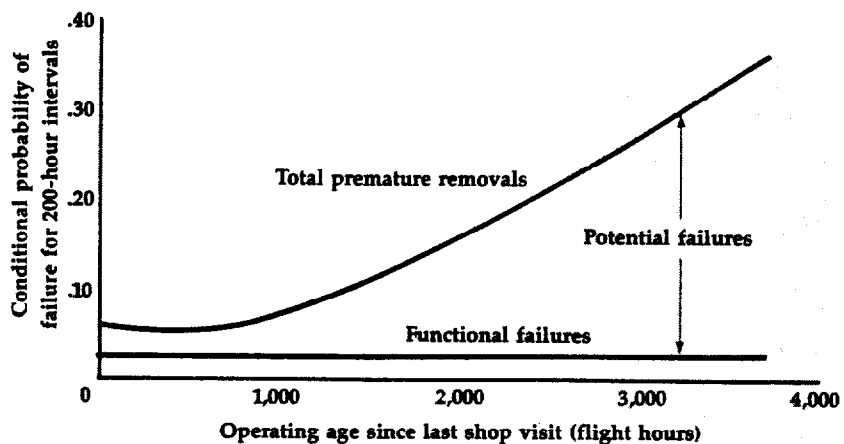

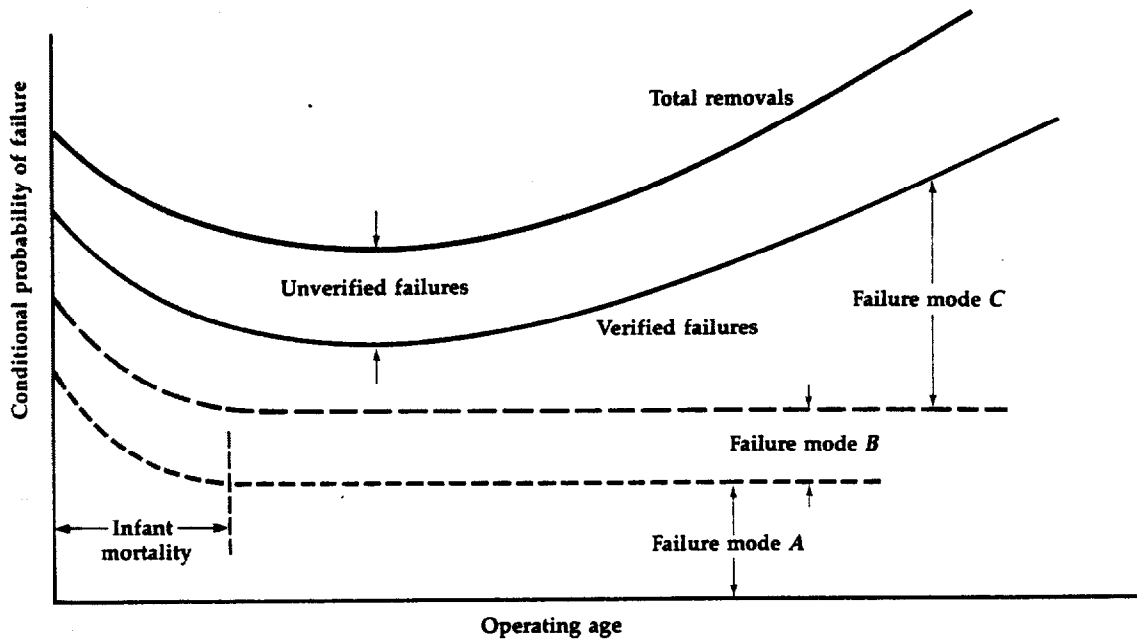

EXHIBIT 5-7 Partitioning of a conditional-probability curve to show the number of unverified failures and the number of verified failures resulting from each of three failure modes. Note that the only high infant mortality occurs from failure mode A; this results in an upturn of the curves above it in a layered representation.

there is no increase in the functional-failure rate with age. Thus the on-condition task itself prevents a wearout zone for functional failures and at the same time permits each engine to realize almost all of its useful life.

The relationship of verified and unverified failures can be examined in the same way to determine the effectiveness of troubleshooting methods. This information is of value to those concerned with stocking and allocating replacement units and spare parts, but it is also important in identifying the actual characteristics of verified failures, so that the failure mode can be pinpointed more exactly and a more accurate potential-failure condition can be defined.

Exhibit 5.7 shows the various age-reliability relationships that can be developed for an item subject to several different failure modes. The upper curve shows the conditional probability for all reported failures, and the curve below it shows the conditional probability of verified failures. The distance between these two curves represents the prob-

ability of unscheduled removals of units that are actually serviceable. Thus the first curve represents the apparent reliability of the item and the second curve represents its actual reliability.

To determine how we might improve the reliability of this item we must examine the contribution of each failure mode to the total of verified failures. For example, failure modes *A* and *B* show no increase with increasing age; hence any attempt to reduce the adverse age relationship must be directed at failure mode *C*. There is also a fairly high conditional probability of failure immediately after a shop visit as a result of high infant mortality from failure mode *A*. The high incidence of early failures from this failure mode could be due to a problem in shop procedures. If so, the difficulty might be overcome by changing shop specifications either to improve quality control or to break in a repaired unit before it is returned to service. In the case of aircraft engines, for example, shop procedures in commercial airlines include a test-cell run at the end of the shop process, during which some engines are rejected and sent back for further work. These test-cell rejects do not appear in the failure count, since this count begins only after the engine is installed on the aircraft.

An actuarial analysis such as that in Exhibit 5.7 can direct improvements toward a great many different areas by indicating which factors are actually involved in the failure behavior of the item. An analysis of the Boeing 727 generator, for example, showed that the conditional probability of generator failure did not increase with age until bearing failures started at an age of 2,000 hours. This failure mode usually results in destruction of the generator. Since a new generator costs about \$2,500, as opposed to \$50 for a bearing replacement, a generator rework task during which the bearing was discarded was both applicable and cost-effective at 4,000-hour intervals.

5.4 REVISIONS IN MAINTENANCE REQUIREMENTS

new diagnostic techniques
design changes

The maintenance tasks instituted in response to serious unanticipated failures are usually interim measures, intended to control the problem until it can be resolved by redesign. Two kinds of technological change, however, may lead to revision of the requirements for scheduled maintenance: the development of new diagnostic techniques and modification of the present equipment.

NEW DIAGNOSTIC TECHNIQUES

Most on-condition inspections are diagnostic techniques, since they measure resistance to failure to identify specific problems. The earliest and simplest technique used for aircraft was visual examination, perhaps aided by a magnifying glass. This visual inspection was extended

by development of the borescope. Numerous other techniques have been developed for detecting cracks in metallic items, such as eddy-current, magnaflux, and zygo inspections. Radiography is also widely employed, not only for detecting cracks, but also to check clearances and changes in configuration without the need to disassemble the item.

A useful diagnostic technique must be able to detect some specific condition that can confidently be defined as a potential failure. It should be sufficiently accurate to identify all units that have reached this condition without including a large number of units for which failure is remote. In other words, such techniques must provide a high power of discrimination. The demand for such discrimination depends in part on the consequences of failure. A technique with low resolving power might be of value for single-engine aircraft if it prevented even a small number of engine failures, despite the fact that it caused numerous unjustified removals. For a multiengine aircraft the same technique would be unnecessary as a safety precaution and undesirable in economic terms.

Certain diagnostic techniques appear to have great potential but will require further development before they can be universally adopted. For example, spectrographic analysis is sometimes used to detect wear in metal parts by measuring the concentration of metallic elements in lubricating oil. In many cases, however, it has been difficult to define a failure condition related to the metal concentrations. Parts have failed without the expected warning, and warnings have not necessarily been associated with imminent failure. Even a change in the brand of oil may necessitate new criteria for interpreting the analysis. Nevertheless, if the failure is one with major consequences, even a low incidence of successful interpretations (and prevented failures) may offset the cost of the inspections that produced no useful information.

Another recent technique is the use of computerized airborne integrated data systems (AIDS), which measure and record the performance characteristics of many items for later study. Some of these characteristics, especially in powerplants, are also monitored by the normal flight instrumentation, but the data are not automatically recorded and integrated with other data. This procedure opens up the possibility of correlating performance trends with the likelihood of failures, or "establishing a signature" for the failure mode. By revealing a previously overlooked indication of reduced resistance to failure, AIDS may make it possible to prevent certain functional failures by on-condition maintenance. The new data systems have in fact assisted in troubleshooting, and they have indicated engine conditions that increase the stress on certain internal parts. However, their success in performing a true (and continuous) on-condition surveillance has so far been limited. Once again, this system may be worthwhile for some organizations if analysis convinces them that the value of its contribution outweighs its costs.

As we have seen, scheduled rework tasks have limited applicability, and discard tasks apply only under rather special circumstances. Major improvements in maintenance effectiveness depend, therefore, on expanded use of diagnostic techniques. The search for additional techniques continues, and the economic desirability of such new developments must be reevaluated from time to time.

DESIGN CHANGES

The product-improvement process is also a factor in changing maintenance requirements, since design modifications may change the reliability characteristics of items either intentionally or otherwise. Hidden functions may be added or removed, critical-failure modes may be added or removed, dominant failure modes and/or age-reliability characteristics may be altered, and redesign may change the applicability of on-condition tasks.

Whenever an item is substantially modified, its maintenance requirements must be reviewed. It may also be necessary to repeat the age-exploration process for such items, both to find out whether the modifications have achieved their intended purpose and to determine how these modifications affect existing maintenance requirements for the item. Finally, entirely new items are added to most equipment during its service life. Initial requirements must be developed for each of these items, to be modified as necessary when operating data on them become available.

5.5 THE PRODUCT-IMPROVEMENT PROCESS

determining the need for product improvement
determining the desirability of product improvement
information requirements
the role of product improvement in equipment development

In the course of evaluating the maintenance requirements of complex equipment many items will be found that cannot benefit from scheduled maintenance, either because there is no applicable preventive task or because the available forms of prevention cannot provide the level of reliability necessary. Because of the inherent conflict between performance requirements and reliability requirements, the reliability problems identified and corrected during early operations are really a part of the normal development cycle of high-performance equipment.

The degree of reliability that can be achieved by preventive maintenance is limited by the equipment itself. Thus a product may be deemed unsatisfactory for any of the following reasons:

- ▶ Exposure to critical failures
- ▶ Exposure to failures that unduly reduce operational capability
- ▶ Unduly high maintenance costs
- ▶ A demonstrated need to make a hidden function visible

Failures may result from the stress and wear associated with the normal operation of the item, or they may be caused by external factors such as lightning strikes, bird ingestion, corrosive environments, and so on. Product improvement to increase resistance to these external factors may be just as necessary as modifications to withstand the effects of the normal operating environment.

DETERMINING THE NEED FOR PRODUCT IMPROVEMENT

Product improvement directed toward better reliability may take a number of forms. An item may be modified to prevent critical failures, to eliminate a particularly expensive failure mode, or to reduce its overall failure rate. The equipment, or an item on it, may be modified to facilitate replacement of a failed unit, to make a hidden function visible, to incorporate features that make on-condition inspections feasible, or to add redundant features which alter the consequences of failure.

Product improvement is expensive. It involves the cost of redesign and the manufacture of new parts or whole new items. The operating organization also incurs the direct cost of modifying the existing equipment and perhaps the indirect cost of taking it out of service while such modifications are being incorporated. Further risks are always introduced when the design of high-performance equipment is changed, and there is no assurance that the first attempt at improvement will eliminate or even alleviate the problem at which improvement is directed. For this reason it is important to distinguish between situations in which product improvement is necessary and those in which it is desirable.

The decision diagram in Exhibit 5.8 is helpful in evaluating the necessity or desirability of initiating design changes. In this case the answers to the decision questions are all based on operating experience. As always, the first consideration is safety:

Does the failure cause a loss of function or secondary damage that could have a direct adverse effect on operating safety?

If the answer to this question is yes, the next concern is whether such failures can be controlled at the maintenance level:

Are present preventive measures effectively avoiding such failures?

If the answer is no, then the safety hazard has not been resolved. In this case the only recourse is to remove the equipment from service until the problem can be solved by redesign. Clearly, product improvement is required.

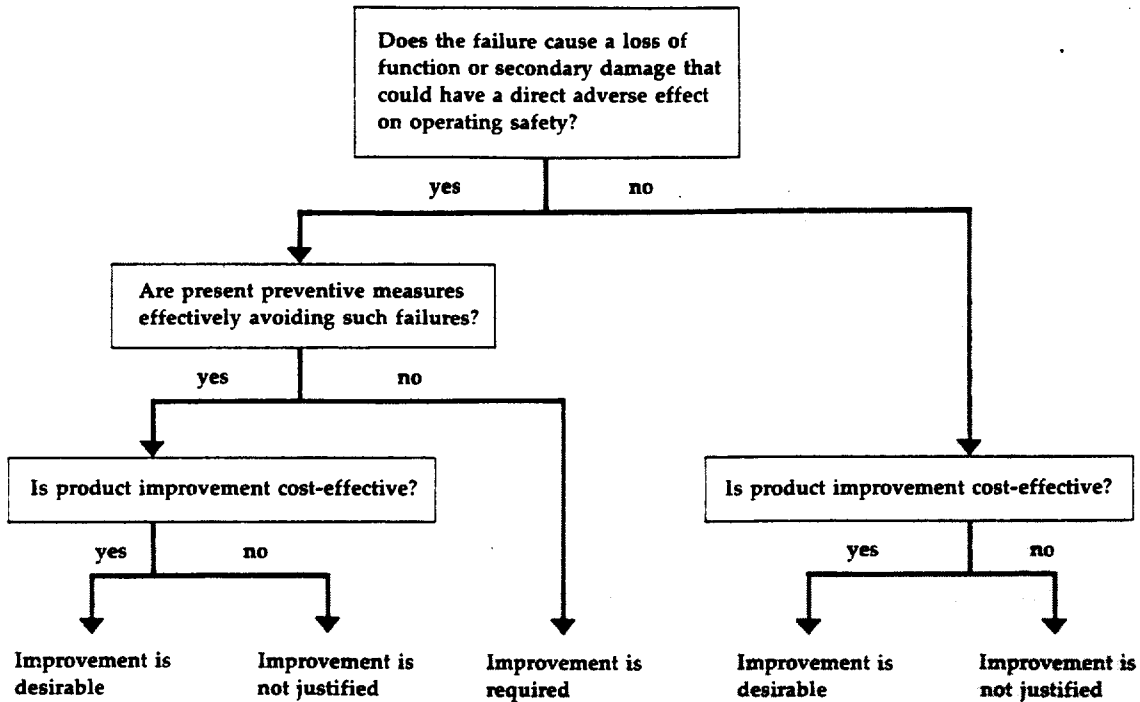

EXHIBIT 5-8 Decision diagram to determine whether product improvement is required or merely desirable if it is cost-effective. Unless product improvement is required for safety reasons, its cost effectiveness must be assessed (see Exhibit 5.9) to determine whether the improvement is in fact economically desirable.

If the present preventive measures are effectively controlling critical failures, then product improvement is not necessary for safety reasons. However, the problem may seriously restrict operating capability or result in unduly expensive maintenance requirements. It is therefore necessary to investigate the possibility of reducing these costs:

Is product improvement cost-effective?

Here we are concerned solely with economics. As long as the safety hazard has been removed, the only issue now is the cost of the preventive measures employed. By the same token, if the answer to the first question was no—that is, the failure has no direct effect on safety—it

may still have costly operational consequences. Thus a no answer to the safety question brings us directly to the question of cost effectiveness.

DETERMINING THE DESIRABILITY OF PRODUCT IMPROVEMENT

There is no hard-and-fast rule for determining when product improvement will be cost-effective. The major variables can be identified, but the monetary values assigned in each case depend not only on direct maintenance costs, but on a variety of other shop and operating costs, as well as on the plans for continuing use of the equipment. All these factors must be weighed against the costs of product improvement.

An operating organization is always faced with a larger number of apparently cost-effective improvement projects than are physically or economically feasible. The decision diagram in Exhibit 5.9 is helpful in ranking such projects and determining whether a proposed improvement is likely to produce discernible results within a reasonable length of time.

The first question in this case concerns the anticipated further use of the equipment:

Is the remaining technologically useful life of the equipment high?

Any equipment, no matter how reliable, will eventually be outmoded by new developments. Product improvement is not likely to result in major savings when the equipment is near the end of its technologically useful life, whereas the elimination of excess costs over a span of eight or ten years of continued service might represent a substantial saving.

Some organizations require for budget approval that the costs of product improvement be self-liquidating over a short period—say, two years. This is equivalent to setting the operational horizon of the equipment at two years. Such a policy reduces the number of projects initiated on the basis of projected cost benefits and ensures that only those projects with relatively high payback are approved. Thus if the answer to this first question is no, we can usually conclude that product improvement is not justified. If the economic consequences of failure are very large, it may be more economical to retire the equipment early than to attempt to modify it.

The case for product improvement is obviously strengthened if an item that will remain in service for some time is also experiencing frequent failures:

Is the functional-failure rate high?

EXHIBIT 5-9 Decision diagram to assess the probable cost effectiveness of product improvement. If a particular improvement appears to be economically desirable, it must be supported by a formal economic-tradeoff study.

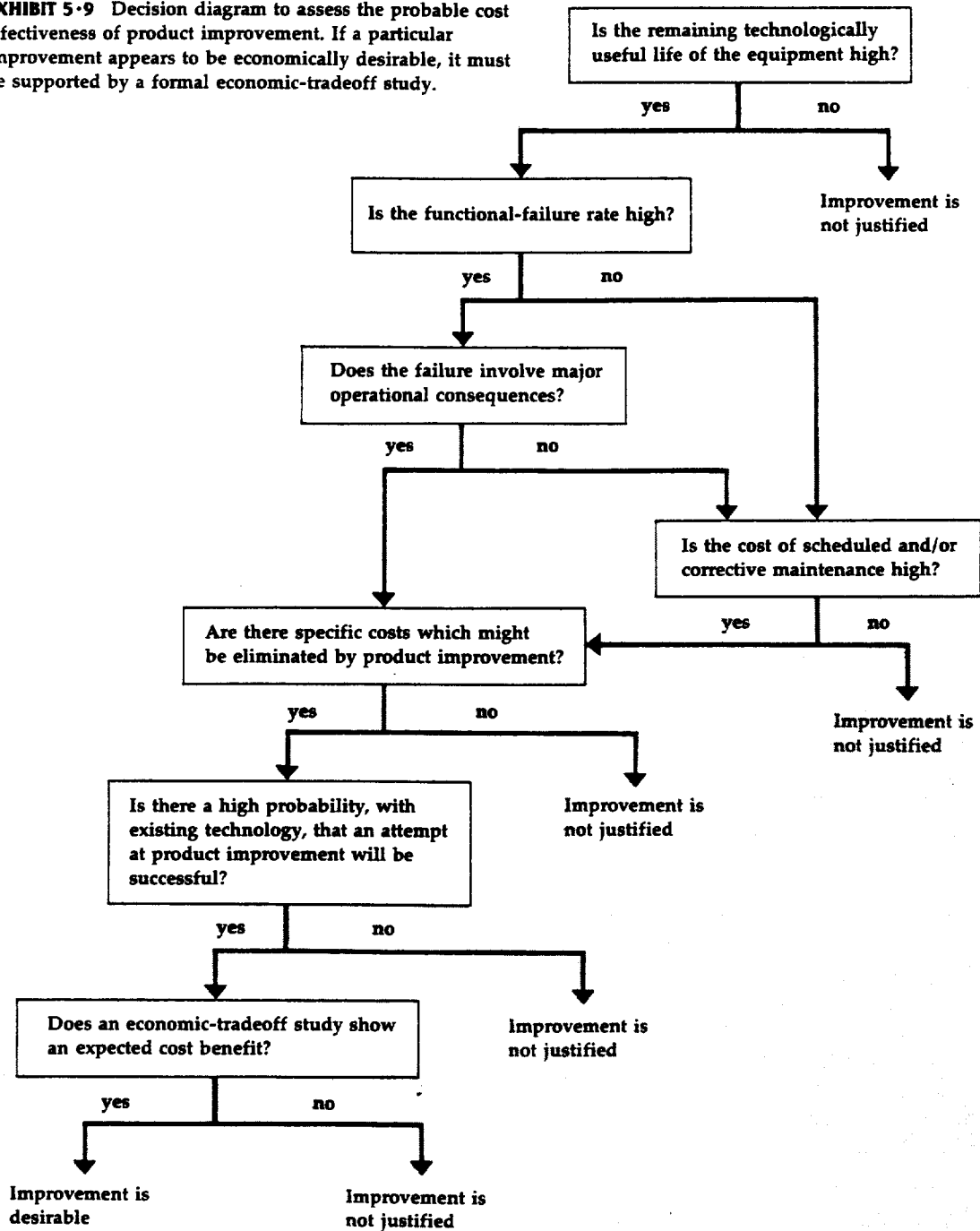

If the answer to this question is yes, we must consider the economic consequences of failure:

Does the failure involve major operational consequences?

Even when the failures have no operational consequences, there is another economic factor to be taken into account:

Is the cost of scheduled and/or corrective maintenance high?

Note that this last question may be reached by more than one path. With a no answer to the failure-rate question, scheduled maintenance may be effectively preventing functional failures, but only at great cost. With a no answer to the question of operational consequences, functional failures may not be affecting operating capability, but the failure mode may be one that results in exceedingly high repair costs. Thus a yes answer to either of the two preceding questions brings us to the question of product improvement:

Are there specific costs which might be eliminated by product improvement?

This question concerns both the imputed costs of reduced operational capability and the more tangible costs associated with maintenance activities. Unless these costs are related to a specific design characteristic, however, it is unlikely that the problem will be eliminated by product improvement. Hence a no answer to this question means the economic consequences of this failure will probably have to be borne.

If the problem can be pinned down to a specific cost element, then the economic potential of product improvement is high. But is this effort likely to produce the desired results?

Is there a high probability, with existing technology, that an attempt at product improvement will be successful?

Although a particular improvement might be very desirable economically, it may not be feasible. An improvement directed at one failure mode may unmask another failure mode, requiring several attempts before the problem is solved. If informed technical opinion indicates that the probability of success is low, the proposed improvement is unlikely to be economically worthwhile.

If the improvement under consideration has survived the screening process thus far, it warrants a formal economic-tradeoff study:

Does an economic-tradeoff study show an expected cost benefit?

The tradeoff study must compare the expected reduction in costs during the remaining useful life of the equipment with the costs of obtaining and incorporating the improved item. The expected benefit is then the projected saving if the first attempt at improvement is successful, multiplied by the probability of success at the first try. Alternatively, it might be considered that the improvement will always be successful, but only a portion of the potential savings will be realized.

There are some situations in which it may be necessary to proceed with an improvement even though it does not result in an actual cost benefit. In this case it is possible to work back through the set of decision questions and determine the values that would have to be ascribed for the project to break even. Also, improvements in the form of increased redundancy can often be justified when redesign of the offending item is not. This type of justification is not necessary, of course, when the in-service reliability characteristics of an item are specified by contractual warranties or when there is a need for improvement for reasons other than cost.

INFORMATION REQUIREMENTS

No manufacturer has unlimited resources for product improvement. He needs to know which modifications to his product are necessary and which are sufficiently desirable for him to risk the cost of developing them. This information must come from the operating organizations, who are in the best position to determine the consequences and costs of various types of failures measure their frequency, and define the specific conditions that they consider unsatisfactory.

Opinions will differ from one organization to another about the desirability of specific improvements, both because of differences in failure experience and because of differing definitions of a failure. A failure with safety consequences in one operating context may have only operational consequences in another, and operational consequences that are major for one organization may not be significant for another. Similarly, the costs of scheduled and corrective maintenance will vary and will also have different economic impacts, depending on the resources of each organization. Nevertheless, the manufacturer must assess the aggregate experience of the various users and decide which improvements will be of greatest value to the entire group.

With any new type of equipment, therefore, the operating organization must start with the following assumptions:

- ▶ Certain items on the equipment will need improvement.
- ▶ Requests for improvement must be supported by reliability and cost data.
- ▶ Specific information on the failure mode must be provided as a basis for redesign.

Critical failures must be reported by a safety-alert system so that all operating organizations can take immediate action against identified safety hazards. Failure with other operational consequences are reported at short intervals so that the cost effectiveness of product improvement can be assessed as soon as possible. The airline industry imputes high costs to delayed or cancelled flights, and these events are usually reported on a daily basis. In military applications it is important that operating data, especially peacetime exercise data, be examined carefully for its implications for operational readiness.

For items whose failure has no operational consequences, the only justification for product improvement is a substantial reduction in support costs. Many of these items will be ones for which there is no applicable and effective form of preventive maintenance. In this case statistical reliability reports at monthly or quarterly intervals are sufficient to permit an assessment of the desirability of product improvement. The economic benefits of redesign will usually not be as great under these circumstances. In general, the information requirements for product improvement are similar to those for management of the ongoing maintenance program. In one case the information is used to determine necessary or desirable design modifications and in the other it is used to determine necessary or desirable modifications in the maintenance program.

THE ROLE OF PRODUCT IMPROVEMENT IN EQUIPMENT DEVELOPMENT

The role of the product-improvement process in the development of new equipment is exemplified by the history of a fleet of Boeing 747's. The first planes in this fleet went into operation in 1970 and the last four planes were delivered in 1973. By April 1976 the airline had issued a total of 1,781 change-order authorizations. Of this total, 85 of the design changes were required by regulatory agencies, 801 were the result of altered mission requirements by the airline, and 895 were required by unsatisfactory reliability characteristics. The cumulative number of these change orders over the first six years of operation is shown in Exhibit 5.10. Most of the change orders to meet regulatory requirements were issued in compliance with FAA airworthiness directives. Such directives mandate specific design changes or maintenance requirements to prevent critical failures. The cumulative number of the 41 directives issued (some entailed more than one change) is shown by the second curve in Exhibit 5.10.

EXHIBIT 5-10 History of change-order authorizations for design improvements in the Boeing 747 (top) and history of FAA airworthiness directives issued over the same time period (bottom). (United Airlines)

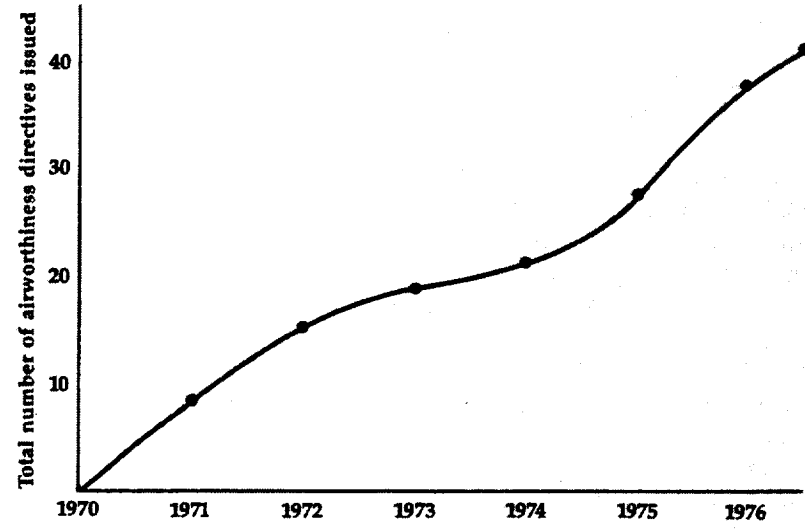
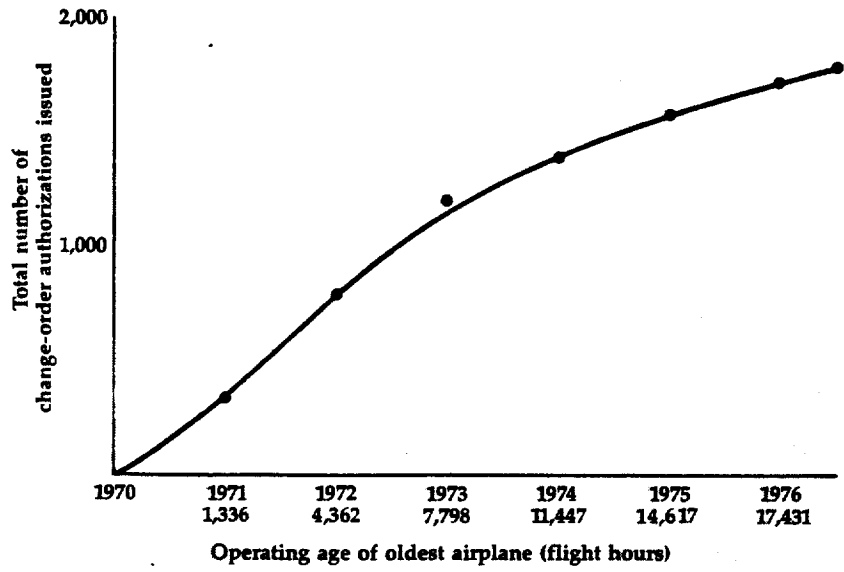

The 895 design changes required to improve reliability characteristics did not include those associated with critical failures. They consisted of the following types of product improvement:

- ▶ Those desirable to prevent or reduce the frequency of conditions causing delays, cancellations, or substitutions (495)
- ▶ Those desirable to improve structural fatigue life and reduce the need for frequent inspection and repairs (184)
- ▶ Those desirable to prevent or reduce the frequency of conditions considered to compromise ground or flight safety (214)

All these changes were based on information gathered from actual operations after the equipment went into service. Such information is an essential part of the development cycle in all complex equipment.

5·6 RCM PROGRAMS FOR IN-SERVICE EQUIPMENT

The decision process outlined in Chapter 4 was discussed in terms of new equipment. However, this procedure also extends to the development of an RCM program for equipment that is already in service and is being supported by a scheduled-maintenance program developed on some other basis. In this case there will be much less need for default answers, since considerable information from operating experience is already available. For example, there will be at least some information about the total failure rate of each item, the actual economic consequences of various kinds of failures, what failure modes lead to loss of function, which cause major secondary damage, and which are dominant. Many hidden functions will have been identified, and there may be information on the age-reliability characteristics of many items.

use of available information
expected benefits

Preparation for the program will still require a review of the design characteristics of the equipment to define a set of significant functions and functional failures. The usual result will be that items currently treated individually can be grouped as a system or subsystem to be considered as one significant item in the new program. A set of proposed maintenance tasks will have to be established which includes all those existing tasks that satisfy the applicability criteria; additional tasks may then be introduced if they also meet these requirements. The tasks would then be analyzed for effectiveness in terms of failure consequences, as with a prior-to-service program.

The new RCM program should be developed with minimal reference to the existing program, and the two programs should not be compared until the proposal for the new one is complete. This is essential

to avoid the influence of past biases and to allow for free exercise of the decision structure. When a comparison is finally made, the new RCM program will generally have the following features:

- ▶ Many systems and subsystems will be classified as significant items.
- ▶ There will be a smaller number of equipment items for which unique scheduled-maintenance tasks are specified.
- ▶ Most systems items will no longer be subject to scheduled rework.
- ▶ Turbine engines and other complex items will be subject to a few specific rework or discard tasks, rather than intensive scheduled overhaul.
- ▶ There will be age-exploration sampling of certain identified parts of the powerplant, which is continued until the parts reach very high ages.
- ▶ There will be increased use of on-condition tasks.
- ▶ There will be some new tasks that are justified by critical-failure modes, operational consequences, or hidden functions.
- ▶ The intervals of higher-level maintenance packages will be greatly increased, whereas intervals of lower-level packages, which consist primarily of servicing tasks and deferrable corrective work, will remain about the same.
- ▶ The overall scheduled-maintenance workload will be reduced.

If the existing program assigns a large number of items to scheduled rework, there may be some concern that eliminating these tasks will result in a substantial increase in the failure rate. This question can be resolved by conducting actuarial analyses of the failure data for these items under the new program, to confirm that the change in maintenance policy has not adversely affected their overall reliability. If these analyses show that rework tasks are both applicable and effective for some items, they can be reinstated.

The new RCM program will not be as labor-intensive as the program it replaces, and this fact will have to be taken into account in adjusting staff requirements at maintenance facilities. It may be necessary to estimate the volume of work that has been eliminated in each maintenance package and make these adjustments when the new program is first implemented. Otherwise the anticipated reductions in manhours and elapsed time for scheduled maintenance will often not be realized.

PART TWO

applications

applying rcm theory to aircraft

THE REASONING behind RCM programs was described in detail in Part One. In the following chapters we will examine specific applications of these principles to actual equipment hardware. Although the examples discussed are drawn from commercial transport aircraft, they provide practical guidelines that easily extend to other operating contexts and to the development of scheduled-maintenance programs for other types of complex equipment. The principle distinction in the case of aircraft has to do with design practices that are common to the aircraft industry.

In the case of commercial aircraft continuous evolution of the design requirements promulgated by airworthiness authorities and the feedback of hardware information to equipment designers by operating organizations have led to increasing capability of the equipment for safe and reliable operation. Thus most modern aircraft enter service with design features for certain items that allow easy identification of potential failures. Similarly, various parts of the airplane are designed for easy access when inspection is necessary or for easy removal and replacement of vulnerable items. A host of instruments and other indicators provide for monitoring of systems operation, and in nearly all cases essential functions are protected by some form of redundancy or by backup devices that reduce the consequences of failure to a less serious level.

Complex equipment that has not benefited from such design practices will have different—and less favorable—reliability characteristics, and therefore less capability for reliable operation. Since preventive maintenance is limited by the inherent characteristics of the equipment, in many cases RCM analysis can do little more than recommend the design changes that would make effective maintenance feasible.

The principles of reliability-centered maintenance still apply, and the decision questions are the same. The answers to these questions, however, must reflect the design characteristics of the equipment itself and hence will be different for equipment designed to other standards.

In this chapter we will briefly review certain aspects of RCM analysis, examine the procedures for setting up a study team to develop a prior-to-service program, and consider some of the factors involved in monitoring the RCM program as it evolves after the equipment enters service.

6·1 A SUMMARY OF RCM PRINCIPLES

The complexity of modern equipment makes it impossible to predict with any degree of accuracy when each part or each assembly is likely to fail. For this reason it is generally more productive to focus on those reliability characteristics that can be determined from the available information than to attempt to estimate failure behavior that will not be known until the equipment enters service. In developing an initial program, therefore, only a modest attempt is made to anticipate the operating reliability of every item. Instead, the governing factor in RCM analysis is the impact of a functional failure at the equipment level, and tasks are directed at a fairly small number of *significant items* – those whose failure might have safety or major economic consequences. These items, along with all hidden-function items, are subjected to intensive study, first to classify them according to their failure consequences and then to determine whether there is some form of maintenance protection against these consequences.

significant items
analysis of failure consequences
evaluation of proposed tasks
the default strategy

The first step in this process is to organize the problem by partitioning the equipment into object categories according to areas of engineering expertise. Within each of these areas the equipment is further partitioned in decreasing order of complexity to identify significant items (those whose failure may have serious consequences for the equipment as a whole), items with hidden functions (those whose failure will not be evident and might therefore go undetected), and non-significant items (those whose failure has no impact on operating capability). As this last group encompasses many thousands of items on an aircraft, this procedure focuses the problem of analysis on those items whose functions must be protected to ensure safe and reliable operation.

The next step is a detailed analysis of the failure consequences in each case. Each function of the item under consideration is examined to determine whether its failure will be evident to the operating crew; if not, a scheduled-maintenance task is required to find and correct hidden failures. Each failure mode of the item is then examined to determine whether it has safety or other serious consequences. If safety is involved, scheduled maintenance is required to avoid the risk of a critical failure. If there is no direct threat to safety, but a second failure in a chain of events would have safety consequences, then the first failure must be corrected at once and therefore has operational consequences. In this case the consequences are economic, but they include the cost of lost operating capability as well as the cost of repair. Thus scheduled maintenance may be desirable on economic grounds, provided that its cost is less than the combined costs of failure. The consequences of a nonoperational failure are also economic, but they involve only the direct cost of repair.

This classification by failure consequences also establishes the framework for evaluating proposed maintenance tasks. In the case of critical failures—those with direct safety consequences—a task is considered effective only if it reduces the likelihood of a functional failure to an acceptable level of risk. Although hidden failures, by definition, have no direct impact on safety or operating capability, the criterion in this case is also risk; a task qualifies as effective only if it ensures adequate protection against the risk of a multiple failure. In the case of both operational and nonoperational failures task effectiveness is measured in economic terms. Thus a task may be applicable if it reduces the failure rate (and hence the frequency of the economic consequences), but it must also be cost-effective—that is, the total cost of scheduled maintenance must be less than the cost of the failures it prevents.

Whereas the criterion for task effectiveness depends on the failure consequences the task is intended to prevent, the applicability of each form of preventive maintenance depends on the failure characteristics of the item itself. For an *on-condition task* to be applicable there must be a definable potential-failure condition and a reasonably predictable age

interval between the point of potential failure and the point of functional failure. For a scheduled *rework task* to be applicable the reliability of the item must in fact be related to operating age; the age-reliability relationship must show an increase in the conditional probability of failure at some identifiable age (wearout) and most units of the item must survive to that age. The applicability of *discard tasks* also depends on the age-reliability relationship, except that for safe-life items the life limit is set at some fraction of the average age at failure. *Failure-finding tasks* are applicable to all hidden-function items not covered by other tasks.

EXHIBIT 6-1 Schematic representation of the RCM decision structure. The numbers represent the decision questions stated in full in Exhibit 4.4, and the abbreviations represent the task assigned or other action taken as an outcome of each decision question.

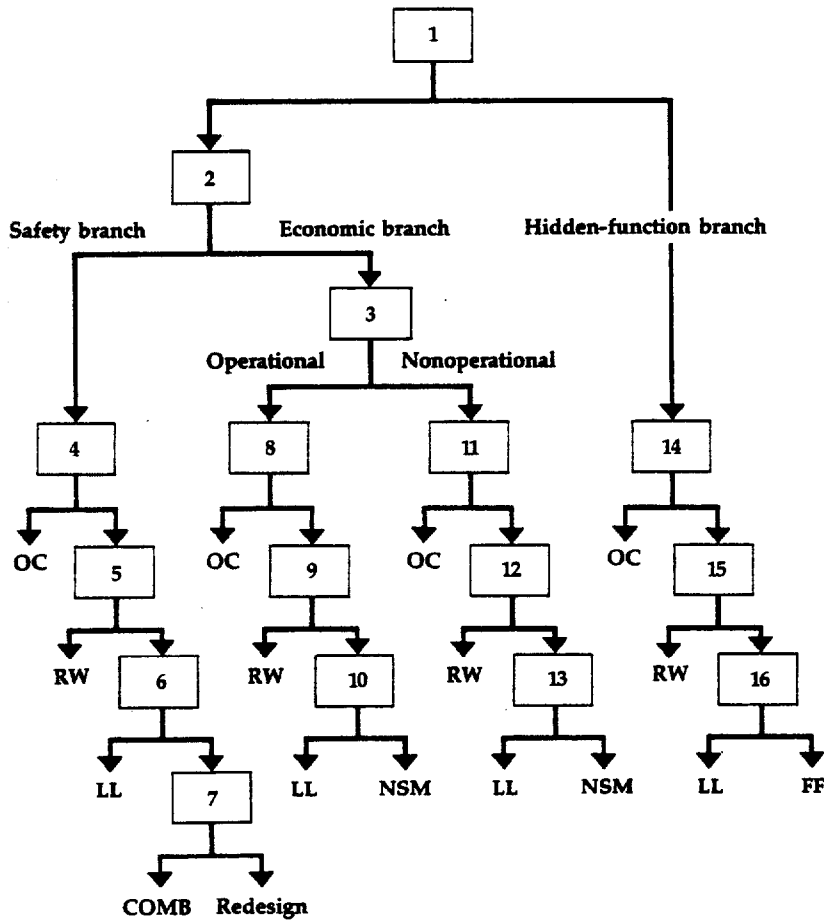

The process of developing an RCM program consists of determining which of these scheduled tasks, if any, are both applicable and effective for a given item. The fact that failure consequences govern the entire decision process makes it possible to use a structured decision-diagram approach, both to establish maintenance requirements and to evaluate proposed tasks. The binary form of a decision diagram allows a clear focus of engineering judgment on each issue. It also provides the basic structure for a default strategy – the course of action to be taken if there is insufficient information to answer the question or if the study group is unable to reach a consensus. Thus if there is any uncertainty about whether a particular failure might have safety consequences, the default answer will be yes; similarly, if there is no basis for determining whether a proposed task will prove applicable, the answer, at least in an initial maintenance program, will be yes for on-condition tasks and no for rework tasks.

It is important to realize that the decision structure itself is specifically designed for the need to make decisions even with minimal information. For example, if the default strategy demands redesign and this is not feasible in the given timetable, then one alternative is to seek out more information in order to resolve the problem. However, this is the exception rather than the rule. In most cases the default path leads to no scheduled maintenance, and the correction, if any, comes naturally as real and applicable data come into being as a result of actual use of the equipment in service.

The decision logic also plays the important role of specifying its own information requirements. The first three questions assure us that all failures will be detected and that any failures that might affect safety or operating capability will receive first priority. The remaining steps provide for the selection of all applicable and effective tasks, but only those tasks that meet these criteria are included. Again, real data from operating experience will provide the basis for adjusting default decisions made in the absence of information. Thus a prior-to-service program consists primarily of on-condition and sample inspections, failure-finding inspections for hidden-function items, and a few safe-life discard tasks. As information is gathered to evaluate age-reliability relationships and actual operating costs, rework and discard tasks are gradually added to the program where they are justified.

The net result of this careful bounding of the decision process is a scheduled-maintenance program which is based at every stage on the known reliability characteristics of the equipment in the operating context in which it is used. In short, reliability-centered maintenance is a well-tested answer to the paradox of modern aircraft maintenance – the problem of how to maintain the equipment in a safe and economical fashion until we have accumulated enough information to know how to do it.

6·2 ORGANIZATION OF THE PROGRAM-DEVELOPMENT TEAM

In the airline industry the FAA convenes a maintenance review board (MRB) for each new type of airplane. This board is responsible for preparing and issuing a document that defines the initial scheduled-maintenance program for the new equipment. Although the initial program of each airline using the equipment is based on this document, the airlines very quickly begin to obtain approval for revisions on the basis of their individual experiences and operating requirements. Consequently the programs that ultimately come into effect may be quite different for users of the same equipment.

regulatory authorities
the role of the steering committee
the role of the working groups

It is usual practice for the MRB to develop this document as a joint venture involving the aircraft and engine manufacturers, the purchasing airlines, and members of the FAA. The industry group—the manufacturers and the airlines—ordinarily develop a complete program and submit it to the MRB as a proposal; the MRB then incorporates any necessary changes before final approval and release. On one hand, this procedure cannot be started until the design characteristics of the equipment are well established; on the other hand, the initial program must be completed and approved before the new plane can enter service. Thus there are certain time constraints involved.

While the initial maintenance program is being developed, other FAA personnel, manufacturing and airline engineers, and pilots of the purchasing airlines compile a *minimum-equipment list* (MEL) and a *configuration-deviation list* (CDL). These two lists give explicit recognition to the fact that the aircraft can be operated safely in a condition that is less than its original state. In fact, these lists help to define operational consequences, since they define the failures that must be corrected before further operation. The minimum-equipment list specifies the items that must be serviceable at the time a plane is dispatched and in some cases includes mandatory operating limitations if certain items are inoperative. The configuration-deviation list is concerned primarily with the external envelope of the aircraft and identifies certain parts, such as cover plates and small pieces of fairing, that are allowed to be missing.

The first draft of the RCM program is generally developed by an industry task force specially appointed for that purpose. Although there are no hard-and-fast rules about organization, the approach on airline programs has been a steering committee supported by a number of working groups. The steering committee consists of about ten manufacturer and airline representatives and is responsible for managing all aspects of the program development; this committee also serves as the interface with the manufacturer and the various regulatory agencies.

The first chore of the steering committee is to appoint working groups of eight to ten members to conduct the detailed study of the aircraft structure, powerplant, and systems. Seven such working groups were employed, for example, to develop the maintenance program for the Douglas DC-10. The steering committee sets the ground rules for each working group and selects a group chairman. Ordinarily a steering-committee member also sits in on each working-group meeting to audit progress and resolve problems.*

One other responsibility of the steering committee is to arrange for training. All members of the task force are given a one-week course to familiarize them with the features of the new equipment. Members of the working groups, however, require additional training in RCM analysis (usually by the steering committee) and much more detailed training on the particular aspect of the equipment they are to analyze. The training in RCM procedures assures that all participants have a uniform understanding of the basic task criteria and the definitions of such key terms as *significant item*, *function*, *functional failure*, *failure mode*, *failure consequences*, and *cost effectiveness*. Working-group members must also be familiar with the decision logic used to sort and select tasks and with the default strategy to be employed when there is no information or the group is unable to reach a consensus.

The members of the task force should represent the best engineering and maintenance talent available. Ideally, the steering-committee should be headed by someone who has had previous experience with similar efforts and is completely familiar with RCM techniques (or employs someone who is familiar with them). All members of that committee should be generalists, rather than specialists. Their duties require experience in management and analysis, whereas the working-group members need actual hardware experience. Thus the steering committee is often composed of reliability, engineering, and quality-assurance managers, whereas the working groups consist of working engineers.

The working groups are responsible for identifying and listing the significant and hidden-function items and evaluating the proposed scheduled tasks. Usually they will be able to start with preliminary worksheets prepared by the manufacturers. These worksheets are studied in detail, and in some cases the working group may examine an aircraft that is being assembled to confirm certain points. Each group recommends additions and/or deletions of significant items, essential functions, failure modes, and anticipated failure consequences and selects appropriate scheduled tasks and task intervals for the portion of

*The role of the auditor in a program-development project is discussed in detail in Appendix A. This discussion also covers some of the common problems that arise during analysis and provides a useful review for those who may be working with RCM procedures for the first time.

the equipment on which it is working. The results are then summarized in a way that allows the steering committee to evaluate the analysis and incorporate the scheduled tasks in the program.

6·3 BEGINNING THE DECISION PROCESS

A new aircraft is never totally new. Rather, it is the product of an era, although its design usually includes some recent technological developments to improve performance capabilities and reduce maintenance costs. The program-development team thus begins with a large body of knowledge gained from experience with other aircraft. In addition to this general context of expertise, there are specific test data on the vital portions of the aircraft. These are the manufacturer's tests, conducted during design and development of the equipment to establish the integrity of the structure, the reliability and performance characteristics of the powerplant, and other factors necessary to ensure that the various systems and components will in fact perform as intended. Finally, the new equipment will come to the RCM team with a list of manufacturer's recommendations for scheduled lubrication and servicing, and often more extensive maintenance suggestions as well.

In evaluating and selecting the scheduled-maintenance tasks for this new equipment, the analysis team will therefore have a fairly good idea from the outset of which functions, failures, and tasks are going to demand consideration. The first step in the procedure is to partition the aircraft into its major divisions so that these can be assigned to the various working groups. Usually one working group is established to study the structure, another to study the powerplant, and several more to study the various systems.

The *systems* division includes the various sets of items other than the engine which perform specific functions—the environmental-control system, the communications system, the hydraulic system. It also includes the items that connect the assemblies; for example, the hydraulic system includes the lines that connect the actuators to the pump. The *powerplant* includes only the basic engine. It does not include the ignition system or engine-driven accessories, such as the fuel control and the constant-speed drive, all of which are part of systems. Nor does it include the engine cowling and supports, which are part of the structure. *Structure* includes all of the airframe structure, as well as the movable flight-control surfaces, hinges, hinge bearings, and landing gear. However, the actuators, cables, gearboxes, and hydraulic components associated with these items are treated as part of the systems division.

Each working group partitions the portion of the equipment for which it is responsible in descending levels of complexity to identify

the partitioning process
assembling the required
information
recording the decision process

nonsignificant items on the one hand and significant and hidden-function items on the other. To help organize this process the items are usually characterized in some kind of order. For example, the engine is ordinarily partitioned according to the order in which it is assembled—by module, stage, and part—whereas the structure is partitioned according to geographic zones. Exhibit 6.2 shows some typical items included under each of the major divisions, as well as typical items covered

EXHIBIT 6-2 Typical hardware items in each of the three major divisions of an aircraft. The level of item selected as significant in each case will depend on the consequences of a functional failure for the aircraft as a whole. These items will be subjected to intensive RCM analysis to determine how they might benefit from scheduled maintenance. The resulting program of RCM tasks is supplemented by a separate program of zonal inspections, which consists of scheduled general inspections of all the items and installations within the specified zone.

systems	powerplant	structure	zonal installations
Flight-control system	Compressor Section	Wing and empennage	Wing zones
Actuators	Stators	Stringers	Hydraulic lines
Gearboxes	Spacers	Spars	Fuel lines
Cables	Tie rods	Skins	Wiring
Linkages	Blades	Control surfaces	Ducting
Control valves	Air seal	Slats and flaps	
Electric-power system	Compressor hubs	Hinges	
Generators	Disks	Landing gear	Wheelwell
Relays	Combustion section	Shock struts	Switches
Constant-speed drives	Scavenge pumps	Pistons	Hydraulic lines
Bus-control unit	Exit guide vanes		Wiring
Air-conditioning system	Diffuser case	Fuselage	Fuselage zones
Packs	Inner case	Circumferentials	Oxygen cylinders
Valves	Bearing assembly	Longerons	Assembly housings
Sensors	Bearing carbon seal	Skins	Water lines
Ignition system	Stator support	Bulkheads	Wiring
Igniter	Combustion chambers		
Power supply	Rear support		
	Outlet ducts		
	Nozzle guide vanes		

by zonal-installation inspections. Although these general inspections are not established on the basis of RCM analysis, the tasks themselves, along with the necessary servicing and lubrication tasks, are included in the final list of scheduled tasks for packaging in the maintenance program.

This first sorting process to identify significant items is largely a matter of experience and judgment. Some items will be classified as significant because they have always been significant in the past; others may be included because there is some uncertainty about their impact on the system as a whole. In selecting the appropriate level of item for intensive study, two types of error are possible: partitioning too far down and unnecessarily increasing the workload, or else not partitioning down far enough and thus overlooking some failure mode that may later prove significant. The first inclination is to minimize this latter possibility in the interests of safety. However, with limited time and resources it is equally important to pick some cutoff point that will not dilute the effort needed for truly significant items. The optimum cutoff point for each item thus lies in a fairly narrow range.

The partitioning process organizes the problem, but it is also necessary to organize the information required to solve it. In addition to the manufacturer's designation of the item, a brief description is needed that indicates the basic function of the item and its location in the equipment. It is also necessary to make a complete and accurate list of all the other intended or characteristic functions of the item in order to define the functional failures to which it is subject. A *functional failure* is any condition that prevents the item from meeting its specified performance requirements; hence the evidence by which this condition can be recognized must be specified as well. A functional failure may have several *failure modes*, and the most likely ones must be identified. For example, the list of functional failures for the main oil pump on a jet engine might include high pressure, low pressure, no pressure, contaminated oil, and leaks. However, the condition of no pressure may be caused by drive-gear failure, shaft failure, or a broken oil line.

To evaluate the consequences of each type of failure it is necessary to identify both the effects of a loss of function and the effects of any secondary damage resulting from a particular failure mode. For example, the loss of function for a generator might be described as no output; if the cause is bearing failure, however, the probable secondary damage is complete destruction of the generator, which is very expensive. Another important factor in evaluating failure consequences is the design of the equipment itself. All redundancies, protective devices, and monitoring equipment must be listed, since these have a direct bearing on the seriousness of any single failure. If an essential function is available from more than one source, then a failure that might otherwise have a

direct effect on safety or operating capability may have no significant consequences. Similarly, failure annunciators and other instrumentation mean that failures that would otherwise be hidden are in fact evident to the operating crew.

All these data elements are assembled for each item before the analysis begins. To keep track of the necessary information it is helpful to summarize the data for each item on a descriptive worksheet like that shown in Exhibit 6.3. The analysis itself consists of a systematic examination of each failure possibility and an evaluation of proposed maintenance tasks. Tasks are proposed by both the manufacturing

EXHIBIT 6-3 Item information worksheet. The data elements that pertain to each item are assembled and recorded on a descriptive worksheet before the analysis is begun. For convenience in documenting the decision process, it is helpful to use reference numbers and letters for the various functions, functional failures, and failure modes of each item.

SYSTEM INFORMATION WORKSHEET type of aircraft

item number

item name

vendor part/model no.

item description

reliability data

premature-removal rate (per 1,000 unit hours)

failure rate (per 1,000 unit hours)

source of data

functions

functional failures

members of the program-development team and by the members of the operating organization. The manufacturer has more specific knowledge of the equipment, its intended design features, and the development and testing procedures that were employed. The operating organization has the more intimate knowledge of how the equipment will be used, what sorts of maintenance tasks are feasible, and which ones have proved most effective in the recent past.

To ensure that the entire decision process is documented, the answer to each question in the decision diagram must be recorded. One convenient form is shown in Exhibit 6.4; the numbers across the top

		page	of				
no. per aircraft	prepared by	date					
system	reviewed by	date					
zone(s)	approved by	date					
<p>redundancies and protective features (include instrumentation)</p> <p>built-in test equipment (describe)</p> <table style="width: 100%; border: none;"> <tr> <td style="width: 60%; vertical-align: top;"> <p>Can aircraft be dispatched with item inoperative? If so, list any limitations which must be observed.</p> </td> <td style="width: 40%; vertical-align: top;"> <p>classification of item (check)</p> <p>significant</p> <p>hidden function</p> <p>nonsignificant</p> </td> </tr> </table> <table style="width: 100%; border: none;"> <tr> <td style="width: 50%; text-align: center;">failure modes</td> <td style="width: 50%; text-align: center;">failure effects</td> </tr> </table>				<p>Can aircraft be dispatched with item inoperative? If so, list any limitations which must be observed.</p>	<p>classification of item (check)</p> <p>significant</p> <p>hidden function</p> <p>nonsignificant</p>	failure modes	failure effects
<p>Can aircraft be dispatched with item inoperative? If so, list any limitations which must be observed.</p>	<p>classification of item (check)</p> <p>significant</p> <p>hidden function</p> <p>nonsignificant</p>						
failure modes	failure effects						

SYSTEM DECISION WORKSHEET type of aircraft

item name

			responses to decision-diagram questions															
ref.			consequences							task selection								
F	FF	FM	1	2	3	4	5	6	7	8	9	10	11	12	13	14	15	16

EXHIBIT 6-4 Decision worksheet for systems and powerplant items. For each function (F), functional failure (FF), and failure mode (FM), the answers to the questions in the decision diagram are recorded to show the reasoning leading to the selection of a particular task. In the case of structural items the principal decision problem concerns the selection of task intervals; hence the worksheet form used for structures is somewhat different.

represent the decision questions, and the trail of answers shows the logic by which a particular decision was reached. Depending on the nature of the item, its failure characteristics, and the failure consequences that govern the evaluation, the outcome may be one or more scheduled tasks, redesign, or no scheduled maintenance. In each case, however, the reason for the decision will be clearly identifiable, both for auditing during analysis and for later review.

The study up to this point represents a substantial effort. The analysis for the Douglas DC-10, which was based on similar principles, led to a set of reports approximately 10 inches high and represented about 10 man years of effort over an 18-month period. Nevertheless, given the complexity of modern aircraft, this effort is still modest in comparison to what might be envisioned if the several bounds on the process were relaxed. These bounds are established by the decision questions themselves, by the default strategy that provides for decision making with minimal information, and also by the auditing process that goes on both during analysis and afterward.

page of
item number

prepared by

reviewed by

proposed task

initial interval

6·4 THE INFORMATION FLOW IN DECISION MAKING

The flow of information in RCM decision making is a circular process that begins with the initial selection of items for intensive analysis and continues throughout the life of the equipment. The very selection of significant items requires not only substantial factual data, but considerable experience and judgment as inputs to a prior-to-service analysis. The outputs are a list of all the applicable and effective tasks to be included in the scheduled-maintenance program. These tasks are then assigned intervals and packaged for implementation, and from this point on the information from actual operating experience becomes the input data.

In most cases the transition from prior-to-service study to actual maintenance on in-service equipment takes place gradually. The first few planes delivered and put into service are inspected at relatively frequent intervals. This "excessive" maintenance is not expensive, since only a few planes are involved, and it serves both to work out the short-

the uses of operating data
evolution of the maintenance
program
managing the ongoing program

INITIAL INFORMATION REQUIREMENTS

RCM DECISION ANALYSIS

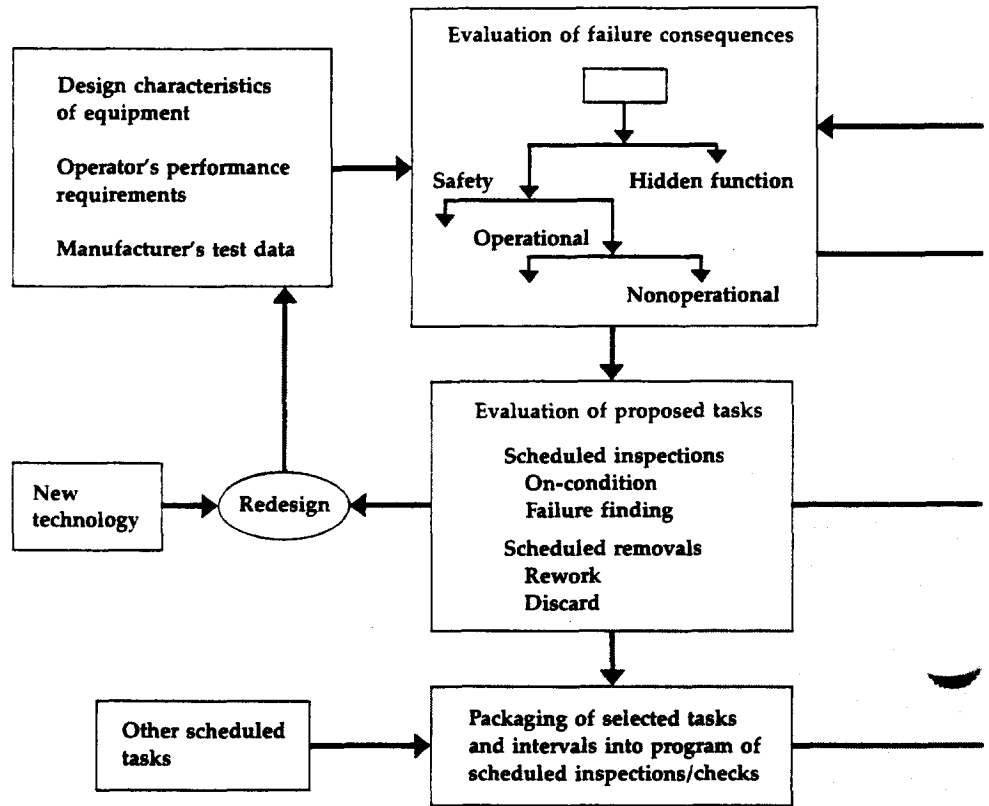
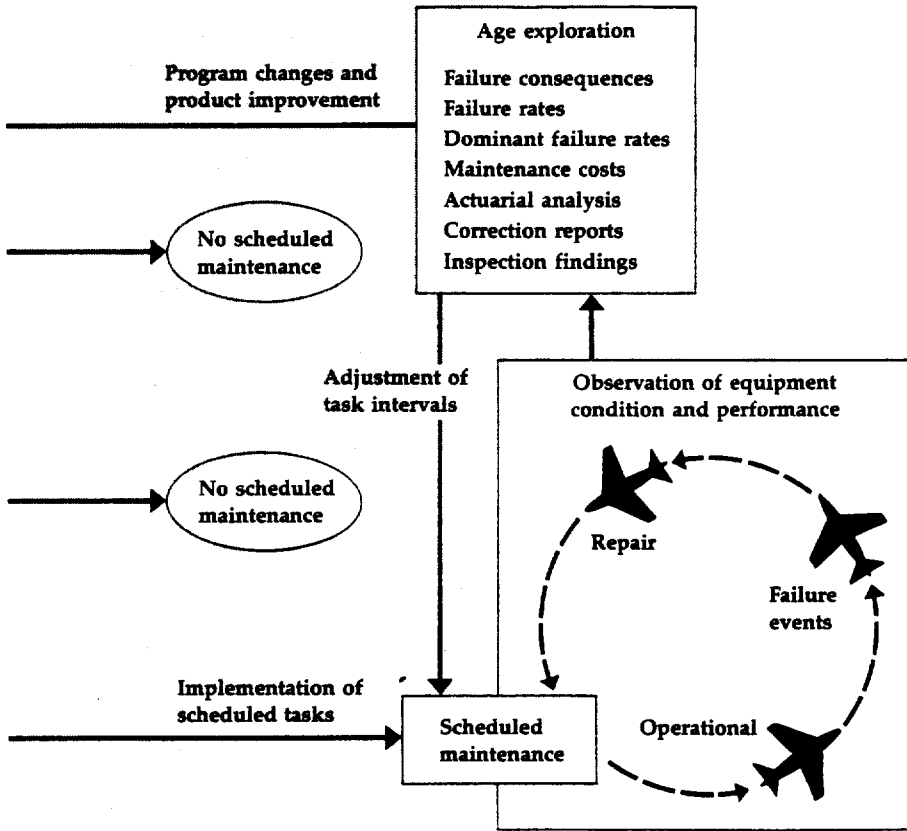

EXHIBIT 6-5 The process of information flow and decision making in the development and evolution of an RCM program.

comings in the maintenance program and to provide training opportunities for the personnel who will eventually handle the entire fleet.

During early operation the condition and performance of the aircraft are continually monitored through what the FAA terms an *analysis and surveillance program*. The maintenance department is prepared for unanticipated kinds of failures and is ready to react immediately to any critical events. Other failure experiences are reported systematically, and this information is used to review and revise the scheduled tasks and to provide the cost data necessary to initiate product improvement. The maintenance crew will also be able to confirm the reliability of

INFORMATION FROM OPERATING EXPERIENCE



many items; that is, they will see a great deal of nonfailure, which is also reflected in the program as it evolves. For example, the inspection intervals for items that are performing satisfactorily will be extended, thus reducing the workload per plane at about the same rate that new planes are entering service.

By the time the fleet has reached full size—about five years after the first planes enter service—the thrust of maintenance analysis turns to a more careful study of the items that may eventually show wearout characteristics and would therefore benefit from periodic rework or discard. As the potential-failure ages of longer-lived items are identified,

some of these items may also be modified through redesign to increase their longevity, and there will be corresponding changes in their maintenance requirements, necessitating a further round of analysis and age exploration to determine their new reliability characteristics. Periodically the entire maintenance program is subjected to "purging," both to eliminate tasks that have crept in to take care of problems that have since been resolved and to omit borderline tasks that have not proved to be worthwhile.

As a result of continuous maintenance and product improvement, the aircraft also evolves throughout its operating life. Most commercial aircraft remain in operation for at least twenty years. At the end of this time, although the overall structure of any given plane will be essentially the structure it started with, the rest of the aircraft will have been substantially replaced or modified, and most of the replaceable parts will have been changed many times. Thus the aircraft is not in fact twenty years old; only the basic structure is. This constant cycle of preventive and corrective maintenance ensures that an aircraft does not wear out with age. Instead, it remains in service until newer designs render it technologically obsolete.

To realize the inherent reliability of any aircraft it is necessary to keep track of its state, both individually and collectively, from the time the equipment enters service until the time it is finally retired. The information about failed items, potential failures, and the corresponding replacement of parts or components in each aircraft must be recorded and assembled in a form that allows for analysis of the performance of the aircraft as a whole, as well as the performance of individual items. At the earliest stages these information requirements concern only individual failures and failure modes. Soon after, it becomes necessary to keep track of the accumulated operating time of the fleet in order to establish failure rates, and when they are sufficiently low, reduce inspection frequencies. It is sometimes helpful during the middle years of operation to make extensive studies of individual item histories (including actuarial analyses).

Given the hundreds of thousands of parts on a modern aircraft, these information requirements call for careful judgment. The notion that someone must be able to determine at any point how long the light bulb over seat 3F has been in operation would lead to staggering information costs. Just as it is crucial at the beginning to size the problem of analysis, so it is crucial to size the reporting system so that the information necessary to manage the ongoing maintenance program is not buried by an information overload. The various types of reporting systems and the specific kinds of information they provide are discussed in Chapter 11.

Whatever the equipment, as the maintenance program evolves each iteration of the decision process must be documented and audited

by independent observers if the results are to be relied upon. This documentation is just as important for subsequent modifications of the initial program as it was in developing the initial program. The structure of the decision logic provides such documentation, since the list of yes/no answers to specific questions leaves a clear audit trail that can be checked both during and after the decision process. This audit trail, together with the information on which the initial decisions were made and modified during subsequent operation of the equipment, provides the starting point for the next round of design evolution. Given the transitory nature of the workforce in both government and commercial situations and the relatively long service life of complex equipment, this maintenance-system "memory" is a necessary factor in long-term technological improvement.

rcm analysis of systems

THE SYSTEMS division includes all the systems required for operating the airplane except the powerplant itself. Most systems are composed of numerous separate assemblies, or components, linked by electrical or hydraulic lines or other connecting devices. Even in a new type of aircraft few of the systems components will be entirely new; most will have been used in previous designs. As a result, the reliability characteristics of many systems items are fairly well known and data are often available on the applicability and effectiveness of specific maintenance tasks. Maintenance experience has also shown that certain classes of items, such as electronic components, have the generic characteristic of being unable to benefit from scheduled maintenance.

A great many systems items do not require scheduled maintenance. While a number of systems do have hidden functions that must be protected by scheduled tasks, most aircraft systems have been designed to preclude critical failures and many have been designed to ensure that the aircraft will remain fully operational after the occurrence of a failure. An item whose failure is evident to the operating crew and has no safety or operational consequences would be classified as nonsignificant and assigned in an initial program to no scheduled maintenance. The system itself would be designated as significant, since its overall function is essential to the aircraft. In many cases, however, the units that actually perform this function are nonsignificant items, since a failure of any one of them has no consequences other than the cost of repair.

In general, the outcome of RCM analysis depends more on the design characteristics of the system than on the nature of the item. Nevertheless, certain results are typical for various classes of items. Mechanical items such as fuel pumps, gearboxes, and brake assemblies

will often receive on-condition tasks, and on rare occasions a rework task, although frequently the assignment is to no scheduled maintenance. Hydraulic items are generally assigned on-condition tasks in which a gross-flow check of the entire system is followed by isolation checks to pinpoint the source of internal leaks. Electrical and electronic items, unless they have hidden functions that require failure-finding tasks, will nearly always be assigned to no scheduled maintenance.

7·1 CHARACTERISTICS OF SYSTEMS ITEMS

Each type of system has a unique function in an aircraft—flight control, environmental control, fuel supply, high-frequency communication, and so on. Nevertheless, systems as a group have certain common characteristics that affect their maintenance requirements. Most systems are equipped with instrumentation which allows the operating crew to monitor the performance both of the system as a whole and of many of its individual components. Thus as a general rule functional failures are evident to the crew. Also, such failures seldom affect operating safety. As a result of careful design, even unanticipated failure modes are unlikely to have safety consequences. The chief reason for this is the high degree of redundancy employed in systems design. All essential functions are available to the aircraft from more than one source, so that the system is *fail-safe*.

It is usual, in fact, for systems to include enough redundancy to permit completion of a day's flying after a failure has occurred. Under these circumstances the airplane can be dispatched with one unit inoperative, and unless a second unit fails there is no need to interrupt sched-

design characteristics
maintenance characteristics

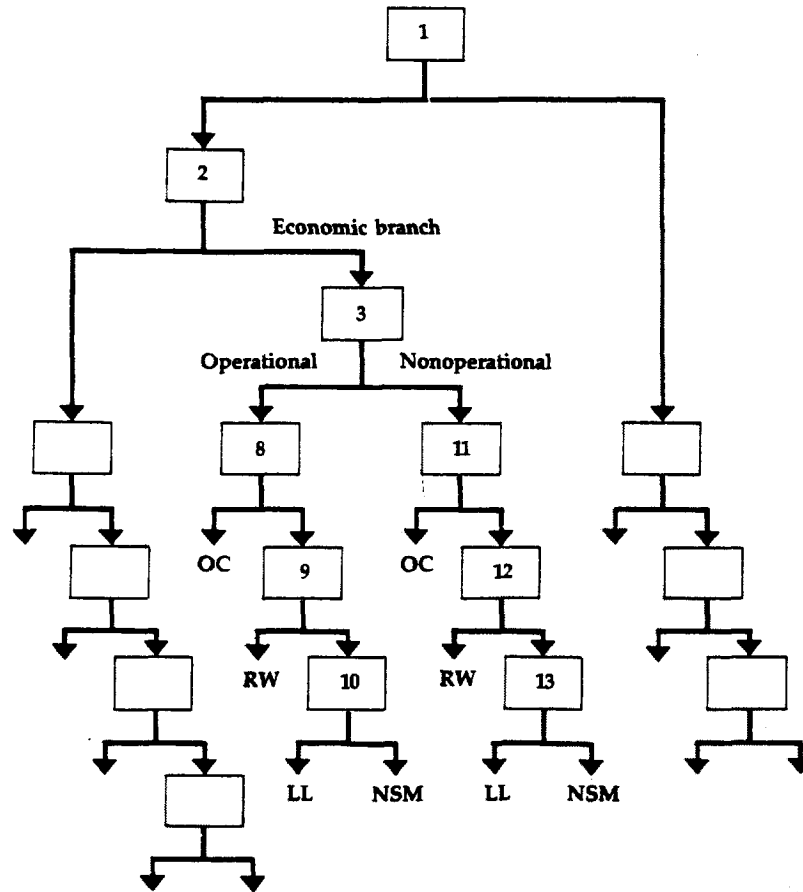

EXHIBIT 7-1 The most common outcomes of RCM analysis in the systems division. Few systems failures fall in the safety branch; several, however, may fall in the hidden-function branch. The principal objective of analysis is to ensure that these exceptions are accurately identified.

uled operations for corrective maintenance. Thus, despite the frequency of systems failures, the majority of these failures have no operational consequences. Correction of the failure is simply deferred to a convenient time and location. In addition to the protection afforded by redundancy, some of the more exotic devices, such as the autoland system, employ a newer technique called *fail-operational*. In this case not only the aircraft, but the system itself remains fully operational after the occurrence of a failure.

Even though systems in commercial aircraft are designed to reduce failure consequences to the nonoperational level, once the equipment enters service the performance of all items, including those assigned to no scheduled maintenance, is carefully monitored during the early stages of operation. To meet the space and weight requirements of high-performance aircraft, systems components are generally designed with a low initial margin of failure resistance; hence their overall reliability tends to be low. To offset this problem components are usually designed for easy replacement in the field. Even so, the poor reliability of certain items may result in unacceptable repair or support costs, and the need to improve systems items by redesign is quite common in new aircraft.

Another characteristic of systems is that the assemblies that comprise them are themselves multicelled and subject to numerous failure modes—that is, they are complex items. Since the overall reliability of a complex item generally shows little or no relationship to operating age, scheduled rework is rarely applicable to systems components (see Section 3.2). Rework or discard tasks may be applicable, however, to relatively simple parts such as connecting lines or to items subject to mechanical wear or metal fatigue. Some assemblies may also include safe-life parts, such as the actuator endcaps in certain flight-control systems, for which redundancy is not feasible.

In terms of RCM analysis, then, systems items are characterized by evident failures which fall primarily in the economic branches of the decision diagram, where scheduled maintenance is desirable only if it is cost-effective (see Exhibit 7.1). For this reason, and because most failures are unrelated to operating age, the most frequent outcome of analysis is either an on-condition task or no scheduled maintenance. However, the exceptions to this general pattern may fall in any branch and lead to almost any of the possible outcomes. The principal focus in developing a prior-to-service program for systems is on proper identification of these exceptions.

7·2 ASSEMBLING THE REQUIRED INFORMATION

The analysis of a system, subsystem, or assembly requires a knowledge both of the system itself and of the relationship of the system to the aircraft as a whole. To evaluate the consequences of a functional failure it is necessary to visualize the various failure possibilities in terms of the basic function of the entire system, rather than from the standpoint of its component units. For this reason particular attention must be paid to redundancies and other fail-safe features, since the amount of replication of a given function will determine the seriousness of the failure consequences. A failure in a nonredundant system might represent a critical loss of function for the aircraft, whereas the same failure in a highly redundant system may not even affect operational capability.

initial information requirements
the information worksheet

EXHIBIT 7-2 The data elements needed for analysis of systems items.

IDENTIFICATION OF ITEM	Quantity per aircraft
Type of aircraft	
System designation	Location(s)
Item name	
Manufacturer's part number	
ITEM INFORMATION	
Item description (general function and major assemblies)	
Redundancies and protective features (including instrumentation)	
Built-in test equipment	
AVAILABLE RELIABILITY DATA	
Anticipated premature-removal rate	
Anticipated verified failure rate	
Source of data (test data or operating experience)	
OPERATING RESTRICTIONS	
Can aircraft be dispatched with item inoperative? (from MEL)	
If so, do any limiting conditions apply?	
RCM INPUT	
Item functions	
Functional failures (as defined for each function)	
Most probable failure modes	
Predictable failure effects (for each failure mode)	
Evidence of functional failure	
Effects of loss of function on operating capability	
Effects of failure beyond loss of function (including ultimate effects of possible secondary damage)	
Nature of failure consequences	
Evidence of reduced failure resistance that can be used to define potential-failure conditions	
Experience with other equipment on which the same or similar item has been used	

Another design feature that affects the evaluation of failure consequences is the instrumentation or built-in test equipment for the system. This instrumentation is a major factor in determining whether functional failures will be evident or hidden from the operating crew. It is also necessary to know enough about the duties of the operating crew to judge whether functional failure will be evident during routine activities, either through use of the function or as a result of standard crew checks of certain hidden-function items.

In the airline industry the minimum-equipment list and the configuration-deviation list, issued by the FAA, specify whether or not an aircraft can be dispatched with a given item inoperative. These lists help to determine whether a failure has operational consequences. They are not the sole determinant; a failure that can be corrected quickly may cause no delay in flight schedules, and highly unreliable items may involve occasional operational consequences as the result of a multiple failure. However, any regulations that define acceptable flight configuration are an important part of the initial information requirements.

Exhibit 7.2 lists the data elements that must be collected and organized for each item to be studied. In the case of new aircraft much of this information is supplied by the manufacturer in the various maintenance manuals and stores catalogs furnished with the equipment. For the wide-body Douglas DC-10, for example, the working groups were provided with worksheets, instruction manuals, and schematic diagrams showing nearly all the data available. Usually 200 to 300 of the most important systems, subsystems, and assemblies will be classified either as functionally significant items or as items with hidden functions. If there is any doubt about whether an item is significant or has a hidden function, it is always classified on this basis initially and included in the list of items to receive further study.

Once the data elements for each item have been assembled, they are summarized on descriptive worksheets for convenient reference during analysis. Note in Exhibit 7.3 that the item description indicates the general function of the item, the level of item being considered, and the major assemblies and components it includes. The failure of any one of these components would represent a failure mode for the item itself. In listing the functions of the item it is important to describe both its basic function and each of its secondary functions clearly and accurately, since each of these functions must be analyzed separately. The functional failures should be worded to define the condition that constitutes a failure. Generally this is the condition or state that exists after a failure has occurred.

Failure effects refers to all the immediate results of the failure. For example, one effect of a locked wheel in a brake assembly is a tire blow-out, with possible secondary damage to the airplane structure; another

EXHIBIT 7-3 An information worksheet for the air-conditioning pack in the Douglas DC-10.

SYSTEM INFORMATION WORKSHEET type of aircraft Douglas DC-10-10

item number

item name Air-conditioning pack

vendor part/model no. Airesearch 927370-4

item description

Pack delivers temperature-controlled air to conditioned-air distribution ducts of airplane. Major assemblies are heat exchanger, air-cycle machine, anti-ice valve, water separator, and bulkhead check valve.

reliability data

premature-removal rate (per 1,000 unit hours)

failure rate (per 1,000 unit hours)

source of data

functions

1 To supply air to conditioned-air distribution ducts at the temperature called for by pack temperature controller

functional failures

A Conditioned air is not supplied at called-for temperature

2 To prevent loss of cabin pressure by backflow if duct fails in unpressurized nose-wheel compartment

A No protection against backflow

		page	of
no. per aircraft	3	prepared by	F. S. Nowlan
system	Air conditioning	reviewed by	J. E. Kuhl
zone(s)	110	approved by	
		date	3/6/78
		date	3/6/78
		date	

redundancies and protective features (include instrumentation)

The three packs are completely independent. Each pack has a check valve to prevent loss of cabin pressure in case of duct failure in unpressurized nose-wheel compartment. Flow to each pack is modulated by a flow-control valve which provides automatic overtemperature protection backed by an overtemperature tripoff. Full cockpit instrumentation for each pack includes indicators for pack flow, turbine inlet temperature, pack-temperature valve position, and pack discharge temperature.

built-in test equipment (describe) None

Can aircraft be dispatched with item inoperative? If so, list any limitations which must be observed.

Yes. No operating restrictions with one pack inoperative

classification of item (check)
 significant
 hidden function
 nonsignificant

failure modes	failure effects
1 Air-cycle machine seized	Reduced pack flow, anomalous readings on pack-flow indicator and other instruments
2 Blocked ram-air passages in heat exchanger	High turbine-inlet temperature and partial closure of flow-control valve by overtemperature protection, with resulting reduction in pack air flow
3 Failure of anti-ice valve	If valve fails in open position, increase in pack discharge temperature; if valve fails in closed position, reduced pack air flow
4 Failure of water separator	Condensation (water drops, fog, or ice crystals) in cabin
1 Failure of bulkhead check valve	None (hidden function); if duct or connectors fail in pack bay, loss of cabin pressure by backflow, and airplane must descend to lower altitude

143

effect is noise and vibration, which will be apparent to the operating crew. The description of failure effects should always include any physical evidence by which the occurrence of a failure can be recognized. Very often this evidence is an instrument indication or a warning light that informs the pilot of a malfunction. In some cases the failure effects also include specific operating restrictions, such as the need to descend to a lower altitude. The failure effects must be described for each type of functional failure, since they help to determine the consequences of that failure for the equipment and its occupants.

All this information is examined, and the item is given a conservative initial classification of significant or nonsignificant on the basis of its failure consequences. Items in either category may have hidden functions; these must be identified whether the item is significant or not. Thus some items may have two classifications. An item classified as significant during the initial partitioning process may later be assigned to no scheduled maintenance, either because its failure consequences do not in fact qualify it as significant or because no maintenance task can be found that will improve its reliability. At this stage, however, any borderline items would be included for analysis.

7.3 ANALYSIS OF TYPICAL SYSTEMS ITEMS

DC-10 air-conditioning pack
nonredundant fuel pump
DC-10 brake assembly
Boeing 747 high-frequency
communications subsystem
other typical systems items

ANALYSIS OF AN AIR-CONDITIONING PACK

The air-conditioning pack described in Exhibit 7.3 is the cooling portion of the Douglas DC-10 air-conditioning system. This subsystem was classified as significant during the first review of the DC-10 systems because of its size, complexity, and cost. There are three independent installations of this item, located in the unpressurized nose-wheel side compartment of the airplane (see Exhibit 7.4). Hot high-pressure air, which has been bled from the compressor section of the engine, enters the pack through a flow-control valve and is cooled and dehumidified by a heat exchanger and the turbine of an air-cycle refrigeration machine. The cooled air is then directed through a distribution duct to a manifold in the pressurized area of the airplane, where it is mixed with hot trim air and distributed to the various compartments. The performance of each pack is controlled by a pack temperature controller. Each pack is also monitored by cockpit instrumentation and can be controlled manually if there is trouble with the automatic control system.

The pack itself consists of the heat exchanger, the air-cycle machine (which has air bearings), an anti-ice valve, a water separator, and a check valve at the pressure bulkhead to prevent backflow and cabin depressurization if there is a duct failure in the unpressurized area.

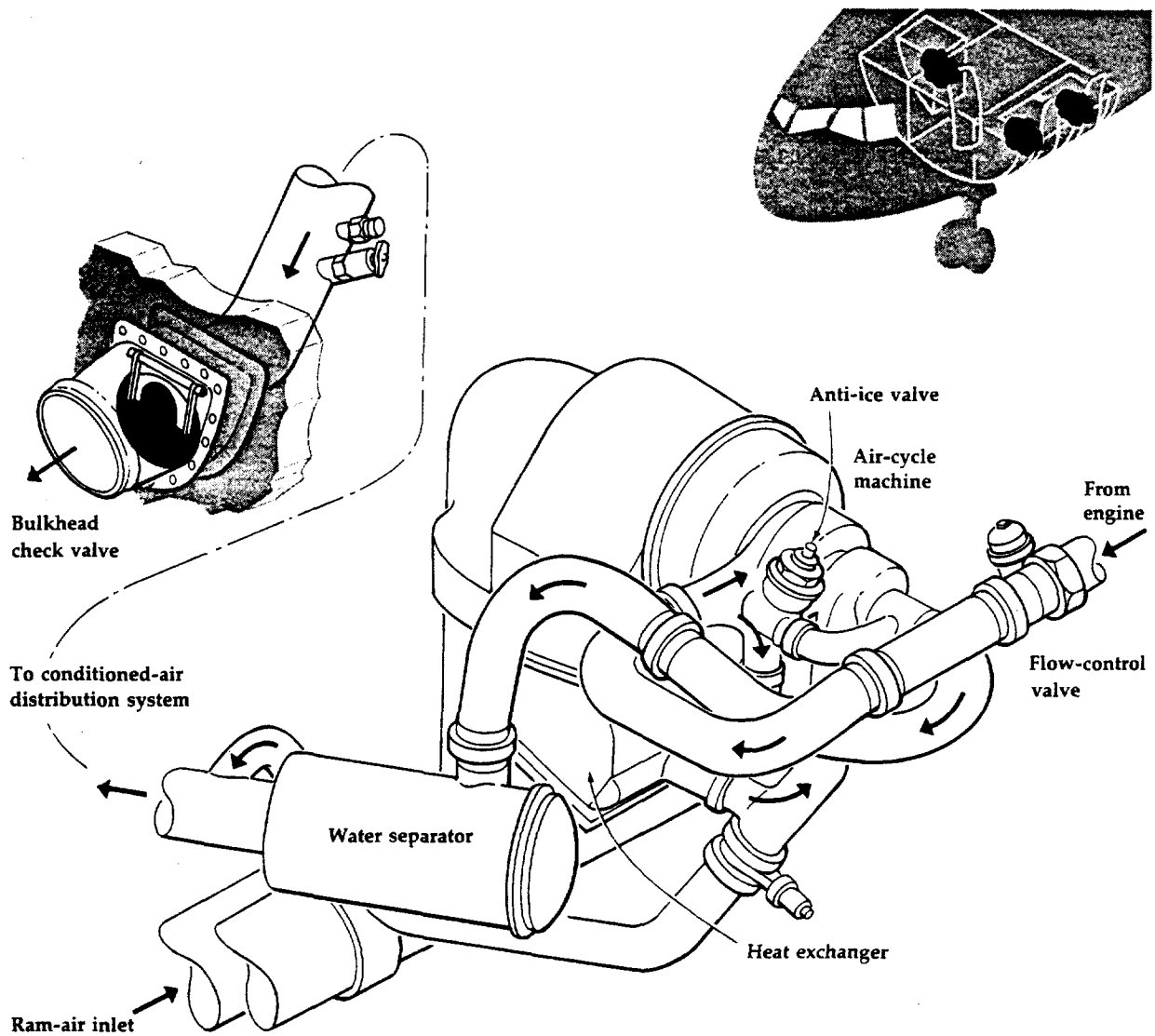

EXHIBIT 7-4 The air-conditioning pack in the Douglas DC-10. The location of the three packs in the nose-wheel compartment is indicated at the upper right. (Based on Airesearch maintenance materials)

The duct is treated as part of the distribution system; similarly the flow-control valve through which air enters the pack is part of the pneumatic system. The pack temperature controller is part of a complex temperature-control system and is also not analyzed as part of the air-conditioning pack.

Two functions have been listed for the air-conditioning pack. Its basic function is to supply air to the distribution duct at the temperature called for by the pack controller. This function is considered first:

1 Is the occurrence of a failure evident to the operating crew during performance of normal duties?

Any one of the failure modes listed will result in changes in the pack's performance, and these anomalies will be reflected by the cockpit instruments. Hence the functional failure in this case can be classified as evident.

The loss of function in itself does not affect operating safety; however, each of the failure modes must be examined for possible secondary damage:

2 Does the failure cause a loss of function or secondary damage that could have a direct adverse effect on operating safety?

Engineering study of the design of this item shows that none of the failure modes causes any damage to surrounding items, so the answer to this question is no.

The next question concerns operational consequences:

3 Does the failure have a direct adverse effect on operational capability?

Because the packs are fully replicated, the aircraft can be dispatched with no operating restrictions when any one pack is inoperative. Therefore there is no immediate need for corrective maintenance. In fact, the aircraft can be dispatched even if two units are inoperative, although in this event operation would be restricted to altitudes of less than 25,000 feet.

On this basis we would reclassify the air-conditioning pack as a functionally nonsignificant item. Failure of any one of the three packs to perform its basic function will be evident, and therefore reported and corrected. A single failure has no effect on safety or operational capability, and since replacement of the failed unit can be deferred, there are no economic consequences other than the direct cost of corrective maintenance. Under these circumstances scheduled maintenance is unlikely to be cost-effective, and the costs cannot be assessed in any event until after the equipment enters service. Thus in developing a

prior-to-service program there is no need to make an intensive search for scheduled tasks that might prevent this type of failure.

When we examine the second function of the air-conditioning pack, however, we find an element that does require scheduled maintenance. The bulkhead check valve, which prevents backflow in case of a duct failure, is of lightweight construction and flutters back and forth during normal operation. Eventually mechanical wear will cause the flapper to disengage from its hinge mount, and if the duct in the unpressurized nose-wheel compartment should rupture, the valve will not seal the entrance to the pressurized cabin.

To analyze this second type of failure we start again with the first question in the decision diagram:

1 Is the occurrence of a failure evident to the operating crew during performance of normal duties?

The crew will have no way of knowing whether the check valve has failed unless there is also a duct failure. Thus the valve has a hidden function, and scheduled maintenance is required to avoid the risk of a multiple failure—failure of the check valve, followed at some later time by failure of the duct. Although the first failure would have no operational consequences, this multiple failure would necessitate descent to a lower altitude, and the airplane could not be dispatched after landing until repairs were made.

With a no answer to question 1 proposed tasks for the check valve fall in the hidden-function branch of the decision diagram:

14 Is an on-condition task to detect potential failures both applicable and effective?

Engineering advice is that the duct can be disconnected and the valve checked for signs of wear. Hence an on-condition task is applicable. To be effective the inspections must be scheduled at short enough intervals to ensure adequate availability of the hidden function. On the basis of experience with other fleets, an initial interval of 10,000 hours is specified, and the analysis of this function is complete.

In this case inspecting the valve for wear costs no more than inspecting for failed valves and is preferable because of the economic consequences of a possible multiple failure. If a multiple failure had no operational consequences, scheduled inspections would still be necessary to protect the hidden function; however, they would probably have been scheduled at longer intervals as a failure-finding task.

SYSTEM DECISION WORKSHEET type of aircraft **Douglas DC-10-10**

item name **Air-conditioning pack**

ref.	responses to decision-diagram questions																	
	consequences			task selection														
F	FF	FM	1	2	3	4	5	6	7	8	9	10	11	12	13	14	15	16
1	A	1	Y	N	N													
1	A	2	Y	N	N													
1	A	3	Y	N	N													
1	A	4	Y	N	N													
2	A	1	N	-	-	-	-	-	-	-	-	-	-	-	-	-	-	Y

EXHIBIT 7.5 A worksheet showing the results of RCM analysis of the air-conditioning pack in the Douglas DC-10. The references in the first column are to the functions, functional failures, and failure modes listed in Exhibit 7.3.

Exhibit 7.5 shows the results of the preceding analysis, including the response to each question in the decision diagram. Note that the basis for each answer to the first three questions is directly traceable to the information recorded on the descriptive worksheet in Exhibit 7.3.

ANALYSIS OF A NONREDUNDANT FUEL PUMP

The fuel-pump assembly described in Exhibit 7.6 was classified as a significant item because the aircraft in which it is installed is a single-engine attack plane. This means that a complete loss of function will bring the airplane out of the sky. As indicated on the worksheet, the fuel pump is subject to four types of functional failures. The first of these is loss of fuel flow (and pressure), and the associated failure mode is stripped splines on the main drive shaft.

1 Is the occurrence of a failure evident to the operating crew during performance of normal duties?

page of
item number

prepared by F. S. Nowlan

reviewed by J. E. Kuhl

proposed task

initial interval

None. This functional failure has no significant consequences; reclassify as nonsignificant.

Disconnect duct to manifold and examine check valve for wear

Not to exceed 10,000 hours

Loss of fuel flow results in fuel starvation of the engine and an immediate and complete loss of thrust (flameout). The pilot will sense this loss of thrust by a reduction in engine noise and deceleration of the aircraft, but it will also be evidenced by many instruments—the fuel-pressure indicator, the fuel-flow indicator, the engine tachometer, the airspeed indicator, and the altimeter. The answer to question 1 is therefore yes.

Since the failure is evident, the next concern is with its direct consequences:

2 Does the failure cause a loss of function or secondary damage that could have a direct adverse effect on operating safety?

In the event of a flameout, the pilot must either eject or make the best power-off landing he can, regardless of the landing conditions. In this case the loss of function itself has safety consequences, so it is unnecessary to consider whether either of the failure modes causes hazardous

EXHIBIT 7-6 An information worksheet for the fuel pump in the Douglas A-4, a single-engine attack airplane.

SYSTEM INFORMATION WORKSHEET type of aircraft **Douglas A-4**

item number

item name **Fuel pump**

vendor part/model no.

item description

Multistage engine fuel pump driven through splined shaft by engine-accessory gearbox. Delivers high-pressure fuel to fuel control and provides fuel-control governor with engine-speed information. Includes a fuel filter and filter bypass.

reliability data

premature-removal rate (per 1,000 unit hours)

failure rate (per 1,000 unit hours)

source of data

functions

functional failures

1 To pump fuel to engine through fuel-control unit

A No fuel flow (and pressure)

2 To contain fuel, without external leakage

A External fuel leaks

3 To filter fuel

A Unable to filter fuel

4 To provide engine-speed signal to fuel control

A Loss of engine-speed signal

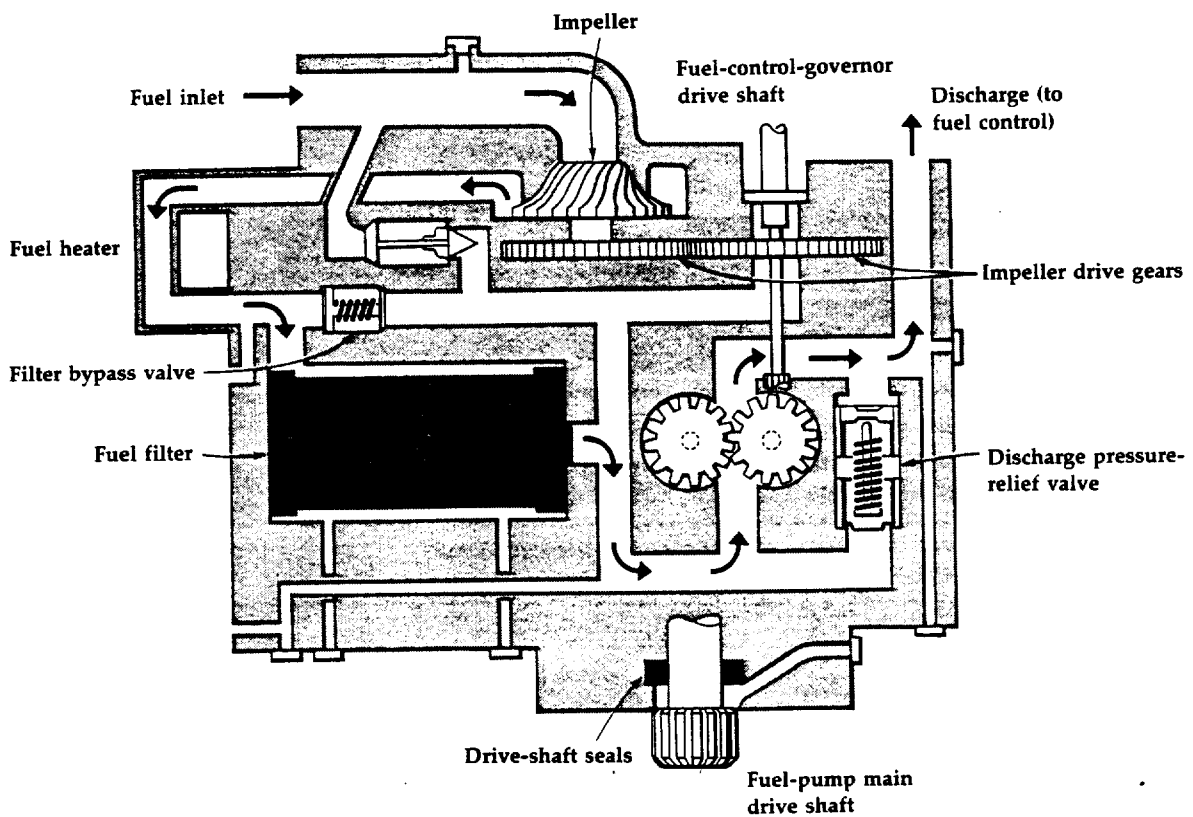

EXHIBIT 7-7 Schematic diagram of the fuel-pump assembly in the Douglas A-4. The fuel-pump main drive shaft is powered by the airplane engine.

secondary damage. The yes answer to this question brings us to the safety branch of the decision diagram, where all applicable scheduled-maintenance tasks are required but are considered effective only if they reduce the risk of this failure to an acceptable level.

We must now evaluate possible preventive tasks directed at the failure mode, stripped drive-shaft splines:

4 Is an on-condition task to detect potential failures both applicable and effective?

Periodic inspection of the drive shaft for spline wear will result in the removal of units from service at the potential-failure stage; hence an on-condition task is applicable. If this task reduced the risk of a functional failure to an acceptable level, it would also be considered effective.

page of

no. per aircraft 1

prepared by F. S. Nowlan

date 3/6/78

system Fuel supply

reviewed by T. M. Edwards

date 3/6/78

zone(s)

approved by

date

redundancies and protective features (include instrumentation)

Fuel flow and fuel pressure are instrumented. Warning light indicates when fuel filter is bypassed; manual fuel-heat control can be used to clear filter of ice particles. Fuel-control unit includes fuel bypass with a constant-flow restrictor that automatically provides sufficient fuel for 80 percent N_2 engine speed if speed signal is lost.

built-in test equipment (describe) None

Can aircraft be dispatched with item inoperative? If so, list any limitations which must be observed.

No

classification of item (check)

significant

hidden function

nonsignificant

failure modes

1 Stripped splines on main drive shaft

1 Worn or damaged main-shaft seals

1 Filter clogged by ice or debris from wear

1 Stripped splines on fuel-control-governor drive shaft

failure effects

Instruments show no fuel flow and pressure; engine flameout, requiring forced no-power landing

Small loss of fuel through overboard drains

Warning light shows filter bypass, possible delivery of contaminated fuel to fuel control and engine; if fuel heater does not correct for ice particles (warning light goes out), airplane must land at nearest airport

Fuel control automatically provides fuel for 80 percent N_2 engine speed, no engine control except manual shutdown; landing hazardous

174

tive, and the answer to the question would be yes. In an initial program, however, the chief source of information concerning the effectiveness of an on-condition task is prior experience with a similar item. In this case such information is not available, and even though we know the task will be applicable, we have no means of determining that it will provide the degree of protection required. Under these circumstances we would be reluctant to consider this task as meeting the effectiveness criterion, and the answer to the on-condition question must therefore be no.

Since an effective on-condition task has not been identified, we must investigate other types of tasks:

5 Is a rework task to reduce the failure rate both applicable and effective?

The fuel pump is a complex item, so we would not expect scheduled rework to make a difference in its overall reliability. Such a task might be applicable, however, for a specific failure mode involving a simple part, such as stripped drive-shaft splines. In this case scheduled rework would probably entail removing the pump from the aircraft and sending it to the maintenance base for machine work to restore the splines to "like-new" condition. If analysis of the other failure possibilities identified additional parts that could benefit from rework, there might be quite extensive rework activity while the pump was at the base.

Scheduled rework might lead to an appreciable reduction in fuel-pump failures if the failure modes for which rework tasks were applicable represented a large proportion of the failure possibilities for this item. However, this is an unusual situation for a complex item. Moreover, the information necessary to assess the value of a rework task is not available at the time an initial program is developed. At this stage, therefore, we cannot conclude that scheduled rework would provide any guarantee of operating safety and would have to answer this question no.

A no answer to the rework question means that we must move on to the question of a discard task:

6 Is a discard task to avoid failures or reduce the failure rate both applicable and effective?

During the development of an initial program the answer to this question must be no unless the pump manufacturer has specified a safe-life limit for the drive shaft.

Since no single task has been identified thus far which will protect against loss of the basic fuel-pump function, there is one further recourse:

7 Is a combination of preventive tasks both applicable and effective?

The answer must again be no, since the only task that might possibly be of benefit is an on-condition inspection of the drive shaft. The outcome of the analysis, therefore, is that scheduled maintenance cannot prevent pump failures, and to avoid critical failures the design must

EXHIBIT 7-8 A worksheet showing the results of RCM analysis of the fuel pump in the Douglas A-4. The references in the first column are to the functions, functional failures, and failure modes listed in Exhibit 7.6.

SYSTEM DECISION WORKSHEET type of aircraft Douglas A-4

item name Fuel pump

			responses to decision-diagram questions															
ref.			consequences							task selection								
F	FF	FM	1	2	3	4	5	6	7	8	9	10	11	12	13	14	15	16
1	A	1	Y	Y	-	N	N	N	N									
<p>If airplane must enter service before design is modified, the following responses would be appropriate, although there is no assurance that scheduled tasks will meet effectiveness criterion.</p>																		
1	A	1	Y	Y	-	Y												
2	A	1	N	-	-	-	-	-	-	-	-	-	-	-	-	N	N	N
3	A	1	Y	N	Y	-	-	-	-	Y								
4	A	1	Y	Y	-	N	N	N	N									

be changed—in this case to provide redundant pumping capabilities in the fuel-supply system.

What can be done if the aircraft must enter service before the design can be modified? An on-condition inspection of the drive shaft for spline wear can be assigned because such a task is usually effective for a single mechanical part. We do not know whether it will prove effective in this case. A rework task would probably not be scheduled to remachine the splines; instead the shaft would be replaced if the splines were in bad condition. All such tasks, however, would entail scheduled removals, because the fuel pump must be disassembled to gain access to the shaft. The initial intervals would be very conservative, and we

page of
item number

prepared by F. S. Nowlan

reviewed by T. M. Edwards

proposed task

initial interval

{ None. Redesign is necessary to provide sufficient redundancy for operating safety.

Inspect main fuel-pump drive shaft for spline wear

Not to exceed 1,000 hours

Inspect for external leaks (failure finding)

During walkaround checks and overnight stops

Inspect filter for contamination

Not to exceed 60 hours

Outcome as for failure of main drive shaft, 1 A 1

would still have to recognize that operating experience may show that these measures are not reducing the hazard to an acceptable level.

In addition to loss of fuel flow as a result of mechanical failure, the pump is also subject to external leaks. While a leak serious enough to affect fuel pressure would be evident to the operating crew, the fact that a leak has formed will not be evident from the cockpit instrumentation. The answer to the first decision question is therefore no, which takes us to the hidden-function branch of the diagram. As indicated by the answers recorded in Exhibit 7.8, there are no applicable and effective on-condition, rework, or discard tasks in this case. Therefore we arrive at the default alternative and must schedule a failure-finding task – an inspection during walkaround checks and overnight stops for any leaks that exceed a specified value.

The third type of functional failure results from clogging of the fuel filter. A warning light informs the pilot when this condition exists, so the failure is classified as evident. It does not present any safety problems, but it does have operational consequences, since a single-engine plane must land at the nearest airport and cannot be dispatched until this condition has been corrected. An on-condition inspection of the fuel filter for contamination is applicable. In this case the failure consequences are economic; hence the criterion of task effectiveness is cost. The cost of performing this task is so low that it would be judged as cost-effective in an initial program. As a result of experience with other fuel pumps, an initial interval of 60 hours is set for this check.

The fourth type of failure is inability to provide engine-speed information to the fuel-control assembly, caused by failure of the governor drive shaft (see Exhibit 7.7). Since the analysis of this failure is similar to that for failure of the main drive shaft, the details are not repeated in Exhibit 7.8. If tasks were scheduled, they would be performed at the same time as those for the main drive shaft.

ANALYSIS OF A LANDING-GEAR BRAKE ASSEMBLY

The brake assembly for the main landing gear of the Douglas DC-10 is classified as significant because the primary function of the braking system is to provide stopping capability after landing or during other ground operation. Since a complete loss of this function would clearly have safety consequences, it is necessary to consider how the brake assembly contributes to the overall system function. The full braking capacity is rarely used, and its effect is masked by concurrent use of reverse thrust from the engine. As a result, the pilot is not likely to notice the reduction in stopping capability caused by a failure in one brake assembly of a multiwheeled landing gear. This item therefore has hidden functions as well. Had there been a difference of opinion about the crew's ability to detect this condition, the default strategy would also have required that these functions be classified as hidden.

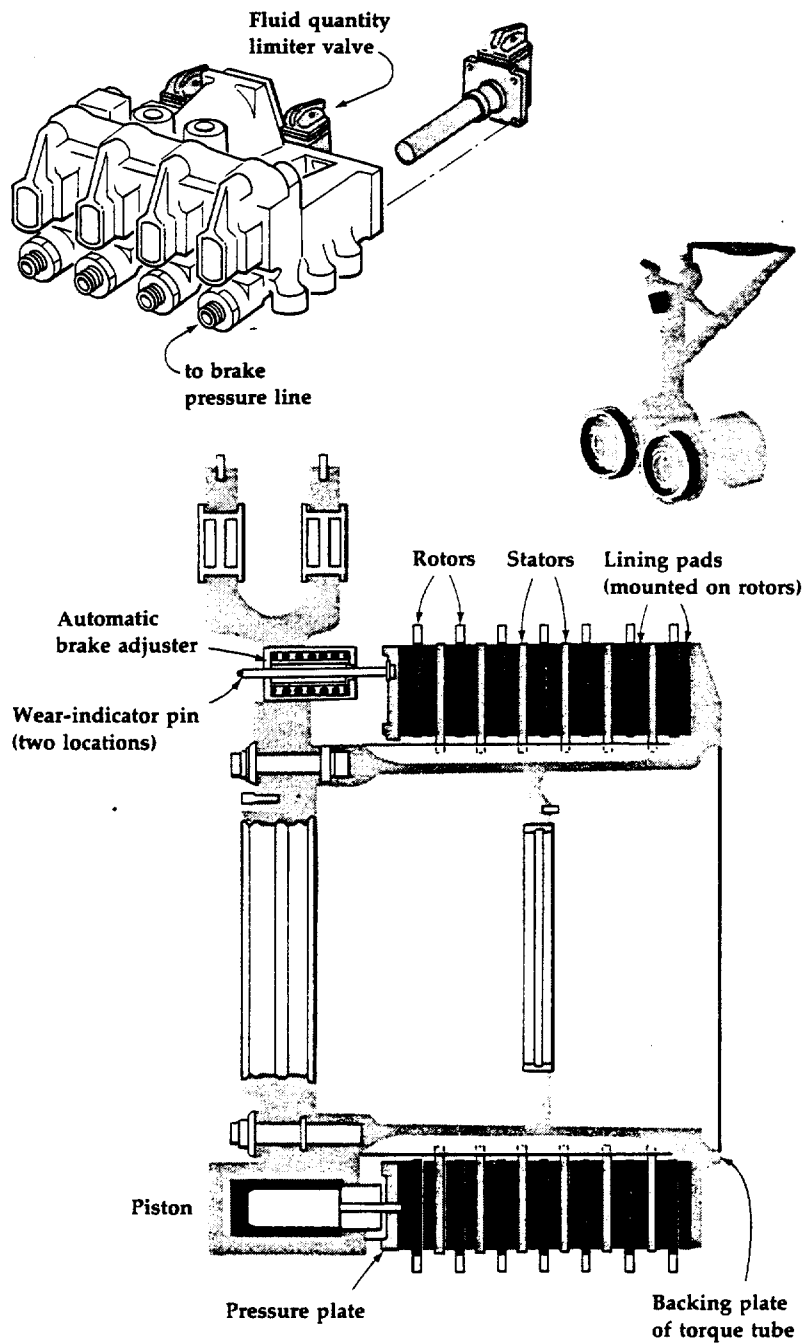

EXHIBIT 7-9 The brake assembly on each wheel of the main landing gear of the Douglas DC-10. (Based on Goodyear maintenance materials)

EXHIBIT 7-10 An information worksheet for the main-landing-gear brake assembly of the Douglas DC-10.

SYSTEM INFORMATION WORKSHEET type of aircraft Douglas DC-10-10

item number

item name Brake assembly, main landing gear

vendor part/model no. Goodyear 500709

item description

Multiple-plate disk brake (seven rotors and six stators) powered by eight hydraulic-driven pistons. Pressure line to this assembly is included for purposes of analysis.

reliability data

premature-removal rate (per 1,000 unit hours) 1 per 1,000 landings

failure rate (per 1,000 unit hours)

source of data Similar equipment

functions

1 To provide stopping capability on command during ground operation

2 To release brakes

3 To contain hydraulic fluid

functional failures

A No braking action

B Reduced braking action

A Dragging brake

A External hydraulic leaks

page of

no. per aircraft	8	prepared by	F. S. Nowlan	date	3/6/78
system	Landing gear	reviewed by	T. M. Edwards	date	3/6/78
zone(s)	733, 743	approved by		date	

redundancies and protective features (include instrumentation)

One brake assembly in each wheel (four) of each main-landing-gear truck. Separate hydraulic systems power half the pistons in each brake; loss of brake fluid due to failed pressure line to wheel prevented by fluid quantity limiters in each hydraulic system. Engine thrust reverser provides another source of stopping capability. Wheelwell is designed to prevent critical secondary damage by debris from tire failure.

built-in test equipment (describe) Visual wear indicators

Can aircraft be dispatched with item inoperative? If so, list any limitations which must be observed.

Yes. If one brake assembly inoperative, gross takeoff and landing weights must be reduced.

classification of item (check)

significant
 hidden function
 nonsignificant

failure modes

1 Brake wear to point of seizure

1 Broken pressure line

1 Malfunction of aduster assembly

1 Damaged or distorted piston seals

failure effects

Wheel skid, causing tire blowout; audible noise and vibration, possible extensive secondary damage to systems within wheelwell; requires correction before dispatch

No braking action from half the actuating pistons in one assembly, causing reduced braking capability and slightly increased minimum stopping distance

Increased wear of pad and disk; overheating of brake and tire may cause tire fuse plugs to blow, with landing on flat tire and secondary damage from the failure; requires correction before dispatch

Slow loss of hydraulic fluid from one system

A review of the design characteristics of the DC-10 shows that each truck on the main landing gear has four wheels, and each wheel has a multiple-disk brake assembly consisting of seven rotors and six stators (see Exhibit 7.9). The brakes are powered by eight pistons, four of which are driven by one hydraulic system and four by another. Without this extensive replication, especially of the wheels on each truck, reduced stopping capability in one brake assembly might be a critical failure. In this case the failure results only in slightly increased stopping distances. One of the failure effects, however, is a possible tire blowout, with secondary damage caused by rubber thrown from the damaged tire. Brake assemblies can be replaced in the field, but the time required will cause delays. The aircraft can also be dispatched with one assembly inoperative, but only at a great penalty in operating weight. Thus any observed failure of a brake assembly has operational consequences.

Note that in this case the primary function of the brake assembly is subject to two failure possibilities, no braking action and reduced braking action. Each of these functional failures must be considered separately. The first type of failure is no braking action, caused by brake wear:

1 Is the occurrence of a failure evident to the operating crew during performance of normal duties?

If the brake pads are allowed to wear beyond a certain point, they come loose from the rotor and jam between the rotors and stators, causing the brake to seize. The wheel will therefore not rotate on landing, and the tire will skid and blow out, throwing pieces around the wheelwell. The resulting noise and vibration would be evident to the flight crew; thus the answer to this question is yes.

With a yes answer to question 1 we must now consider the possible consequences of this failure:

2 Does the failure cause a loss of function or secondary damage that could have a direct adverse effect on operating safety?

The loss of braking function for one of the eight wheels is not in itself critical, so the answer to the first part of this question is no. The answer to the second part is also no, because this failure has been taken into account in the design of the wheelwell, so that secondary damage from occasional tire failures will not be critical.

Although a scheduled task is not required for safety reasons, the secondary damage does have serious operational consequences:

3 Does the failure have a direct adverse effect on operational capability?

In addition to the time required to exchange the brake assembly, this particular type of failure can result in extensive damage to hydraulic lines, flight-control surfaces, and other fail-safe systems. Thus the secondary damage alone may prevent the airplane from being dispatched. Such a failure therefore has serious economic consequences, and we must consider the possible preventive tasks.

The first choice is an on-condition task directed at detecting brake wear:

8 Is an on-condition task to detect potential failures both applicable and effective?

This brake assembly is equipped with wear indicators that show when the pad and disk stack have reached a wear level that calls for replacement. Since the wear indicators make it possible to define a potential-failure condition, an on-condition task is applicable; it will also be effective as long as the inspection interval is short enough to ensure sufficient remaining pad to keep the brake from locking.

In an initial program inspection of the wear indicators might be assigned for every overnight layover at a maintenance station, since this would be a convenient time to change brake assemblies if a potential failure is found. The brake assembly will ordinarily be removed if the wear indicator shows that fewer than 20 more landings are possible. The wear indicators will also be checked at every preflight walkaround, but the wear criterion will be less stringent. The objective is for the overnight mechanics to be the first to identify the need for a brake change, to reduce the number of delays incurred by the discovery of potential failures in the field.

The second type of functional failure, reduced braking action, is caused by a broken pressure line—the line from the fluid quantity limiter to the brake assembly itself. (These lines are treated as part of the brake assembly because the limiters and lines are independent for each system to each wheel.) Analysis of this failure possibility takes us again to the first question in the decision diagram:

1 Is the occurrence of a failure evident to the operating crew during performance of normal duties?

A broken pressure line will result in a loss of function for only half the actuating pistons in the affected assembly, as the limiter stops the flow of hydraulic fluid when the line breaks. Thus the other four pistons in the assembly will still provide normal braking action. There is sufficient braking margin that the slight reduction in braking capability would not come to the attention of the operating crew—that is, the failure would not be evident.

A no answer to the first question means that a scheduled task is required to ensure that the failure will be found and corrected, and further analysis falls in the hidden-function branch of the decision diagram. In this case either one of the directly preventive tasks or a failure-finding task must be assigned to avoid the risk of a multiple failure. The choice depends on technical feasibility and relative cost.

14 Is an on-condition task to detect potential failures both applicable and effective?

EXHIBIT 7-11 A worksheet showing the results of RCM analysis of the Douglas DC-10 brake assembly. References in the first column are to the functions, functional failures, and failure modes listed in Exhibit 7.10.

SYSTEM DECISION WORKSHEET type of aircraft **Douglas DC-10-10**

item name **Brake assembly, main landing gear**

ref.	consequences	responses to decision-diagram questions																	
		task selection																	
F	FF	FM	1	2	3	4	5	6	7	8	9	10	11	12	13	14	15	16	
1	A	1	Y	N	Y	-	-	-	-	-	Y								
1	B	1	N	-	-	-	-	-	-	-	-	-	-	-	-	-	N	N	N
2	A	1	N	-	-	-	-	-	-	-	-	-	-	-	-	-	-	Y	
3	A	1	N	-	-	-	-	-	-	-	-	-	-	-	-	-	N	N	N

On-condition inspections are not applicable for this failure mode because we cannot define a condition that will preclude functional failures. This brings us to the question of a rework task:

15 Is a rework task to reduce the failure rate both applicable and effective?

At the time the initial program is developed there is no information to indicate that a rework task is applicable and will be cost-effective; hence the answer to this question is no.

16 Is a discard task to avoid failures or reduce the failure rate both applicable and effective?

Once again, there is no information to support the applicability of an economic-life limit, so the answer in an initial program is no. A failure-

page of
item number

prepared by **F. S. Nowlan**

reviewed by **T. M. Edwards**

proposed task

initial interval

Inspect brake wear indicators

During walkaround checks and overnight stops

Inspect for broken lines (failure finding)

During walkaround checks and overnight stops

Test automatic brake adjuster

Whenever brake assembly is in shop

Inspect for external leaks (failure finding)

During walkaround checks and overnight stops

SECTION 7-3 185

185

finding task is therefore required – an inspection during preflight walk-arounds and overnight layovers to check for broken lines.

In addition to its primary function of providing stopping capability, the brake assembly has two further functions. It must be capable of releasing the brake, so that it does not drag, and it must contain the hydraulic fluid. Brake drag is caused by a malfunctioning automatic brake adjuster, and this subassembly is not visible unless the brake assembly is removed and disassembled. In most cases the only effect of this failure is increased brake wear, which will show up on the brake wear indicator. Thus the brake assembly will eventually be removed for repair as a result of the on-condition task already scheduled, and the automatic adjuster can then be checked and adjusted as necessary while the assembly is in the shop. In a few cases the failure effects may include overheating of the brake assembly, pulling of the brake on one side, a blowout of the tire-pressure plug, and possibly a landing on a flat tire – in short, the same ultimate effects as those caused by a locked brake. In this event the failure would be evident to the operating crew; however, the same additional task would apply in either case: a shop specification to inspect the automatic brake adjuster on all brake assemblies that come in for repair.

The last type of failure, hydraulic leaks caused by damaged or distorted seals, results in a slow loss of fluid from the hydraulic system. Like the broken pressure line, this failure possibility falls in the hidden-function branch. If some leakage were permitted, so that a slight leak could be defined as a potential failure, an on-condition task would be applicable. In this case, however, any leak is defined as a functional failure. Rework and discard tasks are not applicable for this failure mode, so the only choice, by default, is a failure-finding task, an inspection during preflight walkarounds and overnight layovers for external leaks.

The results of this analysis are summarized in Exhibit 7.11. Note that we have discussed four types of functional failures, all of which could ultimately affect the stopping capability of the airplane. If we had treated reduced stopping capability as a single functional failure, we would have considered exactly the same failure modes and identified exactly the same inspection tasks for inclusion in the program.

ANALYSIS OF A HIGH-FREQUENCY COMMUNICATIONS SUBSYSTEM

The information worksheet in Exhibit 7.12 describes the high-frequency communications system used for voice communications on Boeing 747 aircraft operated on long overwater flights. This system consists of two identical subsystems which are completely independent of each other, right down to the antennas and the source of electrical power from the airplane's power-supply system. Thus either subsystem provides the full system function. Additional sources of voice communication are

provided by a separate very-high-frequency system. Each of the sub-systems consists of numerous assemblies and components, all of which have specific functions. However, failure of any one of these components results in only three types of failure in terms of communications: inability to transmit, inability to receive, or inability to select the desired channel (frequency).

1 Is the occurrence of a failure evident to the operating crew during performance of normal duties?

The failure effects described in Exhibit 7.12 show that any of these three basic types of failure will immediately be evident to the operating crew. Hence the answer to the first decision question is yes.

2 Does the failure cause a loss of function or secondary damage that could have a direct adverse effect on operating safety?

Because of system redundancy, none of the failures will result in a loss of the system function and will therefore not affect operating safety, so the answer to this question is no.

This brings us to the question of operational consequences:

3 Does the failure have a direct adverse effect on operational capability?

Most of the major assemblies in this item are plug-in/plug-out units and can be changed very quickly after a failure has occurred. The time required to replace a failed unit may result in no delay if the failure is reported at a maintenance station, but it will cause a delay if the failure report is received at a nonmaintenance station. Since both subsystems must be operative before the plane can be dispatched, a failure is considered to have operational consequences. This means that the item must be classified as significant.

At this point we would ordinarily examine each failure mode to find preventive tasks that are both applicable and cost-effective. However, past experience with this type of system has shown that, although each major assembly is subject to many failure modes, current technology provides no means of detecting reduced failure resistance. There are therefore no applicable forms of on-condition inspection. We would not expect scheduled rework to reduce the failure rate in a complex item, and in fact it does not. By the same token, discard tasks are not

EXHIBIT 7-12 An information worksheet for the high-frequency communications subsystem in the Boeing 747.

SYSTEM INFORMATION WORKSHEET type of aircraft **Boeing 747**

item number

item name **High-frequency communications subsystem**

vendor part/model no. **All models**

item description

Communications subsystem consisting of receiver, transmitter, power modulator, frequency-selector panel, antenna coupler, accessory unit, lightning arrester, and boom antenna.

reliability data

premature-removal rate (per 1,000 unit hours)

failure rate (per 1,000 unit hours)

source of data

functions	functional failures
1 To transmit voice signals	A No output
2 To receive voice signals	A No reception
3 To select desired channel	A Failure to tune to selected channel

no. per aircraft	2	prepared by	F. S. Nowlan	date	3/6/78
system	Communications	reviewed by	E. S. Wagner	date	3/6/78
zone(s)		approved by		date	

redundancies and protective features (include instrumentation)

The system consists of two identical independent subsystems which can be used simultaneously for transmitting or receiving on any frequency. Backup systems include a very-high-frequency system for relay of messages and SELCAL (selective calling), which allows ground stations to ring bell in cockpit to notify crew of call.

built-in test equipment (describe) Fault-annunciator panel on accessory unit

Can aircraft be dispatched with item inoperative? If so, list any limitations which must be observed.

No

classification of item (check)

- significant
- hidden function
- nonsignificant

failure modes

failure effects

- | | |
|---------------------------------|--|
| 1 Many | No voice amplification, no response to transmission; loss of backup-frequency transmitting capability |
| 1 Many | No background noise from receiver, no messages heard; loss of backup-frequency monitoring capability |
| 1 Failure of frequency selector | No response to transmission on expected frequencies; possible loss of backup-frequency monitoring capability |

SYSTEM DECISION WORKSHEET type of aircraft **Boeing 747**

item name **High-frequency communications subsystem**

		responses to decision-diagram questions																
ref.		consequences						task selection										
F	FF	FM	1	2	3	4	5	6	7	8	9	10	11	12	13	14	15	16
	1	A	1	Y	N	Y	-	-	-	-	N	N	N					
	2	A	1	Y	N	Y	-	-	-	-	N	N	N					
	3	A	1	Y	N	Y	-	-	-	-	N	N	N					

EXHIBIT 7-13 A worksheet showing the results of RCM analysis of the Boeing 747 high-frequency communications subsystem. The references are to the functions, functional failures, and failure modes listed in Exhibit 7.12.

applicable. We must therefore conclude that this system cannot benefit from scheduled maintenance. If operating experience shows that its reliability is inadequate, especially as the result of a dominant failure mode, design changes directed at the faulty component will be the only way of overcoming the problem. The results of this analysis are shown in Exhibit 7.13.

ANALYSIS OF OTHER TYPICAL SYSTEMS ITEMS

The failure of a hidden function cannot, by definition, have a direct effect on operating safety. In some cases, however, the consequences of a multiple failure involving the loss of this function can be critical. This situation is characteristic of emergency equipment, where the demand for a hidden function arises as the result of some other failure. Two examples are the powerplant fire-warning system and ejection-seat pyrotechnic devices. All such items must be protected by some scheduled task to ensure that the hidden function will be available if it is needed.

The powerplant fire-warning system is active whenever an airplane is in use, but its function is hidden unless it senses a fire. Although some warning systems include fault indicators, certain failure modes can result in a loss of function that is not shown by the indicators; consequently this system is always classified as a hidden-function item. However, the required failure-finding task is not necessarily performed

page of
item number

prepared by F. S. Nowlan

reviewed by E. S. Wagner

proposed task

initial interval

None. There are no applicable and effective scheduled-maintenance tasks for this system.

by the maintenance crew. In this case it is specified as part of the duties of the operating crew. The crew tests the system before each flight by means of a built-in self-test circuit.

The pyrotechnic device in an ejection seat is also a hidden-function item that requires a high degree of availability. Pyrotechnic materials deteriorate with age whether they are installed or not, so a discard task is applicable to this item. In an initial program the task interval is set either conservatively low or at a life limit based on previous experience with the same item in other aircraft. All units are tested when they are removed from service to see whether they would have worked, and the interval is adjusted as necessary on the basis of the test results. The cool-gas generator for the inflatable evacuation chute of passenger aircraft is accorded the same treatment.

Although systems items in commercial transport airplanes rarely fall in the safety branch of the decision diagram, not all systems components can be protected by redundancy. One example is the hydraulic landing-gear actuator, which powers the mechanism that raises and lowers the landing gear. If the actuator fails to retract the gear, the airplane must return to the point of takeoff. If it fails to extend the gear, the gear can still be extended by a free-fall feature. In either case the loss of function does not affect safety, but one of the failure modes does cause secondary damage.

One failure mode for these actuators involves cracking or separa-

tion of the endcap as a result of fatigue, perhaps accelerated by pitting corrosion. This type of failure may cause secondary damage to the aircraft structure, but only in the unlikely event of certain multiple failures. The structural damage in this case does not affect safety, but it does have major operational consequences, since any structural repairs take the entire aircraft out of service. Pitting corrosion, which will greatly shorten the fatigue life of the endcap, is visible when the actuator is disassembled in the shop. An on-condition inspection for corrosion is therefore applicable and would be scheduled as part of any shop visit of the landing-gear actuator. However, the primary failure process is fatigue, and it is not feasible to inspect the endcap often enough to detect fatigue cracks at the potential-failure stage. Scheduled rework is not applicable for this failure mode. A discard task would take care of the fatigue problem, but this particular cap was designed for a fatigue life greater than the expected service life of the airplane; hence a life limit was considered unnecessary.

7.4 ESTABLISHING TASK INTERVALS

initial intervals
the role of age exploration

At the time an initial maintenance program is developed there is usually enough information to determine the applicability of on-condition and failure-finding tasks. However, the information needed to determine optimum inspection intervals is ordinarily not available until after the equipment enters service. In many cases previous experience with the same or a similar item serves as a guide, but in the absence of actual operating data it is necessary to set conservatively short intervals for all tasks and increase them on the basis of age exploration. Thus on a new aircraft the tires and brake wear indicators are ordinarily checked once a day to determine the rate of reduction in failure resistance under actual operating conditions. Once this has been established, precise limits can be defined for potential failures and the inspection intervals can be adjusted as necessary.

Scheduled rework tasks have proved to be ineffective for complex items in systems, and in any case, the information required to determine their applicability is rarely available until sufficient operating experience has accumulated for an actuarial analysis. Occasionally prior experience or concern about the economic impact of failures leads to the specification of rework tasks in an initial program. Seven items were specified for rework in the Douglas DC-10 program and eight in the Boeing 747 program. The DC-10 generator control unit was scheduled for rework at an initial interval of 3,000 hours, the DC-10 high-pressure bleed-control valve at an interval of 8,000 hours, and the Boeing 747 generator at an interval of 5,000 hours.

The intervals for safe-life items are known at the outset, since these are established by the manufacturer. Economic-life discard tasks for simple items such as hydraulic lines may be anticipated in an initial program, but they are rarely included at this stage. Like rework tasks, there is no basis for establishing a cost-effective interval until the equipment begins to age in service. The role of age exploration, especially in monitoring the performance of the many systems assigned to no schedule maintenance, is discussed in detail in Chapter 11.

rcm analysis of powerplants

THE POWERPLANT division of an airplane includes only the basic engine. Engines are complex, however, and are subject to numerous forms of failure, most of which are expensive and some of which are critical. Moreover, nearly all powerplant failures have operational consequences, since it is usually necessary to remove an engine and install a replacement after a failure has occurred. Thus the cost of failure includes both operational consequences and the support cost of very expensive replacement units, in addition to the high cost of corrective maintenance. For all these reasons there is a particularly strong incentive to find applicable and effective preventive tasks.

The powerplant is accompanied by a number of engine-driven accessories, such as the fuel pump and the fuel-control system. On some types of engines the thrust reverser is also an accessory, rather than an integral part of the engine. These accessories, as well as their connecting links to the engine, are treated as part of the systems division. However, some of the failure possibilities to which they are exposed will influence the functioning of the engine itself; a fuel-pump failure, for example, may cause an engine flameout. It is therefore important for the study group working on the powerplant program to review the analyses of the essential engine accessories.

Because of its complexity a turbine engine is subject to a great many types of failures, most of which never reach the functional-failure stage. While potential failures may result in age-related removals, particularly if there are dominant failure modes, the residual failure rate—those failures seen by the operating crew—remains relatively constant at all ages because of the large number of failure modes involved. This fact has several implications for a scheduled-maintenance program. First of all, because those functional failures that cannot be

prevented by on-condition tasks occur at widely disparate ages, scheduled overhaul of the entire engine at some particular age will do little or nothing to improve its reliability. However, engine removals for both potential and functional failures result in a continual flow of engines to the shop throughout their operating lives, thus providing the opportunity for a more effective form of protection through on-condition tasks scheduled as part of the repair process. New engines in particular supply an abundance of such opportunity samples, and the assignment of internal engine parts to inspections for intensive age exploration is an important part of the initial powerplant program

8·1 CHARACTERISTICS OF POWERPLANT ITEMS

The operating gross weights of transport aircraft are not only restricted by structural considerations; they are also restricted flight by flight to ensure that a multiengine airplane will have a specified performance capability, measured as available rate of climb, after a complete loss of thrust from one engine (in some cases two engines). Hence the airplane is capable of safe operation with one engine inoperative as long as the remaining engines meet specified performance requirements. For this reason the basic function of an aircraft engine is defined as the capability of providing a specified amount of thrust, without vibration and at acceptable levels of other operating parameters. If an engine cannot perform this function, a functional failure has occurred. This failure may range from a complete loss of thrust (an engine shutdown) to insufficient thrust, caused, for example, by high exhaust-gas temperatures. In aircraft other than civilian transport airplanes the basic function of the

the basic engine function
design characteristics
maintenance characteristics

engine can still be stated in terms of specified thrust, but the consequences of a functional failure might be quite different. In a single-engine aircraft, for instance, a significant loss of thrust would have a direct effect on operating safety, since there is only one source of power.

Cockpit instruments enable the operating crew to monitor most aspects of engine performance, such as compressor rotation speed, exhaust-gas temperature, fuel flow, oil pressure, oil-inlet temperature, and the engine pressure ratio. The engine pressure ratio is correlated with engine thrust, and power is set by advancing the throttle until a desired pressure ratio is reached. Ordinarily power will be obtained at an exhaust-gas temperature well below the maximum limit. However, when there is deterioration that reduces combustion efficiency or the efficiency of gas flow through the engine, more throttle movement, and hence more fuel consumption, is needed to obtain the same power. Consequently the exhaust-gas temperature is increased, and the engine may become temperature-limited even though no parts within it have failed. An engine failure of this kind always has operational consequences because, although a multiengine airplane can safely complete its flight with one engine inoperative, it cannot be dispatched in this condition.

In addition to failures resulting from inefficient engine performance, an aircraft engine is subject to numerous other failure modes, some of which cause secondary damage that presents a safety hazard. For both these reasons the engine as a whole must be classified as a significant item; a functional failure may have safety consequences and always has major economic consequences. If the engine is partitioned into smaller items, by module or by stage, many of its components will also be classified as significant items.

As an example, consider the Pratt & Whitney JT8D engine, which is in use on such aircraft as the Boeing 737, the Douglas DC-9, and the Boeing 727. This turbine engine has five general sections, as illustrated in Exhibit 8.1. The compressor section consists of two axial-flow compressors, a front low-pressure compressor with six stages and a rear high-pressure compressor with seven stages. Each compressor is built up from individual disks for each stage. These disks rotate, and small blades attached to their peripheries compress the air as it flows by them. Air from the inlet section of the engine flows into the front compressor. The first two stages of this compressor are fan stages, and some of the air that flows through them bypasses the other compressor stages; the rest moves on to higher stages, with its pressure increased at each successive stage. The compressed air then enters the nine-can (annular) combustion chamber. Fuel is added to the air, the mixture is burned, and the expanding gases flow through a four-stage turbine and finally pick up speed as they are expanded out of the exhaust nozzle, thereby creating thrust.

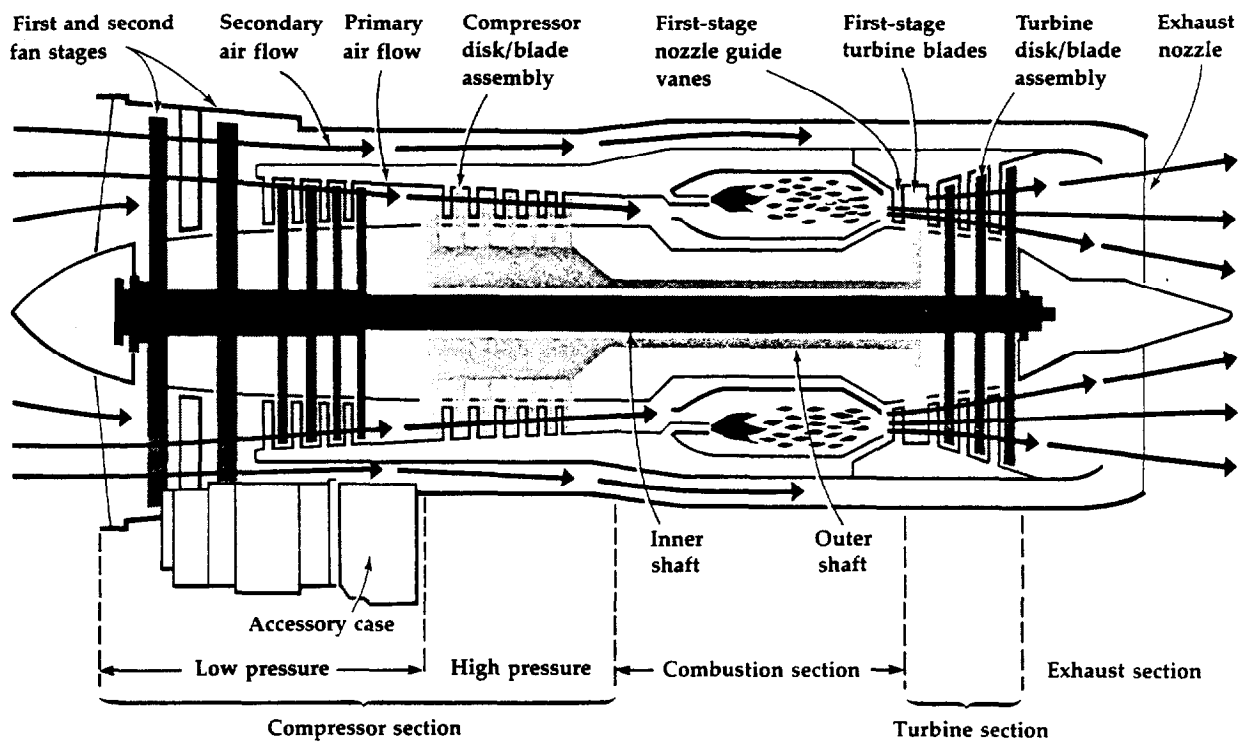

EXHIBIT 8-1 Schematic diagram of the Pratt & Whitney JT8D turbine engine. The thrust reverser is not shown. (Based on Pratt & Whitney training materials)

Each stage of the turbine is a disk with blades on its periphery, somewhat like the compressor stages. The forward stage of the turbine drives the high-pressure compressor and the other three stages drive the low-pressure compressor by means of concentric rotor shafts. Power is taken from the outer shaft by bevel gears and directed down a towershaft to the main accessory case. Each accessory attached to this case is driven by a spline-pinion connection to the main gear. Plenum rings and ports built into the engine case bleed off air from the sixth, eighth, and thirteenth stages of the compressor and direct it into ducting; this high-pressure air supplies the pneumatic system for cabin pressurization, air conditioning, anti-icing, thrust-reverser actuation, and engine cross-starting capability.

The thrust reverser is an accessory on the JT8D engine and would ordinarily be analyzed as a systems item. However, in some installations it is attached in such a way that it is removed along with the basic engine, and on other types of engines it is often part of the basic engine. For convenience, therefore, we will consider it as a powerplant item in this case. The thrust reverser is mounted behind the exhaust nozzle.

It is of the mechanical-blockage type and moves two clamshell-shaped deflectors into the exhaust stream on the pilot's command. The deflected exhaust is then redirected forward by a panel of cascade vanes mounted on each side of the engine. The reverser is actuated pneumatically by a system of controls, valves, actuators, linkages, and plumbing.

When the engine is partitioned into modules (systems), sections (subsystems), and stages (assemblies), some modules will be found to contain very few parts that are not significant. In a compressor, for example, the disks, hubs, and shafts are all significant items. Failures of most of the rotating parts and parts exposed to the gas path will be evident to the operating crew from the cockpit instruments; they will therefore have operational consequences. Failures of nonrotating, non-gas-path parts, many of which form plenums (containing gases under pressure) or reservoirs (containing operating fluids such as oil) may not be evident and will require scheduled inspections for this reason. In short, there are very few parts of an engine that do not require some form of scheduled maintenance.

Because of the great number of failure modes to which an aircraft engine is exposed, RCM analysis of powerplant items may fall in any of the four branches of the decision diagram. Many engine parts are subject to failures with critical secondary damage and will therefore be assigned safe-life discard tasks. In an initial powerplant program, however, the most frequent outcome in any consequence category is an on-condition task, with intensive inspection of certain items as part of the age-exploration plan. One reason for this is that corrective maintenance on engines is responsible for more than half the support cost for any airplane, and even when fractured parts do not cause hazardous damage, they may cause damage that is very expensive to repair. Another reason, of course, is to avoid the safety and operational consequences of a functional failure.

On-condition inspections of powerplant items are performed at two levels, depending on the accessibility of the item. Many items can be inspected visually or by borescope and radiography techniques while the engine is on the aircraft. Most internal engine parts cannot be inspected without a certain amount of disassembly. These parts are therefore assigned on-condition inspections in the shop when the engine is being disassembled for repair. When the combustion-chamber retaining lug is removed, for example, a plug gage is fitted into the lug. If the fit meets specifications the combustion chamber can be reinstalled as is; otherwise it is routed to repair.

Whereas on-condition inspections on installed engines are performed at fixed intervals, the shop inspections of internal engine items are scheduled on the basis of *opportunity samples*, sometimes with a maximum age interval as a precaution. Opportunity samples take advantage of the fact that with large fleets of multiengine airplanes there

will be a sufficient flow of engines through the shop to provide continuing exposure of all the major parts. During the first few years of operation, when the fleet is small, the failure rate is usually also at its highest, which automatically brings a larger number of engines to the shop. These frequent shop visits not only provide information on the items that have failed, but also permit easy inspection of all the parts that must be removed to gain access to the failed item. Thus, in addition to the on-condition tasks that are known to be applicable, in an initial program many internal engine parts are assigned such inspections for the purpose of age exploration. Although some of these inspections may prove to have no real on-condition capability, they will be the only source of information on items that are not experiencing failures.

8·2 ASSEMBLING THE REQUIRED INFORMATION

The analysis of significant items in an aircraft powerplant requires a broad knowledge of current maintenance practices, as well as a detailed understanding of the specific engine under consideration. The members of the powerplant working group will know from previous experience the areas of the engine that tend to be the most troublesome in new designs. They will also be familiar with the various forms of on-condition inspection and the uses of opportunity sampling in conducting age exploration. In addition to this background information, the engine manufacturer provides specific information about any new engine by reviewing the design characteristics of the production model with the entire working group. During this process similarities to and differences from in-service types of engines become apparent. The review also pinpoints areas in which new, or relatively new, technology has been incorporated in the design, either to reduce the weight of the engine or to increase its performance capabilities.

New aircraft engines are designed and developed over a period of years preceding certification of the aircraft in which they are installed. Extensive testing is conducted at each stage of development to ensure that a reliable product is being developed. Many different prototype engines are usually used during the certification test flights of the airplane itself, and experience with these engines gives the manufacturer an opportunity to identify and resolve any problems that come to light. In addition, once the engine design is stabilized, several engines are tested in endurance runs, either as part of the engine certification program or as an adjunct to it. Unfortunately this early experience may not be of great use during the development of an initial maintenance program, because the engine will usually have been modified to correct any known problems before the production engines are delivered. The development of an effective powerplant maintenance program thus

initial information requirements
the information worksheet

EXHIBIT 8-2 The data elements needed for analysis of powerplant items.

IDENTIFICATION OF ITEM

Type of aircraft	Quantity per engine
Type of engine	Location (section/module)
Item name	
Manufacturer's part and model number	

ITEM INFORMATION

Item description (general function and major parts)
Redundancies and protective features (including instrumentation)
Built-in test equipment

AVAILABLE RELIABILITY DATA

Anticipated premature-removal rate
Anticipated verified failure rate
Source of data (test data or operating experience)

RCM INPUT

Item functions
Functional failures (as defined for each function)
Most probable failure modes
Predictable failure effects (for each failure mode)
 Evidence of functional failure
 Effects of loss of function on operating capability
 Effects of failure beyond loss of function (including ultimate effects of possible secondary damage)
Nature of failure consequences
Evidence of reduced failure resistance that can be used to define potential-failure conditions
Experience with other engines containing the same or similar item

depends heavily on the knowledge and experience of the working group.

Exhibit 8.2 lists the data elements that must be assembled before analysis begins. Much of this information comes from detailed review of the production model, supplemented by the manufacturer's instruction manuals and test data. The data elements for each item to be analyzed are recorded on an information worksheet like that used for systems items. In the case of powerplant items the manufacturer's identification is usually functionally descriptive in itself. However, the item description should include all major components and should reflect the level of item being considered (see Exhibit 8.3). Where the item is a module or stage, the description should list all the major assemblies it contains.

As with systems items, it is important to list all redundancies and protective features. Bypasses and pressure-relief systems, as well as the extent of the cockpit instrumentation, are all factors in evaluating the consequences of a functional failure. If the engine case is designed to contain fractured parts, this information should be included, since it means that the secondary damage resulting from certain failures will not have safety consequences (although it may have major economic consequences). Ordinarily an aircraft cannot be dispatched with any major engine item inoperative (this information comes from the minimum-equipment list and pertains primarily to systems items). However, a yes answer for an individual part may mean that this item can be classified as nonsignificant, since a functional failure will have no operational consequences.

In listing the functions of an item it is important to describe both its basic function and all secondary or characteristic functions. Each function described should relate in some way to one of the overall engine functions. For example, the basic function of the nozzle guide vanes is to redirect the exhaust gases onto the first-stage turbine blades; a second function is to create the proper nozzle area for efficient engine operation. The functional failures are the inability to perform these functions; note that in some cases there is more than one failure possibility for a given function. The failure modes are the specific ways each type of functional failure can occur. In addition to the failure modes listed for the nozzle guide vanes, rotating parts such as blades and disks are subject to fatigue. Combustion chambers may crack or burn through, or their locating pins may wear. Unless the failure modes are clearly identified, there is no way to determine what preventive tasks might be applicable.

The failure effects identify the immediate results of the failure. These effects include any secondary damage caused by the failure, as well as the impact of the loss of function both on the engine and on the aircraft.

EXHIBIT 8-3 An information worksheet for the first-stage nozzle guide vanes of the Pratt & Whitney JT3D powerplant.

POWERPLANT INFORMATION WORKSHEET type of aircraft **Douglas DC-8**
type of engine **Pratt & Whitney JT3D**

item number

item name **First-stage nozzle guide-vane assembly**

vendor part/model no. **536751/JT3D**

item description

The 63 nozzle guide vanes form a set of airfoils located in the gas path immediately downstream of the combustion-chamber outlet duct. They accelerate and direct hot gases onto the first-stage turbine blades at the proper angle for aerodynamic efficiency.

reliability data

premature-removal rate (per 1,000 unit hours)

failure rate (per 1,000 unit hours)

source of data

functions

1 To redirect gases at the proper velocity and angle

functional failures

A Vanes form improper angle and nozzle area

		page	of
no. per engine	63	prepared by	T. M. Edwards
section	Turbine	reviewed by	T. N. Mix
module		approved by	
		date	6/26/78
		date	6/26/78
		date	

redundancies and protective features (include instrumentation)

Vanes are made of small-grain alloy to resist heat deformation and receive protective coating to resist heat damage and erosion. Vanes are bolted in place to prevent fractured parts from slipping into airstream.

Note: Multiple guide vanes provide no functional redundancy.

built-in test equipment (describe) None

Can aircraft be dispatched with item inoperative? If so, list any limitations which must be observed.

No

classification of item (check)

significant

hidden function

nonsignificant

failure modes

1 Bowing of nozzle guide vanes from heat deformation

2 Erosion of nozzle guide vanes from direct exposure to exhaust-gas particles

failure effects

Progressive loss in engine efficiency, increased fuel consumption and exhaust-gas temperature, and possible high-power stall resulting in engine shutdown; if vanes bow back into turbine-blade path, contact with rotating blades resulting in fracture and critical secondary damage from blade failure

Progressive loss in engine efficiency, leading to possible engine shutdown as for 1 A 1 (no contact with turbine blades)

The description should also specify any physical evidence by which the occurrence of the failure can be recognized by the operating crew. In the case of most engine failures this is an instrument indication, often the exhaust-gas temperature reading. The failure effects must be described for each failure possibility, since they help to determine the consequences of that failure, and hence the priority of maintenance requirements.

As an example, one of the failure modes listed in Exhibit 8.3 for the JT3D engine is bowing of the turbine nozzle guide vanes as a result of prolonged exposure to high temperatures. The effects in this case are progressive. Slight bowing will change the entry direction of the gases, reducing the efficiency of turbine-blade action and causing the exhaust-gas temperature to rise for a given thrust setting. If the temperature is already high because of other deterioration in the engine, the permissible temperature will be exceeded, and the pilot will report a functional failure. However, the exhaust-gas temperature measures the overall efficiency of the engine, and if the limit temperature is not reached, bowing may continue to a point at which the stationary vanes come into contact with the rotating turbine blades. Either the blades or the vanes will fracture, and if the engine case cannot contain the fractured parts, the ultimate effect of bowed guide vanes in this engine design is critical secondary damage. The failure must therefore be classified as having safety consequences.

All the relevant information is examined for each engine item, and the item is then classified as significant or nonsignificant on the basis of its failure consequences. Items in either category may have one or more hidden functions; thus an item may be identified in this initial partitioning process as nonsignificant, but also as having a hidden function. Since all hidden functions must be protected by scheduled maintenance to ensure that failures will be found and corrected, both significant items and hidden-function items must be subjected to full RCM analysis.

The objective of the partitioning process outlined in Chapter 4 is to select the most convenient level of item for analysis. Most powerplant analyses can be conducted conveniently at the module or section level. In this case the failure of any significant item included in the module or section under consideration would constitute a failure mode. For example, if the item selected for study were the turbine section, one of the failure modes would be failure of the first-stage turbine nozzle guide vanes. However, the powerplant itself can also be viewed as an item. While this is only one of several possible approaches, it has certain advantages in sorting the vast number of failure possibilities that must be considered into an organized pattern on the basis of their consequences. In the examples that follow, therefore, we will consider the entire engine as a significant item.

8-3 FAILURES OF THE BASIC ENGINE FUNCTION

The Pratt & Whitney JT8D engine used on the three-engine Boeing 727 is described by the information worksheet in Exhibit 8.4. Although this engine might be analyzed at the module or section level, at the engine level its functions can be defined as follows:

fractures with critical secondary damage
fractures with no critical secondary damage
failures caused by deterioration

- ▶ To provide specified amounts of thrust without exceeding the acceptable levels of the engine operating parameters
- ▶ To drive engine-mounted accessories, such as the fuel pump, oil pump, fuel-control unit, hydraulic pump, and constant-speed drive generator
- ▶ To provide high-pressure air to the pneumatic system for use by subsystems
- ▶ To provide reverse thrust to assist in braking the airplane (assumed as a function of this engine design)

At this point let us consider the first type of engine failure, a failure to provide specified thrust (including complete loss of thrust, or an engine shutdown):

1 Is the occurrence of a failure evident to the operating crew during normal performance of duties?

Any reduction in engine thrust will be evident, because the engine pressure ratio and other instrument readings are closely monitored by the operating crew. When the airplane is in flight, changes in engine output may also be signaled by throttle vibration or audible thumps. Hence the answer to this question is yes.

The next step in RCM analysis would ordinarily be to examine each of the failure modes that might lead to this functional failure. In identifying the probable failure modes, however, it will be found that some involve the fracture of a part that can cause critical secondary damage, whereas others involve a fracture without such damage, and still others involve general deterioration with no fractured parts. For convenience, then, we can group all significant assemblies and parts into these three classes and analyze each *class* of failure modes separately.

FRACTURES WITH CRITICAL SECONDARY DAMAGE

Compressor disks, turbine disks, and turbine blades are typical of the powerplant items whose fracture can cause critical secondary damage. It is apparent from the failure effects described in Exhibit 8.4 that all

EXHIBIT 8-4 An information worksheet for analysis of the Pratt & Whitney JT8D-7 powerplant of the Boeing 727.

POWERPLANT INFORMATION WORKSHEET type of aircraft **Boeing 727**
type of engine **Pratt & Whitney JT8D-7**

item number

item name **Propulsion powerplant**

vendor part/model no. **JT8D-7**

item description

Axial-flow front-turbofan engine with a thirteen-stage split compressor (two spools), a nine-can (can-annular) combustion chamber, and a split four-stage turbine.

reliability data

premature-removal rate (per 1,000 unit hours)

failure rate (per 1,000 unit hours)

source of data

functions

1 To provide specified amounts of thrust without exceeding the acceptable values of engine operating parameters

functional failures

A Engine does not provide specified thrust (including case of no thrust)

no. per aircraft	3	prepared by	T. M. Edwards	date	2/14/78
section		reviewed by	F. S. Nowlan	date	2/14/78
module		approved by		date	

redundancies and protective features (include instrumentation)

The airplane has three engines; operating weight is controlled for all flights so that airworthiness requirements can be met with one engine inoperative. Full instrumentation of all engine operating parameters; each engine protected by fire-warning and fire-extinguishing system.

built-in test equipment (describe) None

Can aircraft be dispatched with item inoperative? If so, list any limitations which must be observed.

No

classification of item (check)

- significant
- hidden function
- nonsignificant

failure modes

1 Failure of parts whose fracture can cause critical secondary damage:

- a Failure of compressor or turbine disks
- b Failure of turbine blades

2 Failure of parts whose fracture does not cause critical secondary damage:

Towershaft bearing or gear failure

3 Failure resulting from general deterioration without the fracture of parts:

Deterioration of combustion chambers, nozzle guide vanes, compressor blades, etc.

failure effects

Immediate loss of thrust or flameout, confirmed by instrument readings; possible critical secondary damage if engine case does not contain fractured parts; pilot will abort takeoff if prior to takeoff-refusal speed, otherwise will land at nearest suitable airport; engine change required

Immediate loss of thrust or flameout, confirmed by instrument readings; operational effects as for 1 A 1; engine change required

Progressive loss of engine efficiency as shown by instrument readings; if desired thrust cannot be obtained without exceeding maximum exhaust-gas temperature, pilot will abort takeoff if prior to takeoff-refusal speed; if airborne may continue flight at reduced power or shut down engine and land at nearest suitable airport; engine change may be required

such failures will immediately be evident to the operating crew. As for any failure of the basic engine function, therefore, the answer to the first decision-diagram question is yes.

The next step in the decision process is to determine the precise nature of the failure consequences:

2 Does the failure cause a loss of function or secondary damage that could have a direct adverse effect on operating safety?

Although the loss of thrust has no safety consequences, all items whose failure involves secondary damage fall in the safety branch of the decision diagram (see Exhibit 8.5).

Disks, for example, are subject to low-cycle fatigue failures, and when they fracture, any fragments that cannot be contained by the engine case can damage the nacelle, wing, or fuselage. Even if these projectiles do not damage the aircraft structure, there is the hazard of hot gases escaping through the torn engine case. Ejected turbine blades present the same hazards. Turbine-blade failures have sometimes occurred with no observable effect on thrust and no other evidence of failure (in this case failure-finding inspections are necessary). However, they have also been known to be ejected and cause critical secondary damage. There is no way of knowing whether this problem has been overcome in the present design, so in the interests of conservatism the blades have been included in this class of items.

The next step is to evaluate proposed scheduled-maintenance tasks. A yes answer to the safety question means that no task can be considered effective unless it reduces risk of a functional failure to an acceptable level. From this point on, however, we must examine each failure mode separately, because the applicability of a particular task will depend on the failure characteristics of the part. Our next question therefore concerns a possible maintenance task for the disk:

4 Is an on-condition task to detect potential failures both applicable and effective?

A low-cycle fatigue failure begins as a slip along crystallographic planes in the metal, which progresses under repeated load applications until a small crack eventually becomes visible. After this point, however, the crack propagates very rapidly to the point of fracture. Most of the disks are also inaccessible in the installed engine; thus even if it were possible to define the crack as a potential-failure condition, the engine would have to be removed and disassembled more frequently than is feasible. An on-condition task is therefore not applicable to the disk.

method has been found that will eliminate the material's "memory" of repeated loads, so the answer to the rework question is no.

6 Is a discard task to avoid failures or reduce the failure rate both applicable and effective?

Because on-condition inspections are not applicable, the manufacturer has established a safe-life limit for the disk in each stage of the compressor and the turbine. One engine manufacturer uses a computer model, based on material strength tests and stress calculations, that simulates the in-service aging of the disk. This model has been validated by the results of developmental spin testing of many different disks used in various engine designs. The safe-life limit determined by this technique is the operating age at which one disk per 1,000 will develop a crack of 1/32 inch. The disks are designed to have safe lives ranging from 10,000 to 20,000 hours, and these are the intervals that will be used for the discard tasks.

The answer to the discard question is yes, and the analysis of this failure mode is complete. Each type of disk is assigned a discard task scheduled for the safe-life limit established for that disk. In this case an on-condition task might also be assigned—an inspection for any damage that might prevent attainment of the safe-life age, to be performed whenever the disks are accessible during the normal course of repair work on the engine.

The failure process in turbine blades is somewhat different from that in disks. The blades are in a hot-gas stream that exerts aerodynamic forces on them. The forces pulsate as the blades pass by the stationary guide vanes, with the result that the blades are also subject to fatigue failure. The propagation of fatigue cracks in blades, however, is much slower than it is in disks. In addition, the blades are subject to creep and oxidation caused by the high temperature of the gases and to erosion from solid particles in the gas. In this case on-condition inspection is more promising:

4 Is an on-condition task to detect potential failures both applicable and effective?

Potential failures can be defined for such conditions as oxidation, erosion, blade-root wear, and fatigue cracks; therefore an on-condition task is applicable. It will also be effective, since the blades can be inspected at short enough intervals to ensure that potential failures will preempt functional failures. Thus the answer is yes, and analysis of this failure mode is complete.

On-condition tasks for the blades would probably be specified at two levels—on the aircraft and in the shop. For example, a borescope inspection of all turbine blades on installed engines might be assigned at an initial interval of 150 operating hours, with a “broomstick” check of the fourth-stage turbine blades for looseness scheduled at intervals of 300 to 400 hours. In addition, as part of the opportunity-sampling program, an inspection of the blades for creep, heat deterioration, cracks, and wear at the roots would probably be scheduled for every shop visit of the engine, with a threshold age of 500 hours.

Note that on some engines the first-stage turbine nozzle guide vanes would also fall into the class of items whose failure can cause critical secondary damage. The nozzle guide vanes on the JT3D engine, described in Exhibit 8.3, would therefore be analyzed through the safety branch of the decision diagram. This engine has a hollow shaft through which an isotope pill can be inserted to expose radiographic film placed on the engine case at the outer ends of the vanes. The exposed film shows the amount of bowing that has occurred, and also the remaining clearance between the vanes and the adjacent turbine blades. Thus an on-condition task is applicable, and it would be scheduled at intervals short enough to prevent all critical failures.

In the engine under consideration here the same task would apply. However, the JT8D engine has been designed so that bowing of the nozzle guide vanes will cause the exhaust-gas temperature to reach the limit before the vanes reach a state in which they can intersect the turbine plane. Thus the ultimate effect of this failure mode in the JT8D engine is a functional failure caused by engine inefficiency, rather than a failure with critical secondary damage.

FRACTURES WITH NO CRITICAL SECONDARY DAMAGE

The second class of powerplant items is subject to fractures that do not cause critical secondary damage (although the secondary damage is often expensive). Typical items in this class are the towershaft bearing and the towershaft gears. Failure of either of these items will result in inability to drive the engine-mounted accessories, including the fuel pump, and the engine will flame out. We know, therefore, that the failure will be evident to the operating crew. Since a loss of thrust is not critical and this class of failure modes has no critical secondary effects, we also know that there are no safety consequences.

A no answer to the safety question brings us to the question of operational consequences:

3 Does the failure have a direct adverse effect on operational capability?

surfaces, and when the integrity of the hard surface has been lost, complete disintegration proceeds rapidly.

8 Is an on-condition task to detect potential failures both applicable and effective?

In some cases fragments of shed metal can be detected by inspection of magnetic plugs and oil screens, and the existence of these metal particles can be defined as a potential failure. While such inspections are applicable, they miss a large number of potential failures. They are cost-effective, however, because the discovery of even one potential failure more than offsets the cost of years of such inspections. Thus the answer is yes for these tasks, and they would be included in the program.

The real control of gear and bearing failures comes from on-condition inspections performed when the engine is in the shop. Visual inspection of the balls, rollers, races, and gear teeth for cracking, wear, or deformation, using 10- to 30-power magnification, has been found to identify most potential failures. The bearings and gears are put in the opportunity-sampling program to establish the optimum interval for shop inspections, and the analysis of these items is complete.

FAILURES CAUSED BY DETERIORATION

Whereas fractured parts can cause extensive secondary damage—with or without safety consequences—a large number of engine failures are the result of deterioration that does not involve the fracture of any part. When some part of the engine is not functioning efficiently, more and more throttle is required to attain the desired thrust. This increases the fuel flow, and thus the exhaust-gas temperature, which may further accelerate deterioration of the parts involved. Eventually one of the engine operating parameters, usually the exhaust-gas temperature, will be exceeded before the desired thrust is reached, and a functional failure of the engine has occurred. Items involved in this class of failure modes are the airseals, compressor blades, combustion chambers, and in this engine the turbine nozzle guide vanes.

The reduction in engine power is evident to the operating crew and has no safety consequences. Such failures will still have operational consequences, however, because the engine may be replaced after the airplane lands. Hence analysis of the items in this category also falls in the operational-consequences branch of the decision diagram, where scheduled maintenance is desirable if it is cost-effective.

Compressor blades are exposed to erosion and airseals to wear, causing losses in aerodynamic efficiency. Since the burner cans and the turbine nozzle guide vanes are in the gas path, they are also subject to

EXHIBIT 8-7 A worksheet showing the results of analysis for the primary engine function of the Pratt & Whitney JT8D-7 powerplant. The references in the first column are to the failure modes listed for the primary engine function in Exhibit 8.4.

POWERPLANT DECISION WORKSHEET type of aircraft **Boeing 727**
 type of engine **Pratt & Whitney JT8D-7**

item name **Propulsion powerplant**

ref.	consequences			responses to decision-diagram questions														
	1	2	3	task selection														
F	FF	FM	1	2	3	4	5	6	7	8	9	10	11	12	13	14	15	16
1	A	1a	Y	Y	-	N	N	Y										
1	A	1b	Y	Y	-	Y												
1	A	2	Y	N	Y	-	-	-	-	-	-	-	-	-	-	-	-	Y
1	A	3	Y	N	Y	-	-	-	-	-	-	-	-	-	-	-	-	Y

prepared by T. M. Edwards reviewed by F. S. Nowlan

proposed task	initial interval
Remove and discard all compressor and turbine disks at life limit	Manufacturer's safe-life limit for each type of disk
Borecope inspection of all turbine blades	50 flight cycles or 150 hours, whichever is first
Broomstick check of fourth-stage turbine blades for looseness	300 to 400 hours
Inspect all turbine blades for wear, creep, and cracking	During engine shop visit; use opportunity sampling to establish best frequency, initial threshold 500 hours
Check magnetic plugs and screens for metallic particles	300 to 400 hours
Inspect all towershaft and drive-train elements for wear, deformation, and cracking	During engine shop visit; use opportunity sampling to establish best frequency, initial threshold 500 hours
Borecope inspection of combustion chambers, nozzle guide vanes, liners, supports, and seals visible through hot-section access ports	50 flight cycles or 150 hours, whichever is first
Borecope inspection of seventh- to thirteenth-stage compressor blades, stators, spacers, and seals visible through compressor access ports	150 flight cycles or 450 hours, whichever is first
Inspect all rotating parts, gas-path parts, hot-section parts, and main bearings for wear, deformation, and cracking	During disassembly for engine repair; use opportunity sampling to establish best frequency, initial threshold 500 hours

heat deformation. All these deterioration processes occur slowly and at a relatively constant rate, a situation which favors on-condition inspections:

8 Is an on-condition task to detect potential failures both applicable and effective?

The answer is yes for most of these items, such as compressor blades, combustion chambers, and nozzle guide vanes. Their condition can be ascertained by borescope or radioisotope inspections while the engine is still installed, and the rate of deterioration is slow enough to identify at the potential-failure stage.

Since the hot section usually suffers the most rapid deterioration in a new engine, borescope inspections might be scheduled for the combustion-chamber outlets, nozzle guide vanes, and surrounding liners, supports, and seals at an initial interval of 50 flight cycles or 150 operating hours, whichever comes first.* Next to the hot section, the high-pressure compressor has the highest rate of deterioration. Thus borescope inspections of the seventh- to thirteenth-stage compressor blades might be scheduled for an initial interval of 150 to 200 flight cycles or 450 to 600 operating hours.

In addition to these scheduled inspections on installed engines, most of the rotating parts, gas-path parts, hot-section parts, and bearings would be assigned to shop inspection of opportunity samples, with an initial age threshold of perhaps 500 hours. During these inspections the dimensions and condition of each part are compared with the "acceptable for service" limits established by the manufacturer. Parts that have deteriorated beyond these limits are repaired or replaced and parts within the limits are returned to service.

Note that taking the engine out of service because the exhaust-gas temperature exceeds a defined limit is in itself a form of on-condition action, since this limit is established to prevent expensive damage to the combustors, turbine blades, vanes, and liners. One might wonder, therefore, why additional on-condition tasks are directed at these items. The reason is that increased exhaust-gas temperature measures the total efficiency of all gas-path parts. Thus the temperature might be within the limit if most parts were in good condition, even if one part—say, the nozzle guide vanes—had deteriorated beyond the point of economical repair. In the interests of economy, then, it is better to inspect the nozzle guide vanes and judge them by their individual condition than to wait for the temperature to reach the limit. This concept becomes increasingly important for in-service engines, which are composed of parts of diverse ages as a result of the normal repair cycle.

*These low initial intervals represent the practices followed in the mid-1960s.

It is also important to bear in mind that this analysis is based on a redundant engine installation. The engine is one of three in a multi-engine airplane. If this engine were installed in a single-engine aircraft, analysis of the same items would lead to completely different results, because in this case a loss of function might in itself constitute a critical failure. The analysis of all failure modes involving a major loss of thrust would therefore fall in the safety branch, where any applicable tasks would be scheduled regardless of cost effectiveness. The criteria for task applicability would remain the same, however; thus scheduled rework would still be applicable only for those engine parts whose conditional-probability curves show both an identifiable wearout age and a high probability of reaching that age without failure. Since an item subject to numerous failure modes rarely satisfies these conditions (see Section 2.8), scheduled rework of the entire engine would be unlikely to make a significant difference in its operating safety.

8·4 FAILURES OF SECONDARY ENGINE FUNCTIONS

In addition to the basic engine function of providing specified thrust, three secondary functions have been listed for the Pratt & Whitney JT8D engine under consideration. These functions and their associated functional failures and failure modes are listed on the continuation worksheet shown in Exhibit 8.8. One of these functions, to drive the engine-mounted accessories, has two failure possibilities: inability to drive any of the accessories and the inability to drive a particular accessory. The failure modes that cause a total inability to drive any of the accessories are associated with bearing and gear failures in the tower-shaft drive train, discussed in the preceding section. The inability to drive individual accessories could be defined as a separate functional failure for each accessory. From the standpoint of the engine, however, we can consider this case as a single functional failure with several failure modes.

failure to drive accessories
failure to supply pneumatic system
failure to provide reverse thrust

The first question, as before, is whether failure of the engine to drive some one of the accessories will be evident:

1 Is the occurrence of a failure evident to the operating crew during performance of normal duties?

The performance of each engine accessory is monitored by means of cockpit instrumentation, and a malfunction of any accessory would be evident from the instrument readings (see Exhibit 8.8). Thus the answer to this question is yes for all failure modes.

EXHIBIT 8-8 Continuation information worksheet for the secondary functions of the Pratt & Whitney JT8D-7 powerplant.

CONTINUATION WORKSHEET type of aircraft **Boeing 727**
type of engine **Pratt & Whitney JT8D-7**

item number

item name **Propulsion powerplant**

vendor part/model no. **JT8D-7**

functions	functional failures
2 To drive the engine-mounted accessories	<p>A Inability to drive any engine accessory</p> <p>B Inability to drive one of the engine accessories</p>
3 To provide high-pressure air to the pneumatic system	A Does not provide sufficient bleed air (pneumatic pressure)
4 To provide reverse thrust for braking assistance	<p>A Inability to provide reverse thrust</p> <p>B Thrust reverser jammed during reverse-thrust sequence</p>

no. per aircraft	3	prepared by	T. M. Edwards	date	2/14/78
section		reviewed by	F. S. Nowlan	date	2/14/78
module		approved by		date	

failure modes	failure effects
1 Failure of main-gearbox drive	Instruments show no output from any accessory; engine flameout; pilot will abort takeoff if prior to takeoff-refusal speed, otherwise will land at nearest suitable airport; engine change required
1 Failure of constant-speed-drive generator splines	Instruments show no output from one generator; crew will disconnect generator from constant-speed drive as a precaution; aircraft can be dispatched with one generator inoperative
2 Failure of hydraulic-pump drive splines	Instruments show no pressure from one pump; crew will disconnect pump for completion of flight; gearbox or engine change required at destination
3 Failure of fuel-pump drive splines or bearings	Instruments show no output from fuel pump; engine flame-out, with operational effects as for 2 A 1; gearbox or engine change required
4 Failure of oil-pump drive bearings	Instruments show loss of oil pressure, requiring engine shutdown; operational effects as for 2 A 1; engine change required
1 Burst saddle duct	Loss of some pneumatic pressure, instruments show increased fuel flow, exhaust-gas temperature, and engine speed; heat damage to insulation and hoses, with probable fire warning resulting in engine shutdown; operational effects as for 2 A 1; engine change required
1 Burst pneumatic-actuator supply duct	Instruments show thrust reverser inoperative, loss of braking assistance from one engine; may require correction before further dispatch
1 Binding due to wear of mechanical components	Instruments show thrust reverser active; correction required before further dispatch

This brings us to the question of possible safety consequences:

2 Does the failure cause a loss of function or secondary damage that could have a direct adverse effect on operating safety?

Failure of certain of the accessory drives, such as those for the fuel pump and the oil pump, can lead to complete loss of thrust from the engine, but an engine shutdown does not in itself affect safety. Recent engines, including this one, have also been designed so that accessory-drive parts do not penetrate the case. There is therefore no exposure to critical secondary damage from these failures, and the answer to this question is no.

3 Does the failure have a direct adverse effect on operational capability?

The airplane usually cannot be dispatched when one of the engine-driven accessories is inoperative (this information would appear on the information worksheets for the pertinent systems items). If the problem is caused by a failure of the internal accessory drive, however, it is necessary to repair or replace the engine before further dispatch. Thus any failure of the accessory drive train has operational consequences, and scheduled maintenance is desirable if it is cost-effective.

To evaluate proposed tasks we must consider the failure process:

8 Is an on-condition task to detect potential failures both applicable and effective?

Spline wear in each of the accessory drive trains is a major source of trouble, and we know that on-condition inspections to measure spline wear are applicable. Hence the answer to this question is yes. The accessory drive shafts, gear, and bearings are assigned to the shop opportunity-sampling program to determine the most effective inspection interval; in addition, the splines in the accessory gear box are scheduled for inspection on the aircraft whenever an accessory is changed.

The third function of the engine is to provide high-pressure air for the pneumatic system, and one failure mode is a burst bleed-air duct. In a powerplant analysis we would be concerned with the ducting that is part of the quick-engine-change assembly; this includes the sixth-, eighth-, and thirteenth-stage saddle ducts. Downstream ducting is analyzed either as part of the pneumatic system or as part of the

system it serves. A burst saddle duct in any of these stages will be evident to the operating crew. Cockpit instrumentation shows the pressure in the duct to the cabin air-conditioning system, but hot air from the duct will also trigger a fire warning, and the free escape of bleed air will affect engine performance.

Because of the fire-warning system, this type of failure is not critical. Although hot thirteenth-stage bleed air may burn wiring insulation and char hoses, the most serious effect is the need to shut down an engine after a fire warning. Such a failure does have operational consequences, however, since the airplane cannot be dispatched until the burst duct is repaired. Thus once again we are concerned only with the cost effectiveness of proposed maintenance tasks.

Examination of the failure process shows that stresses in the duct lead to the development of fine cracks, which can be detected by on-condition inspections. Experience with earlier equipment has shown that such inspections will not identify all potential failures. However, this task can be performed on installed engines and can be scheduled for short intervals. An on-condition task is therefore both applicable and cost-effective, and our analysis of this type of failure is complete.

The fourth function of the engine is to provide reverse thrust to assist in braking the airplane, and this function is also subject to two failure possibilities: either the reverser will not operate at all or it jams during the reversing sequence. The only predictable mode for the first type of failure is bursting of the pneumatic supply duct to the actuator, whereas the second type of failure can be caused by wear in many different parts of the mechanical linkages. The cockpit instruments include a light that indicates when the reverser has left its stowed position and is in transit to the reverse-thrust position. Inability of the reverser to operate is therefore evident.

No credit is given to availability of reverse thrust in determining the runway lengths required for landing and takeoff, and it is permissible to dispatch an airplane with one reverser inoperative. Thus the failure of a reverser is not considered to have safety consequences. The reverser does have great value in certain situations, however, such as the need to avoid other aircraft on the runway or when braking action is reduced by water or snow. For certain destination conditions the operating crew may request that all reversers be operative at takeoff. A reverser failure is therefore classified as having operational consequences, although these consequences will not be involved under all circumstances. Inspection of the pneumatic supply ducts would be scheduled for the same work package as inspection of the engine pneumatic ducts, as shown in Exhibit 8.9.

The second type of failure, jamming of the reverser in the reverse-thrust position, is also evident, since there is a cockpit warning light

EXHIBIT 8-9 A worksheet showing the results of analysis for the secondary engine functions of the Pratt & Whitney JT8D-7 powerplant. The references in the first column are to the functions, functional failures, and failure modes listed in Exhibit 8.8.

POWERPLANT DECISION WORKSHEET type of aircraft **Boeing 727**
 type of engine **Pratt & Whitney JT8D-7**

item name **Propulsion powerplant**

			responses to decision-diagram questions															
ref.			consequences			task selection												
F	FF	FM	1	2	3	4	5	6	7	8	9	10	11	12	13	14	15	16
2	A	1	Y	N	Y	-	-	-	-	-	Y							
2	B	1	Y	N	Y	-	-	-	-	-	Y							
2	B	2	Y	N	Y	-	-	-	-	-	Y							
2	B	3	Y	N	Y	-	-	-	-	-	Y							
3	B	4	Y	N	Y	-	-	-	-	-	Y							
3	A	1	Y	N	Y	-	-	-	-	-	Y							
4	A	1	Y	N	Y	-	-	-	-	-	Y							
4	B	1	Y	N	Y	-	-	-	-	-	Y							

prepared by T. M. Edwards reviewed by F. S. Nowlan

proposed task	initial interval
Same tasks as 1 A 2 for towershaft drive-train elements	
Inspect all drive shafts for spline wear	Whenever accessory unit is changed or is accessible during engine shop visit
Inspect all accessory drive-train elements for wear and cracking	During engine shop visit; use opportunity sampling to establish best frequency, initial threshold 500 hours
Inspect all engine pneumatic ducts for heat distress, cracking, and leaks	100 to 200 hours
Inspect thrust-reverser pneumatic ducts for heat distress, cracking, and leaks	100 to 200 hours
Inspect thrust-reverser linkages, tracks, and actuator mechanism for wear or binding	100 to 200 hours

that indicates when the reverser is in this position. In this case the failure clearly has operational consequences. Wear and binding in the thrust-reverser mechanism are signs of reduced resistance to failure. On-condition inspection is therefore applicable, and the various linkages, actuators, and tracks would be scheduled for inspection at the same time as the supply ducts.

8.5 THE ROLE OF AGE EXPLORATION

sample-inspection requirements
the opportunity-sampling
program
age exploration and product
improvement

The preceding analysis covers only a few of the tasks that would be included in an initial powerplant program. It is apparent from these examples, however, that when the engine itself is treated as a significant item, the parts that cause it to fail will generally be assigned only two types of tasks. Some parts whose failure could cause critical secondary damage will be assigned safe-life discard tasks, but most parts are assigned on-condition tasks, often as part of an opportunity-sampling age-exploration program.

The reason no failure-finding tasks were assigned has to do with the level of the analysis. The fracture of a single compressor blade or guide vane does not cause a perceptible reduction in engine thrust, and since it also may not result in any secondary damage, the failure of individual blades and vanes may not be evident to the operating crew. Viewed from the parts level, each of these failures would be classified as a hidden functional failure. Similarly, at the assembly level erosion of these parts beyond the acceptable limits would be defined as a hidden failure, since this condition would not necessarily be apparent from the overall exhaust-gas temperature. At the engine level, however, these conditions become potential failures for the engine itself, and in both cases on-condition tasks have been specified. The periodic inspections assigned to the compressor blades and the nozzle guide vanes would reveal any fractured elements as well as other forms of deterioration.

Note that the initial program also contains no rework tasks for individual items. This is partly because there is no information at this stage to support their applicability and partly because on-condition tasks are applicable to so many engine parts. After the equipment enters service the abundance of opportunity samples results in a very rapid accumulation of operating data on engines. Thus the applicability and cost-effectiveness of rework for specific items can be established by the time the first few airplanes in the fleet reach a proposed rework age. Even when age exploration does show that certain items would benefit from scheduled rework, however, the intervals at which such tasks are cost-effective may vary widely for different items. Since there are no rework tasks that can be consolidated into a single work package to be

performed at some specified operating age, complete rework (scheduled overhaul) of the entire engine is unlikely to be justified at any point in its operating life, let alone in an initial program.

An age-exploration program is required for all new aircraft engines. In most cases the requirement calls for the inspection of sets of parts equivalent to two or three complete engines before any installed engine exceeds a specified operating age, say, 1,500 hours. The use of opportunity samples from engines that have aged to a specified lower limit—perhaps 500 or 1,000 hours—is permitted to satisfy this requirement. If there are not enough premature removals to provide the required samples, it may be necessary to remove and disassemble engines that have reached the 1,500-hour limit for the sole purpose of inspecting their parts. After the condition of the parts is evaluated, the upper limit for complete sets of parts may be extended, say, to 3,000 hours.

The requirement for whole-engine sampling is usually dropped after two such inspections, but there will be continuing age exploration for certain selected items. The sampling in this case may also be based on two threshold limits for each item. The inspection information is useful in assessing the effects of age only if the item has aged to the lower limit. With this type of program any units of the item that have aged to the upper threshold must be inspected even if additional disassembly of the engine is necessary to reach them. Such units are termed *forced samples*, in contrast to the opportunity samples of parts available for inspection during the normal course of disassembly. Both threshold limits are ordinarily extended after two or three samples of an item have been inspected and found to be in satisfactory condition.

A newer and more economical variation of this procedure is an age-exploration plan based entirely on opportunity sampling. This concept involves a lower threshold limit and a sample size of one unit. The first opportunity sample whose age exceeds an initial lower limit is inspected, and if the inspection findings are satisfactory, the age of this sample unit becomes the new threshold limit. As a result, documented sample information increases steadily in small age increments, with the age of the oldest inspection sample roughly parallel at all times to the age of the oldest installed engine (see Exhibit 5.9 in Chapter 5). It is preferable in this type of program that the inspection samples not be reworked before they are reinstalled unless their condition is judged unacceptable for continued service. In this way the time since rework is not zeroed out, and it is possible for sampling to proceed rapidly to units of higher ages.

At some age the condition of the units inspected will show enough deterioration to identify the appropriate intervals for first and repeat inspections of all units of the item. In this case the condition defined as a potential failure would be based on an inspection interval roughly

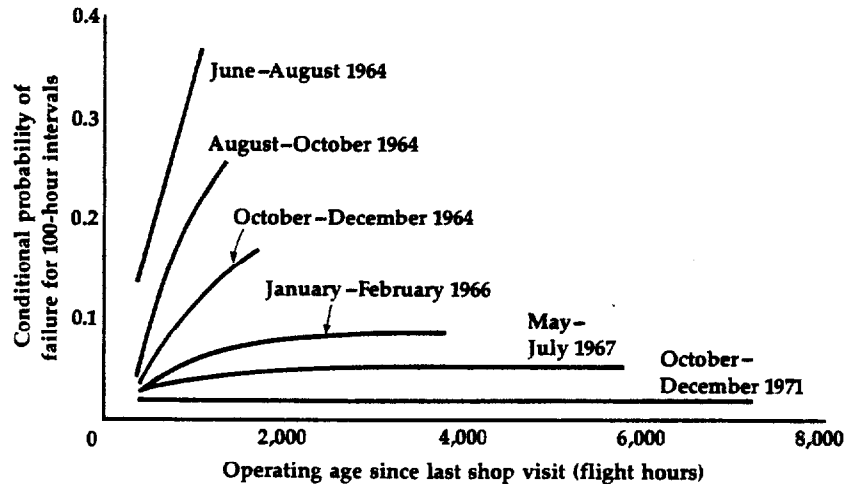

EXHIBIT 8-10 The results of successive age-reliability analyses of the Pratt & Whitney JT8D-7 engine after it entered service. (United Airlines)

equal to the interval between successive shop visits of the engine (the mean time between removals). As an alternative, the sampling threshold may be held at a fixed age limit to accumulate more information on the condition of parts at that particular age. If this additional information shows that a large proportion of the units are reaching the potential-failure point at a fairly well-defined age, a rework task might be assigned to that item—or, depending on the ratio of rework cost to replacement cost, a discard task might be specified for a slightly higher age.

Exhibit 8.10 shows the results of successive age-reliability analyses conducted as part of the age-exploration activities after the Pratt & Whitney JT8D engine entered service. Each curve represents all premature removals, both those resulting from on-condition inspections and those resulting from crew-reported malfunctions. While the first few curves show a very high conditional probability of failure, complete engine overhauls at an age low enough to affect the premature-removal rate would have grounded the fleet (engine overhauls take about 45 days). If the data had been partitioned to show the respective contributions of potential and functional failures to the total premature removals, it would also be apparent that the potential failures were much more age-related than the functional failures. In other words, on-condition inspections were effectively removing faulty units from service at a much earlier stage than would have been feasible with any rework age limit.

In this case actuarial analysis of the premature-removal data identified the dominant failure modes, which were in the hot section of the engine, and redesign of the parts most susceptible to rapid heat deterioration resulted in the ultimate reliability shown by the final curves. Apart from the fact that complete engine overhauls would have represented a needless expenditure on the other sections of the engine, which were in excellent condition, they would have impeded improvement of the engine itself. If all parts of the engine had been zero-timed at fixed intervals, there would have been no means of determining the actual potential-failure ages of individual items and improving the inherent reliability of the engine accordingly. In the powerplant division age exploration in fact plays a dual role. On one hand, it provides a means of determining the actual maintenance requirements of each engine item, and on the other, it provides the information necessary to improve the overall safety and operating reliability of the engine. This latter role is an integral part of the development process for any new engine.

rcm analysis of structures

THE STRUCTURE division consists of all the load-carrying elements of the airplane. These include not only the basic airframe – the fuselage, wings, and tail assembly – but a variety of other assemblies and components that are subjected to loads:

- ▶ The landing gear (except brakes, tires, and retraction mechanisms)
- ▶ Movable flight-control surfaces and high-lift devices (except their associated actuators and gearboxes)
- ▶ Integral fuel tanks
- ▶ Powerplant pylons, supports, and cowlings
- ▶ The aircraft skin
- ▶ Doors, hatches, windshields, and cabin windows
- ▶ Internal partitions, decks, and braces
- ▶ Connecting elements such as brackets and clips

Airplane structures are subject to many types of loads during operation – gust loads, maneuvering loads, landing loads. The magnitude and frequency of these loads depend on the nature of the operating environment, although in general low loads will occur frequently and peak loads will be encountered very infrequently. The structure must therefore be designed in terms of all its load spectra and must be so strong that it is extremely unlikely to encounter any load it cannot withstand during its intended type of operation. The role of scheduled maintenance is to find and correct any deterioration that would impair this load-carrying capability.

Unlike systems and powerplant items, few failures short of a critical failure will be evident to the operating crew. The ultimate effects of

most functional failures, however, have a direct impact on safety; hence RCM analysis of all structurally significant items falls in the safety branch of the decision diagram. In this case there are only two task outcomes: on-condition inspections for all items, with the addition of a discard task for safe-life elements. The focus in developing a structure program, therefore, is not on a search for applicable and effective tasks. Rather, it is on determining an appropriate inspection interval for each item. All parts of the structure are exposed to the age-related processes of fatigue and corrosion, but these processes interact and are not entirely predictable. Thus even for an airplane that embodies well-known materials, design practices, and production processes, the intervals assigned in an initial program are only a small fraction of the age at which any evidence of deterioration is anticipated. In fact, the inspection plan itself merely delineates the start of structural age-exploration activities.

9·1 CHARACTERISTICS OF STRUCTURAL ITEMS

The structure of an airplane consists of numerous individual assemblies. As an integral unit, however, it performs a variety of functions, a few of which can be defined as follows:

- ▶ To enable aerodynamic lifting forces to balance the weight of the airplane
- ▶ To provide mounts for the powerplants that produce the thrust necessary to balance aerodynamic drag
- ▶ To provide movable flight-control surfaces for maneuvering the airplane

design strength
the fatigue process
factors that affect fatigue life
structurally significant items

- ▶ To provide the means (landing gear) for making a transition from air to ground operation
- ▶ To provide volumes for carrying fuel
- ▶ To provide space and mounting points for the various systems required for operating capability
- ▶ To provide space with a suitable environment (often pressurized) for the operating crew and the payload to be carried

Loads are imposed on the structure during the performance of these functions, and if any major assembly cannot withstand them, the structure experiences a functional failure. Thus the basic function of individual assemblies or structural members is to withstand the loads imposed on them without collapsing or fracturing.

Many of the functions listed above are of such a nature that a functional failure would have an immediate effect on operating safety; hence the design practices followed for the structure ensure that failures are extremely unlikely. Whereas other parts of the aircraft are designed to facilitate reports of functional failures by the operating crew, the crew will rarely be in a position to report structural failures (although there are occasional crew reports of failed landing gear and high-lift devices).

It is also very difficult and expensive to replace parts of the structure. Systems and powerplant items are continually changed throughout the operating life of the aircraft; hence on any in-service airplane these items are likely to be of widely varying ages. In contrast, structural elements are repaired, often by the use of doublers, and they are also modified, but they are rarely replaced. Consequently, except for those parts added as repairs or modifications, nearly all parts of the structure on any given airplane will be of the same age. Since all structural elements are subject to a primary failure process that is directly related to total age, the structure as a whole is designed to a goal of failure ages far longer than the expected operating life of the airplane.

DESIGN STRENGTH

Airplane structures are designed to withstand many different kinds of loads, such as those caused by air turbulence, flight maneuvers, landings, and takeoffs. For commercial transport airplanes manufactured in the United States, each of these load requirements is defined by FAA airworthiness regulations. For aircraft operating in other contexts, load requirements are specified either by the appropriate airworthiness authority in the case of civil aviation or by the purchasing organization in the case of military aviation. Individual design-load requirements are stringent enough to ensure that a more severe load situation would be extremely improbable in the operating environment for which the

airplane is designed. For example, one of the load requirements for structures in the commercial-transport category is defined as follows:*

25.341 *Gust Loads*

- a The airplane is assumed to be subjected to symmetrical vertical gusts in level flight. The resulting limit load factors must correspond to the conditions determined as follows:
- 1 Positive (up) and negative (down) rough air gusts of 66 fps at V_B [the design speed for maximum gust intensity] must be considered at altitudes between sea level and 20,000 feet. The gust velocity may be reduced linearly from 66 fps at 20,000 feet to 38 fps at 50,000 feet.
 - 2 Positive and negative gusts of 50 fps at V_C [the design cruising speed] must be considered at altitudes between sea level and 20,000 feet. The gust velocity may be reduced linearly from 50 fps at 20,000 feet to 25 fps at 50,000 feet.
 - 3 Positive and negative gusts of 25 fps at V_D [the design dive speed] must be considered at altitudes between sea level and 20,000 feet. The gust velocity may be reduced linearly from 25 fps at 20,000 feet to 12.5 fps at 50,000 feet.

During the development and certification of any new aircraft the manufacturer conducts numerous tests to confirm that each structural assembly can withstand the specified design loads without damage or permanent deformation. Design loads with this objective are called *limit loads*. There are also requirements that the structure be able to withstand at least 150 percent of the limit load without collapsing (experiencing a functional failure). When design loads are factored upward in this way they are called *ultimate loads*. The present airworthiness requirements for design strength have been effective in protecting against functional failures as long as the specified load-carrying capabilities of the structure are preserved.

After the airplane enters service the operating organization is responsible both for preserving the design strength of the structure and also for ensuring that the operating gross weight of the airplane does not exceed the maximum weight at which the structure can satisfy the various load requirements.

THE FATIGUE PROCESS

All the loads to which an aircraft structure is subjected are repeated many times throughout the course of its operating life. Although any single load application may be only a fraction of the load-carrying capability of the element, the stress imposed by each one reduces the

*Federal Aviation Regulations, Airworthiness Standards: Transport Category Airplanes, sec. 25.341, effective February 1, 1965.

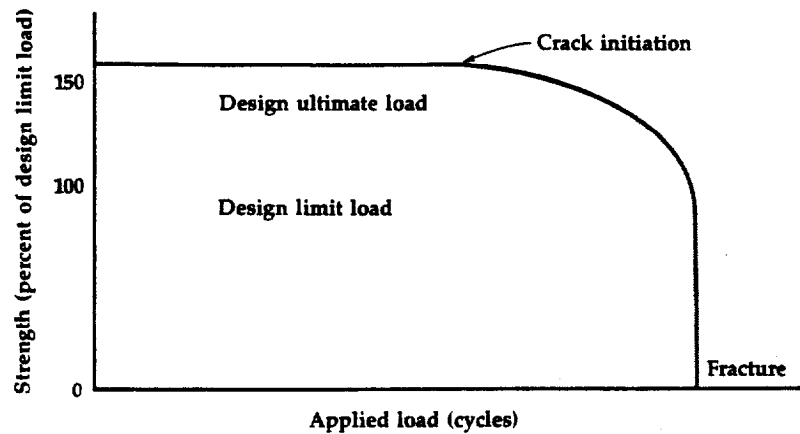

EXHIBIT 9-1 Model of the effect of fatigue on the strength of a single structural element exposed to cyclic loads.

remaining margin of failure resistance. Eventually, as a result of these cumulative reductions, a small crack will appear in the metal. Until the crack reaches the stage at which it is visible, there is little change in the strength of the affected element. Thereafter, as internal stresses cause the crack to propagate, the strength of the element is reduced at an ever-increasing rate.

The fatigue process thus has two aspects. Because the effects of repeated loads are cumulative, as the operating age increases, the age interval before a crack will appear decreases—that is, there is a reduction in the remaining time before *crack initiation*, the appearance of a visible crack. The operating age at which a fatigue crack first appears in a structural item is termed the *fatigue life* of the item.* The second aspect is the reduction in the strength, or load-resisting capability, of the item associated with *crack propagation*. Both fatigue life and the rate of crack propagation vary not only with the material from which the item is made, but also with its size and shape and the manufacturing process by which it was produced. For this reason fatigue tests must be conducted on actual structural elements and assemblies to determine their individual fatigue characteristics.

The fatigue process in a single structural element is illustrated in Exhibit 9.1. When the structure is new the element can withstand an ultimate load, or 150 percent of its design limit load. As the element ages

*The term *fatigue life* is also used to denote the age at which a fracture occurs as a result of fatigue. In this discussion fatigue life always means the time to crack initiation.

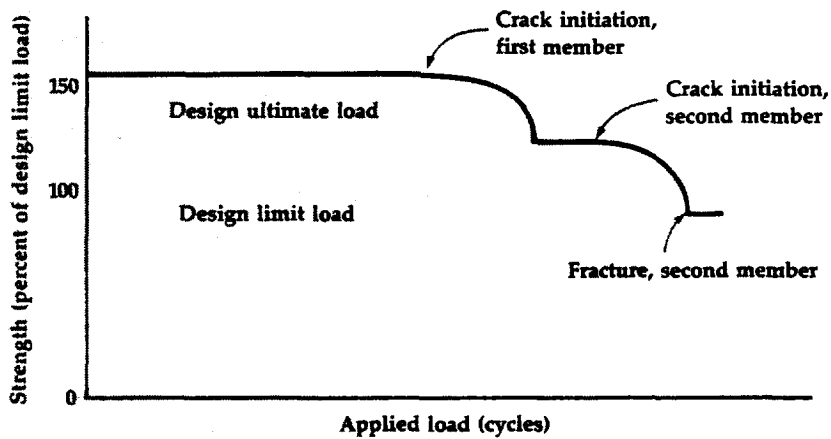

EXHIBIT 9-2 Model of the effect of fatigue on the strength of a multiple-load-path (redundant) structural assembly exposed to cyclic loads.

in service its failure resistance (time to crack initiation) decreases with repeated load applications until a fatigue crack appears. Up to this point its load-resisting capability is relatively unchanged. Now, however, the crack will propagate, and the strength of the element will decrease accordingly. At some point the crack will reach a length at which the element can no longer withstand the limit load; it then becomes a *critical crack*. If this element is subjected to the limit load it will fracture immediately, but even when the continued loads are much lower than the limit load, the rate of crack growth will become so rapid that a fracture cannot be prevented by scheduled maintenance.

If the item that fractures is a monolithic element and is not part of a redundant assembly, this functional failure is usually critical. If the item is one element of a multiple-load-path assembly, the fracture reduces the load-carrying capability of the assembly but does not result in a complete loss of function. The resulting redistribution of the load to the remaining elements does, however, accelerate the fatigue process in those elements. This situation is illustrated in Exhibit 9.2. The cracking or fracture of the first element reduces the residual strength of the assembly. After this the load-carrying capability will remain relatively constant until a crack initiates in a second element, which results in a transition to a still lower residual strength. The amount of reduction in each case will depend on the contribution of each element to the total strength of the assembly.

The difference between these two situations has led to two basic structural-design practices to prevent critical failures. The older, and

perhaps better-known, practice is *safe-life design*, which applies to structural elements with little or no redundancy. A newer practice is *damage-tolerant (fail-safe) design*. This term refers not only to redundant fail-safe structure, but also to monolithic portions of the structure characterized by easily detected cracks with slow propagation rates. A structural assembly is said to be damage-tolerant if after the complete fracture of any one element it can still withstand the damage-tolerant loads specified by the appropriate airworthiness authority. A monolithic item is considered damage-tolerant if the rate of crack propagation is slow enough for at least two inspections to be feasible during the interval from crack initiation to a crack of critical length.

Suppose, for example, that the specified damage-tolerant load is the design limit load treated as an ultimate load. This means that in its intact condition a structural assembly must be capable of withstanding the limit load without permanent deformation, whereas after the failure of one of its elements it must be able to withstand the same load without a functional failure. This specification is similar to the requirement that the engines on a transport airplane provide sufficient residual thrust for safe operation after a complete loss of thrust from one engine (or, in certain situations, from two engines). The residual strength after a single element fails is lower than desired for continuous operation. However, it is still so high that the airplane is unlikely to encounter dangerous loads during the time that will pass before the failed element is discovered and repaired. The concept of damage-tolerant design depends, of course, on an adequate inspection program.

It is rare for the failure of a single element to reduce residual strength to the damage-tolerant level. In fact, depending on the degree of redundancy (number of load paths), the failure of some structural elements has little effect on the assembly. Moreover, the design strength of most elements is determined by the single highest load requirement, such as that for landing loads, and their contribution to the strength of the assembly may be less under other loading conditions. The appearance of a fatigue crack in an element can therefore be defined as a potential-failure condition, and since even the fracture of a single element is not critical, on-condition inspections will be effective at intervals short enough to ensure that not more than one element will fracture.

Most modern aircraft employ damage-tolerant design principles as widely as possible, but there are some parts of the structure, such as the landing gear, for which the criteria for damage tolerance cannot be met. Consequently it is necessary to impose safe-life limits on these elements. Since fatigue is directly related to total operating age, the limit is based on tests conducted to simulate operating loads in order to determine the fatigue life (time to crack initiation) for each element. Although a safe-life discard task based on such fatigue tests is applicable, it cannot be considered effective in the case of structural elements because

they are exposed to other deterioration processes that may prevent the safe-life limit from being achieved. Hence any safe-life structural items must be supported by a combination of tasks—on-condition inspections for corrosion and accidental damage and a safe-life discard task to ensure that the item is removed from service before a fatigue failure can occur.

The replacement of safe-life items and the repair of fatigue damage in other structural elements is both time-consuming and very expensive. Thus for economic reasons as well as safety reasons, the structure of an aircraft is designed for high safe-life limits, and also for a long fatigue life. The design goal for the Douglas DC-10, for example, was a mean fatigue life (to crack initiation) of 120,000 hours for the structure as a whole, with the expectation that any individual airplane would be free of any fatigue problems up to 60,000 hours.

FACTORS THAT AFFECT FATIGUE LIFE

The primary deterioration process in structure is fatigue. However, the integrity of the structure is also threatened by manufacturing imperfections, accidental damage, overloads during operation, and corrosion. All these factors can have a direct effect on structural strength and can also accelerate the fatigue process itself. The age at which fatigue cracks first appear in a given structural item may therefore vary widely from one airplane to another, and structural inspections must begin long before the age at which fatigue-test data indicate that a fatigue crack can be expected.

One well-recognized manufacturing problem is assembly-induced *preload*, a condition caused by design, fabrication, or assembly errors. Exhibit 9.3 shows an example of a preload condition in an angle splice. In this case a missing chamfer allows the edge of the angle to gouge into the radius of the chord piece. When the horizontal joint is drilled and bolted without proper shimming, a further effect is deformation

EXHIBIT 9-3 Example of a preload condition. Although the discovery of this condition on one airplane prompted an immediate inspection of the entire fleet, only a few cases of preload were actually found.

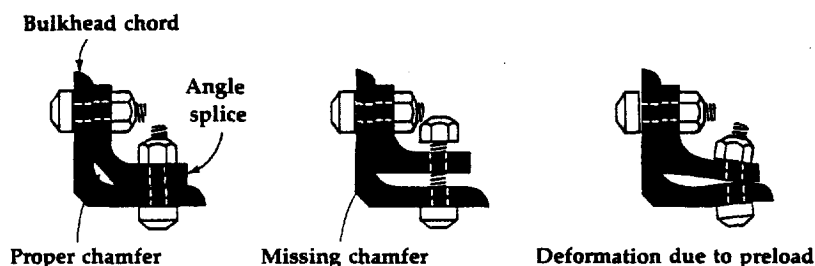

of the pieces. The result is either radial cracking at the joint or a splice with such high imposed loads that it is highly susceptible to any small additional loads. In either case the residual strength of the assembly containing this chord and splice will deteriorate in a fraction of its intended design life. Fortunately the existence of a preload condition is usually detected early in the age-exploration process, but its discovery necessitates immediate inspection of the entire fleet to locate all defective units.

In addition to localized problems, all parts of the structure are exposed to *corrosion*, the deterioration and ultimate destruction of a metal by its environment. There are many different forms of corrosion, ranging from simple oxidation to electrolytic reactions. Like fatigue, corrosion is age-related. It is not nearly so predictable, however, since metals corrode at rates that depend on a complex of environmental conditions and maintenance practices. Corrosion damage has a particularly adverse effect on structural strength. Unless it is detected at an early stage, the localized loss of material will reduce the load-carrying capability of the portion of the structure affected, and the resulting increase in stress levels will accelerate the fatigue process in the remaining metal.

Most types of corrosion are observable as surface deterioration which results in a measurable reduction in the cross section of the element. *Stress corrosion*, however, is more difficult to detect. This form of corrosion is caused by the combined effects of environment and sustained or cyclic tensile stress, and it can lead to the spontaneous collapse of the metal with no macroscopic signs of impending failure. Stress corrosion develops as fine intercrystalline or transcrystalline cracks in the metal itself. Since there may be no external evidence of deterioration, we must rely on such nondestructive techniques as eddy-current inspection to detect this condition. In a moist environment stress-corrosion cracking can occur under stresses much lower than the yield stress of the material. The problem is most common in high-strength aluminum alloys that have been strengthened by heat-treating. It can be caused by improper heat treatment, a poor choice of materials for a particular set of conditions, or the lack of adequate protective coatings. In some cases it may also be caused by the sustained stress created by preload conditions.

Generally the areas that are exposed to dirt, moisture, and heat are the most susceptible to corrosion, and properly applied and maintained protective coatings are necessary to prevent deterioration. Particularly short inspection intervals are required in such corrosion-prone areas as fuselage bilges, the areas under lavatories and galleys, and cargo pits to check for incipient corrosion and restore any deteriorated protective coatings.

STRUCTURALLY SIGNIFICANT ITEMS

Nearly all parts of an airplane structure are inspected at one time or another, both to preserve the design strength of the structure and because deterioration detected in its early stages is relatively inexpensive to repair. Because of the cost and difficulty of replacing failed structural members, most such items might be viewed as significant on the basis of economic consequences. However, the primary consideration in determining structural significance is the effect that failure of an element has on the residual strength of the remaining assembly and on the functional capability of the overall structure. Thus safe-life elements and damage-tolerant monolithic elements are classified as significant because their failure would lead to a complete loss of function of a major assembly either immediately or in the near future. Many elements of a damage-tolerant assembly will also be classified as significant, depending on their contribution to the strength of the assembly and the significance of the assembly to the overall structure.

The generic term *structurally significant item (SSI)* is used to denote each specific structural region that requires scheduled maintenance as part of an RCM program to guard against the fracture of significant elements. Such an item may be defined as a site which includes several elements, it may be defined as the significant element itself, or it may be defined in terms of specific regions on the element which are the best indicators of its condition. In this sense a structurally significant item is selected in much the same way as a functionally significant item, which may be a system, a subsystem, an assembly, or a significant part in an assembly.

During the selection of structurally significant items consideration is also given to the susceptibility of various parts of the structure to corrosion and accidental damage. Thus the relative ranking of significant items takes into account not only the effect of the item's failure, but also how soon a particular item is likely to cause problems. Consequently, although significant items are often defined in terms of specific stress points, such as the joint between two structural members, an entire area that is exposed to moisture, and hence to corrosion problems, may also be classified as significant. In this case specific stress points within the area might be designated as separate items on the basis of fatigue factors. Sometimes different surfaces of the same structural element are designated as separate items, especially if different access routes are required to perform the inspections.

In the development of a prior-to-service program the manufacturer provides the initial designation of structurally significant items, since at that time he is the only one in a position to identify safe-life and damage-tolerant monolithic items, the effect of a failed element on the strength of damage-tolerant assemblies, and the expected fatigue life

and crack-propagation characteristics of each structural element. Although the numbering schemes differ from one manufacturer to another, significant items are usually identified on the basis of a three-dimensional reference system that shows their exact physical location by section or station or within a designated zone.

All structurally significant items are subjected to *detailed inspections*. Many of these inspections are visual, but they must be performed at close range and require special attention to small areas, such as a check for corrosion in bolt holes. Others may entail the use of special equipment, such as x-ray or eddy-current devices. In addition to these detailed inspections, many items also receive frequent *general inspections*, visual checks for any obvious problems, which require no tools or disassembly other than the opening of quick-access doors. These latter inspections are performed as part of the preflight walkaround checks, the zonal program, and general external inspections, which include nonsignificant portions of the structure as well. Thus, although the RCM structural program includes only those items designated as structurally significant, every aspect of the structure is examined at one time or another to ensure that any signs of fatigue, corrosion, or accidental damage will be detected in their early stages.

9·2 THE STRUCTURAL INSPECTION PLAN

external and internal structure
structurally significant items
structural rating factors
class number
relative inspection intervals

The structure of an airplane is exposed to random damage from contact with loading or other ground equipment and from foreign objects such as stones or ice on runways and bird strikes during flight. It is also subject to occasional severe loads during operation as a result of air turbulence or hard landings. However, the chief causes of deterioration (a reduction in failure resistance) are fatigue and corrosion, both of which are age-related. Fatigue is related to the total operating age of the structure, and corrosion is a function of the time since corrosion damage was last repaired and anticorrosion treatments were renewed. The objective of the structural inspection plan is to find and correct any deterioration of those items of greatest significance to the structural integrity of the airplane, and to collect information on the aging characteristics of less significant items by inspections of a sample of the fleet. The sampling information may, of course, lead to inspection of certain items on every airplane as evidence of these characteristics begins to appear.

Because deterioration in its early stages is relatively inexpensive to repair, it is cost-effective to inspect many structural items far more frequently than would be required solely to protect the airworthiness of the airplane. General inspections of the external structure, for example, are scheduled very frequently because they can be performed

quickly and easily. *External structural items* are those portions of the structure that can be seen without removing any covering items or opening any access doors. These general inspections will detect not only accidental damage, but also any external signs of internal deterioration, such as discoloration, popped rivets, buckled skin, and fuel leaks. This external evidence is often a specific design feature in damage-tolerant structure, and the ease of external inspections makes it practical and safe to lengthen the inspection intervals for the internal items themselves.

Any part of the structure that is not visible externally is termed an *internal structural item*. Internal items are more difficult to inspect. Some require only the opening of quick-access doors, but others require the removal of floorboards, linings, and insulation or the disassembly of other parts of the structure or of the aircraft systems. Internal significant items, like external ones, receive detailed inspections. However, whereas external inspections are performed on every airplane, some internal inspections are performed on only a portion of the fleet. In the power-plant division age exploration of internal engine items is based on a continual flow of engines through the repair shop, but structure does not provide such opportunity samples—portions removed and sent to the shop while the airplane remains in service. Thus the inspection program itself is the only vehicle for age exploration. The intervals assigned in an initial program therefore represent only a fraction of the ages at which any signs of deterioration are expected and, in effect, merely define the start of age exploration for each item.

The current practice in developing an initial structure program is based on a rating scheme that makes full use of the designer's information and the manufacturer's test data for the various structural elements. The first consideration is whether the portion of the structure in question is a structurally significant item. If so, it will be assigned a detailed inspection task, but the frequency of inspection will depend on further considerations. If the item is on the underside of the airplane, which is particularly susceptible to accidental damage, it will be inspected more often than one on the upper surface. The inspection intervals for damage-tolerant items will be longer in general than those for safe-life elements. In this case, however, the interval for internal items will depend on whether a damage-tolerant assembly has been designed to provide external evidence of internal damage. The general relationship of these considerations is diagrammed in Exhibit 9.4.

The starting point for the development of a structure program is a list of structurally significant items. Not all these items will be of the same significance. The failure of some redundant elements, for example, will cause a much greater reduction in residual strength than the failure of others. Moreover, the test data on fatigue life, as well as differences

in susceptibility to corrosion and accidental damage, will usually indicate that inspection of all items need not start at the same operating age. To determine an appropriate interval for each item, therefore, it is necessary to assess the following design characteristics:

- ▶ The effect of failure of the item on residual strength

EXHIBIT 9-4 A plan for inspection of the complete structure.

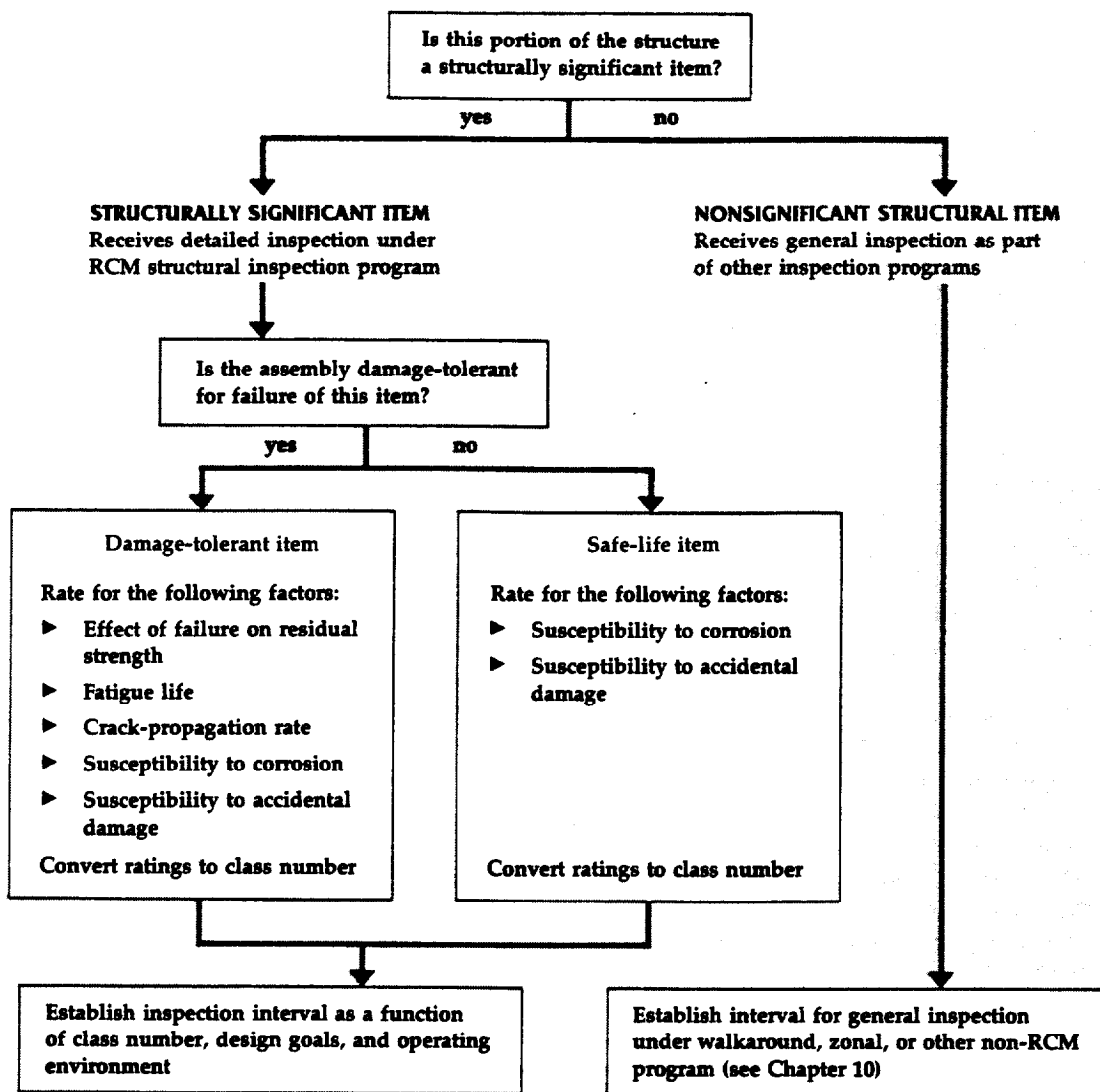

- ▶ The anticipated crack-free life (fatigue life) of the item
- ▶ The crack-propagation characteristics of the item
- ▶ Susceptibility of the item to corrosion
- ▶ Susceptibility of the item to accidental damage

These five factors are used to develop inspection ratings for each item, and the ratings are then transformed into a class number that identifies the appropriate relative interval.

To illustrate, suppose the item is an internal structural element in a damage-tolerant assembly. The first step is to rate each of the five factors independently on a scale of 1 to 4, as outlined in Exhibit 9.5. This scale keeps the number of choices small, but also avoids a middle value, which would tend to be overused. Note that the ratings for fatigue life and crack propagation for an internal item may be increased by 1 if there is external evidence of the item's failure. This does not apply to corrosion ratings, however, since the objective is to inspect often enough to prevent corrosion damage from reaching the stage at which it would be evident externally. Nor does it apply to accidental damage. Thus this particular internal item might be rated as having very little effect on the residual strength of the assembly (4), moderate fatigue life ($2 + 1 = 3$), rapid crack growth ($1 + 1 = 2$), moderate susceptibility to corrosion (2), and very little exposure to accidental damage (4).

The procedure for safe-life items is similar, except that these items are rated for only two factors: corrosion and exposure to accidental damage. A functional failure (fracture of the item) would reduce the

EXHIBIT 9-5 Rating scales for the five factors that determine structural inspection intervals. Each structurally significant item is ranked on a scale of 1 to 4 for each of the factors that apply. The lowest of these rankings represents the class number assigned to that item.

reduction in residual strength	fatigue life*	crack propagation*	susceptibility to corrosion	susceptibility to accidental damage	rating
Large	Short	Rapid	High	High	1
Moderate	Medium	Moderate	Moderate	Moderate	2
Small	Long	Slow	Low	Low	3
Very small	Very long	Very slow	Very low	Very low	4

*These two ratings for an internal item may be increased by 1 if there is external evidence of failure or potential failure.

residual strength to zero, and crack propagation is not a consideration because a safe-life item cannot be allowed to reach the point of crack initiation. If it were feasible to define a crack as a potential failure and depend solely on on-condition inspections to ensure removal of the item before the crack reached critical length, the item would have been classified as damage-tolerant instead of safe-life.

While the ratings are clearly a matter of judgment, they make the best possible use of the information that is available at the time. For example, in assessing the reduction in residual strength caused by the fracture of a single element, consideration must be given not only to the role of the element in relation to the load-carrying capability of the assembly, but also to the role of the assembly itself in relation to the overall structure. From the standpoint of the assembly, one determining factor is the number of elements at the same site that can fail before damage-tolerant capability is lost. The reduction is rated as major if the failure of a second element would leave the assembly incapable of supporting the damage-tolerant load; it would be rated as moderate if the failure of two elements could be tolerated, and if the loads originally carried by the two elements were of the same order of magnitude. Alternatively, the ratings can be based on the percentage of loss in residual strength caused by the fracture of structural elements. For example, if the failure of two elements can be tolerated, a rating of 2 would be used if these failures reduce the margin between the ultimate and damage-tolerant strength by 75 percent; a reduction of 50 percent would be rated as 3, and a reduction of 25 percent would warrant a rating of 4.

In assessing fatigue life and crack-propagation characteristics the working group would consider whether or not the item had undergone

reduction in residual strength		fatigue life of element	
no. of elements that can fail without reducing strength below damage-tolerant level	rating	ratio to fatigue-life design goal	rating
One	1	Less than 1	1
Two or more	2	1-1½	2
Two or more	3	1½-2	3
Two or more	4	More than 2	4

fatigue and crack-propagation tests (if not, all the ratings would be lower), whether the loads applied to the test items are representative of the expected operating loads, and the results of the test in relation to the fatigue-life goal for the airplane. In making corrosion ratings they would consider previous experience with the anticorrosion treatments used in manufacture, the type of environment in which the equipment will be operated, and any specific problems related to the location of the item in the equipment. Operation in a hot, humid environment close to salt water, for example, would affect corrosion ratings for the entire structure. In commercial aircraft those structural items adjacent to the cargo pits, galleys, hot-air ducts, and lavatories are particularly susceptible to corrosion. Susceptibility to corrosion is difficult to rate, since corrosion is a function of the operating environment, and for some types of equipment evidence of corrosion might be acceptable at much lower ages than it is for transport aircraft. Similarly, the susceptibility of an item to accidental damage will range from high for external items exposed to foreign objects on runways to low for internal areas subject to little traffic from maintenance personnel.

One way of rating the fatigue life and crack-propagation characteristics of an item is in terms of the fatigue-life design goal for the structure as a whole. The design goal for the Douglas DC-10, for example, was an average fatigue life of 120,000 hours to crack initiation (about 40 years of airline service, or two operating lifetimes). An individual item with an expected fatigue life of less than 120,000 hours would be rated 1 for fatigue life, an item with an expected fatigue life of 120,000 to 180,000 hours would be rated 2, and so on. The ratings for crack propa-

EXHIBIT 9-6 Factors used to develop ratings for damage-tolerant structurally significant items. In each case the item is rated for the effect of a single failure on the residual strength of the assembly. The fatigue life of each item represents the time to crack initiation in relation to the fatigue-life design goal for the structure as a whole.

crack-propagation rate		susceptibility to corrosion		susceptibility to accidental damage	
ratio of interval to fatigue-life design goal	rating	ratio of corrosion-free age to fatigue-life design goal	rating	exposure as a result of location	rating
1/8	1	1/8	1	High	1
1/4	2	1/4	2	Moderate	2
3/8	3	3/8	3	Low	3
1/2	4	1/2	4	Very low	4

gation would be based similarly on a ratio of the crack-propagation interval for the item to the overall fatigue-life design goal. Thus an item with an interval of less than 15,000 hours from the time of crack initiation to critical crack length (or in the case of a redundant element, to fracture of the element) would receive a rating of 1 for this factor.

Corrosion ratings can be developed in the same way, by comparing the age at which corrosion is first expected to become evident with the fatigue-life design goal. The ratings for susceptibility to accidental damage cannot be expressed in terms of a reference age, but they are based on the item's resistance to damage, as well as the type and frequency of damage to which it is exposed.

Once the item under consideration has been rated for each of the factors that apply, the lowest rating for any individual factor is assigned as the *class number* for that item.* The damage-tolerant item described above has ratings of 4, 3, 2, 2, and 4; hence its class number is 2. A safe-life item rated 4 for corrosion and 1 for susceptibility to accidental damage would have a class number of 1. The class number is the basis for the relative length of the initial inspection interval. The lower the rating, the lower the class number, and therefore the shorter the inspection interval.

For damage-tolerant items the design goal can also serve as a reference for converting class numbers to inspection intervals. The interval must be one that provides for at least two inspections during the crack-propagation interval; if the first inspection does not disclose a potential failure, the second one will. In addition, there should be 20 to 30 inspections before the expected appearance of a fatigue crack on the most significant items, although there may be as few as five for those of least significance. Such inspections not only protect the structure from the effects of incipient corrosion and accidental damage, but also make it possible to confirm that the design fatigue life has in fact been achieved.

There is no hard-and-fast rule for establishing initial inspection intervals, because the rating process itself must be based on cautious informed professional judgment. The scale outlined in Exhibit 9.7 does, however, reflect current practice for commercial swept-wing jet transport aircraft. This scale applies only to structural items that meet damage-tolerant design criteria. Safe-life items must also be inspected to find and correct any deterioration that could prevent attainment of the safe-life limit. The ratings for corrosion and susceptibility to accidental damage will provide rankings for the relative intensity of such inspections, but there is no accepted basis for converting the resulting class numbers to actual intervals. This is because of the wide variations both in susceptibility to such damage and in the value judgments applied

*The lowest number must be used because there is no basis for tradeoffs between any of the individual rating factors.

class number assigned to item as a result of ratings	initial inspection interval as a fraction of fatigue- life design goal
1	1/24
2	1/12
3	1/8
4	1/6

notes

- 1 An internal item whose class number has been raised because of external detectability will have an associated external SSI with the class number of the internal item without this increase.
- 2 Class 1 and class 2 items may be considered for higher initial intervals on later aircraft after a sufficient number of inspections on the original fleet have shown no signs of deterioration.
- 3 Class 3 and class 4 items may be considered as candidates for total-time fleet-leader sampling after pertinent operating information becomes available.

EXHIBIT 9-7 A suggested scale for converting class numbers to relative inspection intervals for significant items in damage-tolerant structure. In this case the initial interval is expressed as a fraction of the fatigue-life design goal for entire structure. A similar scale cannot be used for safe-life elements because the only two factors rated (susceptibility to corrosion and accidental damage) vary with the item and the intended use of the equipment.

to ratings in individual operating contexts. Consequently the initial intervals for safe-life elements are generally set at conservative values which reflect their relative class numbers and are extended, if possible, on the basis of the findings from these inspections after the equipment enters service.

At this point let us examine some of the implications of Exhibits 9.6 and 9.7 and see how the starting and repeat intervals for structural items relate to the fatigue characteristics of the item. Consider a case in which the class number of an item results from its crack-propagation rating. The relationships would be as follows:

<i>class number</i>	<i>ratio of crack-growth interval to fatigue- life design goal</i>	<i>ratio of inspection interval to fatigue- life design goal</i>
1	1/8	1/24
2	1/4	1/12
3	3/8	1/8
4	1/2	1/6

In each case the inspection interval ensures three inspections between the time of crack initiation and time at which the crack will reach critical length. The intervals are therefore quite satisfactory for use as repeat intervals to detect potential failures before the item actually fractures. However, these intervals are also used in the initial program to define the ages at which inspections must be performed to begin the age-exploration process. The same interval will be used for the first, second, and subsequent inspections of the item until there is sufficient information to support a change. Such information will usually show an absence of deterioration at lower ages, and it will then be possible to start inspections on later-delivery airplanes at a higher age—that is, to eliminate the first few inspections in the sequence.

Now suppose that the item in question has a class number of 1, and that the ratings for residual strength and crack propagation are both 1. The inspection interval of 1/24 of the fatigue-life design goal is sufficiently conservative to protect a very significant item in damage-tolerant structure. If both ratings are 2, the inspection interval will be increased to 1/12 of the design goal. However, if the item has been rated 1 for residual strength and 2 for crack propagation, the class number is 1 and the inspection interval remains at 1/24 of the fatigue-life design goal—a somewhat illogical but subjectively attractive increase in conservatism, both for protection of the item and for the intensity of age exploration.

Low ratings for fatigue life and exposure to corrosion or accidental damage can lead in the same way to increased conservatism. Although the intervals in Exhibit 9.7 are generally conservative, items with fairly rapid crack-propagation characteristics may be far off the scale and may require special treatment. This is frequently the case with serious unanticipated failures which occur after the airplane enters service, but then real information is available for use in establishing the appropriate intervals for first and repeat inspections.

While the question of when each item should first be inspected is always believed to be of intrinsic importance in developing an initial inspection program, it is an interesting paradox that the methods actually used to determine initial intervals can be explained only in terms of repeat intervals, with in-service age exploration to establish which multiple of these intervals should be used as the starting interval on later-delivery airplanes. There has been a gradual extension of initial inspection intervals as a result of satisfactory experience with in-service aircraft, and further experience may well support substantially longer initial intervals for designs incorporating familiar technology.

It is important to remember that the intervals suggested in Exhibit 9.7 are based on vast experience with various types of airplanes that have employed similar materials, design practices, and manufacturing processes. They can therefore be applied with confidence to new types

of airplanes that represent an extrapolation of this experience. However, if the aircraft designer is less experienced in this field, or if new types of materials or new manufacturing or bonding processes are employed, or if the equipment is to be operated in an unfamiliar environment (such as supersonic transport), the initial intervals must be far more conservative and the age-exploration activity more intensive. It goes without saying that the effectiveness of an inspection program depends on the proper identification of structurally significant items. It is essential, therefore, that all operating organizations report serious structural deterioration at any age to central coordinating agencies, usually the manufacturer and the regulatory agencies, who will evaluate them and define new significant items, adjust inspection intervals, call for special inspections, or even require that modifications be made to the structure.

9·3 ASSEMBLING THE REQUIRED INFORMATION

Most of the information required to develop an initial structural program must be supplied by the manufacturer. In addition to the test data used to establish fatigue life and the effect of a failure on residual strength, the working group must know the flight profile assumed as the basis for fatigue-life design goals and the structural design philosophy that was followed. To determine appropriate inspection intervals, they must also know whether the design characteristics include external evidence of internal failures, what the accessibility of each item will be, the physical properties of each of the materials used, and the corrosion-prevention procedures and types of paint systems used.

initial information
requirements
the information worksheet

All this information is provided during the design reviews conducted by the manufacturer. As an example, the following design goals were discussed with the entire working group during early presentations on the Douglas DC-10:

- ▶ The residual strength after the failure of any single structural item must be great enough to withstand the applied limit load considered as an ultimate load (the criterion for damage-tolerant structure).
- ▶ A part containing discontinuities must have a fatigue life equal to or greater than the same part without discontinuities.
- ▶ Joints must be stronger than their surrounding elements.
- ▶ The design goal for the airplane is a mean fatigue life of 120,000 flight hours, with a reasonable probability that any single airplane will be crack-free to 60,000 hours (approximately 20 years).

- ▶ Every effort must be made to ensure that areas most subject to fatigue damage are easy to inspect by detailed inspections in small localized areas.
- ▶ The outer-skin cracks which are evidence of fractures in adjacent internal elements must be detectable before they reach critical length.

Proper evaluation of this information, however, depends heavily on the experience and professional judgment that the working-group members bring to the decision process. From experience with other recent designs, they will know the areas of the structure in which fatigue cracks are most likely to appear, the parts of the airplane subjected to the harshest environmental conditions (trapped water, condensation, spillage, damage from cargo), the durability and effectiveness of protective coatings in actual use, and the reaction of various structural materials under loads and environmental conditions similar to those to which the new aircraft will be subjected.

The data elements that must be assembled for each structural item to be analyzed are similar to those required for systems and powerplant items. Because the primary decision problem concerns the assignment of appropriate inspection intervals, however, the information is recorded in a slightly different form (see Exhibit 9.8). In addition to the item name and number, which are usually based on the manufacturer's identification of parts for design reference, a brief description is needed to pinpoint the exact location of the item. The zone numbers are also included, since they are useful when the tasks are assembled into work packages. If an item appears on both sides of the aircraft, both zone numbers should be included. Similarly, if it is a skin panel or some other large area, all zone designators should be included.

It is important to specify the materials from which the item is manufactured, since prior experience with various materials will have great bearing on the evaluation of their properties. The results of fatigue and static-load tests of the complete airplane or its major assemblies are usually not available at the time an initial program is developed, since the tests on most items will still be in progress. However, there are often test data on smaller assemblies, and in some cases relevant data may be available for a similar portion of the structure on in-service aircraft. Where tests on safe-life items are still in progress, the test data which are available must show a zero conditional probability of failure at the safe-life limit indicated.

In the case of all structural analyses it is necessary to indicate whether the item is a safe-life element or meets the criteria for damage-tolerant design. The worksheet should also show whether the item is an internal one or is visible externally. As with systems and powerplant

items, the design redundancies that make an item damage-tolerant and the external detectability of internal problems help to determine the specific area (or areas) of the structure defined as structurally significant, as well as the ratings which establish the intensity of inspection required. The ratings themselves are recorded on the worksheet, along with the class number assigned to the item as a result of the controlling rating factor. Where individual ratings have been increased because of external detectability or decreased because of the absence of test data, these adjustment factors should be noted. The information on related structurally significant items is especially useful in evaluating later adjustments of the initial intervals as a result of age exploration.

Whereas the information worksheets for systems and powerplant items included a detailed list of functions, functional failures, failure modes, and failure effects, this information is rarely needed on structures worksheets. (The reason for this will be explained in the next section.) Instead, the rest of the worksheet covers the nature of the proposed inspection tasks. Where both general and detailed inspections are required for the same item, each task is listed separately, with its appropriate interval. If the item is one that is likely to control the work package in which it is included, the initial interval should be stated in actual operating hours, spectrum hours, or flight cycles. Where a wide range of intervals can be assigned, it may be necessary only to state the letter-check package in which the task is to be included (see Section 4.6).

In assigning initial inspection intervals it is important to bear in mind that the structural inspection program will provide the framework for all the major scheduled-maintenance packages. Thus tasks must be considered not only in terms of their frequency, but also in terms of the length of time the aircraft will have to be out of service while they are performed. Inspections directed at those portions of the structure that are both easily accessible and the most susceptible to corrosion or accidental damage are called out in the more frequent lower-level packages, from the walkaround check on up. While the intervals must be short enough both to protect the equipment and to find damage at a stage when it is still inexpensive to repair, when damage is found, the repair itself may be scheduled for a later time.

The more extensive inspections—those that will take the airplane out of service for more than twenty-four hours—are usually consolidated in a work package performed at much longer intervals. Many of the internal inspections can be performed only at the major maintenance base, where the airplane can be disassembled as necessary to check parts of the structure for evidence of fatigue as well as corrosion damage. This comprehensive inspection, or “airplane overhaul,” is usually referred to as a *D check* and includes all, or nearly all, the inspection tasks in the program. Depending on the complexity of the structure

EXHIBIT 9-8 A worksheet for recording the relevant information, ratings, and task outcomes for structurally significant items.

STRUCTURES WORKSHEET type of aircraft

item number	no. per aircraft
item name	major area
vendor part/model no.	zone(s)

description/location details

material (include manufacturer's trade name)

fatigue-test data

expected fatigue life	hours	crack propagation	hours
-----------------------	-------	-------------------	-------

established safe life

design conversion ratio	operating hours/flight cycle
-------------------------	------------------------------

		ratings				
residual strength	fatigue life	crack growth	corrosion	accidental damage	class no.	controlling factor

adjustment factors

prepared by	date
reviewed by	date
approved by	date

design criterion (check)	inspection access (check)
damage-tolerant element	internal
safe-life element	external
redundancy and external detectability	

Is element inspected via a related SSI? If so, list SSI no.	classification of item (check)
	significant
	nonsignificant

inspection (int./ext.)	proposed task	initial interval
-------------------------------	----------------------	-------------------------

and the size of the maintenance crew, it may take the airplane out of service for a week to several months.

The first of these complete inspections is a very important part of the age-exploration program, since it includes many inspections that are being performed for the first time. The first airplane that ages to the initial interval becomes the inspection sample; the findings for each item are carefully evaluated, tasks and intervals for individual items are adjusted as necessary, and the conservative initial interval for the D-check package is extended. Consequently, although external inspections are performed on every airplane, most internal items will be inspected at the initial interval only on the first one or first few airplanes to reach this age limit. They will, however, be inspected at successively higher ages as the equipment ages in service, often on a fleet-leader sampling basis.

9.4 RCM ANALYSIS OF STRUCTURAL ITEMS

analysis of damage-tolerant
elements
analysis of safe-life elements

As we saw in Chapters 7 and 8, RCM analysis of systems and powerplant items may fall in any branch of the decision diagram. In contrast, all structurally significant items fall in the safety branch, and the evaluation of proposed tasks can have only one of two possible outcomes (see Exhibit 9.9). This is true no matter which of the structural functions we consider. As an example, one function of the aircraft structure is to permit lifting forces to balance the weight of the airplane. Although most of the lift is provided by the wing, its center of lift does not necessarily coincide with the airplane's center of gravity, and the horizontal stabilizer must provide a balancing load that brings the vertical forces into equilibrium. The portions of the structure associated with this function, therefore, are the wing, the fuselage, and the horizontal tail.

The first question is whether a loss of the balancing function will be evident:

1 Is the occurrence of a failure evident to the operating crew during performance of normal duties?

The answer is yes, of course, since a loss of this function as the result of a structural failure would be all too evident, not only to the crew, but to any other occupants of the airplane as well.

Next we would ordinarily examine the various failure modes that could cause such a failure. In the case of structural items, however, the failure modes all involve the fracture of a load-carrying member. Thus the following question relates to any of the failure possibilities:

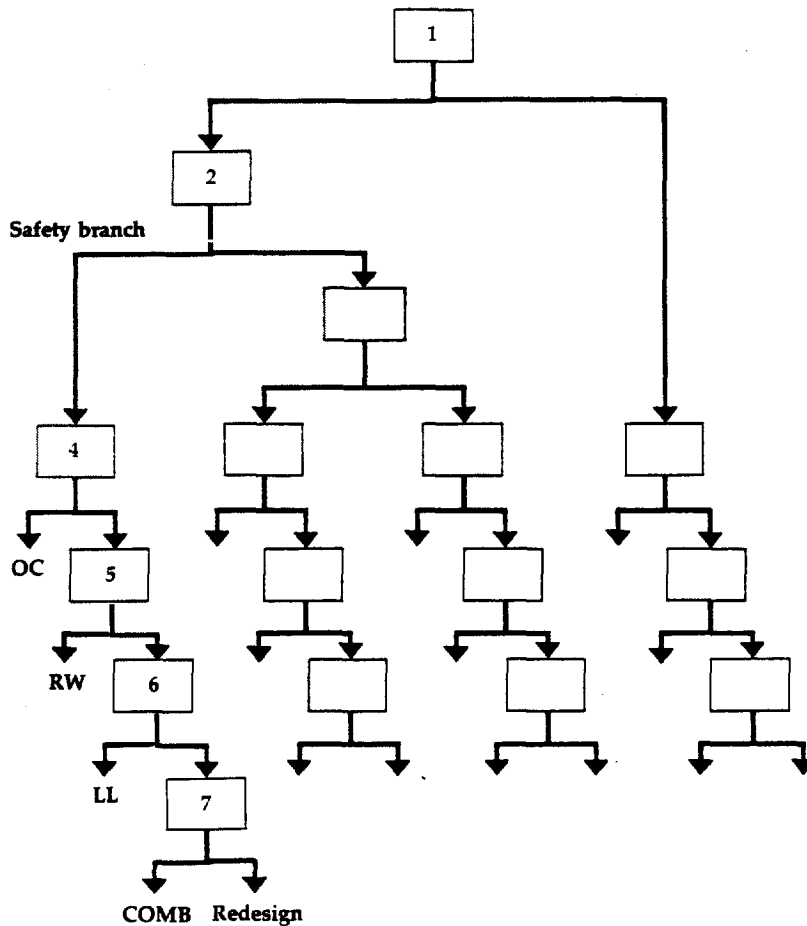

EXHIBIT 9-9 The branch of the decision diagram used for RCM analysis of all functions of the aircraft structure. The only possible task outcomes for structurally significant items are on-condition inspection for elements of damage-tolerant structure and a combination of on-condition and discard tasks for safe-life elements.

2 Does the failure cause a loss of function or secondary damage that could have a direct adverse effect on operating safety?

The fracture of a structural item may well cause critical secondary damage, but in this case the loss of function alone is sufficient to classify the

failure as critical. The answer to this question is therefore yes regardless of the failure mode involved, and further analysis falls in the safety branch of the decision diagram. This means that scheduled maintenance is required and that a task will be considered effective only if it reduces the risk of a functional failure to an acceptable level; in other words, it must result in substantial preservation of the load-carrying capability of the item.

The first type of task we would consider is an on-condition inspection:

4 Is an on-condition task to detect potential failures both applicable and effective?

For items designed to damage-tolerance criteria the answer to this question is yes. The existence of a crack in a structural element can be defined as a potential failure, and in an assembly with redundant load paths even the fracture of one element will not reduce residual strength below the safety level. Hence an on-condition task is applicable, and if it is performed at short enough intervals to ensure that a second element does not fracture (or in the case of a monolithic member, that the crack does not propagate to critical length), the task is also effective. RCM analysis of a damage-tolerant element is therefore complete once this question has been answered, and all that remains is to assign appropriate inspection intervals for each of the significant items.

For safe-life items the answer to question 4 is no. Although the initiation of a fatigue crack can still be defined as a potential failure, unless its propagation characteristics meet damage-tolerant load requirements, we cannot rely on on-condition inspections to prevent fatigue failures. Such inspections are applicable to detect corrosion and accidental damage, which can greatly shorten fatigue life, but since they will not prevent all functional failures, we must look for other tasks:

5 Is a rework task to reduce the failure rate both applicable and effective?

Although the fatigue process is directly related to operating age, there is no form of remanufacture that will erase the cumulative effect of the loads the material has experienced up to that point (restore the original resistance to failure). A rework task can therefore have no effect on the time at which fatigue failures might occur. Since this task is not applicable, the answer to the rework question is no, and we must consider the next possibility, a safe-life discard task.

6 Is a discard task to avoid failures or reduce the failure rate both applicable and effective?

A safe-life limit is based on the fatigue life of the item, as established during developmental testing. However, since corrosion and damage can affect that life, these factors may prevent a structural element from reaching the safe-life age established on the basis of testing in a less hostile environment. Consequently we cannot conclude that a safe-life discard task alone will satisfy the criterion for effectiveness in preventing critical failures, and the answer to this question is no.

A no answer to question 6 brings us to the final question in the safety branch:

7 Is a combination of preventive tasks both applicable and effective?

Both on-condition and discard tasks are applicable, and a combination of the two meets the effectiveness requirements. The on-condition inspections ensure that the item will reach its safe-life limit, and the discard task ensures that it will be removed from service before a fatigue failure occurs.

The results of this analysis are shown on the decision worksheet in Exhibit 9.10. Note that an analysis of any one of the functions listed in Section 9.1 would follow the same path and lead to the same outcomes: on-condition inspections for damage-tolerant items and on-condition inspections plus discard at the safe-life limit for safe-life items. If the elements of a damage-tolerant assembly were analyzed individually, the fracture of a single element would be viewed at the assembly level as a hidden failure. The task itself, however, would be exactly the same—an inspection for cracks and corrosion scheduled at intervals short enough to avoid the risk of a multiple failure of such elements.

Once again, particular care must be given to the definition of functions and functional failures. For example, one of the functions of the structure is to provide movable flight-control surfaces for maneuvering the airplane. However, if the ailerons on each wing are duplicated, a failure of one of the two ailerons will not result in a loss of that function. Rather, from the standpoint of maneuvering capability, it will result in a potential failure. In this sense the failure of a single aileron is analogous to the fracture of a single element in a damage-tolerant assembly, and the maintenance task to prevent a loss of aileron function to the aircraft is an on-condition inspection scheduled at intervals short enough to prevent the failure of more than one aileron.

STRUCTURES DECISION WORKSHEET type of aircraft

item name

ref.	responses to decision-diagram questions																	
	consequences						task selection											
F	FF	FM	1	2	3	4	5	6	7	8	9	10	11	12	13	14	15	16

Loss of balancing function,
all failure modes:

Damage-tolerant assembly (failure of
multiple elements):

Y Y - Y

Safe-life element:

Y Y - N N N Y

EXHIBIT 9-10 The results of RCM analysis for structurally significant items. All functions of the aircraft structure depend on the ability of significant elements to withstand applied loads, and all failure modes lead ultimately to a fatigue failure resulting in the loss of this load-carrying capability. Thus the answers to the decision-diagram questions will be the same for any damage-tolerant item and for any safe-life item, regardless of the particular item under consideration.

9-5 ESTABLISHING INITIAL INSPECTION INTERVALS

<p>damage-tolerant items</p> <p>safe-life items</p>	<p>The Douglas DC-10 is basically a damage-tolerant aircraft, the only safe-life items being the nonredundant parts of the landing gear. During the very early development of this design typical structural components were fatigue-tested, either individually or in assemblies or sections, to determine their contribution to the design goal of an average crack-free fatigue life of 120,000 hours, with 60,000 hours of crack-free operation for any individual airplane. Although a fatigue test on the entire structure was conducted to the full 120,000 hours, and inspections were to be concentrated on this article as the test progressed, the final results were not available at the time the initial program for the DC-10 was developed. The following examples have been updated to reflect both</p>
---	--

page of
item number

prepared by

reviewed by

proposed task

initial interval

**On-condition inspection for cracks,
corrosion, and accidental damage**

**As determined by class number
of item**

**On-condition inspection for cracks,
corrosion, and accidental damage**

**As determined by class number
of item**

Discard at safe-life limit

**As determined by safe-life limit
for item**

the results of the fatigue test and the additional parameters used in RCM analysis.* However, the recommended intervals resulting from this analysis are similar to (although not identical with) those in the original prior-to-service program.

*The structural program for the DC-10, developed just before this aircraft was certified, was based on MSG-2 principles, which involved a similar comprehensive analysis. For a detailed discussion of the considerations behind the original program see M. E. Stone and H. F. Heap, Developing the DC-10 Structural Inspection Program, *Seventh Annual FAA International Aviation Maintenance Symposium*, Oklahoma City, Oklahoma, December 7-9, 1971, and M. E. Stone, Airworthiness Philosophy Developed from Full-scale Testing, *Biannual Meeting of the International Committee on Aeronautical Fatigue*, London, July 23-25, 1973.

DAMAGE-TOLERANT STRUCTURAL ITEMS

The wing-to-fuselage attach tee, together with the structural area around it, is one of the damage-tolerant structurally significant items on the Douglas DC-10. This portion of the structure, identified as SSI 105, is located on the top surface of the wing and consists of the titanium-alloy tee at wing station XW 118.2 and the aluminum-alloy fuselage and upper wing skin within 12 inches of it. The tee, which is in three separate, sections, extends from the front to the rear spar and forms part of the

EXHIBIT 9-11 Worksheet for analysis of the wing-to-fuselage attach tee on the Douglas DC-10.

STRUCTURES WORKSHEET type of aircraft Douglas DC-10-10

item number 105 no. per aircraft 2
 item name Wing-to-fuselage attach "tee" major area Outer wing, upper skin panel
 vendor part/model no. 573.01.105/DC-10-10 zone(s) 264/5, 161/2, 254/5, 274/5

description/location details

Attach tee is located under upper wing-root fairing and runs along upper chord from front to rear spar at wing station XW 118.2; SSI includes attach tee and skin 12 in. all sides of tee (both faces), accessible through doors 527FB, 627FB, 527GB, and 627GB.

material (include manufacturer's trade name) Titanium alloy 6AL-4V
 (Douglas specification 1650)

fatigue-test data

expected fatigue life 240,000 hours crack propagation 60,000 hours

established safe life —

design conversion ratio 1.5 operating hours/flight cycle

residual strength	fatigue life	ratings			accidental damage	class no.	controlling factor
		crack growth	corrosion				
4	4	4	4	4	4	—	

mating joint between the wing and the fuselage. It also forms part of the pressure vessel; thus it is subjected to pressurization loads as well as to flight loads. This structural item cannot be seen externally. The outer portion is under the wing-to-fuselage fairing and the inner portion is under the cabin flooring.

Exhibit 9.11 shows all the pertinent information for this significant item, a record of the ratings, and the resulting inspection interval. The rating for residual strength in this case is 4 because the tee plays

prepared by	H. F. Heap	date	5/12/78
reviewed by	F. S. Nowlan	date	5/12/78
approved by		date	

design criterion (check)	inspection access (check)
<input checked="" type="checkbox"/> damage-tolerant element	<input checked="" type="checkbox"/> internal
<input type="checkbox"/> safe-life element	<input type="checkbox"/> external

redundancy and external detectability

Three pieces to prevent cracks from growing to entire length of tee; no external detectability.

Is element inspected via a related SSI? If so, list SSI no.	classification of item (check)
No	<input checked="" type="checkbox"/> significant
	<input type="checkbox"/> nonsignificant

inspection (int./ext.)	proposed task	initial interval
Internal	Detailed visual inspection for corrosion and cracking	Not to exceed 20,000 hours (D check)

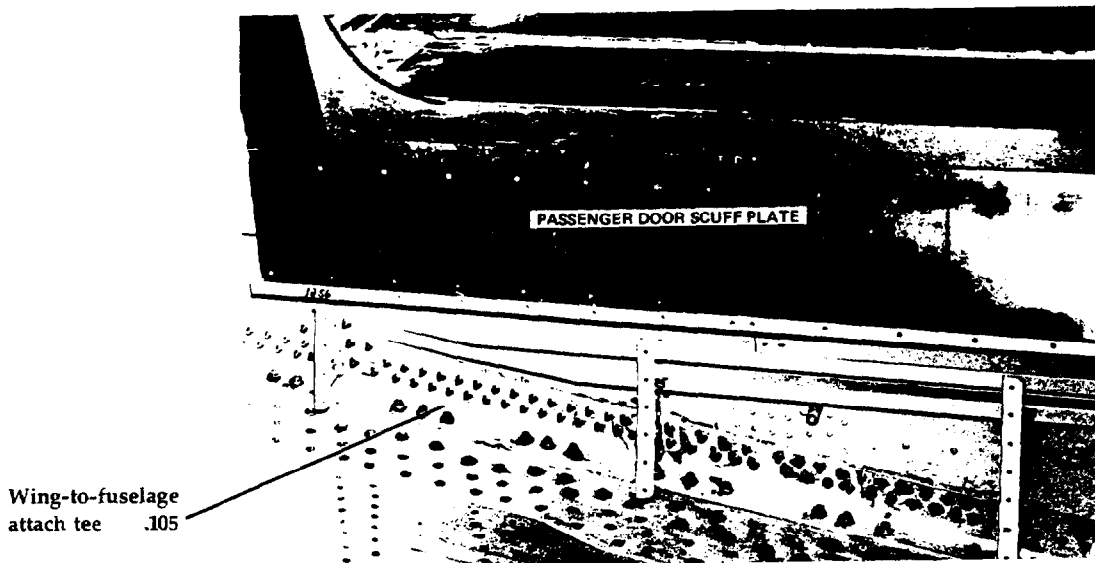

EXHIBIT 9-12 A portion of the Douglas DC-10 outer wing, showing the outer face of the wing-to-fuselage attach tee (SSI 105). This view is from the left-hand wing, looking inboard at the fuselage (outer fairing removed). (Douglas Aircraft)

a relatively minor role in transferring wing loads to the fuselage, and even the failure of two of the three sections of the tee results in only a small reduction in the load-carrying capability of the basic structure. The attach tee is made of an alloy that has excellent fatigue and corrosion resistance, and this part of the structure is expected to survive to more than twice the 120,000-hour design goal; hence the fatigue-life rating is 4. The crack-propagation interval is more than half the design goal, so this rating is also 4. The area is well-protected and well drained, and these properties, in addition to the high corrosion resistance of the material itself, warrant a corrosion rating of 4. This is an internal structural item (either the inner flooring or the outer fairing must be removed for inspection), and since it is exposed to little mechanic traffic, the accidental-damage rating is also 4. The result of these ratings is a class number of 4. From the rating scale outlined in Exhibit 9.7 we see that this class number represents an initial inspection interval of 1/6 of the fatigue-life design goal, or 20,000 hours.

Another significant structural element on the Douglas DC-10 is the wing rear spar, which is one of the main load-carrying members of the airplane. A failure of the aluminum-alloy lower cap of that spar would cause a large reduction in the residual strength of the wing, although it would still be able to carry the damage-tolerant load in the absence of failures of any other significant elements at the same site. The spar also

forms the rear wall of the integral fuel tanks, and since the front tang of the spar cap is therefore difficult to inspect, it was designed for a lower stress level than the rear tang and will thus have a longer fatigue life. This means that inspection of the rear tang will provide the first evidence of fatigue in the spar cap, particularly if inspections are concentrated on regions of structural discontinuities, such as splices (the spar is made in four sections which are spliced together).

The area identified as SSI 079 in Exhibit 9.13 is the rear tang of the lower spar cap at a point where the spar is spliced and also changes direction. This point lies behind the wing-engine pylon and is in front of the aileron attach fitting. The spar cap and splice require internal

EXHIBIT 9-13 A portion of the Douglas DC-10 wing rear spar, showing the lower spar cap and splice (SSI 079). This view is from aft of the left-hand wing, looking forward at the outer-wing rear spar and trailing-edge beam. (Douglas Aircraft)

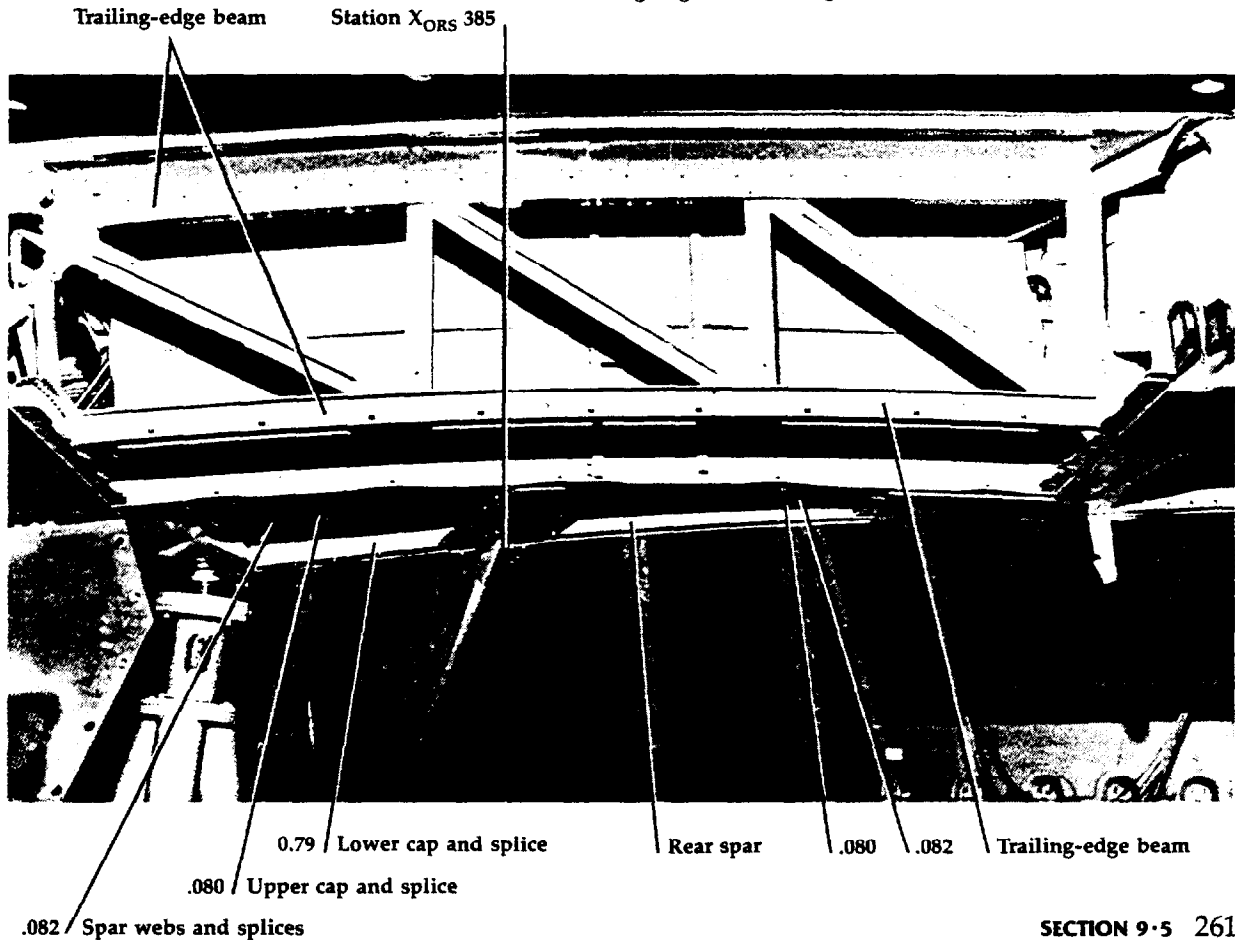

inspection and are accessible through two doors in the lower wing skin behind the wing tank on each side of the aircraft. Internal problems are expected to show such external signs as fuel leaks, cracked skin, or popped rivets long before any extensive deterioration of the underlying structure occurs.

The information for this item is summarized on the worksheet in Exhibit 9.14. In this case a failure will have a large effect on residual strength. The rating for residual strength is therefore 1. The splice has

EXHIBIT 9-14 Worksheet for analysis of the lower spar cap and splice on the wing rear spar of the Douglas DC-10.

STRUCTURES WORKSHEET type of aircraft **Douglas DC-10-10**

item number **079** no. per aircraft **2**
 item name **Lower spar cap and splice** major area **Wing**
 vendor part/model no. **571.04.079/DC-10-10** zone(s) **541, 641**

description/location details

Cap and splice are located on aft lower face of wing rear spar at outer rear spar stations X_{ORS} 372 to 480; SSI includes aft face of cap and splice, accessible through doors 541HB; 641HB, 541FB, and 641FB.

material (include manufacturer's trade name) **Aluminum alloy 7075-T651**

fatigue-test data

expected fatigue life **120,000** hours crack propagation **15,000** hours

established safe life

design conversion ratio **1.5** operating hours/flight cycle

residual strength	fatigue life	ratings			accidental damage	class no.	controlling factor
		crack growth	corrosion				
1	3*	2*	2	4	1	Residual strength	

adjustment factors ***Increased by 1 for external detectability**

an anticipated fatigue life 1½ times the 120,000-hour design goal, and the crack-propagation interval is 1/8 of this time. Ordinarily this would mean a fatigue-life rating of 2 and a crack-propagation rating of 1. However, because of the excellent external indicators of deterioration, both ratings have been increased by 1. The corrosion rating is 2 because of the location of this item; it is exposed to dirt and moisture condensation. The rating for susceptibility to accidental damage is 4 because the item is internal and is exposed to very little mechanic traffic.

prepared by	H. F. Heap	date	5/12/78
reviewed by	F. S. Nowlan	date	5/12/78
approved by		date	

design criterion (check)	inspection access (check)
<input checked="" type="checkbox"/> damage-tolerant element	<input checked="" type="checkbox"/> internal
<input type="checkbox"/> safe-life element	<input type="checkbox"/> external

redundancy and external detectability

Designed for rear tang of spar cap to show first evidence of fatigue; deterioration visible externally (fuel leaks, cracked skin, popped rivets, discoloration)

Is element inspected via a related SSI? If so, list SSI no.	classification of item (check)
Yes. SSI 077 (forward face) SSI 079 (external area)	<input checked="" type="checkbox"/> significant
	<input type="checkbox"/> nonsignificant

inspection (int./ext.)	proposed task	initial interval
Internal	Detailed visual inspection for corrosion and cracking	Not to exceed 5,000 hours

The controlling factor is the residual-strength rating. The class number is therefore 1, and this item is scheduled for inspection at 1/24 of the overall fatigue life, or an interval of 5,000 hours. This is a starting interval for the initial program, and it may be extended for later-delivery airplanes on the basis of the inspection findings after the first airplanes have gone into service. In addition to this internal inspection, the external area expected to show evidence of internal problems will also be

EXHIBIT 9-15 Worksheet for analysis of the lower spar cap and splice (forward face) on the wing rear spar of the Douglas DC-10.

STRUCTURES WORKSHEET type of aircraft **Douglas DC-10-10**

item number **077** no. per aircraft **2**
 item name **Lower spar cap and splice** major area **Wing**
 vendor part/model no. **571.04.077/DC-10-10** zone(s) **533, 633**

description/location details

Cap and splice are located on forward face of wing rear spar at outer rear spar stations X_{ORS}^{372} to 480; SSI includes forward face of cap and splice, accessible through doors 533AT and 633AT.

material (include manufacturer's trade name) **Aluminum alloy 7075-T651**

fatigue-test data

expected fatigue life **120,000 hours** crack propagation **15,000 hours**

established safe life

design conversion ratio **1.5** operating hours/flight cycle

residual strength	fatigue life	ratings			accidental damage	class no.	controlling factor
		crack growth	corrosion				
—	—	—	4		4	4	—

adjustment factors **Ratings for residual strength, fatigue life, and crack growth not applicable, covered by SSI 079**

designated a significant item, and this external area will be inspected at least as frequently.

The front tang of the spar cap, identified as SSI 077, is not expected to be the first indicator of fatigue damage. It must be inspected for corrosion, however, because it is in the fuel tank and is thus exposed to a different environment from the rear tang. Since the forward face of the spar is an interior surface of the fuel tank, it is necessary to drain and

prepared by	H. F. Heap	date	5/12/78
reviewed by	F. S. Nowlan	date	5/12/78
approved by		date	

design criterion (check)	inspection access (check)
<input checked="" type="checkbox"/> damage-tolerant element	<input checked="" type="checkbox"/> internal
<input type="checkbox"/> safe-life element	<input type="checkbox"/> external

redundancy and external detectability
As for SSI 079

Is element inspected via a related SSI? If so, list SSI no.	classification of item (check)
Yes. SSI 079 (aft face), SSI 077 (external area)	<input checked="" type="checkbox"/> significant
	<input type="checkbox"/> nonsignificant

inspection (int./ext.)	proposed task	initial interval
Internal	Detailed visual inspection for corrosion and cracking	Not to exceed 20,000 hours (D check)

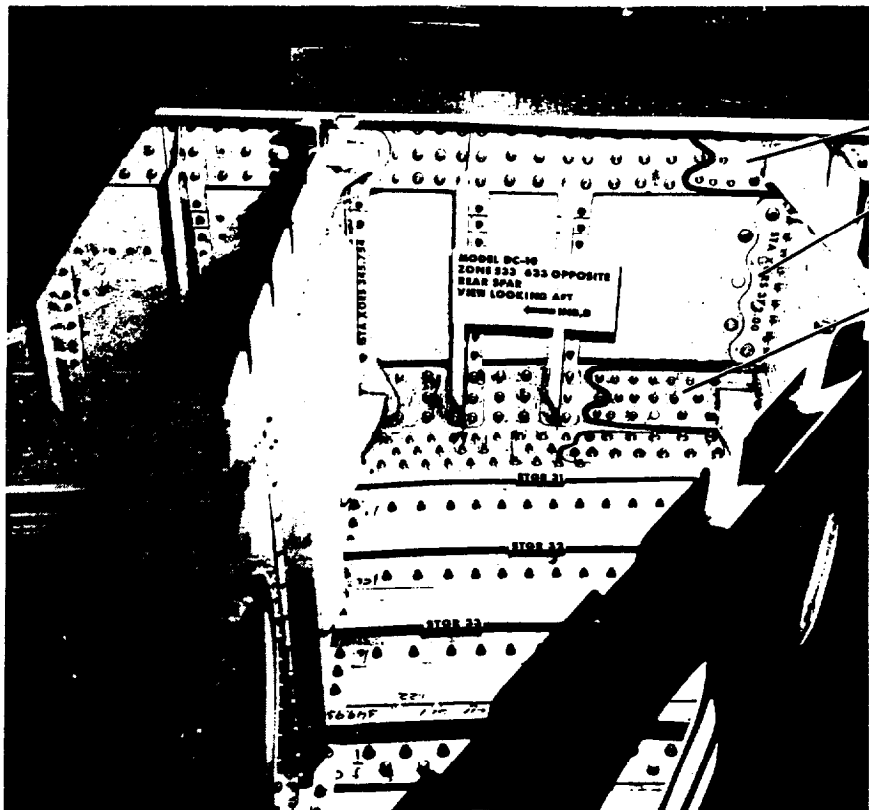

- .078 Upper cap and splice
- .047 Span at bulkhead intersection
- .077 Lower cap and splice

EXHIBIT 9-16 A portion of the Douglas DC-10 wing rear spar, showing the forward face of the lower spar cap and splice (SSI 077). This view is from forward of the left-hand wing, looking aft at the rear spar of the outer wing box (upper panel removed for clarity). (Douglas Aircraft)

purge the tank in order to inspect it. The worksheet in Exhibit 9.15 shows no ratings for residual strength, fatigue life, or crack propagation because these factors are covered for the spar cap by SSI 079. Susceptibility to corrosion is rated as very low, 4, because the tank itself is completely sealed and is protected from microbial action by inhibitors. The accidental-damage rating is also 4, because this face of the spar is exposed to even less possibility for damage than the opposite face.

The class number in this case is the lower of the two rating factors, or 4. Thus this item will be inspected initially at 1/6 of the fatigue-life design goal, or an interval of 20,000 hours. With a class number of 4, it will also be eligible for reduced inspection in the ongoing program if the results of early sampling confirm that the area is not prone to deterioration. This is an example of a situation in which two structurally significant items have been designated to identify specific regions of a

single element that should be inspected to cater to different factors and environments. There are many additional such designations along the full length of the rear spar. The designer plays an important role in such cases in making the primary indicators of deterioration occur in easily inspectable areas.

SAFE-LIFE STRUCTURAL ITEMS

The shock-strut outer cylinder on the main landing gear of the Douglas DC-10 is one of the few safe-life structural items on this aircraft. The following analysis of this item shows the treatment of a safe-life item in an airline context. However, there is no universal approach to setting inspection intervals for safe-life items, and each case must be considered separately. This particular item is of interest because there are two different models, and the outer cylinder on each model has a different safe-life limit. Exhibits 9.17 and 9.18 are worksheets for the two models.

Since this is a safe-life item, it must be removed from service before a fatigue crack is expected to occur; hence it is not rated for residual strength, fatigue life, or crack-propagation characteristics. Both models are of the same material. However, the manufacturer's fatigue tests showed that model ARG 7002-501 had a safe-life limit of 23,200 landings, or 34,800 flight hours, whereas tests on a redesigned model, ARG 7002-505, resulted in a safe-life limit of 46,800 landings, or 70,200 flight hours. The safe-life limits are effective only if nothing prevents the item from reaching them, and in the case of structural items there are two factors that introduce this possibility—corrosion and accidental damage. Both factors reduce the expected fatigue life from that for an undamaged part, and both apply equally to the two models of the shock-strut outer cylinder.

Experience has shown that landing-gear cylinders of this type are subject to two corrosion problems. First, the outer cylinder is susceptible to corrosion from moisture that enters the joints at which other components are attached; second, high-strength steels such as 4330 MOD are subject to stress corrosion in some of the same areas. Both models are therefore given a corrosion rating of 1, which results in a class number of 1.

The onset of corrosion is more predictable in a well-developed design than in a new one, and previous operation of a similar design in a similar environment has shown that severe corrosion is likely to develop by 15,000 to 20,000 hours (five to seven years of operation). It can be detected only by inspection of the internal joints after shop disassembly; hence this inspection will be performed only in conjunction with scheduled inspections of the landing-gear assembly. This corrosion inspection is one of the controlling factors in establishing the shop-inspection interval. It is customary to start such inspections at a conservative interval and increase the interval at a rate determined by

EXHIBIT 9-17 Worksheet for analysis of the outer cylinder of the shock-strut assembly, model ARG 7002-501, on the Douglas DC-10.

STRUCTURES WORKSHEET type of aircraft Douglas DC-10-10

item number 101 no. per aircraft 2
 item name Shock-strut outer cylinder major area Main landing gear
 vendor part/model no. P.N. ARG 7002-501 zone(s) 144, 145

description/location details

Shock-strut assembly is located on main landing gear; SSI consists of outer cylinder (both faces).

material (include manufacturer's trade name) Steel alloy 4330 MOD
 (Douglas TRICENT 300 M)

fatigue-test data

expected fatigue life hours crack propagation hours
 established safe life 23,200 landings, 34,800 operating hours
 design conversion ratio 1.5 operating hours/flight cycle

residual strength	fatigue life	ratings			accidental damage	class no.	controlling factor
		crack growth	corrosion				
—	—	—	1		4	1	Corrosion

adjustment factors

EXHIBIT 9-18 Worksheet for analysis of the outer cylinder of the shock-strut assembly, model ARG 7002-505, on the Douglas DC-10.

STRUCTURES WORKSHEET type of aircraft Douglas DC-10-10

item number 101 no. per aircraft 2
 item name Shock-strut outer cylinder major area Main landing gear
 vendor part/model no. P.N. ARG 7002-505 zone(s) 144, 145

description/location details

Shock-strut assembly is located on main landing gear; SSI consists of outer cylinder (both faces).

material (include manufacturer's trade name) Steel alloy 4330 MOD
 (Douglas TRICENT 300 M)

fatigue-test data

expected fatigue life hours crack propagation hours
 established safe life 46,800 landings, 70,200 operating hours
 design conversion ratio 1.5 operating hours/flight cycle

residual strength	fatigue life	ratings			accidental damage	class no.	controlling factor
		crack growth	corrosion				
—	—	—	1		4	1	Corrosion

adjustment factors

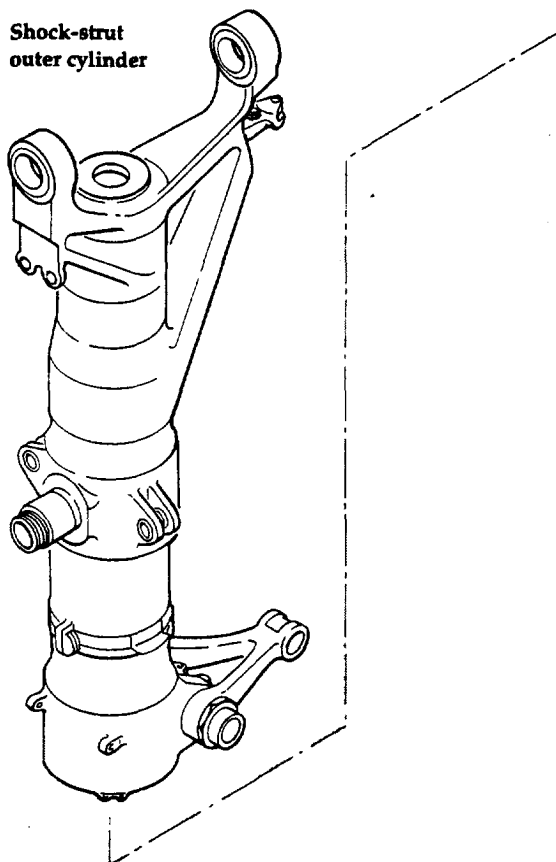

EXHIBIT 9-19 The shock-strut assembly on the main landing gear of the Douglas DC-10. The outer cylinder is a structurally significant item; the rest of the assembly is treated as a systems item. (Based on Douglas DC-10 maintenance materials)

experience and the condition of the first units inspected. The initial requirement is therefore established as inspection of one sample between 6,000 and 9,000 hours and one sample between 12,000 and 15,000 hours to establish the ongoing interval. During the shop visits for these inspections any damage to the structural parts of the assembly are repaired as necessary and the systems parts of the assembly are usually reworked. Thus the combined process is often referred to as landing-gear rework.

In addition to the corrosion rating, both models of the shock-strut

cylinder are rated for susceptibility to accidental damage. The cylinder is exposed to relatively infrequent damage from rocks and other debris thrown up by the wheels. The material is also hard enough to resist most such damage. Its susceptibility is therefore very low, and the rating is 4 in both cases. However, because the damage is random and cannot be predicted, a general check of the outer cylinder, along with the other landing-gear parts, is included in the walkaround inspections and the A check, with a detailed inspection of the outer cylinder scheduled at the C-check interval. The same inspection program applies to both models, since they have the same susceptibility to corrosion and accidental damage. The only difference is in the interval for the safe-life discard task; this task is scheduled at the safe-life limit for each model.

Note that the outer cylinder has been treated in this case as a single structurally significant item. It could also have been designated as two items, with the interval for the internal surface controlled by the corrosion rating and that for the external surface controlled by a single rating for accidental damage. This treatment would, of course, have resulted in the same set of tasks and intervals.

9·6 STRUCTURAL AGE EXPLORATION

In the systems and powerplant divisions the consequences of many functional failures are economic and do not involve safety. Thus little attempt is made to predict those reliability characteristics that cannot be determined until after the equipment enters service. Instead, the default strategy is employed, and additional tasks are incorporated in the scheduled-maintenance program only after there is sufficient operating information to assess their economic desirability. In the analysis of structural items, however, the determination of inspection intervals for damage-tolerant structure is based on an assessment of the effect of failures on residual strength, the relationship of fatigue-test results for individual items to the design goal for the overall structure, crack-propagation characteristics, and the anticipated rate of corrosion. All these assessments involve some degree of prediction. The results are therefore treated very conservatively, not only because they are extrapolations from test data, but also because manufacturing variations, differences in operating environments, and different loading histories may lead to wide variations in fatigue life from one airplane to another.

In all cases there will be differences between the manufacturer's test environment and the environment in which a given fleet of airplanes is actually operated. If different airplanes in the fleet are to be assigned quite different types of missions or will be operating in different types of environments, it may be advisable to develop a separate

the role of the inspection plan
the fleet-leader concept

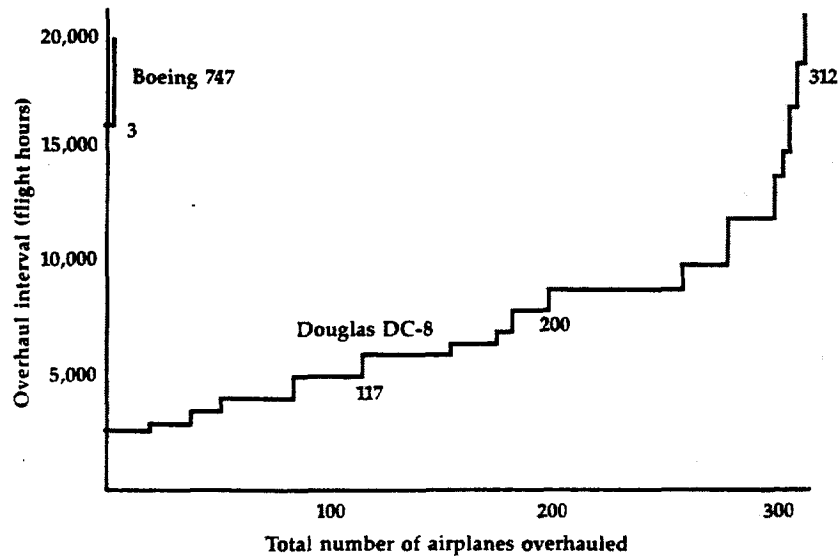

EXHIBIT 9-20 The number of heavy structural inspections (overhauls) required to reach the same maximum interval under different maintenance policies. The figures shown for the Douglas DC-8 indicate the total number of overhauls performed up to the time of an interval extension. The very conservative initial interval for this airplane was extended slowly until a change in maintenance concepts occurred. The initial interval for the Boeing 747 was established after this change in concept, and only three heavy inspections were required to reach a 20,000-hour interval. (United Airlines)

set of inspection intervals for each kind of operation and implement these tailored programs from the outset. Any initial structure program, however, merely specifies the start of age exploration for each item to determine its actual fatigue characteristics. The program includes all the inspection tasks necessary to protect the structure, but it is the results of these inspections after the equipment enters service that will determine the intervals to be used during continuing operation.

Until fairly recently structural inspection programs did not take into account the explicit role of the inspections themselves in the age-exploration process. The heavy structural inspections, the work package that includes all the inspection tasks in the program, were often the major part of what was called an "airplane overhaul"—an unfortunate term, since it implies that something can be done to restore the structure to like-new condition. Although the repair of damage found during such inspections will restore the original load-carrying capability, there is no form of remanufacture that will zero-time the effects of fatigue.

The so-called overhaul, therefore, could have no effect on the operating age at which fatigue cracks might appear.

Under older policies a fairly large proportion of the fleet was given a full structural inspection at a low age (2,500 hours in the case of the Douglas DC-8), the inspection findings were assessed, and the procedure was then repeated at a slightly longer interval. At all times, however, the emphasis was on the time since the last inspection, not on the total operating age of the airplane. As a result, 117 such inspections were performed on one fleet of Douglas DC-8's before the overhaul interval was extended beyond 5,000 hours, and of the 32 overhauls performed at the 5,000-hour limit, 9 represented the fourth overhaul and 16 the third overhaul for individual airplanes (see Exhibit 9.20).

The density of inspections performed under this policy varied from item to item; some items were inspected at every overhaul, some at every second overhaul, and so on. This procedure was explicit recognition of the fact that some items were more significant than others and that the exposure to deterioration varied from item to item. The concept of sampling is still employed in the age exploration of internal structural items with a high class number. This and other aspects of structural age exploration are discussed in detail in Chapter 11.

Since the airplanes in any given fleet will have entered service over a period of years, the difference in operating age between the oldest and the youngest airplane may be as much as 30,000 hours. As it became clear that the oldest members of the fleet were more likely to provide new information about fatigue damage, inspection emphasis shifted to what is often termed the fleet-leader concept, concentration of heavy structural inspections of the airplanes with the highest total time. This approach not only provides the same amount of information in the shortest calendar time, but identifies the age at which fatigue damage is likely to appear before the younger aircraft reach this age limit. Thus it is possible to perform fleetwide inspections for damage while it is still in its early stages and also to develop design modifications that will extend the fatigue life of the structural areas involved. The result of this change in concept was much more rapid extension of overhaul intervals and fewer such overhauls performed on aircraft too young to provide the necessary information.

As the structure ages in service the intervals for many individual items will be adjusted to ensure that deterioration is found as early as possible, and some items that are unacceptably short-lived may have to be modified to increase their fatigue lives. In general, however, the state of the art is now such that the designer can often establish quite meaningful predictions of fatigue life, and as these predictions have been borne out by experience, there has been a tendency to begin age exploration at increasingly higher ages with each new design.

completing the maintenance program

THUS FAR we have been concerned with scheduled-maintenance tasks generated by explicit consideration of failure consequences and the inherent reliability characteristics of each item. These tasks comprise the major portion of the total scheduled-maintenance program, but not all of it. The set of tasks identified by RCM analysis is supplemented by certain other scheduled tasks which are both so easy to perform and so obviously cost-effective that they require no major analytic effort. Five common categories of such additional tasks are zonal-installation inspections, preflight walkaround inspections, general inspections of external structure, routine servicing and lubrication, and regular testing of functions that are used only intermittently by the operating crew.

Zonal inspections, preflight walkarounds, and general inspections of external structure are not directed at any specific item and hence cannot in themselves be considered RCM tasks. However, they often serve as a vehicle for specific on-condition or failure-finding tasks. Servicing and lubrication tasks do in fact fit RCM decision logic, but their benefits are so obvious that the cost of analysis is not worthwhile. In contrast, the testing of infrequently used functions merely takes advantage of the scheduled-maintenance program to supplement the failure-reporting duties of the operating crew.

Once all the scheduled tasks have been assembled, we must turn our attention to the problem the maintenance organization faces in scheduling and controlling the accomplishment of the work. It is possible, of course, to schedule each of the hundreds of different tasks at the optimum interval for each item. It may even be desirable to do so if the fleet is very small and the opportunities for scheduled maintenance are very frequent. In most cases, however, it is necessary to group the tasks into a fairly small number of work packages so that they can be consolidated at a few maintenance stations and do not interfere with scheduled use of the equipment. Although this procedure results in

shorter intervals than necessary for a great many individual tasks, the additional cost is more than offset by the overall increase in efficiency. There is no single optimum way of packaging tasks, since the overall cost of the maintenance process depends on such factors as organizational structure, maintenance resources and facilities, and operating requirements.

This chapter discusses the additional work, beyond RCM analysis, that is required to complete an initial scheduled-maintenance program.

10·1 OTHER SCHEDULED-MAINTENANCE TASKS

ZONAL-INSTALLATION INSPECTIONS

Zonal inspections are based on the three-dimensional reference system required to identify the physical location of any item on an airplane. The entire airplane is considered to be partitioned into discrete spaces, or *zones*, usually bounded by physical features such as floors, bulkheads, and outer skins. The specific zones in each type of airplane are designated by the manufacturer, usually at the design stage, and are then carried through to all reference material on maintenance for that particular design. Exhibit 10.1 shows the zonal reference system used for the McDonnell F4J and Exhibit 10.2 shows a portion of the Boeing 747 zonal system.

The various assemblies and connecting lines (wiring, hoses, ducting, attach fittings) of the aircraft systems that are in each zone are referred to as *zonal installations*. In some cases, such as the cockpit area, the whole zone is readily accessible. More often, however, a zone must be entered by some access door in the outer surface so that mechanics can inspect, repair, or replace the various installations. Consequently zonal installations are subject not only to the normal wear and tear of use, but

zonal-installation inspections
walkaround inspections
general external inspections
servicing and lubrication tasks
testing of rarely used functions
event-oriented inspections

Major zones

- 1 Radome and radar compartment
- 2 Forward fuselage
- 7 Upper right wing
- 8 Aft fuselage and empennage
- 9 Upper left wing
- 12 Left intake duct and cavity
- 13 Center fuselage
- 14 Forward cockpit
- 15 Aft cockpit
- 16 Left engine
- 17 Right engine

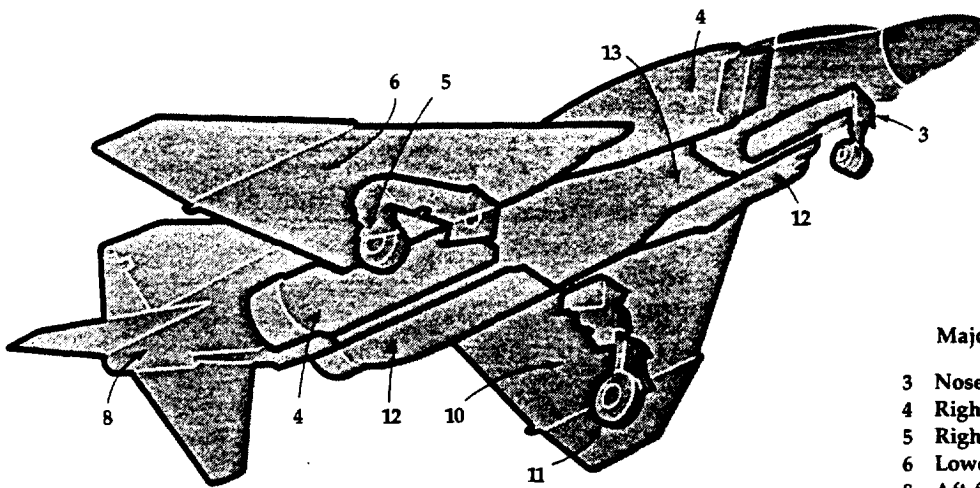
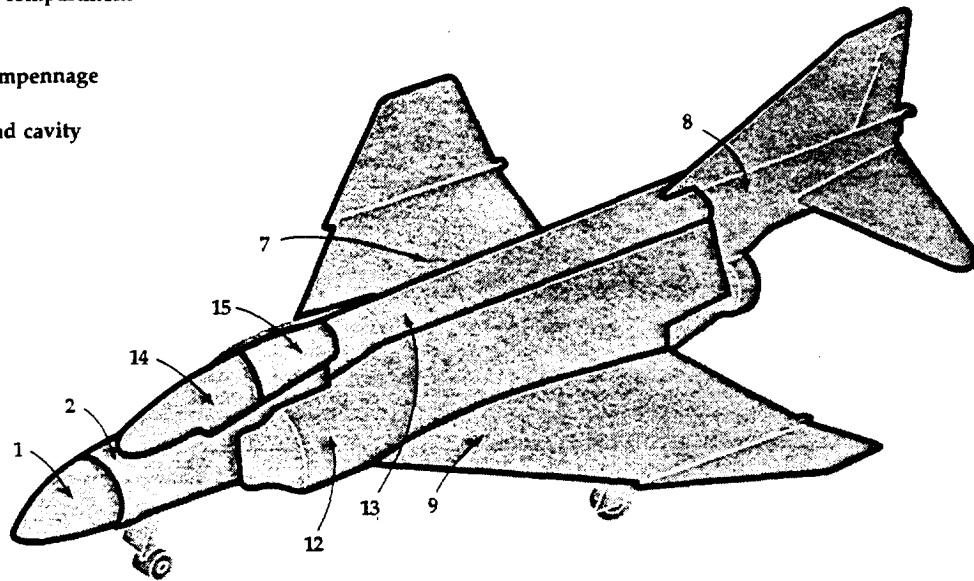

Major zones

- 3 Nose landing gear
- 4 Right intake duct and cavity
- 5 Right main landing gear
- 6 Lower right wing
- 8 Aft fuselage and empennage
- 10 Lower left wing
- 11 Left main landing gear
- 12 Left intake duct and cavity
- 13 Center fuselage

EXHIBIT 10-1 The zone numbering system for the McDonnell F4J.
(McDonnell Aircraft maintenance materials)

220 Control cabin and staterooms, sta 220 to sta 720

- 221 Control cabin, left hand
- 222 Control cabin, right hand
- 223 Compartment aft of control cabin, left hand
- 224 Compartment aft of control cabin, right hand
- 225 Staterooms, left hand
- 226 Staterooms, right hand

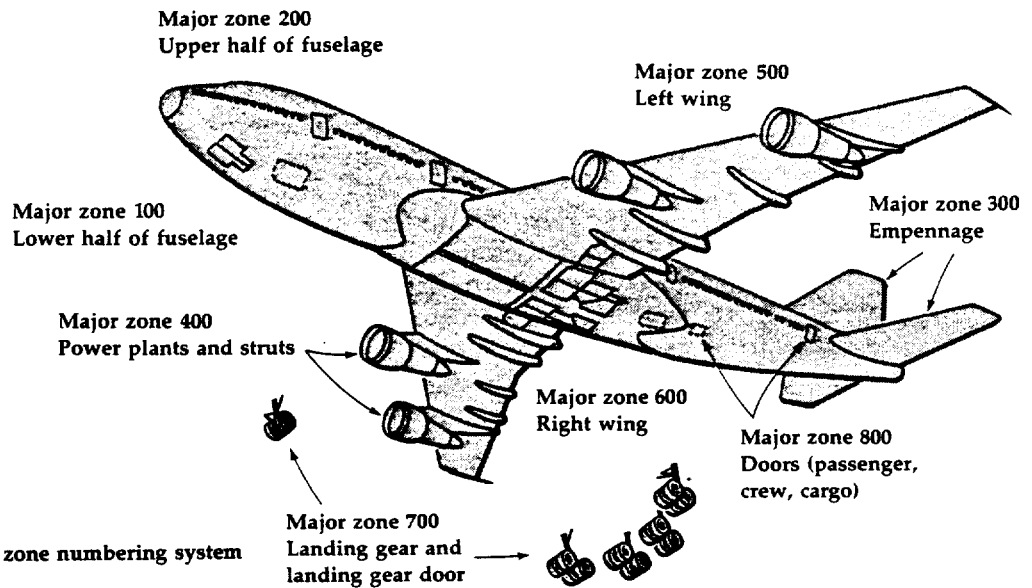
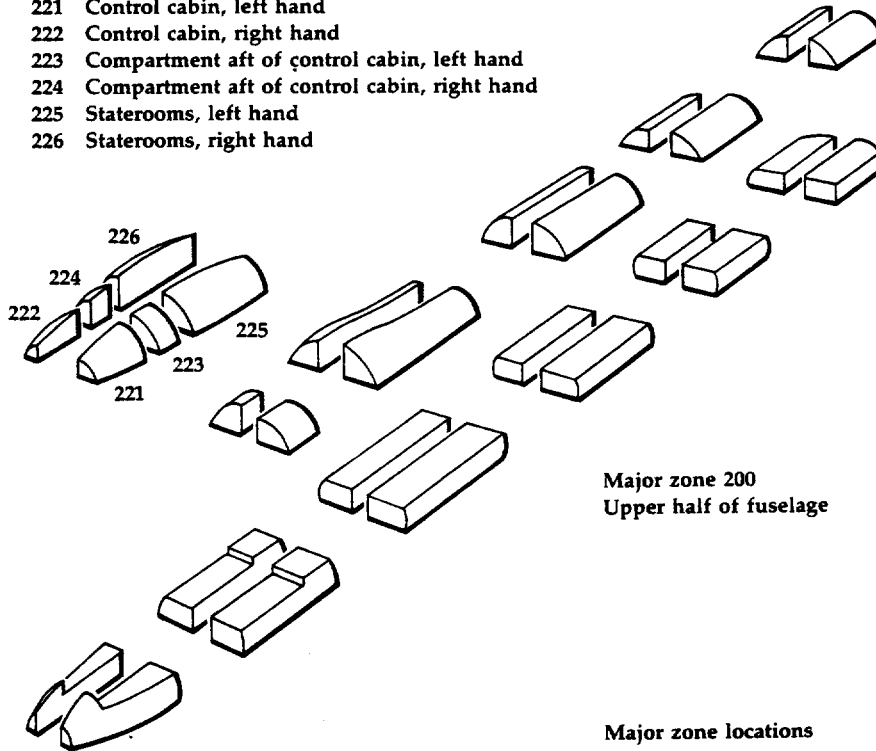

EXHIBIT 10-2 The zone numbering system for the Boeing 747.
(Boeing Aircraft maintenance materials)

also to accidental damage from the traffic of mechanics and other personnel in the zones. In the interests of prudence, therefore, a separate zonal inspection program is needed to complement the program of RCM tasks.

Although zonal inspections are directed primarily at the installations in each zone, they also include general inspections of those portions of the internal structure that can be seen with the installations in place. These inspections are relatively nonspecific checks on the security of installed items – to detect loose or missing parts or parts that may rub against each other – checks for any accidental damage, and a quick survey for obvious leaks. In some cases the number and location of the access doors govern the amount of a zone that is inspected. These inspections do not qualify as on-condition tasks, since they are not directed at a specific failure mode, except where leaks have been defined as a failure condition for a given item. However, they are very inexpensive to perform and provide an opportunity to spot early signs of problems developing in the systems. Thus they are cost-effective if they result in even a small reduction in repair costs or identify a potential failure at a time that avoids operational consequences.

In current practice the intervals assigned to zonal inspections are judgmental, although they are based on a general consideration, zone by zone, of susceptibility and failure consequences. In this case susceptibility refers to the overall vulnerability of the installations within a zone to damage, loss of security, and leaks (which we can construe as the probability of failure for the zone), and failure consequences refers to the ultimate effect of not detecting and correcting the conditions that could be discovered by a zonal inspection. These effects include the consequences of a functional failure (even the absence of emergency equipment in the event of an emergency), a more advanced potential-failure stage, or a multiple failure that might have been avoided by the inspection.

The interval for some zones may be very short. The cockpit of an airplane, for example, contains many items of emergency equipment, and since it is subject to heavy traffic by members of the operating crew, the cabin crew, and the maintenance crew, these items are all susceptible to damage. The consequences of not having this equipment in position and serviceable if it is needed are also very serious. These considerations lead to intervals as short as 20 hours and never longer than 200 hours (the usual A-check interval) for zonal inspections of this area. These inspections are often complemented by additional inspections that are part of the crew duties. At the other end of the scale, zones that contain no system installations are inspected at D-check intervals (20,000 hours or more). These inspections are for the sole purpose of looking at the nonsignificant portions of the internal structure within these zones.

While the intervals for zonal inspections are based on general assessments, rather than a comprehensive analysis of specific data, it is sometimes helpful to rate each zone for susceptibility and consequences and then assign class numbers, much like the rating scheme used to establish intervals for structurally significant items (see Section 9.2). The considerations in rating a zone for susceptibility to trouble would include:

- ▶ The number and complexity of installed items in the zone
- ▶ The susceptibility of individual items to deterioration of one kind or another (damage due to corrosion, heat, or vibration, for example, will usually depend on the location of the zone)
- ▶ The traffic in the zone that might cause damage, including the relative frequency of access for on-condition tasks and the replacement or repair of failed items

As with structural items, a scale of 1 to 4 is used to rate susceptibility and consequences separately for the zone in question:

<i>susceptibility</i>	<i>consequences</i>	<i>rating</i>
High	Serious	1
Moderate	Moderate	2
Low	Minor	3
None	None	4

In this case *none* means that there are no system installations in the zone. Such zones are still given a rating, however, since the zonal inspection program is the vehicle that ensures general inspections of nonsignificant internal structural items. (Structurally significant items are covered by the basic structure program, as described in Chapter 9.) The ratings for both factors are, of necessity, a matter of experience and judgment. Although consequences are taken into account, the evaluation is a very broad one and is not based on detailed examination of the reliability characteristics of each item, as is the case in developing a set of RCM tasks.

The lower of the two ratings is the class number for the zone and determines the relative frequency of zonal inspections: the lower the class number, the shorter the inspection interval for that zone. The intervals themselves depend on further subjective considerations of design characteristics, operating environment, and the flight hours logged during a given operating period.

The zonal inspection program is usually developed by a separate working group, and the results must be integrated with the scheduled tasks developed by the systems and structure groups to eliminate gaps and overlaps between the two programs.

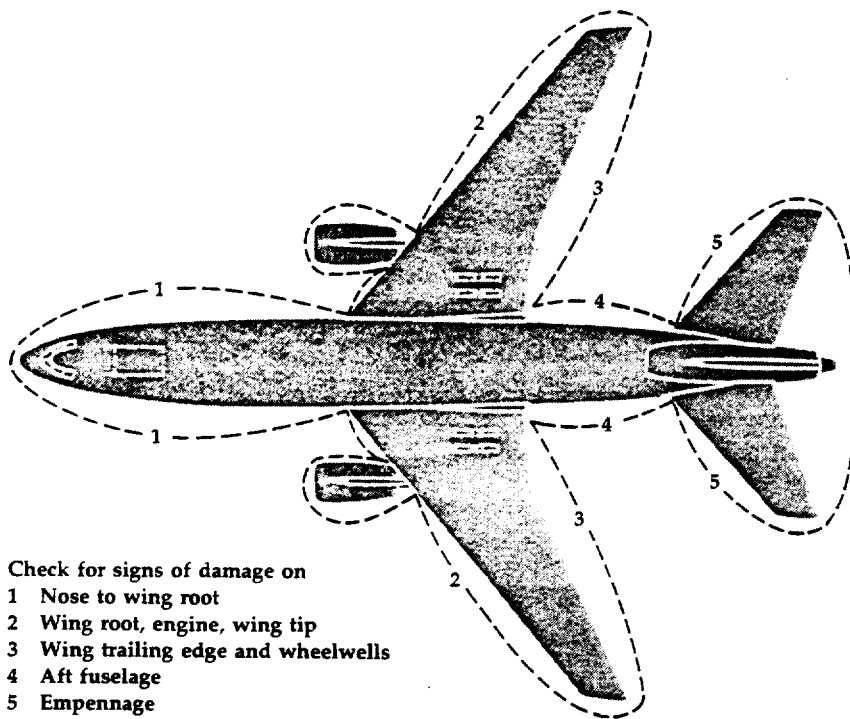

- Check for signs of damage on
- 1 Nose to wing root
 - 2 Wing root, engine, wing tip
 - 3 Wing trailing edge and wheelwells
 - 4 Aft fuselage
 - 5 Empennage

EXHIBIT 10-3 Diagram for a walkaround check on the Douglas DC-10, performed before or after each flight. (Douglas Aircraft maintenance materials)

WALKAROUND INSPECTIONS

Walkaround inspections are general visual inspections performed at the ground level to detect any obvious external damage. This may be accidental damage caused by contact with other aircraft, ground equipment, buildings, or debris thrown up from the runway, or it may be loose fittings or leaks from the various fluid lines. These checks are performed by the maintenance crew before each departure from a maintenance station and often incorporate simple on-condition tasks, such as a check of the brake wear indicators and specific checks of the structural areas expected to show external evidence of internal structural damage. There may also be independent preflight inspections by a member of the operating crew. In some military operations walkaround checks are performed both before and after each flight.

Walkaround inspections not only detect failures with minor consequences, but often provide the first indication of an impending engine or structural failure. A simple diagram like that in Exhibit 10.3 is usually included in the maintenance manual to identify the portions of the airplane where damage is most likely to be found.

GENERAL EXTERNAL INSPECTIONS

General inspections of the external structure are similar to the inspections performed during walkarounds, except that they include those portions of the structure that cannot be seen from the ground. Inspection of the vertical tail and the upper surfaces of the wings and fuselage requires the use of scaffolding that is part of the hangar dock. Consequently these inspections are performed at intervals corresponding to those of work packages that require hangar facilities.

SERVICING AND LUBRICATION TASKS

The scheduled-maintenance program also includes the periodic servicing and lubrication tasks assigned to various items on the airplane. Servicing includes such tasks as checking fluid reservoirs and pressures and replenishing or adjusting them as necessary, replacing filters, adding nitrogen to tires and landing-gear struts, and so on. Each of these tasks could be generated by RCM analysis (see Section 3.6), and sometimes they are. More often, however, the tasks are simply scheduled as recommended by the aircraft, powerplant, or system manufacturer, since their cost is so low in relation to the obvious benefits that deeper analysis is not warranted.

All servicing and lubrication tasks tend to involve the replacement of consumables, where it is expected that the need will be time-related. Although such tasks are usually assigned conservatively short intervals, the tasks themselves are so inexpensive that effort is rarely spent on age exploration to find the most economical interval.

TESTING OF RARELY USED FUNCTIONS

Much of the scheduled-maintenance program hinges on the fact that the operating crew will detect and report all evident functional failures. In some situations, however, an evident function may be utilized infrequently or not used at all during certain deployment of the aircraft. Such functions are not hidden in the strict sense of the word, since a failure would be evident during the normal performance of crew duties. Rather, they are hidden only when they are not being used. Under these circumstances the scheduled-maintenance program is a convenient vehicle for periodic tests to ensure their continued availability.

This continued availability is especially important for multiple-role equipment subject to sudden changes in operational use. One obvious example is an airplane all of whose scheduled flights fall in the daylight hours. In this case it is necessary to include tests of the landing lights, cockpit lights, and other items used for nighttime operation in the maintenance program, since actual use of these functions by the operating crew will not constitute an adequate failure-reporting system. The inverse of this situation—the extension of crew duties to cover tests of certain hidden-function items—usually applies in any operating

context; hence it is taken into account during RCM analysis (tests by the operating crew make the failure evident). However, the need for inspection tasks to cover rarely used functions depends on the actual use of the equipment, and such tasks must ordinarily be added to the program on an individual basis by each operating organization. Where the airplanes in a fleet are used under different sets of operating conditions, these tasks may be required for some members of the fleet, but not for others.

EVENT-ORIENTED INSPECTIONS

There are special inspections that are not scheduled in the ordinary sense, but must be performed after the occurrence of certain unusual events. Typical examples are hard-landing and rough-air inspections of the structure and overtemperature and overspeed inspections of engines. These are all on-condition inspections of the specific significant items which are most likely to be damaged by the unusually severe loading conditions.

10·2 PACKAGING THE MAINTENANCE WORKLOAD

letter-check intervals
maintenance-package contents

All the task intervals we have discussed so far have been based on the individual requirements of each item under consideration. The control of these individual tasks is greatly simplified by grouping the tasks into work packages that can be applied to the entire aircraft, to an installed engine, or to a removable assembly. In many cases the study groups developing each segment of the program will have anticipated the packaging procedure; thus individual tasks may be specified for an interval that corresponds to the preflight walkaround or to the A-check or D-check interval. In some cases a maximum interval is specified in hours or flight cycles as well, and the grouping of tasks must ensure that each task will be performed at some time within this limit.

Generally speaking, the tasks that have the shortest intervals are servicing tasks and simple inspections such as the walkaround checks, which do not require specialized training, equipment, or facilities. Thus the smaller maintenance packages are generally called *service checks*. A #1 service check may be a group of tasks that can be performed at every stop at a maintenance station, and a heavier #2 service check, amounting to 2 or 3 manhours of scheduled work, may be performed during every long layover if the airplane has flown more than 20 hours since the preceding #2 service. The major work packages, called *letter checks*, are performed at successively longer intervals (see Exhibit 4.11 in Chapter 4). Each letter check incorporates all the work covered by the preceding checks, plus the tasks assigned at that letter-check interval. Thus each one requires an increasing amount of manpower, technical skills, and specialized equipment.

Although the intervals for letter-check packages are customarily expressed in terms of operating hours, some organizations may prefer to convert them to calendar time based on average daily use of the equipment. Packages would then be designed to include tasks to be performed once a day, once a week, once a month, and so on. Similarly, the operator of a small fleet—say, two airplanes—may not want to be faced with a very heavy intermittent workload of two C checks a year, each requiring an expenditure of perhaps 2,000 manhours. He may prefer instead to distribute the C-check tasks among the more frequent checks, with a different group of C-check tasks performed at every A and B check. It is also possible to work out nightly packages with equalized work content by distributing the A and B packages as well. In this case, although the workload will be relatively constant, the actual tasks to be performed will vary greatly from night to night, making control of their accomplishment more difficult.

Even when the letter-check packages are not broken up in this way, their content will not necessarily be the same each time they are performed. For example, a task that has a long interval but is not time-consuming may be assigned to one of the more frequent letter checks but scheduled only for every second or every fourth such check. Conversely, a group of tasks that are especially time-consuming may be distributed among successive letter checks of the same designation, or there may be items that are monitored independently and scheduled for the time of the nearest check regardless of its designation. Consequently the actual tasks performed will often differ greatly for the same letter check from one visit of the airplane to the next.

Usually the objective in packaging is to consolidate the work into as few check intervals as possible without unduly compromising the desired task intervals. Some maintenance organizations attempt to make the interval for each higher check a multiple of the lower checks. This has the advantage of simplicity, but the necessity of maintaining the geometric relationship penalizes workload scheduling. One method of relating each check to the next higher check is illustrated in Exhibit 10.4. In this case the intervals are arranged to overlap as follows:

- ▶ The #2 service check includes a #1 service check and therefore zero-times the #1 check.
- ▶ The A check includes a #2 service check and zero-times it.
- ▶ The B check includes the next A check due and zero-times all the A-check tasks performed.
- ▶ The C check includes the next B check due and zero-times all the B-check tasks performed.
- ▶ The D check includes the next C check due and zero-times all the C-check tasks performed.

EXHIBIT 10-4 One method of relating letter-check intervals.

Note that the time scale is different for each line, and each check is scheduled to include the lower-level work package due at that interval. The C check is a special case; the tasks scheduled for this interval are split into four different phase-check packages, to be performed at successive B checks. Thus the equivalent of the first C check has been completed by the B₄ check, and so on. The D check, scheduled at 20,000 hours, zero-times all phase-check tasks performed through the B₂₃ check, but not those tasks scheduled for the B₂₄ check.

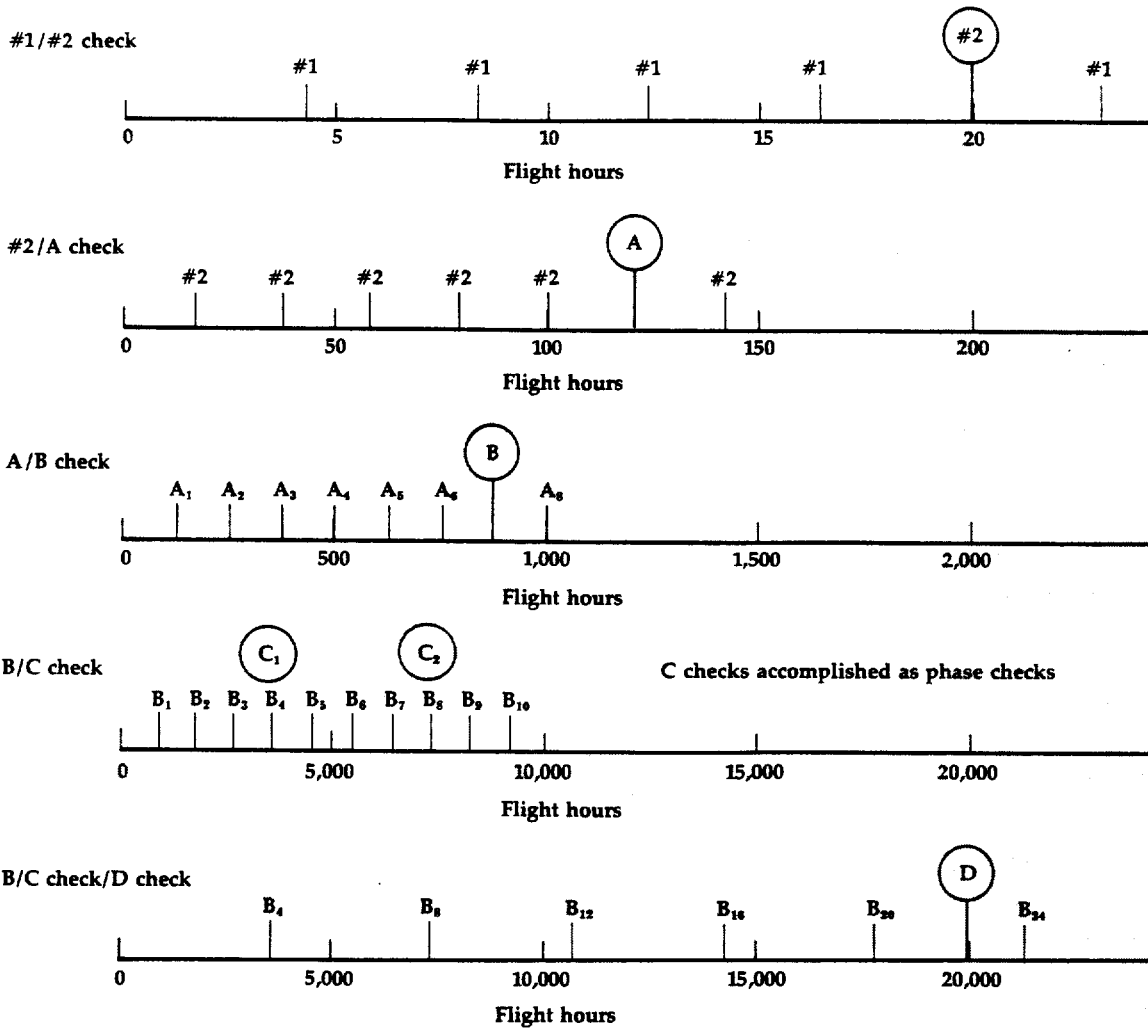

Alternatively, the C check might be divided into four smaller packages, with one of these packages assigned to each B check. The check that combines B- and C-check tasks is often called a *phase check*. Whereas a full C check would take the airplane out of service for 24 hours, it may be possible to accomplish a phase check in an elapsed time of 10 or 12 hours. When the C-check tasks are distributed in this way, the D-check includes the next phase check and zero times the tasks in that phase check.

The first step in assembling the tasks for each letter-check package is to establish the desired letter-check intervals. In an initial program these intervals, like the task intervals themselves, are highly conservative. The next step is to adjust the intervals for individual tasks to correspond to the closest letter-check interval. Whenever possible, poor fits should be accommodated by adjusting the task interval upward; otherwise the task must be scheduled at the next lower check or multiple of that check. As an example, the initial interval assigned to a corrosion-control task for the internal fuselage lower skin of the Boeing 747 was 9,000 hours. The inspection is essential to protect the bilge areas of the plane from corrosion, but this interval would have necessitated a separate visit to the maintenance base for a single task. Since the interval represented a conservative value in the first place, some flexibility was considered allowable, and it was decided that the interval could safely be extended to 11,000 hours, which coincided with a group of tasks scheduled for a midperiod visit at half the D-check interval.

Exhibit 10.5 shows a partial list of the scheduled tasks included in each letter check for the Boeing 747. Note that this program employed phase checks in place of a C-check work package. When phase checks are used there is no real C check, in the sense of a group of tasks all of which are to be performed at the same time. It is helpful to refer to a phantom C check, however, to develop the content of the phase-check packages, and the tasks of the phantom C check have the desired interval if they are performed at every fourth phase check.

Exhibit 10.6 shows sample tasks from a somewhat different packaging scheme for the McDonnell F4J. This program was designed for a military context, but it includes several of the packaging features found in its commercial counterpart. For example, the work package designated as the maintenance check is actually spread out over six lower-level phase checks, much like the series of phase checks performed at the B-check interval on the Boeing 747.

Both the task intervals and the package intervals in an initial program are subject to age exploration. Usually the intervals for individual tasks are increased by extending the package intervals, as discussed in Section 4.6. When a maximum interval is identified for a specific task, the task will either be assigned to a different letter-check package or, if it is a task that controls the rest of the package, the check interval will be frozen.

EXHIBIT 10-5 Partial maintenance-package contents for line and base maintenance on the Boeing 747. (United Airlines)

LINE MAINTENANCE

#1 SERVICE After each completed flight, average 4 flight hours

Review flight log

Perform walkaround check

#2 SERVICE Every 20 flight hours

Perform #1 service

Check tires and brake wear indicators

Check constant-speed-drive oil quantity

Check engine oil quantity

Check exterior lights

Clear deferred flight-log items

A CHECK At overnight layover, limit 125 flight hours

Perform #2 service

Check essential and standby power

Check battery, auxiliary power unit

Check cool-gas generator freon level

Check portable fire extinguisher

Check hydraulic-system differential-pressure indicator

Perform general visual inspection of landing gear

Inspect landing-gear shock struts

Check truck-beam bumper pads, main landing gear

Inspect cockpit zone

A5 check (every fifth A check)

Lubricate landing gear

BASE MAINTENANCE

B CHECK Limit 900 flight hours

Perform next A check due

Check hydraulic-supply fire-shutoff valve

Lubricate main cargo door

Check hydraulic accumulator

Lubricate flap-transmission universal joint

Lubricate midflap carriage roller

Inspect wing fixed trailing-edge upper panel

Inspect wing trailing-edge flap track

Inspect engine second-stage compressor blades

Test engine and fuel-control trim

Check and service engine main oil screen

B2 check (every second B check)

Check magnetic plug, engine main 3 and 4 bearings

Inspect fire-extinguisher pylon support

Inspect body station 2360 pressure bulkhead, aft side, for corrosion

Check and service magnetic plug, auxiliary power unit

Test and service battery and charger, inertial navigation system

B3 check (every third B check)

Inspect crank, latch, and torque tube, main entry door (limit 3,200 flight hours)

C CHECK Performed as phase checks over four successive B checks, limit 3,600 flight hours

Perform next B check due

EXHIBIT 10-6 Partial maintenance-package contents for maintenance performed on the McDonnell F4J. (United Airlines)

TURNAROUND Average every 2 flight hours

Clear pilot squawk sheet

Perform walkaround check for damage

Intensive inspection of torque-arm assembly, nose landing gear

Check fluid quantity, hydraulic reservoirs, and service as required

Check operation of boundary-layer-control airflow at one-half and full flaps

Check pressure gage, emergency oxygen supply

DAILY Every day aircraft is on operational status

Service liquid-oxygen converter (pilot/radar operator oxygen supply)

Check pressure gages, pneumatic-system emergency bottles

Check tire condition, nose landing gear

Check struts, nose landing gear and main landing gear, and service as required

Check brake condition, main landing gear

Check pressure gages, hydraulic-system accumulator

Check visual indicators, personnel emergency equipment

Check boundary-layer-control, bellows, and outer-wing connectors

General visual inspection of lower inboard and outboard wing surface

General visual inspection of wingfold area

Check engine oil quantity

SPECIAL At 7 days when aircraft is on operational status

Check chemical dryers

Clean water drain holes, lower forward fuselage

Inspect drag chute for damage (if deployed in last 7 days)

Service constant-speed drive and check for leaks

At 14 days when aircraft is on operational status

Lubricate aileron, spoiler, flap hinges, speed-brake hinges, landing gear, and gear doors

At 30 flight hours; when due, combine with lower check

Check operation of transducer probe heater

Check angle-of-attack sensor and signal quality to air-data computer

Check operation of accelerometer

At 35 days when aircraft is on operational status

Intensive inspection of wing rear spar

Intensive inspection of lower torque-box skin

Intensive inspection of aileron-actuator access door

Intensive inspection of canopy sill (underside) for corrosion

Intensive inspection of upper longeron

PHASE CHECK At 80 flight hours; six checks per 500-hour cycle

Lubricate doors, uplocks, ring, and torque collar, main landing gear

Lubricate wingfold mechanisms

Lubricate ejection-seat components

Inspect spoiler and aileron control-cylinder rods, bolts, and nuts

Inspect wing upper and lower skin

Inspect arresting hook

Check operation of refueling shutoff valves

At 160 flight hours (every second phase check)

Intensive inspection of trunnion fitting, nose landing gear

Intensive inspection of aileron lower-closure skin

Check operation of emergency UHF transmitter/receiver

Lubricate landing-gear control handle

At 240 flight hours (every third phase check)

Check operation of landing-gear emergency extension system

Change oil, constant-speed drive unit
Replace aircraft battery and auxiliary-power battery and test thermoswitch
Check external-power receptacles
Inspect cockpit equipment and installations
Check oil quantity and service horizontal-stabilizer-control drive unit
Inspect wing trailing-edge sections
Perform separate operational check of each flight-control hydraulic system
Treat wheelwell cables, main landing gear, for corrosion protection (limit 4,000 flight hours)
Inspect floor, main cabin and upper deck
Inspect engine pylons
Inspect rudder-stabilizer hinge-support fitting
Inspect cabin interior
C2 check (every second C check or every eighth B check)
Inspect access door, electronic and air-conditioning bay
Lubricate torque tube and sprocket, main entry door
Test heat-override valve, aft cargo compartment
Test electronic-equipment airflow detector
Test autothrottle limit
Lubricate flight-control-surface hinges
Lubricate trailing-edge flap track
Inspect fillet-fairing support structure for corrosion
Inspect lower rudder, upper closing rib
C4 check (every fourth C check)
Inspect tail-cone intercostals

C5 check (every fifth C check)
Clean electronic racks
Service alternate drive motor, wing trailing-edge flap
C_X check (at nearest C check)
Inspect internal fuselage lower skin for corrosion and apply LPS oil (12,000 hours start, repeat at 9,000 hours ± 2,000 hours)
D CHECK Limit 25,000 flight hours
Perform next phase check due
Inspect and sample structural items
Refurbish cabin
Repaint aircraft
Inspect rudder and elevator cables
Test aileron and aileron-trim system (also test all other flight-control systems)
Test fire-extinguishing system
Inspect all ac power wiring
Check flight-compartment access doors
Inspect cables, fuselage pressurized areas
Inspect spare-engine aft support fitting for corrosion
Replace and rework landing-gear parts, oxygen regulators, and other specified items

Intensive inspection of outboard leading-edge flap actuators, attach-fitting links, and bellcranks

Check operation of constant-speed-drive underspeed switch and frequency drift

MAINTENANCE CHECK At 500 flight hours; performed over six phase checks, or 480 flight hours

External visual inspection of critical zones

Internal visual inspection of critical zones

Check hydraulic-system filters; replace as necessary

Service hydraulic system

Inspect control cables for chafing, integrity, and rigging

Inspect control-system mechanism; clean and lubricate as required

Replace air filters on electronic cooling-air system

Test operation of bell-mouth seal system

Test operation of IFR emergency-extend system

Check nose-landing-gear centering system (strut extended)

Intensive inspection of nose-landing-gear extend system

Lubricate nose-landing-gear bearing, doors, and uplocks

Intensive inspection of critical structural items

Lubricate flight controls

Inspect and test operation of boundary-layer-control valves and systems

Check operation of seal trim system

Intensive inspection of stabilizer actuator, rod, and actuator fitting

Test operation of canopy jettison system

At 300 days (ranges from 200 to 600 flight hours)

Remove ejection seat for limited functional test; check and service (corrosion protection) as required

DEPOT VISIT Limit 960 flight hours or 42 months

Inspect and sample structural items

Remove ejection seat and perform general visual inspection of cockpit

Repaint aircraft

Inspect control cables

Remove landing gear

Replace flight-control bearing

Check component hidden functions

SPECIAL CONDITIONS

Engine removal, scheduled at 600 flight hours or on-condition

Check boundary-layer-control bleed-air check valve

Intensive inspection of engine mounts

Perform visual check of engine firewall

Before carrier duty

Check canopy-actuator shear-pin gap

Check operation of canopy emergency jettison

After 75 arrested landings

Perform magnetic-particle inspection of axle/brake-flange fillets, main landing gear

the use of operating information

AGE EXPLORATION, the process of determining the reliability characteristics of the equipment under actual operating conditions, begins the day a new airplane enters service. This process includes monitoring the condition and performance of each item, analyzing failure data to identify problems and their consequences, evaluating inspection findings to adjust task intervals, and determining age-reliability relationships for various items. Since the decision process that led to the initial scheduled-maintenance program was based on prior-to-service information, the program will reflect a number of default decisions. As operating experience begins to produce real data on each item, the same decision logic can now be used to respond to unanticipated failures, assess the desirability of additional tasks, and eliminate the cost of unnecessary and overintensive maintenance resulting from the use of default answers.

In the preceding chapters we considered certain aspects of age exploration as they relate to task intervals and the intensive study of individual items in the systems, powerplant, and structures divisions. In a broad sense, however, age exploration encompasses all reliability information on the aircraft as it ages in service. Thus the heart of an ongoing maintenance program is the collection and analysis of this information, either by the engineering organization or by a separate group.

11·1 TYPICAL INFORMATION SYSTEMS

Although intensive age exploration of individual items plays a direct role in assessing their maintenance requirements, this is only one of many sources of reliability information. In the case of airplanes it is also not the information of most immediate concern. In order to respond to unanticipated problems, an operating organization must have some means of identifying those that require first priority. On this basis the airline industry ranks the various types of reliability data according to the priority of failure consequences and is generally concerned with information in the following order:

types of information systems
the uses of operating
information

- ▶ Failures that could have a direct effect on safety
- ▶ Failures that have a direct effect on operational capability, either by interrupting the flight or by restricting its continuation
- ▶ The failure modes of units removed as a result of functional failures
- ▶ The causes of potential failures found as a result of on-condition inspections
- ▶ The general condition of unfailed parts in units that have failed
- ▶ The general condition of parts in units removed specifically for sampling purposes

This order of importance is consistent with the priorities underlying the RCM distinctions between necessary and economically desirable scheduled-maintenance tasks.

The data needed to manage the ongoing maintenance program must usually be extracted from a number of information systems, some of which were established for purposes quite different from that of supplying data to maintenance analysis. As a result, it is sometimes a laborious process to assemble all the information elements needed for maintenance decisions. Most information systems can be classified according to three basic characteristics:

- ▶ *Event-oriented systems* collect and record data whenever an undesirable event occurs. Such systems range from a plan for immediate telephone communications between designated executives in the event of any failure that involves safety considerations to a system for recording unsatisfactory conditions found during scheduled inspections.
- ▶ *Monitoring systems* summarize data about some aspect of the operation during a specified calendar period. The data are extracted from event-oriented systems and are summarized in reports such as the monthly premature-removal report, the monthly delay-and-cancellation report, and so on. These reports are prepared regardless of the occurrence of any reportable events; thus they give positive information about the absence of problems as well as information on any problems that have occurred.
- ▶ *Analysis systems* not only collect, summarize, and report data, but also give the results of some special analysis of the information. This might be an actuarial analysis, a determination of the 20 items with the highest premature-removal rates, or some other specific analysis.

One of the most important information systems is the airplane *flight log*. The primary purpose of this log is to record the operating and maintenance history of each airplane. Such information as the flight number, the names of the crew members, fuel on board at takeoff, oil on board at takeoff, takeoff time, landing time, and observed engine performance parameters and vibration levels are always recorded. In addition, any instances of unsatisfactory conditions observed during the flight are entered on the log sheet to alert the maintenance organization to the need for corrective maintenance (see Exhibit 11.1). The maintenance crew also uses the log to record the repairs made as a result of these reports, to record the performance of scheduled tasks, and by signing a maintenance release, to certify the airplane's airworthiness. Copies of recent log sheets are kept in the airplane for review by the operating crew, and the older sheets are sent to a permanent central file.

EXHIBIT 11-1 Log sheet from an airplane flight log. The flight log shows any unsatisfactory conditions reported by the operating crew, as well as the corrective action taken by the maintenance crew. (United Airlines)

captain (print) **A. Pilot** (sign) *A. Pilot* dom **JFK** date **2-7-76** enter plane number **2042**
 second officer (print) **S. Officer** (sign) *S. Officer* dom **JFK**
 flight crew make entries in white area enter of enter initial enter no. indicate work accomplished
 K other T&B #1SVC #2SVC A B C maintenance release signatures station
 1 *SM* *NT* 1 *L Macchia* **ORD**
 2 *NT* 2 *Turner* **DEN**
 3
 4
 5
 6
 7

AIRPLANE FLIGHT LOG

Flight no. & date	T/O EPR		gallons boarded	lb fuel at		stations		max. cruise alt.	flight time			check whether or not service required	
	max.	actual		block dept.	block arr.	from	to		off	on	hr		min
1 2875 7	1.35	1.74	3969	43.2	20.6	JFK	ORD	39.0	1255	1445	1	50	
2 2875 7	1.70	1.74	4705	50.8	23.7	ORD	DEN	39.0	1557	1804	2	07	
3 2875 7	1.8	1.78	1810	34.9	22.8	DEN	SLC	39.0	1950	2050	1	00	
4
5
6
7	4	57	(details omitted)

(details omitted)
 trip time
 TSO start 1705504
 TSO end 1706001
 com. TSO

item no.	DISCREPANCY	limit insulation code	item no.	station	CORRECTIVE ACTION	def. no. new	def. no. corr.
1	Precautionary shutdown of #1 eng doct. fluctuating oil press, oil press light on, high oil temp. Windmilling time: 25 min. Shutdown oil press: 10-20psi		1	ORD	Dom		
			1	SLC	Pulled accy case; oil strainer, scavenge oil screen, main oil screen found ok. Refilled oil tank. Ran engine. No leaks. OK for service per SFOLM A. Controller		
2	Had to use continuous ignition to start #2 Eng.		1	SLC	Recheck #1 Eng main oil screen in 30 hrs by TSO 17110:01 per SFOLM Controller	277	
			2	SLC	OK to cont Def. per Controller SFOLM	278	
			2	SLC	REPLACED EXCITER BOX - B. Mechanic DENMM		278

CHRONIC ITEM REVIEW:

Another event-oriented system is the *aircraft maintenance information system*, which keeps track of all the scheduled-maintenance tasks performed at each line station and the manhours required for each one, as well as the time spent on corrective work as a result of crew-reported failures or conditions discovered during performance of the scheduled tasks. Some of the larger airlines have computerized this system and enter the log-book failure reports into it as additional data. This allows a maintenance station to determine what deferred repairs are going to be necessary for an arriving airplane. However, this real-time on-line system is still in the early stages of development.

The *daily operations report* is both a monitoring and an event-oriented system. Among other things, it provides a brief narrative description of any unusual flight incident, flight interruption, delayed departure, or cancelled flight that has occurred during the preceding 24-hour period.

Data associated with premature removals are reported by means of *identification and routing tags*, another event-oriented system. A tag attached to the unit that is removed records the removal information and information on the replacement unit and then routes the removed unit back to a maintenance base (see Exhibit 11.2). The tag stays with the unit throughout the repair process and is then filed for future reference. When a major assembly, such as an engine or a landing gear, reaches the shop for rework, additional tags are generated for any sub-assembly that is removed and routed to another shop.

Some of the event-oriented systems are complemented by monitoring systems. For example, data are extracted periodically from the identification and routing tags to show the premature-removal rates of significant items. Similarly, data extracted from the daily operations report for the monthly summary of delays and cancellations identify the associated failures on a periodic basis.

There are additional information systems designed to ensure that there will be a record of all adverse findings during every inspection performed, as well as a record of any corrective work done as a result of such findings. While this information is available on all items subject to scheduled tasks, the data may be difficult to retrieve. For this reason it is common practice to designate certain units as *time-extension samples* when an increase in task intervals is being considered and to pay particular attention to data gathering for these samples.

In many cases it is relatively easy to review the data and decide whether a change in the scheduled-maintenance program would be desirable. If it takes a long time to repair a certain type of failure, and scheduled flights must therefore be cancelled, the economic justification for a preventive task is apparent—particularly if the failure is one that occurs frequently. And if no preventive tasks are applicable to

IDENTIFICATION & ROUTING TAG

stock no. & name _____ dash no. on 358 unit TSO on 0

maint. shops FS home shop _____ ship. cont. _____ batchable R

X date serviceable 1-20-75 quantity 1 X

plane no. 7567 plane TSO 13766 engine no. _____ date 1/22/75 station SEA

Why was unit removed? (see over) detailed reason for removal No Brightness

resp. failure X time attached _____ other _____

unit TSO off _____ dash no. off 30 plane or eng. position _____ unit position _____ by [Signature] engine TSO _____

Does unit condition agree with removal reason? yes Was other condition found which would cause removal? no

1	2	3	4	5	6	7	8	9	10	11	12	disposition BC/repair overhaul _____ returned to vendor _____ junked or surplus _____ other _____	SFOMB DCAMB _____	enter other station _____
13	14	15	16	17	18	19	20	21	22	23	24			

What caused failure? Picture tube 86718 signature [Signature]

Enter remarks about serviceable unit only in this area:

Enter remarks about repairable units in this area:

Repl. DST acct. Bad

Forward repairable tags daily to SFOMB

EXHIBIT 11-2 An identification and routing tag showing the unit removed from the airplane, the reason for removal, verification of the problem, and disposition of the unit. (United Airlines)

an item, there is no point in adding them, regardless of the operational consequences of the failures (there may, of course, be a point in re-designing the item). Sometimes, however, when a functional failure might or might not have operational consequences, depending on the circumstances, it may be necessary to retrieve information from a number of different sources to gain a clear picture of the problem.

EXHIBIT 11-3 Premature-removal "top-twenty" report. This information, extracted from the monthly premature-removal report, lists data on the 20 items with the highest premature-removal rates. Note that this report also shows the number of premature removals that were verified as functional failures. (United Airlines)

TOP TWENTY PREMATURE REMOVALS

type of aircraft Boeing 727

period April-June 1978

premature-removal rank	maintenance records no.	name	no. of premature removals	premature-removal rate (per 1,000 unit hours)	no. of verified failures	percent of verified failures
1	21392	Control, cabin pressure	56	3.28	18*	32
2	43132	Indicator, WX radar	189	1.85	66*	35
3	42210	Receiver, VHF navigation	71	1.68	5*	7
4	25342	Dispenser, coffee maker	368	1.59	171*	46
5	43122	Accessory unit, WX radar	161	1.58	14*	9
6	43112	Transmitter/receiver, WX radar	151	1.48	73	48
7	41701	Indicator, standby attitude (SAI)	13	1.28	4	31
8	23711	Recorder, cockpit voice	124	1.22	82	66
9	41134	Computer, air data	31	1.14	21	68
10	42252	Receiver, VHF nav/glidescope	22	1.08	10*	45
11	31212	Recorder, flight data	104	1.02	40	38
12	33496	+ Light, anticollision	10	.98	5*	50
	33495	- Included with 33496				
13	22113	Channel-pitch control	26	.96	6	23
14	43511	Transmitter/receiver, radio altimeter	95	.93	23	24
15	23311	Amplifier, public address	66	.88	12*	18
15	23501	Accessory unit, audio	15	.88	1*	7
16	22305	Controller, pedestal	64	.86	23*	36
17	41294	Battery box, SAI system	87	.85	46*	53
18	41135	Altimeter, electric	17	.84	3*	18
19	21329	Controller, cabin pressure auto	61	.82	19*	31
20	41193	Computer, air data	59	.79	16*	27

*Shop data incomplete.

298

Suppose, for example, that the daily operations report, or perhaps the monthly summary of delays and cancellations, indicates that failures of a particular system item are causing a fairly large percentage of delayed departures. Under these circumstances the maintenance organization would investigate to see whether these consequences can be alleviated. The first step is to review the delay-and-cancellation summaries for the past several months to obtain a broader-based statistic on the delays. It is then necessary to go back to the daily operations report to find out the actual length of the delay and the assembly or assemblies involved in most of the failures.

Once the dimensions of the delay problem have been established, the next step is to determine whether failures are evident to the operating crew, and if so, what is being reported in the flight log as evidence of failure. It is always possible that the definitions of satisfactory performance are so demanding that the cost is greater than the benefits. The log sheets may also supply some information on the assemblies that are failing, but the best source of this information is the aircraft maintenance information system. This system will show whether corrective maintenance involves replacing failed units, and if so, the frequency of replacement and the line-station cost of the work. The frequency of repairs may be much higher than the frequency of operational delays; for example, failures on airplanes inbound to overnight layovers would have no operational consequences.

If the failures do involve the removal of units, the monthly premature-removal report will provide an overview of the frequency of premature removals. This report also shows the proportion of premature removals that are verified failures (see Exhibit 11.3). If there are numerous unverified failures, better troubleshooting methods are needed. A check of the present methods requires reference to the identification and routing tag system, shop records, and engineering records. A quick analysis of these records will also show whether one or more dominant failure modes account for a large proportion of the failures. In either case the shop cost records must be examined to determine the material and labor costs incurred in repairing failed units.

With this information, together with a figure for the imputed cost of delays, it is now possible to return to the RCM decision diagram to examine possible cost-effective tasks. If none can be found, or even if there are applicable and effective tasks, the desirability of design changes to improve the inherent reliability of the item should also be investigated. One supplementary bit of information will help substantiate the cost effectiveness of a design change—the reduction in spare replacement units that would result from a lower premature-removal rate. This information requires a special analysis by the inventory-planning organization.

A complete analysis of this type has required reference to eight different information systems (see Exhibit 11.4). In time the use of integrated data bases will make it easier to assemble the relevant data. Fortunately, however, not all maintenance decisions require this complete a study. Indeed, the need for a formal study can often be determined fairly simply by means of the decision diagram discussed in Section 4.4.

EXHIBIT 11-4 An example of the information systems that might be consulted to determine the desirability of introducing a change in the scheduled-maintenance program.

information needed	source of data
Identification of system whose failures may be causing operational delays	Daily operations report or monthly summary of delays and cancellations
Frequency of delays	Monthly summary of delays and cancellations
Length of delays	Daily operations report
The failure evidence that is apparent to operating crews	Flight-log sheets
Identification of assembly or part causing a large proportion of system failures	Daily operations report and aircraft maintenance information system
Determination of whether repair at line station requires replacement (premature removal) of unit	Aircraft maintenance information system
Frequency of unit replacement	Aircraft maintenance information system and monthly premature-removal report
Cost of corrective maintenance (labor) at line station	Aircraft maintenance information system
Cost of corrective maintenance (labor and materials) at maintenance base	Shop cost records
Identification of failure modes and failure-mode dominance	Shop records, identification and routing tags, special analysis
Desirability of modifying scheduled-maintenance program	RCM analysis
Effect of failure rate on spare-unit requirements	Inventory-planning system
Desirability of design change (product improvement)	Special analysis

11-2 TYPICAL TYPES OF ROUTINE ANALYSIS

Many analyses are performed routinely as a part of age exploration. The engine data recorded in the flight log, for example, are fed into a computer after each flight and are analyzed on a daily basis. This computer analysis reduces the observed data to "standard-day" reference conditions, compares the performance of each engine with that of other engines on each airplane for a specific flight, and compares each engine with its prior history. The observed data are weighted so that small changes in recent information receive more attention than small changes between recent and older performance, and statistical-significance tests are used to identify engines whose performance parameters require further investigation.

This program of *flight-log monitoring* is useful in detecting minor variations and trends that would not be apparent to the operating crew. The process cannot pinpoint the exact cause of the variation, and the readings can be affected by instrument changes, since each instrument has different calibration errors. However, flight-log monitoring does prompt investigations that may lead to engine removals (usually less than 5 percent of the total premature-removal rate), and on this basis it might be considered a form of on-condition inspection.

Two other data elements that are monitored by trend analysis are in-flight engine shutdowns and premature removals. Exhibit 11.5 shows a typical report generated by a shutdown event and a summary report of all shutdowns for that type of engine during a given month. Exhibit 11.6 shows long-term trends in shutdown and premature-removal rates for the same engine. Premature-removal rates are summarized monthly for all significant items, usually with a supplementary report like that in Exhibit 11.3, listing the items with the highest removal rates. These summaries do not identify the failure consequences, but they do show which items are the least reliable.

Premature-removal data are used not only for actuarial analysis, but also to help identify chronic maintenance problems, failures that are deep in a system and are not corrected by replacing the items that seem to be causing the problem. Removal data are fed into a computer that retains a certain amount of recent history, usually covering a period of about a month. New data are compared with the stored history and an alert is given if an item has more than the expected number of removals during the period covered. This alert report identifies the airplanes that have had repeated removals and also notifies the maintenance organization that special troubleshooting effort is needed to locate the source of the problem. Other systems for identifying airplanes with chronic problems use the flight log as a data base. All such

flight-log monitoring
chronic maintenance problems
analysis of premature-removal
data
actuarial analysis
effect of an overhaul limit
on age exploration

plane no. 8042U	station SLC date 2/8/76
incident no. 081400	unsched. landing
delay delay time	cancellation substitution
flight in/date	flight out/date
plane no. dispatched	in-flight stage Cruise
primary resp. station system 79	engine in-flight shutdown Yes

problem and repair, parts replaced (include part nos.)

Log report: Precautionary shutdown no. 1 eng acct fluct oil press, lite on, hi temp. Windmilled 25 min, maintained 20 psi.

Action: SLCMM refilled oil tank, ran 20 min, no oil loss. No external oil leakage found. Found oil qty gage stuck at 8.5. Swapped gages and oil qty checked OK after filling oil tank. Accessory case strainer, scavenge oil screen, main oil screen all checked OK. Deferred SFOMM.

EXHIBIT 11-5 Left, a typical in-flight shutdown report showing the details for that event, and right, a monthly summary of the in-flight shutdowns for that type of engine. (United Airlines)

EXHIBIT 11-6 Shutdown and premature-removal rates plotted over an 18-month period for the Pratt & Whitney JT3D-3 engine on the Douglas DC-8. (United Airlines)

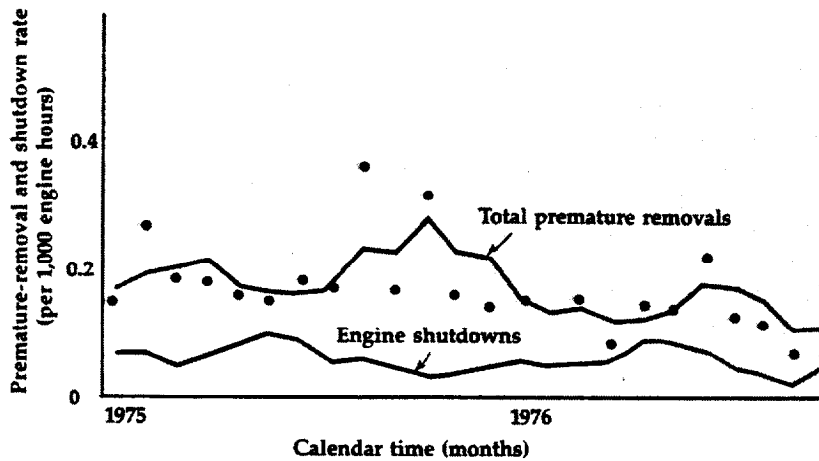

type of aircraft Douglas DC-8

period February 1976

type of engine Pratt & Whitney JT3D-1/3/3B

no.	plane, eng	date, station	engine age	reason for shutdown	line action	findings
1	8042U 1	2/7 SLC	20681	High oil temperature	Engine change	Undetermined critical other X
2	8081U 2	2/11 ORD	22303	Engine oil temperature pegged, found rear bearing seal failed	Engine change	Gearbox full of oil; severe cavitation erosion in pressure-pump cylinder wall through which oil leaked critical other X
3	8044U 3	2/18 JFK	16920	Low oil pressure	Found oil leak at B nuts inlet and outlet of oil- scavenge screens; re- torqued B nuts, checked OK, returned plane to service	Loose B nuts at scavenge screen critical other X

reports are intended to aid in troubleshooting on airplanes with especially complex systems, but as the use of built-in test equipment (BITE) becomes more common, they may become unnecessary.

From time to time it is desirable to explore the age-reliability relationship for a particular item to determine whether a scheduled rework task is applicable. In this case the premature-removal data are supplemented by other data for the several different analyses that might be made.* Exhibit 11.7 shows the history of a constant-speed-drive unit on the Boeing 727 over one calendar quarter. Note that this report identifies the types of functional failures, as well as the failure modes. Exhibit 11.8 shows the results of an actuarial analysis of this history, and the curves in Exhibit 11.9 show a summary analysis of data over a period of several years. The constant-speed drive shows no evidence of a wearout age, indicating that removal of this item for rework at some arbitrary operating age will have little effect on its reliability.

*For a detailed discussion of the actuarial techniques employed in these analyses, see Appendix C.

EXHIBIT 11-7 A history of operating experience over one calendar quarter with the constant-speed drive on the Boeing 727. The unit TSO refers to operating age since last shop visit. (United Airlines)

item identification MR 24118 727 constant-speed drive			study period February 1-March 30, 1976																		
unit TSO in 500-hr intervals	operating hours per interval	no. premature removals per interval	reason for removal						shop findings						no. units in interval at end of period						
			1 metal in sump	2 faulty output	3 high oil temp.	4 leaks, low oil level	5 low oil press.	6 miscellaneous	1 housing leak	2 seal leak	3 hydraulic log failed	4 governor failed	5 differential log failed	6 Spraggs failed		7 idler gear failed	8 miscellaneous	9 no trouble	10 other trouble	11 in process	
0-499	11,237	2			/	/			/						0	/					26
500-999	3774	0																			14
1,000-1,499	4157	0																			7
1,500-1,999	6111	2	//						/	/					0						9
2,000-2,499	6261	1		/							0								/		11
2,500-2,999	5885	1	/									/									13
3,000-3,499	4743	1							/										/		10
3,500-3,999	3524	0																			7
4,000-4,499	4989	1	0				/														8
4,500-4,999	3606	0																			9
5,000-5,499	2706	0																			6
9,000-9,499	5358	2	/		/					0	/		/								10
9,500-9,999	5067	0																			9
10,000-10,499	5069	5	/		/	//	/		//	0	//	0		0	0	0					10
10,500-10,999	6071	3	//		/					//	0	//	0		0	0		/	/		10
11,000-11,499	5977	2			/			/	/	/					0						12
11,500-11,999	7147	3	/		//					0	//			0	0			/			15
12,000-12,499	9550	2			//				//	//	0	0		0	0						16
12,500-12,999	14,544	6	//		//			//	//	//	0	0		0	0	/					25
13,000-13,499	16,186	3	/	/				/		0	/				0		/				23
13,500-13,999	15,189	4	/		/	//			//	/			0		/	0					35
14,000-14,499	14,925	5	//		/	/			//	//	0				0	0					22
14,500-14,999	16,373	4	/		/	//			/	0	//	0		/	0	0					31
15,000-15,499	12,034	4	/		//		/		/	0	//	0			/						26
15,500-15,999	7530	2	/				/													//	18
16,000-16,499	3068	0																			8
16,500-16,999	2379	3	/		/		/		/							/		/			2
17,000-17,499	1610	2			/		/		/					0				/			6
17,500-17,999	745	0																			1
18,000-18,499	615	0																			1
18,500-18,999	855	1			/				/					0							2
19,000-19,499																					
19,500-19,999																					
total	236,212	63	15	7	4	21	5	11		21	18	1	2	4	3	4	5	5	5	450	
3-month removal rate		0.27																			

Δ = secondary trouble ○ = other trouble

204

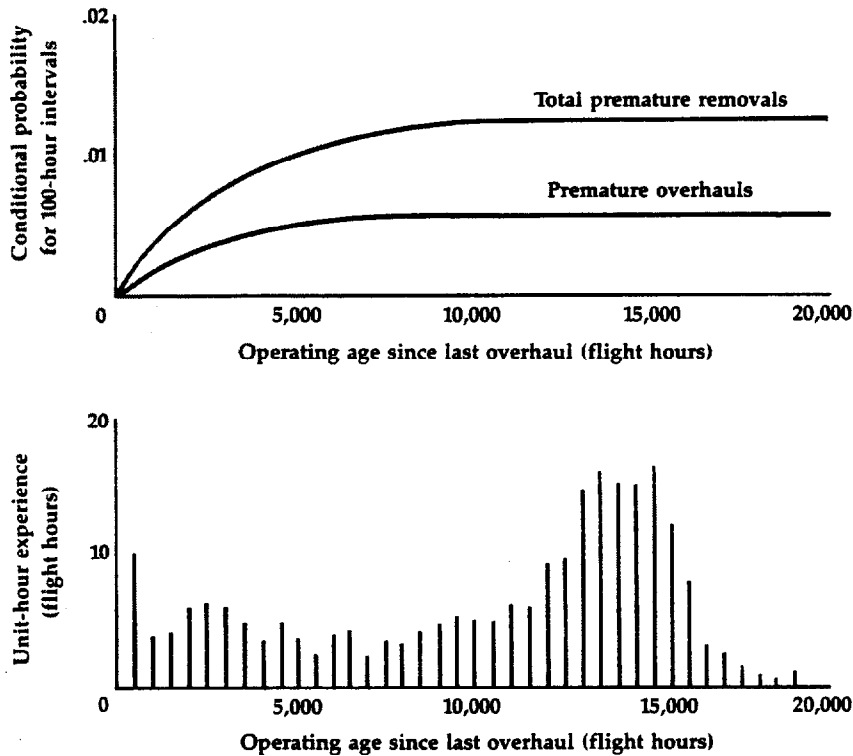

EXHIBIT 11-8 The results of actuarial analysis of the operating history shown in Exhibit 11.7. Of the total premature removals, some units were repaired and returned to service and others required sufficiently extensive work to zero-time their operating ages. (United Airlines)

At the time the curves in Exhibits 11.8 and 11.9 were developed this constant-speed drive was subject to an overhaul age limit, although it was being rapidly extended as a result of actuarial analysis and the findings from teardown inspections of time-expired units. Evidence of deterioration will usually be found in serviceable units that are removed at some specified age limit, but it is generally beyond human capability to estimate from this early evidence the rate at which the deterioration will progress. Consequently teardown inspections of time-expired units rarely provide the information in which we are most interested. The condition of parts in failed units, however, provides information on the general deterioration of these units, as well as on the specific failure modes to which they are subject. Moreover, since failed units are available for inspection at far more frequent intervals

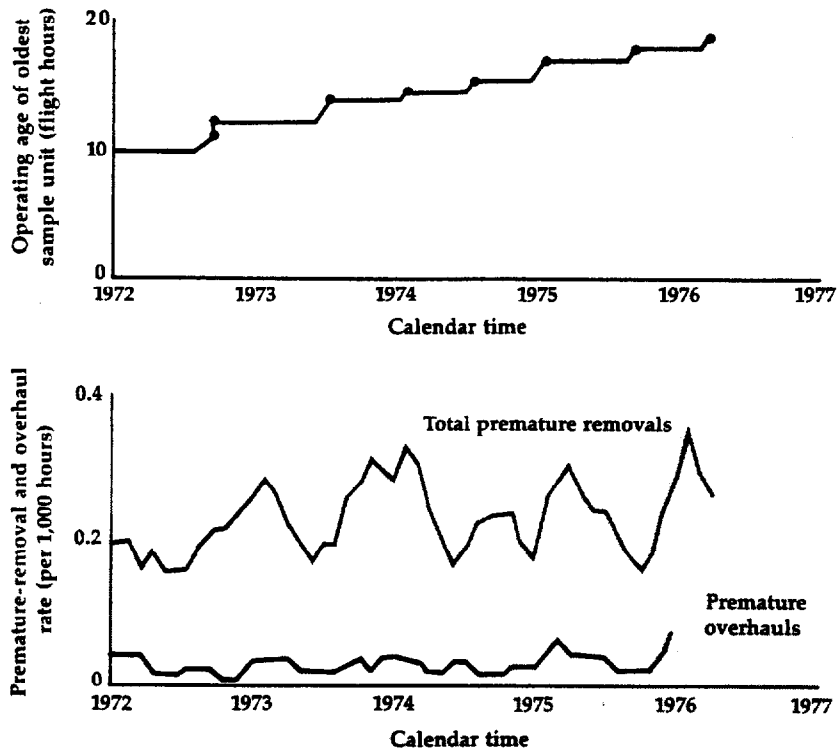

EXHIBIT 11-9 The results of actuarial analysis of operating experience over a five-year period for the constant-speed drive of the Boeing 727. (United Airlines)

than would be necessary (or feasible) for a rework age limit, this information accumulates continuously without the need to remove units from service at fixed intervals. Exhibit 11.10 shows how high-time inspection samples become available for age exploration with and without the imposition of a rework age limit.

Of course, the real criterion of applicability for scheduled rework is the existence of a well-defined wearout region in the conditional-probability curve. Thus unless enough failures have occurred to provide the necessary data for a conditional-probability curve, there is no basis on which a rework task can be scheduled—nor is there any basis for determining whether it would be cost-effective even if it proved to be applicable.

Whereas age exploration to support scheduled rework tasks relies on statistical analysis, the analyses directed at extension of the initial intervals in an RCM program are based on the results of the tasks themselves. Most of the tasks in an initial program are on-condition inspec-

tions, and when they are grouped into the various letter-check packages, it is with the expectation that the inspection findings on a small number of airplanes (time-extension samples) will support major extensions of these work-package intervals. During the period in which intervals are being extended, engineers and analysts participate in the inspections of the units designated as time-extension samples and make their own notes to supplement the information that will become available from other information systems.

11.3 MODIFYING THE MAINTENANCE PROGRAM

The nature of the items in the systems, powerplant, and structures divisions leads to different patterns in their maintenance requirements, and hence in the decision paths used to arrive at an initial set of scheduled tasks. For the same reason, age-exploration activities in each of the three major divisions tend to focus on different sources of reliability information. In some cases the study of individual items involves no specified age limits; in other cases it involves limits that are moved

age exploration of systems
 age exploration of powerplants
 age exploration of structures

EXHIBIT 11.10 The effect of an overhaul limit on age exploration. With a hard-time limit, units that fail shortly before they are due for scheduled removal are overhauled prematurely. This procedure zeroes times many units, thus reducing the number that survive to the end of the interval and can be used as inspection samples to support extension of the current limit. With no fixed removal limit, the economic reasons for premature overhaul no longer exist, and inspection of the oldest opportunity samples provided by failures results in samples at increasing ages instead of a number of samples all of the same age.

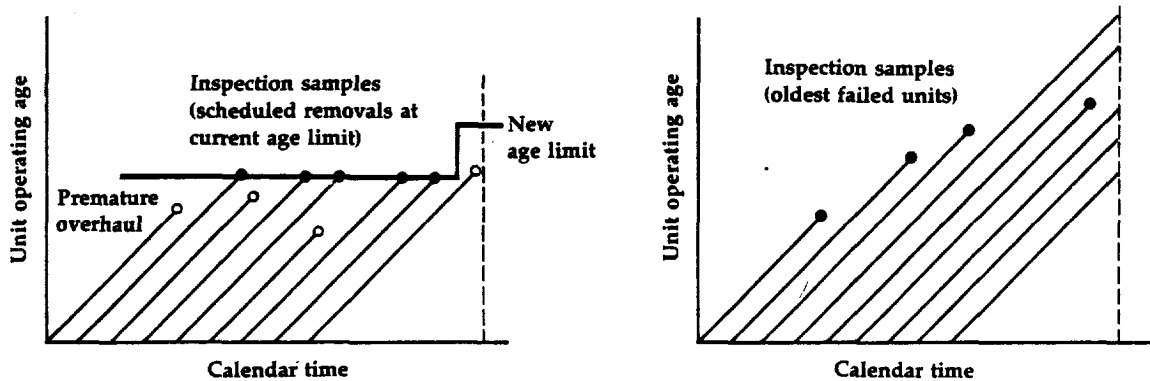

freely and rapidly on the basis of inspection findings. The essential factor in all cases is not the existence of an age limit, but knowing the age of each unit of the item examined.

AGE EXPLORATION OF SYSTEMS ITEMS

The systems division consists of a large number of readily replaceable complex items and their relatively simple fixed connecting lines. Usually an initial systems program includes few scheduled-maintenance tasks other than servicing and failure-finding inspections, and there are rarely defined age-exploration requirements, as in the powerplant and structure programs. The cost of corrective maintenance is fairly low for most systems items, and when operating data do indicate that additional preventive tasks are justified, it is generally because of an unexpectedly high failure rate that involves operational consequences. In some cases the failure rate may be high enough to warrant the replacement of certain components with more reliable ones.

One aspect of operational consequences not discussed thus far is passenger reaction to failures that would not otherwise affect the operating capability of the airplane. A case in point is the problem that developed with toilets on the Boeing 747. The airplane is equipped with eleven lavatories; hence the system is protected by redundancy. The toilet units are of the recirculating type, in which the flushing water is pumped through filters, deodorized, and eventually pumped back to the unit for reuse. One failure mode is a plugged line or flushing ring, so that the toilet can no longer be flushed. When this occurs the lavatory is closed, and the failure is recorded in the flight log for repair when the airplane reaches its destination. However, with one or more lavatories closed, a long line forms at the operable units, and passengers often find the wait uncomfortable. Moreover, one of the failure effects that was overlooked was the fact that the deodorizing action is ineffective on an inoperable toilet.

When passenger reaction indicated an extensive problem, especially during the summer, when each trip has more passengers and more trips are full, the failure was treated as one that had serious operational consequences. In this case an on-condition task was added to the program. A partially plugged line or ring is evidenced by incomplete flow from the ring. Thus it was possible to check the amount of the bowl wetted during the flushing operation and treat units with incompletely wetted bowls as potential failures (see Exhibit 11.11). This task was scheduled, of course, to coincide with inspections for other problems.

Since the reliability of systems items on the whole tends to be low, the principal age-exploration tool in the systems division is actuarial analysis of failure data. Ordinarily the conditional probability of failure for a complex item is not expected to vary much with operating age. However, a newly designed system will sometimes show a dominant

plane no.	Select 8000	skill	crew	zone	phase	job no.
ref.	C & S toilet flush ring	90	E	1204	40	20

-08-85

COA no. cost class no.

insp. accom. by

09 Clear flush-ring fluid outlet in bowl of residue and check flushing action.

Caution: Do not operate toilet flush pumps if waste tank is empty.

A With a long-handled brush and system flushing fluid, remove all residue from the flushing-ring fluid outlets in bowl of toilets listed:

2	W	1 Lav U1
2	W	2 Lav B
2	W	3 Lav C

B Check toilet flushing action of each toilet listed below, as follows:

1 Push flush button and allow completion of one full cycle; wait 30 seconds (minimum) before starting test cycle.

2 Push button for test cycle. The cycle should start immediately and continue for 12 plus or minus 3 seconds. There must be a vigorous flushing action in the bowl and the inside of the bowl shall be completely wetted. Make a writeup to correct inadequate flush action.

1	I	A Lav U1
1	I	B Lav B
1	I	C Lav C

EXHIBIT 11-11 The job instruction card for a task added to the Boeing 747 maintenance program to prevent operational consequences. (United Airlines)

failure mode that is both age-related and expensive enough to make an age-limit task desirable. Exhibit 11.12 shows a conditional-probability curve derived from operating experience with the engine-driven generator of the Boeing 727. There is little change in the failure rate until about 2,000 hours, when the bearing starts to fail; thereafter the conditional probability of failure increases with age as this failure mode becomes more dominant. The survival curve in Exhibit 11.12 shows the probability that a generator will not suffer a bearing failure.

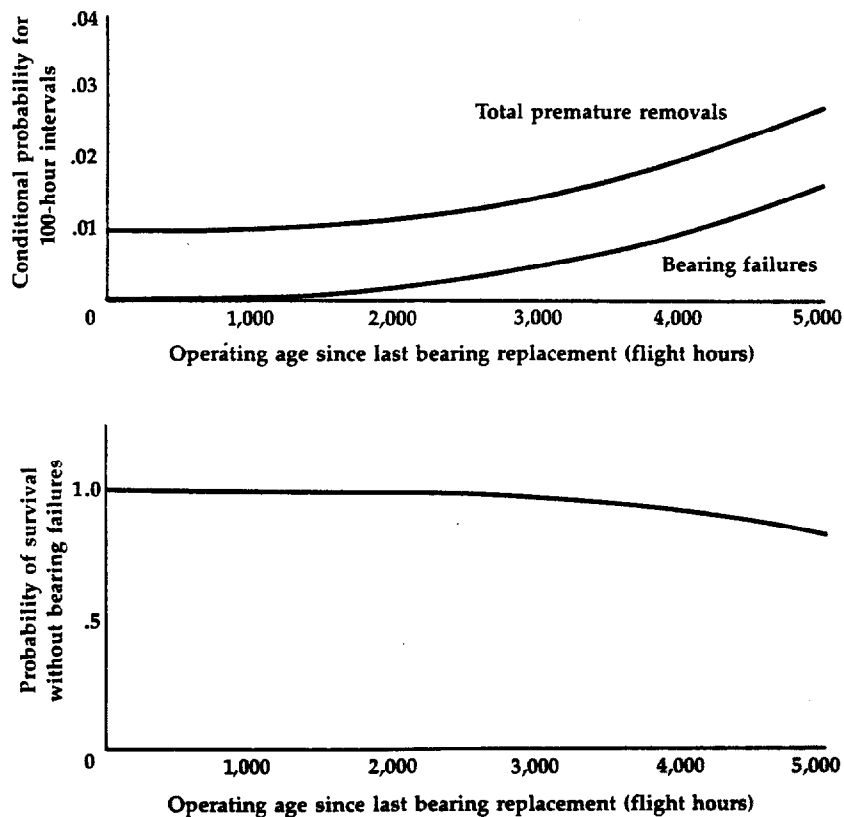

EXHIBIT 11-12 The results of actuarial analysis of operating experience with the engine-driven generator of the Boeing 727. The data represent a total of 1,310,269 unit hours from January 1, 1970 to January 31, 1971. (United Airlines)

Bearing failures cause such extensive damage to a generator that the entire generator must be scrapped and replaced with a new one, at a cost of about \$2,500. The bearing itself costs only \$50. In this case a cost analysis showed that it would be desirable to assign an economic-life discard task to the bearing at an interval of 4,000 hours. Such a task could also be viewed as a scheduled rework task for the generator, with the rework specification including discard and replacement of the bearing.

The generator and bus-tie relay on the Douglas DC-8 was assigned a scheduled rework task for a different reason. The relay is a complex mechanical item in the first type of aircraft to have three-phase 400-cycle ac power systems. Its basic functions are to convey the power from each

generator to its own load bus and to convey ground power to the individual load buses. A failure of either of these functions will be reported by the operating crew and will result in removal of the faulty relay for repair. The relay also has a number of secondary functions, some of which are hidden. However, the maintenance program for this aircraft predated the use of RCM techniques, and at that time no recognition was given to hidden functions.

When older units began coming into the shop for repair, many of the hidden functions were found to be in a failed state; in addition, many of the parts were so worn that the units could no longer be repaired. On this basis the relay was assigned a rework task—scheduled removal at a maximum age limit of 14,000 hours for shop disassembly to the extent necessary for repair. This task was intended primarily to protect the important hidden functions, but the saving in repairable units in this case more than offset the expense of scheduled removals.

Although unanticipated failures in the systems division rarely involve safety, some failures do have serious enough consequences to be treated as if they were critical. One such case was a failure of the landing-gear actuator endcap on the Douglas DC-10, discussed in Section 7.3. The endcap was designed to have a fatigue life longer than the expected service life of the airplane, and since corrosion was not expected to be a problem with this item, the only task assigned in the initial program was an on-condition inspection of the cap whenever the actuator was in the shop for repair. A check for internal hydraulic leaks had also been discussed, but it was considered unnecessary for this type of actuator. Unfortunately this actuator is not removed as part of the landing gear, and it has a very low failure rate. Consequently no opportunity inspections had been performed.

The endcap actually experienced two failures in the industry, each with different airlines. These failures originated in the exposed internal portion of the endcap, where an O-ring is used to seal in the hydraulic fluid. The original design and assembly techniques had allowed moisture to accumulate between the cap and body of the actuator on the air side of the O-ring, causing pitting corrosion. When the endcap separates from the actuator, all the hydraulic fluid is lost from the number 3 hydraulic system, and the landing gear cannot be retracted. If this failure occurred during flight, the gear in the failed position would rest on the doors, and when the pilot extended the landing gear, all three gears would simply free-fall to the down and locked position. However, if the gear doors were also to fail, the failed gear would free-fall through the opening, and in the extreme case at high speed, the door could separate and fall to the ground. This multiple failure would be considered critical.

While neither of the two endcap failures in themselves were classified as critical, the action taken was similar to that for an unanticipated

critical failure. First, a safe-life limit was established for the endcap and a modified part with greater fatigue life was designed. This modified cap is being installed at or before the existing caps reach the present life limit. Second, all actuators are being removed and sent to the shop for upgrading as fast as they can be handled. Each actuator is disassembled, the endcap is replaced with the new part, corrosion on other parts of the actuator is removed, and improved corrosion-protection materials are applied on reassembly. This procedure consists of applying fluid-resistant primer to the threads of both the endcap and the barrel, renewing the cadmium plating and painting, assembling the actuator with grease on all threads, and applying corrosion-inhibiting sealant on the last thread at all threaded joints. When all the shorter-life parts are removed from service and all the actuators have been assembled with this new procedure, it is expected that the problem will be resolved.

Failure data are also the basis for adjusting task intervals for hidden functions in systems items. Many of the failure-finding tasks are based on opportunity samples, tests or inspections of hidden functions on units sent to the shop for other repairs. The results of these inspections are recorded and analyzed to find the inspection interval that will provide the required level of availability at the lowest inspection cost. The units tested in the shop are considered to be a random sampling of the units in the operating fleet. Thus the percentage of failures found in the shop tests can be taken as the percentage of failures that would be found throughout the fleet. Failure-finding inspections of items installed on the airplane are performed at scheduled intervals. In this case the percentage of failures found will represent approximately twice the percentage expected in the entire fleet, because the inspection occurs at the end of the assigned interval, rather than at random times since the preceding inspection.

AGE EXPLORATION OF POWERPLANT ITEMS

Age exploration is an integral part of any initial powerplant program. A completely new type of engine, often incorporating new technology, is usually quite unreliable when it first enters service. During the first few years of operation premature-removal rates are commonly as high as 2 per 1,000 engine hours. This high removal rate makes it possible for the engine repair shop to obtain information not only on the parts involved in the failure, but on the condition of other parts of the engine as well.

Most new aircraft engines experience unanticipated failures, some of which are serious. The first occurrence of any serious engine failure immediately sets in motion the developmental cycle described in Section 5.2. The cause of the failure is identified, and an on-condition task is devised to control functional failures until the problem can be resolved

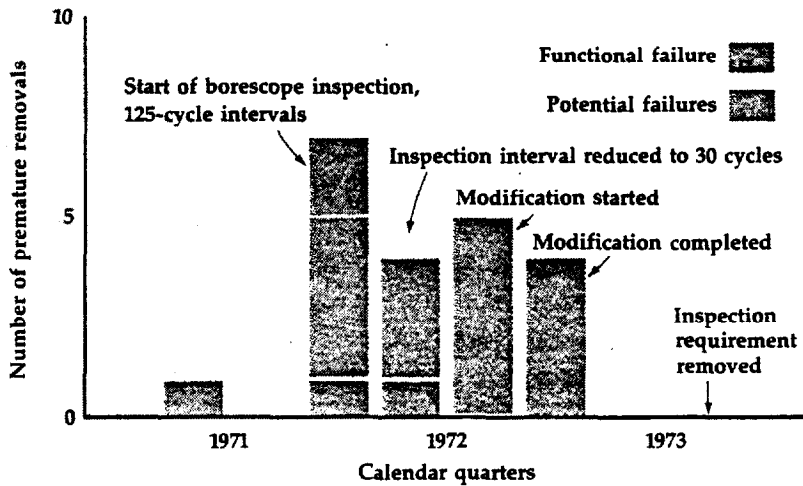

EXHIBIT 11-13 History of the C-sump problem in the General Electric CF6-6 engine on the Douglas DC-10. The on-condition task instituted to control this problem had to be reduced to 30-cycle intervals in order to prevent all functional failures. The precise cause of this failure was never pinpointed; however, both the inspection task and the redesigned part covered both possibilities. Once modification of all in-service engines was complete no further potential failures were found, and the inspection requirement was eventually eliminated.

at the design level. Modified parts are then incorporated in the operating fleet, and when continued inspections have shown that the modification is successful, the special task requirements are terminated.

The General Electric CF-6 engine on the Douglas DC-10 experienced several such unanticipated failures during early operation. The low-pressure turbine sections separated from the engine, and these separated rear sections fell off the airplane. Investigation determined that these failures were probably a result of oil fires in the engine case, caused by seepage due to a pressure imbalance in the oil scavenging system. However, there was also a possibility that there had been a structural failure of the C sump, which supports two of the bearings. Thus on-condition borescope inspections of the C sump were scheduled to search for either cracks in the C sump or oil on its external surface. The initial interval for this inspection was 125 flight cycles, but the interval was lowered to 30 cycles after another functional failure occurred (see Exhibit 11.13). Inspections were continued at this short interval until the engines were modified.

EXHIBIT 11-14 A portion of the opportunity-sampling program
for age exploration of the Pratt & Whitney JT8D-7 engine.
(United Airlines)

section and part name	inspection limit	inspection threshold
COLD SECTION		
No. 2 bearing assembly		
Engine Manual, 72-09-50	—	21,000-24,000
Intermediate case (Cadillac)		
Engine Manual, 72-34-1	—	19,500-21,000
Intermediate case (non-Cadillac)		
Engine Manual, 72-34-1	—	17,000-19,000
13th-stage bleed MFD		
Engine Manual, 72-72-0	—	16,000-18,000
Heavy maintenance, 72-72-0	Available	—
8th-stage bleed MFD		
Engine Manual, 72-72-0	—	14,000-16,000
Heavy maintenance, 72-72-0	Available	—
No. 4½ carbon seal, #728981-600 assemblies only		
Engine Manual, 72-09-13	—	9,500-12,500
Engine Manual, 72-09-10	—	
Engine Manual, 72-09-20	—	
Heavy maintenance, 72-53	Available	—
No. 4½ carbon seal, other part no. assemblies		
Engine Manual, 72-09-13	—	—
Engine Manual, 72-09-10	9,500	
Engine Manual, 72-09-20	—	
Heavy maintenance, 72-53	Available	—
No. 6 carbon seal		
Engine Manual, 72-09-13	—	—
Engine Manual, 72-09-10	8,600	
Engine Manual, 72-09-20	—	
Heavy maintenance, 72-53	Available	—
Accessory bearings, front accessory drive		
Engine Manual, 72-09-50	—	9,000-12,000
Accessory bearings, gearbox- drive towershaft		
Engine Manual, 72-09-50	—	8,500-11,500

Over the course of six or seven years, as failure information is used to improve the engine, the total premature-removal rate (for both potential and functional failures) usually drops to 0.3 or less per 1,000 engine hours. There are many noncritical parts in the engine which are quite reliable, however, and which may not fail at all until much higher operating ages. The question is whether a rework or discard age limit will prevent these failures from occurring. Until some unsatisfactory condition appears, there is no information from which to determine an age-reliability relationship. In this case all we can do is inspect unfailed parts at successive ages until some signs of deterioration appear. While such inspections do not always have on-condition capability, they are the only source of information on parts that are performing satisfactorily.

As opportunity samples provide documented information on parts at increasingly higher ages, the maintenance organization gradually compiles a list of significant parts, their failure modes if they have failed, and the age at which full inspection should be started for each item. This list identifies the part, refers to the section of the maintenance manual in which the task itself is defined, and states the threshold age limits at which the task is to be performed. The schedule shown in Exhibit 11.14 uses two threshold limits for each engine item. Any part that falls within these age limits is treated as an opportunity sample if it becomes available for inspection while an engine is being disassembled for repair. If any engine has a part that has aged beyond the upper limit, that part must be inspected even if further disassembly is required for this purpose alone. In either case, the inspection sample is measured against appropriate standards, and its condition is documented on a special sampling form.

The sampling requirements usually specify that the threshold limits for each item may be increased after two inspection samples have been examined and found to be in satisfactory condition, although engineers will often want to inspect far more than two samples before authorizing extension of the limits. To ensure that most of the samples will be opportunity samples, the two threshold limits are set as much as 3,000 hours apart while the inspection intervals are still being extended. Consequently, when a maximum interval is identified, this "opportunity band" will already have removed a great many units before they reached the upper limit, leaving very few age-limited units in the fleet. This type of age-exploration program has been quite successful in extending limits without the need for engine removals solely to inspect parts.

If the item is one that has experienced functional failures, and an actuarial analysis has established that a rework or discard task will improve its reliability, the task is added to the program and the item is removed from the sampling schedule. In the event of a serious unan-

anticipated failure of a high-time part, the age status of that item will be reviewed in the entire fleet, and the engines with high-time parts will be inspected on the wing if this is possible; otherwise such engines will be removed and sent to the shop for disassembly.

As a result of the continual process of repair and replacement of failed parts and the incorporation of design modifications, the parts of any engine that has been in service for some time will be of widely disparate ages. The overall age identified with an engine is the age of its nameplate. The nameplate is useful in referring to individual engines, but any engine in an operating fleet may consist of parts older or younger than its nameplate. For this reason it is necessary to keep track not just of the age of each engine, but of the ages of all the parts from which it is assembled.

AGE EXPLORATION OF STRUCTURAL ITEMS

Whereas systems and powerplant items are designed to be interchangeable, there is no simple way of replacing most structural elements. Repairs and even detailed inspection of internal parts of the structure involve taking the entire airplane out of service, sometimes for an extended period. For this reason structural items are designed to survive to much higher ages than systems or powerplant components. Nevertheless, initial intervals in the structural inspection plan are only

EXHIBIT 11-15 A record of structural-inspection findings and corrective maintenance as reported during a number 2 A check. Omitted details include labor time, signoffs by the mechanic and the inspector, and reference file numbers. (United Airlines)

plane no.	TSO		station	type of check					source			sub no.	
	hours	min		other	#15V	#25V	A	B	C	log	def		mech
3026	2866	46	ORD				2					✓	2100
work area			job type		system code								
T L H O A E O S							(details omitted)						
x			x										
<p>REPLACE AFT LONG RT FLOOR PANEL IN LOWER GALLEY ACCT. SOFT</p> <p style="text-align: center;">Replaced panel</p>													
											defined checkoff		
											date and time	by	
											4-21	/0100	
(details omitted)													

a fraction of this design life goal, both because of the consequences of a structural failure and because of the factors that can affect the design fatigue life in individual airplanes. These include variations in the manufacturing process, overloads encountered by individual airplanes, loading spectra that differ from the standards employed by the designer, environmental conditions causing corrosion, and accidental damage from foreign objects.

In the structure division the inspection program itself is the vehicle for age exploration. Thus the initial intervals are intended not only to find and correct any deterioration that may have occurred, but also to identify the age at which deterioration first becomes evident for each structural item. Exhibit 11.15 shows the form in which the findings of an A-check task are recorded, along with a record of any corrective action taken. The inspection findings and work performed at line stations are usually monitored by engineers, who log all the relevant findings on those airplanes designated as inspection samples in the form shown in Exhibit 11.16. With this information there is a good basis in the ongoing program for revising the age at which inspections of structurally significant items should begin in later-delivery airplanes.

In general the interval to the first inspection in the initial program is the same as the interval for repeat inspections, and successive inspections are performed on each airplane as it ages to identify the age at which deterioration first becomes evident. This procedure provides adequate information if the interval is short in relation to the fatigue-life design goal. Inspection of an item at intervals of 5,000 hours, for example, will result in documentation of its condition at total ages of 5,000 hours, 10,000 hours, 15,000 hours, and so on. However, if an item is assigned an initial interval of 20,000 hours, subsequent inspections at total ages of 40,000 and 60,000 hours would leave great gaps in the flow of age-condition information. It is therefore necessary to schedule inspections of several airplanes at intermediate ages to ensure that the age at which any deterioration begins can be identified within a close enough range for the information to be useful. The items that are assigned such long intervals, of course, are those which not only have very little effect on residual strength, but also have a very low susceptibility to corrosion and other damage.

Because it takes several years for a fleet of airplanes to build up, it is always hoped that the conservative start-of-inspection intervals in the initial program will apply only to the first few airplanes to reach these ages, and that inspection findings will support an increase in the ages at which the first inspections are performed on subsequent airplanes entering the fleet. This increase is usually accomplished by "forgiving" the first few inspections in the sequence, rather than by changing the interval. The information obtained from the inspections

ON-AIRCRAFT INSPECTION FINDINGS

- 1 On 9/2/71 at 285 hours
Indications of material flowing out of center waste pump in aft waste tank
103 rivets popped or loose, RH side of aft pylon fin; 96 rivets loose, LH side of aft pylon fin
- 2 On 9/28/71 at 571 hours
No significant defects recorded
- 3 On 11/3/71 at 881 hours
No significant defects recorded
- 4 On 12/12/71 at 1,166 hours
No significant defects recorded
- 5 On 1/24/72 at 1,475 hours
A couple of writeups that could indicate a chronic condition. Numerous loose rivets on left & right wing tips; also loose rivets on no. 2 engine top aft fairing.
- 6 On 3/21/72 at 1,835 hours
Repair fuselage damage under captain's window, left side of fuselage; scrape 4 ft long. Removed rivets, bumped out skin to contour, installed 2024T3 tapered shims between skin & frame, reinstalled rivets. To be inspected, sta 330 frame, in approx. 3,000 hr.
Lower LH leading-edge skin cracked. Installed patches, replaced door.
Leading-edge doors found loose even though they had previously been taped; one door had broken through tape, was hanging down approx. 3/4 in.
Aft, center, & fwd cargo door hinges rusted. Cleaned and sprayed with oil.

EXHIBIT 11-16 An example of the inspections findings recorded for a designated inspection sample of the Douglas DC-10 airplane. (United Airlines)

is supplemented by data from the manufacturer's continuing fatigue tests, as well as by inspection information from other operating organizations. Once the first evidence of deterioration does appear, this new information may indicate that adjustment of the repeat interval itself would be desirable. When early deterioration appears in a structural item, low start-of-inspection and repeat intervals must be defined and maintained until design changes have been incorporated that avoid the need for such early and frequent inspections.

- Evidence of working rivets above LH overwing entry door at splices, sta 1256 & 1305 and longeron 15. No action taken.
- 7 On 5/8/72 at 2,186 hours
80 rivets loose & popped at vert. stabilizer fin above aft engine hot section. Replaced rivets.
No. 6 axle sleeve has migrated and rotated. Shop repaired.
Bracket cracked on no. 1 pylon cap area. Replaced bracket.
Right inboard spoiler upper skin cracked. Replaced spoiler.
Typical and chronic loose leading-edge plates, popped rivets on wing-tip structure. . . .
- 8 On 6/16/72 at 2,533 hours
Possible corrosion source: drain in service center leaks to FFR. Blew out all drain lines, unable to find trace of leak.
Chronic—right & left wing leading-edge plates cracked, latches loose, etc.
Firewall cracked, no. 2 engine, PT7 bulkhead fitting loose and bolt missing just aft of aft engine mount. Stop-drilled cracks, installed doubler under bulkhead fitting.
- 9 On 8/7/72 at 2,968 hours
Rib flanges cracked and rivets sheared at fwd end of tail fin above aft end of no. 2 engine. 2d, 3d, 4th, & 5th from top on left side and 5th, 6th, & 7th on right side, interior. OK to continue to special route for COA.
Lower leading-edge plate cracked, loose, etc. (typical).
Lower leading-edge skin area just fwd of center accessory compartment has water. Sucked out water (recorded as possible corrosion source).
LH no. 2 lead-edge slat retract cable frayed beyond limits (center track at wing leading edge). Replaced cable. Caused by contact. . . .

In short, the initial structural inspection program defines the starting points for an age-exploration program that will continue throughout the operating life of the airplane. At first all significant items are inspected on all airplanes, and as information is obtained, the starting intervals assigned in the prior-to-service program are lengthened, if possible, to reduce the inspection workload on the later-delivery airplanes. The major structural inspections, or D checks, usually entail inspection of all significant items and most nonsignificant ones, and

this may be the only work package that requires inspection of class 4 significant items.

The first D checks are performed on the highest total-time airplanes of the fleet—the fleet leaders, which are the first airplanes to reach the end of the starting interval. While the starting interval for this work package is being extended, the number of major structural inspections in any one fleet is relatively small. Once a maximum limit is reached, however, the volume of major inspections increases markedly as individual airplanes age to this fixed limit. At this point it becomes necessary to examine possibilities for reducing maintenance costs which do not involve interval extension. It is common in the airline industry to divide the ongoing inspection program into two parts—a *100 percent program*, which consists of those tasks to be performed on every airplane, and a *sampling program*, consisting of tasks to be performed only on a specified portion of the fleet.

The two parts of the ongoing inspection program take into account the wide range in the importance of individual structurally significant items which is exemplified by the rating process. Class 1 and class 2 items are identified by a joint consideration of the effect of their failure on residual strength and their susceptibility to deterioration. If either of these factors is large, that item must remain in the 100 percent program to minimize the likelihood of a functional failure. The 100 percent program thus ensures the integrity of those structural elements which are essential to the safety of the airplane.

The concept of damage-tolerant design depends on the existence of this 100 percent inspection plan to reveal any failed structural member before the failure of a second member can cause an unacceptable reduction in residual strength. In practice the inspection intervals for such elements are intended to detect cracks and corrosion at a sufficiently early stage to prevent the first member from failing. This early detection of damage also lowers the cost of repairs; however, we do not differentiate between structural integrity and economic considerations in the 100 percent program.

In contrast, the failure of a class 3 or class 4 item, by definition, has only a small effect on residual strength, and such items also have little susceptibility to deterioration. Consequently we can permit economic considerations to play a large role in their scheduled-maintenance requirements. Detection of deterioration in its early stages will reduce the cost of repairs, but this saving must be balanced against the cost of the inspections necessary to find the first evidence of deterioration in every airplane. A sampling plan is therefore used to determine the age characteristics of the fleet, with full knowledge that individual uninspected airplanes may require expensive repairs by the time the sample inspections identify a problem area. Since the issue in this case is not structural integrity, but the relative cost of repairs, the risk of occasional

high repair costs is acceptable if the result is a marked reduction in inspection costs. This exposure would not be acceptable, of course, for class 1 and class 2 items, where a failure would have a marked effect on residual strength.

A relatively small number of sample inspections may be adequate for economic purposes. For example, suppose an item has a relatively short average fatigue life of 60,000 hours. In a sample of 10 airplanes all of the same total age, the probability of discovering this defect by 50,000 hours is .63, and the same defect would be expected to appear at this age in 10 percent of the uninspected airplanes.* In practice, however, the sample inspections are performed on highest-age airplanes, and when the defect is discovered, its incidence in the lower-age airplanes in the rest of the fleet will be much less than 10 percent. In bygone years, when a large number of airplanes were to be inspected at a fixed major-inspection interval it was common practice to inspect items of relatively low significance on a fraction of the fleet—say, every fifth airplane—and this practice was referred to as *fractional sampling*.

Once the sampling inspections have identified the age at which an item begins to show signs of deterioration, some action must be taken. This may be an increase in the number of aircraft sampled, perhaps to 100 percent, or it may be treatment or modification of the affected area to forestall deterioration in other airplanes. For example, doublers may be installed on all airplanes, or protective coatings may be applied to prevent corrosion. As the fleet ages, more and more of the sampling inspections will revert to 100 percent inspections unless such basic preventive measures are taken.

As the operating fleet of a specific type of airplane ages in service, from time to time it is necessary to conduct a thorough review of the structural maintenance program in light of the information obtained from operating experience and later manufacturer's tests. In 1976 Douglas Aircraft conducted such a review for the DC-8, and special inspections for 27 items were added to the program for airplanes with ages greater than 50,000 hours. Similar reviews of its structural designs are being conducted by Boeing. The British Civil Aviation Authority now requires a Structural Integrity Audit and Inspection Document:†

5 *Structural Integrity Audit and Inspection Document*

5.1 *The Constructor's Role* For each aeroplane type to which this Notice is applicable the necessary work is that the constructor should carry out a 'structural integrity audit' in which each

*M. E. Stone and H. F. Heap, Developing the DC-10 Structural Inspection Program, Seventh Annual FAA International Maintenance Symposium, Oklahoma City, Okla., December 7-9, 1971.

†Continuing Structural Integrity of Transport Aeroplanes, Civil Aviation Authority, Airworthiness Notice 89, August 23, 1978.

area of the structure for which fail-safe characteristics are critical is considered, and the acceptable extent, rate of growth, and detectability of damage is assessed, together with the probability of damage being present in associated areas. Based on this Audit, an Inspection Document should be drawn up and made available to operators.

- 5.1.1 The Inspection Document should include:
 - (a) A statement of (or reference to) all the inspections (and replacements, repairs or modifications) considered by the constructor to be necessary to ensure that a safe level of structural strength will be maintained.
 - (b) For each location, the thresholds (time/flights, to first inspection) frequencies and type and method of inspections required and the extent of damage which it is aimed to be able to find.
 - (c) Reference to the types of operations for which it is considered valid. *Note:* Its validity may, of course, be varied by reissue from time to time.
- 5.1.2 The Inspection Document would have to be prepared on the basis of a Structural Integrity Audit (or other process providing similar results) generally acceptable to the Authority, but would not require approval in detail. Guidance on the method of carrying out a Structural Integrity Audit and as to what should be included in the Inspection Document is given in CAA Information Leaflet, Continuing Integrity of Transport Aeroplanes.

While the manufacturer is formally responsible for conducting these structural reviews, their value depends on adequate information from operating organizations.

Quite apart from problems associated with higher ages, there is always the possibility of an unanticipated failure of a structural item at more modest ages, just as there is for systems and powerplant items. One such example was the cracking of the Boeing 747 floor beams as a result of cyclic loading from cabin pressurization. This problem was first discovered when increased floor flexibility and loose seats were reported in an airplane that had accumulated approximately 8,400 pressurization cycles. The discovery led to a Boeing service bulletin, followed within a week by a U.S. Department of Transportation airworthiness directive, detailing an on-condition inspection program for the floor beams and specifying a modification of the structure to eliminate the problem.* The airworthiness directive required that all

*Boeing Service Bulletin 747-53-2176, February 10, 1978, and U.S. Department of Transportation Airworthiness Directive 78-04-04, February 16, 1978.

airplanes with more than 6,000 landings be inspected within the next 100 landings and that the inspections be repeated within the next 1,200 landings if no cracks were found. If not more than one beam was found to be cracked, and if the crack in the beam web was less than 3 inches long, the crack would be stop-drilled and inspected for evidence of further progression within the next 50 landings, subject to the provision that the crack be permanently repaired within 1,200 landings. If a crack more than 3 inches long was found, repair was required before further flight.

Note that this directive embodies the concept of a long initial interval followed by short repeat intervals. In this case both of the intervals are firmly established by information derived from actual operating experience. The continuing age exploration of damage-tolerant structure will lead to the same results. Once the age at which fatigue damage becomes evident has been identified for each item, there will either be short inspection intervals starting at this age or else a design modification that extends the fatigue life of the item and makes the inspection task unnecessary.

The decision to modify an airplane structure depends on its remaining technologically useful life. When the airplane is likely to be outdated soon by new designs, it is usually difficult to justify structural modifications on economic grounds, and it may be necessary to perform frequent inspections of items that have been identified as approaching their fatigue lives. In this case there is an increasing likelihood that the detection of a fatigue crack will also take the airplane out of service for repair, and if the cost of repair cannot be justified, it may be necessary to retire the airplane. Whenever an active modification policy is not followed, the frequency of repair and the number of out-of-service incidents will be a direct function of the increasing age of the airplane.

It is frequently considered axiomatic that all structural inspections must be intensified when an airplane reaches higher ages. However, this has not necessarily been the experience with transport aircraft because of the policy of modifying items as soon as they are identified as nearing their fatigue lives. Consequently in decisions concerning fleet retirement the cost of maintaining structural integrity has been secondary to such factors as fuel consumption, speed, passenger acceptance, and payload/range capability.

When a safe-life structural item reaches its defined life limit there is usually no alternative to replacing it with a new one. Thus an airplane designed to safe-life structural criteria must have greater economic viability than one designed as damage-tolerant structure in order to justify the more expensive procedures that are required for continued operation.

11-4 INTERVALS: AN INFORMATION PROBLEM

the role of age exploration
the dynamics of
product improvement

The difficulty of establishing "correct" intervals for maintenance tasks is essentially an information problem, and one that continues throughout the operating life of the equipment. With the techniques of RCM analysis it is fairly simple to decide what tasks to include in a scheduled-maintenance program, but the decision logic does not cover the intervals at which these tasks are to be performed. Since rework and economic-life tasks are developed on the basis of age exploration, the intervals for these tasks cannot be determined until operating information becomes available. Safe-life intervals, which are based on the manufacturer's test data, are set prior to service with the expectation that operating information will never become available. The most effective preventive tool in a maintenance program, however, is on-condition inspections, and in this case there is just not enough information to set fixed intervals, even after airplanes are in service and age exploration is under way.

At the time an initial program is developed the available information is usually limited to prior experience with similar items, familiarity with the manufacturer's design practices, and the results of the developmental and fatigue tests for the new airplane. With this information it is possible to arrive at a rough estimate of the ages at which signs of deterioration can be expected to appear. However, the initial intervals are then set at only a fraction of these ages. Indeed, the fraction may be a very small one, to force intensive age exploration, if the manufacturer is relatively inexperienced, if the design contains new materials or processes, or if the airplane is to be operated in an unfamiliar environment. While there is some economic penalty in the use of such short intervals, the overall impact is small because the intent is to increase the intervals on the basis of actual operating data as the new fleet grows in size.

The basic concept underlying on-condition inspections is that the interval to the first inspection should be long enough for some physical evidence of deterioration to be seen, and the interval for repeat inspections should be short enough to ensure that any unit that has reached the potential-failure stage will be removed from service before a functional failure can occur. In theory, then, it seems that the problem should merely be one of using age exploration to determine the appropriate intervals for first inspection and repeat inspections of each item, and that once this is done the intervals can be fixed. However, matters are not quite that simple.

In most cases, particularly if the remaining service life of the airplane is high, once the potential-failure ages of significant items have

been identified, they will be judged undesirably low. Items will therefore be modified to increase their longevity, and there must be another age-exploration cycle to determine the intervals appropriate to the improved item. Consequently any set of initial and repeat intervals may apply only from the time the original information becomes available until the time the modified item goes into service. While the dynamics of this process add to the age-exploration requirements, they also reduce the growth in the maintenance workload associated with short repeat intervals for more items as the airplane grows older.

11.5 RESOLVING DIFFERENCES OF OPINION

It is inevitable that there will be differences of opinion concerning the interpretation of operating information and the revisions that should be made to the scheduled-maintenance program. In most cases these differences can be resolved by reference to the principles underlying the development of an RCM program.

benefits of a rework task
the need for a safe-life limit

One common situation is that of an item initially assigned to no scheduled maintenance which has experienced a high in-service failure rate. Although the failure is one that has no safety consequences, the engineer may assume that all mechanical items have a wearout age and that the high failure rate is in itself evidence of wearout. On this basis he might propose that the item be assigned a scheduled rework task to improve its reliability. The data required for an actuarial analysis are available in this case, since the failure rate is high; hence we can gain a fair picture of the item's age-reliability characteristics. If the conditional-probability curve does show an increase with age, then the failure rate that would result from the imposition of any given age limit can be computed as described in Chapter 3.

So far there is no difference of opinion. However, scheduled removals will certainly increase the shop workload. The cost of the increased workload must therefore be compared with the saving that would result from a reduction in the failure rate. If these added costs outweigh the benefits, the task may be applicable, but it is not cost-effective. Even when the proposed task appears to be cost-effective, there may be other difficulties. Very often the items that show high failure rates in service were not expected to do so. Thus the spare-unit inventory is already inadequate as a result of these unexpected failures, and the same is true of the parts and tools needed for repairs. Consequently a rework task, although economically desirable on other grounds, may be impractical, since adding scheduled removals to the current workload would increase an already serious logistics problem.*

*For a further discussion of this point see Section C.5 in Appendix C.

There is usually no difficulty in reaching an agreement if it turns out that it is not practical to implement a scheduled rework task. Suppose, however, that the conditional-probability curve shows that a rework task is not applicable to the item in question. In this case the difference of opinion may be more difficult to resolve. The engineer may want to know why the actuarial curves do not support his intuitive belief that a high failure rate is synonymous with wearout, and an analyst working with statistical data is often not equipped to explain why a particular item does not show wearout characteristics. The situation may be further complicated when teardown inspections show the surviving units to be in poor physical condition. There have been many instances in which highly qualified inspection teams have judged the parts of time-expired samples to be in such poor condition that they could not have survived to a proposed higher age limit. Nevertheless, when these items were allowed to continue in service with no age limit, subsequent analysis of their operating histories showed no actual increase in their failure rates. Under these circumstances the discrepancy is between two sets of physical facts, and while the difference of opinion may not be resolved, an understanding of the principles discussed in Chapters 2 and 3 will at least provide the basis for arriving at a decision.

Occasionally the problem is one that requires reference to the decision logic itself. The following situation is more complex, and fortunately far less common. The initial maintenance program for the Douglas DC-8 called for lubrication of the flight-control elevator bearings at every D check. At this time half the bearings were to be removed and inspected; those in good condition were then reinstalled and the others were scrapped. This task specification had remained in the program without change for many years. During that time there had been major extensions of the D-check interval, and the interval for newer planes entering the fleet had reached 17,000 hours. When these later planes aged to the D-check interval, however, the inspections showed that many of the bearings were badly corroded. The inner race was difficult or impossible to turn by hand, and when it could be turned, some of the bearings felt rough. Obviously the interval between lubrications had become too long, and it was reduced accordingly to the C-check interval. But the problem was what to do about the high-time bearings in the rest of the operating fleet. One group insisted that the situation was critical and that all high-time bearings would have to be removed from service immediately; this was tantamount to imposing a safe-life limit on the bearings. Another group felt that such drastic action was not warranted.

For a clearer picture of the problem let us consider the bearing itself as a significant item. This item is a roller bearing housed in a fitting attached to the stabilizer. A hinge bolt on the elevator passes through

the bearing to form a control-surface hinge. The function of the bearing is to reduce friction and wear (and consequent free play) in the rotating joint. Only two types of failure are important: wear or mechanical damage, resulting in looseness or free play in the bearing, and unacceptable operating friction, leading to seizure of the inner and outer bearing races. This latter failure mode is the one of concern.

The designer's description of the control system for this aircraft states in part:*

Flight control surface hinges and pilot control system rotating joints were designed to be tolerant of inevitable deterioration and/or possible failure of bearings. Possible seizure of a bearing's inner and outer races is compensated for by assuring that the bearing's function is transferred to the rotating joint's pin or shaft. Friction in the joint would increase considerably in this event, but would not prevent relative motion between components. Control surface moments about the hinge line are so great that bearing seizure cannot impede surface travel. Control surface hinges and other rotating joints that would be adversely affected by bearing free play are redundant such that deterioration or failure of the bearing in this mode will not create intolerable levels of looseness or structural loading of the connection and will not, therefore, affect the airworthiness of the airplane.

If we apply the decision logic to these characteristics, we see immediately that a loss of function in this bearing will not be evident to the operating crew. When flight tests were conducted on equipment with high-time bearings, the handling characteristics of the airplane were normal even though subsequent inspections showed that the bearings were seriously deteriorated. However, while a bearing failure has no direct effect on safety, its function is hidden. Therefore a scheduled task for the bearing is required to avoid the risk of a multiple failure. The first possibility in the hidden-function sequence is an on-condition task, and we find that there is already such a task in the program. Combined with more frequent lubrication, the scheduled inspection of the bearings for wear should ensure adequate availability (although the interval for this task might require adjustment as well).

The conclusion in this case was that the situation was not critical and there was no need to impose a safe-life limit on the bearing. However, those airplanes with high-time bearings that might already have been affected by inadequate lubrication were scheduled for bearing inspection prior to 20,000 hours as a failure-finding task.

*R. N. Frankel, Douglas Aircraft Company, letter to R. M. Casterline, United Airlines, September 25, 1974.

11·6 PURGING THE PROGRAM

conducting the review
typical findings

One of the most important activities in the management of an ongoing maintenance program is periodic purging of the entire program, an organized review of *all* scheduled tasks to identify those that are no longer worth continuing. Often the conditions that originally supported the inclusion of a specific task will have changed, and the task can now be deleted from the program. Moreover, in a maintenance organization concerned with complex equipment many different groups will be responsible for adding tasks to the program, and the additions are often made without enough attention to the totality of scheduled tasks. For this reason it is necessary to conduct a formal review every three to five years to purge the program of all tasks that have become superfluous. The results can be impressive. In such a review of the Boeing 747 program after the airplane had been in service for six years, so many tasks were eliminated from the phase-check package (a combination of B and C checks) that the manhours required to accomplish the scheduled work in this package were reduced by 21 percent.

The review should be conducted by a special team, with representatives from each of the organizational groups concerned with the maintenance program. The people selected must be knowledgeable and objective and fully prepared to challenge the continued requirement for any scheduled task. Once the group has been assembled, it will ordinarily be responsible for developing review standards and procedures, collecting and summarizing data, and assembling review packages consisting of task job cards, a sample of typical inspection findings, and a list of the review procedures. The review packages are then processed through the various departments involved, including production (maintenance shops), production planning, reliability analysis, and engineering, after which they are returned to the review team for resolution of any disagreements. The review team then obtains approval for the changes and repackages the tasks for implementation.

Certain findings are typical in such a review:

- ▶ Scheduled tasks that do not meet the criteria for applicability and effectiveness; these can be deleted from the program.
- ▶ Tasks that originally met these criteria but are no longer effective because of subsequent modifications to the equipment; these can be deleted from the program.
- ▶ The absence of tasks that do meet the criteria; these can be added.
- ▶ Tasks that are duplicated; the duplication can be eliminated.

- ▶ Task intervals that are either too long or too short; these intervals can be adjusted.
- ▶ Job cards that either do not clearly define the requirements of the task and the procedures to be followed or do not reflect the intent of the engineering department; these can be revised.

The final result of the review will be a more effective program, as well as a less costly one.

the role of scheduled maintenance

THIS CHAPTER is a reprise. It brings together the concepts discussed in preceding chapters to expand in several areas on the role of scheduled maintenance. One of these areas is the relationship of safety, reliability, and scheduled maintenance as it pertains to the modern air-transport industry. In particular, we will examine the current safety level of transport airplanes, the manner in which this basic safety level is affected by various types of functional failures, and the proposed requirement that the likelihood of certain failures not exceed one in a billion flights. We will also consider the design-maintenance partnership and the type of relationship necessary both to realize the inherent safety and reliability of the equipment and to identify the specific design modifications that will improve it.

In the preceding chapters we have discussed the development and evolution of RCM programs for new equipment. Because operating data are already available for in-service fleets, it is a simple matter to extend RCM analysis to the many types of airplanes that are currently being supported by maintenance programs developed along other lines. However, the same principles extend to any complex equipment that requires a maintenance support program. Although older designs may have more limited capability for on-condition inspections to protect functional reliability, RCM analysis will pinpoint their specific maintenance requirements, and thus permit the elimination of costly tasks which are not applicable and effective.

12·1 SAFETY, RELIABILITY, AND SCHEDULED MAINTENANCE

As we have seen throughout this volume, the failure process is a phenomenon that cannot be avoided by any form of preventive maintenance. However, by focusing on this process in each item whose function is essential to the aircraft, RCM programs ensure that the maximum capabilities of preventive maintenance are used to prevent those functional failures which impair safety or operating capability. The nature and extent of the impairment—the consequences of a particular failure—as well as the feasibility of protecting against it, depend on the design of the equipment itself. It is possible to design equipment in such a way that individual failures do not affect operating safety, or else with specific provisions for controlling such failures by scheduled maintenance. These design characteristics determine the inherent safety level of the equipment.

There is no really satisfactory analytic determination of the inherent safety level associated with current airworthiness requirements for transport airplanes. There have been instances in which modern swept-wing jet aircraft have not had the structural or performance capability to survive the conditions they encountered even when their structures were intact and all engines were functioning normally. The number of these accidents is too small to provide meaningful statistics, but in

the effect of systems failures
the effect of
powerplant failures
the effect of
structural failures

rough terms we might say the safety level of modern transport aircraft whose capabilities have not been reduced by any functional failures is somewhere on the order of 10^{-7} , or 1 accident per 10 million flights. Let us therefore examine the way in which safety levels are reduced by functional failures and the role of scheduled maintenance in preventing this reduction.

SYSTEMS FAILURES

A complete loss of certain system functions would have critical consequences for the aircraft; for example, a loss of all electrical power in weather that requires instrument procedures would clearly jeopardize the equipment and its occupants. Other system functions, such as pressurization and air conditioning, are more forgiving; pilots can compensate for the loss by changing the conduct of the flight and, if necessary, by making an unscheduled landing. In this case the loss of function affects operational capability, but it is not critical. There are many other functions whose loss has only minor operational consequences or none at all. However, the designer of an aircraft system can always ensure that the complete loss of a particular function will be extremely unlikely simply by replicating the items that provide that function.

The availability of a system function is usually a go/no-go situation; either the function is available to the airplane or it is not. When the source of a function is duplicated the probability of its becoming unavailable during a given flight is very small. If a failure of one source does occur, the function is still available. Thus, although there may be many flights during which one source of the function fails, the risk level associated with any flight is the probability of a joint event—a failure of one source, followed during the same flight by an independent failure of the remaining source. After the first failure, however, the overall exposure per flight hour during the remainder of the flight becomes considerably higher, (see Section 2.4). Consequently the actual risk level may vary not only during the course of the flight, depending on the occurrence or nonoccurrence of a first failure, but also from one flight to another, depending on the duration of the flight. The risk level also varies, of course, with the inherent reliability of the item and the degree to which the function in question is essential to the aircraft.

This situation is illustrated in Exhibit 12.1. In a system with two independent sources, point A represents normal performance when all the items associated with both sources are serviceable. Functional performance at the airplane level will still be normal after a failure of one of these sources, but the risk per flight hour of a complete loss of function is now much higher during the remainder of the flight. Except for servicing and lubrication, scheduled maintenance usually can do

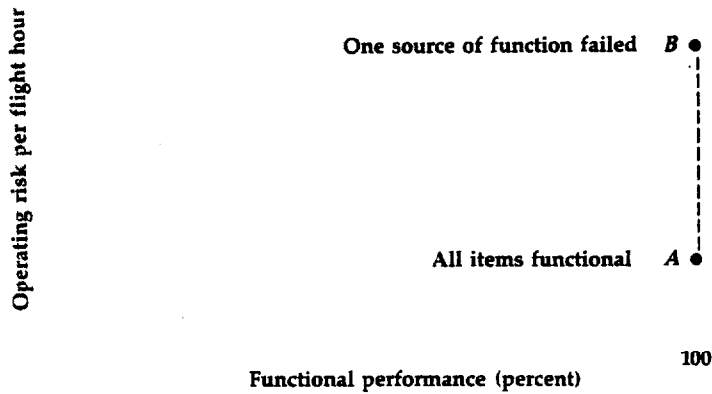

EXHIBIT 12-1 The effect on operating safety of functional failures in the systems division.

very little to reduce the failure frequencies of individual complex items in the systems division. Failure-finding tasks will ensure the repair of items that have already failed, but if the failure rate proves unacceptably high, the only way to improve the reliability of such items is by design changes. The information derived from operating experience will indicate very clearly the areas in which such action is needed.

POWERPLANT FAILURES

A complete loss of all propulsive power in an aircraft is always critical. Once again, however, the likelihood of such a loss is made extremely remote by replication of the basic engine function on multiengine transport airplanes. In some cases this protection is also supported by certain operating restrictions. For example, the length of overwater flights for twin-engine airplanes in commercial service is restricted to ensure that the airplane will not have to fly more than one hour if an engine becomes inoperative. Similarly, transport aircraft operating on transoceanic flights are restricted in weight to ensure that with two engines inoperative the remaining engines will still provide the specified rate of climb.

Although the design goal is assurance of adequate power to overcome any conditions that the airplane may encounter, there is still the remote possibility of extreme turbulence or wind shear that it cannot survive even with all engines operative. When one or more engines are inoperative, even though the remaining engines provide the required

minimum thrust, the airplane's performance capabilities are reduced. Thus there is an increased risk during the remainder of the flight that it will encounter conditions that cannot be handled. This risk may vary during the course of a flight, since it is higher after an engine shutdown than it is when all engines can develop full power. The safety level may also vary from flight to flight, since airplanes fly at different weights below the maximum permissible ones, and airport conditions, en route terrain, and atmospheric conditions all vary from one flight to another.

The general effect of an in-flight engine shutdown on the level of operating risk is illustrated in Exhibit 12.2. The performance capability of the airplane, and hence the risk level, can be measured in terms of available rate of climb. The risk is lowest when all the engines can generate full power and increases as the airplane has less reserve power to draw upon. Unlike most systems functions, however, the situation is not limited to the two cases defined by points A and B. Since an engine failure is defined as the inability to develop a specified amount of thrust, there are many functional failures in which power is reduced, but not entirely lost. Thus the risk level may fall at various points between A and B.

In multiengine aircraft the primary control in maintaining a safe level of available performance is flight-by-flight control of the operating weight of the airplane. Whenever the actual operating weight is less than the maximum performance-limited weight, the available rate of climb is increased accordingly. The effect of this weight reduction

EXHIBIT 12·2 The effect on operating safety of functional failures in the powerplant division.

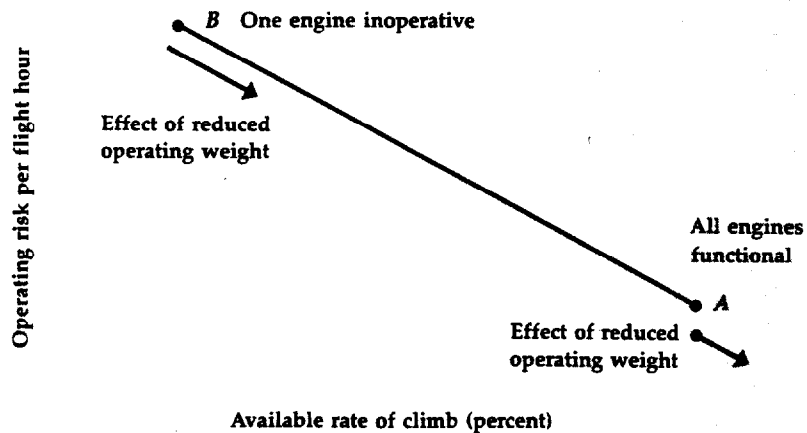

on the risk level is shown in Exhibit 12.2. Scheduled maintenance does play a secondary role, however, since it reduces the frequency of engine failures, and hence the frequency with which the risk level approaches point *B*. In the case of single-engine aircraft, of course, scheduled maintenance is the primary control, since there is only one source of power regardless of the operating weight.

Scheduled maintenance can accomplish much more for engines than it can for some of the systems items. Because modern aircraft engines are designed to facilitate the use of advanced inspection technology, many parts of the engine can be inspected without removing them from the airplane. Thus on-condition tasks can be employed to protect individual engines against many types of functional failures, and safe-life tasks usually prevent the few types of failures that can cause critical secondary damage. While the inherent level of risk depends on the degree of engine replication and the design features of individual engines, the overall effect of scheduled maintenance for a multiengine airplane is, in fact, equivalent to the effect that could be achieved by a reduction in operating weight.

STRUCTURAL FAILURES

The consequences of a structural failure depend on the design characteristics of the structure, but the functional failure of any major assembly is usually critical. With the exception of the landing gear, it is rarely possible to replicate major structural assemblies; hence scheduled maintenance is the only technique available to control the likelihood of functional failures. Although it usually includes some safe-life tasks, the maintenance program consists for the most part of on-condition inspections directed at specific structural sites. It is possible to rely on on-condition tasks, not only because they are applicable in all cases, but also because most modern aircraft structures are designed to be damage-tolerant—that is, they are designed to ensure that the residual strength of a structural assembly meets specified standards after the fracture of an individual element. Although the objective of the inspections is to prevent the fracture of single elements, the practice of damage-tolerant design ensures that a structural assembly will still be capable of withstanding the defined damage-tolerant load in the event that a fracture does occur.

As in the case of the powerplant, there is always the remote possibility that an aircraft structure will encounter loading conditions it cannot withstand even though there has been no reduction of its original strength. Again, the risk level can also vary during a single flight and from one flight to another. If a structural element fractures in the course of a flight, the residual strength will be slightly lower during the remainder of the flight. Similarly, since the fractured element

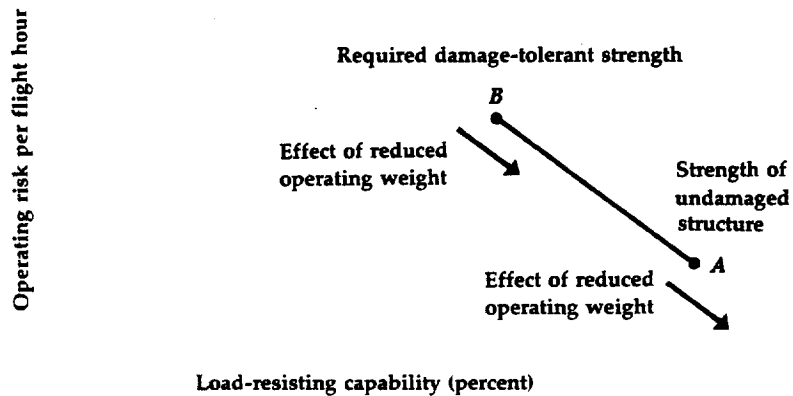

EXHIBIT 12-3 The effect on operating safety of functional failures in the structure division.

may not be discovered and repaired until the next inspection, the risk level can vary from flight to flight, depending on whether a fracture has occurred and the effect on residual strength of the particular element that fractures. In addition, the operating weights of individual airplanes may be much less than the required structural limits, and there is a wide variation—sometimes from one moment to the next—in atmospheric conditions.

Exhibit 12.3 illustrates the general effect that functional failures (fractures) of individual structural elements have on the risk level associated with damage-tolerant assemblies. The assembly itself will suffer a critical loss of function if it cannot withstand any load to which the airplane is exposed. The risk of such an event is lowest when the structure is intact, at point *A*. The operating weight of the airplane is restricted to ensure that the structure can withstand certain defined loading conditions in its undamaged state; it must also be able to withstand the defined damage-tolerant load at the same weight. After a failure occurs, the risk level increases to point *B* and remains at this level until the damage is found and corrected. As in the powerplant division, however, the actual operating risk can assume any value between *A* and *B*, and the risk under any specific set of conditions is reduced when the operating weight is less than the maximum permissible structural weight.

The primary control of the safety level for structures, then, is provided by damage-tolerant design practices and the control of operating weights. The role of scheduled maintenance in this case is to prevent the fracture of individual elements by detecting fatigue cracks in these

elements soon after they occur. When the program is effective, the operating risk rarely rises above the level represented by point A. Once again, the overall effect of scheduled maintenance is equivalent to the effect that would be achieved by a reduction in operating weight.

12·2 AIR-TRANSPORT SAFETY LEVELS

THE PROBLEM OF RISK EVALUATION

As we have seen, there is a remote but undetermined risk level associated with an airplane before its resistance to failure is reduced by any of the forms of impairment to which it is exposed. This inherent level is increased by functional failures, but the amount of increase depends on such design features as the replication of essential functions and the use of multiple load paths in damage-tolerant structures. Scheduled maintenance merely reduces the frequency with which functional failures occur, and hence the frequency with which the basic risk levels are exceeded. Unfortunately, however, we have no precise means of assessing either the inherent level of risk or the increased risks that do result from failures.

the problem of risk evaluation
the dilemma of
extreme improbability

At first glance the assessment of risks in the systems division might seem to be a simple matter of computing flight hours and the failure rates of individual items. The problem is not this straightforward, however, because the results of these considerations must be modified by a probability distribution representing the degree to which each function is essential for the safety of any individual flight. Another important variable, and one that is least amenable to analytic treatment, is the ability of the pilot to respond to and compensate for many types of systems failures.

Risk evaluation in the powerplant and structure divisions is even more difficult. Airplane performance and structural-strength requirements have slowly increased over the years as a result of the few accidents that have occurred, until they have become stringent enough to produce the current safety record. Thus both performance and strength requirements are based on empirical data associated with the rare-events end of a probability distribution describing the conditions that airplanes must be able to withstand. The problem of assessing the basic risk level for any individual airplane is further complicated by operating weights which are usually much less than the airworthiness limits and flight procedures which may differ markedly from those assumed for airworthiness purposes. Consequently, even if the effect of each reduction in failure resistance could be evaluated satisfactorily, we have no means of determining the actual level from which the increase should be measured.

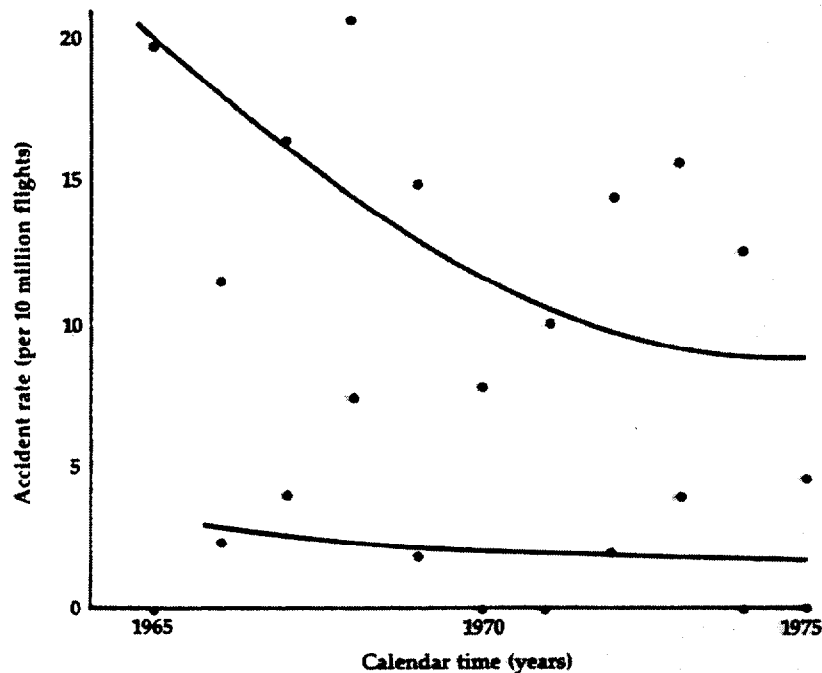

EXHIBIT 12-4 Fatal accident rates for all United States air carriers over an eleven-year period. The lower curve represents the accidents that involved a mechanical failure. (Based on National Transport Safety Board statistics, 1965-1975)

Although accident statistics do not provide enough data to establish meaningful safety levels, a review of the National Transportation Safety Board statistics for the eleven-year period of 1965-1975 shows the general trends plotted in Exhibit 12.4. The data represent all fatal accidents on domestic and international operations of United States air carriers (excluding training, ferry, and military flights) over a period representing approximately 54 million flights. During these eleven years there was a total of 523 accidents from all causes, both fatal and nonfatal, and of the 73 fatal accidents, 11 were either caused by or involved a mechanical failure and 54 were landing accidents.

The causes of these 11 accidents were classified as shown in Exhibit 12.5 to identify the ones that scheduled maintenance might have been able to prevent. Even with the benefit of hindsight, it is unlikely that additional or more effectively performed maintenance could have reduced the rate by more than half. The residual accident rate, which includes some failures of apparently sound structure in extreme turbulence, appears to be 1 per 10 million flights. Scheduled maintenance

probably never will be prescient enough to prevent the first occurrence of certain completely unanticipated types of failure, even though recurrences can be prevented. Thus it will be very difficult to reduce the rate of such accidents to less than 1 in 10 million flights.

THE DILEMMA OF EXTREME IMPROBABILITY

The current airworthiness regulations for transport airplanes cover many aspects of aircraft design—structural strength, powerplant characteristics, airplane performance characteristics, flight-handling qualities, and systems characteristics. These regulations are directed not only at reducing the likelihood of various types of failure, but also at mitigating the consequences of those failures that will inevitably occur. Thus there are detailed requirements for damage-tolerant structure and for the residual performance capabilities of the airplane after one (or more than one) engine has lost power. In addition, there are many requirements to ensure that the operating crew will be capable of handling the airplane safely after a failure has occurred. These airworthiness regulations have resulted in a commendable safety record for transport aircraft.

EXHIBIT 12-5 Classification of fatal air-carrier accidents involving mechanical failures.

cause of accident	no. of accidents	preventable by scheduled maintenance
Failure of apparently undamaged structure in turbulence	2	No
Failure of damaged structure:		
Airplane	1	Yes
Helicopter	2	?
Failure of flight-control system	1	Yes
Secondary damage associated with functional failures:		
Auxiliary-power unit	1	?
Propulsion system	1	Yes
Propeller	1	?
Obscure (functional failures involved, but role in sequence of events leading to accident cannot be identified)	2	?
	<u>11</u>	<u>3 yes</u> <u>2 no</u> <u>6 ?</u>

The regulations include a certification process to verify that the design requirements have in fact been met, and it then becomes the responsibility of the operating organization to maintain the equipment in such a way that the design characteristics are preserved. The operator must also ensure that the flight crews are trained in the procedures necessary to cope with various types of failures. A unique problem is now being encountered, however, with certain systems whose functions cannot be duplicated by the human flight crew. This situation introduces the possibility that at some time a relatively unlikely sequence of failures, some of them perhaps hidden, might result in the loss of one or more functions that are essential to operating safety.

The design objective, of course, is to ensure that such critical failures are extremely improbable, and the FAA has suggested that *extremely improbable* be defined as an expected failure rate of no more than 1 per billion flights (or operating hours, as applicable). Even when an analysis based on assumed failure rates does indicate that the requirement will be met, the validity of the assumed rate cannot be determined in the limited amount of flying done during the certification tests. A further proposal, therefore, is that the maintenance intervals be reduced if actual failure rates are higher than those assumed for the calculations. A reliability-stress analysis based on assumed failure rates may be quite involved even for a simple system. For example, the Boeing 727 automatic-takeoff thrust control is a nonredundant system whose failure can be caused by the failure of any one of approximately 100 different items, some of which have hidden functions. The item considered to be the least reliable in this system was a fuel-control unit that had an estimated mean time between failures of 167,000 hours. To meet the extreme-improbability requirement, however, the availability of this unit would have to be protected by a failure-finding interval of only 125 hours.*

The question, of course, is whether such intensive maintenance to meet this probability requirement is necessary or can possibly achieve the desired result. One in a billion, or 10^{-9} , is a very, very small number. There probably have not been a billion airplane flights since the Wright brothers took to the air. To put it another way, a billion flights represents 200 years of operation at the current activity level of the United States air carrier industry. A risk level of 10^{-9} is 1 percent of the current residual accident rate that cannot be reduced by scheduled maintenance, and it is one-fifth of 1 percent of the current landing-accident rate. On this basis the proposed requirement seems unrealistic. In fact, it may even be counterproductive, since it is likely to prevent the development of systems that would improve safety even though they cannot satisfy the extreme-probability criterion. The real issue, however, is whether

*For a discussion of this analysis see J. J. Treacy, Use of Probability Analysis in Aircraft Certification and Its Effects on Maintenance and Equipment Maintenance, AIAA Aircraft Systems and Technology Meeting, Seattle, Wash., August 22-24, 1977.

it is possible to develop an analytic model for evaluating new systems that is in itself accurate to anything approaching this order of magnitude.

Under the circumstances, although reliability-stress analysis is a valuable tool for comparing alternative design approaches, its application to actual operating and maintenance requirements would be difficult to justify. Further work is clearly necessary to develop a more viable approach to the problem.

12·3 THE DESIGN-MAINTENANCE PARTNERSHIP

The interrelationship between design and maintenance is perhaps most apparent in the case of aircraft. On one hand, the design of the equipment determines its inherent reliability characteristics, including the consequences of functional failures; on the other hand, scheduled maintenance attempts to preserve all the safety and operating reliability of which the equipment is capable. Realization of this goal, however, requires a joint effort which has not always been recognized. Designers have not always understood the capabilities of scheduled maintenance and the practical limits on these capabilities. By the same token, maintenance organizations have not always had a clear grasp of the design goals for the equipment they maintain. The need for a cooperative effort has always existed, but the comprehensive analysis required by RCM techniques makes this need far more apparent.

requirements for
effective maintenance
requirements for
product improvement

During the development of a prior-to-service program the identification of significant items and hidden functions depends on the designer's information on failure effects as well as the operator's knowledge of their consequences. At this stage the information on anticipated failure modes and their associated mechanisms must also come from the designer. While the maintenance members of the study group will be able to draw on prior experience with similar materials, design practices, and manufacturing techniques, this information should be complemented by the designer's advice concerning the ages at which various forms of deterioration are likely to become evident.

At a more fundamental level, it is important for the designer to bear in mind some of the practical aspects of scheduled maintenance. In general, on-condition inspections are the most effective weapon against functional failures. However, it must be possible to use them, preferably without removing items from their installed positions on the airplane. Thus the designer must not only help to identify the items for which such inspections are applicable, but must also make sure that there is some means of access to the area to be inspected. An equally important factor is the use of materials and design features such as damage tolerance which result in a relatively slow deterioration of items intended for on-condition inspections.

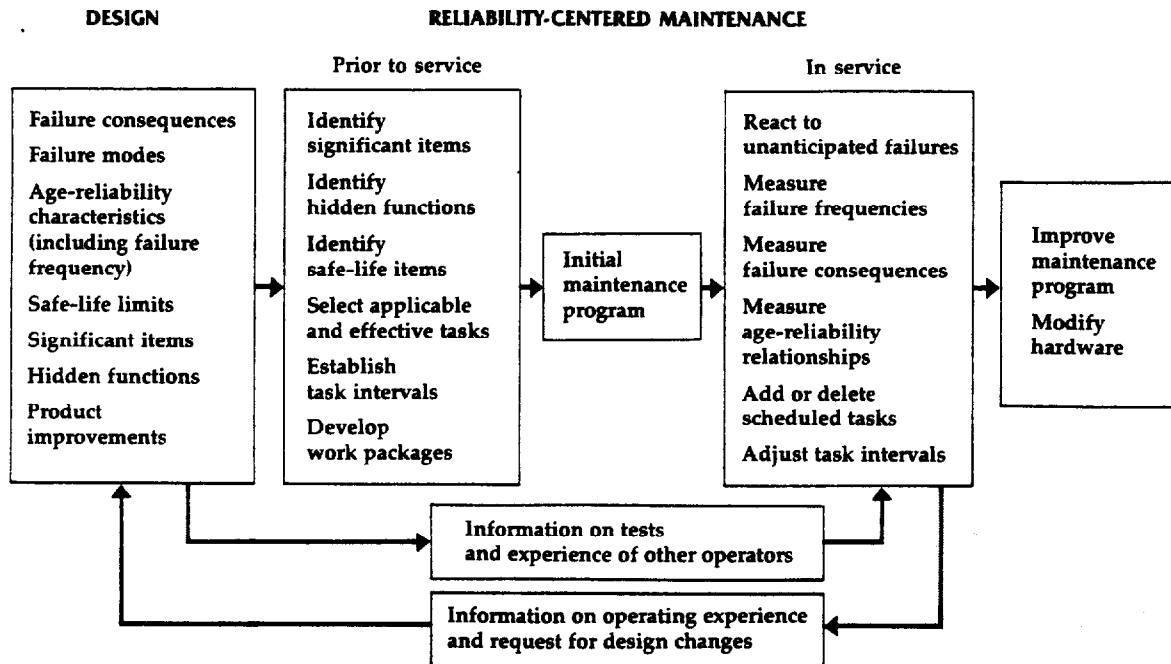

EXHIBIT 12-6 The design-maintenance partnership

Once the new airplane goes into service, there will be continuous refinement and improvement of the basic maintenance program as a result of age exploration. There will also be unanticipated failures, some of which require immediate action. In these cases the designer's help is crucial in developing new interim scheduled tasks that will control the problem until design changes can be developed and incorporated in the operating fleet. Both the design and maintenance organizations must work together to identify the failure mechanism, because this information is needed for product improvement as well as to develop the interim tasks. The product-improvement process and its role in the development of all complex equipment was discussed in detail in Section 5.5. However, it entails a two-way flow of information: the operating organization must identify the need for an improvement, and the manufacturer must advise the operator of the results of his continuing test programs and the experiences that other users of the equipment have encountered. The development of airplanes that can be more effectively maintained and achieve still higher levels of reliability and safety depends on a continuing close partnership, with both design and maintenance organizations familiar with and sympathetic to each other's problems and goals.

12·4 RCM PROGRAMS FOR IN-SERVICE FLEETS

Aircraft have long service lives, and many of the airplanes now in service are supported by maintenance programs developed on bases quite different from RCM methods. For the most part these maintenance programs have evolved to the point of providing adequate protection of safety and operating capability. It is natural to wonder, however, about the extent to which an RCM program would reduce maintenance costs and even improve the reliability of in-service fleets. In nearly all cases there will be some benefits, although the size of the benefits will depend on the nature of the existing program. For an airline fleet maintained by a program based on MSG-2 principles the gains may be minimal, whereas a fleet supported by a traditional program will show major savings. The gains will be somewhat attenuated, however, by the fact that aircraft designed under earlier design philosophies may have fewer items capable of on-condition inspections and more with hidden functions.

expected benefits
systems programs
powerplant programs
structure programs

The areas in which RCM analysis is likely to provide the greatest economic benefits are in the elimination of tasks that are inapplicable, particularly scheduled rework (hard-time overhaul) of powerplants and systems items, increases in task intervals, and a reduction in the number of items assigned to scheduled-maintenance tasks. Even where all present tasks do meet the applicability criteria, the analysis will frequently eliminate a large number of unnecessary or overlapping tasks, thereby providing further economic gains. To ensure that these gains are realized it is important to reduce the size of the workforce to correspond to the reduction in the maintenance workload.

When there is already an existing program it is sometimes tempting to modify it by subjecting the present tasks piecemeal to RCM decision logic. This practice is not recommended, since there is always a tendency to perpetuate some of the tasks that are not really justified. Moreover, this approach will certainly overlook the need for new tasks. The best procedure is to put the old program aside and conduct a pure RCM analysis for the fleet. After the RCM program has been completed it should be compared with the old program and corrected for any clear omissions, and the differences should be evaluated to determine the benefits the new program will provide.

It is usually most efficient to set up a special task force to conduct the RCM analysis. The members of this team should be engineers, reliability analysts, and possibly production or production-planning personnel who are familiar with the type of airplane involved. The analysis begins with the identification of the items to be considered and the development of worksheets to record the data elements and the decision process. Individual members of the task force are then assigned

to collect the data and complete the worksheets for each item. After each member has completed the analysis of two or three items, the results should be reviewed by the whole group. This review is necessary to ensure a common understanding of the decision logic and to improve the definitions of functions and failure modes being used. Usually the review will turn up a number of functions and failure modes that have been overlooked.

Work should proceed quickly after this first review, with different members of the task force assigned to the various systems, the power-plant, and the structure. Substantial operating history for an in-service fleet should provide more than enough data on reliability characteristics and cost factors to make default answers unnecessary for any of the proposed tasks. When each major portion of the analysis has been finished, it is reviewed, any necessary adjustments are made, and all the scheduled tasks are then consolidated into work packages.

An alternative approach is to have the analysis done by the engineers who are normally responsible for the maintenance standards for the various items on the airplane. While this method has the advantage of utilizing the person with the most technical knowledge to analyze each item, it has the drawback of involving a larger number of people, with a consequent increase in the work of training and coordination.

SYSTEMS PROGRAMS

The analysis of systems items for an in-service fleet is similar to that for the initial program of a new type of airplane. The chief difference is that in this case real data are available on reliability characteristics, failure consequences, and costs. Although rework tasks are seldom applicable to systems items, the information is on hand to determine whether such tasks do meet the applicability criteria, and if so, whether they are cost-effective. In fact, except for hidden functions and the rare situation that involves safety consequences, all types of tasks must meet the condition of cost effectiveness. The same information also makes it possible to establish optimum task intervals at this stage.

The airlines have applied MSG-2 techniques, the predecessor of reliability-centered maintenance, to the systems of many types of in-service fleets with somewhat mixed results. The investigation of such techniques on the Boeing 727 and 737 and the Douglas DC-8 was part of the process that led to MSG-1 and MSG-2, and ultimately to RCM analysis. Consequently, by the time MSG-2 programs were developed for these aircraft it was found that the anticipated program revisions for many items had already been accomplished in a rather piecemeal fashion. Even so, the formal reviews led to significant reductions in the number of scheduled rework tasks.

Exhibit 12.7 shows the results of an MSG-2 review of the systems program for an in-service fleet of Boeing 727's. The differences are not

previous program	disposition after review			
	rework	on-condition	no scheduled maintenance	
Rework	172	117†	23	32
On-condition*	325	1	142	182
No scheduled maintenance	15	1	11	3
Total	512	119	176	217

*Many of the tasks originally classified as on-condition did not satisfy the applicability criteria for this type of task. Some were failure-finding tasks and others were actually no scheduled maintenance (no inspections were scheduled and none were possible).

†Twelve of the rework items had shorter intervals after the review.

EXHIBIT 12-7 Summary of the changes in the Boeing 727 systems program as a result of MSG-2 review. (United Airlines)

as dramatic as they would have been if the existing program had not been undergoing continuous change in this direction as MSG-2 evolved. Another factor is that many of the rework tasks left in the program were for highly reliable items that had been assigned very long intervals, such as the major structural inspection interval. These rework tasks were included not because they met the criteria for applicability and effectiveness, but simply to provide a means for occasional inspection in the shop. In RCM terminology these tasks would simply be shop on-condition inspections, although the requirement might be met instead by shop inspection of the older opportunity samples.

As noted in Section 3.5, there are some other differences between RCM and MSG-2 terminology for the basic types of tasks. The category now called no scheduled maintenance was termed *condition monitoring* under MSG-2. MSG-2 also provided no explicit definition of failure-finding tasks; hence some of these tasks are included in the on-condition category and others are included under condition monitoring.

POWERPLANT PROGRAMS

If the existing maintenance program for a turbine engine includes scheduled rework either for the whole engine or for its hot section, RCM analysis will probably result in major reductions in the maintenance workload. The review will be far less productive if the present program is already based on the results of opportunity sampling and age exploration. The economic benefits may also be somewhat limited in the

case of a single-engine airplane. Although complete overhaul will do no more to improve reliability than it would if the engine were installed on a multiengine airplane, there is a natural tendency to specify all possible tasks on the grounds of safety. (Unlike turbine engines, many types of piston engines do have age-related wearout characteristics and thus are more likely to benefit from complete rework.) However, the safety branch of the decision diagram will also lead to the inclusion of any task that is even partially effective in reducing the frequency of loss of thrust; hence a larger number of rework tasks directed at specific failure modes will probably be included on this basis.

The major benefit in applying RCM decision logic to in-service powerplants is that it facilitates the identification of significant items, so that a natural aging process can be established which minimizes the need for scheduled removals or disassemblies. It is possible that the existing opportunity-sampling program is adequate for age-exploration purposes, but if there is any doubt, a new list of significant items can be developed and compared with the present list. If the lists are the same, there may be no need for further RCM analysis. If there are only slight differences, it may still be possible to adjust the sampling requirements instead of undertaking a complete analysis. Otherwise an analysis should be completed for a sample of ten or so random significant items to judge whether further effort will be productive.

The existing maintenance program for the General Electric J-79 engine on the McDonnell F4J was reviewed in 1975 by MSG-2 techniques. The review did not result in a program that was completely structured by RCM logic, but major cost reductions were achieved nevertheless by program revisions which greatly reduced the amount of ineffective scheduled maintenance that was being performed. The engine overhaul interval was doubled, from 1,200 hours to 2,400 hours, with a special inspection introduced at 1,200 hours, and a number of tasks were eliminated from the hot-section inspection performed every 600 hours.

STRUCTURE PROGRAMS

The chief benefit in the review of an existing structure program is likely to be a more effective application of maintenance resources. For example, an analysis of the McDonnell F4J structure identified 161 items as structurally significant, in contrast to only 97 in the original program. Of these 161 items, 141 were scheduled for detailed inspections, whereas the prior program called for detailed inspection of only 66 items. Some of the additional items were designated as significant to focus inspections on specific parts of the structure in which failures would be critical, and others were so designated to ensure the discovery of early deterioration for economic reasons. It is difficult to assess the economic impact of these program changes because there were many

adjustments of inspection intervals, a recommendation for a more dynamic age-exploration program to reduce future costs, and a major refinement of the zonal inspection program.

12.5 EXPANSION OF RCM APPLICATIONS

The widespread and successful application of RCM principles in the air-transport industry has important implications for many types of complex equipment other than aircraft. Rapid-transit systems, fleets of ships and buses, and even machinery used in complex manufacturing processes all require scheduled-maintenance programs that will ensure safe and reliable operation. Many of the current problems indicate that the relationship between design and maintenance is not clearly understood. In many instances, however the operating organizations themselves have not considered the real capabilities and limitations of scheduled maintenance and have been frustrated by their inability to solve the operating problems that are caused by failures.

objectives of a
maintenance program
basic RCM precepts

In most cases the equipment will not be designed to the same standards as those applied to commercial aircraft. There is usually far less use of redundancy to protect essential functions, with the result that any one of a multitude of minor failures can render the equipment incapable of operation. There is also less instrumentation, so that a greater number of items are subject to hidden failures, and therefore to the risk of a multiple failure. Parts that require inspection are often not accessible or have not been designed to facilitate the detection of potential failures. Under these circumstances RCM analysis will not produce a magic solution to all reliability problems. However, it will identify the maintenance tasks and product improvements that would alleviate such problems. Meanwhile, it will result in a program that ensures all the reliability of which the equipment is capable and includes only the tasks that will accomplish this goal.

In general, any maintenance support program based on RCM principles has the following objectives:

- ▶ To ensure realization of the inherent safety and reliability levels of the equipment
- ▶ To restore the equipment to these inherent levels when deterioration occurs
- ▶ To obtain the information necessary for design improvement of those items whose inherent reliability proves to be inadequate
- ▶ To accomplish these goals at a minimum total cost, including maintenance costs, support costs, and the economic consequences of operational failures

One obstacle to all these objectives is the tendency to rely on traditional concepts of scheduled maintenance, especially the belief that scheduled overhauls are a universally effective weapon against failures. Thus an organization must recognize and accept the following facts before it is prepared to implement a detailed RCM program for its equipment:

- ▶ The design features of the equipment establish the consequences of any functional failure, as well as the cost of preventing it.
- ▶ Redundancy is a powerful design tool for preventing complete losses of function to the equipment.
- ▶ Scheduled maintenance can prevent or reduce the frequency of complete losses of function (functional failures), but it cannot alter their consequences.
- ▶ Scheduled maintenance can ensure that the inherent reliability of each item is realized, but it cannot alter the characteristics of the item.
- ▶ There is no "right time" for scheduled overhauls that will solve reliability problems in complex equipment.
- ▶ On-condition inspections, which make it possible to preempt functional failures by potential failures, are the most effective tool of scheduled maintenance.
- ▶ A scheduled-maintenance program must be dynamic; any prior-to-service program is based on limited information, and the operating organization must be prepared to collect and respond to real data throughout the service life of the equipment.
- ▶ Product improvement is a normal part of the development cycle for all new equipment.

Until an operating organization is comfortable with these facts it may be difficult to proceed confidently with the results of RCM analysis. There is often concern because hard-time tasks play such a minor role and so many complex items have no scheduled-maintenance requirements. In this case an organization may wish to reinforce its confidence in the new approach by conducting studies similar to those discussed in Appendix B. The new RCM program will always result in substantial savings, chiefly through the elimination of unnecessary and unproductive maintenance effort. More important, however, by directing both scheduled tasks and intensive age-exploration activities at those items which are truly significant at the equipment level, such a program will ultimately result in equipment that provides a degree of reliability consistent with the state of the art and the capabilities of maintenance technology.

PART THREE

appendices

auditing rcm program development

AN RCM ANALYSIS is conducted by experienced maintenance people, and their professional expertise is one of their most valuable assets. This specialized experience has a corresponding penalty, in that it tends to create certain biases which make objective judgment difficult. The decision-making process therefore requires an independent review by someone who is not directly involved in the analysis – an auditor, who can test the logic of the decision against the prescribed criteria and procedures and check for any flaws in the reasoning. Although the auditor's own judgments may not be completely free of bias or error, the fact that he is independent of the detailed analysis provides him with a different perspective. Thus the audit serves as a practical tool for identifying some of the common errors in the use of the decision logic, and frequently some of the more subtle errors as well.

In the air-transport industry the auditing function is performed by members of the steering committee, which also has overall responsibility for the program-development project (see Section 6.2). Thus the auditors assigned to individual working groups will be aware of the scope of the project, the overlap of work among the various groups, and the specific level of effort needed to coordinate their activities. Because the problems and focus of the analysis will differ from one group to another, it is difficult to offer any universal guidelines. However, working groups tend to stray from the objective of developing a set of applicable and effective scheduled tasks, and it is important for the auditor to be able to detect this and help keep the project on the track.

In many organizational contexts the work of the steering committee and the overall management of the project are themselves subject to audit, to ensure that the work will proceed efficiently and will result in the intended product. Once the program has been developed and pack-

aged for implementation, a group within the operating organization will be responsible for collecting and analyzing the reliability data needed to assess its effectiveness and evaluate the desirability of new tasks. The auditing functions in these two areas often require a different set of skills and experience from those needed to review the detailed analysis of the equipment. In all cases, however, both the auditor and the program-development team will require a clear understanding of the basic concepts outlined in this volume.

A·1 AUDITING THE PROGRAM- DEVELOPMENT PROJECT

The first draft of an RCM program is generally prepared by a special task force consisting of a steering committee and several working groups. The project may be organized and managed in several ways, and the auditor's first concern is whether the organization, staffing, and working procedures are adequate to carry out the project.

SCOPE OF THE PROJECT

To ensure that the finished maintenance program will be accurate and complete, both the auditor and all participants in the project must have a clear understanding of its exact scope. In some cases the project will encompass certain portions of the equipment, rather than the entire aircraft. In either case it is important to know whether the program is to cover all levels of maintenance, from servicing tasks and walkaround checks to the major-inspection level. It is difficult to design a complete maintenance program for only a few of the levels of maintenance, even

if the program is for just one portion of the equipment. If the project does include only portions of the aircraft, there must also be clear provisions for handling items that interface with the portions that are not included. Otherwise the resulting confusion will lead almost inevitably to gaps and overlaps in the total program. The auditor should make sure he understands the scope of the project and should check periodically to see that it is not expanding beyond its intended bounds.

DEFINITION OF THE FINAL PRODUCT

The completed scheduled-maintenance program consists of all the scheduled tasks and their intervals, but the exact form of this program must also be specified. Both the auditor and the program-development team must know whether the final product is to be simply a list of the RCM tasks and intervals, with a brief description for the use of production planners, or whether it is to consist of a complete set of work packages, like the letter-check packages assembled in airline practice. In either case, the definition of the final product should specify the level of task detail and the amount of descriptive material to be included. Will the procedures writers be able to translate the results of the analysis into job instructions that accurately reflect the purpose of each task? For whom is the final report intended? Are detailed explanatory writeups of the program needed as part of the package? The final product will have to be checked against these requirements before it is submitted, and a clear understanding of them at the outset will facilitate the work of the analyst and auditor alike.

TIMETABLE FOR THE PROJECT

The timetable developed for completion of various aspects of the project is also subject to audit. Is it realistic in terms of the amount of work to be accomplished, the number of analysts assigned, and their previous experience with RCM analysis? Are the milestones at logical points for adequate control of the schedule—or perhaps overspecified, so that crucial target dates are likely to suffer? Do they take into account the fact that analysis of the first few items will proceed much more slowly as part of the learning process? It is apparent from these questions that the timetable must be reasonably tight, but also flexible and realistic.

The auditor must accomplish his own work within this timetable. In most cases progress reviews will be conducted when the overall plan is drafted, when the program-development team has been organized and trained, when each working group has agreed on a list of significant items and analysis of the first few items has been completed, when each major portion of the program has been completed, and when the final product has been assembled and is ready for approval. Additional audits will be needed between these check points to review progress and clear up any questions or misconceptions in the analysis itself. Where

subsequent work depends on the results of the auditor's review, is the review timed to ensure that it will not impede other aspects of the analyst's work?

THE PROGRAM-DEVELOPMENT TEAM

In addition to those factors that relate to the project itself, the auditor must also consider the organization of the program-development team and the skills of the people who comprise it. Whereas the analysts will be working engineers with extensive hardware experience, the task force should be headed by someone with managerial experience, and preferably someone who has had experience on similar projects. Is the manager himself knowledgeable about RCM principles, or is he assisted by someone who is? Is he in an organizational position that will facilitate completion and implementation of the project? To what extent is the project supported by top management?

The adequacy of the staffing, the working arrangements among the team members, and the availability of outside resources all require careful study. Are there enough people to do the work in the time allotted—and not too many to work closely as a team? Are the analysts in each working group experts in the portion of the equipment they will be analyzing? Are all engineering and reliability disciplines represented or available for consultation? How is the task force organized? Does the organization provide for direct interaction among members of the group, or are there organizational obstacles that may impede communication? Is each analyst responsible for a complete analysis, or are various aspects of the job (researching information, completing worksheets, etc.) assigned in a way that makes work difficult to integrate? What arrangements have been made for the analyst to obtain help from outside resources or more details about the operation and construction of the equipment? Is the designer available to answer questions about specific failure modes and effects? Is there someone available to each working group who has an extensive knowledge of RCM techniques? The auditor should not only check the availability of these resources, but also determine how frequently they are being used.

STANDARDS AND PROCEDURES

One important function of the steering committee (or manager of the task force) is to arrange for training of all participants. This includes general familiarization with the design features of the new equipment, as well as training in RCM procedures and the standards to be used for this particular project. If this is a large project, some members will require more training than others. Has each member of the task force received adequate training in RCM methods, and is the RCM text available for easy reference? Other standards that apply to the project should also be available in written form. Does each analyst have a copy of the

cost-tradeoff models to be used, including the costs imputed by this organization to various types of operational failures? What failure rates or repair expenses are considered high enough to qualify an item for analysis? All written standards and procedures should be checked carefully for any ambiguity or lack of clarity. They should also be checked for any fundamental conflicts with basic RCM concepts.

Each working group will require additional detailed training on the portion of the equipment to be analyzed. Have all analysts been furnished with written materials, schematics, and full descriptions of the hardware and its relationship to other aspects of the airplane? Are reliability data available for similar items, either from developmental testing or from service experience? Is there access to an actual production model of the equipment if further questions arise?

A·2 AUDITING THE DECISION PROCESS

THE SELECTION OF ITEMS FOR ANALYSIS

Once the program-development team has been assembled, organized, and trained, the focus of auditing shifts to the analysis process itself. Ordinarily this phase of auditing is carried out by a member of the steering committee, but the chief prerequisite is a clear understanding of RCM principles. As a preliminary step the working group will screen out all obviously nonsignificant items and complete descriptive worksheets for those items selected for analysis. Thus the first problem may be in arriving at a common definition of *significant item*. There is often a tendency to identify items as significant on the basis of their cost and complexity, rather than on the basis of their failure consequences. It is important that all members of the group understand that failure consequences refers to the direct impact of a particular loss of function on the safety and operating capability of the equipment, not to the number of failure possibilities for the item or the effect of these failures on the item itself.

Another area that may require clarification is the definition of operational consequences. If the minimum-equipment list or other regulations stipulate that the equipment cannot be dispatched with an item inoperative, the item is always classified initially as one whose failure will have operational consequences. However, the actual economic impact will vary from one operating context to another and even from organization to organization, depending on scheduled use of the equipment, maintenance facilities, the ease of replacing failed units, and a variety of other considerations. For this reason it is necessary to have a clear definition of the circumstances that constitute operational consequences and the relative costs imputed to those consequences by the organization for which the program is being prepared. Without

this information there is no clear basis for determining whether a given type of failure would have major economic consequences for this particular organization.

REVIEWING THE INFORMATION WORKSHEETS

Several problems may come to light when the completed worksheet forms are examined. One of these is the design of the worksheets themselves. Each organization will have its own preferences about forms, but the worksheets must cover all the points to be considered in the analysis. Whenever worksheets are redesigned there is always the danger of overlooking some of the basic elements or introducing "improvements" that reflect misconceptions. In general the forms should be as simple as possible and still provide an adequate record of the decision process. The chief criterion is that each task be completely traceable. At any time, either during or after analysis, it must be possible to start with any function and trace through to the task assigned to protect it or to backtrack from a given task to examine the reasoning that led to it. Obvious omissions can often be spotted from an examination of the blank forms, but more subtle difficulties may not come to light until the first few worksheets are completed.

Another problem—and perhaps the single most important error for the auditor to detect—is improper definition of the functions of an item. Is the basic function stated precisely for the level of item in question? Does it relate directly to some higher-level function that is essential to operating capability? If not, there may be some confusion about the level of item under discussion. Have all secondary or characteristic functions been listed, and is each in fact a separate function from the standpoint of the operating crew or the system as a whole? Does the list include all hidden functions (again, stated in terms of the system as a whole)? If there are failure possibilities with no related function, this is a clue that the functions themselves require further thought. For example, the basic function of a fuel pump is to pump fuel; however, if this item is also subject to leaks, one additional function must be to contain the fuel (be free of leaks).

It is important to bear in mind that the level of item being analyzed will affect the way the functions are described. At the parts level each part has a function with respect to the assembly in which it is contained, but a description of these functions leads to an analysis of failures only from the standpoint of the assembly, not from the standpoint of the system or the aircraft as a whole. At too high a level the number of functions and failure possibilities may be too great for efficient analysis. One test is to select a few items and try combining them or dividing them further to see whether this changes the list of functions. If so, select the level that makes the analysis most efficient but still includes all the functions that can clearly be visualized from the aircraft level.

The statement of functional failures should be examined carefully for any confusion between functional failures and failure modes. This statement must describe the *condition* defined as a functional failure (a loss of the stated function), not the manner in which this failure occurs. There is often a tendency to describe a failure such as external leaks as "leaking oil seal," with the result that other failure modes that lead to external leaks may be overlooked, or else erroneously attributed to some other function. This problem is often a source of the difficulty in defining the item's functions. The statement describing the loss of a hidden function requires particular care to ensure that it does not refer to a multiple failure. For example, if the function of a check valve is to prevent backflow in case of a duct failure, the functional failure in this case is not backflow, but no *protection* against backflow. Errors in this area can be quite subtle and difficult to spot, but they frequently lead to confusion about the failure consequences.

The identification of failure modes is another problem area. Do the worksheets list failure modes that have never actually occurred? Are the failure modes reasonable in light of experience with similar equipment? Have any important failure modes been overlooked? In this area the auditor will have to rely on his own general engineering background to identify points on which further consultation with the designer or other specialists is advisable. One problem to watch for is superficiality — failure modes that are not the basic cause of the failure. Another is the tendency to list all possible failure modes, regardless of their likelihood. This results in a great deal of unnecessary analysis and the possible inclusion of unnecessary tasks in the initial program.

Just as failure modes may slide back into the description of functional failures, they also tend to slide into the description of failure effects. Thus one point to watch for is a description of failure effects that relate to the cause of the failure, rather than to its immediate results. Again, the failure mode "leaking oil seal" will sometimes be stated as a failure effect (perhaps with "oil-seal failure" given as the failure mode). This is a subtle error, but it obscures the effect of the functional failure in question on the equipment and its occupants.

The description of failure effects must include all the information necessary to support the analyst's evaluation of the failure consequences. Does the statement include the physical evidence by which the operating crew will recognize that a failure has occurred — or if there is none (a hidden failure), is this fact mentioned? Are the effects of secondary damage stated, as well as the effects of a loss of function, and is it clear from the description whether or not the secondary damage is critical? Is the description stated in terms of the ultimate effects of the failure with no preventive maintenance? In the case of hidden functions the ultimate effects will usually represent the combined effects of a possible

multiple failure. This information helps to establish the intensity of maintenance required to protect the hidden function; however, it must be clear from the description that these effects are not the immediate result of the single failure under consideration.

The failure effects should be examined to ensure that they do not represent overreaction by inexperienced analysts. At the other extreme, there is a possibility that serious effects may have been overlooked where the equipment cannot be shown to be damage-tolerant for certain types of failures. In either case the effects stated—including secondary damage—must be a direct result of the single failure in question, and not effects that will occur only in conjunction with some other failure or as a result of possible pilot error. As with hidden-function items, protection against multiple failures is provided for in the decision logic by independent analysis of each single failure possibility.

CLASSIFICATION OF FAILURE CONSEQUENCES

The first three questions in the decision logic identify the consequences of each type of failure, and hence the branch of the decision diagram in which proposed tasks are to be evaluated. The answers to these questions therefore warrant special attention during auditing to ensure that the tasks have been measured against the correct effectiveness criterion. The basis for each answer should be clearly traceable to the information recorded on the descriptive worksheet.

There are several common problems in identifying hidden functions. The first matter to be ascertained concerns the use of the decision diagram itself. Has the evident-failure question been asked, not for the item, but for each of its functions? If not, the answer may be true only for the basic function, and other functions will be analyzed according to the wrong criteria. And if the basic function of the item happens to be evident, hidden functions that require scheduled tasks may be overlooked. Another common error is the tendency to overlook cockpit instrumentation as a means of notifying the operating crew of malfunctions that would otherwise not be evident. An error that is more difficult to spot is the identification of a replicated function in an active system as evident when a failure would in fact not become evident until both units failed.

Have the hidden functions of emergency items, such as ejection-seat pyrotechnics and stored oxygen, been overlooked? Hidden-function items with built-in test equipment may be improperly identified as having evident functions because failure-finding tasks are performed by the operating crew. Similarly, items whose loss of function is evident during normal use may be mistakenly classified as hidden-function items simply because they are not used during every flight. (In this case the failure-reporting system may have to be supplemented by

maintenance checks to ensure continued availability, but the analysis of this function does not fall in the hidden-function branch.)

Answers to the safety questions may reflect some misconceptions about the definition of a critical failure. Has a failure been identified as critical (or for that matter, as evident) on the basis of multiple-failure consequences, rather than the consequences of a single failure? Has it been identified as critical because it requires immediate corrective maintenance—that is, it has operational (but not safety) consequences? Has the analyst taken into account redundancy and fail-safe protection that prevent a functional failure from being critical? One problem that requires special attention is the failure to identify secondary damage as critical when the aircraft cannot be shown to be damage-tolerant in this respect.

Answers to the operational-consequences question should be checked for any inconsistencies with the minimum-equipment list (MEL) and the configuration-deviation list (CDL). The auditor should watch for tendencies to interpret failures that are expensive to repair as having operational consequences, or to ascribe operational consequences to failures that inconvenience the operating crew but do not limit the operating capability of the equipment in any way. In some cases operating restrictions associated with continued operation after the occurrence of a failure may be overlooked as operational consequences. If they have also been overlooked in the statement of failure effects, they should be added to the information worksheet.

A no answer to question 3 means that the failure in question has only nonoperational consequences, and that function need not be protected by scheduled tasks in an initial program. If the item is subject to a particularly expensive failure mode, it will ordinarily be assigned to intensive age exploration to determine whether scheduled maintenance will be cost-effective. At this stage, however, any task analysis that falls in the third branch of the decision diagram is subject to challenge by the auditor and must be supported by a cost-tradeoff study based on operating data for the same or a similar item.

All answers to the first three decision questions should be examined in detail, at least for the first few items completed by each analyst. Even experienced analysts will have to refer to the RCM procedures to refresh their memories on certain points, and the auditor's review of this aspect of the decision logic is essential not only to correct errors, but to ensure that the analyst fully understands the nature of the questions. Misconceptions in this area are often evidenced by attempts to revise the decision diagram to overcome some apparent shortcoming. So far such revisions have proved to stem from an incomplete understanding of RCM concepts, rather than from deficiencies in the diagram. The auditor should therefore be alert to this tendency and make sure that the decision diagram has not been altered.

TASK SELECTION: APPLICABILITY CRITERIA

The answers to the remaining decision-diagram questions represent the evaluation of proposed tasks. The most important point for the auditor to determine here is that the analyst understands the relative resolving power of the four basic types of task and the specific conditions under which each type of task is applicable. One frequent error in evaluating an on-condition task is the failure to recognize all the applicability criteria. If the task is merely an inspection of the general condition of the item and is not directed at a specific failure mode, it does not constitute an on-condition task. The failure mode must also be one for which it is possible to define a potential-failure stage, with an adequate and fairly predictable interval for inspection. Another error is extending the task to include the detection of functional failures (as defined for the level of item being analyzed); the objective of an on-condition task is to remove units from service before the functional-failure point.

It is important to evaluate proposed on-condition tasks in terms of their technical feasibility. The failure mode may be one for which on-condition inspection is applicable, but is the item accessible for inspection? Is the task one that is feasible within the maintenance framework of the organization? Working groups often suggest inspection techniques that are still in the developmental state or recommend methods that are feasible in theory but have not been tested. In the case of critical failure modes this may be necessary, but it is equally likely that redesign would eliminate the need for the task, and both alternatives should be investigated. Does each inspection task include the specific evidence the mechanic is to look for? If not, the procedures writers may have difficulty converting the task to the proper job instruction, especially when the task is a visual inspection.

If a rework task has been specified, have the age-reliability characteristics of the item been established by actuarial analysis? Does the conditional-probability curve show wearout characteristics at an identifiable age *and* a high probability of survival to that age? Is the failure mode one for which rework will in fact restore the original resistance to failure? The auditor should be prepared to question assumptions that the item under study will prove to have the same reliability characteristics as a similar item that was shown to benefit from scheduled rework. If there is reason to believe that scheduled removals for rework will be of value, is there a cost-effective interval for this task? Has the item been assigned to age exploration to obtain the necessary information?

The only discard tasks that should appear in an initial program are for items that have been assigned life limits by the manufacturer. However, there is sometimes confusion about the difference between safe-life limits and other age limits. Does the safe-life limit represent a zero conditional probability of failure up to that age? Is the limit supported

by manufacturer's test data? If the task interval instead represents the average age at failure, it is incorrect. Safe-life tasks are applicable only to items subject to critical failures; hence they should appear only in the safety branch of the decision diagram. The life limits assigned to hidden-function emergency items – which are not in themselves subject to critical failures – are adjusted on the basis of failure-finding tests and in the strict sense are not safe-life limits. The auditor should question any safe-life discard tasks that are not supported by on-condition inspections (where possible) to ensure that the safe-life age will be achieved.

There are several pitfalls to watch for in auditing failure-finding tasks. One is the failure to recognize that these tasks are the result of default – that is, they are the outcome of all no answers in the hidden-function branch of the decision diagram. Another problem is failure to recognize that these tasks are limited to the detection of functional failures, not potential failures. The intervals for such tasks should be examined for mistaken assumptions concerning the required level of availability. Does the level of availability properly reflect the consequences of a possible multiple failure? Has the analyst overlooked the fact that the interval is based only on the required availability of the hidden function itself? Have failure-finding tasks covered by routine crew checks been accounted for on the decision worksheets?

TASK SELECTION: EFFECTIVENESS CRITERIA

It is important to remember that the applicability criteria for tasks pertain only to the type of task and are true for that task regardless of the nature of the failure consequences. The effectiveness criteria, however, depend on the objective of the task – the category of failure consequences it is intended to prevent – regardless of the nature of the task. Thus the expected resolving power of a particular task can be measured only in terms of the effectiveness criterion for the branch of the decision diagram in which the failure is being analyzed.

Some practical problems often come up in interpreting the effectiveness criterion for the safety branch. Do the tasks and intervals selected have a reasonable chance of preventing all critical failures? If not, what is the basis for judging that the remaining risk level is acceptable? It is important in this connection to bear in mind the resolving power of the different types of tasks. On-condition tasks provide control of individual units and therefore have a good chance of preventing all functional failures if the inspection interval is short enough; in contrast, age-limit tasks (scheduled removals) merely control the overall failure rate for the item. The auditor should therefore question the decision outcome of scheduled rework in the safety branch, because a reduction in the failure rate is unlikely to reduce the risk of failure to an acceptable level. What is the policy or procedure for items for which no applicable and effective

tasks can be found? Is there an established procedure for referring them back for redesign? Is there provision for a review with the designer prior to any such referrals?

For tasks in the operational-consequences branch the only criterion for effectiveness is cost effectiveness. Does the analysis show the basis for determining that the task will be cost-effective? What costs are imputed to the operational consequences, and what is the source of these costs? Is the number of operational interruptions shown in the analysis realistic? Is the expected reduction in this number as a result of the proposed task based on real data, or at least real data for a similar item?

Cost effectiveness is far more difficult to justify in the nonoperational-consequences branch. If a task has been assigned, what is the basis for the cost-tradeoff analysis? Does the analysis erroneously attribute imputed costs of operational interruptions to these failures? If it includes any savings beyond the cost of correcting the failure and its resulting secondary damage, the cost analysis is incorrect.

In the hidden-function branch a proposed task must ensure the level of availability necessary to reduce the risk of a multiple failure to an acceptable level. Is there a policy concerning this risk level that can be used to interpret adequate availability? Does the policy differentiate between items on the basis of the consequences of the multiple failure?

USE OF THE DEFAULT STRATEGY

In any initial program the decision paths will reflect default answers. Thus the analyst's use of the default strategy should also be audited. Have failures which may or may not be evident to the operating crew always been classified as hidden? Where it cannot be demonstrated that any anticipated secondary damage will not be critical, has the failure been assigned to the safety branch? Have any opportunities been overlooked to assign on-condition inspections that may be partially effective in preempting functional failures? Have all items for which the necessary information was unavailable been assigned to age exploration? In checking the analyst's understanding of the default strategy, the auditor may encounter some instances of overuse. Have default answers been used when real and applicable data for the item are in fact available as the basis for a firm decision?

GENERAL USE OF THE DECISION LOGIC

After examining individual aspects of the decision logic, the auditor must review the results of the analysis in larger perspective. Has every task been assigned through direct application of the decision logic? One major problem is the tendency to select a familiar maintenance task and then work back through the decision logic to justify it. This handicaps

the analysis in two ways: on one hand, more of the tasks tend to stay justified, and on the other, the possibilities of new tasks are not explored. Some analysts may have a strong preference for rework tasks and will specify them whether they are applicable or not. Others will favor on-condition inspections under any and all circumstances.

The auditor should look for signs of individual bias during the progress-review meetings, and by actually counting the numbers of each type of task selected by the various analysts. If there are more than a dozen rework tasks for the entire systems division of a new type of airplane, the results of the analysis should be questioned. It is also important to check the disposition of items that have no scheduled tasks. Is the number disproportionately high or low? Have items whose failures have neither safety nor operational consequences been reclassified as nonsignificant?

The worksheets and all supporting information should be assembled for each item, usually with a cover sheet summarizing all the tasks and intervals. After this material has been audited for accuracy and completeness, and revised or corrected as necessary, the auditor should sign or initial the list of tasks as final approval.

A·3 AUDITING ANALYSIS OF THE EQUIPMENT

The auditing principles discussed thus far apply to all divisions of the equipment. However, each of the major divisions — systems, powerplant, and structure — has certain features that pose specific problems during analysis.

ANALYSIS OF SYSTEMS ITEMS

The chief difficulty in analyzing systems items is confusion about the appropriate level of analysis and the functions of the specific item under consideration. Does the list of significant items consist of systems and subsystems, perhaps with a few of the more important complex assemblies? If more than 500 systems items have been classified as significant at the aircraft level, the list is probably too long, and if there are fewer than 200, it may be too short. If any subsystem includes more than half a dozen functionally significant items, their classification should be reexamined.

Another problem is finding the dividing line between one system and another. Have the working groups agreed on the list of significant items and the specific hardware each analysis will cover? Does the procedure allow for later revisions as each group gets into the details? Working groups will occasionally overlook a significant item or a hidden function. The auditor should check for this by scanning the list of items classified as nonsignificant and questioning any that are doubtful.

Several questions will come up in examining the list of functions for each item. Is the basic function correctly stated for the system level represented by the worksheet? (Is the system level clearly indicated on the worksheet?) How does the analyst know that all the functions have been listed? Does each functional failure have at least one failure mode, and are the failure modes all real and possible? Do the failure effects reflect the complete impact of each type of failure on the rest of the equipment? It pays to play "what if" with the analyst for a sample of failure possibilities to determine whether he has analyzed the item in sufficient depth.

In auditing the tasks assigned to the item the auditor should check to see that on-condition inspections are generally limited to installed items. There is a tendency to specify shop inspections for systems items simply because they will be in the shop often, which may unnecessarily increase the workload. Any rework tasks must be substantiated by actuarial analysis. Does this analysis show that scheduled rework will in fact improve the reliability of the item? Rework is not cost-effective for many systems items even when their failures are age-related. If a rework task is applicable, has a cost-effective interval been found?

Are discard tasks specified only for the few systems items to which the manufacturer has assigned life limits? Are safe-life limits supported, where possible, by shop inspections of opportunity samples for corrosion or other damage? Do failure-finding tasks scheduled for installed systems items duplicate either shop inspections or routine crew checks? Where such tasks are added to crew duties, what consideration has been given to the present workload of the operating crew? What provisions have been made for evident functions that the analyst knows will not be used regularly in the intended operating context?

ANALYSIS OF POWERPLANT ITEMS

In auditing a powerplant program it is important to know exactly what the powerplant includes. In some cases the analysis covers only the basic engine; in others it includes all the quick-engine-change parts. If this has not been determined, some key items may escape analysis. Certain problems will be a matter of coordination. Was the systems analysis of essential engine accessories far enough along to be taken into account by the powerplant analysts? Did they have access to the structural analyses of the engine mounts and cowling? How do the failure possibilities for these items affect the basic engine?

The engine itself is subject to a number of failure modes that involve secondary damage. Whether or not this damage is critical, however, depends on both the model of engine and the type of airplane. Does the working group have a complete understanding of the specific design characteristics of this engine? The failure effects require particularly careful auditing. Has the analyst considered the ultimate effects in the

absence of any preventive maintenance, or does the description presuppose that progressive failure modes will be halted before they reach the critical stage? Will a failure mode that would otherwise be critical in fact be preempted by a noncritical loss of function? Where the failure evidence depends on cockpit instrumentation, what instrument indications are evidence of this particular type of failure?

Unless the engine is installed in a single-engine plane, an engine failure that does not involve critical secondary damage does not have safety consequences. Have evident failures been properly placed in the operational-consequences branch of the decision diagram?

Safe-life items must be covered by discard tasks, but most of the tasks in an initial powerplant program will be on-condition inspections. Have these inspections been assigned to installed engines whenever possible, to avoid the need for engine removals? Are they limited to known problem areas, with the remaining on-aircraft inspection capability reserved for troubleshooting and later scheduled tasks if necessary? The intervals for inspections on installed engines should be specified in operating hours or flight cycles, whereas shop inspections of internal engine items should be scheduled to take advantage of opportunity samples. Have any shop inspections been specified in a way that will require scheduled removals or unnecessary disassembly to reach a single part?

The entire age-exploration program for the powerplant should be reviewed. Does it include procedures for increasing task intervals on the basis of inspection findings? Does it provide for inspection of the oldest parts available on an opportunity basis, without special disassembly for age-exploration purposes? Does it include threshold limits, or a similar plan, to allow the removal of most units from service at or before the upper limit without special engine removals? If any of these features are missing, that aspect of the age-exploration plan should be questioned.

ANALYSIS OF THE STRUCTURE

Auditing of the structure program consists of a review of the ratings and class numbers used to establish the initial inspection interval for each structurally significant item. Both the auditor and the analysts must have a clear understanding of the difference between damage-tolerant and safe-life structure, the rating factors that apply in each case, the basis for rating each factor, and the basis for converting the final class number into an inspection interval. Some members of the working group may have more difficulty than others in grasping the distinction between resistance to failure and residual strength. Are all members of the working group using the same definition of fatigue life, and are the manufacturer's data expressed in these terms? Was the conversion of test data into safe-life limits based on an adequate scatter factor?

The definition of a structurally significant item is one of the most important aspects of the analysis. Is the basis for this definition clearly understood by the working group? Are the significant items generally confined to primary structure, or is needless effort being devoted to evaluation of much of the secondary structure as well? Has adequate consideration been given to the possibility of multiple failures at the same site? If the designations are correct, most of the significant items will represent small localized areas, rather than whole structural members; otherwise each item will require much more inspection time in the continuing program. Has the manufacturer's engineering department participated in the identification of significant items? No one else is in a position to identify the structural elements most susceptible to fatigue failure and the effect of such failures on the strength of the assembly.

If the structure includes any new material or manufacturing processes or is to be operated under any new conditions, the inspection intervals will be far more conservative. Even with familiar materials and conditions, however, the test data must be data for this production model. Is a fatigue test being conducted for the whole structure, and will preliminary results be available in time for use in developing the initial program? Will inspection findings and any failure data from the flight-test program be available? The fatigue data should be examined to determine whether the flight-load profile is realistic. The usual test method is flight cycles; is the conversion to operating hours realistic for the intended operating environment?

While structural strength and fatigue life are the manufacturer's responsibility, the operating organization is concerned in these matters as well. The working-group members must therefore have enough information about the design and the test results to be able to evaluate and question the manufacturer's maintenance recommendations. One point the auditor should check at an early stage is whether there is adequate interaction between the manufacturer's and the operator's representatives to provide for full participation by all members. Before work begins there must be general agreement on the basis for the selection of significant items and the basis on which each factor will be rated. A sample of structurally significant items and their ratings should be audited to make sure they correspond to this agreement before significant items are selected for the whole structure. Do the ratings give proper recognition to areas prone to corrosion as a result of their location? Has external detectability been properly considered? What was the basis for converting class numbers to intervals? Are the intervals similar to those in current use for other aircraft?

The number of structurally significant items on an airplane will depend on the size of the airplane, the size of the area designated as significant, and in some cases on the number of ways it can be accessed. Has the exact location of each significant item been clearly designated?

Have photographs been provided which show the designated items? The working group should verify the entire list of significant items by inspection of an airplane in its fully assembled configuration. Some items assigned visual inspection may in fact be hidden beneath other structural elements or behind installations. In this case x-ray inspection may have to be specified, or some other approach to the area may have to be employed for this significant item. The tasks themselves should be audited to ensure that the inspection plan as a whole does not include unnecessarily expensive or sophisticated techniques. Is x-ray inspection, for example, limited to areas in which it is known to be useful, or are all items covered in the hope that it will prove useful?

The basic inspection plan covers only structurally significant items. However, it will be supplemented by general inspections of nonsignificant structure as part of the zonal program, preflight walkaround inspections, and general inspections of the external structure. The structure program should therefore be reviewed in connection with these other programs, both for any obvious conflicts and to ensure that all nonsignificant portions of the structure have been accounted for. Has external structure that is not visible from the ground been taken into account? Do the inspections assigned to structural elements in systems and powerplant items take into account the other inspection requirements of these items?

NON-RCM PROGRAM ELEMENTS

The zonal inspection program should be audited to ensure that all zones in the airplane are included. If a rating scheme has been used to establish relative inspection intervals, is it consistent with RCM principles? Do the relative intervals for each zone correspond to the rating scheme? How do these intervals correspond to those for detailed inspection of internal structurally significant items? If there are conflicts, can the zonal inspection intervals be adjusted? Zonal inspections are general visual inspections; do the tasks clearly describe the elements in the zone to be inspected?

The servicing and lubrication tasks should be audited for completeness, and any deviations from the manufacturer's recommendations should be substantiated. The specifications for walkaround and other damage inspections should be audited to make sure that all the important areas are clearly indicated—especially those most likely to incur damage from ground operation and from mechanic traffic itself.

THE COMPLETED PROGRAM

After each working group has completed its analysis and the results have been audited separately, additional questions may arise when the program is examined as a whole. Some apply to the accuracy and completeness of the worksheets when they are summarized for each major

portion of the airplane; others apply to packaging questions that arise when all the tasks are grouped for implementation.

Do the tasks for each portion of the airplane cover all levels of maintenance? Have all of them been transcribed accurately? Do they still make sense when they are viewed together? One problem that may come up at this stage is a discrepancy in the level of task detail and amount of explanatory material for different items. All the tasks should be reviewed to see that they meet the original definition of the final product. Are there any gaps or overlaps? If the final product is simply a list of the tasks and their intervals, have those intervals that are flexible been indicated, to facilitate packaging decisions?

Packaging presents special auditing problems, since the standards to be applied depend on the organization, its routing practices, the fleet size, the number and location of maintenance facilities, and a variety of other factors. Have these been taken into account? Are the most frequent tasks the kind that can be accomplished at small stations with limited staff and facilities? Auditing the packaging of the tasks is primarily a matter of determining whether the tasks have been scheduled as efficiently as possible for a given set of circumstances.

The impact of the maintenance program on the intended use of the equipment should not be overlooked in the audit. Will the proposed maintenance schedule permit each aircraft to carry out the longest series of scheduled flights without interruption? If not, can either the operating schedule or the maintenance schedule be revised? Does the program allow for all the operating environments that will be encountered, including a possible change from one set of operating conditions to another for the same aircraft? Does it provide for RCM analysis of any new systems or tasks that may be added as a result of age exploration?

A·4 AUDITING THE ONGOING PROGRAM

Once the initial RCM program has been completed and packaged for implementation, a group within the organization will also be needed to monitor failure data and the results of age exploration and revise the prior-to-service program accordingly. The plans for these activities and overall management of the ongoing program are also subject to auditing. Certain information systems must be established before the aircraft goes into service:

- ▶ A system for reporting failures, their frequency, and their consequences
- ▶ An age-exploration system for continual evaluation of age-condition information, with procedures for extending task intervals as rapidly as the data permit

- ▶ A system for controlling the addition of new scheduled tasks to ensure that they meet RCM criteria before they are accepted
- ▶ A system for periodic reevaluation of all tasks in the program to eliminate those which are no longer needed
- ▶ A system for reviewing the content of the work packages as the size of the fleet grows
- ▶ A system for evaluating unanticipated problems and determining the appropriate action

Are the present information systems adequate to meet all these requirements? Are they adequate for the size and age of the fleet? How familiar are the key personnel with basic RCM concepts, and how are differences of opinion resolved?

Auditing an ongoing maintenance program may require different skills and experience from those needed to audit program development. The auditor's questions during program development are chiefly at the procedural level. At this stage, however, the auditor may often find himself in an adversary situation, where much of his work is with people having differing viewpoints about what should or should not be done. Thus he will have to be both inquisitive and objective to discern the overall pattern of reliability information from various sources and interpret its impact on the maintenance program.

A·5 AUDITING NEW PROGRAMS FOR IN-SERVICE FLEETS

The auditing principles in Sections A.2 and A.3 also apply to new RCM programs for in-service aircraft, but there are some additional factors to bear in mind. Older aircraft may not be as sophisticated or complex as those currently being developed, and there are often fewer fail-safe or damage-tolerant features. Consequently both the pattern of analysis and the resulting tasks may differ somewhat from those for a new airplane. Another reason for the difference, however, is that much of the age-exploration information is already available; thus the tasks that would ordinarily be added later to a prior-to-service program will appear from the outset in a new program for in-service equipment.

It is especially important for the auditor to determine that the new RCM program is not being developed by an analysis of the existing tasks, but represents a completely independent analysis of the equipment. The set of tasks resulting from this analysis should then be compared with the existing program to determine the differences. At this time the current tasks that were not included in the new program should be reviewed, but only to ensure that nothing has been missed.

In developing a program for a new type of airplane reliability data on similar items, even when it is available, may or may not apply to the item under study. In this case, however, the necessary information is available from actual operating experience. Thus one of the major differences in auditing the analysis itself is to determine that the data were in fact used and were used correctly. The auditor should make sure that rework tasks, for example, have not been selected without an actuarial analysis of the data on this item. A sample of the actuarial analyses themselves should be reviewed to see that they conform to the general methods outlined in Appendix C.

The number of tasks in the program will ordinarily be somewhat greater for an in-service airplane, and in many cases there will be quite a few rework tasks for systems items. These should be reviewed thoroughly to make sure they are necessary; however, an older airplane may require more rework tasks than a new one for several reasons. First, the results of age exploration will show that a few rework tasks are economically desirable and should be included in the program. Second, the older designs may actually have more assemblies that show a wear-out pattern. There may also be a larger number of scheduled tasks for hidden functions because of older design practices, and the number of on-condition tasks may be slightly higher because ways of exploiting these relatively inexpensive inspections will have been found for a number of items.

In comparing the completed RCM program with the existing program the auditor will have to take differences in terminology into account. Many older programs call some tasks on-condition that do not meet the criteria for this type of task. They may be inspections of the general condition of the item, or they may be inspections to find functional failures rather than potential failures. Similarly, the designation condition monitoring will actually include failure-finding tasks for some items. In case of doubt the auditor (or the analyst) may have to refer to the job-instruction card for the present task to determine its actual nature.

As with any program-development project, the results should be reviewed to ensure that they are in accord with the definition of the final product. In the case of a program for in-service equipment the final product may consist only of the new RCM program, or it may include a full cost comparison of the two programs and perhaps a list of recommendations.

the history of rcm programs

MAINTENANCE THEORY in the aircraft industry began with certain traditional ideas. One was the assumption that there is a one-to-one relationship between scheduled maintenance and operating reliability; hence the more scheduled maintenance, the more reliable the equipment would be. Since it was further assumed that reliability is always related to operating safety, these ideas led to the belief that each item had a "right" overhaul time which could be discovered but must not be exceeded in the meantime.

Over the years equipment designers have been able to eliminate the possibility of most critical failures, and although the two issues cannot be entirely dissociated, modern aircraft design practices have greatly weakened the relationship between safety and reliability. While safety is the first consideration that leads to failure-tolerant or damage-tolerant design, redundancy in commercial aircraft usually extends beyond this point to enable an airplane to continue scheduled operations despite one or more functional failures. In fact, dispatch reliability is now a competitive design feature. As a result of these design practices, equipment designers have, in effect, ensured that operating safety has the least possible dependence on scheduled maintenance — although this dependence still exists for a small number of failure modes.

The gradual recognition that safety and reliability were no longer synonymous in the case of aircraft led to a general questioning of traditional maintenance practices on economic grounds. These questions were given impetus by the fact that certain types of failures were not being prevented even by the most intensive application of these prac-

tices. Consequently a number of studies were conducted in the late 1950s to identify the actual relationship between overhaul times and reliability. The results necessitated a rejection of the simple belief that every item had a right overhaul time, and the focus changed to the development of alternative approaches, which eventually culminated in the present form of RCM analysis as a basis for determining maintenance requirements. This appendix describes the more important programs that were implemented during this evolutionary period, along with some of the studies that led to the abandonment of traditional hard-time policies in the commercial-aircraft industry.

B-1 THE HARD-TIME PARADOX

The Federal Aviation Regulations governing the maintenance and operation of commercial aircraft still embody the traditional concept that the length of time between successive overhauls is an important factor in operating safety. The Federal Aviation Act of 1958 empowered the Secretary of Transportation to prescribe and revise from time to time "reasonable rules and regulations governing, *in the interest of safety*, . . . the periods for, and the manner in which, . . . inspection, servicing, and overhauls shall be made." This wording is still in effect.* More specifically, Federal Aviation Regulation 121.25, revised in 1973, requires

*Title VI, Safety Regulation of Civil Aeronautics, *Aeronautical Statutes*, sec. 601(a)(3).

that all commercial air carriers formally institute "time limitations, or standards for determining time limitations, for overhauls, inspections, and checks of airframes, engines, propellers, appliances and emergency equipment."

Besides the regulations proper, the FAA also provides guidelines in the form of advisory circulars, intended to facilitate application of the regulations. According to Advisory Circular 121-1A, issued in June 1978, "for those aircraft not listed in AC 121-1A or an MRB document, the basic principle followed by the Administrator will be that the inspections, checks, maintenance, or overhaul be performed at times well within the expected or proven service life of each component of the aircraft."* The interesting point about these regulations and guidelines is that they are still the official form, even though most airlines today receive full approval of maintenance programs that have little to do with the traditional frame of reference implied by the rules.

Under these circumstances, however, it is not surprising that the initial scheduled-maintenance program for the Douglas DC-8, authorized in 1959 by the FAA Maintenance Review Board, established hard-time overhauls for 339 items, in addition to scheduled overhauls for the engine and for the airplane as a whole. The objective of the program-development team was to establish overhaul times which were "well within the expected or proven service life of each component of the aircraft." It is interesting to examine the human capability of achieving this objective as it was interpreted then.

Exhibit B.1 shows the actual failure rates, plotted as a function of the initial overhaul times, for the 55 items on the DC-8 which experienced the highest numbers of premature removals. The data are separated to differentiate between electronic and nonelectronic items, but in either case there was evidently little success in associating an initial interval with the failure rate that would be experienced, and hence ensuring that overhaul occurred within the service life of the item. The curve shows, for any given failure rate, the age at which only 10 percent of the units would survive if the age-reliability relationship were exponential.

Because of the difficulty in predicting the expected right overhaul time for each item, overhaul intervals on a new type of airplane were set at relatively low ages and were increased only with great caution. The FAA required at least three months between successive increases, but most airlines in fact permitted much longer periods of time to elapse. And when intervals were extended, the amount of increase was very small. The FAA also limited any increase in powerplant overhaul times, for example, to no more than 100 hours over the previous limit. The

**Standard Operations Specifications: Aircraft Maintenance Handbook*, FAA Advisory Circular 121-1A, June 1978.

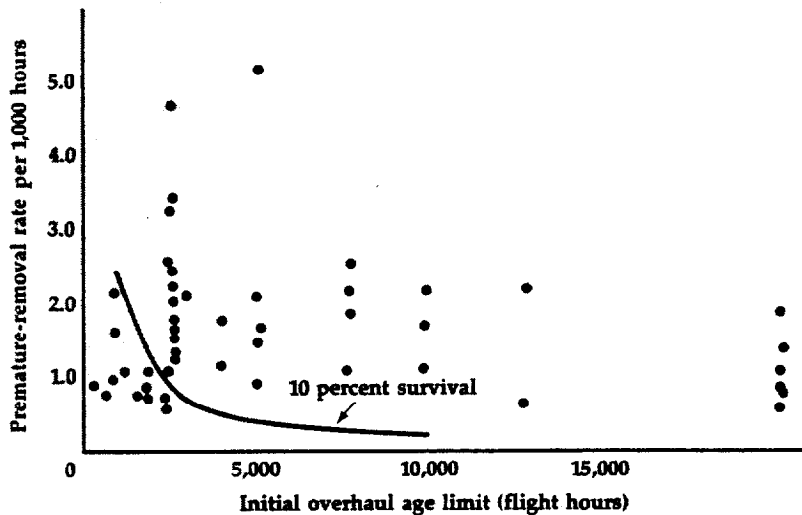

EXHIBIT B-1 Premature-removal rates of systems items on the Douglas DC-8, plotted against the overhaul limit assigned to each item in the initial maintenance program. The data points in color are for electronic items and those in black are for nonelectronic items. The curve represents the failure rate at which 10 percent of the units (both electronic and nonelectronic) would survive to a given age limit. (United Airlines)

basis for extending the overhaul limits was a complete teardown inspection of a number of serviceable items that had reached the current age limit and an evaluation of the condition of each part to judge whether it could have continued to operate to the proposed new age limit.

While this procedure might at first seem similar to an on-condition process, note that in most cases there was no means of meeting the criteria of applicability for an on-condition inspection:

- ▶ It must be possible to detect reduced failure resistance for a specific failure mode.
- ▶ It must be possible to define a potential-failure condition that can be detected by an explicit task.
- ▶ There must be a reasonably consistent age interval between the time of potential failure and the time of functional failure.

Since the teardown-inspection findings provided no objective basis for extending overhaul intervals, the continued viability of the item was tested by monitoring the failure rates and failure modes at the new limit

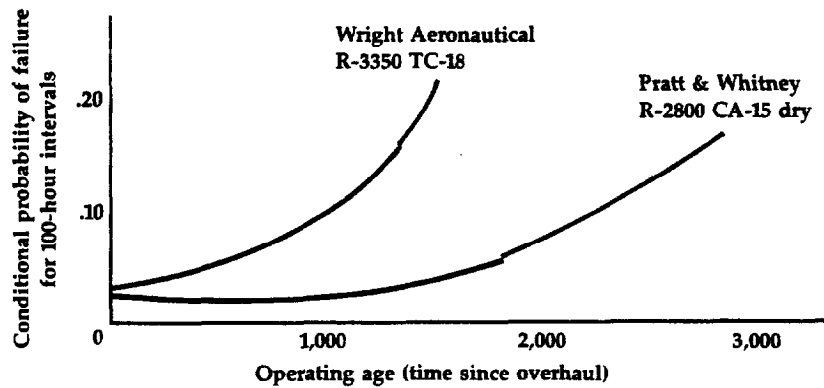

EXHIBIT B-2 Age-reliability analyses of two types of reciprocating aircraft engines which illustrate the difficulty in interpreting teardown-inspection findings. Inspection reports were favorable for the Wright R-3350 and unfavorable for the Pratt & Whitney R-2800. The red portion of the curves represents analyses performed in the spring of 1959, and the black portion represents subsequent analyses performed in 1963. (United Airlines)

to ensure that the extension had not adversely affected reliability—and then the cycle was repeated. The assumption was that this process of incremental time extensions would ultimately identify the correct overhaul age.

This procedure also led to some perplexing situations. In the spring of 1959 extension of the overhaul limit for two different types of reciprocating aircraft engines was under consideration. One engine, the Wright R-3350 TC 18, had a high enough failure rate that very few engines survived to the current overhaul limit of 1,300 hours; consequently it was difficult to obtain time-expired sample engines for the teardown inspections. Nevertheless, the opinion of the inspection team was that the parts of those engines that had survived to the limit were in very good condition, and that these particular engines could have continued in operation to much higher ages without experiencing failures. On this basis the team recommended that the overhaul limit be extended. It was apparent, however, that the time extension would be of little economic benefit, since even fewer engines would survive to the new limit.

The other engine, the Pratt & Whitney R-2800 CA 15, had a low failure rate. Hence a large number of engines had survived to the current overhaul time of 1,800 hours, and it was relatively easy to obtain time-expired sample engines for the teardown inspections. In this case, however, the same inspection team judged many of the parts to be in poor

enough condition that the sample engines could not have operated to the proposed new overhaul limit without experiencing failures. The inspection team therefore recommended against extending the limit for this engine. The time extension would have high economic value, however, if the opinion concerning increased likelihood of failure proved incorrect, since so many engines were surviving to the current limit.

Actuarial analyses were performed to determine the age-reliability characteristics of both types of engines; the results of these analyses are shown by the red portion of the curves in Exhibit B.2. Note that the opinions expressed by the inspection team are equivalent to a contention (1) that the conditional probability of failure for the first engine will show a marked decrease at ages greater than the current limit, and (2) that the conditional probability of failure for the second engine will show an abrupt increase at ages greater than the current limit. The reliability analysts argued that abrupt changes in age-reliability characteristics were unlikely to occur, and the overhaul times of both engines were extended.

The black portion of the curves in Exhibit B.2 shows the results of analyses made in March 1963, after the overhaul times of both engines had been extended well beyond those that existed when the conflict between the inspection findings and the actuarial findings first became apparent. The overhaul time of the Pratt & Whitney R-2800 was ultimately extended to 3,300 hours, with substantial economic benefits, despite adverse inspection reports at each step. Since the inspection team consisted of skilled people, familiar both with the items in question and with airline maintenance processes, this contradiction of their findings by actuarial analysis has continued to be a paradox.

The FAA's last determined effort to control operating reliability by adjustment of hard-time overhaul limits was in August 1960, when it issued the Turbine Engine Time Control Program. In this case the basis for adjustment of overhaul limits was the in-flight engine-shutdown rate experienced by the operating airline, rather than the recommendation of an inspection team. The adjustment of overhaul intervals was related to the shutdown rate for the preceding three-month period as follows:

<i>shutdown rate</i> <i>(per 1,000 engine hours)</i>	<i>overhaul-time adjustment</i>
Greater than 0.20	100-hour reduction
0.15-0.20	No adjustment
0.10-0.15	100-hour extension
Less than 0.10	200-hour extension

This program elicited strong negative reaction from the airlines, since the basis for adjustment was highly sensitive to variations in the shut-down rate caused by sampling effects and did not provide for engine shutdowns due to the failures of accessories which were not part of the basic engine. The program was short-lived.

B·2 CHANGING PERCEPTIONS OF THE HARD-TIME POLICY

By the late 1950s sufficient operating data had accumulated for intensive studies of the effectiveness of prevailing scheduled-maintenance methods. These studies brought several important facts to light:

- ▶ It was beyond human capability to set an initial overhaul time that would be well within the proven service life of an item.
- ▶ When the likelihood of failure did increase with age, the reports from teardown inspections often conflicted with the results of actuarial analysis. The teardown inspections were apparently unable to identify failure resistance in a discriminating manner.
- ▶ There were many items for which the likelihood of failure did not increase with operating age, and hard-time limits had no effect on reliability in these cases.

A better method of determining scheduled-maintenance requirements was clearly needed.

During the same period the FAA and the airlines were expressing continuing concern about the high failure rate of the Wright R-3350 engine and the fact that various changes in maintenance policy had resulted in no significant improvement in its reliability. This situation, and the general need for an improved overhaul-time policy for aircraft turbine engines, led to the formation in 1960 of a task force, with representatives from both the FAA and the Air Transport Association. This team was charged with the responsibility of obtaining a better understanding of the relationship between overhaul policy and operating reliability.

The result of this study was the *FAA/Industry Reliability Program*, issued in November 1961. The introduction to this publication stated the objective of the program as follows:*

The development of this program is toward the control of reliability through an analysis of the factors that affect reliability and provide a system of actions to improve low reliability levels when they

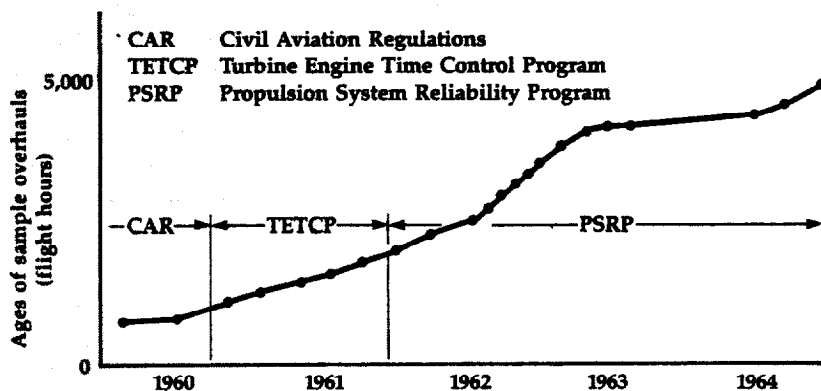

EXHIBIT B-3 The effect of changing overhaul policies on the rate of interval extension for the Pratt & Whitney JT4 engine. The Propulsion System Reliability Program, authorized in November 1961, represented the first significant change in the emphasis on overhaul intervals, although it still presupposed a relationship between scheduled overhaul and reliability. (United Airlines)

exist. In the past, a great deal of emphasis has been placed on the control of overhaul periods to provide a satisfactory level of reliability. After careful study, the Committee is convinced that reliability and overhaul time control are not necessarily directly associated topics; therefore, these subjects are dealt with separately. Because the propulsion system has been the area of greatest concern in the recent past, and due to powerplant data being more readily available for study, programs are being developed for the propulsion system first, as only one system at a time can be successfully worked out.

The publication authorized a trial period for a new Propulsion System Reliability Program which established a shutdown-alert rate for each type of engine. If an airline experienced a shutdown rate that exceeded the alert value, an investigation was required to determine the reasons, and action appropriate to the results of the investigation was to be taken. There was no requirement, however, that overhaul times be either reduced or not extended further, unless the investigation indicated this action as a remedy. Teardown inspections were also restored as the basis for extending overhaul times. The number of time-extension samples was a function of fleet size and ranged from a sample of 1 for

a fleet of four or fewer operating units to a sample of 6 for 101 or more operating units. The requirement of a minimum calendar period between successive extensions was eliminated. This last change greatly increased the rate of overhaul-time extension (see Exhibit B.3) and lowered maintenance costs by reducing the number of engines in the overhaul process.

It had already been recognized that each type of engine had a group of short-lived parts that could not survive through the entire scheduled-overhaul interval. The trial program therefore provided for monitoring of some of these parts by on-condition inspections, with replacement of deteriorated parts as necessary. The other short-lived parts were to be replaced at a scheduled "engine heavy maintenance" (hot-section) visit. The limit on the heavy-maintenance interval was imposed by the shortest-lived part that depended on this shop visit for maintenance action. The limit was increased as improved parts were developed. Again, each increase was based on the condition of a sample of time-expired engines. The requirement for scheduled engine heavy maintenance was abandoned altogether in 1972 in favor of scheduled rework or discard tasks where applicable and effective for specified individual engine parts.

The trial Propulsion System Reliability Program, which later became a permanent program, represented a significant weakening of the traditional emphasis on hard-time overhauls as a major factor in engine reliability. This program was legally enabled by the clause in the regulations covering "time limitations or standards for determining time limitations" — the same clause that had been used earlier to promulgate the short-lived Turbine Engine Time Control Program. At the time the Propulsion System Reliability Program was instituted it was still assumed that a "right" overhaul time would ultimately be identified for each type of engine.

After work on the powerplant program was finished there was no agreement among the industry members of the task force concerning the type of item that should be investigated next. Consequently the FAA permitted each of the airlines represented on the task force to develop and implement test programs for those items in which it was most interested. United Airlines chose to develop a Component Reliability Program for complex mechanical items which had previously been assumed to be among the best candidates for hard-time overhaul. This program was initiated in February 1963 and was at first applied to six items: the cabin compressor, the constant-speed drive, and freon compressor on the Douglas DC-8 and similar items on the Boeing 720.

The components program also presupposed that each item had an optimum overhaul time, and the objective was simply to identify this limit in the shortest possible calendar time with a minimum cost for interim scheduled overhauls. The test program was designed to demon-

EXHIBIT B-4 Experience with three systems items on the Douglas DC-8 under the Component Reliability Program and later programs. Premature-removal rates are per 1,000 operating hours. (United Airlines)

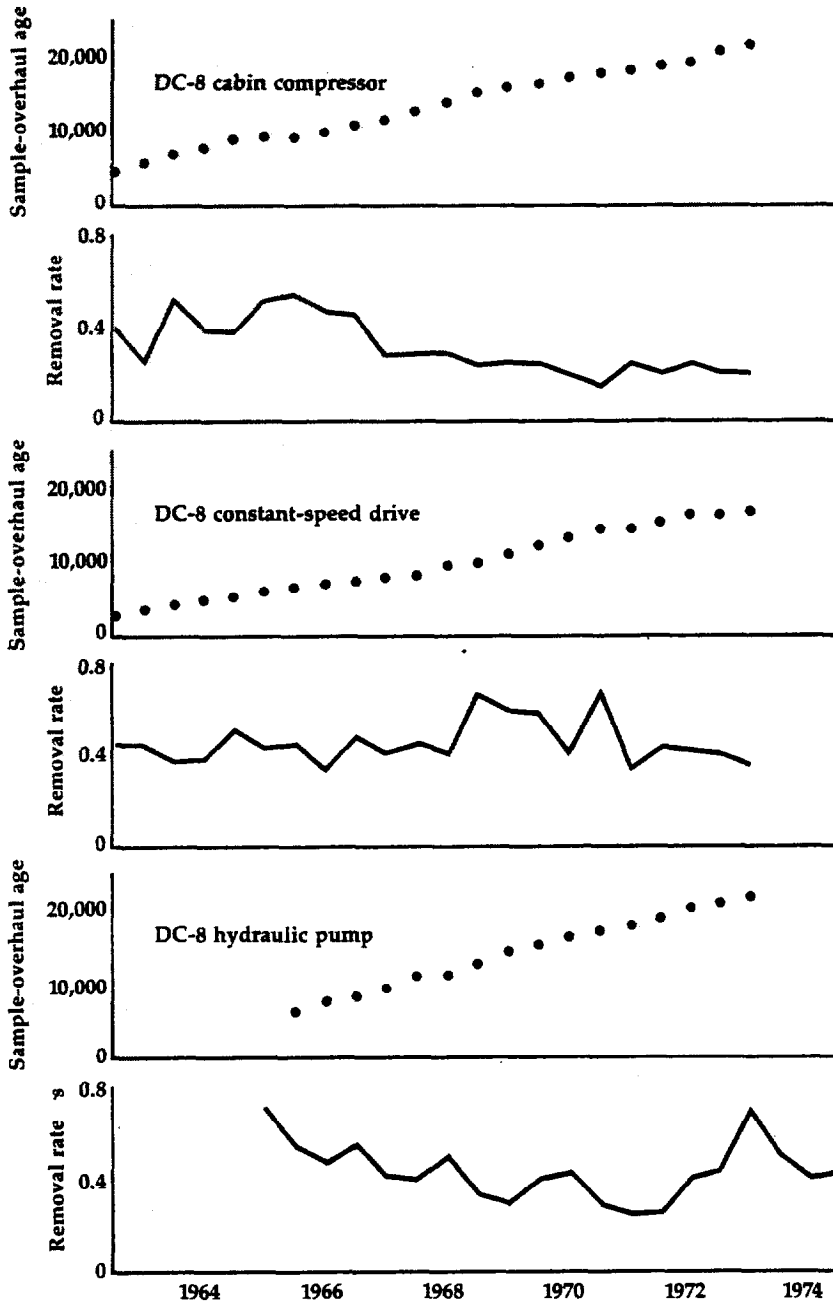

strate that reliability could be controlled in the absence of fixed overhaul times while the final right time was being sought. On this basis particular attention was paid to the following factors:

- ▶ The age-reliability characteristics of the items as determined by actuarial analysis
- ▶ New and undesirable failure modes that might appear at higher ages
- ▶ The total support cost for the item
- ▶ The results of a limited teardown inspection of a small number of high-time units

There were no overhaul limits as such, and other units were permitted to continue aging in service while the sample units were being inspected. As a result, inspection data accumulated rapidly and continually for successive age intervals. Moreover, despite the continuous increases in the age of sample overhauls, as illustrated in Exhibit B.4, there was no reduction in the reliability of the components under this program.

The experience with the trial programs conducted by the various airlines prompted the FAA to issue Advisory Circular 120-17, a *Handbook for Maintenance Control by Reliability Methods*, in December 1964. The purpose of this document was stated as follows:*

This handbook provides information and guidance material which may be used to design or develop maintenance reliability programs which include a standard for determining time limitations. . . . It is, in addition, a method to realistically and responsively relate operating experience to the controls established.

With reference to the test programs, the circular went on to say:

The purpose of these studies is to acquire, through practical application, information that could be used to amend and refine our present system of monitoring operator's maintenance quality and yet permit the operator maximum flexibility in establishing its own maintenance controls within the bounds of generally accepted maintenance philosophies.

United Airlines moved quickly to qualify reliability programs for various types of items, because the reduced scheduled-maintenance workload under the test programs had not resulted in any reduction in reliability. The residual maintenance workload was still large enough, however, to warrant further attention. In January 1965 United qualified

**Handbook for Maintenance Control by Reliability Methods*, FAA Advisory Circular 120-17, December 31, 1964.

its Turbine Engine Reliability Program under the terms of Advisory Circular 120-17. This program was similar to the Component Reliability Program, but there was a less demanding sample-overhaul requirement of one engine per 10,000 hours of operating experience. This requirement was changed from time to time in the next few years until, in 1968, the requirement for sample overhauls was eliminated entirely. The history of the increase in the sample-overhaul time limit shown in Exhibit B.5 is typical of the pattern for turbine engines during that period.

In addition to the requirement for sample overhauls as a basis for extending the engine overhaul limit, the turbine-engine program included a scheduled shop visit for engine heavy maintenance, with time extensions for this interval accomplished by a process similar to that specified in the Propulsion System Reliability Program. There were also scheduled tasks to replace specific time-limited parts whose failure could have a direct adverse effect on operating safety. The need for these scheduled discard tasks has continued regardless of other changes in maintenance theory.

The Turbine Engine Reliability Program, with revisions, continued in successful operation until 1972, when it was replaced with United

EXHIBIT B-5 The history of sample-overhaul requirements for the Pratt & Whitney JT4 engine under successive test programs. The Turbine Engine Reliability Program, authorized in January 1965, continued successfully without the sample-overhaul requirement until it was replaced in 1972 by current reliability-centered programs. (United Airlines)

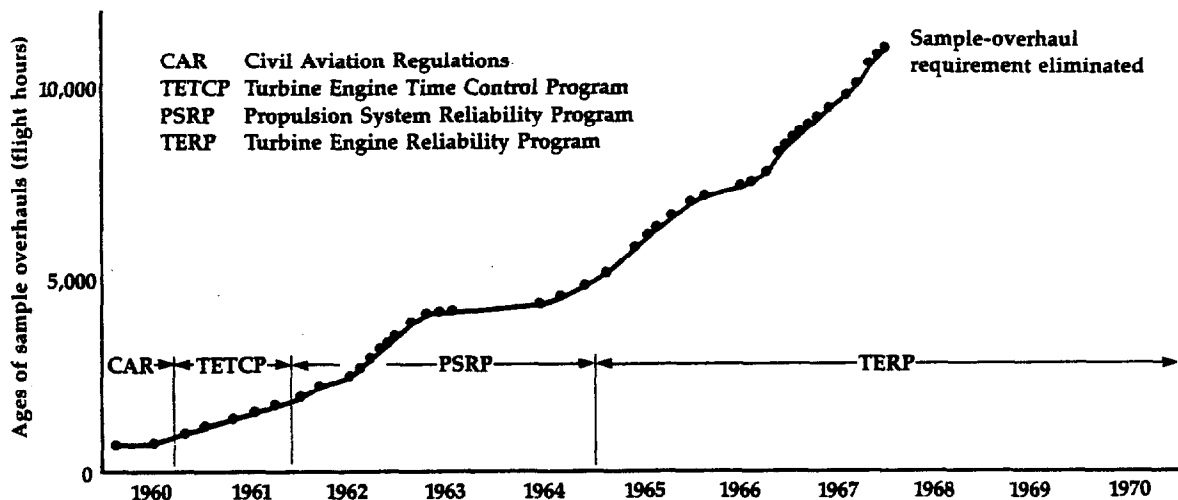

Airlines' current program, called Logical Information Based on Reliability Analysis (LIBRA), which embodies decision logic. A permanent and expanded Component Reliability Program also continued in operation, with only minor changes, until the current program was established in 1972. By 1969 there were 20 items under this components program. Not all of them are still in service, but the ages of most of the items that are in service are still being permitted to increase. The rate of increase is now quite small, since few units survive to the maximum ages that have been experienced without the need for repair work which is sufficiently extensive to zero-time the unit. The operating experience illustrated in Exhibit B.4 is typical of the pattern for such items.

In June 1965 United Airlines obtained approval to implement a permanent Reliability Controlled Overhaul Program (RCOH). This program in fact dated back to April 1958, but its use had been restricted to a small number of items. Items covered by this program were not subject to any overhaul time limits at all; consequently there were no sample-overhaul requirements. An item qualified for the program if actuarial analysis demonstrated that the conditional probability of failure did not increase with increased time since the last shop visit. In other words, the item had to show an age-reliability relationship represented by curve *D*, *E*, or *F* in Exhibit 2.13, indicating that it could not benefit from scheduled overhaul. The program did require that an alert failure rate, based on past operating history, be established for each item and that a fact-finding investigation be conducted whenever the failure rate exceeded the specified value. It was found, however, that most excursions above the alert rate were associated with sampling effects, and not with changes in age-reliability characteristics. By 1969 this program covered 277 items from various types of airplanes. These items included many mechanical and electromechanical assemblies, although most were electronic components. This program also continued in successful operation until it was replaced in 1972 by the current program.

During the course of both the Turbine Engine Reliability Program and the Component Reliability Program there was a rapid escalation of overhaul age limits and a continuing reduction in the number of sample overhauls required at each limit. Wherever there might have been a slight increase in the failure rate as units reached higher ages, its effects were more than offset by the results of product-improvement activity. In the process numerous age-reliability relationships were defined. They showed no pronounced wearout characteristics for the components, and much of the wearout evident in the premature-removal rates for engines was the result of on-condition inspections, not of functional failures. Finally in 1972 the practice of a scheduled complete disassembly for inspection, followed by an overhaul, was discontinued entirely in both programs. The Reliability Controlled Overhaul Program had never required sample overhauls and relied instead on the results of actuarial

analysis. Note that all these programs were based on information that had to be derived from operating experience.

B·3 THE INTRODUCTION OF ON-CONDITION MAINTENANCE

The testing of new concepts in the early 1960s was not limited to a search for the best way to identify optimum overhaul limits. In 1962 the overhaul concept itself was challenged. Traditional overhauls entailed complete disassembly and remanufacture, and a shop visit which entailed less work than this was classified as a repair and was not considered to zero-time the operating age of the unit. Serviceable units returned to the supply organization after such a repair were classified as "part-time spares" to indicate that after they were installed, they could not remain on the airplane for a full overhaul interval.

To reduce the need for these early scheduled removals, a new concept of "conditional overhaul" was tested on several items. A conditional overhaul consisted of:

- ▶ Correction of the immediate cause of failure
- ▶ Such additional work, if any, as required to enable the unit to meet the functional performance specifications for the item
- ▶ Certain specified inspection and/or rework of known points of wear or deterioration

The operating performance of the units that received conditional overhauls was carefully monitored, and actuarial analyses of these units were compared with analyses of units that received the traditional complete overhauls to determine whether there were any undesirable differences in age-reliability characteristics. The only notable difference was that the units that had received conditional overhauls showed less infant mortality. Application of the conditional-overhaul concept grew, and by 1965 most of the items that were subject to overhaul limits were receiving conditional overhauls, and a conditional overhaul was considered to zero-time the unit. This approach resulted in a marked reduction in shop maintenance costs with no adverse effect on reliability.

Another new concept introduced during this period was United Airlines' Test and Replace as Necessary Program (TARAN), which was approved in January 1964 for the Boeing 720 hydraulic system. Up to this point many items in the hydraulic system had individual overhaul limits, frequently timed to coincide with the overhaul age for the airplane itself. This program depended instead on on-condition tasks. It consisted of a schedule of tests to be performed prior to this major airplane overhaul to determine whether there were internal leaks, an indication of reduced failure resistance, in the hydraulic subsystems

and assemblies. Only those units that failed the tests were removed and routed to the shop for overhaul (repair). By 1969 United Airlines had qualified 209 items on various types of airplanes under this on-condition program.

Several facts had become apparent as a result of all these new programs:

- ▶ The reliability programs that had been developed and implemented to "realistically and responsively relate operating experience to the maintenance controls established" had demonstrated that hard-time overhaul actions were of no benefit whatsoever in controlling the reliability of most items—that is, most items had no "right" overhaul times.
- ▶ Actuarial analysis provided a means of determining the age-reliability characteristics of flight equipment and controlling operating reliability in the absence of fixed overhaul limits.
- ▶ Conditional overhauls were at least as effective for most items as the overhauls carried out under traditional concepts.
- ▶ Reliability programs achieved a major portion of the economic gains that could be realized by elimination of those scheduled-maintenance tasks that were ineffective.
- ▶ Administration of a large number of individual reliability programs was a burdensome procedure.

It was clearly time for something more than a piecemeal approach. It was now necessary to consolidate the existing knowledge and develop a technique by which:

- ▶ An effective scheduled-maintenance program could be designed before a new type of airplane entered service
- ▶ This program could be modified after the airplane was in service and reliability information from actual operating data was available

The first attempt at a decision-diagram approach to the development of scheduled-maintenance programs was made in 1965, and by 1967 a workable technique had been developed and described in professional papers.*

*H. N. Taylor and F. S. Nowlan, Turbine Engine Reliability Program, FAA Maintenance Symposium on Continued Reliability of Transport-type Aircraft Propulsion Systems, Washington, D.C., November 17–18, 1965. T. D. Matteson and F. S. Nowlan, Current Trends in Airline Maintenance Programs, AIAA Commercial Aircraft Design and Operations Meeting, Los Angeles, June 12–14, 1967. F. S. Nowlan, The Use of Decision Diagrams for Logical Analysis of Maintenance Programs, United Airlines internal document, August 2, 1967.

Also in 1967, the initial program for the new Boeing 737 incorporated a procedure called System and Component Operating Performance Evaluation (SCOPE).^{*} This procedure was applicable to classes of items which had been found historically to have no marked age-reliability relationships. The program provided for a two-year period free of any overhaul limits. During this period the performance of each item was to be monitored, and from then on its performance was to be compared with standards based on the item's operation during those two years. An item that did not meet the standard of its previous performance— one whose failure rate might be increasing with age— was then to be investigated, and action was to be taken, if feasible, to improve its reliability. The investigation might include actuarial analyses for specific items that failed to meet the performance standards if an operating airline chose to conduct such studies. However, no actuarial studies were required to qualify an item for exclusion from overhaul limits in an initial program.

This program represented the first recognition in an initial program that certain items do not benefit from scheduled maintenance (later such items would be said to be supported by condition monitoring). The program covered 49 items that would have been assigned hard-time overhaul limits under previous maintenance approaches.

B·4 THE AIR TRANSPORT ASSOCIATION MSG-1 AND MSG-2 PROGRAMS

By 1968, when the initial scheduled-maintenance program for the new Boeing 747 was developed, there had been further developments. There was general recognition of three primary maintenance processes— hard-time overhaul, an on-condition process, and a condition-monitoring process. The conditions that must be met for each of these processes to be applicable had been clearly defined, and there was a workable decision diagram that could be used to develop a scheduled-maintenance program that encompassed these three primary processes.

The FAA had indicated an interest in working with the airline customers of the Boeing 747 to apply a newer and more modern technique to the development of the initial maintenance program for this airplane. Accordingly, a group of the airline representatives on the 747 Maintenance Steering Group drafted MSG-1, *Handbook: Maintenance Evaluation and Program Development*. This document, issued in July 1968, was used

^{*}*Federal Aviation Administration Maintenance Review Board Report, app. A, Boeing 737 Maintenance Program, October 1967.*

by special teams of industry and FAA personnel to develop the new Boeing 747 program. As described by the FAA in a later publication, these teams*

. . . sorted out the potential maintenance tasks and then evaluated them to determine which must be done for operating safety or essential hidden function protection. The remaining potential tasks were evaluated to determine whether they are economically useful. These procedures provide a systematic review of the aircraft design so that, in the absence of real experience, the best [maintenance] process can be utilized for each component or system.

The Boeing 747 maintenance program was the first attempt to apply RCM concepts.

Actual work with MSG-1 identified many areas in which the document could be improved, and in March 1970 the Air Transport Association issued *MSG-2: Airline/Manufacturer Maintenance Program Planning Document*. This document, which included further refinement of the decision-diagram approach, was used to develop the initial maintenance programs for the Lockheed 1011 and the Douglas DC-10. A similar document, entitled *European Maintenance System Guide*, was prepared in Europe and served as the basis for development of the initial programs for the Airbus Industrie A-300 and the Concorde. The impact of MSG-1 and MSG-2 on the resulting programs is apparent from the number of items assigned scheduled removal tasks—eight on the Boeing 747 and seven on the Douglas DC-10, in contrast to 339 in the earlier program for the Douglas DC-8.

In 1972 MSG-2 was used to develop reliability programs for all the older fleets of airplanes operated by United Airlines. These individual programs were implemented by the single program LIBRA, which replaced all the earlier reliability programs that had been developed on a piecemeal basis for these aircraft. However, MSG-2 focused primarily on the tasks that should be included in an initial program and provided little guidance on other aspects of the decision-making process, such as the identification of significant items and the use of operating data in modifying the initial program. The next step, therefore, was further refinement of the decision-diagram technique to clarify the role of failure consequences in establishing maintenance requirements, the role of hidden-function failures in a sequence of multiple failures, and the concept of default answers to be used as the basis for decisions in the absence of the necessary information. The result was the technique of RCM analysis described in this volume.

**Federal Aviation Administration Certification Procedures*, Federal Aviation Administration, May 19, 1972, par. 3036.

B·5 THE RELATIONSHIP OF SCHEDULED MAINTENANCE TO OPERATING SAFETY

The traditional view of scheduled maintenance was that it must, of necessity, increase operating safety, and therefore the more intensive the maintenance, the safer an aircraft would be. It is quite possible, of course, for the loss of an essential function or the secondary damage caused by certain failure modes to have a direct effect on safety. Whether this is the situation in specific cases, however, depends on the design characteristics of both the item and the equipment in which it is installed.

Since complex high-performance equipment is by nature subject to failures, a major safety consideration is to ensure that it will be failure-tolerant (damage-tolerant). While the basic forms of preventive maintenance can very often prevent failures caused by specific failure modes, they are not as successful in reducing the overall failure rate of complex items subject to many different types of failure. Fortunately most critical failures can be prevented at the design stage by the use of redundancy to protect against the complete loss of an essential function. Where a specific failure mode can cause critical secondary damage, and this possibility cannot be eliminated by modifying the design, there are two preventive tasks that can be used to ensure safety: on-condition inspections, where they are applicable and effective, and discard of the part in question at a predetermined safe-life limit. In both cases these tasks are directed at the individual part in which the critical failure mode originates. Thus scheduled maintenance can ensure realization of the inherent safety levels of the equipment, but it cannot compensate for deficiencies in those levels.

The process of RCM analysis consists of a detailed study of the design characteristics of the equipment to determine the items whose loss of function would have significant consequences at the equipment level, as well as the specific failure modes most likely to lead to that loss of function. This study identifies the failures and failure modes that are critical—those which could have a direct effect on operating safety. It also identifies those failures which will be hidden and therefore represent a loss of protection that might at some later time affect operating safety. We then examine the various forms of preventive maintenance at our disposal to determine which scheduled tasks are essential and must be included in the program to prevent critical failures. This examination also tells us which tasks are likely to accomplish this objective—that is, what tasks can prevent all failures and what tasks can merely reduce the failure frequency.

Modern transport aircraft are subject to very few critical failure modes because the design requirements of the FAA, as well as the

specifications of operating organizations and manufacturers, have been adjusted repeatedly over the years to overcome safety problems inherent in the design as soon as they became apparent. In the process, however, equipment has become more complex, and therefore subject to a greater number of failures that do not affect safety. Current thinking on the relationship between safety and scheduled maintenance can thus be summarized as follows:

- ▶ Failures are inevitable in complex equipment and can never be entirely prevented by scheduled maintenance.
- ▶ Reliability can usually be dissociated from safety by the design features of the equipment.
- ▶ A failure is critical only if loss of the function in question has a direct adverse effect on operating safety *or* if the failure mode that causes a loss of function also causes critical secondary damage. Because of this second condition, an item can have a critical failure mode even when the loss of its function is not critical.
- ▶ It is possible to design equipment so that very few of its failures or failure modes will be critical.
- ▶ In the few cases in which critical failure modes cannot be overcome by design, on-condition tasks and safe-life discard tasks can make the likelihood of a critical failure extremely remote.
- ▶ Scheduled overhaul has little or no effect on the reliability of complex items. Rework tasks directed at specific failure modes can reduce the frequency of failures resulting from those failure modes, but the residual failure rate will still represent an unacceptable risk. Consequently scheduled rework is not effective protection against critical failures.
- ▶ The technique of RCM analysis explicitly identifies those scheduled tasks which are essential either to prevent critical failures *or* to protect against the possible consequences of a hidden failure.
- ▶ Scheduled-maintenance tasks that do not relate to critical failures have no impact on operating safety. They do have an impact on operating costs, and their effectiveness must therefore be evaluated entirely in economic terms.

actuarial analysis

THE APPLICABILITY criteria for both scheduled rework tasks and economic-life tasks include two conditions which require the use of conditional-probability and survival curves derived from operating data:

- ▶ There must be an identifiable age at which the item shows a rapid increase in the conditional probability of failure.
- ▶ A large proportion of the units must survive to that age.

Both conditions, of course, relate to the question of what good an age limit might do. In this appendix we will consider the problems and methods involved in determining whether the failure behavior of an item satisfies these conditions. Although much of the computation is amenable to computer applications, the discussion here is confined to manual methods, both to illustrate the computational details and to indicate the areas in which certain graphical procedures have distinct advantages over most available computer methods.

The development of an age-reliability relationship, as expressed by a curve representing the conditional probability of failure, requires a considerable amount of data. When the failure is one that has serious consequences, this body of data will not exist, since preventive measures must, of necessity, be taken after the first or the first few failures. Thus actuarial analysis cannot be used to establish the age limits of greatest concern — those necessary to protect operating safety. In these cases we must rely instead on safe-life limits established on the basis of the manufacturer's test data. Fortunately safe-life items are single parts, and the ages at failure are grouped fairly closely about the average. However, the test data for long-lived parts are so scanty that we usually cannot associate them with any of the well-developed probability distributions. Thus a safe-life limit is established by dividing the test results by some conservatively large arbitrary factor, rather than by the tools of actuarial analysis.

The same limitation applies to failures that have serious operational consequences. The first occurrence of such a failure frequently requires an immediate decision about protective action, without waiting for the additional data necessary for an actuarial analysis. At the other end of the scale, there will usually be a large body of data available for those items whose failure has only minor consequences. Thus there is ample material for an actuarial analysis to determine whether an age limit would be applicable, but far less likelihood that it will meet the conditions for cost effectiveness. The chief use of actuarial analysis is for studying reliability problems in the middle range – those failures which, taken singly, have no overwhelming consequences, but whose cumulative effect can be an important cost consideration.

C·1 ANALYSIS OF LIFE-TEST DATA

Actuarial analysis is simplest when it is based on data obtained from a life test. In a life test a group of units of a given item begin operation simultaneously under identical operating conditions. Each unit is then permitted to operate until it either fails or reaches the age set as the termination age for the test. A life-test analysis conducted on a set of 50 newly installed engines will illustrate both the utility and the limitations of this approach. The test period in this case was 2,000 operating hours, and of the 50 units that started, 29 survived to the test-termination age, accumulating a total of 58,000 hours of operating experience. At various times during the test period, 21 units failed, and these failed units accumulated 18,076 hours of operating experience. The ages at failure are listed in Exhibit C.1 in order of increasing age at failure. It is important to note that each of the 50 engines had an *opportunity* to survive to 2,000 hours. Some did survive, whereas others failed at ages less than 2,000 hours.

Exhibit C.1 also shows the proportion of units surviving after each engine failure. The first engine failed at an age of 4 hours. The other 49 survived beyond that age. Thus 49/50, or 0.98, of the engines survived to an age greater than 4 hours. Similarly, 48/50, or 0.96, of the engines survived to an age greater than 33 hours. When the proportions surviving after the age of each failure are plotted on a graph, as shown in Exhibit C.2, a smooth curve drawn through the points provides a smooth estimate of the proportion that would survive—the probability of survival—at any interim age. This smooth curve can also be used to estimate the probability of survival in the population of engines from which the sample of 50 was selected.

While this freehand process is likely to result in slight differences in the smooth curves drawn by different analysts, the curve is always

EXHIBIT C-1 Life-test experience to 2,000 hours with 50 newly installed Pratt & Whitney JT8D-7 engines. (United Airlines)

number of units in test 50
 number of units surviving to 2,000 hours 29
 number of units failed before 2,000 hours 21

failure age of units that failed (hours)	proportion surviving beyond failure age	failure age of units that failed (hours)	proportion surviving beyond failure age
4	0.98	792	0.76
33	0.96	827	0.74
112	0.94	886	0.72
154	0.92	1,136	0.70
309	0.90	1,638	0.68
337	0.88	1,657	0.66
359	0.86	1,664	0.64
403	0.84	1,807	0.62
694	0.82	1,818	0.60
724	0.80	1,986	0.58
736	0.78	$\Sigma = 18,076$	

Operating experience of 29 surviving units = 58,000 hours

Operating experience of 21 failed units = 18,076 hours

Total operating experience all units = 76,076 hours

Failure rate = $21/76,076 = 0.276$ per 1,000 hours

Mean time between failures = $76,076/21 = 3,623$ hours

Average age at failure = $18,076/21 = 861$ hours

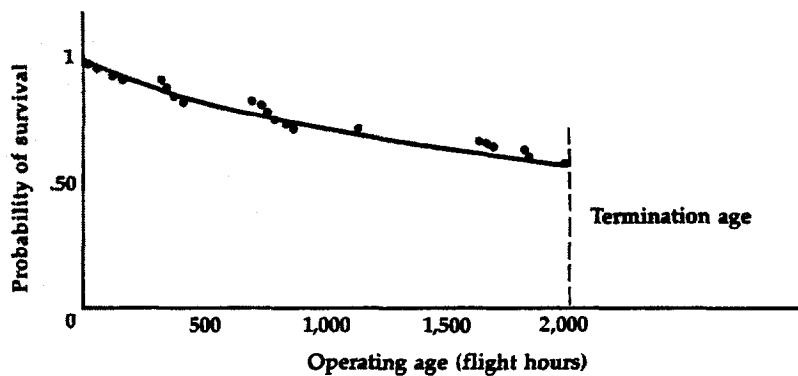

EXHIBIT C-2 A survival curve based on the life-test data in Exhibit C.1. (United Airlines)

constrained by the fact that the proportion surviving (and hence the probability of survival) cannot increase, so that by definition the first derivative must be negative. This condition is generally sufficient to force a high degree of conformity, at least in the curves drawn by experienced analysts.

In looking at life-test data there is sometimes a temptation to concentrate on the ages of the units that failed, instead of balancing the failure experience against the survival experience. For example, the test data in Exhibit C.1 show a mean time between failures of 3,623 operating hours, although the average age of the failed engines was only 861 hours. This large difference results from the test-termination age of 2,000 hours. If the test had run instead to a termination age of 3,000 hours, additional failures would have occurred at ages greater than 2,000 hours, making the average age at failure much higher; in contrast, the mean time between failures would not be much different. If the life test were permitted to continue until all 50 of the units failed, the average age at failure and the mean time between failures would, of course, be the same.

Caution must be exercised in using life-test failure rates as estimates of what might happen in the future. If maintenance practice required the replacement of all engines with new ones at the end of 2,000 hours, and if the units in the life test represented a random sample of the process that would supply the replacement units, then the failure rate of 0.276 per 1,000 operating hours would be an accurate prediction for the engine in Exhibit C.1. However, it is far more likely that expensive complex items will receive extensive corrective maintenance, and a repaired unit may or may not exhibit precisely the same failure rate as a new one. Moreover, as dominant failure modes are identified and

corrected, the overall failure rate would be expected to drop. There would also be little point in removing the units that survived the life test from service unless there were strong evidence that removal at that age would result in some overall gain, such as a lower failure rate. Thus the failure rate for a life test tells us little more than the simple fact that there were x failures for the number of hours of experience covered by the test.

The life-test approach has certain disadvantages in an operational setting. Usually it is not possible to select the test units as a random sample of the population, since the objective of the test is to obtain information as soon as possible. This means that the study will ordinarily be based on the first units to enter service. Also, it cannot be terminated until each of the selected units has reached the specified age — that is, until the last unit installed has reached the test-termination age. The analysis can be advanced, of course, either by reducing the number of units in the study or by reducing the length of the test period. Reducing the number of units covered increases the likelihood of being misled by sampling effects. Reducing the termination age for the test results in disregarding part of the available information — the actual experience at ages greater than the test-termination age.

EXHIBIT C-3 An example of the information excluded by life-test data. Although information is available on unit 4, which replaced failed unit 2, this unit will not have aged to 2,000 hours by the termination age, and hence cannot be taken into account.

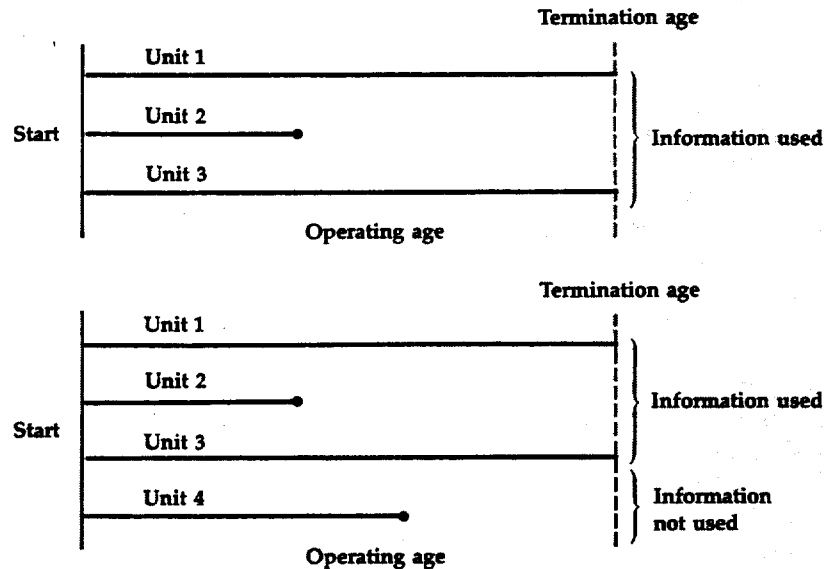

Exhibit C.3 illustrates another reason that certain available information cannot be used if operating data are used to simulate a life test. Suppose units 1 and 3 survive to the test-termination age, and unit 2 fails. In actual operations this failed unit will be replaced by unit 4, which will age in service but will not have reached 2,000 hours by the time units 1 and 3 reach the termination age. Thus, although the experience of unit 4 is available, it cannot be considered in a life-test format. The fact that this type of analysis does not permit us to use all the available information is sufficient reason in itself to consider other methods of analysis that do not have this shortcoming.

Life-test analysis has one further shortcoming from the standpoint of an operating organization. If there are reliability problems, the operator will initiate product-improvement programs and is interested in determining as quickly as possible whether such programs are successful. This interest may be as great as the interest in age-reliability relationships as such. For this reason procedures for analysis have been developed which use operating data derived from experience over a relatively short calendar period.

C·2 ANALYSIS OF DATA FROM A DEFINED CALENDAR PERIOD

The first step in analyzing operating data over a defined calendar period is to define the length of the period. The choice of an appropriate study period is always a compromise between two factors. On the one hand, a short period is desirable to expedite decision making and to minimize the effects of changes in the character of the units and the external environment. On the other hand, a short period limits the amount of operating experience and failure data that can be considered. The relative magnitude of sampling effects is a function of the number of failures and increases as the number of failures decreases. Experience suggests that the calendar period selected for any item should be long enough to include at least 20 failure events.

Once the period has been defined, the following data must be obtained:

- ▶ The age and identity of each unit of an item that was in operation at the beginning of the calendar period
- ▶ The age and identity of each unit of an item that was still in operation at the end of the calendar period
- ▶ The age and identity of each unit that was removed from operation during the calendar period and the reason for removal (failure of this unit or removal for some other reason)

- The age and identity of each replacement unit that was installed during the calendar period

Notice the emphasis on unit identification. Reliability analysis is greatly facilitated by giving each unit a unique serial number. Exhibit C.4 describes the operating history of seven such units over a three-month calendar period. The same information is displayed in Exhibit C.5. Each horizontal line in the first graph represents a unit's operating position on a piece of equipment. If the history for all units were plotted, an installation would follow the removal of unit 5810 on May 4. Similarly, a removal would precede the installation of unit 5880 on May 27—unless that line represented equipment that first entered service on that date. Lack of continuity on any line is an indication that unit life histories are missing. The second graph shows the relationship between events and the operating ages of the units.

Briefly, then, what happens during a fixed calendar period is this: A certain number of units, of varying ages, enter the study period in service; these units build up time, with some continuing in operation over the entire period and others being withdrawn from service, either because they have failed or for some other reason. New units enter service to replace the ones that have been removed, and these new units also accumulate operating experience during that time; some of these may also be removed before the end of the calendar period and replaced, in turn, by other new units. From this picture we want to

EXHIBIT C-4 Operating history of seven units from May 1 to July 31, 1974. (United Airlines)

serial number	date on	date off	reason off	age, 5/1/74	age on	age off	age, 7/31/74
5072	4/23/74	—	—	34	—	—	522
5810	12/17/72	5/4/74	NF*	2,441	—	2,447	—
5974	8/19/73	—	—	1,251	—	—	1,707
5880	5/27/74	6/29/74	F†	—	0	154	—
6031	7/7/74	—	—	—	0	—	127
5827	3/18/74	—	—	167	—	—	607
6026	12/15/73	—	—	639	—	—	1,095

*Removal for reasons not associated with a failure.

†Removal because of a failure.

EXHIBIT C-5 Operating history of the seven units in Exhibit C.4 shown as a function of calendar time (top) and as a function of operating age (bottom). (United Airlines)

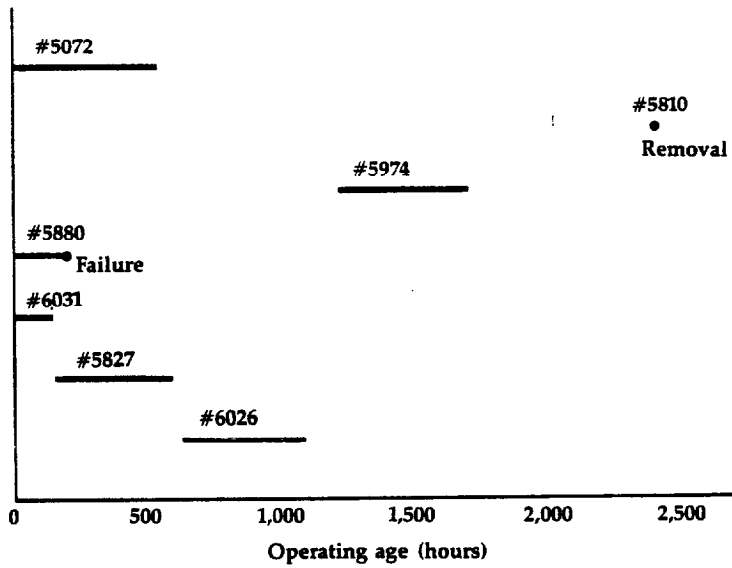
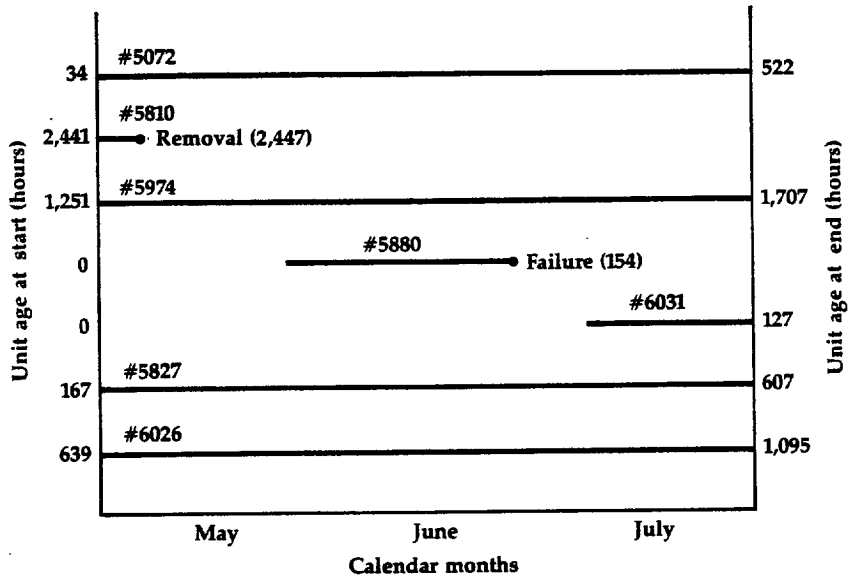

determine what proportion of the units failed prior to a given age and what proportion survived.

The first step in an actuarial analysis is to break the total lifetime of the oldest unit down into age intervals. These may be age cells of any length, but a reasonable rule of thumb is to have fewer age intervals than there are failures (otherwise many of the intervals will have zero failures). In the situation described in Exhibit C.6, for example, the oldest engine in the study was less than 5,400 hours old, and there were 30 verified failures during the three-month study period; hence we can use 200-hour age intervals. The total age range can then be viewed as a series of discrete intervals—0–200 hours, 201–400 hours, 401–600 hours, and so on—and the aging process consists of a series of trials to traverse each successive interval. Thus the first trial for a newly installed unit is to traverse the 0–200-hour interval. If the unit fails prior to 200 hours, the trial is unsuccessful. If the unit survives this interval, its next trial is to traverse the 201–400-hour interval. There are only two possible outcomes for any trial: a successful traverse or a failure.

The ratio of failures during an interval to the number of trials at that interval is the *conditional probability of failure* during that age interval—that is, it is the probability of failure, given the condition that a unit enters that interval. The ratio of successful traverses across an interval to the number of trials at that interval is the conditional probability of survival across that age interval.

A trial is counted as a whole trial under three circumstances:

- ▶ A unit enters an interval and makes a successful traverse.
- ▶ A unit enters an interval and fails in that interval.
- ▶ A unit starts in an interval and fails in that interval.

A trial is counted as a fractional trial when:

- ▶ A unit enters an interval and is removed during that interval without failure.
- ▶ A unit starts in an interval and either makes a successful traverse or is removed during that interval without failure.

Each fractional trial is counted as half of a whole trial—which it is, on the average.

Consider the 0–200-hour age interval. Some of the units that were in that age interval on May 1 and some of the units that entered it after May 1 failed. Others made a successful traverse and survived to enter the next interval, 201–400 hours. The number that entered this next interval is the number that were either in the 0–200-hour interval on May 1 or entered it after that date, less the number of removals and the number of units which were still in that interval on July 31. In other

EXHIBIT C-6 Procedure followed in an actuarial analysis of operating experience with the Pratt & Whitney JT8D-7 engine on the Boeing 737 from May 1 to July 31, 1974. (United Airlines)

age interval	no. which entered interval	no. in interval on May 1	no. in interval on July 31	total removed	no. failed	cumulative failures	no. of trials	experience in interval	cumulative experience
(1)	(2)	(3)	(4)	(5)	(6)	(7)	(8)	(9)	(10)
0- 200	42	19	16	4	4	4	43.5	8,300	8,300
201- 400	41	16	18	3	3	7	40.0	7,700	16,000
401- 600	36	20	18	2	1	8	36.5	7,200	23,200
601- 800	36	14	16	4	4	12	35.0	6,600	29,800
801-1,000	30	4	14	2	2	14	25.0	4,800	34,600
1,001-1,200	18	7	9	1	1	15	17.0	3,300	37,900
1,201-1,400	15	8	9	1	0	15	14.0	2,800	40,700
1,401-1,600	13	6	3	1	0	15	14.0	2,800	43,500
1,601-1,800	15	8	7	3	3	18	15.5	2,800	46,300
1,801-2,000	13	3	2	6	3	21	12.0	2,100	48,400
2,001-2,200	8	5	5	1	1	22	8.0	1,500	49,900
2,201-2,400	7	7	1	1	1	23	10.0	1,900	51,800
2,401-2,600	12	5	2	5	2	25	12.0	2,200	54,000
2,601-2,800	10	2	4	3	1	26	8.0	1,500	55,500
2,801-3,000	5	3	4	1	0	26	4.0	800	56,300
3,001-3,200	3	0	0	1	1	27	3.0	500	56,800
3,201-3,400	2	3	2	1	1	28	2.5	400	57,200
3,401-3,600	2	0	0	1	1	29	2.0	300	57,500
3,601-3,800	1	1	0	0	0	29	1.5	300	57,800
3,801-4,000	2	0	1	0	0	29	1.5	300	58,100
4,001-4,200	1	0	1	0	0	29	0.5	100	58,200
4,201-4,400	0	0	0	0	0	29	0.0	000	58,200
4,401-4,600	0	0	0	0	0	29	0.0	000	58,200
4,601-4,800	0	0	0	0	0	29	0.0	000	58,200
4,801-5,000	0	1	0	0	0	29	0.5	100	58,300
5,001-5,200	1	0	0	1	1	30	1.0	100	58,400
5,201-5,400	0	0	0	0	0	30	0.0	000	58,400
				<u>42</u>	<u>30</u>				

words, referring to the column numbers in Exhibit C.6, the number of units that leaves any age interval to enter the next higher age interval is computed as

$$\text{col 2} + \text{col 3} - \text{col 4} - \text{col 5}$$

Note that whenever a unit is removed, the replacement unit, which has just come out of the shop, enters the 0–200-hour interval at an age of 0 hours. There were 42 units removed from service during the study period, 30 caused by failures and 12 for other reasons. This means that 42 units entered the 0–200-hour interval as new units. The number entering each of the other intervals must be calculated from the equation above.

Now we must calculate the trials associated with each age interval. The number of traverses of the upper boundary of an interval is greater than the number of successes during the calendar period, because those units that were already in that interval on May 1 had, on the average, each completed half a trial. The number of trials associated with the successful traverses is therefore

$$(\text{col 2} + \text{col 3} - \text{col 4} - \text{col 5}) - \frac{\text{col 3}}{2} = \text{col 2} + \frac{\text{col 3}}{2} - \text{col 4} - \text{col 5}$$

Each engine failure counts as a full trial. The engine removals that were not associated with failures and the units that were still in the age interval on July 31 are counted as fractional trials. The total number of trials associated with an age interval is

$$\begin{aligned} \text{col 2} + \frac{\text{col 3}}{2} - \text{col 4} - \text{col 5} + \text{col 6} + \frac{\text{col 5} - \text{col 6}}{2} + \frac{\text{col 4}}{2} \\ = \text{col 2} + \frac{\text{col 3}}{2} - \frac{\text{col 4}}{2} - \frac{\text{col 5}}{2} + \frac{\text{col 6}}{2} \end{aligned}$$

Each trial associated with a successful traverse represented 200 hours of operating experience. Each engine removal and each unit still in the interval on July 31 therefore represents an average of 100 hours of operating experience. Consequently the operating experience represented by an age interval is computed as

$$\begin{aligned} 200 \times \left[\left(\text{col 2} + \frac{\text{col 3}}{2} - \text{col 4} - \text{col 5} \right) + \left(\frac{\text{col 5}}{2} + \frac{\text{col 4}}{2} \right) \right] \\ = 200 \times \left[\text{col 2} + \frac{\text{col 3}}{2} - \frac{\text{col 4}}{2} - \frac{\text{col 5}}{2} \right] \end{aligned}$$

The next step is calculation of the proportion of the trials that end in successful traverses of each age interval and the proportion that result in failure in each interval. The results of these calculations are shown in Exhibit C.7. The proportion of units surviving or failing in a given age

EXHIBIT C-7 Survival characteristics of the Pratt & Whitney JT8D-7 engine on the Boeing 737 during the period May 1 to July 31, 1974. (United Airlines)

age interval	no. of trials	no. of failures	proportion surviving	cumulative probability	proportion failing	cumulative failure no.
(1)	(2)	(3)	(4)	(5)	(6)	(7)
0- 200	43.5	4	0.908	0.908	0.092	0.092
201- 400	40.0	3	0.925	0.840	0.075	0.167
401- 600	36.5	1	0.973	0.817	0.027	0.194
601- 800	35.0	4	0.886	0.724	0.114	0.308
801-1,000	25.0	2	0.920	0.666	0.080	0.388
1,001-1,200	17.0	1	0.941	0.627	0.059	0.447
1,201-1,400	14.0	0	1.000	0.627	0.000	0.447
1,401-1,600	14.0	0	1.000	0.627	0.000	0.447
1,601-1,800	15.5	3	0.806	0.505	0.194	0.641
1,801-2,000	12.0	3	0.750	0.379	0.250	0.891
2,001-2,200	8.0	1	0.875	0.332	0.125	1.016
2,201-2,400	10.0	1	0.900	0.298	0.100	1.116
2,401-2,600	12.0	2	0.833	0.249	0.167	1.283
2,601-2,800	8.0	1	0.875	0.217	0.125	1.408
2,801-3,000	4.0	0	1.000	0.217	0.000	1.408
3,001-3,200	3.0	1	0.667	0.145	0.333	1.741
3,201-3,400	2.5	1	0.600	0.087	0.400	2.141
3,401-3,600	2.0	1	0.500	0.044	0.500	2.641
3,601-3,800	1.5	0	1.000	0.044	0.000	2.641
3,801-4,000	1.5	0	1.000	0.044	0.000	2.641
4,001-4,200	0.5	0	1.000	0.044	0.000	2.641
4,201-4,400	0.0	0	—	—	—	—
4,401-4,600	0.0	0	—	—	—	—
4,601-4,800	0.0	0	—	—	—	—
4,801-5,000	0.5	0	1.000	0.044	0.000	2.641
5,001-5,200	1.0	1	0.000	0.000	1.000	3.641
5,201-5,400	0.0	0	0.000	0.000	0.000	3.641

interval are considered to be estimates of the respective probabilities. The cumulative probability of survival to the end of any interval is the product of the survival probabilities for all preceding intervals and the probability of survival across the interval in question. Similarly, the cumulative failure number for the end of any age interval is the sum of the probabilities of failure in all preceding intervals and the probability of failure in this interval. The cumulative failure number is not a probability. It can be considered to represent the average number of failures which would occur if single trials were made to traverse the selected interval and each of the earlier intervals.

The occurrence of a failure in any interval is a random event. Thus it is possible to have a number of failures in one age interval, none in the next, and a few again in the next. Our concern with the age-reliability relationship is the possibility that the failure rate may increase significantly with age, and if it does, we may wish to evaluate the utility of an age limit for the item in question. (Infant mortality is also a concern, but this is a different and much simpler problem, since it occurs quickly, if at all, and there is an abundance of data available for study.) Thus local variations in the failure rate are of little interest. This implies that we will have to smooth the data to reduce the effect of the random time occurrences of the failures.

C-3 THE SMOOTHING PROBLEM

The conditional probability of failure is simply the ratio of the number of failures in a given age interval to the number of units that attempt that interval. In an actuarial study this represents the proportion of the units entering each age interval that fail during that interval, as shown in column 6 of Exhibit C.7. The proportions vary from 0 to 1, and as expected, this variation tends to increase as the number of units in the interval decreases.

The data for the engine under study suggest a relatively high failure rate at low ages (infant mortality), a lower rate at the middle ages, and a higher rate at the higher ages. This last possibility is of particular interest because of its implications for scheduled rework and economic-life-limit tasks. There are several ways of analyzing the data to try to clarify the picture:

- ▶ We can smooth the data through some standard smoothing procedure, such as a moving average or exponential smoothing.
- ▶ We can increase the length of the age intervals, which would increase the number of failures per interval, and thus reduce the variability of the failure rate.

- We can construct cumulative graphs of the data in any of several ways and simply draw a smooth curve through the data points.

The first of these procedures will not be discussed here, since it is well-covered by the literature. The second smoothing procedure—increasing the age interval in such a way that each interval has approximately the same amount of unit experience—is somewhat more common. One such grouping, for example, yields the following results:

<i>age interval</i>	<i>failures</i>	<i>experience</i>	<i>failure rate (per 100 hours)</i>
0–400	7	16,000	0.044
400–800	5	13,800	0.036
800–1,600	3	13,700	0.022
1,600–5,200	15	14,900	0.101

This grouping of the data suggests a linearly decreasing failure rate for the first 1,600 hours, followed by a very sharp increase immediately after this age. The intervals might also be adjusted as follows:

<i>age interval</i>	<i>failures</i>	<i>experience</i>	<i>failure rate (per 100 hours)</i>
0–400	7	16,000	0.044
400–1,200	8	21,900	0.037
1,200–5,200	15	20,500	0.073

In this case the data suggest a more moderate initial decrease in failure rate, followed by a more moderate increase starting at 1,200 hours (rather than 1,600 hours). Other choices would lead to still other variations of this sort. Age grouping is simple and the statistical interpretation is straightforward. However, it is obvious from the examples above that the interpretation is highly dependent on the grouping process.

The chief problem in representing failure data is to reduce the apparent variations so that different analysts will come to similar conclusions. A common engineering procedure to accomplish this is to cumulate the data and then graph the cumulative values. There are three methods in general use, although all three have the limitation that they do not explicitly take into account the varying amounts of unit experience in different age intervals. For example, the engine data in Exhibit C.6 show much more experience in the earlier age intervals than in the later ones—and this will necessarily be the case whenever failed units are automatically replaced by units with zero age. Thus the trial count in Exhibit C.7 ranges from 43.5 to 35 trials in the first four age intervals, whereas in the later intervals the number of trials was as small as 4 or 2, or even 0. This kind of variation in unit experience makes it more difficult to assess the validity of the pattern suggested by a smooth curve.

One method of cumulating the data is to multiply the proportions surviving successive age intervals to obtain the cumulative probability of survival for each interval (column 5 in Exhibit C.7), draw a smooth survival curve through the points (as shown in Exhibit C.2), and then compute the conditional probability of failure for each interval from the simple formula

$$\text{Conditional probability of failure in interval} = \frac{\left(\frac{\text{probability of entering interval}}{\text{probability of surviving interval}} \right) - \left(\frac{\text{probability of surviving interval}}{\text{probability of entering interval}} \right)}{\text{probability of entering interval}}$$

This procedure breaks down, of course, when we reach an interval in which all the units fail (because the proportion surviving is zero). However, the likelihood that all the units in an interval will fail is small unless the number of units in that interval is itself small. With the engine described in Exhibits C.6 and C.7 this happens for the first time in the 5,000–5,200-hour interval, which contains only one unit. If, as sometimes happens, we had had failure data beyond this age interval, a smoothing procedure that relies on multiplication would not have permitted us to use it.

Another method makes use of the cumulative failure number (column 7 in Exhibit C.7). This number, at the end of a given interval, is the sum of the probabilities of failure in all preceding intervals and the probability of failure in the interval in question. Remember that the cumulative failure number is not itself a probability; it represents the average number of failures that would occur if single trials were made to traverse the selected interval and each of the earlier intervals. Exhibit C.8 shows the cumulative failure numbers at the end of each age inter-

EXHIBIT C-8 The cumulative failure number for the Pratt & Whitney JT8D-7 engine on the Boeing 737. (United Airlines)

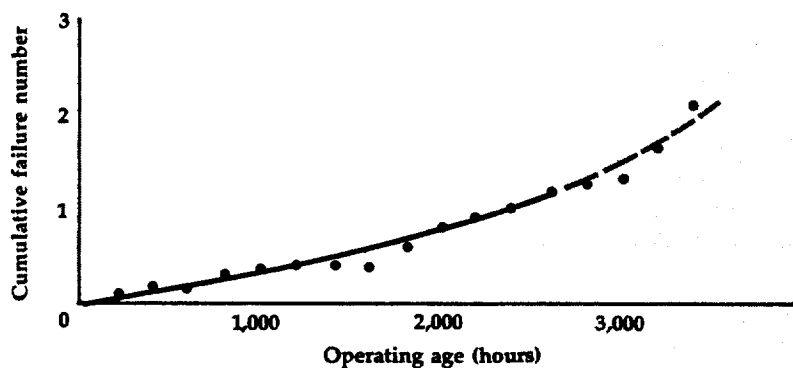

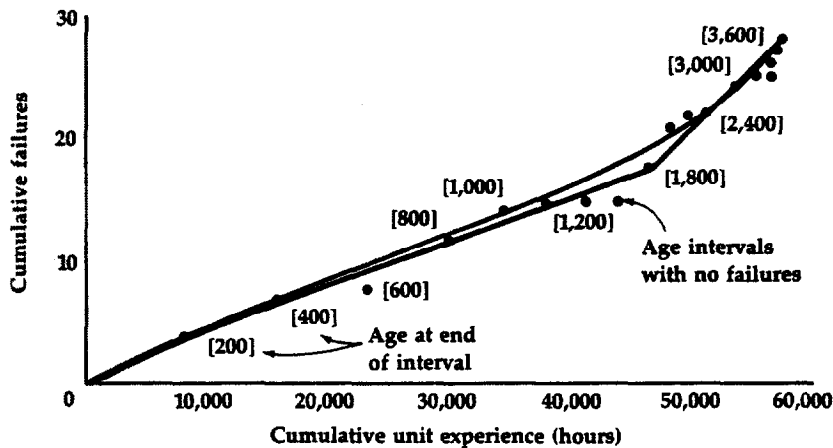

EXHIBIT C-9 A simple method for determining the age-reliability relationship of the Pratt & Whitney JT8D-7 engine. The slope of the smooth curve at any operating ages is a measure of the conditional probability of failure at that age. (United Airlines)

val plotted as a function of operating age, with a smooth curve drawn through the points. The conditional probability of failure in an interval is the difference between the cumulative failure numbers at the end and the beginning of the interval. For example, from Exhibit C.8, the smoothed cumulative failure number at the end of 1,000 hours is 0.395 and at the end of 800 hours it is 0.310. Thus the conditional probability of failure in the 801–1,000-hour interval is $.395 - .310 = .085$, or at 900 hours (midinterval), $.085/2 = .042$ per 100 hours.

This procedure differs from the previous one in terms of the quantity that is being smoothed. The precise difference cannot be pinned down if the graphing is done manually, since there is no way to tell with either method precisely how the experienced analyst is weighting the two factors when he draws the smooth curve. The procedure is primarily additive, however, so that there is no difficulty in treating intervals in which all units fail.

A third method is to plot the cumulative number of failures by the end of each interval against the cumulative experience by the end of that interval. The values for both of these variables are listed in Exhibit C.6, and the resulting plot is shown in Exhibit C.9. The slope of the smooth curve at any age is the conditional probability of failure associated with that age. There is a temptation in this case to represent the plotted points by three straight line segments — one from 0 to 200 hours, another from 200 to 1,800 hours, and a third from 1,800 to 5,200 hours.

Such straight line segments would lead to the following conditional probabilities of failure:

<i>operating age (hours)</i>	<i>conditional probability of failure (per 100 hours)</i>
0-200	.048
200-1,800	.037
1,800-5,200	.100

This construction suggests abrupt changes in the conditional probability of failure at 200 hours and again at 1,800 hours. While it is conceivable that dominant failure modes might be dispersed about these average ages, it is highly unlikely that there are actual discontinuities in the conditional probability of failure.

The discontinuities can be avoided simply by drawing a smooth curve instead of straight line segments through the plotted points (the black curve in Exhibit C.9). Conditional probabilities can then be obtained from the smooth curve by drawing tangents to it at various operating ages. Typical results are as follows:

<i>operating age (hours)</i>	<i>conditional probability of failure (per 100 hours)</i>
0	.050
200	.042
400	.038
600	.036
...	...
1,600	.049

The conditional-probability curve obtained by plotting the conditional probability of failure as a function of operating age is shown in Exhibit C.10.

The average conditional probability of failure in the interval from 0 to 200 hours is .046 (at the midpoint of this interval); hence the probability that an engine will not survive to 200 hours is $2 \times .046 = .092$, and the probability that it will survive is $1 - .092 = .908$. Similarly, the probability that an engine which has survived to 200 hours will continue to survive to 400 hours is $1 - (2 \times .040) = .920$. The probability that an engine will survive both the 0-200 and the 201-400-hour age intervals is the product of both these probabilities, or $.908 \times .920 = .835$. A plot of the survival curve for this extended example is also shown in Exhibit C.10. Both the conditional-probability curve and the survival curve are broken at ages above 2,600 hours as a warning that the levels of the curves are not well-established beyond that age. (The choice of 2,600 hours as a caution point is arbitrary.)

This third procedure for computing conditional and survival prob-

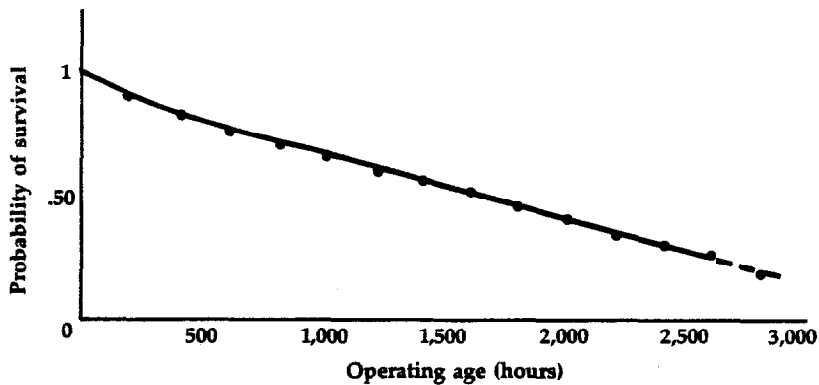
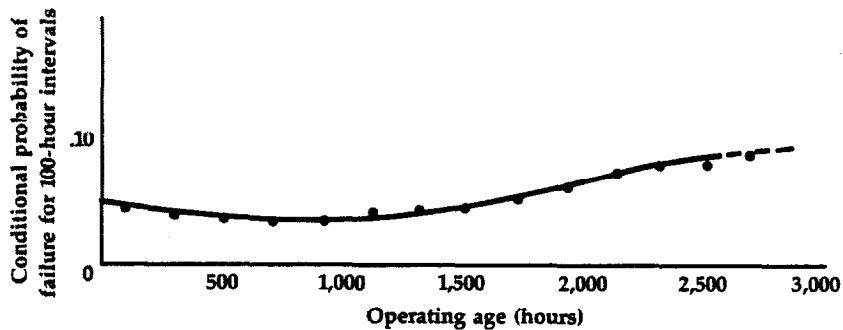

EXHIBIT C-10 Conditional-probability and survival curves derived from the smooth curve in Exhibit C.9.

abilities allows the analyst to assess the varying numbers of failures and trials, and hence to judge reasonably well what portion of the data is well-defined and what portion is more questionable. The smoothing that does occur, while still subject to the variations of freehand construction, will usually lead to nearly identical results for the same data.

Exhibit C.11 shows conditional-probability curves obtained by all three methods, as an indication of the consistency of the curve that will result, regardless of the procedure followed. The histogram below this graph is a convenient way of displaying the experience on which the analysis was based. The vertical bars show the volume of operation in each age interval, and number above each bar is the number of failures that occurred in that interval. A failure rate can be calculated for each age interval. These failure rates are shown as data points on the conditional-probability graph, but it would be difficult to fair a curve through them and define a trend. The actuarial procedures we have discussed overcome this difficulty.

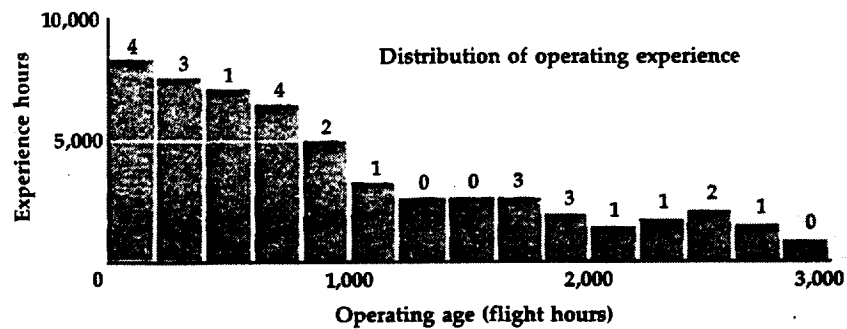
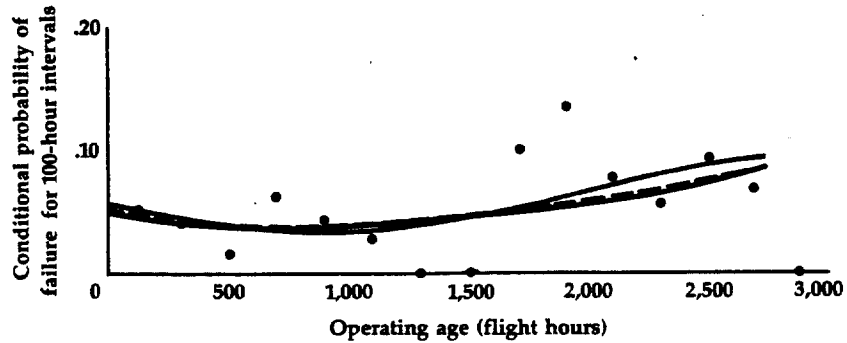

EXHIBIT C-11 A comparison of conditional-probability curves derived by three different methods. The bar chart shows the distribution of operating experience on which all three analyses were based.

C-4 ANALYSIS OF A MIXED POPULATION

The data used in the preceding analyses pertain to an engine that is not subject to scheduled removals. Each engine remains in service until an unsatisfactory condition is detected, either by the maintenance crew or by the operating crew. At that time the engine is removed and sent to the shop for corrective maintenance. Since extensive work may be done on the engine while it is in the shop, this repair process is considered to zero-time the engine. Its operating age is thus measured as engine time since the last shop visit—that is, as the time since the last repair—and all engines are treated as members of a single population.

When an engine is subject to a limit on maximum permissible operating age, it is assumed that complete overhaul of a unit that was operating satisfactorily will also reestablish its age at zero. In the text

discussion concerning the effects of an age limit (Section 2.7), it was further assumed that both repaired and reworked engines have the same age-reliability characteristics. This assumption is equivalent to saying that both are members of the same population. Suppose we want to test the validity of this assumption. In that case our analytic techniques must allow for the possibility that the two shop processes may result in different age-reliability characteristics. This can be done by treating the total population of engines as a *mixed population*.

At one time it was believed that overhaul of a turbine engine prior to a specified operating age played a major role in controlling reliability. On this basis a complete overhaul was the only process considered to zero-time the engine, and operating age was measured as the time since overhaul (TSO). Under this policy an engine removed prematurely for corrective maintenance was repaired and returned to service, but was considered to have experienced no change in its operating age. Two factors, however, might result in *premature overhauls*—overhauls before the scheduled removal age:

- ▶ The occurrence of a failure in the last 20 to 25 percent of the permissible operating age, in which case a complete overhaul during this shop visit would avoid the need for a scheduled removal soon after the repaired engine was reinstalled
- ▶ A failure requiring such extensive repairs that it would be economically desirable to do the additional work needed for a complete overhaul, regardless of the age of the engine

Under these circumstances the results of an actuarial analysis of a mixed population would have to show survival curves, probability-density curves, and conditional-probability curves for three variables—failures, repairs, and overhauls.

The analysis of a mixed population requires very little change from the method discussed in Section C.3. It is necessary only to plot the cumulative number of repairs and the cumulative number of overhauls for each age interval as a function of the cumulative experience for that interval. Exhibit C.12 shows the results for a hypothetical analysis of a mixed population subject to an overhaul age limit of 2,500 hours. The conditional-probability curves show the probability of failure at all ages up to the 2,500-hour limit and the probability of premature overhaul of the units that fail. Below 2,000 hours most of the failed units are repaired and returned to service without overhaul; after 2,000 hours all failures become premature overhauls. The survival curves show that the probability of survival without overhaul decreases slowly up to 2,000 hours; thereafter it decreases at exactly the same rate as the probability of survival without failure. The probability of survival without repair is higher than the probability of survival without failure, since

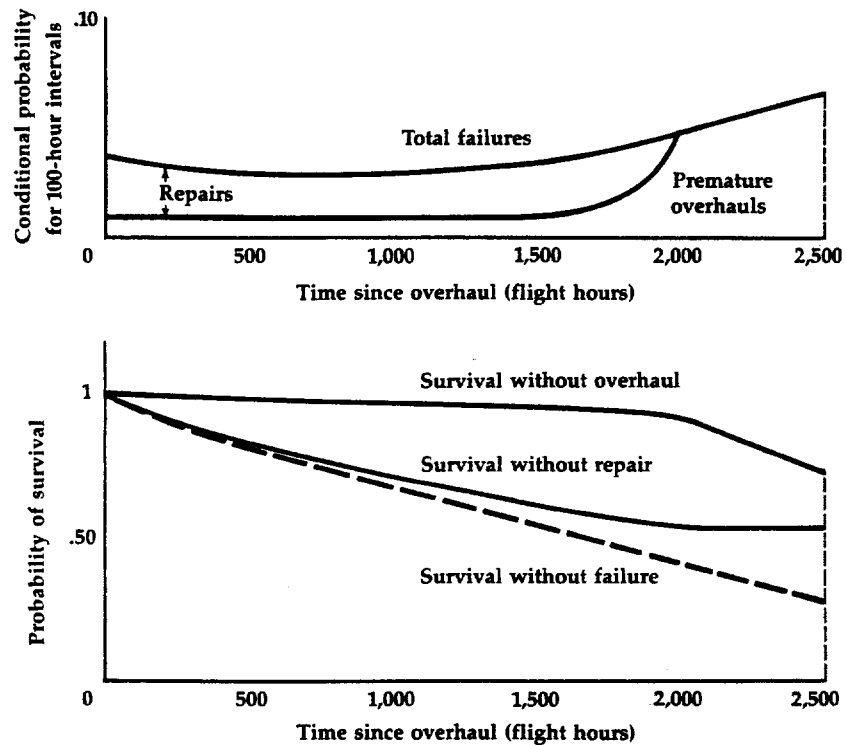

EXHIBIT C-12 Hypothetical results of an actuarial analysis of a mixed population subject to a scheduled rework task.

some failures will result in premature overhauls before 2,000 hours; after 2,000 hours the probability of survival without repair remains constant, since all failed units after that age are overhauled.

Actuarial analysis of a mixed population requires a number of detailed but simple changes in the format outlined in Exhibits C.6 and C.7. The following adjustments are necessary in Exhibit C.6:

- ▶ Column 2, which shows the number of units entering an age interval, must take into account reinstallation of a repaired unit, as well as entry of a unit from the preceding interval.
- ▶ The failure count in column 6 must be partitioned into the number of failed units that are repaired and the number of failed units that are overhauled.
- ▶ The trial count in column 8 must be adjusted to account for the experience of repaired units that are reinstalled during the study period. The failure of a repaired unit during the interval in which

it was installed counts as a whole trial; if the unit survives to leave this interval, this experience counts as a fractional trial.

Similar changes are necessary in the details of Exhibit C.7:

- ▶ The failure number must be partitioned into failed units that are repaired and failed units that are overhauled.
- ▶ The probabilities of survival, both for each interval and cumulative, must be partitioned into survival without overhaul, survival without repair, and survival without failure.
- ▶ The calculations to determine the probability of failure in each interval must be repeated to obtain the probability of a repair in each interval.
- ▶ A cumulative repair number, like the cumulative failure number, must be calculated for the end of each age interval. This number will be less than the cumulative failure number. The difference between these two numbers is the probability of an overhaul and the complement of the cumulative probability of survival without overhaul for the corresponding interval.

C-5 USEFUL PROBABILITY DISTRIBUTIONS

At certain stages of an actuarial analysis curves are faired through sets of data or calculated points, and subsequent calculations are then based on numerical values read from these curves. This curve-fitting technique is not mathematically precise, and one feels somewhat uncomfortable using extrapolations from such curves. In many cases it is possible to model age-reliability relationships by the mathematical functions which represent certain probability distributions. Special graph papers are available for some of the more common distributions which have the property that a survival curve appears on them as a straight line.

It is known that certain failure processes and the characteristics of certain items result in age-reliability relationships that can be approximated by specific probability distributions. Much information on the physical processes that produce this capability is available in the literature, and this knowledge is the best guide in evaluating the adequacy of a given probability distribution to represent the results of an actuarial analysis. Another more empirical guide is the shape of the conditional-probability or probability-density curve that resulted from the initial analysis. If there is reason to believe that the age-reliability characteristics of an item do follow a particular probability distribution, it is usually

more accurate to fit a straight line through survival points on graph paper that is unique to that distribution than it is to draw a curve through the corresponding points plotted on cartesian coordinates.

Many probability distributions have been developed and can be used for reliability analyses. The three which have the widest application are the exponential distribution, the normal distribution, and the Weibull distribution. Exhibit C.13 shows the relationship of the conditional probability of failure, the probability density of failure, and the probability of survival for the *exponential distribution*. The conditional probability of failure associated with an exponential distribution is constant at all ages — that is, the probability of failure is the same at any age to which a given unit may survive. This is sometimes expressed by saying that an item with exponential characteristics has no memory. This conditional-probability relationship, described by curve *E* in Exhibit 2.13, is characteristic of complex items with no dominant failure modes, and also of electronic items, particularly at ages beyond the infant-mortality period.

The failure-density curve shows that the incidence of failures for items characterized by an exponential distribution is highest at low ages, starting at installation. This, of course, is because low ages represent the greatest amount of unit experience, and since the conditional probability of failure is constant, the more units there are in an age interval, the more failures there will be. The survival curve of the exponential distribution has a shape similar to that of the density curve. The exponential distribution is a single-parameter distribution. This parameter is the failure rate. It is a scaling parameter, since it determines the magnitude of the conditional probability of failure, the initial value and rate of decrease of the density curve, and the rate of decrease of the survival curve.

Exhibit C.14 shows the corresponding relationships for the *normal distribution*. The conditional probability of failure associated with a normal distribution is relatively small at low ages and increases monotonically with increasing age. This distribution is therefore a candidate for consideration when an item exhibits increasing signs of wearout after relatively low probabilities of failure at earlier ages. The failure-density curve for the normal distribution has a clearly defined maximum value. This occurs at the average age at failure if all units are permitted to continue in operation until they fail. Note that the density curve is symmetrically disposed about this average age. This is an important characteristic of a normal distribution. The survival curve passes through a probability of .50 at the average age at failure and has twofold symmetry with respect to this probability point.

The statement that an item has a "life of x hours" is usually based on a supposition that it has age-reliability characteristics which can be

EXHIBIT C-13 The relationship of conditional probability, probability density, and probability of survival for an exponential distribution with a mean time between failures of 2,000 hours.

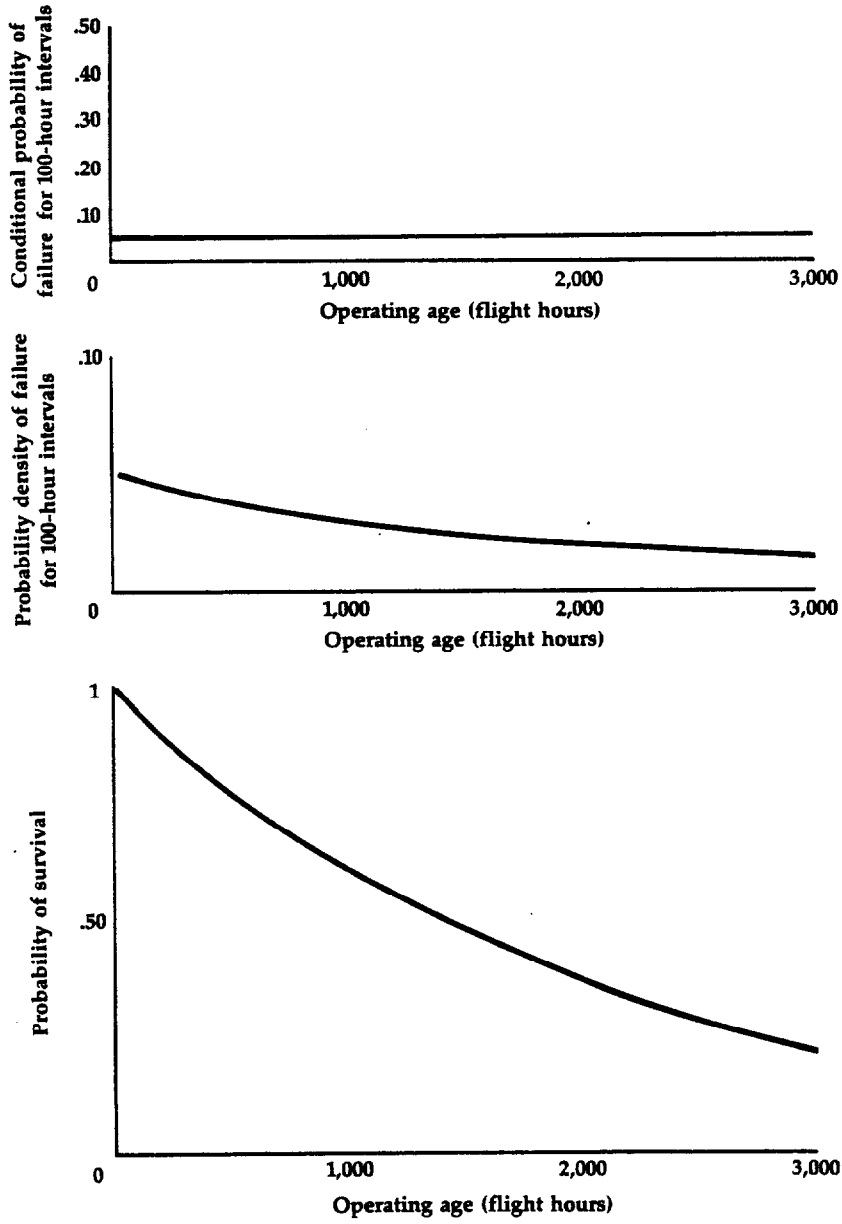
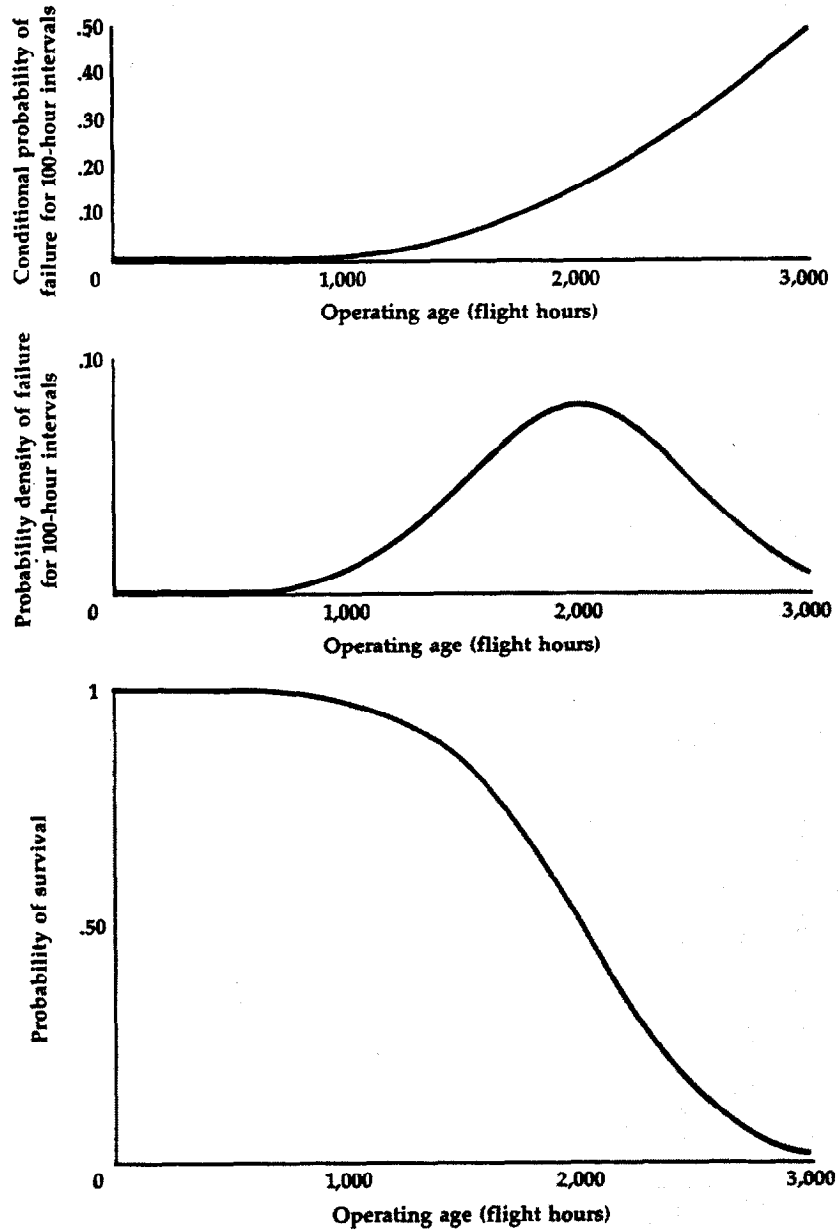

EXHIBIT C-14 The relationship of conditional probability, probability density, and probability of survival for a normal distribution with a mean time between failures of 2,000 hours and a standard deviation in failure age of 500 hours.



represented by a normal distribution. In other words, such a statement assumes the following characteristics:

- ▶ The probability of failure at low ages is very small.
- ▶ The probability of failure increases as operating age increases.
- ▶ There is an age at which the density of failure has a relatively well-defined maximum value.
- ▶ The density of failure at lower or higher ages is symmetrically disposed about the maximum value.

The normal distribution frequently does represent the age-reliability characteristics of simple items (those subject to only one or a very few failure modes).

The normal distribution is a two-parameter distribution. One parameter is a location parameter; it defines the age at which the maximum failure density occurs. The other parameter is a scaling parameter and is determined by the degree of dispersion of the failure densities about the peak value. The scaling parameter thus establishes the curvature of the survival curve, the magnitudes of the conditional probabilities, and the magnitude of the maximum failure density and of other densities about the maximum value.

Exhibit C.15 shows the characteristics of a *Weibull distribution*. In this particular example the conditional-probability curve resembles that for the normal distribution, in that the conditional probability of failure increases monotonically with age. It is dissimilar, however, with respect to the conditional probability at low ages, which is shown as being relatively high. The Weibull distribution is a candidate for representing items that have a moderately high probability of failure at low ages and demonstrate monotonically increasing (or decreasing) failure probabilities thereafter.

This discussion takes considerable liberty with the Weibull distribution. The Weibull distribution is a very versatile one with wide applicability. It can in fact be used to represent items with high or low conditional probabilities at low ages, and age relationships in which the probability of failure either increases or decreases with increasing age. The exponential and normal distributions are both special cases of the Weibull distribution.

The Weibull distribution in Exhibit C.15 has a failure-density curve that is not too different from that for the normal distribution shown in Exhibit C.14. There is an age at which the density function has a well-defined maximum value. Unlike the normal distribution, however, the densities in a Weibull distribution are not necessarily symmetrically disposed about this peak value. They can be, but they usually are not.

EXHIBIT C-15 Relationship of conditional probability, probability density, and probability of survival for a Weibull distribution with a mean time between failures of 1,013 hours, scaling parameter $\alpha = 33.15$, and shaping parameter $\beta = 1.45$.

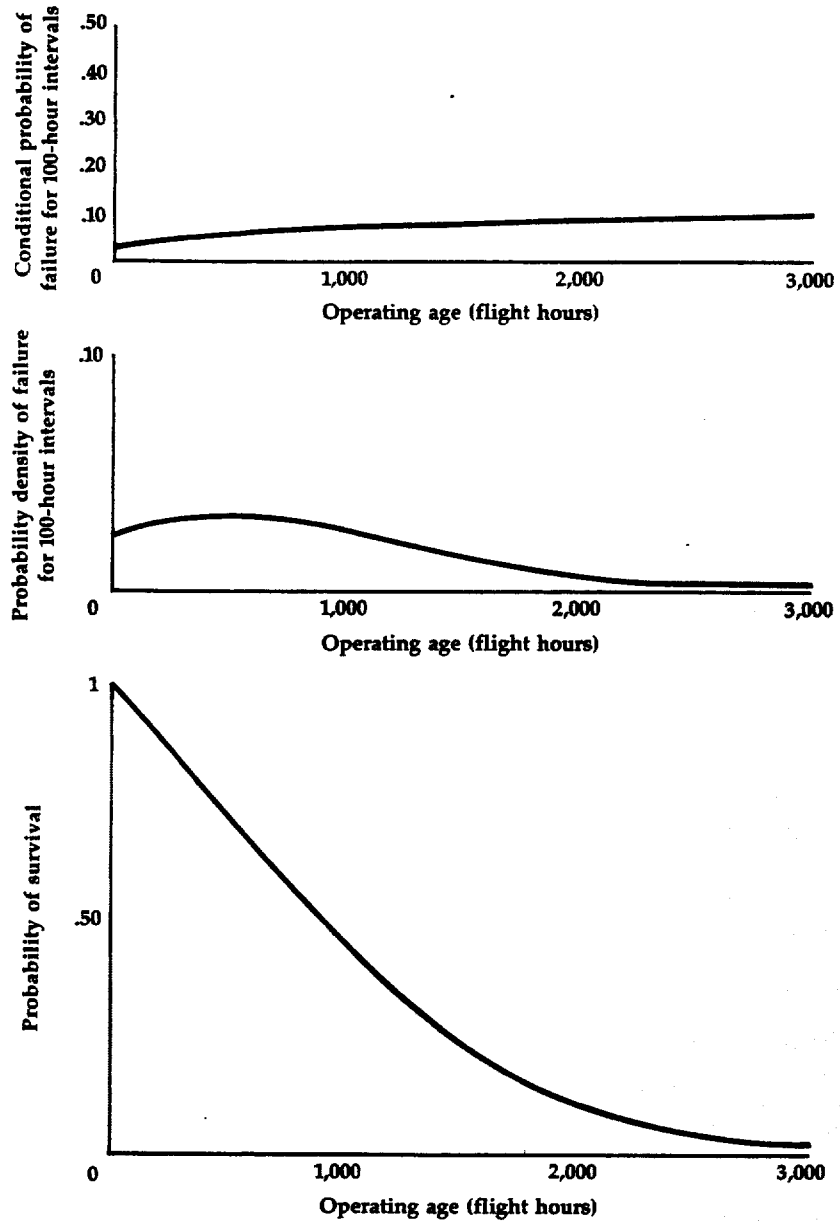

By the same token, the survival curve for a Weibull distribution does not necessarily pass through the .50 point at the age corresponding to the maximum failure density, nor does it have the symmetry of the normal curve.

The Weibull distribution described here is a three-parameter distribution. One parameter is a location parameter which, in effect, defines a negative age at which the conditional probability of failure is zero. The other parameters are scaling and shape parameters.

Each of the probability distributions enables us to express the conditional probability of failure, the probability density of failure, and probability of survival without failure as a function of operating age and certain parameters. These parameters make it possible to develop a large family of different relationships for each type of probability distribution. In practical work we are ordinarily not concerned with enumerating the parameters that apply to a specific analysis or writing the equations that describe the age-reliability relationship. The purpose of an actuarial analysis is to determine whether the reliability of the item deteriorates with operating age, and if it does, to assess the desirability of imposing a limit on operating age. Thus any interest in probability distributions is entirely pragmatic and centers on the possibility of using the specialized graph papers for such distributions to simplify the task of fairing curves through the survival data. Experience has shown that none of these three probability distributions provide a satisfactory model for the results of turbine-engine analysis, and in that case representation still depends on subjective curve fitting by the analyst.

C·6 A SPECIAL USE OF THE EXPONENTIAL DISTRIBUTION

Spare units for each item are purchased and kept on hand to support new equipment when it enters service. The provisioning is based on an anticipated failure rate for each item. It is not uncommon, however, for an item on newly designed equipment to experience a failure rate much higher than was anticipated. This results in an unexpected increase in the shop workload, and also in depletion of the supply of serviceable spare units needed to support the equipment. This means that pieces of equipment may have to be removed from service because there are no replacement units of the unreliable item. A problem of this kind can persist for some time, since the process of proving that specific design changes do in fact improve reliability is a slow one. Moreover, not only does it take time to manufacture additional spare units, but there is also a reluctance to invest in additional units of a design that has proved unsatisfactory.

Invariably the question arises as to whether a limit on the maximum operating age of such an item is desirable to alleviate the spare-unit problem caused by a high failure rate. The exponential distribution can give useful information that permits a quick answer to this question. Exhibit C.16 shows the probability of survival of an item with exponential reliability characteristics, with the operating age expressed as a multiple of the mean time between failures. The exponential distribution represents a constant conditional probability of failure at all ages, as described by curve *E* in Exhibit 2.13. Obviously an item whose failure behavior corresponded to curve *A*, *C*, or *F* in this family of curves would have smaller survival probabilities at all ages than one with exponential characteristics. Items with the characteristics described by curve *B* have survival probabilities which are about the same as those for a class *E* item at low ages and deteriorate at high ages. The relatively few items whose conditional-probability curves correspond to curve *D* have survival probabilities which are actually somewhat better than exponential at higher ages. For the purposes of this question, however, it is reasonable to assume that the troublesome item can be represented by the exponential survival curve in Exhibit C.16.

Suppose this item has a failure rate of 1 per 1,000 hours. The mean time between failures is, of course, $1,000/1 = 1,000$ hours. An age limit of 1,500 hours has been proposed for this item. If we extrapolate values from the exponential survival curve, we find that at an age limit which represents 1.5 times the mean time between failures, 22.3 percent of the units can be expected to survive to that limit and become scheduled removals:

<i>ratio of age limit to mean time between failures</i>	<i>probability of survival to age limit</i>
0.1	.905
0.2	.819
0.4	.670
0.6	.549
0.8	.449
1.0	.368
1.5	.223
2.0	.135
2.5	.082
3.0	.050
3.5	.030
4.0	.018
5.0	.007

These scheduled removals will further increase the demand for spare units, and hence will aggravate the present inventory problem instead

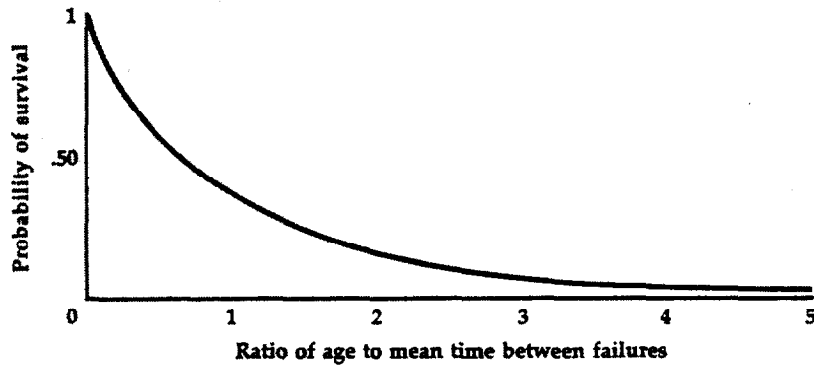

EXHIBIT C-16 A nondimensional form of the exponential survival curve that can be used to determine the probability of survival to any multiple of the mean time between failures.

of alleviating it. Any additional operating life that can be realized by this 22.3 percent of the units represents a saving over the number of spare units that would be needed with an age limit.

If there are major economic consequences associated with the failures – and if the conditional probability of failure in fact increases rapidly after 1,500 hours – then an age limit may be desirable to reduce the failure rate regardless of the increase in the inventory problem. This, however, is a solution to a different problem from the one that has been posed. There are many situations in which the assumption of a simple exponential distribution serves as a useful tool in helping to define the actual problem.

bibliography

JAMES L. DOLBY

THIS BIBLIOGRAPHIC essay has three main purposes:

- ▶ To list the seminal documents in statistics, quality control, reliability theory, information science, and decision analysis that preceded the development of reliability-centered maintenance as a logical discipline
- ▶ To provide access to the broader literature in each of these areas for those readers who would like to explore one or more of them in greater detail
- ▶ To provide specific access to the literature of reliability-centered maintenance and directly related materials

The third task presents a problem not shared by the first two. If one follows the obvious path of searching the general literature using such apparently reasonable terms as *reliability*, *prediction*, *decision analysis*, etc., the yield in retrieved documents is large, but the relevance level is extremely small. For instance, there is a very substantial literature on reliability modeling and prediction which is presumably of significant benefit to the designers and manufacturers of complex equipment. Very little of this literature is useful to one charged with designing a prior-to-service maintenance program. The difference stems in part from the differing needs of the equipment designer and the maintenance-program designer. A reliability model can be sufficiently close to reality to allow the equipment designer to analyze the difference between two competing design alternatives without being sufficiently real to allow precise prediction of performance in the user's environment. The model may be useful to the designer without providing specific insight as to whether the deterioration which precedes failure is visible or not, let alone information on the cost of obtaining such visibility when it is possible.

Similarly, there is a significant amount of literature on actuarial analysis and the fitting of various forms of failure distributions to empirical data. However, the role of actuarial analysis in reliability-centered maintenance is sharply limited, on the one hand, by the fact that we cannot afford to allow critical failures to occur in sufficient numbers to make actuarial analysis meaningful, and on the other hand, by the fact that most failures that are allowable (in terms of their consequences) are best dealt with by replacement at failure. Even in the middle range, where actuarial analysis is useful – at least in the ongoing program, after sufficient operating history has built up – the more sophisticated approaches involving the use of distinguished probability distributions and fine points of estimation theory are frequently misleading because of the stubborn refusal of real data to behave properly at the tails of a distribution.

There is also a fairly substantial literature on the theory of maintained systems, much of which is devoted to the selection of "optimum inspection intervals." Such approaches are rarely general enough to take into account all the variables that matter, including such simple realities as the need to package tasks for reasonable efficiency, continually shifting operating requirements, the availability of maintenance facilities, and the utility of using opportunity samples. The problem is compounded by the general absence of hard data in the prior-to-service study and during the break-in period immediately after the equipment enters service, when the selection of intervals is of greatest concern. Highly sophisticated techniques that begin to become useful only as the equipment nears obsolescence are of limited utility.

As a result, most of the works cited are important primarily because they shed light on the background in which RCM concepts developed or because they provide some insight into the design process that precedes the development of the complex equipment. In a few cases works

that have tried to carry the notion of optimization too far are singled out as a reminder of some of the pitfalls that await the innocent.

The references cited in this appendix were largely derived from an exhaustive literature search of machine-readable and print data bases conducted by Martha West and George Glushenok, who reduced several thousand citations to some 500 pertinent references. The search area encompassed such obvious general fields as engineering, electronics, operations research/management science, information and computer science, logistics, and statistics. In addition, certain selected publications, such as the *Proceedings of the Annual Reliability and Maintainability Symposia*, were searched cover to cover. F. S. Nowlan and C. S. Smith provided key documents from the aircraft/airline internal literature and the Department of Defense, as well as a number of useful comments on what to look for and what to ignore.

D·1 HISTORICAL DEVELOPMENT

The historical development of the study of reliability and maintenance can be broken into three main periods, albeit with a fair degree of overlap. In the 20 years preceding World War II there were several developments that laid the necessary base both in theory and in application. In the 1920s R. A. Fisher (1922) developed the essential structure of small-sample statistics and laid the basis for modern theories of estimation and the design of experiments. Neyman and Pearson (1928) laid the foundations for modern decision theory. Dodge and Romig produced the first sampling plans, which were published in book form later (1944), Fry (1928) and others showed how probabilistic analysis could be applied to the design of modern equipment, and Shewhart (1931) invented quality-control charts.

In the 1930s, even though industrial production was low because of the Depression, many of these techniques were tested in application, particularly in the telephone industry in this country and the chemical industry in Great Britain. Kolmogorov (1933) provided the first complete axiomatic description of probability theory, and work was begun on the problem of providing rigorous structure to the ideas that Fisher had pioneered.

The enormous expansion of industrial production in this country after December 1941 provided the opportunity and the need to implement modern quality-control techniques through the defense industry. The Statistical Techniques Group at Columbia University solidified the earlier work at Bell Laboratories in sampling plans, provided the first tables for estimating tolerance limits for design, and produced the first materials on decision theory. Most of this work became available in monographs published shortly after the war. E. L. Grant (1946) wrote

a primer on statistical quality control, Abraham Wald (1947, 1950) provided two key texts on decision theory, and Eisenhart et al. (1947) summarized other statistical developments derived at Columbia.

The second period of development, which had its roots in World War II and in the theoretical developments in probability theory prior to that time, properly begins after the war. One stimulus was the publication by Altman and Goor (1946) of an application of actuarial methods to engine failures on the B-29; another was the extensive conversion of surplus wartime equipment, particularly to civil aviation. For the next 20 years the increasing use of complex equipment, first with aircraft and later with missiles, led to increasingly sophisticated designs and manufacturing practices involving the use of redundancy to reduce the consequences of failure and burn-in to reduce the incidence of infant mortality. Empirical studies of Davis (1950), Weibull (1951), Epstein (1953), and others provided the base on which to make increasingly sophisticated estimates of expected reliability.

In the later stages of these developments design attention turned to problems of maintainability—the concept of making it easier to detect failures (or potential failures) and to replace failed components at reasonable costs. As with the quality-control era, maturity is marked by the publication of a spate of books. Zelen (1963) edited the proceedings of a conference in Madison, Wisconsin, that covered a number of areas of interest. Goldman and Slattery (1964) wrote the first text explicitly devoted to the maintainability problem. Pieruschka (1963) summarized much of the associated statistical material. Barlow and Proschan (1965) gathered together the mathematics of reliability theory, and Jorgenson, McCall, and Radnor (1967) considered the problem of finding optimal maintenance policies.

The thread begun by Neyman and Pearson and followed so beautifully by Wald was also continued by Von Neumann and Morgenstern (1944) in their classic text on the theory of games. This work was in turn integrated into modern decision theory by Blackwell and Girshick (1954) and extended toward what we now call decision analysis by the French school, as reported in Masse (1962).

The third era, beginning in 1960 with the work at United Airlines, saw yet a new focus on the problem. Whereas the applications of the 1930s had concentrated on the problems of producing and acquiring appropriate quality, and the works that followed were concerned with reliability (the quality experienced over time in use) and its implications for design, attention now turned to the acquisition of appropriate information—frequently in a context in which it was easier to get too much, rather than too little.

While Nowlan, Matteson, and others at United Airlines were carefully studying the age-reliability characteristics of complex equipment to determine precisely what good, if any, preventive maintenance

could do, Magee (1964a, 1964b) was exploring the possibilities of decision diagrams based on an evaluation of the consequences of decisions. In the statistical area, Tukey (1960) pointed out the distinctions between actions and conclusions and thereby laid the framework for modern data analysis. And on yet another front, information science began to evolve out of bibliometrics and information-retrieval studies.

Now, in turn, the monograph literature is ready to catch up with the developments already published in proceedings and journals. The National Academy of Sciences (National Research Council, 1976) has already published an extensive report on setting statistical priorities which shows the interrelationship between information science and statistics and pays particular attention to the problems of establishing the utility of data in contexts where there may be far too much for easy assimilation. Raiffa (1968), Schlaifer (1969), and others have routinized decision analysis to the point where it is being applied in an increasing number of areas.

The present text on reliability-centered maintenance carries the development one step further. By reversing the order of the questions on decision diagrams, so that consequences are evaluated first instead of last, and in gross rather than fine terms, Nowlan and Heap have shortened the path between decision making and data gathering in an important way. Their emphasis on the use of the decision diagram as an audit trail which links decision making to results is strongly reminiscent of Shewhart's (1931) reasoning in establishing quality-control charts and Demos' (1955) integration of such charts into a quality-control system. Finally, their integration of data in the ongoing process goes a long way toward formalizing the process of modifying decisions as hard information develops. As such, it bears a mild resemblance to the work of George Box (1957) on evolutionary operation, although the latter presupposed the opportunity to modify the variables in an ongoing process for gradual improvement of performance, whereas the reevaluation in this case is consequence-centered and connected only through that mechanism to performance.

D·2 RELIABILITY THEORY AND ANALYSIS

In their excellent summary of the historical background of the mathematical theory of reliability, Barlow and Proschan (1965) begin with the pioneering work of Khintchine (1932), Weibull (1939), Palm (1943), and others in the 1930s and 1940s. In this work it seems natural to start with the key paper by Altman and Goor (1946) on the reliability of engines used in the B-29 aircraft in World War II). Altman and Goor used actuarial methods of the life insurance industry and provided a detailed example to illustrate this usage. Their primary interest was in the supply

problem, which required an estimate of the proportion of the engines that would fail prior to their hard-time removal. Since they assumed that there was an appropriate time to remove an engine from the aircraft, the only problem from their point of view was determining the conditional probability of failure prior to this removal time. In addition to the actuarial analysis, they also noted that the frequency of engine failures plotted as a log function of total flying time was approximately a straight line, which has implications for the underlying failure distribution. Altman and Goor also compared the results for new engines with those that had been removed, overhauled, and returned to the field and noted that the overhauled engines had a significantly shorter average life. There was no hint in their work, however, that this should be used as a basis for extending the overhaul interval.

In 1950 D. J. Davis produced a report for the Rand Corporation which was later published in modified form in the *Journal of the American Statistical Association* (Davis, 1952). He considered both the normal failure law and the exponential failure law and showed that failures for a number of types of equipment, particularly electronic components and other complex items, were better approximated by the exponential failure distribution. Davis also inquired into the nature of the failure mechanism as a means for understanding the appropriateness of the failure distribution and discussed (briefly) the problem of finding optimal replacement policies.

A number of other papers appeared about the same time, notably that by Weibull (1951) on the distribution that now bears his name and that by Epstein and Sabel (1953) on the utility of the exponential distribution, particularly in the treatment of electronic equipment. The 1950s also saw the beginnings of reliability study as a formal discipline, as marked by a meeting in New York City in 1952 on applications of reliability theory.

Other theoretical developments during this period included the work of Moore and Shannon (1956) on the theoretical determination of reliability in networks and a theoretical justification by Drenick (1960) of the use of the exponential distribution for complex equipment with no dominant failure modes. By this time the empirical and theoretical developments in reliability had led to an increased interest in maintainability. This term has been used in several ways, but here it refers to those aspects of design provided to facilitate maintenance by making parts that are likely to fail easy to replace and/or easy to inspect. Much of the design development in the 1950s, particularly that associated with development of intercontinental ballistic missiles, had to do with improved reliability through design, including the use of redundant parts and the burn-in of parts with high rates of infant mortality. The latter was investigated by ARINC (Aeronautical Radio, 1958) with respect to electron tubes.

Barlow and Scheuer (1971) consider some of the problems of estimation from accelerated life tests. Included is a useful bibliography by Winter et al. (1964) of 20 papers in this area. Ladany and Aharoni (1975) discuss maintenance policy of aircraft according to multiple criteria. This paper is worthy of note primarily because it is a recent work that does not appear to make use of the developments that occurred between 1963 and 1975. As a result, the writers are not convinced of the utility of exponential distributions in reliability analysis and take a somewhat peculiar view of the field with regard to optimum checking procedures, given an exponential distribution. Miller and Singpurwalla together and singly produced a series of three papers on the theoretical aspects of maintained systems (Miller, 1975, 1976; Miller and Singpurwalla, 1977).

Yet another aspect of the theoretical problem is the problem of computing the reliability of complex networks. This derives from the difficulty of determining how a piece of complex equipment will in fact perform, given the reliability of its several components and the mathematical form of their interaction. Rosenthal (1977) summarizes this problem nicely and includes useful references.

There is a fairly standard set of literature on the estimation problems involved in actuarial analysis, and while fine estimation is not usually necessary, a paper by Rice and Rosenblatt (1976) covers the area well for those who wish to make use of it. The actuarial techniques for studying the utility of overhaul policies were well laid out by Altman and Goor (1946) and are illustrated by Matteson (1966) with two different smoothing techniques. Another smoothing technique is suggested by Barlow and Campo (1975). Their proposal is identical to the method recommended in this text (Appendix C), except that each scale is divided by its maximum value and the inverse function is plotted, so that increasing failure rates plot as concave rather than convex curves. The utility of plotting both axes on (0,1) is that it simplifies the comparison to standard failure laws (such as Weibull) through the use of overlays. The reciprocal of the slope is proportional to (rather than equal to) the conditional probability of failure. With appropriate assumptions, the TTT plot, as it is called by Barlow and Campo, can also be used to find the optimal overhaul interval by graphical means, as is shown by Bergman (1977). Bergman also calls attention to an earlier work (Bergman, 1976) and to Ingram and Scheaffer (1976). For a more general discussion of smoothing methods and their advantages and disadvantages, see Tukey (1977), particularly chap. 7.

Other useful papers in the theoretical area include a summary of current academic research by Barlow and Proschan (1976*b*), a discussion of Bayesian zero-failure reliability-demonstration testing procedure by Waller and Martz (1977), and papers by Martz and Lian (1977) and Martz and Waterman (1977) on other aspects of this problem. Martz, Campbell, and Davis (1977) consider the use of the Kalman filter in

estimating and forecasting failure-rate processes and provide an interesting and useful bibliography of work in this general area, including some 27 papers.

As a final note on reliability theory, a paper by D. C. Bridges (1974) on the application of reliability to the design of ship's machinery offers a concise discussion of this field as of 1974. In addition to a brief summary of reliability theory and techniques generally associated, there is an almost passing mention of data collection and failure modes and effects analysis. The paper concludes with a discussion by several other participants in the forum and a reply by the writer, and these comments help to point out the essence of the problem as it relates to design. Unfortunately this paper does not go the next step and consider the problems of reliability-centered maintenance from the user's point of view.

D·3 INFORMATION SCIENCE AND DECISION ANALYSIS

The fields of information science and decision analysis, with their substantial overlap, are well covered in an excellent bibliography by Lawrence (1976), titled *The Value of Information in Decision Making*. The bibliography is an appendix to a National Academy of Sciences report on setting statistical priorities and covers 184 items in a field Lawrence defines as *information science*. It is broken down into several sections: comparing information structures; user needs and parameters of information-seeking and valuation behavior; managing information systems; decision making under uncertainty, the expected value of information; the economics of lack of perfect information; information and governmental policy; quantitative economic policy; the value of economic forecasts; does the market overprovide or underprovide for knowledge production; information theory, including statistics; and applications to economics and psychology. A good many of the papers cited are addressed to questions of how information affects policy. While the emphasis is on application to governmental problems, the papers in general are much broader. There is a heavy emphasis on information in economic structures, and hence on the attempt to relate information to costs of decisions.

There are several papers on the information problem in maintenance that are worthy of note. Hadden and Sepmeyer (1956) gave a relatively short paper on the methodology for reliable failure reporting from maintenance personnel which raised some useful questions on consideration of the human factor. Shapero, Cooper, Rappaport, and Schaffer (1960) considered the problem of data collection in weapon systems test programs. Bell (1965) gave a talk on information needs for effective maintenance management to the DOD Logistics Research Con-

ference that is worth reading. During the same period there were several studies of the data problem in the military, including one by Cohen, Hixon, and Marks (1966) on maintenance-data collection and the Air Force base-maintenance management system. More recently Dudley, Chow, Van Vleck, and Pooch (1977) have discussed how to get more mileage out of data.

The formal term *decision theory* today usually refers to the work originally done by Abraham Wald (1947) in the late 1930s and early 1940s, in which he formulated the sequential decision problem as a special case of sampling theory. A considerable volume of literature derives from Wald's work.

The next stage historically is the development of the theory of games, and the classic work on this is Von Neumann and Morgenstern (1944). The first detailed application of this theory to business decisions appears to be the work reported by Masse (1962). Shortly thereafter Magee brought this concept to the attention of a broader community through the publication of two articles in the *Harvard Business Review* (Magee, 1964a, 1964b). A good deal of the literature following Magee has to do with investment decision making, and the basic thrust of the use of a decision tree for such purposes is that the tree is laid out first in terms of the available decisions and next in terms of the various possible actions, including those not under the control of the decision maker. Where it is reasonable to postulate a probability distribution for the actions not under the control of the decision maker, this can be done; the form of the tree then provides outcomes at each terminal in such a way that their expected dollar values can be computed, given the appropriate information.

There is a fairly large literature showing applications of this approach, of which the following is but a sampling to indicate the breadth of the activity: Flinn and Turban (1970) on decision-tree analysis for industrial research; Berger and Gerstenfeld (1971) on decision analysis for increased highway safety; Chinn and Cuddy (1971) on project decision and control; Gear, Gillespi, and Allen (1972) on the evaluation of applied research projects; Swager (1972) on relevance trees for identifying policy options; Berger (1972) on implementing decision analysis on digital computers; Feldman, Klein, and Honigfel (1972) on decision trees for psychiatric diagnosis; Whitehouse (1974) on decision flow networks; Rubel (1975) on logic trees for reactor safety; and Wheelwright (1975) on decision theory for corporate management of currency-exchange risks.

There are three standard texts in this area that should be noted: Schlaifer (1969), Raiffa (1968), and Keeney and Raiffa (1976). Schlaifer's book is a nonmathematical text for business students which goes into the details of the decision problem extensively with a number of prob-

lems and references to standard Harvard case studies. Raiffa's treatment is more sophisticated. Chapter 9, *The Art of Implementation*, and *A General Critique*, provides a nice summary of the presentation which goes beyond the step procedures and begins to evaluate how the process is actually used in real problems, including messy real problems. Chapter 10 also provides a concise history of the subject, together with useful observations about the interrelationship of statistics, information theory, and decision theory. In a very brief bibliography at the end of the book Raiffa calls attention to Fellner (1965), which includes an excellent annotated bibliography on 52 well-chosen texts.

In the preface to his book Raiffa (1968) lists the following steps for analysis of a decision problem under uncertainty:

- ▶ List the viable options available to you for gathering information, for experimentation, and for action.
- ▶ List the events that may possibly occur.
- ▶ Arrange in chronological order the information you may acquire and the choices you may make as time goes on.
- ▶ Decide how well you like the consequences that result from the various courses of action open to you.
- ▶ Judge what the chances are that any particular uncertain event will occur.

It is interesting to compare this list of priorities with those on which RCM decision analysis is based:

- ▶ Framing the questions to determine the consequences of failure in such a way as to define the information required to make the decision
- ▶ Framing the questions to select those maintenance tasks which are both applicable and effective
- ▶ Specifying the default action to be taken when information is lacking
- ▶ Extending the approach to the determination of when to make economic-tradeoff studies for cases that are both important and too close to call
- ▶ Providing for the subsequent action to be taken when in-service information begins to accumulate

The first application of the decision diagram to aircraft maintenance problems was developed by F. S. Nowlan (1965) at United Airlines. This internal document noted the importance of the mechanism of

failure, the need for information about inherent reliability characteristics, and the conditions necessary for scheduled overhaul to be effective. The simple decision diagram presented was not unlike the top portion of the RCM decision diagram described in this text, in which the fundamental questions have to do with (1) the evidence of failure and (2) the consequences of failure. A condensed version of this report was also included in a paper presented at an FAA maintenance symposium in November 1965 (Taylor and Nowlan, 1965).

These concepts were expanded on in a later paper by Matteson and Nowlan (1967), and the decision diagram presented in this work was the basis for MSG-1, *Handbook: Maintenance Evaluation and Program Development* (747 Maintenance Steering Group, 1968). This document led to further improvements, published as MSG-2, *Airline/Manufacturer Maintenance Program Planning Document* (Air Transport Association, 1970). These developments were also reported on by Dougherty (1970), Matteson (1972b), and Nowlan (1972). A European version of MSG-2, *European Maintenance Systems Guide* (A-300 B Maintenance Steering Committee, 1972), appeared only a few years later.

D·4 MAINTENANCE THEORY AND PHILOSOPHY

Design developments in the aircraft industry from 1930 to 1960 greatly improved operating safety and resulted in more maintainable equipment. However, these two objectives also had the combined effect of significantly increasing the complexity of equipment and reducing the utility of hard-time limits. In a review paper published in 1968, W. C. Mentzer observed that United Airlines began work under his direction in 1960 on two basic questions: "Do we understand the fundamental principles which underlie the way we maintain our aircraft?" and "Do we really know why we do what we do?". The incentive for a thorough investigation into these questions was provided by the very simple fact that maintenance of aircraft for typical airlines in the United States at that time represented approximately 30 percent of total direct and indirect operating costs. The general history of this development is well summarized in Appendix B of this book.

John F. McDonald (1963) presented a detailed and highly readable paper titled *Reliability, a Random Discussion*, in which he takes a closer look at the overall problem of reliability, the difficulties of predicting performance in the field prior to actual experience, and the utility of hard-time limits in actual operation. As a vehicle for carrying his general discussion, he repeatedly cites quotations from Oliver Wendell Holmes' famous poem *The Deacon's Masterpiece, or The Wonderful "One-Hoss Shay," A Logical Story*, including the key line that states "A

chaise *breaks down*, but doesn't *wear out*." The suggestion that Oliver Wendell Holmes is the true father of modern maintenance theory would perhaps not be well met in all circles, but the observation that "things break down but do not wear out" is, of course, one of the keys to the understanding of the maintenance process for complex items. J. J. Eden (1963), in a paper titled *Engine Overhaul Life, An Outdated Concept*, makes the point quite clearly from his experience with TransCanada.

The inherent difficulties in predicting reliability first suggested by McDonald were reiterated in two papers presented at the 1965 Meeting on Reliability and Maintainability in Los Angeles. The titles are enough to indicate the difficulty: Finocchi (1965) wrote that *Reliability Has Failed to Meet Its Goals*, and Grose (1965) titled his paper *Reliability Can Be Predicted? (A Negative Position)*. Matteson (1966) provided additional insight into the use of reliability analysis of in-service equipment as a guide for reducing maintenance cost and spare-parts requirements.

Ashendorf (1967) added further ideas in this direction by noting the "pitfalls in reliability predictions." In all these works, from McDonald to Ashendorf, one senses the growing recognition that maintenance must be able to cope with performance that falls short of design prediction. This implies the need to redesign and/or change mission requirements to allow the user to get the maximum performance from the equipment. Maintenance in turn must then be done in a context which allows redesign as a possibility and also is prepared for surprise, particularly in the early years of use of the equipment. These observations imply important economic consequences that must be planned for in preparation for the use and maintenance of the equipment.

For many years primary maintenance consisted of hard-time inspection and overhaul tasks. This concept underwent rapid reevaluation in the early 1960s, as pointed out by K. E. Neland (1966) in a paper presented at the Maintenance Symposium on Continued Reliability of Transport-type Aircraft Structure in Washington, D.C. Neland, then chief of the air-carrier maintenance branch of the Federal Aviation Agency, presented a brief history of developments of maintenance policies and procedures from the FAA point of view. In the first phase, he noted, most aircraft prior to World War II were subject to the one-step overhaul process. As a result of the rapid integration of surplus aircraft into commercial fleets after World War II, the late 1940s and 1950s were dominated by a set of phase inspections which provided the FAA, among others, with much more detailed information about the rate of deterioration of performance and safety features over a period of time. This history of deterioration allowed the FAA to take a much kinder view toward the philosophy of on-condition inspection, which became increasingly important after 1960.

In June of 1967 Matteson and Nowlan (1967) presented a paper titled *Current Trends in Airline Maintenance Programs* at the AIAA Commercial Aircraft Design and Operations Meeting in Los Angeles. In this paper they gave a generalized definition of a failure and discussed the mechanism by which failures occur. They then went on to develop a decision diagram to facilitate logical analysis of the decisions required during development of a scheduled-maintenance program. This discussion was essentially an update of Nowlan's earlier paper, and the decision diagram was considerably more detailed. It is this more detailed decision diagram that provided the basis a year later for MSG-1, a working paper prepared by the Maintenance Steering Group for the Boeing 747 (1968). This document was approved by the 747 interairline maintainability conference on July 10, 1968.

The Boeing 747 was the first turbine-powered wide-body aircraft to enter commercial aviation. The preparation of a maintenance program prior to service involved even greater concern about safety, given the large number of passengers this aircraft would be carrying. This exercise was the first application of the concept of reliability-centered maintenance. While the procedure is now somewhat better understood, the basic questions that had to be faced are the same today as they were a decade ago.

The work that led to the development of MSG-1 was not lost on the manufacturers of aircraft or on the FAA. Several papers appearing at about the same time made it quite clear that the relationship between the manufacturer's responsibility for maintainability and the user's responsibility for maintenance were closely interrelated. R. B. MacGregor (1968) spoke to this question directly at the Los Angeles Maintainability Association in September 1968. Matteson (1969) discussed in-service safety and reliability and the role of maintenance at some length. Nowlan (1969) reviewed the on-condition philosophies from a planning and operational viewpoint. Matteson (1969b) discussed the condition-monitoring path on the Boeing 747, and Adams (1969) provided further insight into the concept of increased safety through the new maintenance concepts. These developments all had some influence on the creation of the *Airline/Manufacturer Maintenance Program Planning Document, MSG-2* (Air Transport Association, 1970). This document, which was prepared as the starting point for the wide-body Douglas DC-10 and the Lockheed L-1011, represented a refinement of the MSG-1 procedures developed for the 747.

Also in 1970 the ATA Reliability and Maintainability Subcommittee, consisting of half a dozen members from as many airlines, presented a talk on reliability and maintainability from an airline standpoint (Roberson, 1970). At about the same time J. E. Dougherty, Jr. (1970) reviewed the development of the initial maintenance program for the Boeing 747 from the viewpoint of the Department of Transportation.

Other papers followed in order over the next year or two. Those which are of general interest include Schonewise (1971), Heap and Cockshott (1973), Matteson (1971a, 1971b, 1972b), Mellon (1972), and Nowlan (1972, 1973).

At this time also several writers began to look more closely at the relationship between nondestructive testing and full-scale testing as potential information generators for maintenance decisions. See, for instance, Matteson (1972a) and Stone (1973), and Dougherty (1974), who reviewed FAA activities over the preceding 15 years and made some suggestions as to where this activity was likely to go in the future.

The development of practicing maintenance was very nicely summarized by John F. McDonald (1972) in a paper presented to the Seventh Annual Convention of the Society of Logistics Engineers in August 1972. This paper, in addition to summarizing the history for commercial airlines, draws interesting comparisons between what is done in the airlines and what is feasible in the military, with some strong suggestions as to the utility of the techniques.

The obvious success of the principles embodied in Boeing 747 and Douglas DC-10 maintenance programs was noted by the Department of Defense, which, of course, has a substantial maintenance problem. A review of the McDonnell F4J, an aircraft already in service, was done by United Airlines (1974, 1975, 1977). Bell Helicopter Company published a report on flight-control-system reliability and maintainability investigations for the Army (Zipperer, 1975). The National Security Industrial Association (1975) issued an ad hoc study on the impact of commercial-aircraft maintenance and logistic-support concepts on the flight-cycle cost of air ASW weapons systems which provides some insight into the economic questions of maintenance in military systems. The Naval Air Systems Command (1975) also produced a management manual, NAVAIR 00-25-400, which provided a maintenance-plan analysis guide for in-service Naval aircraft, and Project Rand at about the same time issued a study from the Air Force point of view (Cohen, 1974). Rolf Krahenbuhl (1976) discussed the problem of maintaining transport aircraft at a meeting given at Oxford. The British Civil Aviation Authority (1976) produced a working draft on the safety assessment of systems in September 1976.

Returning to developments in the military in this country, Elwell and Roach (1976) reported on the scheduled-maintenance problems for the F4J aircraft. The following year Saia (1977) provided a comprehensive evaluation of changes in the U.S. Navy aircraft maintenance program and LaVallee (1977) prepared a Navy report on logistic support analysis. Lockheed, California, began an extended inquiry into the applicability of reliability-centered maintenance to Naval ships in 1977. The first report, *Availability Centered Maintenance Program Survey* (1977a)

was subsequently augmented by scheduled-maintenance program-development procedures (1977b).

Each of the basic types of maintenance tasks poses its own special problems with regard to the selection of optimal intervals, and in each case the problem must be further specified to a particular piece of equipment before it is resolvable. On-condition inspection, for instance, can be specified in terms of two intervals: the time to the first on-condition inspection and the repeat intervals after the first inspection. A recent article discussing this problem in structures (with some 23 references) is Johnson, Heller, and Yang (1977). The problem was also discussed in the broader context of an MSG-2 analysis of the Douglas DC-10 in Stone and Heap (1971). For a nonairline example see Arnett (1976). The possibility of mixing random inspections with regularly scheduled inspections in structure is considered in Eggwertz and Lindsjo (1970), *Study of Inspection Intervals*, which also contains a useful set of references.

The use of the exponential function for "random" failures as a basis for choosing inspection intervals for hidden functions was considered at length in Kamins (1960). Two other Rand reports consider "noisy" (imperfect) inspections (Eckles, 1967) and the problem of measuring time in military operations, where use per unit of calendar time can vary widely from one unit to the next (Cohen, 1972). The latter report also provides some insight into the problem of extending intervals in light of real operating experience.

Safe-life intervals provide an entirely different set of problems because of the need to establish the intervals through test results. A nice discussion of this is provided by Jensen (1965), who said:

It is not surprising that we have reached the conclusion that fatigue tests are not a panacea or cure-all to which we can turn in establishing a "safe-life." The assignment of a "safe-life" based on tests involves a great many assumptions. If these assumptions are wrong, we have the unpalatable result of a catastrophic failure.

One of the assumptions in setting safe-life intervals is that it is possible to accelerate a life test and determine from the accelerated test what can be expected later in real time.

The deeper question of whether scheduled overhaul might actually provide negative effects is discussed in two Navy documents of some importance, a study by LaVallee (1974) on aircraft depot-level maintenance, and one by Capra (1975) on engine maintenance.

In the course of designing and bringing a piece of complex equipment to production, there is a considerable amount of activity aimed at ensuring that the proper safety characteristics and overall system effectiveness measures are met. In a useful summary paper Grose (1971b) provides a breakdown of the basic areas of activity aimed at system

effectiveness: design review; development test analysis; failure analysis and corrective action; failure modes and effects analysis (FMEA); fault-tree analysis; life testing; maintainability evaluation; parametric-variability analysis; prediction, apportionment, and assessment; producibility analysis; stress testing; and tradeoff studies.

There is now a very large literature on the various aspects of system effectiveness, much of it specific to particular types of equipment, such as electronic components. The 1977 *Proceedings of the Annual Reliability and Maintainability Symposium* includes a representative set of papers. Spoomaker (1977) discusses reliability prediction for airplane-type springs. Bertolino and Grefsrud (1977) consider the failure analysis of digital systems using simulation. Hughes, Fischler, and Rauch (1977) provide some idea of how to use pattern recognition in product assurance. Onodera, Miki, and Nukada (1977) discuss a variation of the failure modes and effects analysis, which they call HI-FMECA, in making a reliability assessment for heavy machinery. Bishop et al. (1977) go over a number of aspects of reliability availability, maintainability, and logistics. Dennis (1977) considers prediction of mechanical reliability, nondestructive evaluation, and other present and future design practices. Plouff (1977) provides some information on avionic reliability experience for the AR-104 and the 781B.

These proceedings also have three rather interesting papers on reliability and maintainability experiments. McCall (1977) discusses the statistical design of such experiments, Herd (1977) carries this a step further, and Gottfried (1977) provides a brief discussion of the interpretation of statistically designed R & M tests.

Other work in this general area includes an evaluation by Barlow and Proschann (1976a) of the techniques for analyzing multivariate failure analysis and an article by Cooper and Davidson (1976) of the parameter method for risk analysis. Callier, Chan, and Desoer (1976) consider the input-output problem using decomposition techniques. The use of input-output methods goes back to Leontif and has been widely used in an attempt to analyze complex economic systems. However, these techniques have not been in great use for analysis of the reliability of a maintained piece of complex equipment for reasons that are clear from the present text.

Weiss and Butler (1965), in a paper entitled *Applied Reliability Analysis*, give a brief summary of the basic problem from design to application, the analytic and information difficulties therein, and the typical methods used to cope with these difficulties. Another aspect of the design problem, now called *common-failure-mode analysis*, appears when a system designed to have redundant features to protect safety and reliability has at the heart a common failure mode that can remove the perfection provided by the redundancy. A summary discussion in this area is given by Apostolakis (1976).

D·5 MAINTENANCE APPLICATIONS

The main applications of reliability-centered maintenance as described in this text are to commercial and military aircraft, and the primary documents that one should study to get a full feeling for the depth of the application are the Maintenance Review Board documents for these aircraft, notably the Boeing 747, the Douglas DC-10, and the Lockheed L-1011. The simple act of leafing through page after page of summary worksheets, which show how the decisions were made for each of the significant items, provides a feeling of the reality of these procedures in practice on important physical equipment.

However, these documents are not widely available, and they are, of course, quite bulky—typically running to 12 inches or more of standard of $8\frac{1}{2} \times 11$ paper. A much shorter, but still interesting, overview of this process is provided by the *Orion Service Digest* (1976), which summarizes the studies for the Lockheed P3 maintenance program. Among other things, this document provides a good picture of the packaging problem, showing when the various tasks have to be done and how they are grouped together. The reports by United Airlines (1974, 1975a, 1975b), which conducted the comparable study for the McDonnell F4J, include a fairly short report on the analysis process, as well as a nice breakdown of the zonal description and inspection requirements.

In 1975 the Institute for Defense Analyses prepared an extensive set of reports titled *Accomplishing Shipyard Work for the United States Navy* (Heinze, 1975; Morgan et al., 1975). These reports do not get to the problem of reliability-centered maintenance as currently conceived, but rather provide extensive detail on the context in which a Navy shipyard maintenance program must be implemented. The third volume of the reports, by Heinze (1975), includes an extensive bibliography on the subject.

Another picture of the problem from the Navy point of view was developed by the Naval Underwater Systems Center at New London (Howard and Lipsett, 1976) and published under the title *Naval Sea Systems Operational Availability Quantification and Enhancement*. This is a fairly extensive report that tries to provide the overall context of the problem, not just the maintenance problem itself, and the inherent difficulties in trying to establish system effectiveness measures, availability measures, and the like in the Naval situation.

At a more detailed level, the literature about maintenance of aircraft can be broken into the three primary major divisions of the aircraft—structures, powerplants, and systems. The literature on systems is largely devoted to the reliability of particular components. The litera-

ture on structures is generally easier to obtain because the structure as an integrated entity is generally subject to the common problems of corrosion and fatigue, and the signals of reduced resistance to failure are primarily those obtained by inspecting for cracks and leaks.

One view of the problem addressed specifically to maintenance problems of structures can be found in the Lockheed L-1011.385-1 maintenance program, submitted to the FAA as justification for this program. Section 3 on structures is brief, but to the point, and provides useful background. The Douglas DC-10 structural inspection program, also developed by analysis techniques which were the immediate predecessor of RCM analysis, was described extensively in a report by Stone and Heap (1971). This paper provides a history of structural analysis and a general description of the techniques employed.

The literature on powerplant maintenance problems is quite extensive. Rummel and Smith (1973) conducted a detailed investigation of the reliability and maintainability problems associated with Army aircraft engines. This report is primarily devoted to a careful examination of the ways that engines can fail and the causes for removals. It is pertinent to note that in this study over 40 percent of the engine removals were for unknown or convenience reasons. Over half the remaining engine removals were accounted for by foreign-object damage, improper maintenance, leakage, erosion, operator-induced problems, etc. The report provides a useful perspective on the overall maintenance problem in the Army's use of such equipment.

Sattar and Hill (1975) discussed the problems of designing jet-engine rotors for long life. Edwards and Lewis (1973) updated the Taylor and Nowlan (1965) report on United Airlines' turbine-engine maintenance program, and Nowlan (1973) presented a further report on the general background and development of this program.

The Center for Naval Analyses (Capra et al., 1975) did its own survey of aircraft engine maintenance, which concluded that within the current range of operations "engines wear in but do not wear out." This, of course, led to a recommendation that policies which would decrease the number of overhauls performed and increase the time between overhauls appeared to be reasonable from a reliability and safety standpoint. Historically, this report provided a major impetus for the further study of reliability-centered maintenance in the Navy.

Boeing-Vertol also prepared a report on turbine-engine reliability for the Eustis directorate of the U.S. Army (Rummel and Byrne, 1974). This was a follow-up to the report by Rummel and Smith (1973) on Army aircraft engines and includes a careful overall description of the problems of maintenance in the armed services. This report notes in particular that one of the primary problems is the problem of maintenance damage:

Previous studies have shown that maintenance damage is a problem of similar magnitude in the three military services and is at least 10 times that which had been experienced in the commercial airlines service.

This difficulty is at least partially attributable to the higher turnover in service personnel than is common in commercial airlines, which makes an important difference in the overall picture of maintenance analysis for the military. It becomes even more critical in military applications to ensure that unnecessary maintenance is carefully eliminated from the maintenance schedule because of the relatively high probability that it will in fact worsen the condition of the equipment.

Two recent papers might also be mentioned, as they point the way toward increased emphasis on life-cycle analysis and logistics, which includes, of course, the cost of maintenance as part of the overall cost of operations. Nelson (1977) discusses the life-cycle analysis of aircraft turbine engines in summary form from the executive point of view. Benet and Shipman (1977) discuss a logistics-planning simulation model for Air Force spare-engine management.

Among the systems applications Cole (1971) provides a useful look at effective avionic maintenance. Another example of a system of critical importance is the helicopter transmission; this system is not redundant, and a transmission failure can have critical consequences for the helicopter. Dougherty and Blewitt (1973) published a thorough study of the possible uses of on-condition maintenance for helicopter transmissions which provides insight into the nature of criticality analysis, as well as the utility of on-condition maintenance as a maintenance philosophy.

Another interesting set of papers on reliability theory was compiled by Barlow, Fussell, and Singpurwalla (1975). This publication includes papers by well-known writers on eight different topics: fault-tree methodology, computer analysis of fault trees and systems, mathematical theory of reliability, theory of maintained systems, statistical theory of reliability, network reliability, computer reliability, and reliability and fault-tree applications. It is an excellent summary of the state of the art in this area as of 1975.

D·6 A GUIDE TO OTHER SOURCES

The first major bibliography on reliability was prepared by Mendenhall (1958) and updated by Govindaragulu (1964). The most recent bibliography appears to be one by Osaki and Nakagawa (1976). In addition to these special bibliographies, a number of books provide very useful annotated bibliographies. Some of these already cited include Duncan

(1953) on quality control, Barlow and Proschan (1965) on the mathematical theory of reliability, and Lawrence (1976) on information science. It should also be noted that most of the journal papers on the subject are well-indexed in on-line data bases and printed indexes. Another useful bibliography is one put together by the U.S. Air Force (1977), which is broken down into several sections: equipment and systems reliability in maintenance, reliability physics, solid-state applications, and software reliability studies.

There are also several basic publications that group together papers of direct interest on this multifaceted subject. The *IEEE Transactions on Reliability*, now in its twenty-sixth volume, covers much of the reliability theory and applications to electronic equipment. From 1954 to 1965 there was a yearly National Symposium on Reliability and Quality Control, renamed from 1966 to 1971 the Annual Symposium on Reliability. Concurrently from 1962 to 1971 there was a Reliability and Maintainability Conference. In 1972 these two activities were merged as the Annual Reliability and Maintainability Symposium, which is still the current title. As will have been noted from a casual inspection of the following reference list, a large number of the papers cited in this bibliography first appeared in one of these annual proceedings.

- Adams, H. W. (1969) Increased Safety through New Maintenance Concepts, Fifth Annual Aviation Maintenance Symposium, Oklahoma City, Ok, December 9-11, 1969 (Douglas 5698).
- Aerojet Nuclear Systems (1970) *Instructions for System Failure-mode, Effect, and Criticality Analysis for the Nerva Engine*, Aerojet Nuclear Systems Company, Sacramento, Ca, July 1, 1970.
- Aeronautical Radio, Inc. (1958) *A Selection of Electron Tube Reliability Functions*, Aeronautical Radio, Inc., Reliability Research Department, Washington, DC, 1958 (ARINC Publ. 10).
- Air Transport Association (1970) *Airline/Manufacturer Maintenance Program Planning Document: MSG-2*, Air Transport Association R&M Subcommittee, Washington, DC, March 25, 1970.
- Altman, Oscar L., and Charles G. Goor (1946) Actuarial Analysis of the Operating Life of B-29 Aircraft Engines, *J. Am. Statist. Assoc.*, **41**:190-203.
- Apostolakis, George E. (1976) Effect of a Certain Class of Potential Common Mode Failures on the Reliability of Redundant Systems, *Nucl. Eng. Des.*, **36**(1):123-133.
- Arnett, L. M. (1976) *Optimization of Inservice Inspection of Pressure Vessels*, Energy Research and Development Administration, Savannah River Laboratory, Aiken, SC, 1974-1976.
- Ashendorf, George (1967) Pitfalls in Reliability Predictions, *Ann. Reliability Maintainability*, **6**:576-581.
- Association of European Airlines (1976) *European Maintenance Systems Guide to Developing Initial Maintenance Programmes for Civil Air Transport: EMSG-2*, Association of European Airlines, M&R Subcommittee, March, 1976 (draft).

- Barlow, R. E., and R. A. Campo (1975) *Total Time on Test Processes and Applications to Failure Data Analyses*, John Wiley & Sons, Inc. (SIAM Series), New York, NY, 1975.
- Barlow, R. E., J. B. Fussell, and N. D. Singpurwalla (1975) *Reliability and Fault Tree Analysis*, Society for Industrial and Applied Mathematics, Philadelphia, Pa, 1975.
- Barlow, R. E., L. C. Hunter, and F. Proschan (1963) Optimum Checking Procedures, *J. Soc. Ind. Appl. Math.*, **11**(4):1078-1095.
- Barlow, R. E., and Frank Proschan (1965) *Mathematical Theory of Reliability*, John Wiley & Sons, Inc., New York, NY, 1965.
- Barlow, R. E., and Frank Proschan (1976a) *Techniques for Analyzing Multivariate Failure Data*, University of California, Berkeley, Operations Research Center, Berkeley, Ca, April 1976 (ORC 76-11).
- Barlow, R. E., and Frank Proschan (1976b) Some Current Academic Research in System Reliability Theory, *IEEE Trans. Reliability*, **R-25**(3):198-202.
- Barlow, R. E., and Ernest M. Scheuer (1971) Estimation from Accelerated Life Tests, *Technometrics*, **13**(1):145-159.
- Bell, C. F., Jr. (1961) Throw Away Maintenance Policies, *Rand Abstracts*, Rand Corporation, Santa Monica, Ca, October 1961.
- Bell, C. F., Jr. (1965) Information Needs for Effective Maintenance Management, Rand-DOD Logistics Research Conference, Maintenance and Repair Concepts, Warrenton, Ca, May 26-28, 1965; Rand Corporation, Santa Monica, Ca, August 1965 (Rand Rept. P-3180, AD 619 702).
- Benet, Humberto J., and Charles H. Shipman (1977) Logistics Planning Simulation Model for USAF Spare Engine Management, *Proc. Ann. Reliability Maintainability Symp.*, **1977**:500-505.
- Berger, P. D., and A. Gerstenfeld (1971) Decision Analysis for Increased Highway Safety, *Sloan Management Rept.*, **12**:11-23.
- Berger, Roger W. (1972) Implementing Decision Analysis on Digital Computers, *Eng. Econ.*, **17**(4):241-248.
- Bergman, Bo (1976) *Crossing in the Total Time on Test Plot*, University of Lund, Department of Mathematical Statistics, Lund, Sweden, 1976 (LUNFD6/NFMS-3043/1-21).
- Bergman, Bo (1977) Some Graphical Methods for Maintenance Planning, *Proc. Ann. Reliability Maintainability Symp.*, **1977**:467-471.
- Bertolino, Luciano, and Leif E. Grefsrud (1977) Failure Analysis of Digital Systems Using Simulation, *Proc. Ann. Reliability Maintainability Symp.*, **1977**:432-441.
- Bishop, Lawrence L., et al. (1977) Reliability, Availability, Maintainability/Logistics (RAM/LOG), *Proc. Ann. Reliability Maintainability Symp.*, **1977**:49-68.
- Blackwell, E., and M. A. Girshick (1954) *Theory of Games and Statistical Decisions*, John Wiley & Sons, Inc., New York, NY, 1954.
- Box, George (1957) Evolutionary Operation: A Method for Increasing Industrial Production, *Appl. Statist.*, **6**:81-101.
- Bridges, D. C. (1974) Application of Reliability to the Design of Ships' Machinery, *Trans. Inst. Marine Eng. (GB)*, ser. A, **86**(6):109-122.

- C-E-I-R (1965) *Evaluation of Proposed OD 29394: Guide Manual for Reliability Measurement Program*, C-E-I-R, Inc., Los Altos, Ca, January 21, 1965 (contract NOSP 64031-C-FBM).
- Callier, F. M., W. S. Chan, and C. A. Desoer (1976) Input-output Stability Theory of Interconnected Systems Using Decomposition Techniques, *IEEE Trans. Circuits Syst. (USA)*, **23**(12):714-729.
- Capra, James R., et al. (1975) *Aircraft Engine Maintenance Study*, Institute of Naval Studies, Center for Naval Analyses, Arlington, Va, November 21, 1975 (CNS 1060, contract N00014-76-C-0001).
- Chinn, J. S., and W. A. Cuddy (1971) Project Decision and Control: A Case History, *Chem. Eng. Prog. (USA)*, **67**(6):17-21.
- Civil Aviation Authority (1976) *The Safety Assessment of Systems: British Civil Airworthiness Requirements*, CAA Airworthiness Paper 670:1, September 1976.
- Civil Aviation Authority (1978) *Continuing Structural Integrity of Transport Aeroplanes*, CAA Airworthiness Notice 89, August 23, 1978.
- Clarke, A. D. (1965) *Methods of Structural Reliability Substantiation of CH-54A Components Based on Laboratory Fatigue- and Flight-test Data (Preliminary)*, United Aircraft, Sikorsky Aircraft Division, Stratford, Ct, November 25, 1965 (rept. sER. 65189), (contract NOW 63-0150f).
- Cohen, I. K. (1972) *Aircraft Planned Inspection Policies: A Briefing*, Rand Corporation, Santa Monica, Ca, June 1972 (Rand Rept. R-1025-PR, AD 748 990).
- Cohen, I. K., et al. (1974) *Background Studies, Alternatives, and Framework for Addressing Maintenance Posture Improvement*, Working Note for U.S. Air Force Project Rand, Rand Corporation, Santa Monica, Ca, October 1974 [WN(L)-8852-PR, app. WN(L)-8852/1-PR].
- Cohen, I. K., O. M. Hixon, and Barbara G. Marks (1966) *Maintenance Data Collection and Workload Control Information Systems: A Case Study*, Rand Corporation, Santa Monica, Ca, November 1966 [Rand Rept. RM-4985-PR, contract AF 49(638)-1700, AD 645 994].
- Cole, Robert A. (1971) Effective Avionic Maintenance, Seventh Annual FAA International Aviation Maintenance Symposium, Oklahoma City, Ok, December 7-9, 1971.
- Cooper, D. O., and L. E. Davidson (1976) Parameter Method for Risk Analysis, *Chem. Eng. Prog.*, **72**(11):73-78.
- Dallaire, E. E. (1969) Space Technology: Potential Payoff for CPI, *Chem. Eng.*, **76**(18):119-124.
- Davis, D. J. (1950) *An Analysis of Some Failure Data*, Rand Corporation, Santa Monica, Ca, October 25, 1950 (Rand Rept. P-183); *J. Am. Statist. Assoc.*, **47**(258):113-150 (1952).
- Demos, N. P. (1955) Master Control System in General Electric, *Ind. Qual. Control*, **12**(4):17-21.
- Dennis, Norman G. (1977) PMR, NDE Design Practices: Present and Future, *Proc. Ann. Reliability Maintainability Symp.*, **1977**:164-169.
- Dodge, H. F., and H. G. Romig (1944) *Sampling Inspection Tables: Single and Double Sampling*, John Wiley & Sons, Inc., New York, NY, 1944.

- Donaldson, T. S. (1971) *A Study of IRAN Effectiveness for the F-106*. Rand Corporation, Santa Monica, Ca, August 1971 (Rand Rept. R-755-PR).
- Dougherty, James E., Jr. (1970) Development of the Initial Maintenance Program for the Boeing 747, AIAA Second Aircraft Design and Operations Meeting, Los Angeles, Ca, July 20-22, 1970 (AIAA 70-889).
- Dougherty, James E., Jr. (1974) It's Time to Change, ATA Engineering and Manufacturing Forum, Dallas, Tx, September 17-19, 1974.
- Dougherty, J. J., III, and S. J. Blewitt (1973) *Analysis of Criteria for On-condition Maintenance for Helicopter Transmissions*, Boeing, Vertol Division, Philadelphia, Pa, September 1973 (Boeing D210-10593-1, contract DAAJ02-72-C-0068, USAAMRDL-TR-73-58, AD 773 024).
- Dougherty, J. J., III, and K. G. Rummel (1972) *Capability of CH-47C Forward, Aft, and Combining Gear Boxes for "On-Condition" Operation*, Boeing, Vertol Division, Philadelphia, Pa, March 17, 1972 (code 77272, Boeing D210-10367-1).
- Drenick, R. F. (1960) The Failure Law of Complex Equipment, *J. Soc. Ind. Appl. Math.*, 8(4):680-690.
- Drezner, S. M., and R. L. Van Horn (1968) *Design Considerations for a Computer-assisted Maintenance Planning and Control System*, Rand Corporation, Santa Monica, Ca, February 1968 (Rand Rept. RM-5255-PR, P-3765, AD 665 451).
- Dudley, R. H., T. R. Chow, S. E. Van Vleck, and R. J. Pooche (1977) How to Get More Mileage Out of Your Data, *Proc. Ann. Reliability Maintainability Symp.*, 1977:414-420.
- Duncan, A. J. (1953) *Quality Control and Industrial Statistics*, Richard D. Irwin, Inc., Homewood, Il, 1953.
- Eckles, James E. (1967) *Optimum Maintenance with Incomplete Information*, Rand Corporation, Santa Monica, Ca, August 1967 (Rand Rept. RM-5390-PR, contract F44620-67-C-0045, AD 657 010).
- Eden, J. J. (1963) Engine Overhaul Life: An Outdated Concept, ATA Annual Maintenance and Engineering Conference, Washington, DC, October 31, 1963.
- Edwards, Thomas M., Jr., and Hu Lew, Jr. (1973) The Development of a Turbine Engine Maintenance Program from a New Reliability Model, SAE Air Transportation Meeting, Miami, Fl, April 24-26, 1973 (SAE 730374).
- Eggwertz, Sigge, and Goran Lindsjö (1970) Study of Inspection Intervals for Fail-safe Structures, Sixth ICAF Congress, Munich, Germany, September 13, 1968; Flygtekniska Försökstanstalten, Aeronautical Research Institute of Sweden, Stockholm, Sweden, January 1970 (FFA 120).
- Eisenhart, C., M. W. Hastay, and W. A. Wallis (1947) *Techniques of Statistical Analysis*, McGraw-Hill Book Company, Inc., New York, NY, 1947.
- Elwell, R., and C. D. Roach (1976) *Scheduled Maintenance Policies for the F-4 Aircraft: Results of the Maintenance Posture Improvement Program*, Rand Corporation, Santa Monica, Ca, June 1976 (Rand Rept. R-1942-PR).
- Epstein, B., and M. Sabel (1953) Life Testing, *J. Am. Statist. Assoc.*, 48(263): 486-502.
- Feldman, S., D. F. Klein, and G. Honigfel (1972) Reliability of a Decision Tree Technique Applied to Psychiatric Diagnosis, *Biometrics*, 28(3):831.

- Feller, William (1968) *An Introduction to Probability Theory and Its Applications*, vol. 1, John Wiley & Sons, Inc., New York, NY, 1968.
- Fellner, William (1965) *Probability and Profit: A Study of Economic Behavior along Bayesian Lines*, Richard D. Irwin, Inc., Homewood, IL, 1965.
- Finocchi, A. J. (1965) Reliability Has Failed to Meet Its Goals, *Ann. Reliability Maintainability*, 4:111-117.
- Fisher, R. A. (1922) On the Mathematical Foundations of Theoretical Statistics, *Phil. Trans. Roy. Soc. London, ser. A*, 222:309-368.
- Flinn, R. A., and E. Turban (1970) Decision Tree Analysis for Industrial Research, *Res. Management*, 13(1):27-34.
- Fry, Thornton C. (1928) *Probability and Its Engineering Uses*, Van Nostrand Company, New York, NY, 1928.
- Gear, A. E., J. S. Gillespi, and J. M. Allen (1972) Applications of Decision Trees to Evaluation of Applied Research Projects, *J. Management Stud.*, 9(2):172-181.
- Gironi, G., and P. Malberti (1976) Burn-in Program for Wearout Unaffected Equipments, *Microelectron. Reliability*, 15(3):227-232.
- Goldman, A. S., and T. B. Slattery (1964) *Maintainability: A Major Element of System Effectiveness*, John Wiley & Sons, Inc., New York, NY, 1964.
- Gottfried, Paul (1977) The Interpretation of Statistically Designed R & M Tests, *Proc. Ann. Reliability Maintainability Symp.*, 1977:203-205.
- Govindaragulu, Z. (1964) Supplement to Mendenhall's Bibliography on Life Testings and Related Materials, *J. Am. Statist. Assoc.*, 59:1231-1291.
- Grant, E. L. (1946) *Statistical Quality Control*, McGraw-Hill Book Company, Inc., New York, NY, 1946.
- Grose, Vernon L. (1965) Reliability Can Be Predicted? (A Negative Position), *Ann. Reliability Maintainability*, 4:119-129.
- Grose, Vernon L. (1971a) Status of Failure (Hazard) Mode and Effect Analysis, Fault Tree Analysis, and Prediction, Apportionment, and Assessment, *Ann. Reliability Maintainability*, 10:415-423.
- Grose, Vernon L. (1971b) System Effectiveness: Where Do We Stand Today? *Ann. Reliability Maintainability*, 10:400-402.
- Hadden, F. A., and L. W. Sepmeyer (1955) Techniques in Putting Failure Data to Work for Management, *IRE Trans. First Nat. Symp. Qual. Control Reliability Electron.*, 1955:95-109.
- Hadden, F. A., and L. W. Sepmeyer (1956) Methodology for Reliable Failure Reporting from Maintenance Personnel, *IRE Tran. Eng. Management*, EM3(1):27-29.
- Hausman, W. H., and M. Kamins (1964) *Early Failures in Automobile Parts: A Background Study in Reliability*, Rand Corporation, Santa Monica, Ca, March 1964 (Rand Rept. RM-4002-PR).
- Haviland, R. P. (1964) *Engineering Reliability and Long Life Design*, D. Van Nostrand Company, Inc., Princeton, NJ, 1946.

- Heap, H. F., C. A. Asvitt, and H. L. Storey (1966) Aircraft Structure Sampling Inspection Programs, FAA Maintenance Symposium on Continued Reliability of Transport-type Aircraft Structure, Washington, DC, November 2-4, 1966.
- Heap, H. F., and G. G. Cockshott (1973) An Analysis of Economic and Reliability Experience with the Boeing 747 under a Condition Monitoring Type of Maintenance Program, Ninth Annual FAA International Aviation Maintenance Symposium, December 11-13, 1973.
- Heinze, Kenneth P. (1975) *Accomplishing Shipyard Work for the United States Navy: Institutions, Systems and Operations*, vol. 3 (bibliography), Institute for Defense Analyses, Cost Analysis Group, Arlington, Va, August 1975 (paper P-1132, contract DAHC15-73-C-0200, task 81).
- Herd, G. Ronald (1977) Planning Statistical Experimental Designs in R & M Applications, *Proc. Ann. Reliability Maintainability Symp.*, 1977:198-202.
- Howard, Edward F., and H. Gerry Lipsett (1976) *Naval Sea Systems Operational Availability Quantification and Enhancement*, Naval Underwater Systems Center, New London Laboratory, New London, Ct, February 27, 1976 (NUSC-TR-5211).
- Hughes Aircraft (1976) *Final Report: Engineering Analysis of the Planned Maintenance Subsystem Low Pressure Air and Dry Air Systems for FF 1052 Class Ships*, Hughes Aircraft Company, Depot Support Systems Engineering, December 1976 (contract N00123-76-C-001).
- Hughes, Randall A., Martin A. Fischler, and Herbert E. Rauch (1977) Using Pattern Recognition in Product Assurance, *Proc. Ann. Reliability Maintainability Symp.*, 1977:101-107.
- Ingram, C. R., and R. L. Scheaffer (1976) On Consistent Estimation of Age Replacement Intervals, *Technometrics*, 18:213-219.
- Jensen, Harry T. (1965) The Evolution of Structural Fail Safe Concepts, Rotorcraft, ICAF Symposium on Fatigue Procedures, June 16-18, 1965.
- Johnson, R. A., A. Heller, and J. N. Yang (1977) Flight Inspection Data and Crack Initiation Times, *Proc. Ann. Reliability Maintainability Symp.*, 1977: 148-154.
- Jorgenson, D. W., J. J. McCall, and R. Radnor (1967) *Optimal Replacement Policy*, Rand-McNally & Company, Inc., Chicago, Il, 1967.
- Kamins, Milton (1960) *Determining Checkout Intervals for Systems Subject to Random Failures*, Rand Corporation, Santa Monica, Ca, June 15, 1960 (Rand Rept. RM-2578, AD 247 383).
- Kandiew, Anatoly I. (1972) Computer Diagnostic with Inherent Fail-safety, U.S. Patent 3,692,989 (assignee U.S. Atomic Energy Commission), September 19, 1972 (Int. Cl. G06f 11/00, US Cl. 235/153,340/172.5).
- Karg, W. P. (1969) Maintenance Research: The Key to Minimals in Maintenance Costs, Fifth Annual Aviation Maintenance Symposium, Oklahoma City, Ok, December 9-11, 1969.
- Kay, Emile (1976) The Effectiveness of Preventive Maintenance, *Internat. J. Prod. Res. (UK)*, 14(3):329-344.
- Keeney, Ralph L., and Howard Raiffa (1976) *Decisions with Multiple Objectives: Preferences and Value Tradeoffs*, John Wiley & Sons, Inc., New York, NY, 1976.

- Khintchine, A. Ya. (1932) Mathematisches über die Erwartung von Einen Öffentlicher Schalter, *Matem. Sbornik*, 1932.
- Knudsen, G. E., and J. R. Keating (1976) *Helicopter Drive System On-condition Maintenance Capability (UH-1/AH-1)*, Bell Helicopter Company, Fort Worth, Tx, July 1976 (Bell 299-939-003, contract DAAJ02-74-C-0060, USAAMRDL-TR-75-52).
- Kolmogorov, A. (1933) *Grundbegriffe der Wahrscheinlichkeitsrechnung*, Springer-Verlag, Berlin, Germany, 1933.
- Kontich, Petar R. (1976) The Aging Fleet: Fact or Fable? ATA Engineering and Maintenance Forum, October 12-14, 1976.
- Krahenbuhl, Rolf (1976) Maintaining Transport Aircraft, *Aircraft Eng.*, 48(5): 4-8, 13.
- Ladany, Shaul P., and Matityahu Aharoni (1975) Maintenance Policy of Aircraft according to Multiple Criteria, *Internat. J. Syst. Sci.*, 6(11):1093-1101.
- Larsen, A. C., and R. E. Watson (1966) State of the Art in Design and Testing to Ensure Continued Aircraft Structural Integrity, FAA Maintenance Symposium on Continued Reliability of Transport-type Aircraft Structure, Washington, DC, November 2-4, 1966.
- Lavallee, William F. (1974) *USN Aircraft Periodic Depot Level Maintenance Study*, Institute of Naval Studies, Center for Naval Analyses, Arlington, Va, November 1974 (CNS1025).
- Lavallee, William F. (1977) *Logistic Support Analysis Guide*, Naval Aviation Integrated Support Center, Patuzent River, Md, June 15, 1977 (NAILSC PR-3-17).
- Lavallee, William F., John Schiffer, and James Capra (1975) *Aircraft Spare Engine Requirements*, Internal memorandum, Institute of Naval Studies Center for Naval Analyses, Arlington, Va, May 14, 1975 (CNA 715-75).
- Lawrence, David B. (1976) The Value of Information in Decision Making: A Bibliography Setting Statistical Priorities, in *Setting Statistical Priorities: Report of the Panel on Methodology for Statistical Priorities*, National Research Council, Committee on National Statistics, Washington, DC, 1976.
- Leontief, Wassily W., et al. (1953) *Studies in the Structure of the American Economy: Theoretical and Empirical Exploration in Input-output Analysis*, Harvard Economic Research Project, Oxford University Press, New York, NY, 1953.
- Libove, C. (1975) *Flat-packs under Thermal Shock: A Simplified Analysis of Flexural Stress in the Lid-to-Wall Seal*, Syracuse University, New York, NY, December 1975 (contract F30602-71-C-0312, RADC-TR-75-308, AD A021 253).
- Lockheed, California Company (1977a) *Scheduled Maintenance Development Procedures*, vol. 2, Ship Support Improvement Project, Lockheed, California Company, Burbank, Ca, July 1977.
- Lockheed, California Company (1977b) *Availability-centered Maintenance Program Summary*, Ship Support Improvement Project, Lockheed, California Company, Burbank, Ca, July 14, 1977.
- Logistics Management Institute (1966) *Criteria for Repair vs Discard Decisions*, Clearinghouse for Federal Scientific and Technical Information, Springfield, Va, May 1966 (AD 484 603).

- MacGregor, R. V. (1968) Maintainability/Maintenance Relationships, Los Angeles Maintainability Association, September 17, 1968.
- Magee, John F. (1964a) Decision Trees for Decision Making, *Harvard Bus. Rev.*, 42(4):126-138.
- Magee, John F. (1964b) How to Use Decision Trees in Capital Investment, *Harvard Bus. Rev.*, 42(5):79-96.
- A-300 B Maintenance Steering Committee (1972) *European Maintenance System Guide to Developing Initial Maintenance Programmes for Civil Air Transport*, Association of European Airlines, July 1972.
- 747 Maintenance Steering Group (1968) *Handbook: Maintenance Evaluation and Program Development (MSG-1)*, Air Transport Association, Washington, DC, July 10, 1968.
- Marsh, Robert T. (1976) Avionics Equipment Reliability: An Elusive Objective, *Defense Management J.*, 12:24-29.
- Martz, H. F., Jr., K. Campbell, and H. T. Davis (1977) Estimating and Forecasting Failure-rate Processes by Means of the Kalman Filter, in *The Theory and Applications of Reliability*, vol. 1, pp. 165-192, Academic Press, Inc., New York, NY, 1971.
- Martz, H. F., Jr., and M. G. Lian (1977) Bayes and Empirical Bayes Point and Interval Estimation of Reliability for the Weibull Model, in *The Theory and Applications of Reliability*, vol. 2, pp. 203-233, Academic Press, Inc., New York, NY, 1977.
- Martz, H. F., Jr., and M. S. Waterman (1977) *A Bayesian Model for Determining the Optimal Test Stress for a Single Test Unit*, Texas Technical University, Department of Industrial Engineering, Lubbock, Tx, March 31, 1977 (NR 042-320, TR-LA-UR-77-664, contract N00014-75-C-0832).
- Masse, Pierre (1962) *Optimal Investment Decisions: Rules for Action and Criteria for Choice* (trans. Scripta Technica, Inc.), Prentice-Hall, Inc., Englewood Cliffs, NJ, 1962.
- Matteson, T. D. (1966) In-service Reliability Analysis: A Guide for Reducing Maintenance Costs and Spares Requirements, Annual Symposium on Reliability, San Francisco, Ca, January 27, 1966.
- Matteson, T. D. (1969a) In-service Safety and Reliability and the Role of Maintenance, Gates Rubber Company Fourth Annual Plant Engineer's Conference, Denver, Co, May 12-16, 1969.
- Matteson, T. D. (1969b) Condition Monitoring on the 747, Engineering and Maintenance Conference, November 5, 1969.
- Matteson, T. D. (1971a) Air Transport Maintenance Technology Needs a New Regulatory Model, AIAA Conference on Air Transportation and Society, Key Biscayne, Fl, June 7-10, 1971.
- Matteson, T. D. (1971b) Condition Monitoring: The Right Handle, Air Transport Association FAA/NTSB Briefing, October 5-6, 1971.
- Matteson, T. D. (1971c) The Relationship between Maintenance and Operating Safety in Air Transportation, Seventh Annual FAA International Aviation Maintenance Symposium, Oklahoma City, Ok, December 7-9, 1971.
- Matteson, T. D. (1972a) NDT's Piece of the Pie, ATA Nondestructive Testing Subcommittee Meeting, Denver, Co, September 20, 1972.

- Matteson, T. D. (1972*b*) The Design of Modern Air Transport Maintenance Programs, Association Aeronautique et Aerospatiale Française, Paris, France, November 6, 1972.
- Matteson, T. D., and F. S. Nowlan (1967) Current Trends in Airline Maintenance Programs, AIAA Commercial Aircraft Design and Operation Meeting, Los Angeles, Ca, June 12-14, 1967 (AIAA 67-379).
- McCall, Chester, H., Jr. (1977) Statistical Design of R/M Experiments, *Proc. Ann. Reliability Maintainability Symp.*, 1977:194-197.
- McCall, J. J. (1967) *When to Stop Sampling: Initiate Product Improvement*, Rand Corporation, Santa Monica, Ca, February 1967 [Rand memo. RM-3014-PR, contract AF49(638)-700, AD 272 138].
- McDonald, John F. (1963) *Reliability: A Random Discussion?* Lockheed, California Company, Service Engineering Division, Burbank, Ca, October 1963.
- McDonald, John F. (1972) A Discourse on Some Comparisons between Commercial and Military Aircraft Logistics, Seventh Annual Convention of the SOLE, Long Beach, Ca, August 22, 1972.
- Mellon, E. G. (1972) Coping with Maintenance Complexities: A Manufacturer's View, FAA Maintenance Symposium, Oklahoma City, Ok, November 28-30, 1972.
- Mendenhall, William (1958) A Bibliography of Life Testing and Related Topics, *Biometrika*, 45:521-543.
- Mentzer, W. C. (1968) The Evolution of Airline Aircraft Maintenance, Annual General Meeting, Aeronautical Society of India, Bangalore, India, May 3, 1968.
- Miller, Douglas R. (1975) *A Continuity Theorem and Some Counterexamples for the Theory of Maintained Systems*, University of Missouri, Department of Statistics, Columbia, Mo, December 1975 (UMC 66, contract N00014-76-C-0843).
- Miller, Douglas R. (1976) *Almost Sure Comparisons of Renewal Processes and Poisson Processes with Application to Reliability Theory*, University of Missouri, Department of Statistics, Columbia, Mo, June 1976 (UMC 63, contract N00014-76-C-0843).
- Miller, Douglas R., and Nozer D. Singpurwalla (1977) *Failure Rate Estimation Using Random Smoothing*, University of Missouri, Department of Statistics, Columbia, Mo, April 1977 (UMC 67, contract N00014-76-C-0843).
- Moore, E. F., and C. E. Shannon (1956) Reliable Circuits Using Less Reliable Relays, *J. Franklin Inst.*, 262(1):191-208, 262(2):281-297.
- Morgan, John D., Norman B. Davis, Marvin H. Hahn, and William J. E. Shafer (1975) *Accomplishing Shipyard Work for the United States Navy: Institutions, Systems and Operations*, vol. 1 (basic report), Institute for Defense Analyses, Cost Analysis Group, Arlington, Va, August 1975 (paper P-1132, contract DAHC15-73-C-0200, task 81).
- Morgan, John D., Norman B. Davis, Marvin H. Kahn, and William J. E. Shafer (1975) *Accomplishing Shipyard Work for the United States Navy: Institutions, Systems and Operations*, vol. 2 (appendixes), Institute for Defense Analyses, Cost Analysis Group, Arlington, Va, August 1975 (paper P-1132, contract DAHC15-73-C-0200, task 81); for vol. 1 see Heinze.

- National Research Council (1976) *Setting Statistical Priorities: Report of the Panel on Methodology for Statistical Priorities*, National Research Council, Assembly of Mathematical and Physical Sciences, Committee on National Statistics, Washington, DC, 1976.
- National Security Industrial Association (1975) *Impact of Commercial Aircraft Maintenance and Logistic Support Concepts on the Life Cycle of Air ASW Weapons Systems: Ad Hoc Study*, Lockheed, California Company, Burbank, Ca, November 1, 1975.
- Needham, James F. (1975) *Failsafe/Safe-life Interface Criteria*, Summa Corporation, Hughes Helicopters, Culver City, Ca, January 1975 (HH 74-141, contract DAAJ02-74-C-0005, USAAMRDL-TR-74-101, AD A006 131).
- Neland, K. E. (1966) FAA Present and Future Philosophy in Regulating Aircraft Structural Maintenance Programs, FAA Maintenance Symposium on Continued Reliability of Transport-type Aircraft Structure, Washington, DC, November 2-4, 1966.
- Nelson, J. R. (1977) *Life-cycle Analysis of Aircraft Turbine Engines*, Executive Summary, Project Air Force Rept., March 1977 (R-2103/1-AF).
- Neison, J. R., P. Konoshe Dey, et al. (1974) *A Weapon-system Life-cycle Overview: The A-7D Experience*, Rand Corporation, Santa Monica, Ca, October 1974 (Rand Rept. R-1452-PR, contract F444620-73-C-0011).
- Neyman, J., and E. S. Pearson (1928) On the Use and Interpretation of Certain Test Criteria for Purposes of Statistical Inference, *Biometrika*, 20(1):175-240, 20(2):263-294.
- Nowlan, F. S. (1960) A Comparison of the Potential Effectiveness of Numerical Regulatory Codes in the Fields of Overhaul Periodicity, Airplane Strength, and Airplane Performance, United Airlines internal document, United Airlines, San Francisco, Ca, April 14, 1960 (POA-32).
- Nowlan, F. S. (1965) Some Comments Pertaining to Equipment Reliability and Maintenance Policy, United Airlines internal document, United Airlines, San Francisco, Ca, July 17, 1965.
- Nowlan, F. S. (1967) The Use of Decision Diagrams for Logical Analysis of Maintenance Programs, United Airlines internal document, United Airlines, San Francisco, Ca, August 2, 1967.
- Nowlan, F. S. (1969) Review of "On Condition" Philosophies from a Planning and Operational Viewpoint: Past, Present, Future, Fifteenth Meeting of AIATA Production Planning and Control Subcommittee, Belgrade, Yugoslavia, October 7-9, 1969.
- Nowlan, F. S. (1972) Decision Diagram Approach to "On Condition" Philosophies, *Aircraft Eng.*, 44(4):35-37.
- Nowlan, F. S. (1973) A Current Turbine Engine Maintenance Program and the Experience and Logic upon Which It Is Based, ASME Gas Turbine Conference and Products Show, April 8-12, 1973 (ASME N 73-T-81).
- Nowlan, F. S. (1978) Preventive Maintenance: Past, Present, and Future, AIAA Conference on Air Transportation, Technical Perspectives and Forecasts, Los Angeles, Ca, August 21-24, 1978.
- NATO (1972) *Proceedings of a Conference on Decomposition of Large-scale Problems*, Cambridge, England, July 17-26, 1972.

- Onodera, Katsushige, Minoru Miki, and Keizo Nukada (1977) Reliability Assessment for Heavy Machinery by "HI-FMECA" Method, *Proc. Ann. Reliability Maintainability Symp.*, 1977:346-352.
- Orion Service Digest, vol 31, March 1976.
- Osaki, S., and Nakagawa (1976) Bibliography for Reliability and Availability of Stochastic Systems, *IEEE Trans. Reliability*, 25:284-257 (sic).
- Palm, C. (1943) Intensitätsschwankungen im Fernsprechverkehr, *Ericsson Technics*, 44:3-189.
- Pettigrew, James L., and Robert M. McCord (1977) *Diagnostic Guide. Engine Condition Monitoring, Revision One*, Strategic Air Command, Offutt Air Force Base, Nb, February 1977.
- Pieruschka, Erich (1963) *Principles of Reliability*, Prentice-Hall, Inc., Englewood Cliffs, NJ, 1963.
- Plouff, William E. (1977) Avionic Reliability Experience: AR-104 and 781B, *Proc. Ann. Reliability Maintainability Symp.*, 1977:206-212.
- Raiffa, Howard (1968) *Decision Analysis: Introductory Lectures on Choices under Uncertainty*, Addison-Wesley Publishing Company, Reading, Ma, 1968.
- Rand Corporation (1964) *Planned Replacement on a Budget*, Rand Corporation, Santa Monica, Ca, August 1964 (Rand Rept. P-2965).
- Rice, John, and Murray Rosenblatt (1976) *Estimation of the Log Survivor Function and Hazard Function*, Statistical Publishing Society, Calcutta, India, 1976; reprinted from *Sankhya* (Indian Journal of Statistics), ser. A, vol. 38, pt. 1, 1976.
- Roberson, K. D., et al. (1970) Reliability and Maintainability from an Airline Standpoint, National Air Transportation meeting, April 20-23, 1970 (SAE 70036).
- Rosenthal, Arnie (1977) Computing the Reliability of Complex Networks. *SIAM J. Appl. Math.*, 32(2):384-393.
- Rubel, Paul (1975) Bonsai: Cultivating the Logic Tree for Reactor Safety, *Proc. Ann. Reliability Maintainability Symp.*, 1975:13-17.
- Rummel, K. G., and M. Byrne (1974) *Analysis of Factors Affecting Turbine Engine Reliability*, Boeing Company, Vertol Division, Philadelphia, Pa, November 1974 (Boeing D210-10812-1, contract DAAJ02-73-C-0071, USAAMRDL-TR-74-82).
- Rummel, Kirk G., and H. J. M. Smith (1973) *Investigation and Analysis of Reliability and Maintainability Problems Associated with Army Aircraft Engines*, Boeing Company, Vertol Division, Philadelphia, Pa, August 1973 (contract DAAJ02-71-C-0055, USAAMRDL-TR-73-28, AD 772 950).
- Saia, Joseph C. (1977) An Evaluation of Changes in the U.S. Navy Aircraft Maintenance Program, master's thesis, American University, Washington, DC, March 1977.
- Sattar, Siddig A., and J. T. Hill (1975) Design of Jet Engine Rotors for Long Life, SAE Air Transportation Meeting, Hartford, Ct, May 6-8, 1975 (SAE 750619).

- Saunders, Sam C. (1976) *A Confrontation of Mathematical Models for Fatigue Life with Actual Service Data*, Washington State University, Department of Pure and Applied Mathematics, Pullman, Wa, June 1976 (AFFDL-TR-76-47).
- Schlaifer, Robert (1969) *Analysis of Decisions under Uncertainty*, McGraw-Hill Book Company, New York, NY, 1969.
- Schonewise, R. H. (1971) *An Approach to the Design of an Inspection Program for Modern Jet Transport Aircraft Structure*, United Airlines, Maintenance Operations, San Francisco, Ca, February 16, 1971; rev. June 29, 1971 (MOA 145).
- Shapero, Albert, et al. (1960) *Human Engineering Testing and Malfunction Data Collection in Weapon System Test Programs*, Air Research and Development Command, Air Development Division, Wright-Patterson Air Force Base, Oh, February 1960 (WADD-TR-60-36).
- Scheffey, Michael B. (1976) The Amount of a Charitable Contribution of Property: A Decision-tree Approach, *Accounting Rev.*, 51(3):642-643.
- Shewart, W. A. (1931) *Economic Control of Quality of Manufactured Product*, Van Nostrand Company, New York, NY, 1931.
- Smith, Dennis E., and Robert L. Gardner (1976) *A Small-scale Investigation of Statistics for Determining the Number of Clusters in a Data Base*, Desmatics, Inc., State College, Pa, September 1976 (NR 102-3).
- Spoormaker, Jan L. (1977) Reliability Prediction of Hairpin-type Springs, *Proc. Ann. Reliability Maintainability Symp.*, 1977:142-147.
- Stone, M. E. (1965) Fatigue and Fail-safe Design of a New Jet Transport Airplane, ICAF Symposium on Fatigue Design Procedures, Munich, Germany, June 16-18, 1965 (Douglas 3342).
- Stone, M. E. (1973) Airworthiness Philosophy Developed from Full-scale Testing, ICAF Biannual Meeting, London, England, July 23-25, 1973 (Douglas 6099).
- Stone, M. E. and H. F. Heap (1971) Developing the DC-10 Structural Inspection Program, Seventh Annual FAA International Aviation Maintenance Symposium, Oklahoma City, Ok, December 7-9, 1971.
- Swager, William L. (1972) Strategic Planning II: Policy Options, *Technol. Forecasting*, 4(4):151-172.
- Taylor, H. N., and F. S. Nowlan (1965) Turbine Engine Reliability Program, FAA Maintenance Symposium on Continued Reliability of Transport-type Aircraft Propulsion Systems, Washington, DC, November 17-18, 1965.
- Treacy, J. J. (1977) Use of Probability Analysis in Aircraft Certification and Its Effects on Maintenance and Equipment Maintenance, AIAA Aircraft Systems and Technology Meeting, Seattle, Wa, August 22-24, 1977.
- Trustee, B. (1976) *Helicopter Drive System On-condition Maintenance Capability*, United Technologies Corporation, Sikorsky Aircraft Division, Stratford, Ct, July 1976 (contract DAAJ02-74-C-0045, USAAMRDL-TR-75-57).
- Tukey, John W. (1977) *Exploratory Data Analysis*, Addison-Wesley Publishing Company, Reading, Ma, 1977.
- Tukey, John W. (1960) Conclusions vs Decisions, *Technometrics*, 2:423-433.

- United Airlines (1974) *F4J Maintenance Program Analysis Procedures Manual*, United Airlines, F4J Task Selection Team, San Francisco, Ca, September 4, 1974; rev. May 21, 1975 (contract N62269-74-C-0777).
- United Airlines (1975a) *Proposed Packaging and Sequencing Concepts for the Organization and Intermediate Maintenance Process Activity (F4J)*, Report to Naval Air Systems Command, United Airlines, F4J Task Selection Team, San Francisco, Ca, August 15, 1975 (contract N62269-74-C-0777).
- United Airlines (1975b) *Organizational and Intermediate Level Maintenance Program Specification, Navy Model F-4J Aircraft: Final Report*, vol. 1 discussion report, vol. 2 analysis sheets and MRC's, United Airlines Maintenance Operations, F4J, San Francisco, Ca, November 20, 1975 (contract N62269-74-C-0777, P-00002).
- United Airlines (1977) *Analytical Maintenance Program for Naval Aircraft: An Evaluation and Commentary*, United Airlines, San Francisco, Ca, October 31, 1977 (contract N62269-76-C-0168).
- U.S. Department of the Air Force (1977) *Latest Reliability and Maintainability Reports*, Rome Air Development Center, Rome, NY, February 1977.
- U.S. Department of the Army (1977) *Analysis Guidelines for Determination of the Maintenance Plan Using the Principles of Reliability Centered Maintenance*, app. C, Guide to Logistic Support Analysis, U.S. Army Maintenance Management Center, Lexington Ky, August 1977 (DARCOM C1, AMCP 750-16).
- U.S. Department of Defense (1973) *Logistic Support Analysis Data Element Definitions*, Military Standard, Department of Defense, Washington, DC, October 15, 1973 (MIL STD 1388-2).
- U.S. Department of Defense (1974) *Engineering Management*, Military Standard, Department of Defense, Washington, DC, May 1, 1974 [MIL STD 499A (USAF)].
- U.S. Department of the Navy (1975) *Maintenance Plan Analysis Guide for In-service Naval Aircraft: Management Manual*, Naval Air Systems Command, Washington, DC, August 1, 1975 (NAVAIR-00-25-400).
- U.S. Department of the Navy (1976a) *Analytical Maintenance Program Scheduled Maintenance Engineering Analysis Procedures for the F-14/A-6 Series Aircraft and the TF30 Engine*, Specification, Naval Air Rework Facility, Norfolk, Va, February 1976 (NARF NORVA AE-327).
- U.S. Department of the Navy (1976b) *User's Guide: Logistic Support Analysis*, Ship Support Improvement Project PMS 306, Naval Sea Systems Command, October 1976.
- Von Neumann, J., and O. Morgenstern (1944) *Theory of Games and Economic Behavior*, Princeton University Press, Princeton, NJ, 1944.
- Wald, Abraham (1947) *Sequential Analysis*, John Wiley & Sons, Inc., New York, NY, 1947.
- Wald, Abraham (1950) *Statistical Decision Functions*, John Wiley & Sons, Inc., New York, NY, 1950.

- Waller, R. A. and H. F. Martz (1977) *A Bayesian Zero-failure (BAZE) Reliability Demonstration Testing Procedure for Components of Nuclear Reactor Safety Systems*, Los Alamos Scientific Laboratory, Los Alamos, NM, June 1977 (LA 6813-MS).
- Weibull, W. (1939) A Statistical Theory of the Strength of Material, *Ing. Vetenskaps Akad. Handl.*, vol. 151.
- Weibull, W. (1951) A Statistical Distribution Function of Wide Applicability, *J. Appl. Mechan.*, **18**:293-297.
- Weiss, D. W., and D. M. Butler (1965) Applied Reliability Analysis, *Trans. ASME Sixth Joint Control Conf.*, **1965**:848-856.
- Wheelwright, S. C. (1975) Applying Decision Theory to Improve Corporate Management of Currency Exchange Risks, *Calif. Management Rev.*, **17**(4): 41-49.
- Whitehouse, G. E. (1974) Network Flow Analysis, III, Using Decision Flow Networks, *Ind. Eng. (USA)*, **6**(7):18-25.
- Winter, B. B., et al. (1964) *Accelerated Life Testing of Guidance Components*, pp. 64-235, North American Aviation, Autometrics Division, Anaheim, Ca, 1964 (A1 TDR).
- Zelen, Marvin (ed.) (1963) *Statistical Theory of Reliability*, University of Wisconsin Press, Madison, Wi, 1963.
- Zipperer, John, Gavin Jenney, and Jerry Bryant (1975) *Flight Control System Reliability and Maintainability Investigations*, Bell Helicopter Company, Fort Worth, Tx, March 1975 (contract DAAJ02-73-C-0026, USAAMRDL-TR-74-57).

glossary

actuarial analysis Statistical analysis of failure data to determine the age-reliability characteristics of an item.

age The measure of a unit's total exposure to stress, expressed as the number of operating hours, flight cycles, or other stress units since new or since the last shop visit.

age exploration The process of collecting and analyzing information from in-service equipment to determine the reliability characteristics of each item under actual operating conditions.

age at failure The age at which the failure of a specific unit of an item is observed and reported (see *average age at failure*).

age-reliability characteristics The characteristics exhibited by the conditional-probability curve which represents the relationship between the operating age of an item and its probability of failure (see *actuarial analysis, conditional probability of failure*).

airworthiness directive A Federal Aviation Administration directive that defines the scheduled maintenance tasks and intervals necessary to prevent a specific type of critical failure. The directive is issued after operating experience has shown that the equipment is exposed to such a failure, and the specified maintenance must be continued until hardware modifications eliminate the need for it.

analysis and surveillance See *age exploration*.

analysis systems One of the various information systems employed for monitoring the performance and reliability of equipment in operation.

applicability criteria The specific set of conditions that must characterize the failure behavior of an item for a given type of maintenance task to be capable of improving its reliability (see *effectiveness criterion*).

auditing The systematic review of the RCM decision-making process by an independent observer.

average age at failure The average of the failure ages of all failed units of an item.

average availability The expected availability of a hidden function, given a specified failure-finding task interval.

average realized life The expected life of an item, computed on the basis of total removals and total exposure of all units of the item (see *survival curve*).

bathtub curve A conditional-probability curve which represents the age-reliability relationship of certain items, characterized by an infant-mortality region, a region of relatively constant reliability, and an identifiable wearout region.

borescope inspection A maintenance technique that employs an optical device (borescope) for performing visual inspections of internal parts of an assembly, usually through ports provided for that purpose.

class number A number that is the lowest of the individual ratings for a structurally significant item or a zone, used to determine the relative length of inspection intervals (see *structural ratings*).

complex item An item whose functional failure can result from any one of numerous failure modes (see *simple item*).

condition-monitoring process In current regulatory usage, a maintenance process characterized by the absence of scheduled-maintenance tasks. Items (including those with hidden functions) remain in service until a functional failure occurs, and their overall reliability is monitored by analysis and surveillance programs (see *no scheduled maintenance, failure-finding task*).

conditional overhaul A maintenance practice for returning the time-since-overhaul measure to zero, in which the content of the work varies according to the condition of the unit when it arrives in the shop. This can be as little as a postoverhaul performance test or as much as complete disassembly and remanufacture.

conditional probability of failure The probability that an item will fail during a particular age interval, given that it survives to enter that interval (see *probability density of failure*).

consequences of failure The results of a given functional failure at the equipment level and for the operating organization, classified in RCM analysis as safety consequences, operational consequences, nonoperational consequences, and hidden-failure consequences.

corrective maintenance The replacement or repair of failed items (see *scheduled maintenance*).

corrosion The gradual deterioration of a metal or alloy as a result of chemical interaction with its environment.

cost effectiveness Referring to a favorable cost-benefit ratio; the criterion of task effectiveness in preventing any functional failure that has economic, but not safety, consequences (see *effectiveness criterion*).

cost of failure For a failure that has operational consequences, the combined cost of the operational consequences and the cost of corrective maintenance; for a failure that has nonoperational consequences, the direct cost of corrective maintenance.

cost-tradeoff study See *economic-tradeoff study*.

crack initiation The first appearance of a fatigue crack in an item subject to repeated loads, usually based on visual inspection, but sometimes based on the use of nondestructive testing techniques.

crack-propagation characteristics The rate of crack growth, and the resulting reduction in residual strength, from the time of crack initiation to a crack of critical length.

critical crack length The length of a fatigue crack at which the residual strength of the item is no longer sufficient to withstand the specified damage-tolerant load.

critical failure A failure involving a loss of function or secondary damage that could have a direct adverse effect on operating safety (see *safety consequences*).

critical failure mode A failure mode whose ultimate effect can be a critical failure.

D check See *letter check, major structural inspection*.

damage Physical deterioration of an item from any cause.

damage-tolerant structure Structure whose residual strength enables it to withstand specified damage-tolerant loads after the failure of a significant element (in some cases the failure of multiple elements).

decision diagram In RCM analysis, a graphic display of the decision process, in which the answers to an ordered sequence of yes/no questions lead to an identification of the appropriate maintenance action for an item.

default answer In a binary decision process, the answer to be chosen in case of uncertainty; employed in the development of an initial

scheduled-maintenance program to arrive at a course of action in the absence of complete information.

direct effect of failure The physical effects resulting from a single failure which will be felt before the planned completion of the flight.

discard task The scheduled removal of all units of an item to discard the item or one of its parts at a specified life limit; one of the four basic tasks in an RCM program.

dominant failure mode A single failure mode that accounts for a significant proportion of the failures of a complex item.

economic consequences The only consequences of a functional failure which is evident to the operating crew and has no direct effect on operating safety (see *cost of failure, operational consequences, nonoperational consequences*).

economic-life limit A life limit imposed on an item to reduce the frequency of age-related failures that have economic consequences (see *safe-life limit*).

economic-tradeoff study A cost study to determine whether a proposed course of action is cost-effective.

effectiveness criterion The criterion for judging whether a specific task would be capable of reducing the failure rate to the required level for the appropriate consequence branch of the decision diagram (see *applicability criteria*).

engine flameout The cessation of the combustion process in a turbine engine, resulting in a complete loss of function of that engine.

engine shutdown Controlled shutdown of an engine by the pilot as a response to evidence of unsatisfactory conditions.

event-oriented inspection A special on-condition inspection following the occurrence of a specific event that may have caused damage.

event-oriented system One of the various information systems employed in the aircraft industry for collecting data on specific failure events.

evident function A function whose failure is evident to the operating crew during the performance of normal duties.

exposure to stress See *age*.

external structural item Any portion of the structure that is visible without the opening of quick-access panels or the removal of covering items.

fail-operational system A system whose complete functional capability remains available to the equipment without interruption when failures occur within it.

fail-safe system A system whose function is replicated, so that the function will still be available to the equipment after failure of one of its sources.

failure An unsatisfactory condition; any identifiable deviation of the condition or performance capability of an item from its new state that is unsatisfactory to a particular operating organization (see *functional failure, potential failure*).

failure data The reports of failure events, their causes, and their consequences.

failure effects The immediate physical effects of a functional failure on surrounding items and on the functional capability of the equipment, the principal determinant of failure consequences (see *direct effect of failure*).

failure evidence An identifiable physical condition by which the occurrence of a functional failure or a potential failure can be recognized.

failure-finding task Scheduled inspections of a hidden-function item to find functional failures that have already occurred but were not evident to the operating crew; one of the four basic tasks in an RCM program.

failure mode The specific manner of failure; the circumstances or sequence of events which leads to a particular functional failure.

failure observer The person who is in a position to observe a failure, recognize it as such, and report it for correction.

failure process The interaction of stress and resistance to failure over time.

failure rate The ratio of the number of failures of an item during a specified period to the total experience of all units in operation during that period, usually expressed as failures per 1,000 operating hours.

failure substitution In maintenance, the use of a potential failure to preempt a functional failure; in design, the use of an item whose failure has minor consequences to preempt a failure that would have major consequences.

fatigue Reduction in the failure resistance of a material over time as a result of repeated or cyclic applied loads.

fatigue life For an item subject to fatigue, the total time to crack initiation (see *crack initiation, crack-propagation characteristics*).

fleet-leader concept The concentration of sample inspections on the pieces of equipment which have the highest operating ages to identify the first evidence of changes in their condition with increasing age.

flight cycles A measure of exposure to the stresses associated with the conduct of individual flights, expressed as the number of ground-air cycles.

flight hours A measure of operating age, expressed as the number of operating hours from takeoff to landing.

flight log In commercial aviation, the official record of each flight, the primary communication link between the operating crew and the maintenance crew.

forced sample An inspection sample obtained by special disassembly solely for access to that item (see *opportunity sample*).

function The normal or characteristic actions of an item, sometimes defined in terms of performance capabilities.

functional failure Failure of an item to perform its normal or characteristic actions within specified limits.

functionally significant item An item whose loss of function would have significant consequences at the equipment level (see *structurally significant item*).

hard-time process In current regulatory usage, scheduled removal of all units of an item before some specified maximum permissible age limit.

hidden-failure consequences The risk of a multiple failure as a result of an undetected earlier failure of a hidden-function item; one of the four consequence branches of the RCM decision diagram.

hidden function A function whose failure will not be evident to the operating crew during the performance of normal duties.

hidden-function item Any item whose functions include a hidden function.

improvable failure rate The difference between the failure rate of an item on newly designed equipment and the expected failure rate after product improvement to eliminate dominant failure modes; this reduction in the failure rate is generally exponential and can be predicted from early failure data.

imputed cost The economic value assigned to operational consequences as an opportunity cost.

infant mortality The relatively high conditional probability of failure during the period immediately after an item enters service.

inherent reliability level The level of reliability of an item or of equipment that is attainable with an effective scheduled-maintenance program.

inherent reliability characteristics The design characteristics of an item that determine its inherent level of reliability, including the characteristics that determine the feasibility and cost effectiveness of scheduled maintenance.

inherent safety level The level of safety of an item or of equipment that is associated with its inherent reliability level.

initial maintenance program The scheduled-maintenance tasks and associated intervals developed for new equipment before it enters service.

initial task intervals The task intervals assigned in a prior-to-service maintenance program, subject to adjustment on the basis of findings from actual operating experience.

inspection task A scheduled task requiring testing, measurement, or visual inspection for explicit failure evidence by maintenance personnel (see *on-condition task*, *failure-finding task*).

internal structural item Any portion of the structure whose inspection requires the opening of access doors or the removal of covering items.

item Any level of the equipment or its sets of parts (including the equipment itself) isolated as an entity for study.

items that cannot benefit from scheduled maintenance Items for which no maintenance tasks can be found that are both applicable and effective.

letter check In the airline industry, the alphabetic designations given to scheduled-maintenance packages.

life See *conditional probability of failure*, *probability of survival*.

life-limit task A scheduled discard task (see *safe-life limit*, *economic-life limit*).

line maintenance Scheduled and corrective work performed by mechanics at a line station that has been designated as a maintenance station, usually consisting of inspection tasks that can be performed on items

in their installed position and the replacement, rather than repair, of failed units (see *shop maintenance*).

lubrication tasks Scheduled tasks to assure the existence of completeness of lubrication films; usually performed at intervals specified by the manufacturer.

maintainability The ease with which scheduled or corrective maintenance can be performed on an item.

maintenance base The major maintenance facility of an operating organization, staffed and equipped to perform shop maintenance and heavy maintenance on the equipment itself (see *shop maintenance*).

maintenance package A group of maintenance tasks scheduled for accomplishment at the same time.

Maintenance Review Board A designated group of FAA inspectors, each with specialized skills, which is charged with the responsibility of approving the initial maintenance program for a new commercial transport aircraft.

maintenance station A line station staffed and equipped to perform line maintenance (see *line maintenance*).

major structural inspection The maintenance visit that includes inspection of most structurally significant items, called the D check in the airline industry.

mean time between failures The ratio of total operating experience of all units of an item during a specified period to the number of failures during that period; the reciprocal of the failure rate.

monitoring system One of the various information systems employed in the aircraft industry, consisting of periodic summaries of the reliability data reported by event-oriented systems.

MSG-1 A working paper prepared by the 747 Maintenance Steering Group, published in July 1968 under the title *Handbook: Maintenance Evaluation and Program Development (MSG-1)*; the first use of decision-diagram techniques to develop an initial scheduled-maintenance program.

MSG-2 A refinement of the decision-diagram procedures in MSG-1, published in March 1970 under the title *MSG-2: Airline/Manufacturer Maintenance Program Planning Document*; the immediate precursor of RCM methods.

multiple failure A failure event consisting of the sequential occurrence of two or more independent failures, which may have consequences

that would not be produced by any of the failures occurring separately (see *hidden-failure consequences*).

no scheduled maintenance A maintenance term used to categorize items that have been assigned no scheduled tasks, either because they cannot benefit from scheduled maintenance or because the information necessary to determine the applicability and effectiveness of a proposed task must be derived from operating experience.

nonoperational consequences The economic consequences of a failure that does not affect safety or operational capability, consisting of the direct cost of corrective maintenance; one of the four consequence branches of the RCM decision diagram.

nonsignificant item An item whose failure is evident to the operating crew, has no direct effect on safety or on the operational capability of the equipment, and involves no exceptionally expensive failure modes; nonsignificant items that have no hidden functions are assigned to no scheduled maintenance in an initial maintenance program.

on-condition process In current regulatory usage, scheduled inspections, tests, or measurements to determine whether an item is in, and will remain in, a satisfactory condition until the next scheduled inspection, test, or measurement (see *on-condition task*).

on-condition task Scheduled inspections to detect potential failures; one of the four basic tasks in an RCM program.

operating crew In the airline industry, the flight and cabin crew, the primary source of reports of functional failures.

operating information Reliability information derived from actual operating experience with the equipment after it enters service.

operational consequences The economic consequences of a failure that interferes with the planned use of the equipment, consisting of the imputed cost of the lost operational capability plus the cost of corrective maintenance; one of the four consequence branches of the RCM decision diagram.

opportunity sample An item available for inspection at the maintenance base during the normal disassembly of failed units for repair.

overhaul In current regulatory usage, the maintenance operations which form the basis for returning the measure of time since overhaul to zero, accomplished by the shop as specified in the overhaul manual (see *conditional overhaul, rework task*).

partitioning process The process of dividing complex equipment into convenient entities for analysis.

performance requirement The standard of performance for an item defined as satisfactory by an operating organization.

phase check A maintenance package subdivided into sets of tasks to be accomplished at successive occasions of a more frequent lower-level check.

potential failure An identifiable physical condition which indicates that a functional failure is imminent.

powerplant division One of the three major divisions of an aircraft, consisting of the basic engine and in some cases including the thrust reverser and other quick-engine-change parts.

preload An unintended sustained-load condition caused by design, fabrication, or assembly errors.

premature removal Unscheduled removal of a unit because of a suspected or actual potential or functional failure.

preventive maintenance See *scheduled maintenance*.

prior-to-service program See *initial maintenance program*.

probability density of failure The probability that an item will fail in a defined age interval; the difference between the probability of survival to the start of the interval and the probability of survival to the end of the interval (see *conditional probability of failure*).

probability of survival The probability that an item will survive to a specified operating age, under specified operation conditions, without failure (see *survival curve*).

product improvement Design modifications of an existing item to improve its reliability, usually in response to information derived from operating experience after the equipment enters service.

purging The periodic review of a scheduled-maintenance program to eliminate tasks that are superfluous or no longer effective.

RCM analysis Use of the RCM decision diagram to analyze the maintenance requirements of complex equipment according to the consequences of each failure possibility and the inherent reliability characteristics of each item.

RCM program A scheduled-maintenance program consisting of a set of tasks each of which is generated by RCM analysis.

RCM task A scheduled-maintenance task which satisfies the specific applicability criteria for that type of task (see *on-condition task*, *rework task*, *discard task*, *failure-finding task*).

reduced resistance to failure Physical evidence of a deterioration in the condition or performance of individual units of an item which can be used to define a potential-failure condition for that item (see *wearout characteristics*).

redundancy The design practice of replicating the sources of a function so that the function remains available after the failure of one or more items.

reliability See *probability of survival*.

reliability-centered maintenance A logical discipline for developing a scheduled-maintenance program that will realize the inherent reliability levels of complex equipment at minimum cost (see *RCM analysis*).

reliability data All the failure data, inspection findings, and other information derived from the actual service history of each item.

reliability function See *survival curve*.

reliability growth The improvement in the reliability of a new item as a result of product improvement after the equipment enters service (see *improvable failure rate*).

reliability index One of several quantitative descriptions of failure data (see *failure rate, probability density of failure, probability of survival, conditional probability of failure*).

residual failure rate The remaining failure rate of an item after all applicable and effective scheduled-maintenance tasks are performed.

residual strength The remaining load-carrying capability of a damage-tolerant structural assembly after the failure of one of its elements (see *damage-tolerant structure*).

resistance to failure The ability of an item to withstand the stresses to which it is exposed over time (see *reduced resistance to failure*).

rework task The scheduled removal of all units of an item to perform whatever maintenance tasks are necessary to ensure that the item meets its defined condition and performance standards; one of the four basic tasks in an RCM program (see *overhaul*).

safe-life limit A life limit imposed on an item that is subject to a critical failure, established as some fraction of the average age at which the manufacturer's test data show that failures will occur.

safe-life structure Structure that it is not practical to design to damage-tolerant criteria; its reliability is protected by conservative safe-life limits that remove elements from service before failures are expected.

safety consequences The consequences of a functional failure that could have a direct adverse effect on the safety of the equipment and its occupants; one of the four consequence branches of the RCM decision diagram.

scheduled maintenance Preventive-maintenance tasks scheduled to be accomplished at specified intervals (see *corrective maintenance*).

scheduled removal Removal of serviceable unit at some specified age limit to perform a rework or a discard task (see *premature removal*).

secondary damage The immediate physical damage to other parts or items that results from a specific failure mode.

servicing tasks Scheduled tasks to replenish fluid levels, pressures, and consumable supplies.

shop maintenance Scheduled and corrective work performed by mechanics at the maintenance base, usually consisting of inspection tasks that require disassembly of the item, scheduled rework and discard tasks, and the repair of failed units removed from the equipment at line maintenance stations (see *line maintenance*).

significant item An item whose functional failures have safety or major economic consequences (see *functionally significant item*, *structurally significant item*).

simple item An item whose functional failure is caused by only one or a very few failure modes (see *complex item*).

spectrum hours The current flight history of an aircraft structure expressed in terms of the spectrum loading pattern used in the manufacturer's original fatigue tests.

stress The interaction of an item with its environment; the physical processes that reduce resistance to failure.

stress corrosion Spontaneous collapse of metal with little or no macroscopic signs of impending failure, caused by the combined effects of environment and tensile stress.

structure division One of the three major divisions of an aircraft, consisting of the basic airframe and its load-carrying elements.

structural inspection plan The set of on-condition tasks and their intervals assigned to structurally significant items.

structural ratings Individual ratings for each of the factors affecting the failure resistance of a major structural assembly, used to determine

the class number that defines the relative length of maintenance intervals (see *class number*).

structurally significant item The specific site or region that is the best indicator of the condition of a structural element whose failure would result in either a material reduction in residual strength or the loss of a basic structural function.

survival curve A graph of the probability of survival of an item as a function of age, derived by actuarial analysis of its service history. The area under the curve can be used to measure the average realized age (expected life) of the item under consideration.

system A set of components and their connecting links that provide some basic function at the equipment level.

systems division One of the three major divisions of an aircraft, consisting of all systems items except the powerplant.

task An explicit scheduled-maintenance activity performance by mechanics.

teardown inspection The complete disassembly of a serviceable item that has survived to a specified age limit to examine the condition of each of its parts as a basis for judging whether it would have survived to a proposed higher age limit.

technologically useful life The length of time equipment is expected to remain in service before technological changes in new designs render it obsolete.

time-expired unit A serviceable unit that has reached an age limit established for that item.

time-extension sample A unit designated for special analysis of inspection findings as the basis for extending task intervals.

time since last shop visit The operating age of a unit since its last shop visit for repair or rework.

time since overhaul The operating age of a unit since its last overhaul; in current usage, time since last shop visit.

time since rework The operating age of a unit since it was last reworked.

unverified failures Units removed from the equipment because of suspected malfunctions and subsequently determined by shop inspections and tests to be in an unfailed condition.

verified failures Units confirmed to have experienced a functional failure.

walkaround inspection Scheduled general inspection by line mechanics of those portions of the equipment that are visible from the ground, used as a vehicle for certain specific on-condition tasks.

wearout characteristics The characteristics of a conditional-probability curve that indicate an increase in the conditional probability of failure of an item with increasing operating age (see *reduced resistance to failure*).

wearout region The portion of the conditional-probability curve that shows a marked increase in the conditional probability of failure after an identifiable age.

zero-time To restore the operating age of a unit to zero by means of inspection, rework, or repair.

zonal-installation inspections Scheduled general inspections of the installed items in each geographic zone, including inspection of those portions of the internal structure that can be seen with all installations in place.

index

- A check, 109-110, 285-286, 316-319
- Acceleration recorders, 34
- Accident statistics, 338-339
- Accidental damage, 114, 129, 238
 - effect on fatigue life, 84, 235
- Accidental-damage ratings, structurally significant items, 241-246
 - zonal installation, 281
- Actuarial analysis, 39-48, 57-58, 123-126, 390-419
 - data from defined calendar period, 395-402
 - homogeneous population, 395-408
 - to justify rework tasks, 48, 325-326, 363
 - life-test data, 391-395
 - limitations of, 390-391
 - mixed population, 124-126, 408-411
 - smoothing problem, 402-408
 - useful probability distributions, 411-416
 - uses in age exploration, 123-126, 227
 - see also* age-reliability relationship
- Actuator endcap, flight-control system, 161
 - landing gear, 191-192, 311-312
- Age, 33
 - measures of, 33-34
 - operating age, 304, 408-409
- Age at failure, 35, 393
 - complex items, 38-39, 47
 - simple items, 35-37, 48, 60
 - see also* average age at failure, probability of survival
- Age distribution of operating fleet, 105, 123
- Age exploration, 106-108, 113, 114-115, 292,
 - actuarial analysis, 123-126
 - to adjust task intervals, 122, 192-193, 324-325
 - to determine applicability of rework tasks, 57, 224-225, 305-306, 309-311, 325-326, 361
 - to identify needs for product improvement, 128-135
 - information requirements, 155, 293-297, 367-368
 - opportunity sampling, 108, 224, 225, 307, 314, 315
 - powerplant items, 106-107, 224-227, 312-316
 - structural items, 107, 273, 275, 316-323
 - systems items, 107-108, 192-193, 308-312
- Age-exploration cycle, 155-156, 325
- Age grouping, 403
- Age intervals, 398
- Age limit, applicability of, 46-48, 56-61, 390-391
 - effect on age exploration, 225, 227, 307
 - effect on average realized life, 41-42, 57-58
 - effect on inventory problems, 325, 417-419
 - effect on failure rate, 44-45
 - see also* discard tasks, rework tasks, scheduled overhaul
- Age-reliability relationship, 40-49
 - characteristics of complex items, 46-48
 - characteristics of simple items, 47-48, 56
 - dominant failure modes, 48, 57, 118-119, 310, 319
 - probability of survival, 40-42
 - wearout characteristics, 43-44, 47
- Age-reliability relationships, Boeing 727 constant-

speed drive, 303-305
 Boeing 727 generator, 310
 General Electric CF6-6 engine, 124-125
 patterns of, 46-48
 Pratt & Whitney JT8D-7 engine, 44, 226
 Pratt & Whitney R-2800 CA-15 engine, 374
 Wright R-3350 TC-18 engine, 374
 Air Transport Association, 5, 386-387
 Airborne integrated data systems (AIDS), 127
 Airbus Industrie A-300, 5, 386
 Air-conditioning pack, Douglas DC-10, 164-170
 Aircraft maintenance information system, 296
 Airplane overhaul, 249, 274
 see also major structural inspections
 Airworthiness, *see* safety levels
 Airworthiness directives, Boeing 747, floor-beam
 inspection, 322-323
 history of, 135-136
 Airworthiness requirements, powerplants, 195
 structure, 230-231
 systems, 339-340
 Alert rate, chronic maintenance problems, 301
 engine shutdown, 377
 failure, 382
 Alert system, safety, 135, 247
 see also information systems
 Analysis of failure data, 301-307
 see also actuarial analysis
 Analysis and surveillance program, FAA, 154
 Applicability criteria for maintenance tasks, 49,
 50-51, 68-69, 142, 359-360
 discard tasks, economic-life, 60-61
 safe-life, 59-60
 failure-finding tasks, 62-63
 on-condition tasks, 51-57
 rework tasks, 56-58
 Applied loads, 36, 228, 230-231, 331
 Auditing process, 152, 157, 350-369
 analysis of equipment, 362-367
 decision process, 354-362
 ongoing program, 367-368
 packaging, 367
 powerplant analysis, 363-364
 program-development project, 351-354
 programs for in-service aircraft, 368-369
 structure analysis, 364-366
 systems analysis, 362-363
 Average age at failure, 38-39, 60, 143, 393, 412
 Average fatigue life, 243, 320
 Average realized life, 42-44
 Average stress level, 37
 B check, 109-110, 285-287, 288
 Bathtub curve, 45, 47
 see also conditional probability of failure
 Bearing failure, accessory drive, Pratt & Whitney
 JT8D-7, 207, 211-213
 elevator, Douglas DC-8, 326-327
 generator, Boeing 727, 126, 309-310
 Bird strike, *see* accidental damage
 Boeing 720, hydraulic system, 384
 Boeing 727, automatic-takeoff thrust control, 340
 constant-speed drive, 303-306
 generator, 126, 309-310
 MSG-2 review of systems program, 344-345
 rate of fleet growth, 105
 Boeing 737, hydraulic system, 385
 powerplant, *see* Pratt & Whitney JT8D-7 engine
 shock strut, main landing gear, 12
 Boeing 747, airworthiness directives, 135-137
 change-order authorizations, 135-137
 failure reports by operating crew, 21
 floor-beam failure, 322
 high-frequency communications subsystem,
 186-190
 initial maintenance program, 5
 maintenance manhours, 74-75
 maintenance-package contents, 288-289
 major structural inspections, 6, 274-275
 overhaul (rework) items in initial program, 192
 purging of maintenance program, 328
 rate of fleet growth, 105
 toilets, on-condition task for, 308-309
 zone numbering system, 279
 Borescope inspections, 52, 71, 76, 127, 198
 Brake assembly, main landing gear, Douglas DC-10,
 12, 178-186
 Brake wear indicator, 179, 183
 Broomstick check, 71
 Built-in test equipment, 150, 163, 303
 C check, 109-110, 285-287, 288-289
 C-sump problem, General Electric CF6-6, 313
 Cancellations, *see* operational consequences
 Certification, new aircraft, 106, 231
 new engines, 199
 Change-order authorizations, Boeing 747,
 135-137

- Chronic maintenance problems, 301, 303
- Class number, structurally significant items, 244-295
 - zonal inspections, 280-281
 - see also* structural inspection plan
- Cockpit instrumentation, 34, 61, 127, 159, 163, 196, 357
- Combustion chambers, 216
- Communications system, high-frequency, Boeing 747, 186-190
- Complex equipment, maintenance-redesign cycle, 156, 324-327
 - reliability problems in, 9-11, 388
 - role of product improvement in development, 75-77, 128-137
- Complex items, 37
 - age-reliability characteristics, 47-48
 - average age at failure, 38-39
 - dominant failure modes, 38, 119
- Component Reliability Program, 378
- Compressor, assembly, 121
 - blades, 12, 216
 - disks, 118
 - rear frame, 12
 - see also* turbine blades
- Concorde, 5, 386
- Condition-monitoring process, 65-66, 345
- Conditional overhaul, 72, 383
- Conditional probability of failure, 43-44, 398
 - patterns of, 46-48
 - see also* age-reliability relationship
- Conditional-probability curve, 43
- Configuration-deviation list (CDL), 163, 358
- Consequences of failure, 25-31
 - delayed, 88-89
 - effectiveness criteria for tasks, 51, 86-89, 91-96, 360
 - evaluation of, 86-89, 357-358
 - hidden-failure consequences, 28
 - impact on maintenance decisions, 7, 25, 104, 116-121, 293
 - as inherent reliability characteristic, 104, 342, 388
 - multiple failures, 29-30
 - nonoperational consequences, 27-28
 - operational consequences, 27, 85
 - role of design, 11, 75-76, 85, 140-141, 159-161, 230-237, 342, 347, 388
 - safety consequences, 25-26
- Constant-speed drive, Boeing 727, 303-306
- Douglas DC-8, 378
- Controller, *see* maintenance controller
- Corrective maintenance, 11
 - cost of failure, 27, 95-96
 - deferral of, 13, 22, 30, 88-89, 249
- Corrosion, 236
 - effect on fatigue life, 84, 236
 - environmental factors, 236, 237, 243, 248
 - prevention, 236, 312
 - stress corrosion, 236
- Corrosion ratings, structurally significant items, 243-244
- Cost data, *see* economic-tradeoff study
- Cost of default decisions, 98-99
- Cost of failure, *see* economic consequences
- Cost effectiveness, 52, 70, 98-103, 130-134
 - of basic tasks, 67-69
 - as criterion of task effectiveness, 52, 57-58, 61, 63, 68-69, 95-96, 102, 363
 - determination for applicable task, 100-103
 - determination for product improvement, 130-134, 323
 - impact of inherent reliability characteristics, 103-104
- Cost-tradeoff analysis, *see* economic-tradeoff study
- Crack, *see* fatigue crack
- Crack initiation, 233
 - see also* fatigue life
- Crack-propagation characteristics, 106-107, 208, 232-233
- Crack-propagation ratings, structurally significant items, 241-246
- Crew, *see* operating crew
- Critical crack length, 233, 248, 323
- Critical failures, 26
 - powerplant items, 85-86, 116-117, 194, 198, 204, 205-211, 313, 358
 - product improvement, 128-137
 - structural items, 84, 228-229, 230, 252-257
 - systems items, 158, 161, 170-178
 - unanticipated, 115, 116-118, 135-136, 293
 - see also* safety consequences
- Cumulative failure number, 402-404
- Cyclic loads, *see* applied load
- D check, 249, 252, 285-287, 289, 319-320
- Daily operations report, 296
- Damage, *see* accidental damage, reduced resistance to failure
- Damage-tolerant (fail-safe) design, 234, 320

- Damage-tolerant strength, 233-234, 242, 335-336
- Damage-tolerant structural items, 237, 239, 253-254, 256-257
 - see also* structural inspection plan, structures
- Data elements for analysis, *see* information requirements
- Decision-diagram approach, history of, 4-6, 384, 385-386
 - MSG-1, 4-5, 385-386
 - MSG-2, 5, 386
- Decision diagrams, cost effectiveness of product improvement, 132
 - cost effectiveness of applicable task, 101
 - evaluation of failure consequences, 88
 - evaluation of proposed tasks, 90
 - RCM decision diagram, 92-93, 143, 160, 209, 212, 253
 - structural inspection plan, 240
- Decision making, in absence of information, 79, 97-99
 - bounding of problem, 78, 144, 152
 - RCM decision process, 86-99
 - see also* RCM analysis
- Decision worksheet, 151-153
- Default decisions, 95-96, 97-99
 - cost of, 99, 105
 - failure-finding tasks, 62
 - role of default strategy, 97, 361
- Deferred repairs, 13, 22, 30, 88-89, 249
- Delays, *see* operational consequences
- Delay and cancellation summary, 294, 299
- Depot, *see* maintenance base
- Design, damage-tolerant, 234
 - fail-operational, 160
 - fail-safe, 159
 - safe-life, 234
 - see also* consequences of failure
- Design changes, *see* product improvement, redesign
- Design characteristics, complex equipment, 9-11, 75-76, 140-141, 161, 347
 - powerplant items, 76, 196-199, 201
 - structural items, 75-76, 229, 230-237
 - systems items, 75-76, 159-161, 163
- Design goals, performance capabilities, 10
 - structural, 235, 247-248
- Design loads, 230-231, 234
- Design-maintenance partnership, 24, 135-136, 153-157, 341-342
- Detailed inspections, structurally significant
 - items, 238
- Detection of failures, 20-24
 - failure-finding tasks, 50, 61, 190-191
 - on-condition tasks, 50, 51-52
 - role of the operating crew, 20-22
 - verification of failures, 22-24, 125
 - see also* evidence of failure
- Deterioration, *see* reduced resistance to failure
- Developmental testing, powerplant items, 199
 - safe-life limits, 59-60
 - structural items, 231, 248
 - see also* test data
- Diagnostic techniques, *see* inspection technology
- Discard tasks, 50, 58-61, 359-360
 - applicability criteria, economic-life, 61, 98
 - safe-life, 59, 98, 359-360
 - characteristics of, 66, 68-69
 - control of critical failures, 58-60, 68, 381, 388
 - cost effectiveness, 58, 61, 68-69, 98
 - task intervals, *see* safe-life limits
- Dispatch reliability, 135, 370
 - see also* operational consequences
- Dominant failure modes, 38
 - applicability of age limit, 48, 57, 310
 - effect of product improvement, 119, 227
- Douglas A-4, fuel pump, 12, 170-178
- Douglas DC-8, cabin compressor, 378
 - constant-speed drive, 378
 - elevator bearings, 326-327
 - freon compressor, 378
 - generator and bus-tie relay, 310
 - hydraulic pump, 378-379
 - major structural inspections, 6, 274-275
 - overhaul (rework) items in initial program, 5, 372
 - premature-removal rate of systems items, 373
- Douglas DC-10, air-conditioning pack, 164-170
 - brake assembly, main landing gear, 178-186
 - fatigue-life design goal, 235
 - initial maintenance program, 5, 163, 246-248, 256-257
 - landing-gear actuator end cap, 311
 - overhaul (rework) items in initial program, 5, 192
 - powerplant, *see* General Electric CF6-6 engine
 - rate of fleet growth, 105
 - rear spar at bulkhead intersection, 12
 - shock-strut outer cylinder, 267-273
 - spar cap, wing rear spar, 260-267
 - walkaround inspection plan, 282
 - wing-to-fuselage attach tee, 258-260

- Economic benefits of RCM programs, 5-6, 138, 343, 347-348
- Economic consequences, 7, 27, 95-96
 - see also* nonoperational consequences, operational consequences
- Economic-life limits, 60-61
 - see also* discard tasks
- Economic-tradeoff study, 102-103, 134
 - to justify product improvement, 134
 - to justify rework task, 102-103, 361
 - see also* cost effectiveness
- Eddy-current inspection, 127, 238
- Effectiveness criteria for maintenance tasks, 48, 50-51, 87-89, 94-96, 360
 - hidden-failure consequences, 96
 - nonoperational consequences, 96
 - operational consequences, 95
 - safety consequences, 94
- Ejection-seat pyrotechnic devices, 59, 191
- Electrical and electronic items, 85, 158
 - see also* high-frequency communications subsystem
- Elevator-control-system shafts, 28
- Engine, *see* powerplants
- Engine heavy maintenance, 378
- Engineering redesign, *see* product improvement
- Environmental-control system, *see* air-conditioning pack
- European Maintenance System Guide*, 5, 386
- Event-oriented inspections, 284
- Event-oriented system, 294
 - see also* information systems
- Evidence of failure, 18-20
 - functional failures, 20, 163, 165, 201, 204, 356-357
 - hidden failures, 20-21, 63-64
 - potential failures, 19-20, 52-55
- Evident failures, 21, 23, 26, 94
 - determination of, 87-89, 114, 150, 163, 224, 252
- Exhaust-gas temperature 195-196, 213, 214
- Exponential distribution, 412-413
 - age-reliability relationships in complex items, 46-48, 119
 - establishing failure-finding interval, 62
 - prediction of reliability improvement, 120
 - special uses of, 417-419
- External detectability, as damage-tolerant design
 - characteristic, 76, 239, 248
 - effect on structural ratings, 241, 242, 249
 - designation of structurally significant items, 249, 264-265
- External structural items, 239
- Fail-operational design, 160
- Fail-safe design, 159
 - see also* damage-tolerant design
- Failure, 16, 17-20
 - in complex items, 37-39, 45-48
 - functional failure, 18
 - model of failure process, 33-35
 - multiple failure, 28-31
 - potential failure, 19
 - quantitative descriptions of, 39-45
 - in simple items, 31-33, 45-48
 - verified failures, 22-24, 125
- Failure analysis, 301-307
 - see also* actuarial analysis
- Failure characteristics, *see* applicability criteria for maintenance tasks
- Failure data, interpretation of, 24
- Failure effects, 163, 165, 201, 204, 356-357
- Failure-finding tasks, 50, 61-64
 - applicability criteria, 62, 360
 - characteristics of, 66, 68-69
 - effectiveness criteria, 62-63, 96
 - task intervals, 61, 62-63, 169, 191, 312, 361
- Failure modes, 37-38, 149, 163, 201, 356
 - critical, 85-87, 198, 204, 205-211, 358
 - dominant, 38, 48, 119, 308-310
 - relationship to age, 38-39
 - with unusually high repair costs, 101, 126, 308-310, 358
- Failure modes and effects analysis (FMEA), 80
- Failure process, coping with, 76-77
 - generalized model of, 33-35
- Failure rate, 40
 - effect of product improvement, 119
 - effect of rework task, 44-45, 48
 - improvable, 119
 - prediction of reliability improvement, 120
- Failure-reporting system, *see* operating crew
- Failure reports, *see* information systems
- Failure resistance, *see* resistance to failure
- Failure substitution, 11, 27, 76
- Fatigue, 84, 231-235
 - relationship to operating age, 37, 48, 52-53, 84, 231-232, 234, 238, 274-275
- Fatigue crack, 52-53, 231-232
 - critical length, 233, 248, 323

definition as potential failure, 52, 210
 212-213, 242
 effect on structural strength, 232
 inspection intervals, 52-53, 106-107, 243-247
 propagation characteristics, 106-107, 208, 232-233
see also crack initiation, crack-propagation ratings
 Fatigue damage, effect on structural strength,
 232-233
 repair of, 230, 274, 321, 323
 see also external detectability
 Fatigue life, 232
 effect of corrosion, 84, 236
 effect of preload condition, 235-236
 Fatigue-life design goal, Douglas DC-10 structure
 235, 247-248
 as reference for relative inspection intervals,
 244-247
 as reference for structural ratings, 243-244
 Fatigue-life ratings, structurally significant items,
 241-243
 Fatigue-test data, *see* test data
 Federal Aviation Administration, airworthiness
 directives, 135-136, 322-323
 analysis and surveillance program, 154
 certification procedures, 199, 231
 Maintenance Review Board, 8, 145, 372
 Fire-extinguishing system, 22
 Fire-warning system, powerplant, 22, 190-191
 Fleet-leader concept, 113, 275
 Flight-control system, actuator endcap, 161
 bearing failure, 326-327
 Flight cycles, 33-34
 Flight log, 294-295
 Flight-log monitoring, 301
 Forced removals, 108
 Forced samples, 225
 Fractional sampling, 321
 Freon compressor, Douglas DC-8, 378
 Fuel pump, Douglas A-4, 12, 170-178
 Functional failures, 18-19
 definition of, 31-32, 87, 149, 163, 201, 230, 356
 effect of level of item, 53, 61, 224, 255
 Functionally significant items, 85
 see also significant items
 Functions, evident and hidden, 21-22, 87
 of item, 19, 31, 86-87, 161, 163, 201, 255, 355-357
 of powerplant, 195, 205
 rarely used, 283
 redundant, 75, 158-160, 161-162, 195
 of structure, 229-230, 252, 255
 of systems, 159, 161, 163
 General Electric CF6-6 engine, age-reliability
 characteristics, 124-125
 compressor rear frame, 12
 C-sump problem, 313
 initial inspection requirements, 106-107
 General inspections, external structure, 240, 283
 nonsignificant structural items, 240, 281, 282
 structurally significant items, 238
 walkaround inspections, 73, 282
 zonal inspections, 73, 277-281
 Generator and bus-tie relay, Douglas DC-8, 310
 Generator, Boeing 727, 126, 309-310
 Geriatric aircraft, 118, 131, 155-156, 321-323, 325
 Gust loads, 231
 Hard-time directory, 231
 Hard-time maintenance process, 65, 385
 Hard-time policy, 2-6, 371-382
 changing perceptions of, 66, 376-382
 current regulatory usage, 65, 371-372
 hard-time paradox, 371-376
 see also discard tasks, rework tasks, scheduled
 overhaul
 Hidden-failure consequences, 28-31, 87-89, 96
 Hidden-function items, 21
 identification of, 81, 87, 97, 356
 Hidden functions, 21-22, 61-64, 356
 regular testing by operating crew, 61, 283-284
 required level of availability, 30-31, 62-63,
 169, 361
 role in multiple failures, 28-31, 81
 see also failure-finding tasks
 High-frequency communications subsystem,
 Boeing 747, 186-190
 High-lift devices, 230
 Identification and routing tag, 296-297
 Improvable failure rate, 119-120
 Imputed cost of operational consequences, 7, 27,
 95, 361
 In-flight engine shutdown report, 301-302
 In-service equipment, RCM programs for, 137-138,
 343-347
 Infant mortality, 45, 125-126
 Information excluded by life-test data, 394-395
 Information flow, 153-157

- Information problem, prior-to-service decisions, 7-8, 78-79, 97-99, 144
- task intervals, 324-325
- teardown inspections, 6, 66, 305, 372-375
- Information requirements, assessment of rework tasks, 44-45, 57-58, 91, 97-103, 359, 361, 363, 390-391
- management of ongoing program, 155, 293-297, 367-368
- modification of initial program, 114-115, 293, 307-323
- product improvement, 128-135
- RCM analysis, 7-8, 78-79, 86-99, 144, 146, 149-151
- powerplant items, 199-204
- structural items, 247-252
- systems items, 161-166
- see also* age exploration, RCM analysis
- Information systems, 135, 293-300
- Information worksheet, powerplant items, 149-151, 201-203
- structural items, 248-251
- systems items, 149-151, 163-165
- Inherent reliability, 103
- Inherent reliability characteristics, 75-76, 103-104, 114-115
- Initial maintenance program, development of, 78-111, 147-152
- auditing of program development, 350-369
- completion of, 72-73, 109-110, 276-291
- organization of program-development team, 145-147, 353
- see also* RCM analysis
- Inspectability, 140, 341
- Inspection, *see* failure-finding tasks, general inspections, on-condition tasks
- Inspection findings, as basis for interval extension, 107-108, 121-123, 225-226, 306-307
- structural, 316, 318-319
- see also* teardown inspections
- Inspection samples, powerplant items, 108, 225, 315
- structure, 108, 319-321
- see also* time-extension samples
- Inspection technology, 126-128, 341-342
- Inspection, structural, *see* structural inspection plan
- Instrumentation, *see* cockpit instrumentation
- Internal engine items, 195, 198-199, 225
- Internal structural items, 239, 252, 320-321
- external detectability, 241, 248, 249
- Intervals, *see* age intervals, task intervals
- Inventory problems, effect of rework task, 325, 417-419
- Isotope inspection, 52, 71, 211
- Item, 81
- Item description, 149, 163, 201, 248
- Items that cannot benefit from scheduled maintenance, 70, 85, 158-159, 161, 168, 176-177
- see also* nonsignificant items
- Landing gear, actuator endcap, 191-192, 311-312
- brake assembly, Douglas DC-10, 178-186
- shock-strut outer cylinder, Douglas DC-10, 267-273
- Letter checks, 109-110, 284-289
- adjustment of intervals, 122-123
- LIBRA (Logical Information of Reliability Analysis), 382
- Life of item, 48, 415
- age at failure, 35-39, 47-48, 60, 393
- average realized life, 42-44
- conditional probability of failure, 43-44, 46-48, 398
- fatigue life, 232
- probability of survival, 40-42
- Life limit, *see* discard tasks, safe-life limits
- Life tests, 391-395
- Lightning strikes, *see* accidental damage
- Limit loads, structural, 231
- Line maintenance, 13-14
- Load requirements, 230-234
- Lockheed 1011, 386
- Log sheet, airplane flight log, 294-295
- Lubrication tasks, 72-73, 283
- Magnetic-plug inspection, 213
- Maintenance, *see* corrective maintenance, scheduled maintenance
- Maintenance activities, 11-14, 71-75
- Maintenance base, 13
- Maintenance controller, 22
- Maintenance cycle, 156
- Maintenance information system, 296
- see also* information systems
- Maintenance packages, 108-110, 285-291
- partial contents for Boeing 747, 288-289
- partial contents for McDonnell F4J, 290-291
- Maintenance philosophy, *xvi-xx*, 347-348
- Maintenance plan, 11-14, 367

- Maintenance processes, current regulatory usage, 65-66, 385
- Maintenance program, *see* scheduled-maintenance program
- Maintenance-redesign cycle, 116-121, 312-313
- Maintenance Review Board, 8, 145, 372
- Maintenance station, 13
- Maintenance tasks, *see* scheduled-maintenance tasks
- Maintenance technology, 126-128, 341-342
- Major divisions of equipment, 81, 147-148
 - powerplant, 194
 - structure, 228-229
 - systems, 158
- Major structural inspections, 249, 252
 - comparison of policies, 6, 274-275
 - role in age exploration, 274-275, 319-321
 - see also* D check
- Management of the ongoing program, 153-156, 293-299, 367-368
 - information systems, 293-299, 368
 - modifying the program, 121-128, 307-325
 - purging the program, 328-329
 - reacting to unanticipated failures, 116-121
 - resolving differences of opinion, 325-327
 - uses of operating information, 113-116
 - see also* age exploration
- McDonnell F4J, maintenance-package contents, 290-291
 - MSG-2 review of program, 346-347
 - zone numbering system, 378
- Mean time between failures, 40, 340
- Military applications, 34, 94, 113, 135, 170-178
 - see also* Douglas A-4, McDonnell F4J
- Minimum-equipment list (MEL), 163, 354, 358
- Mixed population, actuarial analysis of, 408-411
- Model of failure process, 33-35
- Monolithic elements, damage-tolerant, 234, 237
- MSG-1, 5, 344, 385-286
- MSG-2, 5, 343-347, 386
 - Douglas DC-10 structure program, 257
 - review of Boeing 727 systems program, 344-345
 - review of McDonnell F4J program, 346-347
- Multiengine aircraft, consequences of engine failure, 195, 333-335
 - see also* powerplants
- Multiple failures, evaluation of consequences, 28, 29-31, 311
 - probability of, 28-29
 - role of hidden functions, 28-31, 81
- Multiple-load-path structural assembly, *see* damage-tolerant structural items
- National Transport Safety Board statistics, 338-339
- No scheduled maintenance, 65, 166, 193
 - as default decision, 77, 79, 97-98, 114
 - nonsignificant items, 80, 96, 158-161
- Nonoperational consequences, 27-28, 30, 88-89, 93, 142, 158-161, 358
- Non-RCM tasks, 72-73, 277-284, 366
 - event-oriented inspections, 284
 - general external inspections, 283
 - servicing and lubrication tasks, 72-73, 283
 - testing of rarely used functions, 283
 - walkaround checks, 73, 282
 - zonal inspections, 73, 277-281
- Nonsignificant items, 81, 85, 97, 142, 148, 158
- Normal distribution, 412-415
- Nozzle guide vanes, Pratt & Whitney JT3D engine, 202-204
 - Pratt & Whitney JT8D-7 engine, 209
- Oil-screen inspection, 71, 213
- On-aircraft inspections, *see* on-condition tasks
- On-condition maintenance process, 65, 345
 - introduction of, 383-385
- On-condition tasks, 50-56
 - applicability criteria, 52, 66, 98
 - characteristics of, 65, 67, 68-69
 - control of critical failures, 116-117, 312-313, 388
 - effectiveness criteria, 52-53, 90-91, 98
 - inspection intervals, 52-53, 107, 192, 245-247, 324-325
 - on-aircraft inspections, 71, 198, 341
 - role in powerplant programs, 106, 198-199, 224, 226
 - role in structure programs, 108, 229, 255
 - shop inspections, 198
 - see also* powerplant structures
- Operating age, *see* age
- Operating crew, evident and hidden failures, 21, 61, 159, 163, 196, 357
 - failure-reporting system, 21, 22, 294-295
 - frame of reference, 22-23, 63
 - role as failure observers, 13, 20-22
 - testing of hidden-function items, 61, 312
- Operating environment, effect on definition of

474

- failure, 18
- effect on definition of consequences, 27, 135
- effect on task intervals, 236, 237, 243, 247
- Operating information, uses of, 113-115, 292-329
- Operating reliability, and design, 75-76, 103-104, 140-141
 - and safety, 2-3, 331-337, 340-341, 370
 - see also* operational consequences
- Operating restrictions, coping with failures, 22, 76-77, 118, 166, 333
 - configuration-deviation list, 163, 358
 - control of gross operating weights, 195, 231
 - minimum-equipment list, 163, 354, 358
- Operating safety, and design, 2-3, 11, 159-161, 201, 230-237, 340-341, 388
 - relationship to scheduled maintenance, 2-3, 331-337, 370-371, 387-389
 - see also* hidden-failure consequences, safety consequences
- Operating weight, responsibilities of operating organization, 195, 231
 - effect on level of operating risk, 334-335, 336-337
- Operational consequences, 27, 30-31, 85, 88-89, 308, 354, 358
 - determination of, 27, 149-150, 159-161, 163, 194, 196, 201, 211-212, 213
 - imputed cost of, 7, 27, 95, 135, 361
- Operational performance goals, 10, 234
- Operational readiness, 135, 170
- Opportunity samples, 108, 224, 225, 307, 312, 314, 315
 - see also* age exploration, powerplants
- Overhaul, *see* rework tasks, scheduled overhaul

- Packaging of maintenance tasks, 109-110, 284-291, 351-352, 367
 - structural inspection program, 249
- Part-time spares, 383
- Partitioning of equipment, identification of significant items, 7, 81-83, 142, 149
 - major divisions of equipment, 81, 147-148
- Partitioning of premature-removal data, 124-126, 408-411
 - see also* actuarial analysis
- 100 percent program, structures, 320
- Potential failure, 19
 - definition of, 19-20, 31-33, 53-55, 254
 - effect of level of item, 53, 61
 - preemption of functional failures, 11, 27, 76, 226
- Powerplant division, 147-148, 194
- Powerplants, age exploration of, 106-107, 224-227, 312-316
 - analysis of basic engine function, Pratt & Whitney JT8D-7, 205-217
 - failures caused by deterioration, 195-196, 213-247
 - fractures with critical secondary damage, 205-211
 - fractures with no critical secondary damage, 211-213
 - analysis of secondary engine functions, Pratt & Whitney JT8D-7, 217-224
 - characteristics of powerplant items, 85-86, 195-196
 - first-stage nozzle guide vanes, Pratt & Whitney JT3D, 202-204
 - functions of, 195, 205
 - information requirements, 199-204
 - role of scheduled maintenance, 331, 333-335
- Pratt & Whitney JT3D engine, engine-shutdown rate, 301-303
 - first-stage nozzle guide vanes, 202-204
 - premature-removal rate, 302
- Pratt & Whitney JT4 engine, overhaul-interval history, 381
- Pratt & Whitney JT8D-7 engine, age-reliability relationship, 42-45, 398-408
 - history of reliability improvement, 119, 226-227
 - opportunity-sampling program, 122, 314-315
 - prediction of reliability improvement, 120
 - RCM analysis of, 205-224
- Pratt & Whitney R-2800 CA-15 engine, age-reliability relationship, 374-375
- Precautionary removals, 24
- Preload condition, 235-236
- Premature removals, 24
 - actuarial analysis of, 39-48, 57-58, 123-126, 390-419
 - systems items, Douglas DC-8, 373
- Premature-removal report, 298-299
 - see also* information systems
- Preventive maintenance, 11
 - product improvement as, 75-77
 - see also* scheduled maintenance
- Prior-to-service program, *see* initial maintenance program
- Probability, dilemma of extreme improbability,

- 339-341
of survival, 40-42
see also conditional probability of failure
- Probability density of failure, 42-43, 413, 414, 416
- Probability distributions, 411-419
exponential, 412-413
normal, 412-415
Weibull, 415
- Product improvement, 75-77, 128-137
determining desirability of, 131-134, 323
determining need for, 129-131
information requirements, 134-135
maintenance-redesign cycle, 116-121, 312-313
role in equipment development, 135-137, 348
- Program-development team, 145-147, 353
- Pyrotechnic devices, 59, 191
- Radiography inspection, 52, 127
- Random damage, *see* accidental damage
- Rate of fleet growth, 105, 123
- Rating scales, structurally significant items,
241-244
zonal installation, 281
- RCM analysis, 6-9, 78-80, 86-99, 141-144, 362-366
air-conditioning pack, Douglas DC-10, 164-170
brake assembly, main landing gear, Douglas
DC-10, 178-186
elevator bearings, flight-control system, Douglas
DC-8, 326-327
fuel pump, Douglas A-4, 170-178
high-frequency communications subsystem,
Boeing 747, 186-190
powerplant, Pratt & Whitney JT8D, 205-224
shock-strut outer cylinder, Douglas DC-10,
252-256, 267-273
spar cap, wing rear spar, Douglas DC-10,
252-256, 260-267
wing-to-fuselage attach tee, Douglas DC-10,
252-256, 258-260
- RCM decision diagram, 91-99, 358
evaluation of failure consequences, 86-89,
357-358
evaluation of proposed tasks, 89-91, 359-361
- RCM programs, auditing of program development,
350-369
applications to commercial aircraft, 140-157
applications to other equipment, 80, 140-141,
341-342, 347-348
development of initial program, 78-111, 147-152
history of, 4-6, 370-387
for in-service fleets, 137-138, 343-346
management of, 153-156, 293-299, 367-368
organization of program-development team,
145-147, 353
purging the program, 328-329
- Rear spar at bulkhead intersection,
Douglas DC-10, 12
- Reciprocating engines, 10, 47, 374-375
- Redesign, as default action, 92-93, 95, 96, 128-131,
176-177
economic desirability, 131-135
see also product improvement
- Reduced operating capability, *see* operational
consequences
- Reduced resistance to failure, 32-37
ability to measure, 19-20, 51-53, 104
rate of reduction, 104, 106-107, 114-115
- Redundancy, 5, 11, 75, 140, 149, 159-160, 161-162,
195, 201, 234, 249, 387
see also damage-tolerant structural items,
multiengine aircraft
- Regulatory usage, 65-66, 371-372, 385
- Reliability, 40
indexes of, 39-45
inherent reliability, 103
- Reliability-centered maintenance, 1, 6-9, 141-144
a maintenance philosophy, *xvi-xx*
relationship to MSG-2, *vii-viii*, 5-6, 385-387
see also RCM analysis, RCM programs
- Reliability characteristics, inherent, 75-77,
103-105, 114-115
- Reliability controlled overhaul program
(RCOH), 382
- Reliability data, ranking of, 293
- Reliability problems in complex equipment,
9-11, 388
- Reliability programs, 376-387
- Reliability-stress analysis, 382
- Removals, *see* premature removals, scheduled
removals
- Repair costs, *see* economic consequences
- Residual strength, effect of fatigue, 232-233
- Residual-strength ratings, damage-tolerant
structural elements, 233, 241-242, 321
- Resistance to failure, 32-37, 51-53, 84-85, 161,
233, 364
see also fatigue life, reduced resistance to failure
- Resolving differences of opinion, 325-329

- Rework tasks, 50, 56-58
 - applicability criteria, 4, 57, 66, 71-72, 143, 224-225, 359, 363
 - characteristics of, 65, 67, 68-69
 - control of critical failures, 51, 68, 360
 - default decision in initial program, 45, 91, 97-99, 144, 361
 - effect on age exploration, 225
 - effect on failure rate, 44-45, 48
 - effect on inventory problems, 5, 67, 325, 417-419
 - effect on shop workload, 57-58
 - effectiveness criteria, 57-58, 100-103, 360, 363
 - task intervals, 58, 102, 193, 224-225, 359, 363
 - see also* scheduled overhaul
- Risk evaluation, problem of, 337-340

- Safe-life design, 234
- Safe-life discard tasks, *see* discard tasks
- Safe-life items, powerplants, 72, 118, 198, 209-210
 - structure, 234-235, 237, 240, 242, 244-245, 254-257, 267-273
 - systems, 161, 311-312
- Safe-life limits, 58-60, 210, 234-235, 248, 359-360
- Safety, *see* operating safety, safety level
- Safety-alert system, 135, 247
- Safety consequences, 25-27, 87-89, 91-95, 358
 - see also* critical failures
- Safety levels, 331-341
 - dilemma of extreme improbability, 339-341
 - effect of powerplant failures, 333-335
 - effect of structural failures, 335-337
 - effect of systems failures, 332-333
 - problem of risk evaluation, 337-339
- Sample inspections, to determine optimum
 - inspection intervals, 106-107
 - requirements for age exploration, 106-108, 224-225, 274-275, 312, 312-321
- Sample overhauls, 377-381
- Samples, forced, 225
 - opportunity, 108, 224, 225, 307, 312, 314, 315
 - time-extension, 121, 296, 307, 378
- Sampling, fractional, 321
- Sampling program, internal engine items, 195, 198-199, 225
 - internal structural items, 320-321
- Scheduled maintenance, items that cannot benefit from, 70, 85, 158-159, 161, 168, 176-177
 - role of, *xvi-xx*, 3, 331-341, 347-348, 387-388
- Scheduled-maintenance program, 11
 - dimensions of, 71-75
 - see also* initial maintenance program, RCM programs
- Scheduled-maintenance requirements, *see* consequences of failure
- Scheduled-maintenance tasks, 50-69
 - discard tasks, 58-61
 - failure-finding tasks, 61-64
 - non-RCM tasks, 72-73, 277-284, 366
 - on-condition tasks, 51-56
 - rework tasks, 56-57
 - role in maintenance program, 71-72
- Scheduled-maintenance workload, 75
- Scheduled overhaul, 16, 47-48, 56, 65, 66, 249-274
 - changing perceptions of overhaul policy, 376-382
 - current regulatory usage, 65, 371-372
 - the hard-time paradox, 371-376
 - see also* age limits, rework tasks
- Scheduled removals, 24
 - see also* discard tasks, rework tasks
- Service checks, 110, 285-286
- Service life, *see* average fatigue life, technologically useful life
- Servicing tasks, 72-73, 283
- Shock strut, main landing gear, Boeing 737, 12
 - outer cylinder, Douglas DC-10, 267-273
- Shop maintenance, 13-14, 71-72
- Shop workload, effect of scheduled removals, 57-58
- Shotgun troubleshooting, 23
- Significant items, 80-86
 - functionally significant items, 85
 - identification of, 80-83
 - structurally significant items, 84, 237-238
- Signature of failure mode, 127
- Simple items, 34
 - age-reliability characteristics, 47-48
 - average age at failure, 37
 - failure process, 31-37
- Single-celled item, *see* simple items
- Single-engine aircraft, 94, 95, 127, 170-178, 217
- Spar cap, wing rear spar, Douglas DC-10, 260-267
- Spectrographic oil analysis, 71, 127
- Spectrum hours, 249
- SSI, *see* structurally significant items
- Static load tests, *see* . . .
- Statistical reliability reports, 135
- Statistical techniques, *see* actuarial analysis
- Steering committee, 145-147, 351

Stress, 32-39
 Stress corrosion, 236
 Stress cycles, 33
 Structural inspection findings, 316-320
 Structural inspection plan, 229, 238-247
 nonsignificant structural items, 240, 280-281
 100 percent program, 320
 rating factors, 240-243
 corrosion, 84, 236, 237, 241-244, 248
 crack propagation, 232-233, 241-246
 fatigue life, 84, 232, 235-236, 241-243
 residual strength, 232-233, 241-242, 321
 ratings for damage-tolerant items, 240-245
 ratings for safe-life items, 240-241
 relative inspection intervals, 244-247
 role in age exploration, 229, 252, 273-275
 sampling program, 320-321
 Structural integrity audit and inspection document, 321-322
 Structurally significant items, 84, 237-238, 240, 247
 Structure division, 147, 272
 Structures, age exploration of, 107, 273-275, 315-323
 analysis of damage-tolerant items, 252-254, 256-257
 spar cap, wing rear spar, Douglas DC-10, 260-267
 wing-to-fuselage attach tee, Douglas DC-10, 258-260
 analysis of safe-life items, 252-257
 shock-strut outer cylinder, Douglas DC-10, 267-273
 analysis of safe-life items, 252-257
 267-273
 characteristics of structural items, 84, 229-238
 external and internal items, 238-239
 functions of basic structure, 229-230
 information requirements, 247-252
 role of scheduled maintenance, 228, 247, 331, 335-337
 see also structural inspection plan
 Structures worksheet, 248-251
 Survival curve, 40-41
 Boeing 727 generator, 309-310
 calculation of average life, 41-42
 Pratt & Whitney JT8D engine, 41, 407
 Systems division, 147, 158
 Systems, age exploration of, 107-108, 192-193, 308-312
 actuator endcap, landing gear, 191-192, 311-312
 analysis of systems items, 166-192
 air-conditioning pack, Douglas DC-10, 164-170
 brake assembly, main landing gear, Douglas DC-10, 178-186
 elevator bearings, flight-control system, Douglas DC-8, 326-327
 fuel pump, Douglas A-4, 170-178
 high-frequency communications subsystem, Boeing 747, 186-190
 other typical systems items, 190-192
 characteristics of systems items, 85, 158-161
 information requirements, 161-166
 role of scheduled maintenance, 331, 332-333, 340-341
 Systems worksheets, 149-153, 163-165, 170-171
 TARAN (Test and Replace as Necessary) program, 384
 Task, job instruction card, 309
 level of detail, 352, 359, 367
 see also maintenance tasks
 Task intervals, 192-193, 324-325
 economic-life limits, 60-61
 failure-finding inspections, 61, 62-63, 169, 191, 312, 361
 on-condition inspections, 52-53, 107, 192, 245-247, 317-321, 324-325
 rework tasks, 58, 100-103, 193, 224-225, 359, 363
 role of age exploration, 121-123, 192-193, 224-226, 314-325
 safe-life limits, 58-60, 117, 193, 210, 235, 255, 311-312, 324, 326-327, 359-360
 servicing and lubrication tasks, 72-73, 283
 see also packaging of maintenance tasks
 Teardown inspections, 6, 66, 305, 372-375
 Technological change, 9-11, 115, 126-128
 Technologically useful life, 10, 131, 156
 see also geriatric aircraft
 TERP (Turbine Engine Reliability Program), 381, 382
 TETCP (Turbine Engine Time Control Program), 378, 381
 Test data, 147, 199, 239
 fatigue and crack-propagation tests, 232, 234-235, 239, 243, 248, 256-257, 273
 safe-life items, 59, 234-235, 248
 Test and Replace as Necessary program (TARAN), 384
 Threshold limits, 225, 226, 314, 364

Time-extension samples, 121, 296, 307, 378
Tires, blowout as secondary damage, 182
 tread wear as potential failure, 31-33
Training of program-development team, 146,
 353-354
Troubleshooting methods, 23
Turbine blades, 23, 26, 71
Turbine engine, *see* powerplants
Turbine Engine Reliability Program (TERP),
 381, 382
Turbine Engine Time Control Program (TETCP),
 378, 381

Ultimate load, 231
Unanticipated failures, 112, 115, 116-121, 135-136,
 307-327
Undetected failures, *see* hidden-failure
 consequences
Unscheduled removals, *see* premature removals
Unverified failures, 23

Verified failures, 22-24, 125-126, 299

Walkaround inspections, 73, 282
Wearout characteristics, 43-44, 47
Weibull distribution, 415
Working groups, *see* program-development
 team
Worksheets, decision, 152-153
 information, 150-151, 250-251
Wright Aeronautical R-3350 TC-18 engine,
 age-reliability relationship, 374-375

x-ray inspections, 238

Zonal inspections, 73, 277-281
 rating factors, for inspection intervals, 280-281
Zone numbering systems, 248, 277
 Boeing 747, 279
 McDonnell F4J, 278

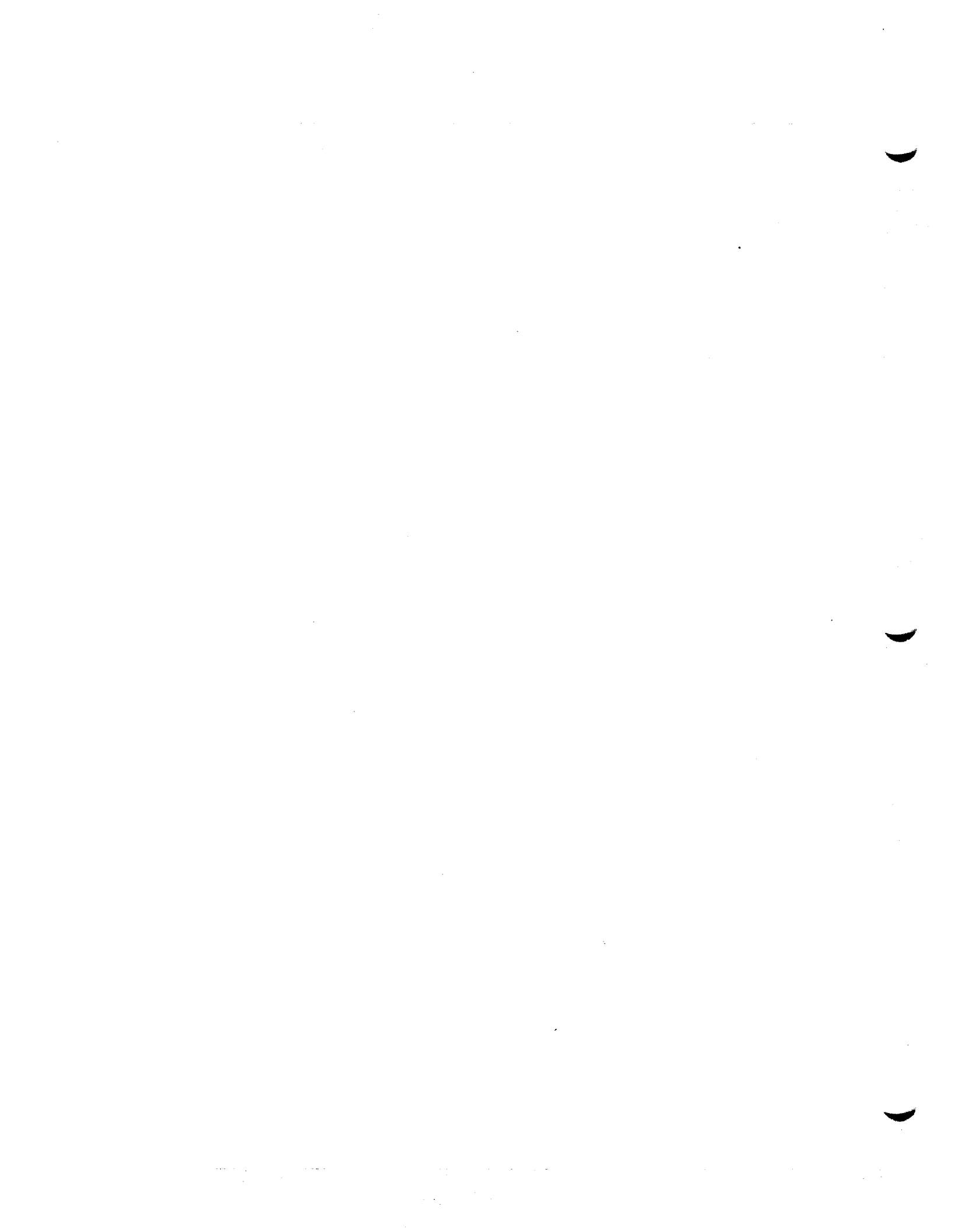

executive summary

**reliability-centered
maintenance**

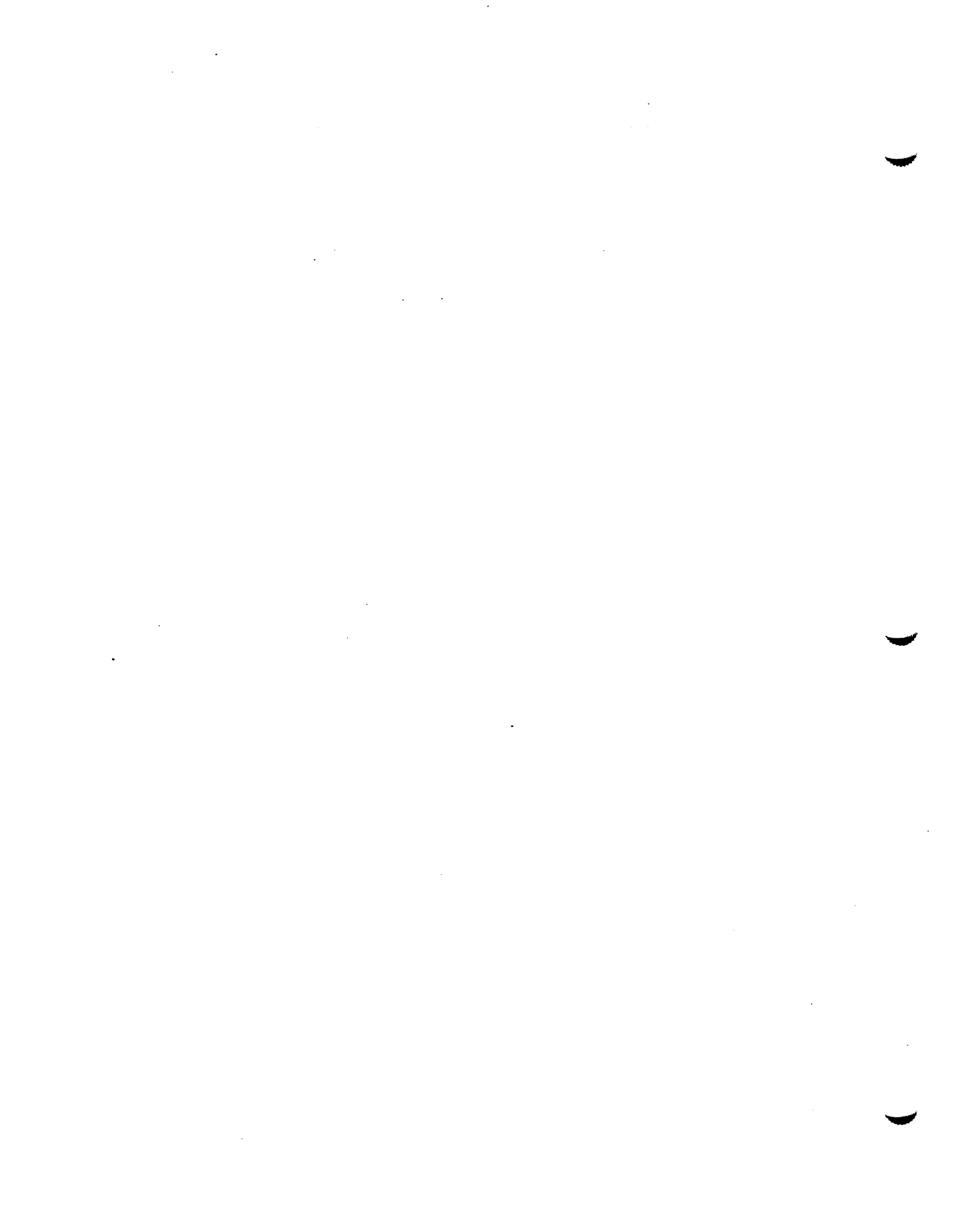

EXECUTIVE SUMMARY

reliability-centered maintenance

This executive summary provides an introductory overview of the book *Reliability-Centered Maintenance*. The following discussion is greatly condensed and is intended only as a brief orientation to the general subject matter. Those interested in a more comprehensive understanding of specific points are referred to the book for a thorough and detailed development of the topic.

reliability-centered maintenance

In 1974 the Office of the Secretary of Defense, U.S. Department of Defense, directed the military services to incorporate United States commercial airline practices into maintenance programs for military equipment. This directive has been reaffirmed each year. Thus far, however, efforts to implement it have been hampered by the absence of explanatory material. The brief working papers which served as the basis for airline maintenance programs were originally written for a small group of readers with extensive backgrounds in airline maintenance, engineering, and reliability analysis, and the detailed clarification necessary for those in other fields to understand airline practices was found to be unavailable in the published literature. To provide this information, the Department of Defense commissioned United Airlines to prepare a textbook that fully explains a logical discipline, based on tested and proven airline practices, which can be used to develop effective scheduled-maintenance programs for complex equipment. The resulting book is titled *Reliability-Centered Maintenance*, and it represents the present state of the art in the field of preventive maintenance.

► THE TRADITIONAL APPROACH TO PREVENTIVE MAINTENANCE

The traditional approach to scheduled-maintenance programs was based on the concept that every item on a piece of complex equipment has a "right age" at which complete overhaul is necessary to ensure safety and operating reliability. Through the years, however, it was discovered that many types of failures could not be prevented or effectively reduced by such maintenance activities, no matter how intensively they were performed. In response to this problem airplane designers began to develop design features that mitigated failure consequences—that is, they learned how to design airplanes that were "failure-tolerant." Practices such as the replication of system functions, the use of multiple

engines, and the design of damage-tolerant structures greatly weakened the relationship between safety and reliability, although this relationship has not been eliminated altogether.

Nevertheless, there was still a question concerning the relationship of preventive maintenance to reliability. By the late 1950s the size of the commercial airline fleet had grown to the point at which there were ample data for study, and the cost of maintenance activities had become sufficiently high to warrant a searching look at the actual results of existing practices. At the same time the Federal Aviation Agency, which was responsible for regulating airline maintenance practices, was frustrated by experiences showing that it was not possible to control the failure rate of certain unreliable types of engines by any feasible changes in either the content or frequency of scheduled overhauls. As a result, in 1960 a task force was formed, consisting of representatives from both the FAA and the airlines, to investigate the capabilities of preventive maintenance.

The work of this group led to the establishment of the *FAA/Industry Reliability Program*, described in the introduction to the authorizing document as follows:¹

The development of this program is towards the control of reliability through an analysis of the factors that affect reliability and provide a system of actions to improve low reliability levels when they exist. In the past, a great deal of emphasis has been placed on the control of overhaul periods to provide a satisfactory level of reliability. After careful study, the Committee is convinced that reliability and overhaul time are not necessarily directly associated topics; therefore, these subjects are dealt with separately.

This approach was a direct challenge to the traditional concept that the length of time between successive overhauls of an item was an important factor in controlling its failure rate. The task force developed a propulsion-system reliability program, and each airline involved in the task force was then authorized to develop and implement reliability programs in the area of maintenance in which it was most interested. During this process a great deal was learned about the conditions that must exist for scheduled maintenance to be effective. Two discoveries were especially surprising:

- ▶ Scheduled overhaul has little effect on the overall reliability of a complex item unless the item has a dominant failure mode.
- ▶ There are many items for which there is no effective form of scheduled maintenance.

► THE HISTORY OF RCM ANALYSIS

The next step was an attempt to organize what had been learned from the various reliability programs and develop a logical and generally applicable approach to the design of preventive-maintenance programs. A rudimentary decision-diagram technique was devised in 1965, and in June 1967 a paper on its use was presented at the AIAA Commercial Aircraft Design and Operations Meeting.² Subsequent refinements of this technique were embodied in a handbook on maintenance evaluation and program development, drafted by the maintenance steering group formed to oversee development of the initial program for the new Boeing 747 airplane.³ This document, known as MSG-1, was used by special teams of industry and FAA personnel to develop the first scheduled-maintenance program based on the principles of reliability-centered maintenance. The Boeing 747 maintenance program has been successful.

Use of the decision-diagram technique led to further improvements, which were incorporated two years later in a second document, *MSG-2: Airline/Manufacturer Maintenance Program Planning Document*.⁴ MSG-2 was used to develop the scheduled-maintenance programs for the Lockheed 1011 and the Douglas DC-10 airplanes. These programs have also been successful. MSG-2 has also been applied to tactical military aircraft; the first applications were for aircraft such as the Lockheed S-3 and P-3 and the McDonnell F4J. A similar document prepared in Europe was the basis for the initial programs for such recent aircraft as the Airbus Industrie A-300 and the Concorde.

The objective of the techniques outlined in MSG-1 and MSG-2 was to develop a scheduled-maintenance program that assured the maximum safety and reliability of which the equipment was capable and also provided them at the lowest cost. As an example of the economic benefits achieved with this approach, under traditional maintenance policies the initial program for the Douglas DC-8 airplane required scheduled overhaul for 339 items, in contrast to seven such items in the DC-10 program. One of the items no longer subject to overhaul limits in the later programs was the turbine propulsion engine. Elimination of scheduled overhauls for engines not only led to major reductions in labor and materials costs, but also reduced the spare-engine inventory required to cover shop maintenance by more than 50 percent. Since engines for larger airplanes now cost more than \$1 million each, this is a respectable saving.

As another example, under the MSG-1 program for the Boeing 747 United Airlines expended only 66,000 manhours on major structural

inspections before reaching a basic interval of 20,000 hours for the first heavy inspections of this airplane. Under traditional maintenance policies it took an expenditure of more than 4 million manhours to arrive at the same structural inspection interval for the smaller and less complex Douglas DC-8. Cost reductions of this magnitude are of obvious importance to any organization responsible for maintaining large fleets of complex equipment. More important:

- ▶ Such cost reductions are achieved with no decrease in reliability. On the contrary, a better understanding of the failure process in complex equipment has actually improved reliability by making it possible to direct preventive tasks at specific evidence of potential failures.

Although the MSG-1 and MSG-2 documents revolutionized the procedures followed in developing maintenance programs for transport aircraft, their application to other types of equipment was limited by their brevity and specialized focus. In addition, the formulation of certain concepts was incomplete. For example, the decision logic began with an evaluation of proposed tasks, rather than an evaluation of the failure consequences that determine whether they are needed, and if so, their actual purpose. The problem of establishing task intervals was not addressed, the role of hidden-function failures was unclear, and the treatment of structural maintenance was inadequate. There was also no guidance on the use of operating information to refine or modify the initial program after the equipment entered service or the information systems needed for effective management of the ongoing program. All these shortcomings, as well as the need to clarify many of the underlying principles, led to analytic procedures of broader scope and crystallization of the logical discipline now known as *reliability-centered maintenance*.

▶ BASIC CONCEPTS OF RELIABILITY-CENTERED MAINTENANCE

A reliability-centered maintenance (RCM) program consists of a set of scheduled tasks generated on the basis of specific reliability characteristics of the equipment they are designed to protect. Complex equipment is composed of a vast number of parts and assemblies. All these items can be expected to fail at one time or another, but some of the failures have more serious consequences than others. Certain kinds of failures have a direct effect on operating safety, and others affect the operational

capability of the equipment. The consequences of a particular failure depend on the design of the item and the equipment in which it is installed. Although the environment in which the equipment is operated is sometimes an additional factor, the impact of failures on the equipment, and hence their consequences for the operating organization, are established primarily by the equipment designer. Failure consequences are therefore a primary inherent reliability characteristic.

There are a great many items, of course, whose failure has no significance at the equipment level. These failures are tolerable, in the sense that the cost of preventive maintenance would outweigh the benefits to be derived from it. It is less expensive to leave these items in service until they fail than it is to try to prevent the failures. Most such failures are evident to the operating crew at the time they occur and are reported to the maintenance crew for corrective action. Some items, however, have functions whose failure will not be evident to the operating crew. Although the loss of a hidden function has no direct consequences, any uncorrected failure exposes the equipment to the consequences of a possible multiple failure as a result of some later second failure. For this reason items with hidden functions require special treatment in a scheduled-maintenance program.

The first step in the development of a maintenance program is to reduce the problem of analysis to manageable size by a quick, approximate, but conservative identification of a set of *significant items*—those items whose failure could affect operating safety or have major economic consequences. The definition of major economic consequences will vary from one operating organization to another, but in most cases it includes any failure that impairs the operational capability of the equipment or results in unusually high repair costs. At the same time all items with hidden functions must be identified, since they will be subjected to detailed analysis along with the significant items.

The analysis itself begins with an evaluation of the failure consequences for each type of failure to which the item is exposed. The logic used to organize this problem, shown in Exhibit 1, leads to four categories of failure consequences:

- ▶ Safety consequences, which involve possible danger to the equipment and its occupants
- ▶ Operational consequences, which involve an indirect economic loss in addition to the cost of repair
- ▶ Nonoperational consequences, which involve no economic loss other than the cost of repair

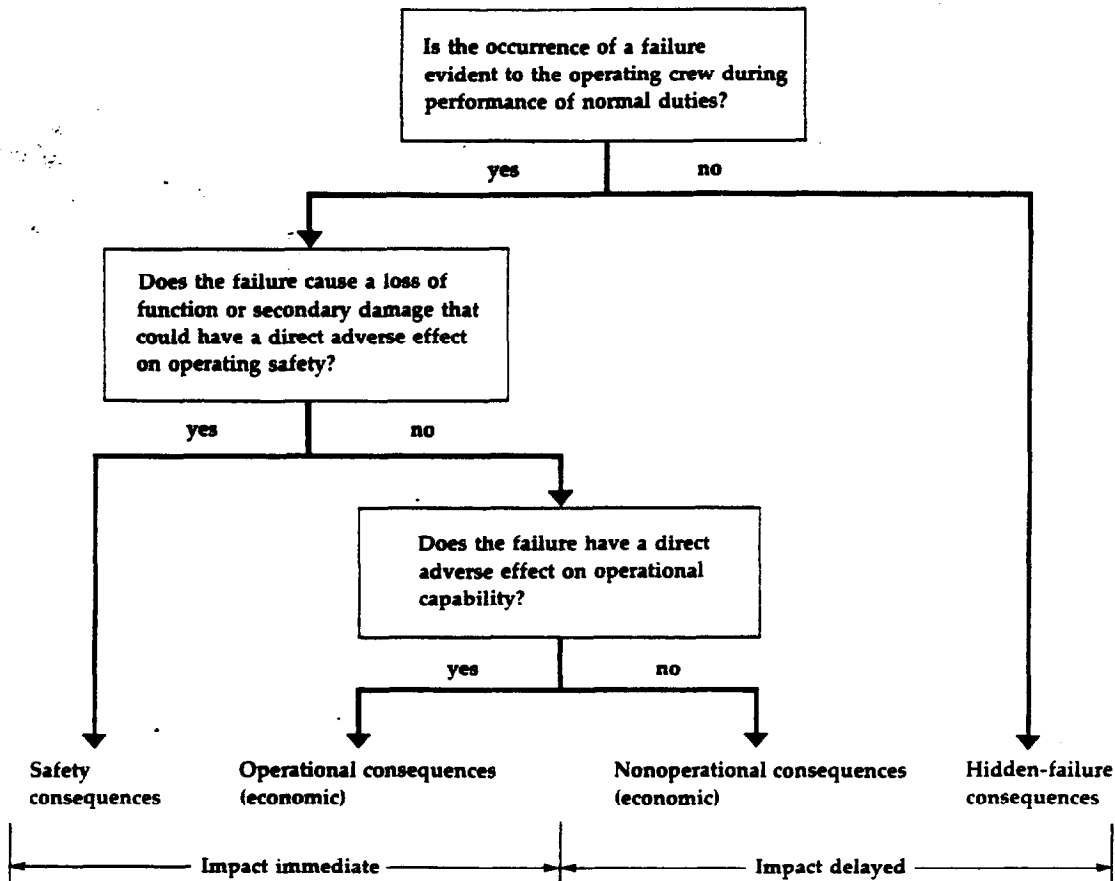

EXHIBIT 1 Decision diagram to identify significant items and hidden functions on the basis of failure consequences. Failures that affect safety or operating capability have an immediate impact, since the equipment cannot be dispatched until they have been corrected. The impact of nonoperational failures and hidden failures is delayed in the sense that correction can be deferred to a convenient time and location.

- ▶ **Hidden-failure consequences, which involve exposure of the equipment to a multiple failure as the result of a later failure of some other item**

If the failure is one that could have a direct effect on operating safety, either through loss of an essential function or as a result of critical secondary damage, all maintenance work that is likely to prevent such fail-

ures is required, and if maintenance does not have the capability to reduce the risk of failure to an acceptable level, the item must be redesigned. If the failure is one that will not be evident to the operating crew, and therefore reported and corrected, scheduled maintenance is also required, to ensure adequate availability of the hidden function. In all other cases the consequences of failure are economic, and the desirability of preventive maintenance can be evaluated only in economic terms. (One notable exception is the case of certain military equipment failures that might additionally include consideration of a critical strategic or tactical impact which may be difficult to quantify solely in economic terms.) For failures that do not involve safety, then, the criterion of maintenance effectiveness is cost effectiveness; the cost of preventive tasks must be less than the cost of the failures they prevent.

► SELECTION OF MAINTENANCE TASKS

There are only four basic types of preventive-maintenance tasks, each of which is applicable under a specific set of conditions:

- Inspection of an item at specified intervals to find and correct potential failures, thereby preempting functional failures
- Rework (overhaul) of an item at or before some specified operating age to reduce the frequency of functional failures
- Discard of an item or one of its parts at or before some specified life limit to avoid functional failures or reduce their frequency
- Inspection of a hidden-function item at specified intervals to find and correct functional failures that have already occurred but were not evident to the operating crew

The first three types of tasks are directed at preventing single failures, and the fourth is directed at preventing multiple failures. Inspection tasks can generally be performed without removing the item from the equipment, whereas rework and discard tasks generally require that the item be removed and sent to a major maintenance base.

The development of an RCM program consists of determining which of these four types of tasks, if any, are both applicable and effective for a given item. Thus an inspection for potential failures can be applicable only if the item has reliability characteristics that make it possible to define a potential-failure condition. Similarly, an age-limit task can be applicable only if the failures at which it is directed are related to operating age. Effectiveness is a measure of the results of the task; the cri-

terion for these results, however, depends on the failure consequences the task is designed to prevent. For example, a proposed task might appear useful if it promises to reduce the overall failure rate, but it could not be considered effective if the failures have safety consequences, since the objective in this case is to prevent all occurrences of a functional failure. The characteristics of the basic tasks, their relative resolving power, and the specific applicability criteria for each one are described in detail in the text *Reliability-Centered Maintenance*. All these factors result in a clear order of task preference, making it possible to evaluate proposed tasks by means of the decision logic shown in Exhibit 2.

EXHIBIT 2 Decision diagram to evaluate proposed scheduled-maintenance tasks. If none of the three directly preventive tasks meets the criteria for applicability and effectiveness, an item whose failures are evident cannot be considered to benefit from scheduled maintenance. If the item has a hidden function, the default action is a scheduled failure-finding task.

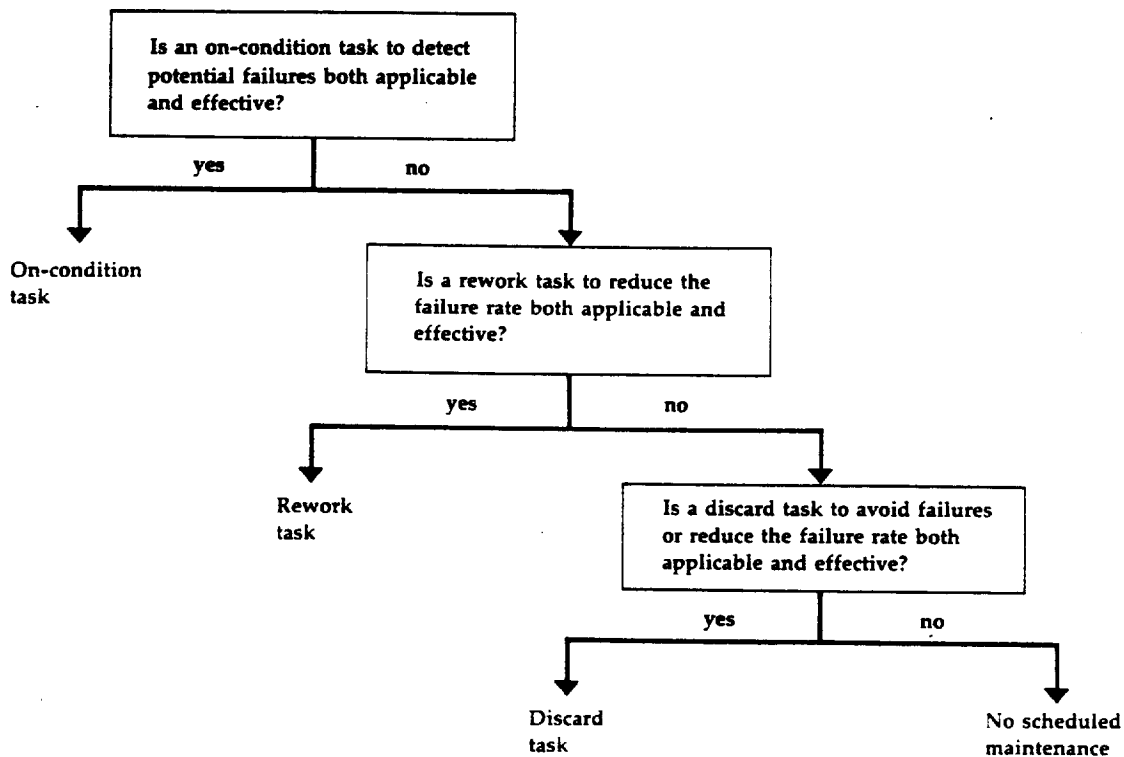

490

► TASK INTERVALS: AN INFORMATION PROBLEM

With the techniques of RCM analysis it is fairly simple to decide what tasks to include in a scheduled-maintenance program, but the decision logic does not cover the intervals at which these tasks are to be performed. Intervals for safe-life discard tasks are established by the manufacturer on the basis of developmental testing and are usually not expected to change. The applicability of other age-limit tasks must be determined through age exploration after the equipment enters service; hence their intervals can be based at that time on actual operating information. The most effective tool in a scheduled-maintenance program, however, is on-condition inspection for potential failures, and in this case there is usually not enough information to set minimum-cost intervals even after the equipment is in service and age exploration is under way.

At the time an initial program is developed, the available information is usually limited to prior experience with similar items, familiarity with the manufacturer's design practices, and the results of developmental and fatigue tests for the new equipment. With this information it is possible to arrive at rough estimates of the ages at which deterioration can be expected to become evident. However, the inspection intervals in an initial program are then set at only a fraction of these ages. The fraction may be quite a small one, to force intensive exploration of aging characteristics, if the manufacturer is relatively inexperienced, if new materials or manufacturing methods have been used, or if the equipment is to be operated in an unfamiliar environment. While this initial conservatism increases the cost of inspection on the first pieces of equipment to enter service, the overall economic impact is small, since the intent is to increase the intervals on the basis of the inspection findings as the new fleet grows in size.

The principle of on-condition inspections is that the time to the first inspection should be long enough for the first evidence of deterioration to be visible, and the intervals for repeat inspections should be short enough to ensure that any unit that has reached the potential-failure stage will be removed from service before a functional failure occurs. In theory, then, the problem of establishing optimum intervals should merely be one of using age exploration to identify the actual rate of deterioration and potential-failure age of each item. Often, however, once this age is identified, it will be judged undesirably low and the item will be redesigned to increase its longevity. Consequently the

“correct” inspection interval for any item may apply only from the time its original reliability characteristics are determined until the time the modified item goes into service. While the dynamics of this process add new age-exploration requirements throughout the life of the equipment, they also reduce the growth in the maintenance workload that is associated with older equipment.

► THE DESIGN-MAINTENANCE PARTNERSHIP

As a result of continuing interaction between design and maintenance organizations, the future will see airplanes and other complex equipment that can be more effectively maintained and achieve still higher levels of safety and reliability. On one hand, the design organization determines the inherent characteristics of the equipment, including the consequences of functional failures and the feasibility and cost of preventing them. On the other hand, the maintenance organization attempts to realize all the safety and reliability of which the equipment is capable. Achievement of this goal, however, requires a joint effort which has not always been recognized. Designers have not always understood both the capabilities and the limitations of scheduled maintenance; by the same token, maintenance organizations have not always had a clear grasp of the design goals for the equipment they maintain. The need for a close partnership has always existed, but the comprehensive analysis required by RCM techniques makes this need far more apparent.

During the development of a prior-to-service program the identification of functionally and structurally significant items and hidden functions depends on the designer's information on failure effects as well as the operator's knowledge of their consequences. At this stage the information on anticipated failure modes must also come from the designer. In general, on-condition inspections are the principal maintenance weapon against functional failures. However, it must be possible to use them, preferably without removing items from the equipment. Thus the designer must not only help to define the physical evidence that makes such inspections applicable, but must also be sure there is some access to the item to be inspected.

Once the equipment enters service there will be a continual flow of information on the condition and performance of each item under actual operating conditions. This information is needed not only to refine and modify the maintenance program, but also to initiate product improvement for those items whose reliability proves to be inadequate. One of the basic functions of the operator's age-exploration program is

492

to provide the designer with the hardware information necessary for product improvement. Certain items on newly designed equipment frequently have a very high failure rate when they first enter service, and this interaction between design and maintenance should be part of the normal development cycle for all complex equipment.

The designer's help is of more immediate importance in dealing with serious unanticipated failures. In this case the designer must help the maintenance organization to devise interim maintenance tasks that will control the problem until design changes have been developed and incorporated in the operating fleet. The two organizations must work together to identify the failure mechanism, because this information is required for the development of interim tasks as well as for ultimate solution of the problem by redesign.

- ▶ Thus the key both to effective maintenance and to greater inherent reliability is a continuing close partnership, with both design and maintenance organizations familiar with and sympathetic to each other's problems, goals, and capabilities.

▶ EXPANSION OF RCM APPLICATIONS

The widespread and successful application of RCM principles in the air-transport industry has important implications for many types of complex equipment other than aircraft. Many of the current problems with rapid-transit equipment, fleets of ships and ground vehicles, and even machinery used in complex manufacturing processes indicate that the relationship between design and maintenance is not clearly understood. In many instances, however, operating organizations themselves have not considered the real capabilities and limitations of scheduled maintenance and have been frustrated by their inability to solve the problems of safety and operational disruptions caused by failures. While no form of preventive maintenance can overcome reliability problems that are inherent in the design of the equipment, RCM analysis does provide a means of identifying the specific maintenance tasks and product improvements that will alleviate such problems.

In general, any maintenance support program based on RCM principles has the following objectives:

- ▶ To ensure realization of the inherent safety and reliability levels of the equipment
- ▶ To restore the equipment to these inherent levels when deterioration occurs

- ▶ To obtain the information necessary for design improvement of those items whose inherent reliability proves inadequate
- ▶ To accomplish these goals at a minimum total cost, including maintenance costs, support costs, and the economic consequences of operational failures

One obstacle to all these objectives is the tendency to rely on traditional concepts of scheduled maintenance, especially the belief that scheduled overhauls are universally applicable to complex equipment. Thus an operating organization must recognize the following facts before it is prepared to develop and implement a detailed RCM program for its equipment:

- ▶ The design features of the equipment establish the consequences of any functional failure, as well as the cost of preventing it.
- ▶ Redundancy is a powerful design tool for reducing safety consequences to economic consequences by preventing a complete loss of function to the equipment.
- ▶ Scheduled maintenance can prevent or reduce the frequency of functional failures of an item, but it cannot alter their consequences.
- ▶ Scheduled maintenance can ensure that the inherent reliability of each item is realized, but it cannot alter the characteristics of the item.
- ▶ There is no "right time" for scheduled overhauls that will solve reliability problems in complex equipment.
- ▶ On-condition inspections, which make it possible to preempt functional failures by potential failures, are the most effective tool of preventive maintenance.
- ▶ A scheduled-maintenance program must be dynamic; any prior-to-service program is based on limited information, and an operating organization must be prepared to collect and respond to real data throughout the service life of the equipment.
- ▶ Product improvement is a normal part of the development cycle for all new equipment.

Once an operating organization is comfortable with these facts, it is ready to proceed confidently with the detailed development of an RCM program. The resulting program will include all the scheduled tasks necessary or desirable to protect the equipment, and because it

includes only the tasks that will accomplish this goal, this program can provide major economic benefits. More important, by directing both scheduled tasks and intensive age exploration at those items which are truly significant at the equipment level, the ultimate result will be equipment with a degree of inherent reliability that is consistent with the state of the art and the capabilities of maintenance technology.

► CONCLUDING REMARKS

The book *Reliability-Centered Maintenance* is the first full discussion of a decision-diagram technique that applies a straightforward logic to the development of scheduled-maintenance programs for complex equipment. The net result of this analytic tool is a structured, systematic blend of experience, judgment, and specific information to determine which maintenance tasks, if any, are both applicable and effective for those items whose failure has significant consequences for the equipment in which they are installed. Part One of the book explains the basic concepts and principles underlying RCM theory, and Part Two illustrates actual hardware analyses, with examples drawn from aircraft systems, powerplants, and structures. The problem of packaging maintenance tasks for implementation, the information systems needed for effective management of the ongoing program, and the uses of operating data as part of a continuing dynamic process are also addressed in detail.

► REFERENCES

- 1 *FAA/Industry Reliability Program*. Federal Aviation Agency, November 7, 1961, p. 1.
- 2 T. D. Matteson and F. S. Nowlan, Current Trends in Airline Maintenance Programs, AIAA Commercial Aircraft Design and Operations Meeting, Los Angeles, Calif., June 12-14, 1967.
- 3 *Handbook: Maintenance Evaluation and Program Development (MSG-1)*, 747 Maintenance Steering Group, Air Transport Association, Washington, D.C., July 10, 1968.
- 4 *Airline/Manufacturer Maintenance Program Planning Document: MSG-2*, Air Transport Association R & M Subcommittee, Washington, D.C., March 25, 1970.

