



# Bearing Installation and Maintenance Guide





# Bearing Installation and Maintenance Guide

## Highlights of the new edition of the SKF Bearing Installation and Maintenance Guide.

- The mounting and dismounting section has been expanded to include:
  - Individual step-by-step instructions for mounting self-aligning ball bearings, spherical roller bearings, and CARB®. This expansion will allow the book to be used as a guide during actual mounting of bearings rather than just a reference.
  - Assembly, mounting and dismounting instructions for split pillow block housings, unit ball housings, and unit roller housings.
- The shaft and housing fit tables have been updated to include stainless steel bearings and reflect slightly different fit recommendations based on bearing size and style. These changes are the result of SKF's profound knowledge of our products and vast experience with OEM and end user customers.
- The lubrication section now includes the latest viscosity requirement guidelines as well as more specific guidelines for grease relubrication.
- The troubleshooting section is now more user-friendly.
- The bearing failure section now reflects the new ISO terminology and structure for bearing failures. It also features failure analysis service provided by SKF.

# Table of contents

<b>Bearing types</b> .....	<b>3</b>
<b>Bearing terminology</b> .....	<b>9</b>
<b>Mounting and dismounting of bearings</b> .....	<b>11</b>
General information.....	11
Bearing care prior to mounting .....	11
Where to mount .....	11
Preparations for mounting and dismounting.....	11
Bearing handling .....	12
Fitting practice .....	12
Internal bearing clearance .....	12
Mounting.....	13
Mounting bearings with cylindrical (straight) bore.....	13
Cold Mounting.....	13
Temperature (hot) mounting .....	14
Heating the bearing .....	14
Heating the housing.....	14
Mounting bearings with tapered bore.....	14
Mounting tapered bore double row self-aligning ball bearings.....	15
Angular drive-up method .....	15
Mounting tapered bore spherical roller bearings.....	18
Radial clearance reduction method on adapter sleeves.....	18
Radial clearance reduction method on solid tapered shaft.....	21
Angular drive-up method on adapter sleeves.....	22
SKF hydraulic mounting method on adapter sleeves.....	24
Mounting of CARB <sup>®</sup> toroidal roller bearings .....	29
Radial clearance reduction method on adapter sleeves.....	29
Radial clearance reduction method on solid tapered shaft.....	32
Angular drive-up method on adapter sleeves .....	33
SKF hydraulic mounting method on adapter sleeves.....	35
Assembly instructions for pillow block housings, SAF and SAFS .....	38
Shaft tolerances.....	38
Seals .....	38
Grease charge .....	39
Cap bolt tightening torques.....	38
Misalignment limits .....	40
Mounting instructions for collar mounted roller unit pillow blocks and flanged housings.....	41
Mounting and dismounting instructions for Concentra mount roller unit pillow blocks and flanged housings .....	42
Mounting and dismounting instructions for ball unit pillow blocks and flanged housings.....	44
Mounting and dismounting instructions for Concentra ball unit pillow blocks and flanged housings.....	46
Test running.....	47
Dismounting methods.....	48
Can the bearing be used again? .....	48

## Table of contents (cont.)

<b>Shaft and housing fits</b> .....	<b>51</b>
Purpose of proper fits.....	51
Selection of fit.....	51
Shaft fit selection tables.....	54
Housing fit selection tables.....	56
Shaft tolerance limits for adapter mounting and pillow block seal seatings .....	57
Fits for hollow shafts .....	57
Fit tolerance tables.....	58-79
ISO tolerance grade limits .....	80
Shaft tolerances for bearings mounted on metric sleeves.....	80
Guidelines for surface roughness .....	80
Accuracy of form and position .....	81
Shaft and housing tolerance tables for inch size taper roller bearings .....	82
Shaft and housing tolerances for metric and J-prefix inch series taper roller bearings .....	83
Shaft and housing tolerances for Precision ABEC-5 deep groove ball bearings .....	85
<b>Lubrication</b> .....	<b>87</b>
Functions of a lubricant .....	87
Selection of oil.....	88
Viscosity Equivalents Chart.....	90
Methods of oil lubrication .....	91
Grease lubrication .....	93
Grease relubrication .....	95
Relubrication intervals.....	95
Relubrication interval adjustments.....	96
Grease relubrication procedures.....	98
SKF solid oil .....	100
SKF lubrication systems (VOGEL).....	101
<b>Troubleshooting</b> .....	<b>103</b>
Common bearing symptoms .....	104
Trouble conditions and their solutions.....	107
<b>Bearing damages and their causes</b> .....	<b>117</b>
Damage mode classification .....	118
Definitions .....	119
Loading patterns for bearings.....	120
Pre-operational damage mode causes .....	122
Operational damage mode causes.....	128
SKF failure analysis service .....	133
<b>Additional resources</b> .....	<b>135</b>
Maintenance and lubrication products .....	135
Reliability Maintenance Institute .....	136
Reliability and services .....	138
The Asset Efficiency Optimization™ (AEO) concept .....	138
SKF technology and service solutions .....	138

# Bearing types

Each type of bearing has characteristic properties which make it particularly suitable for certain applications. The main factors to be considered when selecting the correct type are:

- Available space
- Magnitude and direction of load (radial, axial, or combined)
- Speed
- Misalignment
- Mounting and dismounting procedures
- Precision required
- Noise factor
- Internal clearance
- Materials and cage design
- Bearing arrangement
- Seals

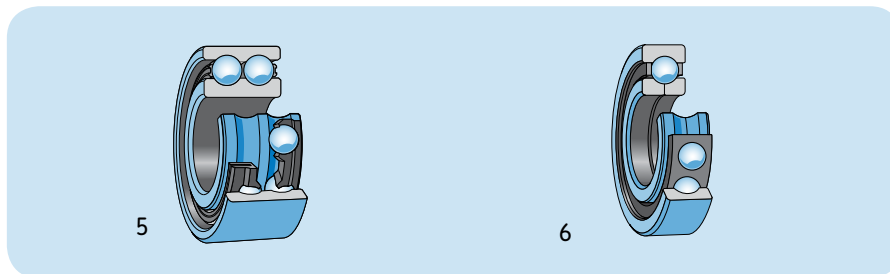
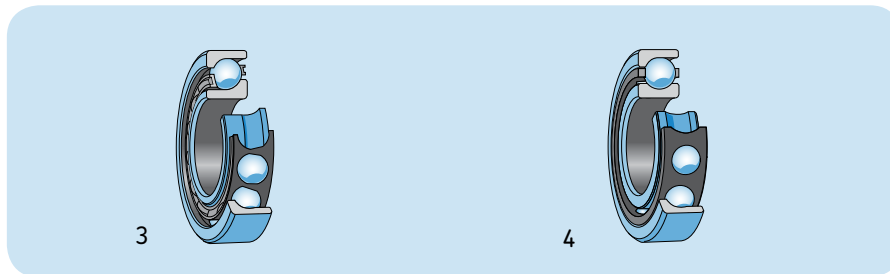
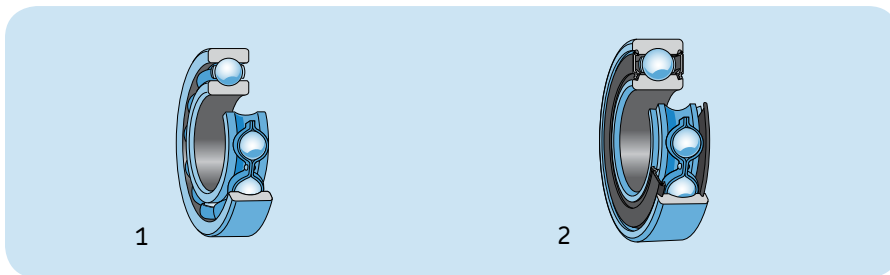

## Radial bearings

### Deep groove ball bearings

single row, with or without filling slots  
 open basic design (1)  
 with shields  
 with contact seals (2)  
 with a snap ring groove, with or without a snap ring

### Angular contact ball bearings

single row  
 basic design for single mounting  
 design for universal matching (3)  
 single row high-precision  
 basic design for single mounting (4)  
 design for universal matching  
 matched bearing sets

### double row

with a one-piece inner ring (5)  
 open basic design  
 with shields  
 with contact seals  
 with a two-piece inner ring  
 Four-point contact ball bearing (6)

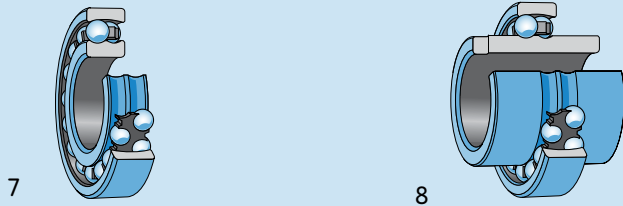

**Radial bearings**

**Self-aligning ball bearings**

- with a cylindrical or tapered bore
- open basic design (7)
- with contact seals
- with an extended inner ring (8)

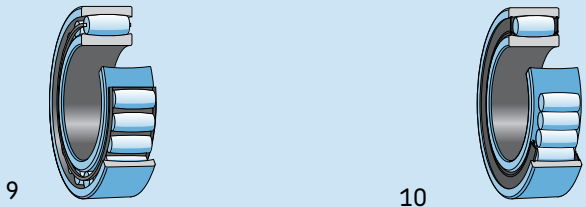

**CARB® toroidal roller bearings**

- with a cylindrical or tapered bore
- open basic designs
- with a cage-guided roller set (9)
- with a full complement roller set
- with contact seals (10)

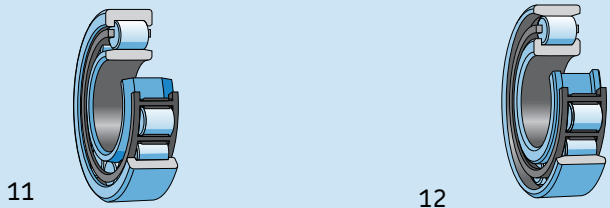

**Cylindrical roller bearings**

- single row
- NU type (11)
- N type (12)

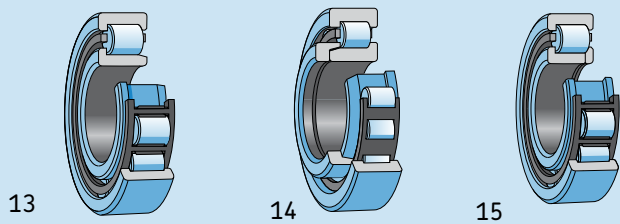

- NJ type (13)
- NJ type with HJ angle ring (14)
- NUP type (15)

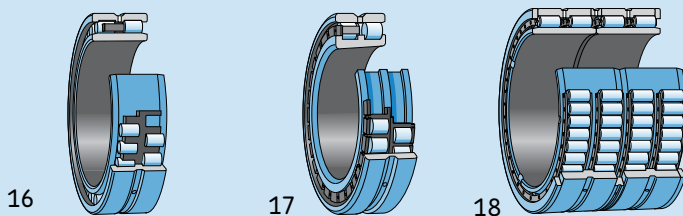

- double row, cylindrical or tapered bore
- NNU type (16)
- NN type (17)
- four-row
- with cylindrical (18) or tapered bore



**Full complement cylindrical roller bearings**

- single row
- NCF design (19)
- double row
- with integral flanges on the inner ring
- with integral flanges on the inner and outer rings
- with contact seals (20)



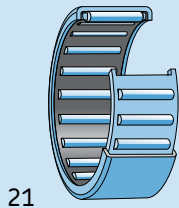

21

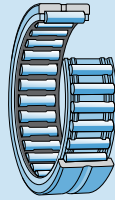

22

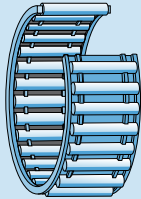

23

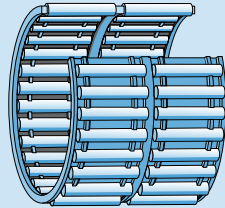

24

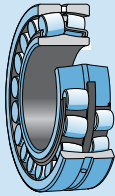

25



26

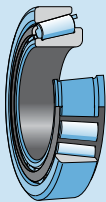

27

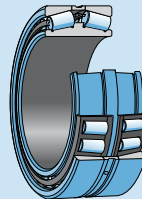

28

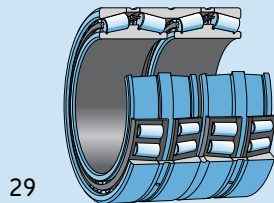

29

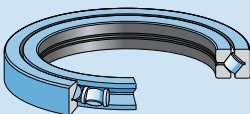

30

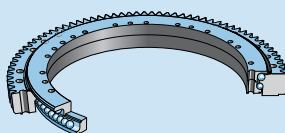

31

## Radial bearings

### Needle roller bearings

- drawn cup needle roller bearings
  - open basic design (21)
  - with contact seals
- needle roller bearings with flanges
  - without an inner ring (22)
  - with an inner ring
    - open basic design
    - with contact seals

### Needle roller and cage assemblies

- single row (23)
- double row (24)

### Spherical roller bearings

- with cylindrical or tapered bore
  - open design (25)
  - with contact seals (26)

### Taper roller bearings

- single row (27)
- double row, matched sets (28)
  - TDO (back-to-back)
  - TDI (face-to-face)

### four row (29)

- TQO configuration
- TQI configuration

### Cross taper roller bearings (29)

- Slewing bearings (31)
- with or without gears

32

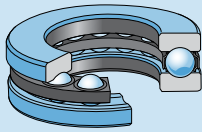

33

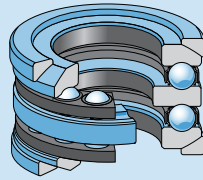

34

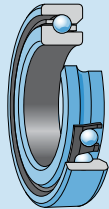

35

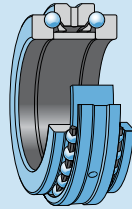

36

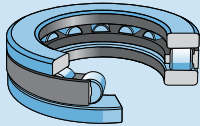

37

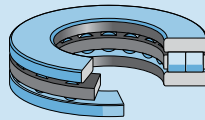

38

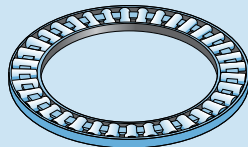

39

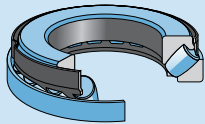

40

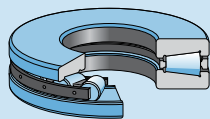

41

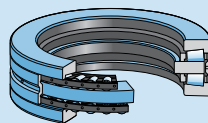

## Thrust bearings

### Thrust ball bearings

single direction

with flat housing washer (32)

with sphered housing washer and

seating washer

double direction

with flat housing washers

with sphered housing washers and

seating rings (33)

without seating rings

### Angular contact thrust ball bearings

high-precision bearings

single direction

basic design for single mounting (34)

design for universal matching

matched bearing sets

double direction

standard design (35)

high speed design

### Cylindrical roller thrust bearings

single direction

single row (36)

double row (37)

components

cylindrical roller and cage thrust

assemblies

shaft and housing washers

### Needle roller thrust bearings

single direction

needle roller and cage thrust assemblies (38)

raceway washers

thrust washers

### Spherical roller thrust bearings

single direction (39)

### Taper roller thrust bearings

single direction

with or without (40) a cover

screw down bearings

double direction (41)

42

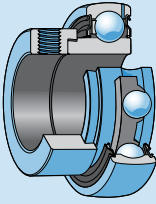

43

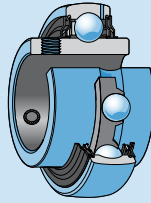

44

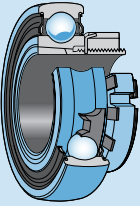

45

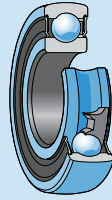

46

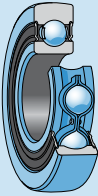

47



48

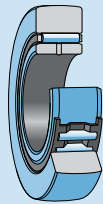

49

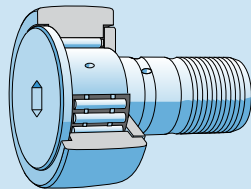

## Y-bearings

### Y-bearings (Insert bearings)

with an eccentric locking collar

inner ring extended on one side (42)

inner ring extended on both sides

with setscrews

inner ring extended on one side

inner ring extended on both sides (43)

with a tapered bore for adapter sleeve mounting (44)

with a standard inner ring

for locating by interference fit on the shaft (45)

## Track runner bearings

### Cam rollers

single row ball bearing cam roller narrow design

with crowned runner surface (46)

double row ball bearing cam roller wide design

with crowned runner surface (47)

with cylindrical runner surface

### Support rollers

without an axial guidance

with crowned or cylindrical runner surface

with or without contact seals

without an inner ring

with an inner ring (48)

### Cam followers

with an axial guidance by thrust plate

with crowned or cylindrical runner surface

with or without contact seals

with a concentric seating (49)

with an eccentric seating collar

with a cage-guided needle roller set

with a full complement needle roller set



# Mounting and dismounting of bearings

## General information

To provide proper bearing performance and prevent premature failure, skill and cleanliness when mounting ball and roller bearings are necessary. As precision components, rolling bearings should be handled carefully when mounting. It is also important to choose the correct method of mounting and to use the correct tools for the job.

See the SKF Bearing Maintenance Tools Catalog (711-639) or [www.mapro.skf.com](http://www.mapro.skf.com).

## Bearing care prior to mounting

Proper care begins in the stock room. Store bearings in their original unopened packages, in a dry place. The bearing number is plainly shown on the box or wrapping. Before packaging, the manufacturer protected the bearing with a rust preventive slush compound. An unopened package means continued protection. The bearings need to be left in their original packages until immediately before mounting so they will not be exposed to any contaminants, especially dirt. Handle the bearing with clean, dry hands and with clean rags. Lay the bearing on clean paper and keep it covered. Never expose the bearing on a dirty bench or floor. Never use a bearing as a gauge to check either the housing bore or the shaft fit.

Don't wash a new bearing — it is already clean.

Normally, the preservative with which new bearings are coated before leaving the factory does not need to be removed; it is only necessary to wipe off the outside cylindrical surface and bore. If, however, the bearing is to be grease lubricated and used at very high or very low temperatures, or if the grease is not compatible with the preservative, it is necessary to wash and carefully dry the bearing. This is to avoid any detrimental effect on the lubricating properties of the

grease. Old grease can be washed from a used bearing with a solvent but the fluid and container must be clean. After this cleaning, wash the bearing out thoroughly with light oil and then relubricate. (See pages 48 and 49).

Bearings should be washed and dried before mounting if there is a risk that they have become contaminated because of improper handling (damaged packaging, etc.). When taken from its original packaging, any bearing that is covered by a relatively thick, greasy layer of preservative should also be washed and dried. This might be the case for some large bearings with an outside diameter larger than 420 mm. Suitable agents for washing rolling bearings include white spirit and paraffin. Bearings that are supplied ready greased and which have integral seals or shields on both sides should not be washed before mounting.

## Where to mount

Bearings should be installed in a dry, dust-free room away from metalworking or other machines producing swarf and dust. When bearings have to be mounted in an unprotected area, which is often the case with large bearings, steps need to be taken to protect the bearing and mounting position from contamination by dust, dirt and moisture until installation has been completed. This can be done by covering or wrapping bearings, machine components etc. with waxed paper or foil.

## Preparations for mounting and dismounting

Before mounting, all the necessary parts, tools, equipment and data need to be at hand. It is also recommended that any drawings or instructions be studied to determine the correct order in which to assemble the various components. Housings, shafts, seals and other components of the bearing arrangement need to be checked to make sure that they are clean, particularly any threaded holes, leads or grooves where remnants of previous machining operations might have collected. The unmachined surfaces of cast housings need to be free of core sand and any burrs need to be removed.

Support the shaft firmly in a clean place; if in a vise, protect it from vise jaws. Protectors can be soft metal, wood, cardboard or paper. The dimensional and form accuracy of all components of the bearing arrangement need to be checked. If a shaft is too worn to properly seat a bearing — don't use it! The bearings will only perform satisfactorily if the associated components have the requisite accuracy and if the prescribed tolerances are adhered to. The diameter of cylindrical shaft and housing seatings are usually checked using a stirrup or internal gauge at two cross-sections and in four directions (**Figure 1**).

Tapered bearing seatings are checked using ring gauges, special taper gauges or sine bars. It is advisable to keep a record of the measurements.

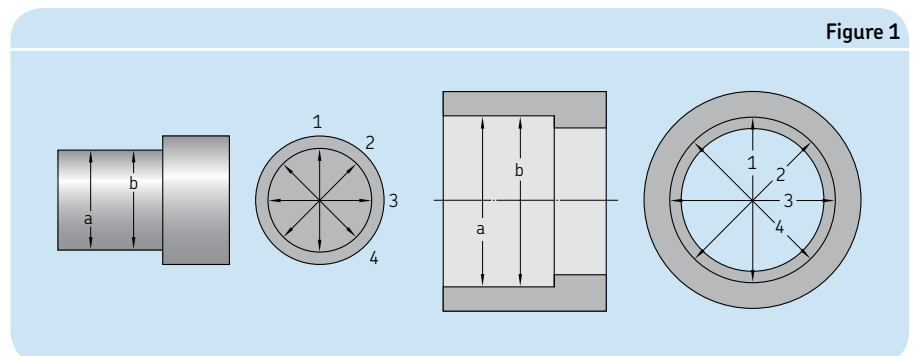

Figure 1

When measuring, it is important that the components being measured and the measuring instruments are approximately the same temperature. This means that it is necessary to leave the components and measuring equipment together in the same place long enough for them to reach the same temperature. This is particularly important where large bearings and their associated components, which are correspondingly large and heavy, are concerned.

## Bearing handling

It is generally a good idea to use gloves as well as carrying and lifting tools, which have been specially designed for mounting and dismounting bearings. This will save not only time and money but the work will also be less tiring and less risky. For these reasons, the use of heat and oil resistant gloves is recommended when handling hot or oily bearings. These gloves should have a durable outside and a soft non-allergenic inside, as for example, SKF TMBA gloves.

Heated and/or larger or heavier bearings often cause problems because they cannot be handled in a safe and efficient manner by one or two persons. Satisfactory arrangements for carrying and lifting these bearings can be made on site in a workshop. The bearing handling tool TMMH from SKF (Figure 2) solves most of the problems and facilitates handling, mounting and dismounting bearings on shafts.



Figure 2

If large, heavy bearings are to be moved or held in position using lifting tackle they should not be suspended at a single point but a steel band or fabric belt should be used (Figure 3). A spring between the hook of the lifting tackle and the belt facilitates positioning the bearing when it is to be pushed onto a shaft.

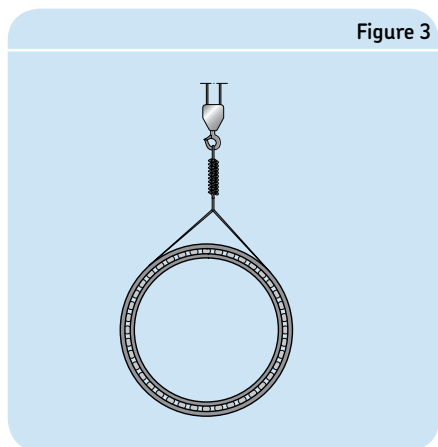

Figure 3

To ease lifting, large bearings can be provided on request with threaded holes in the ring side faces to accommodate eye bolts. The hole size is limited by the ring thickness. It is therefore only permissible to lift the bearing itself or the individual ring by the bolts. Also, make sure that the eye bolts are only subjected to load in the direction of the shank axis (Figure 4). If the load is to be applied at an angle, suitable adjustable attachments are required.

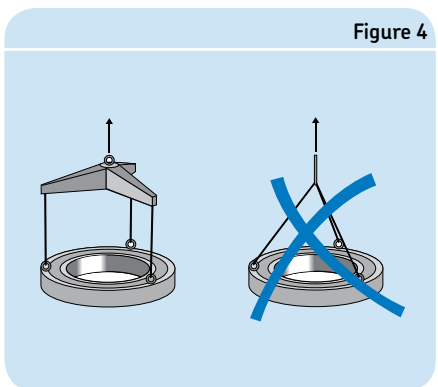

Figure 4

When mounting a large housing over a bearing that is already in position on a shaft, it is advisable to provide three-point suspension for the housing, and for the length of one sling to be adjustable. This enables the housing bore to be exactly aligned with the bearing.

## Fitting practice

A ball or roller bearing has precision component parts which fit together with very close tolerances. The inner ring bore and the outer ring outside diameter are manufactured within close limits to fit their respective supporting members—the shaft and housing. It follows that the shaft and the housing must also be machined to similar close limits. Only then will the required fitting be obtained when the bearing is mounted.

For a rotating shaft load the inner ring will creep on the shaft if a loose fit is used. This will result in overheating, excessive wear and contact erosion between the shaft and inner ring. Creep is described as the relative circumferential movement between the bearing ring and its seat, whether it be the shaft or housing. Therefore a preventive measure must be taken to eliminate creeping and its harmful results. Mount the bearing ring with a sufficient press fit. This will help ensure that both the bearing ring and seat act as a unit and rotate at the same speed. It is also desirable to use a clamping device, i.e. locknut or end plate, to clamp the ring against the shoulder.

If the applied load is of a rotating nature (for example, vibrating screens where unbalanced weights are attached to the shaft), then the outer ring becomes the critical member. In order to eliminate creeping in this case, the outer ring must be mounted with a press fit in the housing. The rotating inner ring, when subjected to a stationary load, can be mounted with a slip fit on the shaft. When the ring rotates in relation to the load a tight fit is required. For specific fit information, shaft and housing fit tables are provided in a separate chapter beginning on page 51.

## Internal bearing clearance

A press (or interference) fit on a shaft will expand the inner ring. This holds true when mounting the bearing directly on the shaft or by means of an adapter sleeve. Thus, there will be a tendency when mounted to have reduced internal clearance from the unmounted clearance.

However, bearings are designed in such a way that if the recommended shaft fits are used and operating temperatures have been taken into account, the internal clearance remaining after mounting the bearing will be sufficient for proper operation.

Figure 5

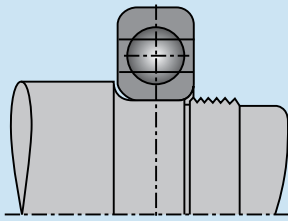

1. Shaft fillet too large

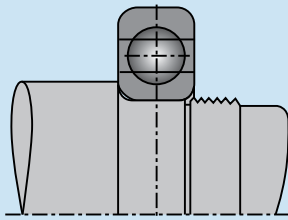

2. Correct shaft fillet

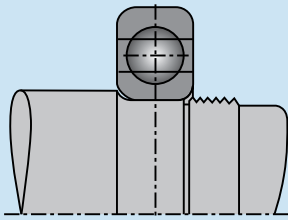

3. Shaft shoulder too small

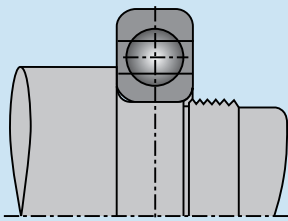

4. Shaft shoulder too large

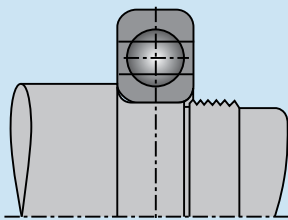

5. Correct shaft shoulder diameter

## Mounting

Nearly all rolling bearing applications require the use of an interference fit on at least one of the bearing rings, usually the inner. Consequently, all mounting methods are based on obtaining the necessary interference without undue effort, and with no risk of damage to the bearing. Depending on the bearing type and size, mechanical, thermal or hydraulic methods are used for mounting. In all cases it is important that the bearing rings, cages and rolling elements or seals do not receive direct blows, and that the mounting force must never be directed through the rolling elements. Three basic mounting methods are used, the choice depending on factors such as the number of mountings, bearing type and size, magnitude of the interferences and, possibly, the available tools. SKF supplies tools for all mounting methods described here. For more details, see the SKF Bearing Maintenance Tools Catalog (711-639) or [www.mapro.skf.com](http://www.mapro.skf.com).

### Mounting bearings with a cylindrical (straight) bore

With non-separable bearings, the ring that is to have the tighter fit should generally be mounted first. The seating surface should be lightly oiled with thin oil before mounting. The inner ring should be located against a shaft shoulder of proper height (Figure 5). This shoulder must be machined square with the bearing seat and a shaft fillet should be used. The radius of the fillet must clear the corner radius of the inner ring. Specific values can be found in the SKF Interactive Engineering Catalog located at [www.skf.com](http://www.skf.com) or the SKF General Catalog.

### Cold mounting

Mounting a bearing without heating is the most basic and direct mounting method. If the fit is not too tight, small bearings may be driven into position by applying light hammer blows to a sleeve placed against the bearing ring face having the interference fit. The blows should be evenly distributed around the ring to prevent the bearing from tilting or skewing.

Cold mounting is suitable for cylindrical bore bearings with an outside diameter up to 4 inches. In some cases, if the interference specified for a cylindrical bore bearing is great enough, the use of one of the other mounting methods is warranted. Three other situations may make it impractical or inadvisable to cold-mount a bearing:

- When the bearing face against which the pressing force is to be applied, either directly or through an adjacent part, is inaccessible.
- When the distance through which the bearing must be displaced in order to seat is too great.
- When the shaft or housing seating material is so soft that there is risk of permanently deforming it during the mounting process.

If a non-separable bearing is to be pressed onto the shaft and into the housing bore at the same time, the mounting force has to be applied equally to both rings at the same time and the abutment surfaces of the mounting tool must lie in the same plane. In this case a bearing fitting tool should be used, where an impact ring abuts the side faces of the inner and outer rings and the sleeve enables the mounting forces to be applied centrally (Figure 6)

Figure 6

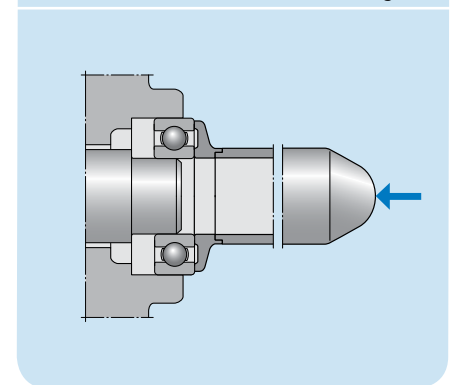

With separable bearings, the inner ring can be mounted independently of the outer ring, which simplifies mounting, particularly where both rings are to have an interference fit. When installing the shaft, with the inner ring already in position, into the housing containing the outer ring, make sure that they are correctly aligned to avoid scoring

the raceways and rolling elements. When mounting cylindrical and needle roller bearings with an inner ring without flanges or a flange at one side, SKF recommends using a mounting sleeve (**Figure 7**). The outside diameter of the sleeve should be equal to the raceway diameter of the inner ring and should be machined to a d10 tolerance.

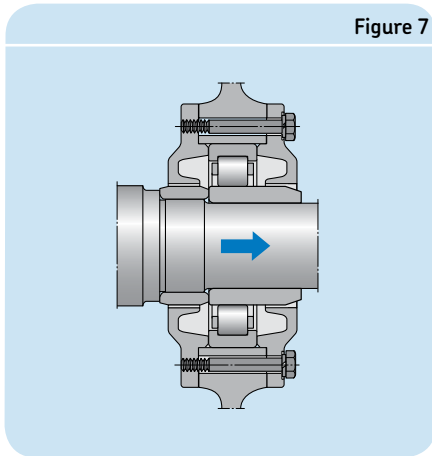

Figure 7

### Temperature (Hot) mounting

It is generally not possible to mount larger bearings in the cold state, as the force required to mount a bearing increases considerably with increasing bearing size. The bearings, the inner rings or the housings (e.g. hubs) are therefore heated prior to mounting. Temperature mounting is the technique of obtaining an interference fit by first introducing a temperature differential between the parts to be fitted, thus facilitating their assembly. The necessary temperature differential can be obtained in one of three ways:

- Heating one part (most common)
- Cooling one part
- Simultaneously heating one part and cooling the other

The requisite difference in temperature between the bearing ring and shaft or housing depends on the degree of interference and the diameter of the bearing seating.

### Heating the bearing

Heat mounting is suitable for all medium and large size straight bore bearings, and for small bearings with cylindrical seating arrangements. Normally a bearing temperature increase of 150° F above the shaft temperature provides sufficient expansion for mounting. As the bearing cools, it contracts and tightly grips the shaft. It's important to heat the bearing uniformly and to regulate

heat accurately. Bearings should not be heated above 250° F, as excess heat can destroy a bearing's metallurgical properties, softening the bearing and potentially changing its dimensions permanently. Standard ball bearings fitted with shields or seals should not be heated above 210° F because of their grease fill or seal material. If a non-standard grease is in the bearing, the grease limits should be checked before heating the bearing. Never heat a bearing using an open flame such as a blowtorch.

Localized overheating must be avoided. To heat bearings evenly, SKF induction heaters (**Figure 8**) are recommended. If hotplates are used, the bearing must be turned over a number of times. Hotplates should not be used for heating sealed bearings.

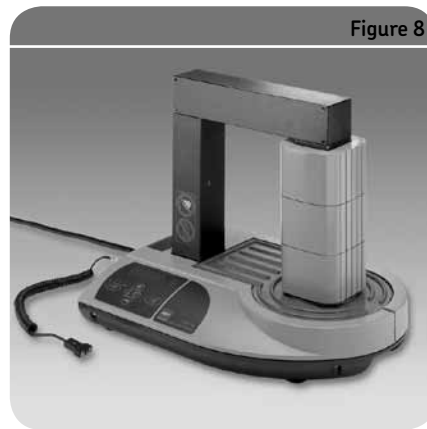

Figure 8

Heat mounting reduces the risk of bearing or shaft damage during installation because the bearing can be easily slid onto the shaft. Appropriate electric-heat bearing mounting devices include induction heaters, ovens, hot plates and heating cones. Of these, induction heaters and ovens are the most convenient and are the fastest devices to use. Hot oil baths have traditionally been used to heat bearings, but are no longer recommended except when unavoidable. In addition to health and safety considerations are the environmental issues about oil disposal, which can become costly. The risk of contamination to the bearing is also much greater.

If hot oil bath is used, both the oil and the container must be absolutely clean. Oil previously used for some other purpose should be thoroughly filtered. Quenching oil having a minimum flash point of 300° F, transformer oil, or 10% to 15% water soluble oil, are satisfactory heating mediums. When using an oil bath, temperature monitoring is

important not only to prevent bearing damage, but also to prevent the oil from reaching flash point. The quantity of oil used in a bath should be plentiful in relation to the volume of the bearing. An insufficient quantity heats and cools too rapidly, introducing the risk of inadequately or unevenly heating the bearing. It is also difficult in such a case to determine when and if the bearing has reached the same temperature as the oil. To avoid hot spots on the bearing, it is good practice to install a rack at the bottom of the bath. Sufficient time should be allowed for the entire bearing to reach the correct temperature. The bath should completely cover the bearing.

### Heating the housing

The bearing housing may require heating in cases where the bearing outer ring is mounted with an interference fit. Since the outer ring is usually mounted with a lighter interference fit, the temperature difference required is usually less than that required for an inner ring. A bearing housing may be heated in several ways. If the size of the housing bore permits, an inspection lamp can be inserted. The heat from the lamp usually is sufficient to produce the desired expansion. In some cases the shape and size of the housing allow the use of an electric furnace, but in other cases a hot oil bath is necessary.

### Mounting bearings with a tapered bore

Tapered bore bearings, such as double row self-aligning ball bearings, CARB® toroidal roller bearings, spherical roller bearings, and high-precision cylindrical roller bearings, will always be mounted with an interference fit. The degree of interference is not determined by the chosen shaft tolerance, as with bearings having a cylindrical bore, but by how far the bearing is driven up onto the tapered seat, i.e. onto the shaft, adapter, or withdrawal sleeve.

As the bearing is driven up the tapered seat, its inner ring expands and its radial internal clearance is reduced. During the mounting procedure, the reduction in radial internal clearance or the axial drive-up onto the tapered seating is determined and used as a measure of the degree of interference and the proper fit.



Drive-up is achieved with a force of sufficient magnitude applied directly to the face of the inner ring. This force is generated with one of the following devices:

1. Threaded lock nut
2. Bolted end plate
3. Hydraulic nut
4. Mounting sleeve

### Cold Mounting

The mounting of any tapered bore bearing is affected by driving the bearing on its seat a suitable amount. Since the amount of drive-up is critical to determining the amount of interference, cold mounting is typically the most common method used for mounting tapered bore bearings. Accurately controlling the axial position of the inner ring is very difficult with hot mounting.

### Oil-injection (hydraulic) mounting

This is a refined method for cold mounting a tapered bore bearing. It is based on the injection of oil between the interfering surfaces, thus greatly reducing the required axial mounting force. The pressure is generally supplied with a manually-operated reciprocating pump. The required pressure seldom exceeds 10,000 psi, and is usually much less. The oil used for oil-injection mounting should be neither too thin nor too viscous. It is difficult to build up pressures with excessively thin oils, while thick oils do not readily drain from between the fitting surfaces and require a little more axial force for positioning the bearing. This method cannot be used unless provided for in the design of the mounting. (Contact SKF for retrofitting details.)

## Mounting tapered bore double row self-aligning ball bearings

Most tapered bore self-aligning ball bearings are mounted with the use of adapter sleeves. Therefore, this instruction will be limited to adapter sleeves only.

### Precautions

For hollow shafts, please consult SKF Applications Engineering. The bearings should be left in their original packages until immediately before mounting so they do not become dirty. The dimensional and form accuracy of all components, which will be in contact with the bearing, should be checked.

#### Step 1

Remove any burrs or rust on the shaft with an emery cloth or a fine file.

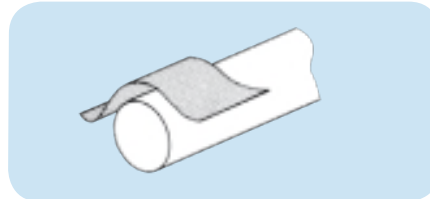

#### Step 2

Wipe the shaft with a clean cloth.



#### Step 3

Measure the shaft diameter.

#### Shaft tolerance limits for adapter mounting seatings

Nominal diameter		Tolerance limits inch
inch over	including	
1/2	1	0.000 / -0.002
1	2	0.000 / -0.003
2	4	0.000 / -0.004
4	6	0.000 / -0.005
6	-	0.000 / -0.006

#### Step 4

Screw off the nut from the adapter sleeve assembly and remove the locking washer.

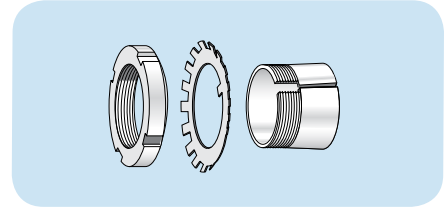

#### Step 5

Wipe preservative from the adapter O. D. and bore. Remove oil from the shaft to prevent transfer of oil to the bore of the adapter sleeve.

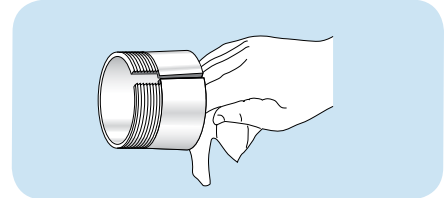

#### Step 6

Position the adapter sleeve on the shaft, threads outboard as indicated, to the approximate location with respect to required bearing centerline. For easier positioning of the sleeve, a screwdriver can be placed in the slit to open the sleeve. Applying a light oil to the sleeve outside diameter surface results in easier bearing mounting and removal.

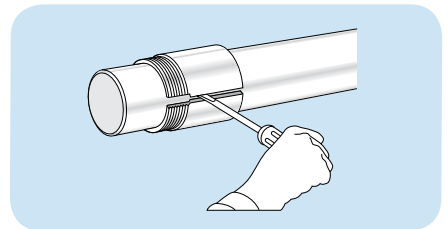

#### Step 7

Wipe the preservative from the bore of the bearing. It may not be necessary to remove the preservative from the internal components of the bearing unless the bearing will be lubricated by a circulating oil or oil mist system.

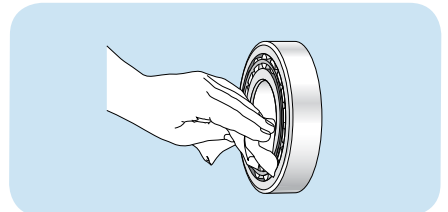

### Step 8

Place the bearing on the adapter sleeve, leading with the large bore of the inner ring to match the taper of the adapter. Apply the locknut with its chamfer facing the bearing (DO NOT apply locking washer at this time because the drive-up procedure may damage the locking washer). Applying a light coating of oil to the chamfered face of the lock nut will make mounting easier.

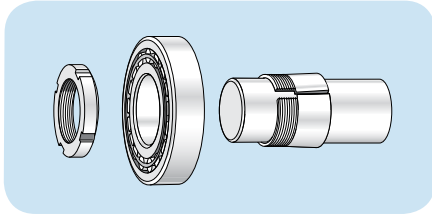

### Step 9

Using a spanner wrench, hand-tighten the locknut so that the sleeve grips the shaft and the adapter sleeve can neither be moved axially, nor rotated on the shaft. With the bearing hand tight on the adapter, locate the bearing to the proper axial position on the shaft. A method for checking if the bearing and sleeve are properly clamped is to place a screwdriver in the adapter sleeve split on the large end of the sleeve. Applying pressure to the screwdriver to attempt to turn the sleeve around the shaft is a good check to determine if the sleeve is clamped down properly. If the sleeve no longer turns on the shaft, then the zero point has been reached. Do not drive the bearing up any further.

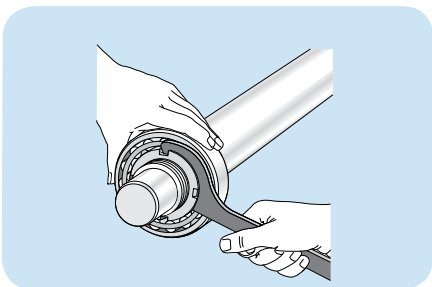

### Step 10

Place a reference mark on the locknut face and shaft, preferably in the 12 o'clock position, to use when measuring the tightening angle.

### Step 11

Identify the specific locknut part number on the adapter sleeve to determine if it is an inch or metric assembly and reference either **Table 1** or **Table 2** on page 17. Locate the specific bearing series column and bearing bore diameter row in the applicable table. Select the corresponding tightening angle.

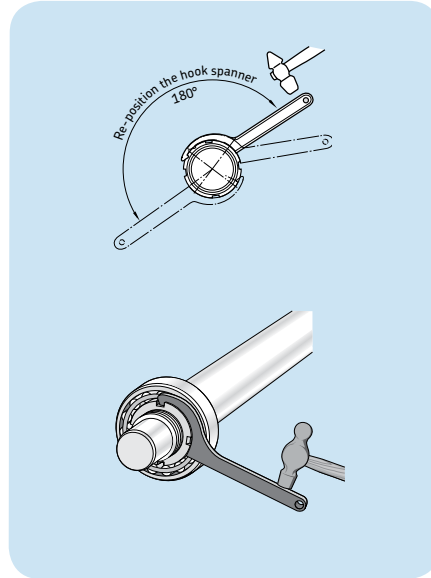

### Step 12

Remove the locknut and install the locking washer on the adapter sleeve. The inner prong of the locking washer should face the bearing and be located in the slot of the adapter sleeve. Reapply the locknut until tight. (DO NOT drive the bearing further up the taper, as this will reduce the radial internal clearance further).

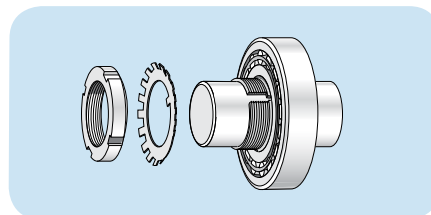

### Step 13

Find the locking washer tang that is nearest a locknut slot. If the slot is slightly past the tang don't loosen the nut, but instead tighten it to meet the closest locking washer tang. Do not bend the locking tab to the bottom of the locknut slot.

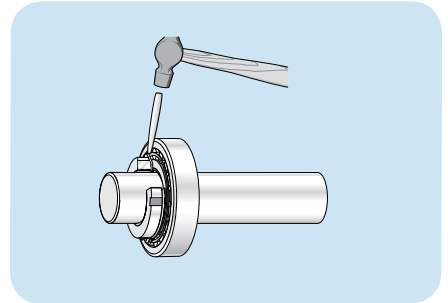

### Step 14

Check that the shaft and outer ring can be rotated easily by hand.

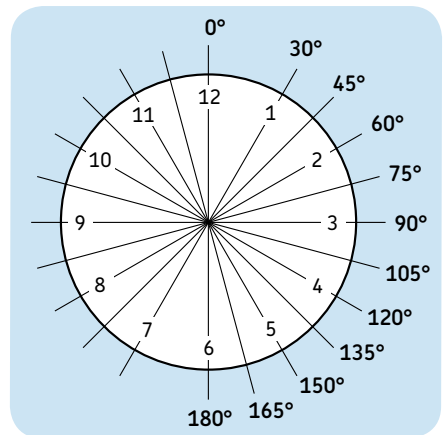
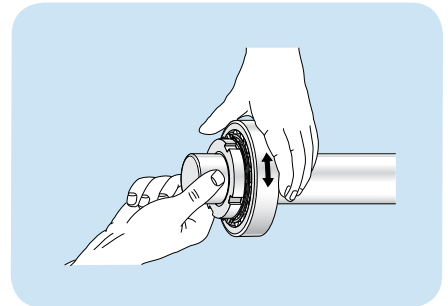

The angles of degree correlate to the hours on a clock. Use this guide to help visualize the turning angles shown on Tables 1 and 2.

Table 1

## Angular drive-up for self-aligning ball bearings (metric nut)

Bearing bore diameter d	Metric nut designation	Axial drive-up bearing series				Turning angle bearing series			
		12 K s	13 K s	22 K s	23 K s	12 K	13 K	22 K	23 K
(mm)		(mm)	(mm)	(mm)	(mm)	(deg)	(deg)	(deg)	(deg)
25	KM(FE) 5	0.22	0.23	0.22	0.23	55	55	55	55
30	KM(FE) 6	0.22	0.23	0.22	0.23	55	55	55	55
35	KM(FE) 7	0.30	0.30	0.30	0.30	70	70	70	70
40	KM(FE) 8	0.30	0.30	0.30	0.30	70	70	70	70
45	KM(FE) 9	0.31	0.34	0.31	0.33	75	80	75	80
50	KM(FE) 10	0.31	0.34	0.31	0.33	75	80	75	80
55	KM(FE) 11	0.40	0.41	0.39	0.40	70	75	70	75
60	KM(FE) 12	0.40	0.41	0.39	0.40	70	75	70	75
65	KM(FE) 13	0.40	0.41	0.39	0.40	70	75	70	75
70	KM(FE) 14	–	–	–	–	–	–	–	–
75	KM(FE) 15	0.45	0.47	0.43	0.46	80	85	75	85
80	KM(FE) 16	0.45	0.47	0.43	0.60	80	85	75	85
85	KM(FE) 17	0.58	0.60	0.54	0.59	105	110	95	110
90	KM(FE) 18	0.58	0.60	0.54	0.59	105	110	95	110
95	KM(FE) 19	0.58	0.60	0.54	–	105	110	95	105
100	KM(FE) 20	0.58	0.60	0.54	0.59	105	110	95	110
105	KM(FE) 21	–	–	–	–	–	–	–	–
110	KM(FE) 22	0.67	0.70	0.66	0.69	120	125	120	125
120	KM 24	0.67	–	–	–	120	–	–	–

Table 2

## Angular drive-up for self-aligning ball bearings (inch nut)

Bearing bore diameter d	Inch nut designation	Threads per inch	Axial drive-up bearing series				Turning angle bearing series			
			12 K s	13 K s	22 K s	23 K s	12 K	13 K	22 K	23 K
(mm)			(inch)	(inch)	(inch)	(inch)	(deg)	(deg)	(deg)	(deg)
25	N 05	32	0.009	0.009	0.009	0.009	100	100	100	100
30	N 06	18	0.009	0.009	0.009	0.009	55	55	55	55
35	N 07	18	0.012	0.012	0.012	0.012	75	75	75	75
40	N 08	18	0.012	0.012	0.012	0.012	75	75	75	75
45	N 09	18	0.012	0.013	0.012	0.013	80	85	80	85
50	N 10	18	0.012	0.013	0.012	0.013	80	85	80	85
55	N 11	18	0.016	0.016	0.015	0.016	100	85	80	85
60	N 12	18	0.016	0.016	0.015	0.016	100	105	100	105
65	N 13	18	0.016	0.016	0.015	0.016	100	105	100	105
70	N 14	–	–	–	–	–	–	–	–	–
75	AN 15	12	0.018	0.019	0.017	0.018	75	85	75	85
80	AN 16	12	0.018	0.019	0.017	0.024	75	85	75	85
85	AN 17	12	0.023	0.024	0.021	0.023	100	100	90	100
90	AN 18	12	0.023	0.024	0.021	0.023	100	100	90	100
95	AN 19	12	0.023	0.024	0.021	0.023	100	100	90	–
100	AN 20	12	0.023	0.024	0.021	0.023	100	100	90	100
105	AN 21	–	–	–	–	–	–	–	–	–
110	AN 22	12	0.026	0.028	0.026	0.027	115	115	110	115
120	AN 24	12	0.026	–	–	–	115	–	–	–

# Mounting tapered bore spherical roller bearings

Tapered bore spherical roller bearings can be mounted using one of three methods: radial clearance reduction, angular drive-up, or axial / SKF hydraulic drive-up. All three methods require the inner ring to be driven up a tapered seat in order to achieve the proper interference fit. The specific method selected by the end user will be dependent upon the size of the bearing, the number of bearings to be mounted, and the space constraints in the area surrounding the bearing.

## Radial clearance reduction method for mounting tapered bore (1:12) spherical roller bearings on adapter sleeves

### Precautions

For hollow shafts, please consult SKF Applications Engineering. The bearings should be left in their original packages until immediately before mounting so they do not become dirty. The dimensional and form accuracy of all components, which will be in contact with the bearing, should be checked.

### Step 1

Remove any burrs or rust on the shaft with an emery cloth or a fine file.

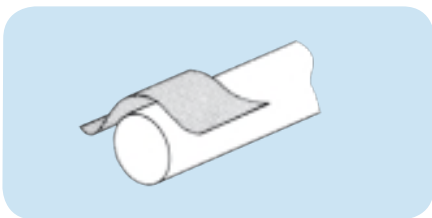

### Step 2

Wipe the shaft with a clean cloth.

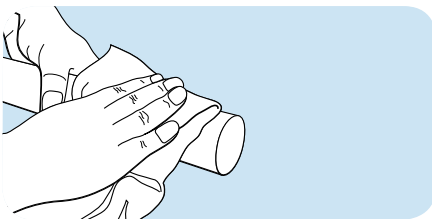

### Step 3

Measure the shaft diameter.

#### Shaft tolerance limits for adapter mounting seatings

Nominal diameter		Tolerance limits inch
inch over	including	
1/2	1	0.000 / -0.002
1	2	0.000 / -0.003
2	4	0.000 / -0.004
4	6	0.000 / -0.005
6	-	0.000 / -0.006

### Step 4

Screw off the nut from the adapter sleeve assembly and remove the locking washer.

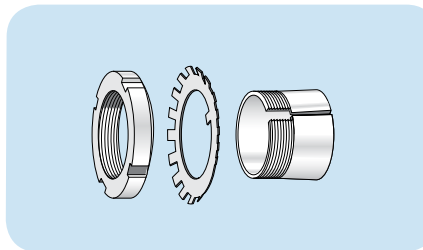

### Step 5

Wipe preservative from the adapter O. D. and bore. Remove oil from the shaft to prevent transfer of oil to the bore of the adapter sleeve.

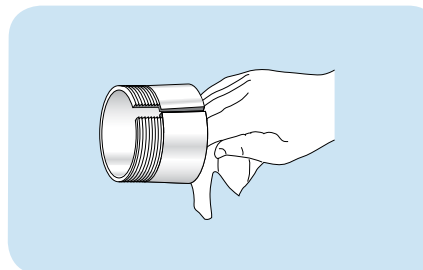

### Step 6

Position the adapter sleeve on the shaft, threads outboard as indicated, to the approximate location with respect to required bearing centerline. For easier positioning of the sleeve, a screwdriver can be placed in the slit to open the sleeve. Applying a light oil to the sleeve outside diameter surface results in easier bearing mounting and removal.

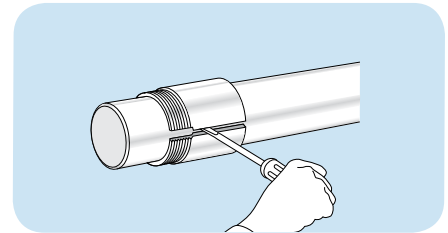

### Step 7

Wipe the preservative from the bore of the bearing. It may not be necessary to remove the preservative from the internal components of the bearing unless the bearing will be lubricated by a circulating oil or oil mist system.

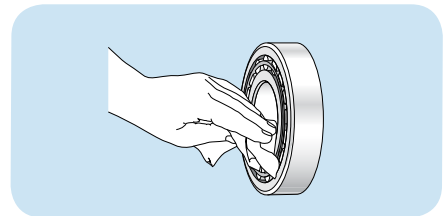

### Step 8

Measure the unmounted radial internal clearance in the bearing. The values for unmounted internal clearance for tapered bore spherical roller bearings are provided in **Table 3** on page 20.

Oscillate the inner ring in a circumferential direction to properly seat the rollers. Measure the radial internal clearance in the bearing by inserting progressively larger feeler blades the full length of the roller between the most unloaded roller and the outer ring sphere. **NOTE:** Do not roll completely over a pinched feeler blade, slide through the clearance. It is permissible to rotate a roller up onto the feeler blade but be sure it slides out of the contact area with a slight resistance. Record the measurement on the largest size blade that will slide through. This is the unmounted radial internal clearance.

Repeat this procedure in two or three other locations by resting the bearing on a different spot on its O.D. and measuring over different rollers in one row. Repeat the above procedure for the other row of rollers or measure each row alternately in the procedure described above.

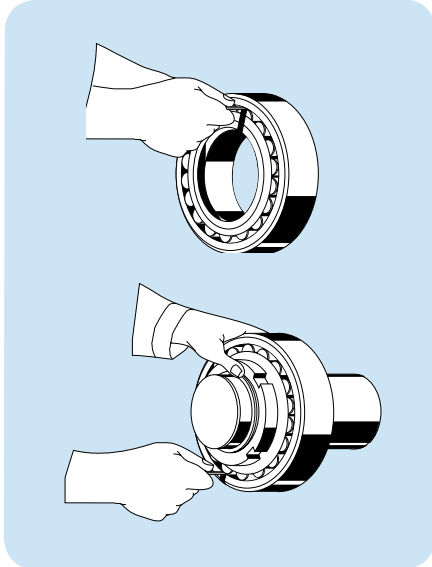

### Step 9

Place the bearing on the adapter sleeve, leading with the large bore of the inner ring to match the taper of the adapter. Apply the locknut with its chamfer facing the bearing (DO NOT apply the locking washer at this time because the drive-up procedure may damage the locking washer). Applying a light coating of oil to the chamfered face of the lock nut will make mounting easier.

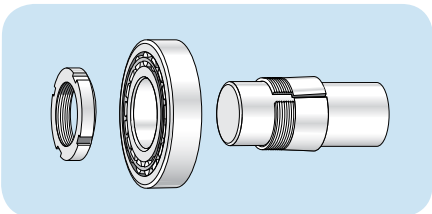

### Step 10

Using a spanner wrench, hand-tighten the locknut so that the sleeve grips the shaft and the adapter sleeve can neither be moved axially nor rotated on the shaft. With the bearing hand tight on the adapter, locate the bearing to the proper axial position on the shaft.

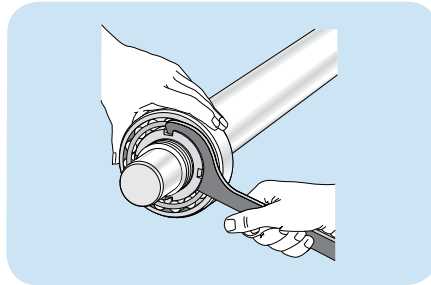

### Step 11

Select the proper radial internal clearance reduction range from **Table 3** on page 20. Using a hammer and a spanner wrench or just a hydraulic nut, begin tightening the nut in order to drive the inner ring up the tapered seat until the appropriate clearance reduction is achieved. **NOTE: LARGE SIZE BEARINGS WILL REQUIRE A HEAVY DUTY IMPACT SPANNER WRENCH AND SLEDGE HAMMER TO OBTAIN THE REQUIRED REDUCTION IN RADIAL INTERNAL CLEARANCE. AN SKF HYDRAULIC NUT MAKES MOUNTING OF LARGE SIZE BEARINGS EASIER.** Do not attempt to tighten the locknut with hammer and drift. The locknut will be damaged and chips can enter the bearing.

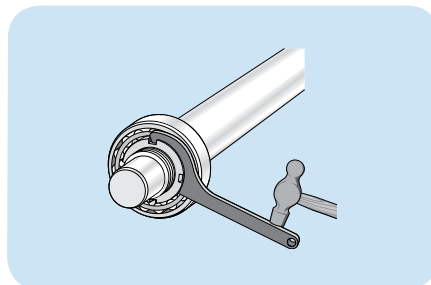

### Step 12

Remove the locknut and install the locking washer on the adapter sleeve. The inner prong of the locking washer should face the bearing and be located in the slot of the adapter sleeve. Reapply the locknut until tight. (DO NOT drive the bearing further up the taper, as this will reduce the radial internal clearance further).

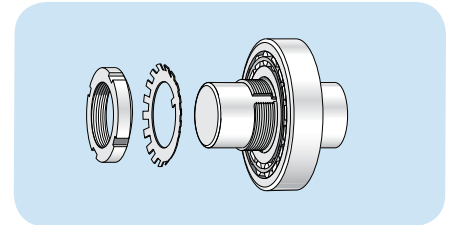

### Step 13

Find the locking washer tang that is nearest a locknut slot. If the slot is slightly past the tang don't loosen the nut, but instead tighten it to meet the closest locking washer tang. Do not bend the locking tab to the bottom of the locknut slot.

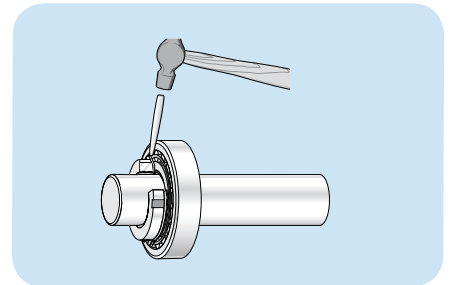

### Step 14

Check that the shaft and outer ring can be rotated easily by hand.

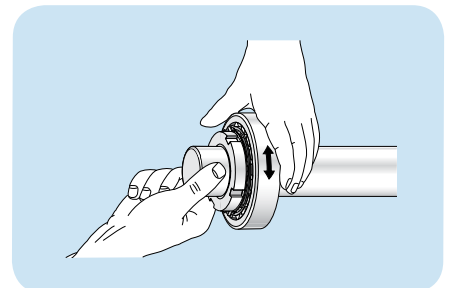

Table 3

Unmounted radial internal clearance of SKF tapered bore spherical roller bearings (in inches)								Recommended clearance reduction values of SKF tapered bore bearings (in inches)	
Bore diameter range (mm)		Normal		C3		C4		Reduction in radial internal clearance	
		(in.) min	max	(in.) min	max	(in.) min	max	(in.) min	max <sup>1</sup>
24	30	0.0012	0.0016	0.0016	0.0022	0.0022	0.0030	0.0006	0.0008
31	40	0.0014	0.0020	0.002	0.0026	0.0026	0.0033	0.0008	0.0010
41	50	0.0018	0.0024	0.0024	0.0031	0.0031	0.0039	0.0010	0.0012
51	65	0.0022	0.0030	0.003	0.0037	0.0037	0.0047	0.0012	0.0015
66	80	0.0028	0.0037	0.0037	0.0047	0.0047	0.0059	0.0015	0.0020
81	100	0.0031	0.0043	0.0043	0.0055	0.0055	0.0071	0.0018	0.0025
101	120	0.0039	0.0053	0.0053	0.0067	0.0067	0.0087	0.0020	0.0028
121	140	0.0047	0.0063	0.0063	0.0079	0.0079	0.0102	0.0025	0.0035
141	160	0.0051	0.0071	0.0071	0.0091	0.0091	0.0118	0.0030	0.0040
161	180	0.0055	0.0079	0.0079	0.0102	0.0102	0.0134	0.0030	0.0045
181	200	0.0063	0.0087	0.0087	0.0114	0.0114	0.0146	0.0035	0.0050
201	225	0.0071	0.0098	0.0098	0.0126	0.0126	0.0161	0.0040	0.0055
226	250	0.0079	0.0106	0.0106	0.0138	0.0138	0.0177	0.0045	0.0060
251	280	0.0087	0.0118	0.0118	0.0154	0.0154	0.0193	0.0045	0.0065
281	315	0.0094	0.0130	0.013	0.0169	0.0169	0.0213	0.0050	0.0075
316	355	0.0106	0.0142	0.0142	0.0185	0.0185	0.0232	0.0060	0.0085
356	400	0.0118	0.0157	0.0157	0.0205	0.0205	0.0256	0.0065	0.0090
401	450	0.0130	0.0173	0.0173	0.0224	0.0224	0.0283	0.0080	0.0105
451	500	0.0146	0.0193	0.0193	0.0248	0.0248	0.0311	0.0085	0.0110
501	560	0.0161	0.0213	0.0213	0.0268	0.0268	0.0343	0.0095	0.0125
561	630	0.0181	0.0236	0.0236	0.0299	0.0299	0.0386	0.0100	0.0135
631	710	0.0201	0.0264	0.0264	0.0335	0.0335	0.0429	0.0120	0.0155
711	800	0.0224	0.0295	0.0295	0.0378	0.0378	0.0480	0.0135	0.0175
801	900	0.0252	0.0331	0.0331	0.0421	0.0421	0.0539	0.0145	0.0195
901	1000	0.0280	0.0366	0.0366	0.0469	0.0469	0.0598	0.0160	0.0215
1001	1120	0.0303	0.0406	0.0406	0.0512	0.0512	0.0657	0.0175	0.0235
1121	1250	0.0327	0.0441	0.0441	0.0559	0.0559	0.0720	0.0190	0.0255
1251	1400	0.0358	0.0484	0.0484	0.0614	0.0614	0.0787	0.0215	0.0285
1401	1600	0.0394	0.0532	0.0532	0.0677	0.0677	0.0866	0.0235	0.0315
1601	1800	0.0437	0.0591	0.0591	0.0756	0.0756	0.0945	0.0265	0.0350

1. CAUTION: Do not use the maximum reduction of radial internal clearance when the initial unmounted radial internal clearance is in the lower half of the tolerance range or where large temperature differentials between the bearing rings can occur in operation.

NOTE: If a different taper angle or shaft system is encountered, the following guidelines can be used.

The axial drive-up "S" is approximately:

- 16 times the reduction on 1:12 solid tapered steel shafts
- 18 times the reduction on 1:12 taper for sleeve mounting
- 39 times the reduction on 1:30 solid tapered steel shafts
- 42 times the reduction on 1:30 taper for sleeve mounting

## Radial clearance reduction method for mounting tapered bore (1:12) spherical roller bearings onto a solid tapered shaft

### Precautions

For hollow shafts, please consult SKF Applications Engineering. The bearings should be left in their original packages until immediately before mounting so they do not become dirty. The dimensional and form accuracy of all components, which will be in contact with the bearing, should be checked.

### Step 1

Remove any burrs or rust on the shaft with an emery cloth or a fine file.

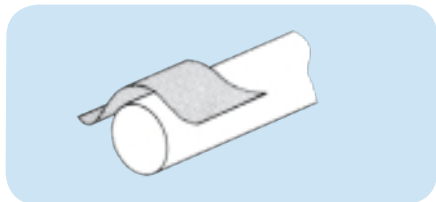

### Step 2

Wipe the shaft with a clean cloth.



### Step 3

Measure the shaft taper for geometry and contact using taper gauges.

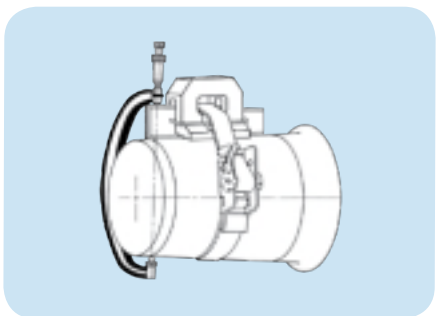

### Step 4

Wipe the preservative from the bore of the bearing. It may not be necessary to remove the preservative from the internal components of the bearing unless the bearing will be lubricated by a circulating oil or oil mist system.

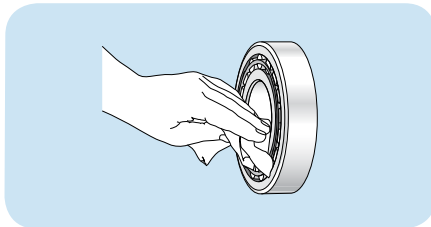

### Step 5

Measure the unmounted radial internal clearance in the bearing. The values for unmounted internal clearance for tapered bore spherical roller bearings are provided in **Table 3** on page 20.

Oscillate the inner ring in a circumferential direction to properly seat the rollers. Measure the radial internal clearance in the bearing by inserting progressively larger feeler blades the full length of the roller between the most unloaded roller and the outer ring sphere. **NOTE:** Do not roll completely over a pinched feeler blade, slide through the clearance. It is permissible to rotate a roller up onto the feeler blade but be sure it slides out of the contact area with a slight resistance. Record the measurement on the largest size blade that will slide through. This is the unmounted radial internal clearance.

Repeat this procedure in two or three other locations by resting the bearing on a different spot on its O.D. and measuring over different rollers in one row. Repeat the above procedure for the other row of rollers or measure each row alternately in the procedure described above.

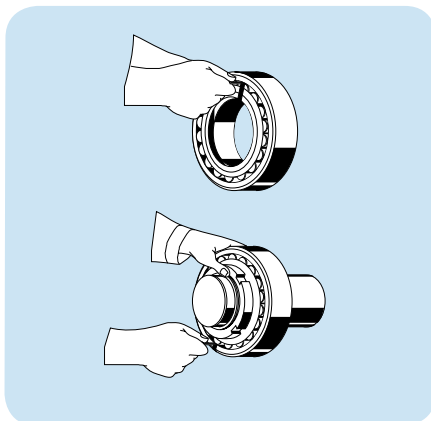

### Step 6

Place the bearing on the tapered shaft, leading with the large bore of the inner ring to match the taper of the shaft. Apply the locknut with its chamfer facing the bearing (DO NOT apply the locking washer at this time because the drive-up procedure may damage the locking washer). Applying a light coating of oil to the chamfered face of the lock nut will make mounting easier.

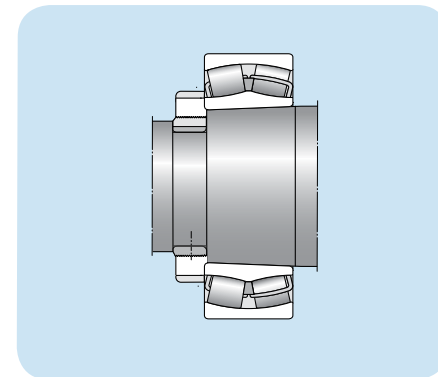

### Step 7

Select the proper radial internal clearance reduction range from **Table 3** on page 20. Using a hammer and a spanner wrench or just a hydraulic nut, begin tightening the nut in order to drive the inner ring up the tapered shaft until the appropriate clearance reduction is achieved. **NOTE:** LARGE SIZE BEARINGS WILL REQUIRE A HEAVY DUTY IMPACT SPANNER WRENCH AND SLEDGE HAMMER TO OBTAIN THE REQUIRED REDUCTION IN RADIAL INTERNAL CLEARANCE. AN SKF HYDRAULIC NUT MAKES MOUNTING OF LARGE SIZE BEARINGS EASIER. Do not attempt to tighten the locknut with a hammer and drift. The locknut will be damaged and chips can enter the bearing.

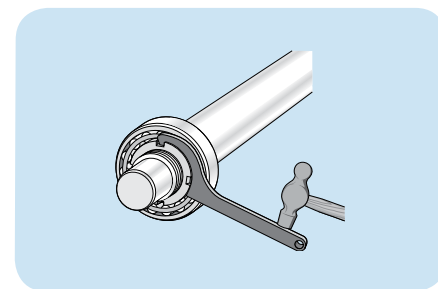

### Step 8

Remove the locknut and install the locking washer on the shaft. The inner prong of the locking washer should face the bearing and be located in the keyway. Reapply the locknut until tight. (DO NOT drive the bearing further up the taper, as this will reduce the radial internal clearance further).

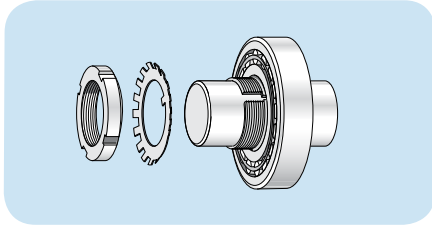

### Step 9

Find the locking washer tang that is nearest a locknut slot. If the slot is slightly past the tang don't loosen the nut, but instead tighten it to meet the closest locking washer tang. Do not bend the locking tab to the bottom of the locknut slot.

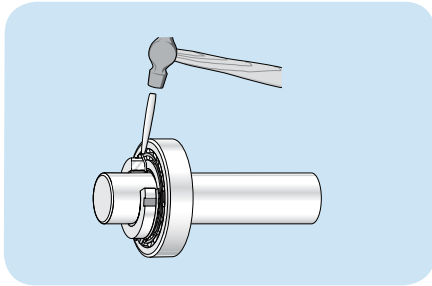

### Step 10

Check that the shaft and outer ring can be rotated easily by hand.

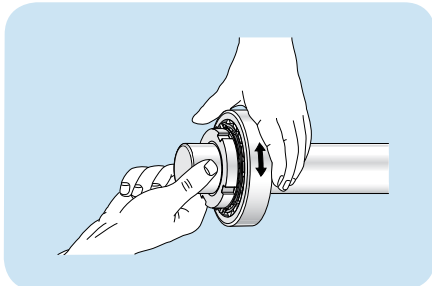

## Angular drive-up method for mounting tapered bore (1:12) spherical roller bearings on an adapter sleeve

The angular drive-up method simplifies the mounting process by equating axial drive up to the rotation of a locknut. By knowing the threads per inch of a locknut, the number of rotations to achieve a specific axial movement can be determined. In order to make this mounting method work properly, the starting point is important since that is the reference point to determine when to start counting the rotation of the locknut.

### Precautions

The bearings should be left in their original packages until immediately before mounting so they do not become dirty. The dimensional and form accuracy of all components, which will be in contact with the bearing, should be checked.

### Step 1

Remove any burrs or rust on the shaft with an emery cloth or a fine file.

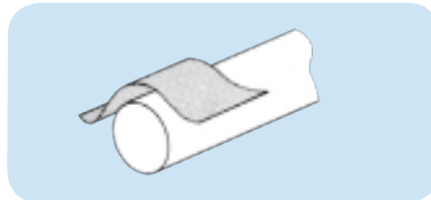

### Step 2

Wipe the shaft with a clean cloth.



### Step 3

Measure the shaft diameter.

#### Shaft tolerance limits for adapter mounting seatings

Nominal diameter		Tolerance limits inch
inch over	including	
1/2	1	0.000 / -0.002
1	2	0.000 / -0.003
2	4	0.000 / -0.004
4	6	0.000 / -0.005
6	-	0.000 / -0.006

### Step 4

Screw off the nut from the adapter sleeve assembly and remove the locking washer.

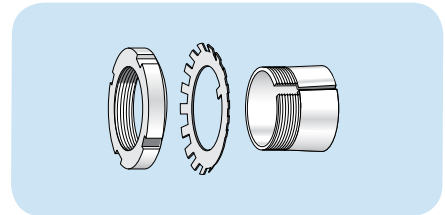

### Step 5

Wipe preservative from the adapter O. D. and bore. Remove oil from the shaft to prevent transfer of oil to the bore of the adapter sleeve.

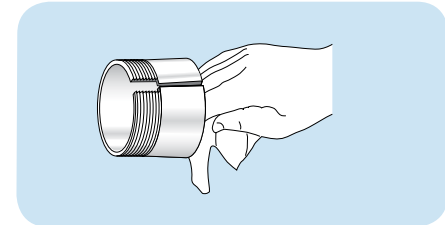

### Step 6

Position the adapter sleeve on the shaft, threads outboard as indicated, to the approximate location with respect to required bearing centerline. For easier positioning of the sleeve, a screwdriver can be placed in the slit to open the sleeve. Applying a light oil to the sleeve outside diameter surface results in easier bearing mounting and removal.

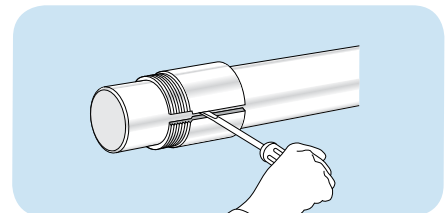



### Step 7

Wipe the preservative from the bore of the bearing. It may not be necessary to remove the preservatives from the internal components of the bearing unless the bearing will be lubricated by a circulating oil or oil mist system.

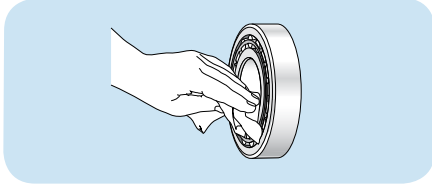

### Step 8

Place the bearing on the adapter sleeve, leading with the large bore of the inner ring to match the taper of the adapter. Apply the locknut with its chamfer facing the bearing (DO NOT apply the locking washer at this time because the drive-up procedure may damage the locking washer). Applying a light coating of oil to the chamfered face of the lock nut will make mounting easier.

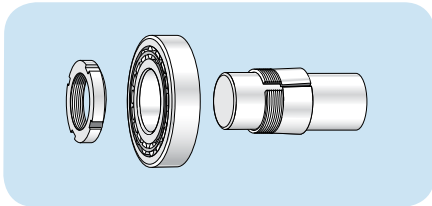

### Step 9

Using a spanner wrench, hand-tighten the locknut so that the sleeve grips the shaft and the adapter sleeve can neither be moved axially, nor rotated on the shaft. With the bearing hand tight on the adapter, locate the bearing to the proper axial position on the shaft. A method for checking if the bearing and sleeve are properly clamped is to place a screwdriver in the adapter sleeve split on the large end of the sleeve. Applying pressure to the screwdriver to attempt to turn the sleeve around the shaft is a good check to determine if the sleeve is clamped down properly. If the sleeve no longer turns on the shaft, then the zero point has been reached. Do not drive the bearing up any further.

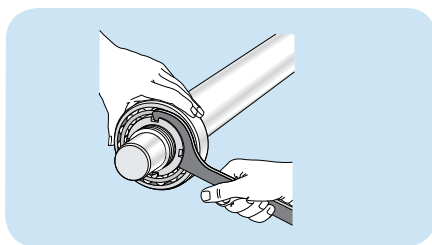

### Step 10

Place a reference mark on the locknut face and shaft, preferably in the 12 o'clock position, to use when measuring the tightening angle.

### Step 11

Locate the specific bearing part number in **Table 4** on page 24. Note the specific lock nut part number on the adapter sleeve to determine if it is an inch or metric assembly. Once the appropriate locknut part number has been obtained, select the corresponding tightening angle from **Table 4**.

### Step 12

Using a hammer and a spanner wrench, begin tightening the locknut the corresponding tightening angle. **NOTE: LARGE SIZE BEARINGS WILL REQUIRE A HEAVY DUTY IMPACT SPANNER WRENCH AND SLEDGE HAMMER TO OBTAIN THE REQUIRED REDUCTION IN RADIAL INTERNAL CLEARANCE.** Do not attempt to tighten the locknut with hammer and drift. The locknut will be damaged and chips can enter the bearing.

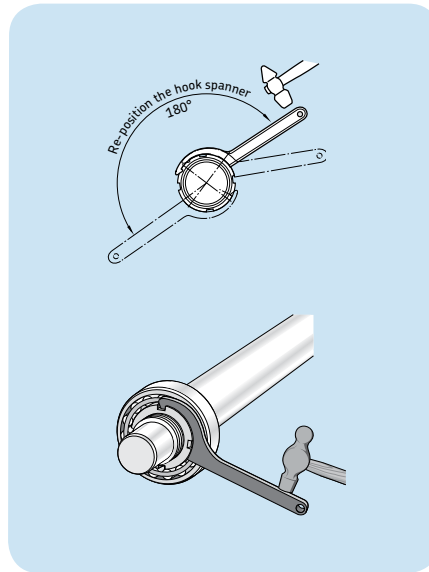

### Step 13

Remove the locknut and install the locking washer on the adapter sleeve. The inner prong of the locking washer should face the bearing and be located in the slot of the adapter sleeve. Reapply the locknut until tight. (DO NOT drive the bearing further up the taper, as this will reduce the radial internal clearance further).

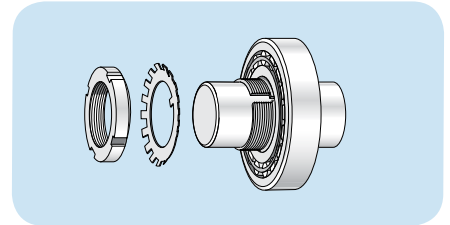

### Step 14

Find the locking washer tang that is nearest a locknut slot. If the slot is slightly past the tang don't loosen the nut, but instead tighten it to meet the closest locking washer tang. Do not bend the locking tab to the bottom of the locknut slot.

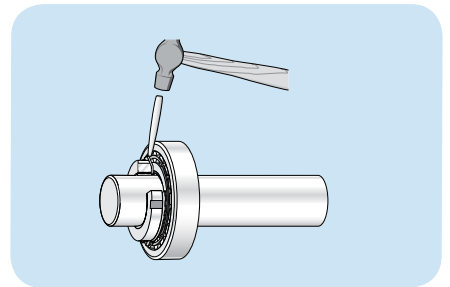

### Step 15

Check that the shaft and outer ring can be rotated easily by hand.

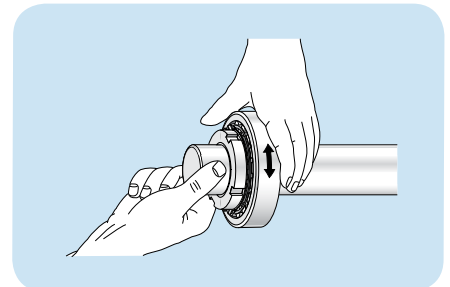
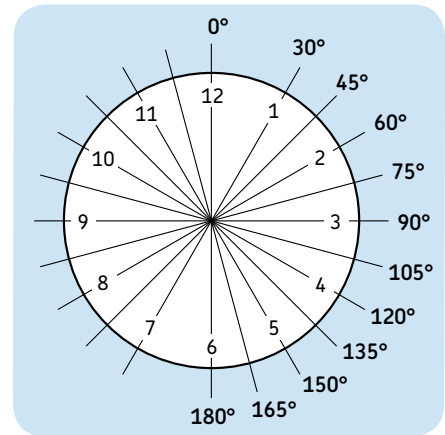

Table 4

### Angular drive-up for spherical roller bearings (metric and inch nuts)

Bearing designation	Bearing bore diameter d (mm)	Axial drive-up s (mm)	Metric nut designation	Turning angle $\alpha$ (degrees)	Inch nut designation	Turning angle $\alpha$ (degrees)
<b>222xx series</b>						
22206 K	30	0.30	KM(FE) 6	110	N 06	115
22207 K	35	0.35	KM(FE) 7	115	N 07	120
22208 K	40	0.35	KM(FE) 8	125	N 08	135
22209 K	45	0.40	KM(FE) 9	130	N 09	140
22210 K	50	0.40	KM(FE) 10	140	N 10	150
22211 K	55	0.45	KM(FE) 11	110	N 11	155
22212 K	60	0.45	KM(FE) 12	115	N 12	165
22213 K	65	0.45	KM(FE) 13	120	N 13	170
22214 K	70	0.60	KM(FE) 14	130	N 14	175
22215 K	75	0.60	KM(FE) 15	135	AN 15	120
22216 K	80	0.60	KM(FE) 16	140	AN 16	130
22217 K	85	0.70	KM(FE) 17	145	AN 17	135
22218 K	90	0.70	KM(FE) 18	150	AN 18	145
22219 K	95	0.70	KM(FE) 19	155	AN 19	145
22220 K	100	0.70	KM(FE) 20	160	AN 20	150
22222 K	110	0.75	KM(FE) 22	175	AN 22	160
22224 K	120	0.75	KM 24	185	AN 24	170
<b>223xx series</b>						
22308 K	40	0.35	KM(FE) 8	125	N 08	135
22309 K	45	0.40	KM(FE) 9	135	N 09	140
22310 K	50	0.40	KM(FE) 10	145	N 10	150
22311 K	55	0.45	KM(FE) 11	115	N 11	155
22312 K	60	0.45	KM(FE) 12	120	N 12	165
22313 K	65	0.45	KM(FE) 13	125	N 13	170
22314 K	70	0.60	KM(FE) 14	135	N 14	175
22315 K	75	0.60	KM(FE) 15	135	AN 15	120
22316 K	80	0.60	KM(FE) 16	145	AN 16	130
22317 K	85	0.70	KM(FE) 17	150	AN 17	135
22318 K	90	0.70	KM(FE) 18	155	AN 18	145
22319 K	95	0.70	KM(FE) 19	165	AN 19	145
22320 K	100	0.70	KM(FE) 20	170	AN 20	150
22322 K	110	0.75	KM(FE) 22	185	AN 22	160
22324 K	120	0.75	KM 24	195	AN 24	170

Drive up and angular rotation values are the same for both CC and E design SKF spherical roller bearings. For sizes greater than those shown above we recommend the use of the SKF Hydraulic drive-up method. For threads per inch see **Table 2** (page 17).



The angles of degree correlate to the hours on a clock. Use this guide to help visualize the turning angles shown on Table 4.

### SKF hydraulic (axial) drive-up method for tapered bore (1:12) spherical roller bearings on an adapter sleeve

The axial drive-up method relies on the bearing being driven up a tapered seat a specific amount to ensure the inner ring is expanded enough to provide proper clamping force on the shaft or sleeve. In order for this method to work properly, the starting point is important since that is the reference point to determine when the bearing has been driven up enough. A new method of accurately achieving this starting point has been developed by SKF and is now available. The method incorporates the use of a hydraulic nut fitted with a dial indicator, and a specially calibrated pressure gauge, mounted on the selected pump.

A special hydraulic pressure table providing the required psi pressures must be used for each bearing type (see **Table 5** on page 26). This enables accurate positioning of the bearing at the starting point, where the axial drive-up is measured. This method provides:

1. Reduced time to mount bearings.
2. A reliable, safe and accurate method of clearance adjustment.
3. Ideal way to mount sealed spherical roller bearings.

### Precautions

For hollow shafts, please consult SKF Applications Engineering. The bearings should be left in their original packages until immediately before mounting so they do not become dirty. The dimensional and form accuracy of all components, which will be in contact with the bearing, should be checked.

### Step 1

Remove any burrs or rust on the shaft with an emery cloth or a fine file.

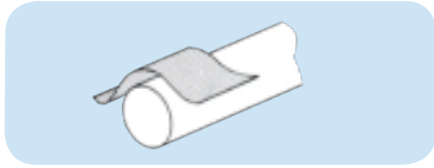

### Step 2

Wipe the shaft with a clean cloth.

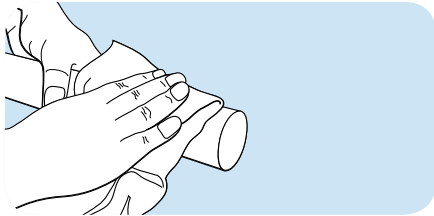

### Step 3

Measure the shaft diameter.

#### Shaft tolerance limits for adapter mounting seatings

Nominal diameter		Tolerance limits inch
inch over	including	
1/2	1	0.000 / -0.002
1	2	0.000 / -0.003
2	4	0.000 / -0.004
4	6	0.000 / -0.005
6	-	0.000 / -0.006

### Step 4

Remove the locknut and locking washer from the adapter sleeve assembly.

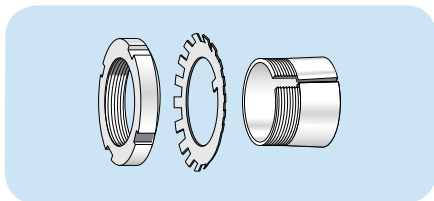

### Step 5

Wipe preservative from the adapter O. D. and bore. Remove oil from the shaft to prevent transfer of oil to the bore of the adapter sleeve.

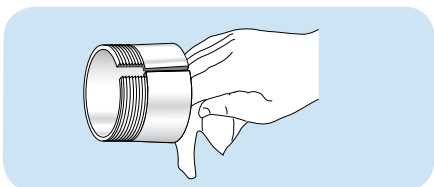

### Step 6

Position the adapter sleeve on the shaft, threads outboard as indicated, to the approximate location with respect to required bearing centerline. For easier positioning of the sleeve, a screwdriver can be placed in the slit to open the sleeve.

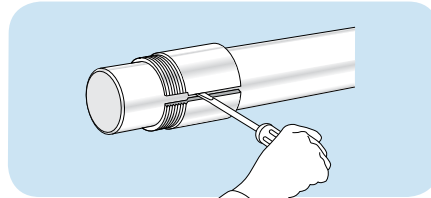

### Step 7

Applying a light oil to the sleeve outside diameter surface results in easier bearing mounting and removal. Wipe the preservative from the bore of the bearing. It may not be necessary to remove the preservative from the internal components of the bearing unless the bearing will be lubricated by a circulating oil or oil mist system.

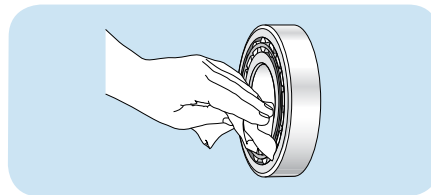

### Step 8

Place the bearing on the adapter sleeve, leading with the large bore of the inner ring to match the taper of the adapter. Apply the hydraulic nut (DO NOT apply the locking washer at this time). Ensure that the bearing bore size is equal to the hydraulic nut. Otherwise, the pressure in the table must be adjusted. Drive the bearing up to the starting position by applying the hydraulic pressure listed in Starting Position 1\* in Table 5 for the specific bearing size being mounted. Monitor the pressure by the gauge on the selected pump. As an alternative, SKF mounting gauge TMJG 100D can be screwed directly into the hydraulic nut.

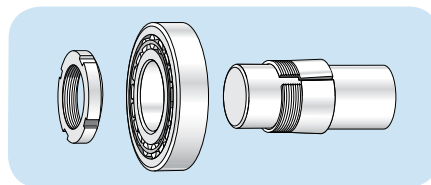

### Step 9

Drive the bearing up the adapter sleeve the required distance  $S_5$  shown under column heading 1\*\*\* of Table 5. The axial drive-up is best monitored by a dial indicator.

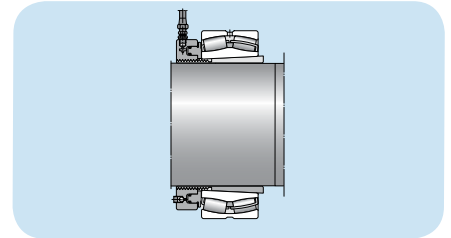

### Step 10

Remove the hydraulic nut and install the locking washer on the adapter sleeve. The inner prong of the locking washer should face the bearing and be located in the slot of the adapter sleeve. Reapply the locknut until tight. (DO NOT drive the bearing further up the taper, as this will reduce the radial internal clearance further).

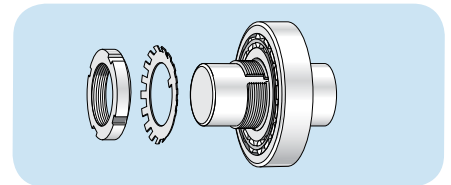

### Step 11

Find the locking washer tang that is nearest a locknut slot. If the slot is slightly past the tang don't loosen the nut, but instead tighten it to meet the closest locking washer tang. Do not bend the locking tab to the bottom of the locknut slot.

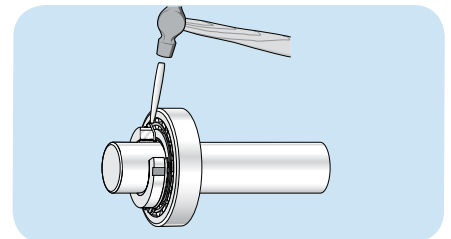

### Step 12

Check that the shaft and outer ring can be rotated easily by hand.

**Note:** For bearings with a bore diameter greater than 200mm, hydraulic assist is recommended in addition to using the hydraulic nut.

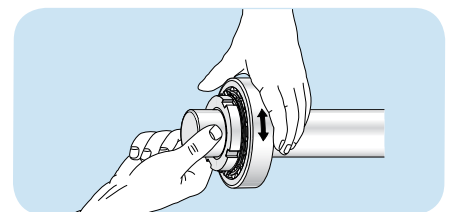

## Pressure and axial drive-up for spherical roller bearings

SKF bearing designation	Starting position		Final position		
	Hydraulic pressure		Radial clearance reduction from zero position (in.)	Axial drive-up from starting position $S_s$	
	1* (psi)	2** (psi)		1*** (in.)	2**** (in.)
<b>213xx series</b>					
21310 EK	286	–	0.0009	0.0146	–
21311 EK	215	365	0.0010	0.0154	0.0181
21312 EK	351	600	0.0011	0.0177	0.0205
21313 EK	365	625	0.0012	0.0185	0.0213
21314 EK	386	658	0.0012	0.0205	0.0232
21315 EK	318	542	0.0013	0.0201	0.0229
21316 EK	319	545	0.0014	0.0209	0.0236
21317 EK	254	434	0.0015	0.0205	0.0236
21318 EK	270	460	0.0016	0.0225	0.0252
21319 EK	278	476	0.0017	0.0232	0.0260
21320 EK	216	368	0.0018	0.0229	0.0256
<b>222xx series</b>					
22210 EK	102	191	0.0009	0.0126	0.0154
22211 EK	104	194	0.0010	0.0142	0.0169
22212 EK	139	248	0.0011	0.0154	0.0181
22213 EK	168	313	0.0011	0.0162	0.0189
22214 EK	135	244	0.0013	0.0173	0.0201
22215 EK	126	225	0.0013	0.0177	0.0209
22216 EK	146	262	0.0014	0.0189	0.0217
22217 EK	168	300	0.0015	0.0197	0.0229
22218 EK	174	318	0.0016	0.0213	0.0240
22219 EK	199	354	0.0017	0.0221	0.0248
22220 EK	212	376	0.0018	0.0229	0.0256
22222 EK	251	452	0.0019	0.0248	0.0276
22224 EK	267	471	0.0021	0.0268	0.0299
22226 EK	284	502	0.0023	0.0284	0.0311
22228 CCK/W33	338	595	0.0025	0.0311	0.0339
22230 CCK/W33	361	634	0.0027	0.0335	0.0362
22232 CCK/W33	373	731	0.0028	0.0355	0.0382
22234 CCK/W33	402	751	0.0030	0.0374	0.0402
22236 CCK/W33	361	676	0.0032	0.0390	0.0422
22238 CCK/W33	371	706	0.0033	0.0410	0.0437
22240 CCK/W33	389	722	0.0035	0.0433	0.0461
22244 CCK/W33	426	838	0.0039	0.0477	0.0504
22248 CCK/W33	480	938	0.0043	0.0524	0.0552
22252 CCK/W33	470	914	0.0046	0.0559	0.0587
22256 CCK/W33	428	818	0.0050	0.0595	0.0626
22260 CCK/W33	419	802	0.0053	0.0634	0.0662
22264 CCK/W33	442	841	0.0057	0.0674	0.0705

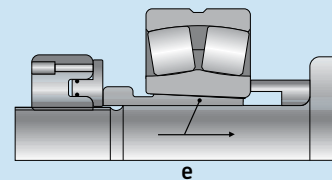
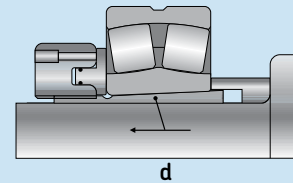
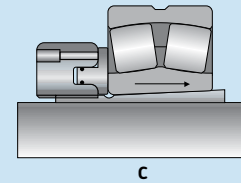
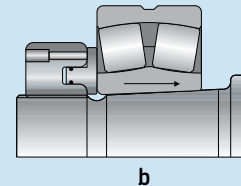
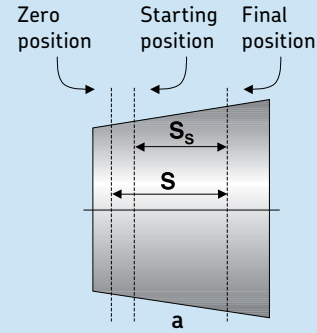

\* Values given valid for HMV (C) E series hydraulic nuts equal to bearing size and with one sliding surface (see **Figures b and c**). Surfaces lightly oiled with light oil.

\*\* Values given valid for HMV (C) E series hydraulic nuts equal to one size smaller than bearing size and two sliding surfaces (see **Figure e**). Surfaces lightly oiled with light oil.

\*\*\* Values given are valid for one sliding surface (see **Figures b and c**). Surfaces lightly oiled with light oil.

\*\*\*\* Values given are valid for two sliding surfaces (see **Figure e**). Surfaces lightly oiled with light oil. The difference in drive-up between one surface and two surfaces is the result of smoothing.

NOTE: To convert values to mm and MPa  $\text{mm} = \text{in} \times 25.4$   $\text{MPa} = \text{psi} \times 0.0069$

Table 5

## Pressure and axial drive-up for spherical roller bearings

SKF bearing designation	Starting position		Final position		
	Hydraulic pressure		Radial clearance reduction from zero position	Axial drive-up from starting position $S_s$	
	1* (psi)	2** (psi)		(in.)	1*** (in.)
<b>223xx series</b>					
22310 EK	270	–	0.0008	0.0134	0.0162
22311 EK	287	532	0.0010	0.0150	0.0181
22312 EK	345	616	0.0011	0.0162	0.0189
22313 EK	306	570	0.0011	0.0165	0.0193
22314 EK	374	674	0.0013	0.0185	0.0217
22315 EK	338	608	0.0013	0.0189	0.0217
22316 EK	348	624	0.0014	0.0197	0.0225
22317 EK	428	764	0.0015	0.0213	0.0240
22318 EK	432	787	0.0016	0.0225	0.0256
22319 EK	441	784	0.0017	0.0232	0.0260
22320 EK	595	1057	0.0018	0.0252	0.0280
22322 EK	653	1176	0.0019	0.0272	0.0299
22324 CCK/W33	634	1118	0.0021	0.0288	0.0319
22326 CCK/W33	686	1209	0.0023	0.0307	0.0335
22328 CCK/W33	729	1282	0.0025	0.0331	0.0359
22330 CCK/W33	766	1344	0.0027	0.0355	0.0382
22332 CCK/W33	747	1465	0.0028	0.0374	0.0402
22334 CCK/W33	760	1417	0.0030	0.0390	0.0418
22336 CCK/W33	747	1396	0.0032	0.0414	0.0441
22338 CCK/W33	738	1405	0.0033	0.0433	0.0461
22340 CCK/W33	745	1382	0.0035	0.0457	0.0485
22344 CCK/W33	811	1595	0.0039	0.0508	0.0536
22348 CCK/W33	808	1581	0.0043	0.0548	0.0575
22352 CCK/W33	815	1581	0.0046	0.0591	0.0619
22356 CCK/W33	827	1581	0.0050	0.0634	0.0662

Table 5

## Pressure and axial drive-up for spherical roller bearings

SKF bearing designation	Starting position		Final position		
	Hydraulic pressure		Radial clearance reduction from zero position	Axial drive-up from starting position $S_s$	
	1* (psi)	2** (psi)		(in.)	1*** (in.)
<b>230xx series</b>					
23022 CCK/W33	157	283	0.0019	0.0240	0.0268
23024 CCK/W33	149	262	0.0021	0.0260	0.0288
23026 CCK/W33	184	325	0.0023	0.0276	0.0303
23028 CCK/W33	175	309	0.0025	0.0295	0.0327
23030 CCK/W33	180	316	0.0027	0.0319	0.0347
23032 CCK/W33	180	351	0.0028	0.0335	0.0362
23034 CCK/W33	194	363	0.0030	0.0351	0.0378
23036 CCK/W33	219	409	0.0032	0.0374	0.0406
23038 CCK/W33	215	409	0.0033	0.0394	0.0422
23040 CCK/W33	236	438	0.0035	0.0418	0.0445
23044 CCK/W33	242	476	0.0039	0.0453	0.0485
23048 CCK/W33	216	422	0.0043	0.0489	0.0516
23052 CCK/W33	249	484	0.0046	0.0532	0.0559
23056 CCK/W33	225	431	0.0050	0.0630	0.0595
23060 CCK/W33	255	487	0.0053	0.0607	0.0634
23064 CCK/W33	232	442	0.0057	0.0642	0.0670
23068 CCK/W33	267	492	0.0060	0.0682	0.0713
23072 CCK/W33	238	448	0.0064	0.0717	0.0745
23076 CCK/W33	229	419	0.0067	0.0753	0.0780
23080 ...K/W33	254	476	0.0071	0.0796	0.0823
23084 CAK/W33	236	439	0.0074	0.0827	0.0855
23088 CAK/W33	248	450	0.0078	0.0867	0.0894
23092 CAK/W33	249	452	0.0081	0.0906	0.0934
23096 CAK/W33	218	400	0.0085	0.0934	0.0961
<b>231xx series</b>					
23120 CCK/W33	206	364	0.0018	0.0225	0.0252
23122 CCK/W33	210	378	0.0019	0.0240	0.0268
23124 CCK/W33	257	454	0.0021	0.0264	0.0295
23126 CCK/W33	239	421	0.0023	0.0280	0.0307
23128 CCK/W33	248	435	0.0025	0.0299	0.0327
23130 CCK/W33	322	564	0.0027	0.0327	0.0355
23132 CCK/W33	328	641	0.0028	0.0343	0.0374
23134 CCK/W33	310	579	0.0030	0.0359	0.0386
23136 CCK/W33	335	626	0.0032	0.0382	0.0410
23138 CCK/W33	363	690	0.0033	0.0402	0.0429
23140 CCK/W33	377	700	0.0035	0.0426	0.0453
23144 CCK/W33	393	773	0.0039	0.0465	0.0492
23148 CCK/W33	378	741	0.0043	0.0500	0.0532
23152 CCK/W33	418	811	0.0046	0.0544	0.0571
23156 CCK/W33	377	721	0.0050	0.0579	0.0607
23160 CCK/W33	409	780	0.0053	0.0619	0.0646
23164 CCK/W33	448	853	0.0057	0.0662	0.0689
23168 CCK/W33	489	900	0.0060	0.0705	0.0733
23172 CACK/W33	473	890	0.0064	0.0745	0.0772
23176 CAK/W33	416	760	0.0067	0.0772	0.0800

\* Values given valid for HMV (C) E series hydraulic nuts equal to bearing size and with one sliding surface (see **Figures b** and **c**). Surfaces lightly oiled with light oil.

\*\* Values given valid for HMV (C) E series hydraulic nuts equal to one size smaller than bearing size and two sliding surfaces (see **Figure e**). Surfaces lightly oiled with light oil.

\*\*\* Values given are valid for one sliding surface (see **Figures b** and **c**). Surfaces lightly oiled with light oil.

\*\*\*\* Values given are valid for two sliding surfaces (see **Figure e**). Surfaces lightly oiled with light oil. The difference in drive-up between one surface and two surfaces is the result of smoothing.

NOTE: To convert values to mm and MPa  $\text{mm} = \text{in} \times 25.4$   $\text{MPa} = \text{psi} \times 0.0069$

Table 5

Pressure and axial drive-up for spherical roller bearings					
SKF bearing designation	Starting position		Final position		
	Hydraulic pressure	Radial clearance reduction from zero position	Axial drive-up from starting position $S_s$		
	1* (psi) 2** (psi)	(in.)	1*** (in.)	2**** (in.)	
<b>232xx series</b>					
23218 CCK/W33	245	447	0.0016	0.0213	0.0244
23220 CCK/W33	278	494	0.0018	0.0229	0.0256
23222 CCK/W33	341	615	0.0019	0.0248	0.0276
23224 CCK/W33	367	647	0.0021	0.0272	0.0299
23226 CCK/W33	371	655	0.0023	0.0288	0.0315
23228 CCK/W33	439	774	0.0025	0.0311	0.0339
23230 CCK/W33	451	792	0.0027	0.0335	0.0362
23232 CCK/W33	477	935	0.0028	0.0355	0.0382
23234 CCK/W33	497	929	0.0030	0.0370	0.0398
23236 CCK/W33	461	863	0.0032	0.0390	0.0418
23238 CCK/W33	471	898	0.0033	0.0410	0.0437
23240 CCK/W33	503	934	0.0035	0.0433	0.0461
23244 CCK/W33	550	1080	0.0039	0.0477	0.0504
23248 ...K/W33	626	1224	0.0043	0.0520	0.0552
23252 ...K/W33	667	1296	0.0046	0.0563	0.0595
23256 ...K/W33	599	1147	0.0050	0.0599	0.0626
23260 ...K/W33	629	1201	0.0053	0.0642	0.0670
23264 ...K/W33	677	1289	0.0057	0.0686	0.0713
23268 ...K/W33	721	1328	0.0060	0.0725	0.0756
23272 ...K/W33	677	1275	0.0064	0.0760	0.0788
23276 ...K/W33	686	1253	0.0067	0.0800	0.0831
<b>239xx series</b>					
23936 CCK/W33	122		0.0032	0.0366	
23938 CCK/W33	104		0.0033	0.0382	
23940 CCK/W33	129		0.0035	0.0406	
23944 CCK/W33	109		0.0039	0.0437	
23948 CCK/W33	93		0.0043	0.0473	
23952 CCK/W33	132		0.0046	0.0516	
23956 CCK/W33	119		0.0050	0.0552	
23960 CCK/W33	154		0.0053	0.0595	
23964 CCK/W33	139		0.0057	0.0626	
23968 CCK/W33	129		0.0060	0.0662	
23972 CCK/W33	116		0.0064	0.0697	
23976 CCK/W33	152		0.0067	0.0741	

Table 5

Pressure and axial drive-up for spherical roller bearings					
SKF bearing designation	Starting position		Final position		
	Hydraulic pressure	Radial clearance reduction from zero position	Axial drive-up from starting position $S_s$		
	1* (psi) 2** (psi)	(in.)	1*** (in.)	2**** (in.)	
<b>240xx series</b>					
24024 CCK30/W33	157	302	0.0021	0.0646	0.0717
24026 CCK30/W33	203	387	0.0023	0.0693	0.0764
24028 CCK30/W33	186	357	0.0025	0.0741	0.0812
24030 CCK30/W33	194	370	0.0027	0.0796	0.0867
24032 CCK30/W33	191	409	0.0028	0.0835	0.0906
24034 CCK30/W33	219	444	0.0030	0.0879	0.0950
24036 CCK30/W33	257	521	0.0032	0.0946	0.1020
24038 CCK30/W33	225	467	0.0033	0.0977	0.1050
24040 CCK30/W33	251	508	0.0035	0.1040	0.1110
24044 CCK30/W33	252	541	0.0039	0.1130	0.1210
24048 CCK30/W33	219	464	0.0043	0.1220	0.1290
24052 CCK30/W33	274	581	0.0046	0.1330	0.1400
24056 CCK30/W33	239	499	0.0050	0.1410	0.1480
24060 ...K30/W33	273	567	0.0053	0.1510	0.1580
24064 CCK30/W33	261	538	0.0057	0.1610	0.1680
24068 CCK30/W33	296	592	0.0060	0.1710	0.1780
24072 CCK30/W33	270	551	0.0064	0.1790	0.1860
24076 CCK30/W33	258	513	0.0067	0.1880	0.1950
<b>241xx series</b>					
24122 CCK30/W33	225	442	0.0019	0.0607	0.0674
24124 CCK30/W33	280	538	0.0021	0.0666	0.0737
24126 CCK30/W33	271	521	0.0023	0.0705	0.0776
24128 CCK30/W33	273	522	0.0025	0.0756	0.0827
24130 CCK30/W33	342	654	0.0027	0.0820	0.0890
24132 CCK30/W33	370	786	0.0028	0.0871	0.0942
24134 CCK30/W33	315	638	0.0030	0.0898	0.0965
24136 CCK30/W33	357	726	0.0032	0.0961	0.1030
24138 CCK30/W33	384	798	0.0033	0.1010	0.1080
24140 CCK30/W33	410	827	0.0035	0.1070	0.1140
24144 CCK30/W33	409	873	0.0039	0.1170	0.1240
24148 CCK30/W33	412	876	0.0043	0.1260	0.1340
24152 CCK30/W33	450	950	0.0046	0.1370	0.1440
24156 CCK30/W33	402	837	0.0050	0.1450	0.1520
24160 CCK30/W33	448	929	0.0053	0.1560	0.1630
24164 CCK30/W33	492	1018	0.0057	0.1670	0.1740
24168 ECAK30/W33	522	1047	0.0060	0.1770	0.1840
24172 ECCK30J/W33	476	974	0.0064	0.1850	0.1920
24176 ECAK30/W33	439	871	0.0067	0.1930	0.2010

\* Values given valid for HMV (C) E series hydraulic nuts equal to bearing size and with one sliding surface (see Figures b and c). Surfaces lightly oiled with light oil.

\*\* Values given valid for HMV (C) E series hydraulic nuts equal to one size smaller than bearing size and two sliding surfaces (see Figure e). Surfaces lightly oiled with light oil.

\*\*\* Values given are valid for one sliding surface (see Figures b and c). Surfaces lightly oiled with light oil.

\*\*\*\* Values given are valid for two sliding surfaces (see Figure e). Surfaces lightly oiled with light oil. The difference in drive-up between one surface and two surfaces is the result of smoothing.

NOTE: To convert values to mm and MPa  $\text{mm} = \text{in} \times 25.4$   $\text{MPa} = \text{psi} \times 0.0069$

## Mounting of CARB® toroidal roller bearings

CARB can accommodate axial displacement within the bearing. This means that the inner ring as well as the roller assembly can be axially displaced in relation to the outer ring. CARB can be secured with lock nuts KMF .. E or KML. If standard KM, AN, or N style lock nuts and locking washers are used instead, a spacer may be needed between the bearing inner ring and the washer to prevent washer contact with the cage, if axial displacement or misalignment are extreme, see **Figure 9**. The spacer dimensions shown in **Figure 10** will help ensure safe operation with axial offset  $\pm 10\%$  of bearing width, and  $0.5^\circ$  misalignment.

Note that both the inner and outer ring must be locked in the axial direction as shown in **Figures 9 and 10**.

**Figure 9**

Axial location and axial displacement

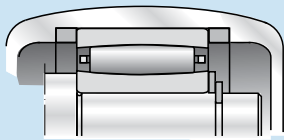

**Figure 10**

Initial axial displacements and spacer dimensions

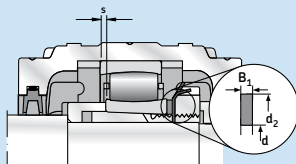

### Spacer dimensions

For mounting with standard KM, AN and N lock nuts and locking washers, as shown in **Figure 10**, spacers with the following dimensions are needed:

$d < 35$ mm	$B1 = 2$ mm
$35 \text{ mm} < d < 120$ mm	$B1 = 3$ mm
$d > 120$ mm	$B1 = 4$ mm

Dimensions  $d$  and  $d_2$  as shown in **Figure 10** must be obtained from the SKF General Catalog, CARB section.

### Axial mounting position

Initial axial displacement of one ring in relation to the other can be used to increase the available axial clearance for shaft movement in one direction, see **Figure 10**.

It is also possible to accurately adjust the radial clearance or the radial position of the bearing by displacing one of the rings. Axial and radial clearance are interdependent, i.e. an axial displacement of one ring from the center position reduces the radial clearance. This principle is shown in **Figure 11** as applied to CARB C 2220.

**Figure 11**

The clearance window for CARB®

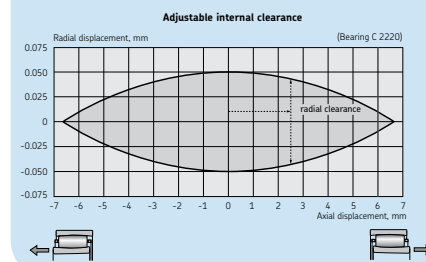

For example, if the axial displacement is 2.5 mm, the radial clearance is reduced from 100 to 90  $\mu\text{m}$  and the radial position of the bearing changes from  $-50$  to  $-45$   $\mu\text{m}$ , (**Figure 11**). For more information please contact SKF.

### Mounting of CARB toroidal roller bearings with cylindrical bore

The same precautions and mounting procedures apply as other bearings with cylindrical bores. See page 13 for the different methods of mounting cylindrical bore CARB.

### Radial clearance reduction method for mounting tapered bore (1:12) CARB on adapter sleeves

#### Precautions

For hollow shafts, please consult SKF Applications Engineering. The bearings should be left in their original packages until immediately before mounting so they do not become dirty. The dimensional and form accuracy of all components, which will be in contact with the bearing, should be checked.

#### Step 1

Remove any burrs or rust on the shaft with an emery cloth or a fine file.

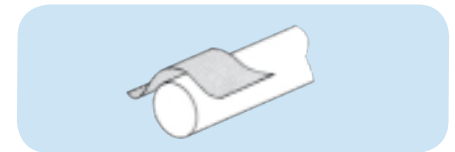

#### Step 2

Wipe the shaft with a clean cloth.



#### Step 3

Measure the shaft diameter.

#### Shaft tolerance limits for adapter mounting seatings

Nominal diameter	Tolerance limits	
	inch over	inch including
1/2	1	0.000 / -0.002
1	2	0.000 / -0.003
2	4	0.000 / -0.004
4	6	0.000 / -0.005
6	-	0.000 / -0.006

#### Step 4

Screw off the locknut from the adapter sleeve assembly and remove the locking washer.

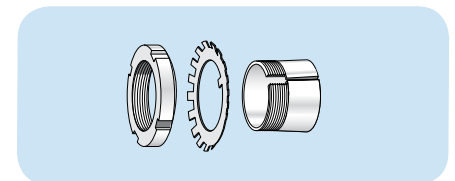

### Step 5

Wipe preservative from the adapter O. D. and bore. Remove oil from the shaft to prevent transfer of oil to the bore of the adapter sleeve.

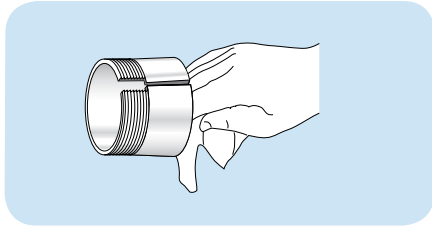

### Step 6

Position the adapter sleeve on the shaft, threads outboard as indicated, to the approximate location with respect to required bearing centerline. For easier positioning of the sleeve, a screwdriver can be placed in the slit to open the sleeve. Applying a light oil to the sleeve outside diameter surface results in easier bearing mounting and removal.

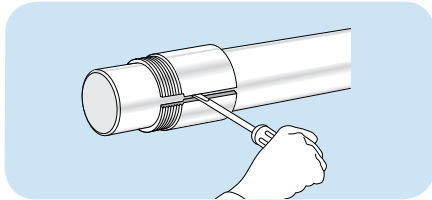

### Step 7

Wipe the preservative from the bore of the bearing. It may not be necessary to remove the preservative from the internal components of the bearing unless the bearing will be lubricated by a circulating oil or oil mist system.

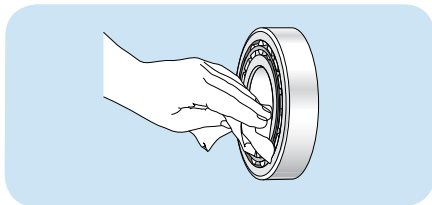

### Step 8

Measure the unmounted radial internal clearance in the bearing. The values for unmounted internal clearance for CARB are provided in **Table 6**.

Oscillate the inner ring in a circumferential direction to properly seat the rollers. Measure the radial internal clearance in the bearing by inserting progressively larger feeler blades the full length of the roller between the most unloaded roller and the

outer ring sphere. **NOTE:** Do not roll completely over a pinched feeler blade, slide through the clearance. It is permissible to rotate a roller up onto the feeler blade but be sure it slides out of the contact area with a slight resistance. Record the measurement on the largest size blade that will slide through. This is the unmounted radial internal clearance.

Repeat this procedure in two or three other locations by resting the bearing on a different spot on its O.D. and measuring over different rollers.

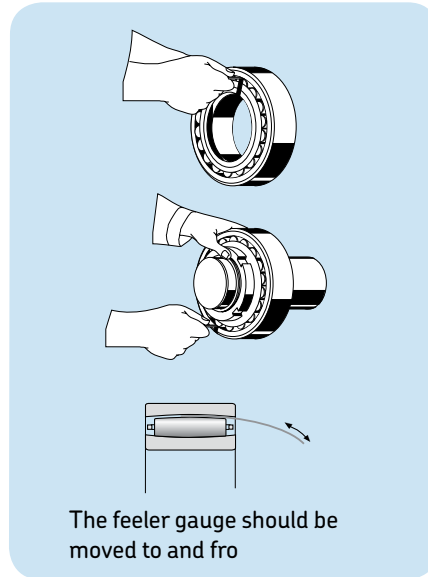

### Step 9

Place the bearing on the adapter sleeve, leading with the large bore of the inner ring to match the taper of the adapter. Apply the locknut with its chamfer facing the bearing (**DO NOT** apply the locking washer at this time because the drive-up procedure may damage the locking washer). Applying a light coating of oil to the chamfered face of the lock nut will make mounting easier. With the bearing hand tight on the adapter sleeve, locate the bearing to the proper axial position on the shaft.

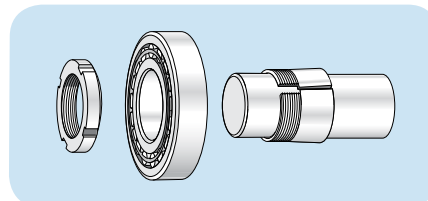

### Step 10

Using a spanner wrench, hand-tighten the locknut so that the sleeve grips the shaft and the adapter sleeve can neither be moved axially, nor rotated on the shaft. With the bearing hand tight on the adapter, locate the bearing to the proper axial position on the shaft.

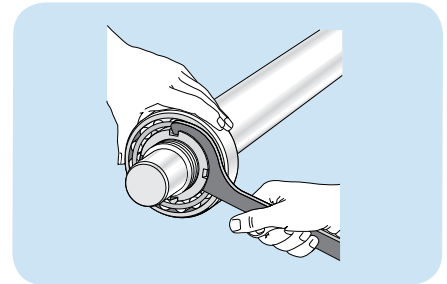

### Step 11

Select the proper radial internal clearance reduction range from **Table 6** on page 31. Using a hammer and a spanner wrench or just a hydraulic nut, begin tightening the locknut in order to drive the inner ring up the tapered seat until the appropriate clearance reduction is achieved. **NOTE:** LARGE SIZE BEARINGS WILL REQUIRE A HEAVY DUTY IMPACT SPANNER WRENCH AND SLEDGE HAMMER TO OBTAIN THE REQUIRED REDUCTION IN RADIAL INTERNAL CLEARANCE. AN SKF HYDRAULIC NUT MAKES MOUNTING OF LARGE SIZE BEARINGS EASIER. Do not attempt to tighten the locknut with hammer and drift. The locknut will be damaged and chips can enter the bearing.

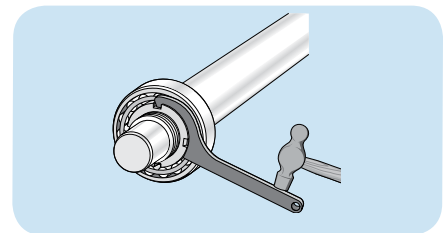



Radial internal clearance (RIC) of CARB® toroidal roller bearings with tapered bore

Bore diameter range d		Unmounted radial internal clearance								Reduction in RIC		Axial drive-up (S) <sup>1</sup> 1:12 taper	
		C2		Normal		C3		C4		min	max	min	max
		min	max	min	max	min	max	min	max	min	max	min	max
mm		inch											
18	24	0.0007	0.0012	0.0012	0.0017	0.0017	0.0022	0.0022	0.0027	0.0004	0.0006	0.0083	0.0114
25	30	0.0009	0.0015	0.0015	0.0020	0.0020	0.0026	0.0026	0.0032	0.0005	0.0007	0.0098	0.0134
31	40	0.0011	0.0018	0.0018	0.0024	0.0024	0.0031	0.0031	0.0039	0.0006	0.0009	0.0118	0.0165
41	50	0.0013	0.0021	0.0021	0.0029	0.0029	0.0037	0.0037	0.0046	0.0008	0.0012	0.0146	0.0201
51	65	0.0017	0.0025	0.0025	0.0035	0.0035	0.0044	0.0044	0.0058	0.0010	0.0015	0.0173	0.0252
66	80	0.0020	0.0031	0.0031	0.0043	0.0043	0.0054	0.0054	0.0069	0.0013	0.0019	0.0213	0.0299
81	100	0.0025	0.0038	0.0038	0.0052	0.0052	0.0068	0.0068	0.0086	0.0016	0.0024	0.0256	0.0366
101	120	0.0030	0.0045	0.0045	0.0061	0.0061	0.0079	0.0079	0.0100	0.0020	0.0028	0.0311	0.0433
121	140	0.0035	0.0053	0.0053	0.0071	0.0071	0.0091	0.0091	0.0116	0.0024	0.0033	0.0366	0.0500
141	160	0.0041	0.0061	0.0061	0.0083	0.0083	0.0106	0.0106	0.0133	0.0028	0.0038	0.0421	0.0567
161	180	0.0046	0.0068	0.0068	0.0094	0.0094	0.0119	0.0119	0.0150	0.0031	0.0043	0.0476	0.0634
181	200	0.0051	0.0076	0.0076	0.0102	0.0102	0.0130	0.0130	0.0164	0.0035	0.0047	0.0535	0.0701
201	225	0.0057	0.0084	0.0084	0.0113	0.0113	0.0143	0.0143	0.0181	0.0039	0.0053	0.0591	0.0783
226	250	0.0063	0.0093	0.0093	0.0124	0.0124	0.0158	0.0158	0.0201	0.0044	0.0059	0.0657	0.0866
251	280	0.0069	0.0102	0.0102	0.0135	0.0135	0.0175	0.0175	0.0219	0.0049	0.0067	0.0728	0.0969
281	315	0.0078	0.0111	0.0111	0.0148	0.0148	0.0189	0.0189	0.0243	0.0055	0.0075	0.0811	0.1083
316	355	0.0088	0.0125	0.0125	0.0165	0.0165	0.0213	0.0213	0.0267	0.0062	0.0085	0.0909	0.1217
356	400	0.0099	0.0138	0.0138	0.0185	0.0185	0.0235	0.0235	0.0296	0.0070	0.0094	0.1020	0.1366
401	450	0.0111	0.0151	0.0151	0.0207	0.0207	0.0257	0.0257	0.0329	0.0079	0.0106	0.1146	0.1535
451	500	0.0120	0.0171	0.0171	0.0226	0.0226	0.0289	0.0289	0.0359	0.0089	0.0118	0.1283	0.1701
501	560	0.0132	0.0187	0.0187	0.0249	0.0249	0.0316	0.0316	0.0396	0.0098	0.0132	0.1421	0.1902
561	630	0.0150	0.0209	0.0209	0.0276	0.0276	0.0349	0.0349	0.0437	0.0110	0.0150	0.1591	0.2134
631	710	0.0166	0.0232	0.0232	0.0304	0.0304	0.0388	0.0388	0.0484	0.0124	0.0167	0.1783	0.2402
711	800	0.0189	0.0265	0.0265	0.0339	0.0339	0.0433	0.0433	0.0543	0.0140	0.0189	0.2008	0.2701
801	900	0.0208	0.0289	0.0289	0.0376	0.0376	0.0478	0.0478	0.0600	0.0157	0.0213	0.2256	0.3035
901	1000	0.0228	0.0320	0.0320	0.0409	0.0409	0.0528	0.0528	0.0657	0.0177	0.0236	0.2535	0.3370
1,001	1120	0.0254	0.0352	0.0352	0.0459	0.0459	0.0589	0.0589	0.0738	0.0197	0.0264	0.2811	0.3768
1,121	1250	0.0278	0.0384	0.0384	0.0502	0.0502	0.0644	0.0644	0.0809	0.0220	0.0295	0.3150	0.4213

1. Valid only for solid tapered shafts.

CAUTION: Do not use the maximum reduction of radial internal clearance when the initial unmounted radial internal clearance is in the lower half of the tolerance range or where large temperature differentials between the bearing rings can occur in operation.

### Step 12

Remove the locknut and install the locking washer on the adapter sleeve. The inner prong of the locking washer should face the bearing and be located in the slot of the adapter sleeve. Reapply the locknut until tight. (DO NOT drive the bearing further up the taper, as this will reduce the radial internal clearance further).

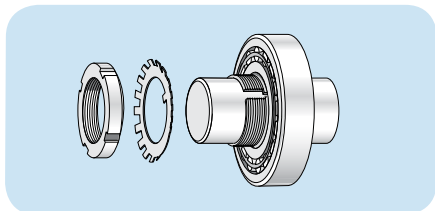

### Step 13

Find the locking washer tang that is nearest a locknut slot. If the slot is slightly past the tang don't loosen the nut, but instead tighten it to meet the closest locking washer tang. Do not bend the locking tab to the bottom of the locknut slot.

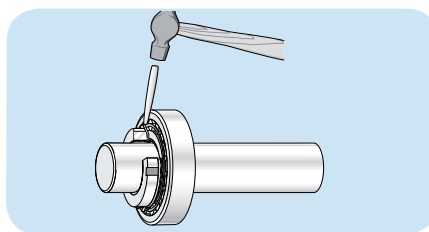

### Step 14

Check that the shaft and outer ring can be rotated easily by hand.

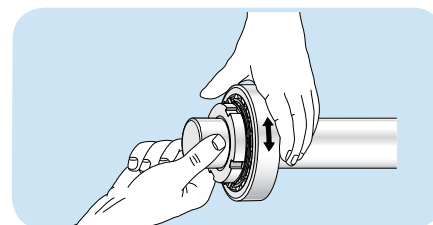

## Radial clearance reduction method for mounting tapered bore (1:12) CARB® toroidal bearings onto a tapered shaft

### Precautions

For hollow shafts, please consult SKF Applications Engineering. The bearings should be left in their original packages until immediately before mounting so they do not become dirty. The dimensional and form accuracy of all components, which will be in contact with the bearing, should be checked.

### Step 1

Remove any burrs or rust on the shaft with an emery cloth or a fine file.

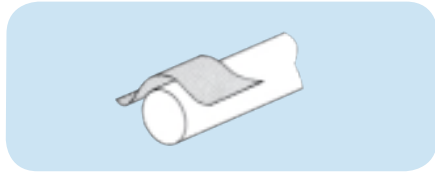

### Step 2

Wipe the shaft with a clean cloth.



### Step 3

Measure the shaft taper for geometry and contact using taper gauges.

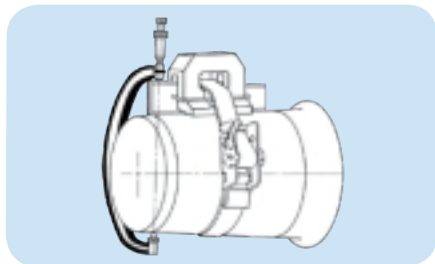

### Step 4

Wipe the preservative from the bore of the bearing. It may not be necessary to remove the preservative from the internal components of the bearing unless the bearing will be lubricated by a circulating oil or oil mist system.

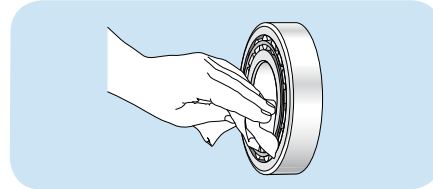

### Step 5

Measure the unmounted radial internal clearance in the bearing. The values for unmounted internal clearance for tapered bore CARB are provided in **Table 6** on page 31. Oscillate the inner ring in a circumferential direction to properly seat the rollers. Measure the radial internal clearance in the bearing by inserting progressively larger feeler blades the full length of the roller between the most unloaded roller and the outer ring sphere. **NOTE:** Do not roll completely over a pinched feeler blade, slide through the clearance. It is permissible to rotate a roller up onto the feeler blade but be sure it slides out of the contact area with a slight resistance. Record the measurement on the largest size blade that will slide through. This is the unmounted radial internal clearance.

Repeat this procedure in two or three other locations by resting the bearing on a different spot on its O.D. and measuring over different rollers.

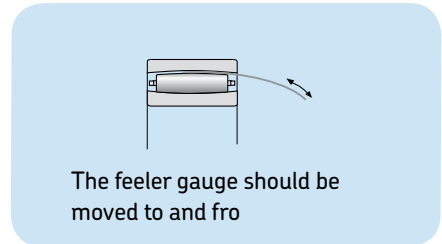
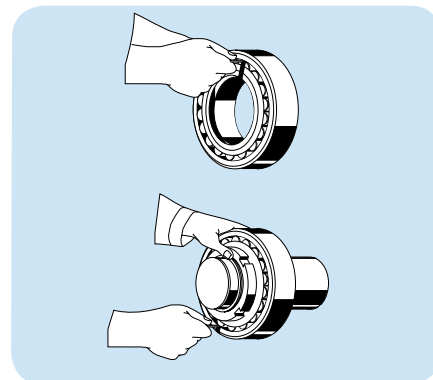

### Step 6

Place the bearing on the tapered shaft, leading with the large bore of the inner ring to match the taper of the shaft. Apply the locknut with its chamfer facing the bearing (DO NOT apply the locking washer at this time because the drive-up procedure may damage the locking washer). Applying a light coating of oil to the chamfered face of the lock nut will make mounting easier.

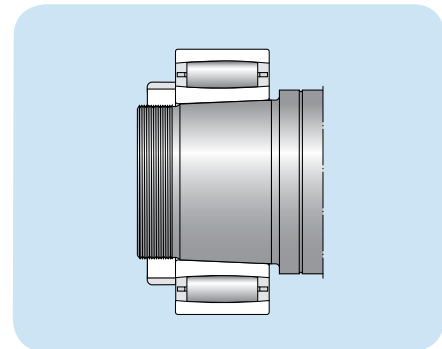

### Step 7

Select the proper radial internal clearance reduction range from **Table 6** on page 31. Using a hammer and a spanner wrench or just a hydraulic nut, begin tightening the nut in order to drive the inner ring up the tapered shaft until the appropriate clearance reduction is achieved. **NOTE:** LARGE SIZE BEARINGS WILL REQUIRE A HEAVY DUTY IMPACT SPANNER WRENCH AND SLEDGE HAMMER TO OBTAIN THE REQUIRED REDUCTION IN RADIAL INTERNAL CLEARANCE. AN SKF HYDRAULIC NUT MAKES MOUNTING OF LARGE SIZE BEARINGS EASIER. Do not attempt to tighten the locknut with a hammer and drift. The locknut will be damaged and chips can enter the bearing.

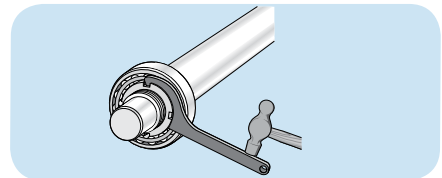

### Step 8

Remove the locknut and install the locking washer on the shaft. The inner prong of the locking washer should face the bearing and be located in the keyway. Reapply the locknut until tight. (DO NOT drive the bearing further up the taper as this will reduce the radial internal clearance further).

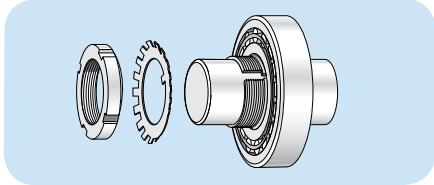

### Step 9

Find the locking washer tang that is nearest a locknut slot. If the slot is slightly past the tang don't loosen the nut, but instead tighten it to meet the closest locking washer tang. Do not bend the locking tab to the bottom of the locknut slot.

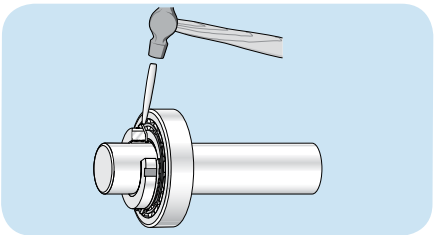

### Step 10

Check that the shaft and outer ring can be rotated easily by hand.

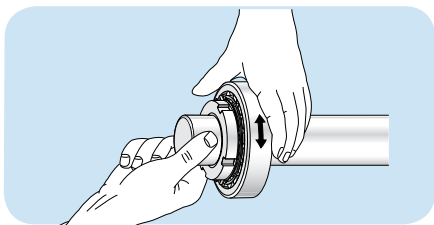

## Angular drive-up method for mounting tapered bore (1:12) CARB toroidal bearings on an adapter sleeve.

The angular drive-up method simplifies the mounting process by equating axial drive up to the rotation of a locknut. By knowing the threads per inch of a locknut, the number of rotations to achieve a specific axial movement can be determined. In order to make this mounting method work properly, the starting point is important since that is the reference point to determine when to start counting the rotation of the locknut.

### Precautions

The bearings should be left in their original packages until immediately before mounting so they do not become dirty. The dimensional and form accuracy of all components, which will be in contact with the bearing, should be checked.

### Step 1

Remove any burrs or rust on the shaft with an emery cloth or a fine file.

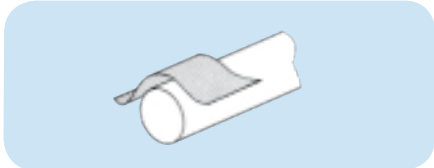

### Step 2

Wipe the shaft with a clean cloth.



### Step 3

Measure the shaft diameter.

#### Shaft tolerance limits for adapter mounting seatings

Nominal diameter	Tolerance limits	
	inch over	inch including
1/2	1	0.000 / -0.002
1	2	0.000 / -0.003
2	4	0.000 / -0.004
4	6	0.000 / -0.005
6	-	0.000 / -0.006

### Step 4

Screw off the nut from the adapter sleeve assembly and remove the locking washer.

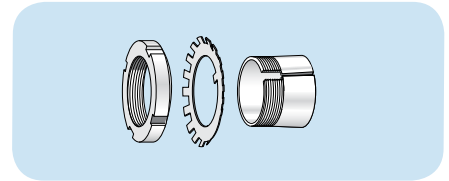

### Step 5

Wipe preservative from the adapter O. D. and bore. Remove oil from the shaft to prevent transfer of oil to the bore of the adapter sleeve.

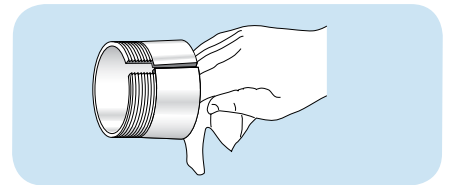

### Step 6

Position the adapter sleeve on the shaft, threads outboard as indicated, to the approximate location with respect to required bearing centerline. For easier positioning of the sleeve, a screwdriver can be placed in the slit to open the sleeve. Applying a light oil to the sleeve outside diameter surface results in easier bearing mounting and removal.

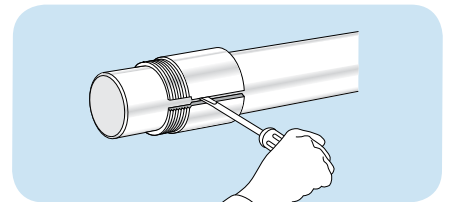

### Step 7

Wipe the preservative from the bore of the bearing. It may not be necessary to remove the preservative from the internal components of the bearing unless the bearing will be lubricated by a circulating oil or oil mist system.

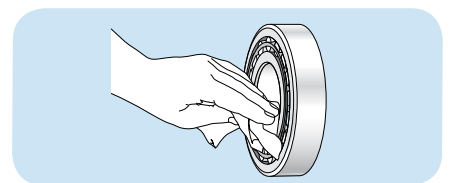

### Step 8

Place the bearing on the adapter sleeve, leading with the large bore of the inner ring to match the taper of the adapter. Apply the locknut with its chamfer facing the bearing (DO NOT apply the locking washer at this time because the drive-up procedure may damage the locking washer). Applying a light coating of oil to the chamfered face of the lock nut will make mounting easier.

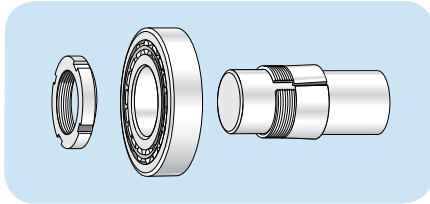

### Step 9

Using a spanner wrench, hand-tighten the locknut so that the sleeve grips the shaft and the adapter sleeve can neither be moved axially, nor rotated on the shaft. With the bearing hand tight on the adapter, locate the bearing hand tight on the adapter, locate the bearing to the proper axial position on the shaft. A method for checking if the bearing and sleeve are properly clamped is to place a screwdriver in the adapter sleeve split on the large end of the sleeve. Applying pressure to the screwdriver to attempt to turn the sleeve around the shaft is a good check to determine if the sleeve is clamped down properly. If the sleeve no longer turns on the shaft, then the zero point has been reached. Do not drive the bearing up any further.

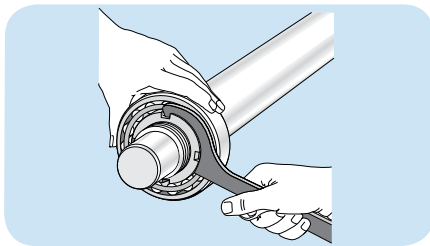

### Step 10

Place a reference mark on the locknut face and shaft, preferably in the 12 o'clock position, to use when measuring the tightening angle.

### Step 11

Locate the specific bearing part number in **Table 7**. Note the specific lock nut part number on the adapter sleeve to determine if it is an inch or metric assembly. Once the appropriate locknut part number has been obtained, select the corresponding tightening angle from **Table 7** on page 35.

### Step 12

Using a hammer and a spanner wrench, begin tightening the locknut the corresponding tightening angle. **NOTE: LARGE SIZE BEARINGS WILL REQUIRE A HEAVY DUTY IMPACT SPANNER WRENCH AND SLEDGE HAMMER TO OBTAIN THE REQUIRED REDUCTION IN RADIAL INTERNAL CLEARANCE.** Do not attempt to tighten the locknut with hammer and drift. The locknut will be damaged and chips can enter the bearing.

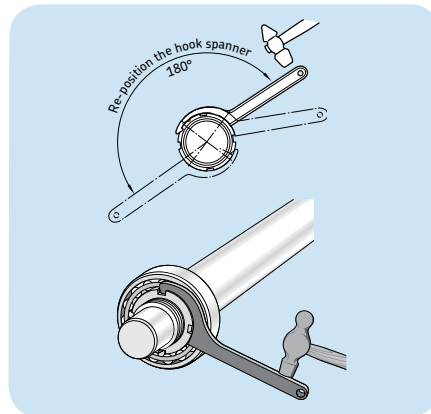

### Step 13

Remove the locknut and install the locking washer on the adapter sleeve. The inner prong of the locking washer should face the bearing and be located in the slot of the adapter sleeve. Reapply the locknut until tight. (DO NOT drive the bearing further up the taper, as this will reduce the radial internal clearance further).

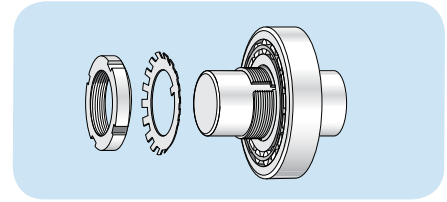

### Step 14

Find the locking washer tang that is nearest a locknut slot. If the slot is slightly past the tang don't loosen the nut, but instead tighten it to meet the closest locking washer tang. Do not bend the locking tab to the bottom of the locknut slot.

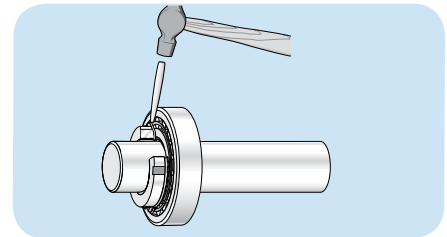

### Step 15

Check that the shaft and outer ring can be rotated easily by hand.

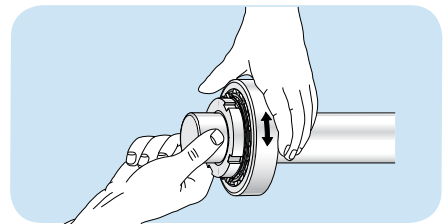

Table 7

## Angular drive-up for CARB® toroidal roller bearings (metric and inch nuts)

Bearing designation	Bearing bore diameter d	Axial drive-up s	Metric nut designation	Turning angle $\alpha$	Inch nut designation	Turning angle $\alpha$
	(mm)	(mm)		(degrees)		(degrees)
<b>22xx series</b>						
C 2205 K	25	0.25	KM(FE) 5	100	N 05	190
C 2206 K	30	0.25	KM(FE) 6	105	N 06	115
C 2207 K	35	0.30	KM(FE) 7	115	N 07	120
C 2208 K	40	0.30	KM(FE) 8	125	N 08	135
C 2209 K	45	0.37	KM(FE) 9	130	N 09	140
C 2210 K	50	0.37	KM(FE) 10	140	N 10	150
C 2211 K	55	0.44	KM(FE) 11	110	N 11	155
C 2212 K	60	0.44	KM(FE) 12	115	N 12	165
C 2213 K	65	0.44	KM(FE) 13	120	N 13	170
C 2214 K	70	0.54	KM(FE) 14	125	N 14	175
C 2215 K	75	0.54	KM(FE) 15	130	AN 15	120
C 2216 K	80	0.54	KM(FE) 16	140	AN 16	130
C 2217 K	85	0.65	KM(FE) 17	145	AN 17	135
C 2218 K	90	0.65	KM(FE) 18	150	AN 18	145
C 2219 K	95	0.65	KM(FE) 19	150	AN 19	150
C 2220 K	100	0.65	KM(FE) 20	155	AN 20	160
C 2222 K	110	0.79	KM(FE) 22	170	AN 22	160
C 2224 K	120	0.79	KM 24	180	AN 24	170
<b>23xx series</b>						
C 2314 K	70	0.54	KM(FE) 14	130	N 14	185
C 2315 K	75	0.54	KM(FE) 15	135	AN 15	130
C 2316 K	80	0.54	KM(FE) 17	140	AN 16	135
C 2317 K	85	0.65	KM(FE) 18	145	AN 17	140
C 2318 K	90	0.65	KM(FE) 19	155	AN 18	145
C 2319 K	95	0.65	KM(FE) 20	155	AN 19	150
C 2320 K	100	0.65	KM(FE) 21	160	AN 20	155

For sizes greater than those shown above we recommend the use of the SKF Hydraulic drive-up method.  
For threads per inch see **Table 2** (page 17).

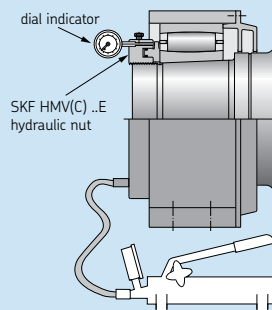

Figure 12

## SKF hydraulic (axial) drive-up method for tapered bore (1:12) CARB toroidal bearings on an adapter sleeve.

The axial drive-up method relies on the bearing being driven up a tapered seat a specific amount in order to ensure the inner ring is expanded enough to properly clamp the shaft or sleeve. In order for this method to work properly, the starting point is important since that is the reference point to determine when the bearing has been driven up enough. A new method of accurately achieving this starting point has been developed by SKF and is now available. The method incorporates the use of an SKF hydraulic nut, HMV(C) .. E fitted with a dial indicator and a specially calibrated pressure gauge, mounted on a selected pump. The equipment is shown in **Figure 12** below. The required pressure for each CARB bearing is given in **Table 8**, page 37. This enables accurate positioning of the bearing at the starting point, from where the axial drive-up (s) is measured. **Table 8** also provides the required psi pressures required for each.

1. Reduced time to mount bearings.
2. A reliable, safe and accurate method of clearance adjustment.

### Precautions

For hollow shafts, please consult SKF Applications Engineering. The bearings should be left in their original packages until immediately before mounting so they do not become dirty. The dimensional and form accuracy of all components, which will be in contact with the bearing, should be checked.

#### Step 1

Remove any burrs or rust on the shaft with an emery cloth or a fine file.

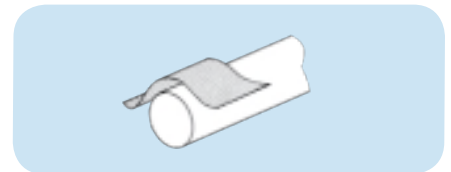

#### Step 2

Wipe the shaft with a clean cloth.



### Step 3

Measure the shaft diameter.

#### Shaft tolerance limits for adapter mounting seatings

Nominal diameter		Tolerance limits
inch over	including	
1/2	1	0.000 / -0.002
1	2	0.000 / -0.003
2	4	0.000 / -0.004
4	6	0.000 / -0.005
6	-	0.000 / -0.006

### Step 4

Remove the locknut and locking washer from the adapter sleeve assembly.

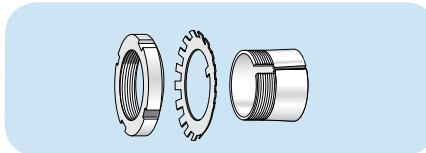

### Step 5

Wipe preservative from the adapter O. D. and bore. Remove oil from the shaft to prevent transfer of oil to the bore of the adapter sleeve.

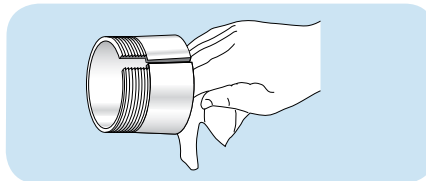

### Step 6

Position the adapter sleeve on the shaft, threads outboard as indicated, to the approximate location with respect to required bearing centerline. For easier positioning of the sleeve, a screwdriver can be placed in the slit to open the sleeve.

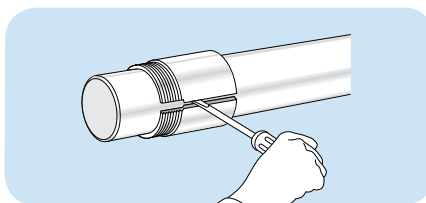

### Step 7

Applying a light oil to the sleeve outside diameter surface results in easier bearing mounting and removal. Wipe the preservative from the bore of the bearing. It may not be necessary to remove the preservative from the internal components of the bearing unless the bearing will be lubricated by a circulating oil or oil mist system.

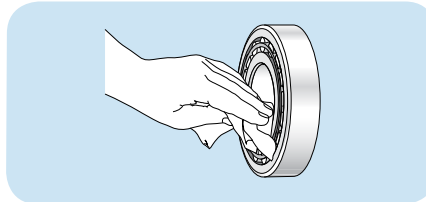

### Step 8

Place the bearing on the adapter sleeve leading with the large bore of the inner ring to match the taper of the adapter. Apply the hydraulic nut (DO NOT apply the locking washer at this time). Ensure that the bearing size is equal to the hydraulic nut. Otherwise, the pressure in the table must be adjusted. Drive the bearing up to the starting position by applying the hydraulic pressure listed in Starting Position 1\* in **Table 8** for the specific bearing size being mounted. Monitor the pressure by the gauge on the selected pump. As an alternative, SKF mounting gauge TMJG 100D can be screwed directly into the hydraulic nut.

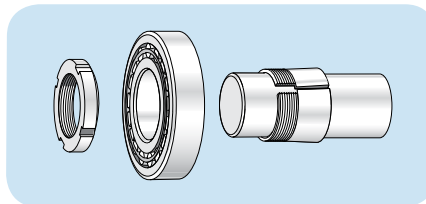

### Step 9

Drive the bearing up the adapter sleeve the required distance  $S_5$  shown under column heading 1\*\*\* of **Table 8**. The axial drive-up is best monitored by a dial indicator.

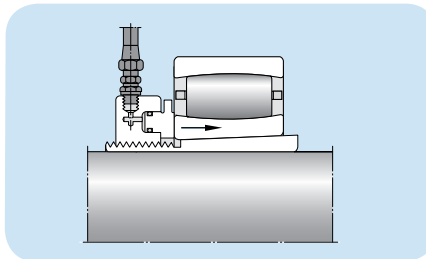

### Step 10

Remove the hydraulic nut and install the locking washer on the adapter sleeve. The inner prong of the locking washer should face the bearing and be located in the slot of the adapter sleeve. Reapply the locknut until tight. (DO NOT drive the bearing further up the taper, as this will reduce the radial internal clearance further).

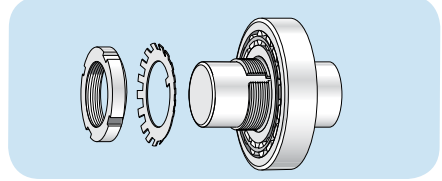

### Step 11

Find the locking washer tang that is nearest a locknut slot. If the slot is slightly past the tang don't loosen the nut, but instead tighten it to meet the closest locking washer tang. Do not bend the locking tab to the bottom of the locknut slot.

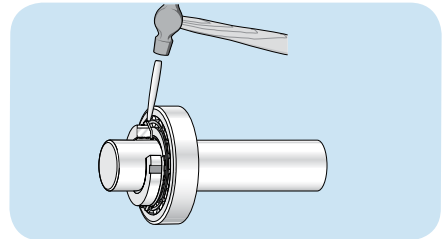

### Step 12

Check that the shaft and outer ring can be rotated easily by hand.

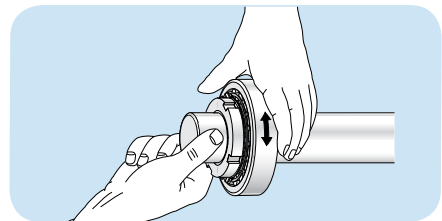

Pressure and axial drive-up for CARB toroidal roller bearings with tapered bore

SKF bearing designation	Starting position		Final position			SKF bearing designation	Starting position		Final position		
	Hydraulic pressure		Radial clearance reduction from zero position	Axial drive-up from starting position $S_s$			Hydraulic pressure		Radial clearance reduction from zero position	Axial drive-up from starting position $S_s$	
	1* (psi)	2** (psi)	(in.)	1*** (in.)	2**** (in.)		1* (psi)	2** (psi)	(in.)	1*** (in.)	2**** (in.)
<b>C 22xx series</b>					<b>C 31xx series</b>						
C 2210 K	97	185	0.0009	0.0126	0.0154	C 3130 K	349	613	0.0027	0.0331	0.0359
C 2211 K	83	154	0.0010	0.0138	0.0165	C 3132 K	300	589	0.0028	0.0343	0.0370
C 2212 K	158	283	0.0011	0.0154	0.0181	C 3136 K	247	464	0.0032	0.0370	0.0398
C 2213 K	119	222	0.0011	0.0158	0.0185	C 3140 K	393	731	0.0035	0.0426	0.0457
C 2214 K	110	199	0.0013	0.0169	0.0197	C 3144 K	400	787	0.0039	0.0465	0.0496
C 2215 K	102	183	0.0013	0.0173	0.0250	C 3148 K	291	571	0.0043	0.0489	0.0516
C 2216 K	149	268	0.0014	0.0189	0.0217	C 3152 K	400	777	0.0046	0.0540	0.0567
C 2217 K	162	290	0.0015	0.0197	0.0225	C 3156 K	381	731	0.0050	0.0579	0.0607
C 2218 K	197	358	0.0016	0.0217	0.0244	C 3160 K	407	777	0.0053	0.0619	0.0646
C 2220 K	162	287	0.0018	0.0221	0.0252	C 3164 K	303	576	0.0057	0.0634	0.0662
C 2222 K	216	390	0.0019	0.0244	0.0272	C 3168 K	386	712	0.0060	0.0686	0.0713
C 2226 K	209	368	0.0023	0.0276	0.0303	<b>C 32xx series</b>					
C 2228 K	342	603	0.0025	0.0311	0.0339	C 3224 K	357	629	0.0021	0.0268	0.0299
C 2230 K	260	454	0.0027	0.0323	0.0351	C 3232 K	389	761	0.0028	0.0343	0.0370
C 2234 K	374	697	0.0030	0.0370	0.0398	C 3236 K	535	1001	0.0032	0.0398	0.0429
C 2238 K	257	489	0.0033	0.0390	0.0422	<b>C 40xx series</b>					
C 2244 K	283	557	0.0039	0.0453	0.0481	C 4028 K30	180	345	0.0025	0.0741	0.0812
<b>C 23xx series</b>					C 4032 K						
C 2314 K	291	525	0.0013	0.0177	0.0209	152	325	0.0028	0.0820	0.0890	
C 2315 K	326	587	0.0013	0.0189	0.0217						
C 2316 K	306	550	0.0014	0.0193	0.0221						
C 2317 K	348	622	0.0015	0.0205	0.0232						
C 2318 K	418	760	0.0016	0.0225	0.0252						
C 2319 K	323	574	0.0017	0.0225	0.0252						
C 2320 K	371	658	0.0018	0.0232	0.0260						
<b>C 30xx series</b>											
C 3036 K	207	389	0.0032	0.0374	0.0402						
C 3038 K	232	442	0.0033	0.0398	0.0426						
C 3040 K	235	435	0.0035	0.0418	0.0445						
C 3044 K	229	450	0.0039	0.0453	0.0481						
C 3048 K	194	380	0.0043	0.0485	0.0512						
C 3052 K	257	499	0.0046	0.0532	0.0559						
C 3056 K	245	470	0.0050	0.0571	0.0599						
C 3060 K	261	499	0.0053	0.0611	0.0638						
C 3064 K	261	497	0.0057	0.0650	0.0678						
C 3068 K	296	545	0.0060	0.0689	0.0721						
C 3092 K	290	526	0.0081	0.0918	0.0946						

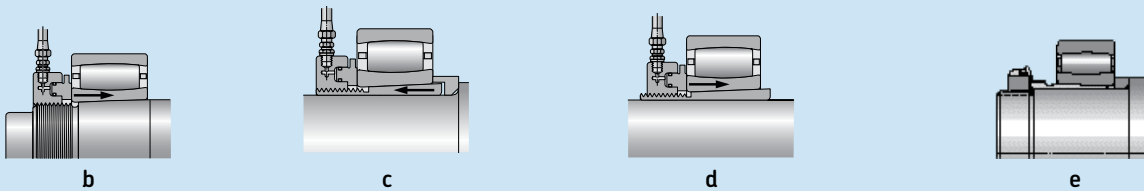
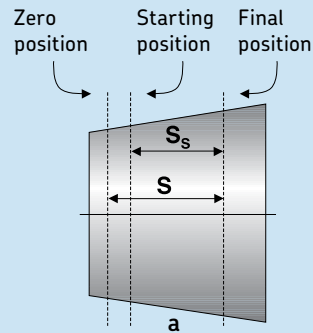

\* Values given valid for HMV (C) E series hydraulic nuts equal to bearing size and with one sliding surface (see **Figures b and c**). Surfaces lightly oiled with light oil.  
 \*\* Values given valid for HMV (C) E series hydraulic nuts equal to one size smaller than bearing size and two sliding surfaces (see **Figure e**). Surfaces lightly oiled with light oil.  
 \*\*\* Values given are valid for one sliding surface (see **Figures b and c**). Surfaces lightly oiled with light oil.  
 \*\*\*\* Values given are valid for two sliding surfaces (see **Figure e**). Surfaces lightly oiled with light oil. The difference in drive-up between one surface and two surfaces is the result of smoothing.

NOTE: To convert values to mm and MPa mm = in x 25.4 MPa = psi x 0.0069

# Assembly instructions for pillow block housings

## SAF and SAFS series

**WARNING:** Read these instructions before starting work. Failure to follow these instructions could result in injury or damage such as catastrophic premature bearing failure. Be careful with heavy weight and tools and other devices, and with high pressure oil when using the hydraulic assist method. Be familiar with the MSDS or other safety instructions for any grease or oil used and keep them nearby.

### Step 1

Remove any burrs or rust on the shaft with an emery cloth or a fine file.

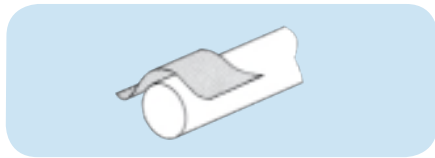

### Step 2

Wipe the shaft with a clean cloth.

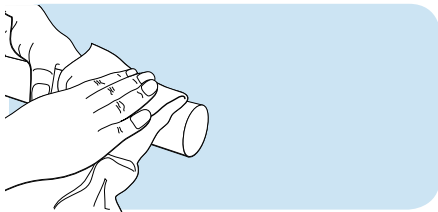

### Step 3

Check shaft diameter.

Table 9

Dia. tol. for adapter & cylindrical bore mounted shaft extensions			
Nominal dia. inches		Dia. tolerance limits inches	
over	including	S-1	S-2 & S-3
1	2	0.000 -0.003	0.000 -0.003
2	4	0.000 -0.004	0.000 -0.003
4	6	0.000 -0.005	0.000 -0.003
6	10	0.000 -0.006	0.000 -0.004
10	15	0.000 -0.006	0.000 -0.005
15	—	0.000 -0.006	0.000 -0.006

**Note:** S1 refers to the shaft tolerance for an adapter mounted bearing. S2 and S3 refer to the shaft tolerance under the seal for a cylindrical mounted bearing, not the bearing seat diameter. For bearing seat diameter tolerances, refer to the Shaft and Housing Fits Section of this catalog on page 57.

### Step 4

Install inboard seal.

#### PosiTrac (LOR) and PosiTrac Plus seal

Slide the seal onto the shaft. The resistance should only require slight hand pressure to overcome. The O-ring can be lubricated with grease or oil to ease assembly. Locate the seal to match the labyrinths in the housing. The old style LER labyrinth seal still used for small shaft diameters is installed in the same manner. The picture shows the PosiTrac Plus seal, which requires greasing the seal lip at assembly. See PosiTrac Plus Assembly Instructions for more information (Publication 655-810), which is included with the B-10724 contact element. SKF's next generation M5 style SAF housings have the external labyrinth painted for improved corrosion resistance. Removal of this paint is not recommended.

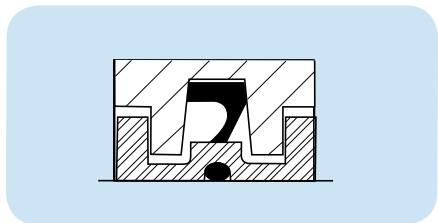

#### Taconite (TER) seal

Coat the shaft with oil. Smear grease in the bore of the seal cartridge, filling the cavity between seals, and lubricating the bore of the felt seal and the lip of the contact seal. Fill the TER seal cavity with grease. If the end of the shaft does not have a lead-in bevel, smooth the bore of the felt seal with a flat instrument to aid in starting the felt seal over the end of the shaft. Carefully slide the seal cartridge assembly on the shaft to approximate assembly position. **Note:** Make sure the lobes of the rubber extrusion on the outside diameter of the taconite seal are not located at the split of the housing; to ensure this occurs, the grease fitting should

be at 12 or 6 o'clock. For seal misalignment capabilities, see **Table 12**.



### Step 5

Mount the bearing.

**Note:** Several mounting methods exist. Refer to the beginning of this section for specific mounting instructions for the specific bearing being used in the housing. Please consult SKF for alternative instructions or reference [www.skf.com/mount](http://www.skf.com/mount).

### Step 6

Install outboard seal (same as step 4).

### Step 7

#### Lower half of housing (Base)

Set the bases on their mounting surface and lightly oil the bearing seats. SKF's M5 style SAF housings have painted base-planes. Removal of this paint is not required prior to installation. If grease is used as a lubricant, it should be applied before the upper half of the housing is secured. Smear grease between the rolling elements of the bearing and work it in until the bearing is 100% full. The base should be packed 1/3 to 1/2 full of grease. See **Table 10** for initial grease fill. For M5 style SAF housings, there is a cast line in the housing base that can be used as a grease fill line (fill to the bottom of the line). See **Figure 13**.

Place the shaft with bearings into the base, carefully guiding the seals into the seal grooves. Be certain that the bearings' outer rings sit squarely in the housing bearing seats. Bolt the "held" housing securely in place (see step 8). The "free" bearing housing will be located and bolted to its mounting surface after the "free" bearing is properly positioning in the "free" housing to ensure correct float. **Note:** If shimming is required, shims must cover the full mounting surface of the base.



Table 10

Initial grease charge for SAF pillow block assemblies

SAF	SAF	SAF	SAF	SAF	Initial charge	
					oz.	lbs.
—	—	507	—	—	2 <sup>1</sup> / <sub>2</sub>	
—	—	509	—	—	3	
—	—	510	—	—	4	
—	308	—	—	—	4 <sup>1</sup> / <sub>2</sub>	
—	309	—	609	—	5	
—	—	511	—	—	5	
—	310	—	610	—	6 <sup>1</sup> / <sub>2</sub>	
—	—	513	—	—	7 <sup>1</sup> / <sub>2</sub>	
—	311	—	611	—	8	
—	—	515	—	—	9	
—	312	—	—	—	10	
216	313	516	613	—	13	
217	—	517	—	—	13	
—	314	—	—	—	14	
218	315	518	615	—	14	
—	316	—	616	—	16	
—	317	—	617	—	20	
220	—	520	—	024	21	
—	318	—	618	—	22	
222	—	522	—	026	28	
224	320	524	620	028	40	
226	322	526	622	030	3 <sup>1</sup> / <sub>4</sub>	
—	—	—	—	032	3 <sup>1</sup> / <sub>4</sub>	
228	—	528	—	034	3 <sup>1</sup> / <sub>4</sub>	
230	324	530	624	—	3 <sup>3</sup> / <sub>4</sub>	
232	326	532	626	036	4 <sup>1</sup> / <sub>4</sub>	
—	—	—	—	038	4 <sup>1</sup> / <sub>4</sub>	
234	328	534	628	040	5 <sup>1</sup> / <sub>4</sub>	
236	330	536	630	—	6	
238	332	538	632	044	7 <sup>1</sup> / <sub>4</sub>	
240	334	540	634	048	8 <sup>1</sup> / <sub>2</sub>	
244	338	544	638	052	11 <sup>1</sup> / <sub>2</sub>	
—	340	—	640	056	15 <sup>1</sup> / <sub>2</sub>	

**Note:** There must be only one “held” bearing per shaft. One bearing should be “free” to permit shaft expansion. Some housings require two stabilizing rings, which must be inserted to obtain a “held” assembly with the bearing centered in the housing. Stabilizing rings enclosed in standard housings are intended for spherical roller bearings or CARB. A different stabilizing ring is required for self-aligning ball bearings (purchased separately).

**Step 9**

*Upper half housing (Cap)*

The bearing seat in the cap should be thoroughly cleaned, lightly oiled and placed over the bearing. With oil lubrication, use a sealing compound such as Permatex 2 or equivalent at the split surfaces; apply sparingly. Wipe a thin film near the outer edges. Excessive amounts may get forced between the housing bore and bearing outside diameter. This can pinch an outer ring or make a “free” bearing actually “held”.

Two dowel pins will align the cap to its mating base. **Note:** Caps and bases of housings are not interchangeable. Each cap and base must be assembled with its original mating part. All SKF SAF and SAFS split housings are match marked with serialized identification on the cap and base to assist in assembling of mating parts. To complete the assembly, the lockwashers and cap bolts are then applied and tightened to the proper tightening torque for the specific cap bolts. See **Table 11** and **Figure 14**. The rubber plug and plastic fitting in the cap holes of M5 style SAF housings should be removed and discarded. Replace with appropriate metallic plugs/fittings that are supplied with each SKF M5 style SAF housing.

Figure 13

Grease fill line

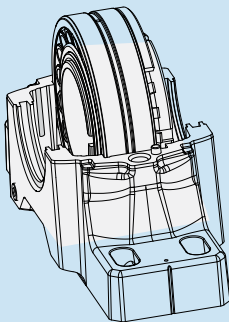

**Step 8**

*Stabilizing rings*

A stabilizing ring should be used if a spherical roller or self-aligning ball bearing is to be “Held” or “Fixed” (i.e. locating the shaft). The stabilizing ring should also be used for all toroidal roller bearing (CARB) units. In cases when only one locating ring is used, move the shaft axially so that the stabilizing ring can be inserted between the bearing outer ring and housing shoulder on the locknut side of bearing, where practical. For bearings that will be free to float in the housing, generally center the bearings in the housing seat.

Figure 14

Identification of cap bolt grade

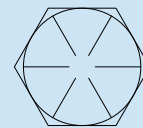

SKF 'A' style SAF (iron)  
SKF SAFS (steel)  
SAE J429 grade 8  
cap bolts are black in color  
(use table 11 values)

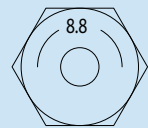

SKF 'M5' style SAF (iron)  
ISO R898 class 8.8  
cap bolts are painted blue  
(use table 11 values)

Table 11

## Cap bolt tightening torque for SAF style housings

Size	Tightening torque (ft-lbs)		
	(F)SAF "A" style	F(SAF) "M5" style	SAFS "N", "L" style
024	380	—	—
026	380	—	—
028	900	—	—
030	900	—	—
032	900	—	—
034	900	—	—
044	600	—	—
048	600	—	—
052	900	—	—
056	870	—	—
213	60	110	—
215	60	110	110(L)
216	220	110	220(L)
217	220	110	220(L)
218	220	110	110(N)
220	380	150	220(N)
222	380	150	220(N)
224	900	295	220
226	900	295	380(N)
228	900	295	600(N)
230	380	—	600(N)
232	380	—	600(N)
234	380	—	900(N)
236	380	—	2380(L)
238	600	—	1280(N)
240	600	—	1820(N)
244	900	—	2380(N)
308	110	—	—
309	110	—	—
310	110	—	—
311	110	—	—
312	110	—	—
313	220	—	—
314	220	—	—
315	220	—	—
316	380	—	—
317	380	—	—
318	380	—	—
320	900	—	—
322	900	—	—
324	380	—	—
326	380	—	—
328	380	—	—
330	380	—	—
332	600	—	—
334	600	—	—
338	900	—	—
340	870	—	—

Table 11

## Cap bolt tightening torque for SAF style housings

Size	Tightening torque (ft-lbs)		
	(F)SAF "A" style	F(SAF) "M5" style	SAFS "N", "L" style
509	70	45	—
510	70	45	—
511	110	60	—
513	110	60	—
515	110	60	110(L)
516	220	110	220(L)
517	220	110	220(L)
518	220	110	110(N)
520	380	150	220(N)
522	380	150	220(N)
524	900	295	220
526	900	295	380(N)
528	900	295	600(N)
530	380	—	600(N)
532	380	—	600(N)
534	380	—	900(N)
536	380	—	2380(N)
538	600	—	1280(N)
540	600	—	1820(N)
544	900	—	2380(N)
609	110	—	—
610	110	—	—
611	110	—	—
613	220	—	—
615	110	—	—
616	380	—	—
617	380	—	—
618	380	—	—
620	900	—	—
622	900	—	—
624	380	—	—
626	380	—	—
628	380	—	—
630	380	—	—
632	600	—	—
634	600	—	—
638	900	—	—
640	870	—	—

## Misalignment

The misalignment capability of SKF split housings is dependent upon the specific seal that is being used. Even though the bearing inside the housing can accommodate more misalignment, the limiting component is the seal. Refer to the table below for misalignment capability of specific SKF seals.

## Lubrication

See Lubrication section, page 87. Should bearing temperature be below 32° F (0° C) or above 200° F (93° C), consult SKF for lubrication recommendations.

## Temperature limits

The temperature limitations of the SAF and SAFS series housings are mainly dependent upon the specific lubricant bearing used to lubricate the bearing and/or the seal material limitations. Any seal using a rubber lip component will have a temperature limit of 240° F. However, the lubricant being used may have a lower temperature limit than the seal and be the limiting factor. So in order to determine the maximum operating temperature of the housing, the application conditions, lubricant, and seal must be known.

Table 12

## SKF seal alignment capabilities

Designation	Description	Allowable misalignment (degrees) <sup>1)</sup>
LER	Labyrinth seal (SAF 507-513)	0.3
B-9784	Contact seal (SAF 507-513)	0.1 <sup>2)</sup>
LOR	PosiTrac labyrinth seal	0.3
LOR + B 10724-xx	PosiTrac Plus seal	0.3
TER	Taconite seal w/contact seal	0.1 <sup>2)</sup>
TER-xx V	Taconite seal w/V-ring	0.5

1) Values are approximate to cover a family of parts. For specific sizes, consult SKF application engineering

2) Optimum contact seal performance is obtained when shaft misalignment and run-out are kept to a minimum

## Mounting instructions for collar mounted roller unit pillow blocks and flanged housings (held and free bearings)

### Step 1

Remove any burrs or rust on the shaft with an emery cloth or a fine file.

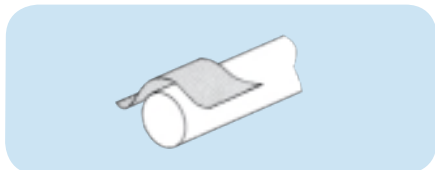

### Step 2

Wipe the shaft with a clean cloth.

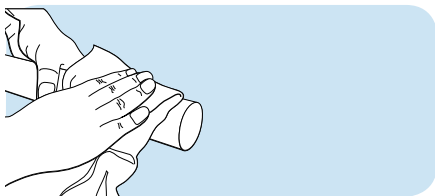

### Step 3

Check the shaft diameter.

#### Recommended shaft tolerances

##### Shaft diameter Tolerance

Up to 1 <sup>15</sup> / <sub>16</sub> "	Nominal to -0.0005"
2" to 4 <sup>15</sup> / <sub>16</sub> "	Nominal to -0.0010"

**NOTE:** When the load is Heavy, C/P<8.3, a press fit must be used. Consult SKF Applications Engineering.

### Step 4

Clean the base of the housing and support surface on which it rests. Be sure the supporting surface is flat. If pillow block elevation must be adjusted by shims, the shims MUST extend the full length and width of the support surface.

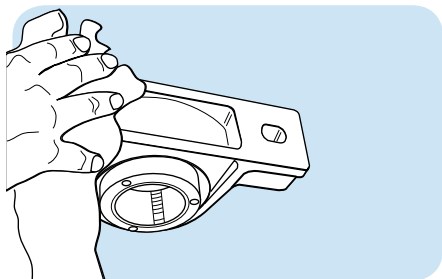

### Step 5

Slide the bearing and housing onto the shaft and position it where the pillow block is to be secured. Bolt the housing securely to the support.

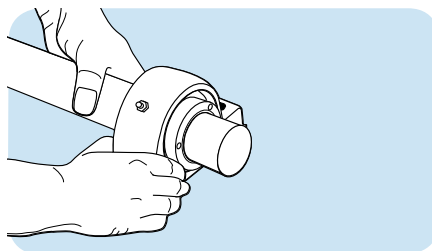

### Step 6

The FREE bearing must be centered in the housing to allow for axial shaft expansion. Move the bearing axially in the housing in both directions as far as it will go and determine the centered position. It will be necessary to relieve the bearing load while moving the bearing.

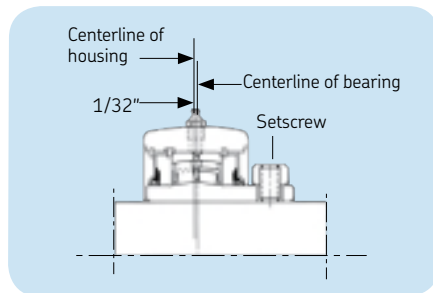

### Step 7

Tighten each setscrew alternately with the proper allen wrench until they stop turning and the wrench starts to spring. The spring of the wrench can be easily seen and felt when an extension is used. When both setscrews are tightened on the shaft, the bearing is firmly seated.\*\*

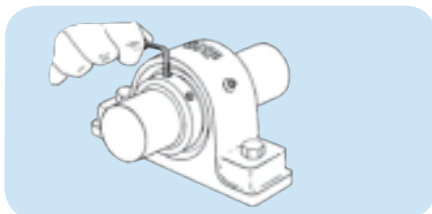

## Misalignment

The misalignment capability of SKF collar mounted roller units is a maximum of 1.5°. Even though the bearing inside the housing can accommodate more misalignment, the limiting component is the seal. The optimum contact seal performance is obtained when shaft misalignment and run-out are kept to a minimum.

## Lubrication

All SKF unit roller bearing pillow blocks and flanged housings are equipped with a grease fitting which allows the roller bearing to be relubricated in service. Suggestions for relubrication frequency and quantity are found on page 95. Relubrication cycles shorter than suggested on page 95 may be necessary where the bearing operates in severe conditions such as humid or excessively dirty environments. The standard bearing units are packed with SKF grease LGEP2, which is a lithium based NLGI No. 2 grease with EP additives and a base viscosity at 140° F (40° C) of 190 CST (mm<sup>2</sup>/s). When relubricating the bearing care must be taken to use greases that are compatible with LGEP2. SKF suggests medium temperature, lithium base NLGI grade No. 2 greases with oil viscosity of 150 to 220 CST (mm<sup>2</sup>/s) at 140° F (40° C) (750 to 1000 SUS at 100° F). When a unit is being relubricated, avoid excessive pressure, which may cause damage to the bearing seals. Should the bearing operating temperature be below 32° F (0° C) or above 200° F (93° C), consult SKF for lubrication recommendation.

### \*\*CAUTION

Proper tightness of setscrews is necessary to assure adequate bearing service life and axial locating ability. To achieve full permissible axial load carrying rating without an abutment shoulder, the following recommended setscrew tightening torques should be applied.

Shaft sizes	Setscrew (no.) size	Torque	Permissible axial load
in		in-lbs	lbs
17/16 to 23/16	(2) 3/8"-24	250	515
27/16 to 31/2	(2) 1/2"-20	620	900
311/16 to 4	(2) 5/8"-18	1325	1200
47/16 to 4 <sup>15</sup> / <sub>16</sub>	(4) 5/8"-18	1325	2400

## Mounting instructions for Concentra mount roller unit pillow blocks and flanged housings (held and free bearings)

**NOTE:** Read all instructions carefully before mounting or dismounting. In the following instructions, provision has been made to achieve a tight interference fit on the shaft using commercial grade shafting. This is a unit assembly. Do not attempt to remove the bearing from the assembly prior to installation. One side of the bearing has a collar marked "MOUNTING" and one side marked "DISMOUNTING". Do not tighten any mounting screws. Do not remove the plastic protection plugs from the dismounting collar.

### Step 1

Remove any burrs or rust on the shaft with an emery cloth or a fine file.

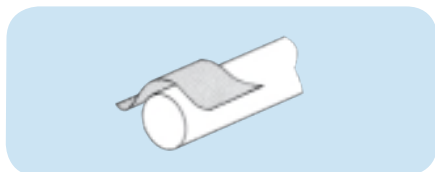

### Step 2

Wipe the shaft with a clean cloth.

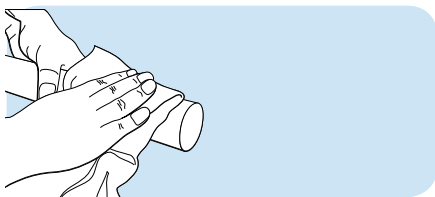

### Step 3

Check the shaft diameter.

#### Recommended shaft tolerances

Shaft diameter	Tolerance
Up to 1 <sup>1</sup> / <sub>2</sub> "	+0.000 to -0.003"
1 <sup>11</sup> / <sub>16</sub> " to 2 <sup>1</sup> / <sub>2</sub> "	+0.000 to -0.004"
2 <sup>11</sup> / <sub>16</sub> " to 4"	+0.000 to -0.005"
Up to 35mm	+0 to -76µm
35mm to 65mm	+0 to -101µm
70mm to 100mm	+0 to -125µm

**NOTE:** Tolerances shown are typically found on cold finished carbon steel bar, cold drawn or turned and polished shafts per ASTM A29 specification.

### Step 4

Lubricate the shaft with light oil.

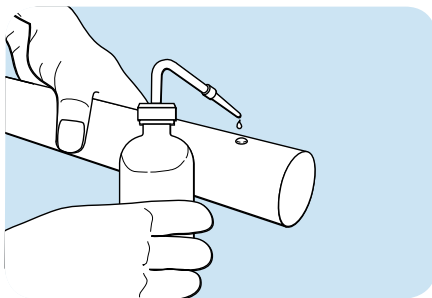

### Step 5

Clean the base of the housing and support surface on which it rests. Be sure the supporting surface is flat. If pillow block elevation must be adjusted by shims, the shims MUST extend the full length and width of the support surface.

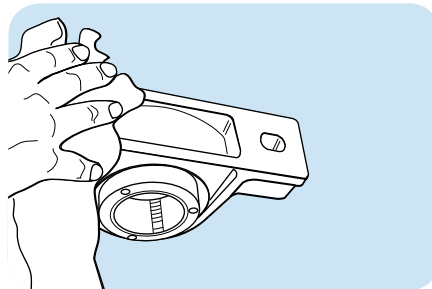

### Step 6

Slide the bearing assembly, with the "MOUNTING" side facing outward, on the shaft where the pillow block is to be secured. Leave 1-1/2" minimum axial spacing to allow for insertion of an allen wrench in the dismounting side setscrews. Bolt the assembly securely to the support.

**NOTE:** The mounting side of the bearing is the side that does not have the plastic protection plugs inserted in the setscrew holes and is marked "MOUNTING".

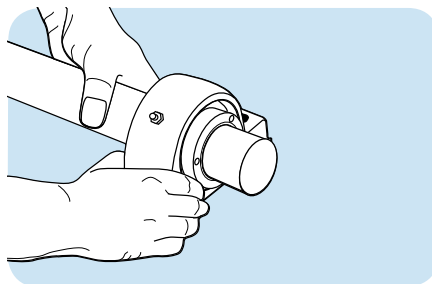

### Step 7

The "free" bearing must be centered in the housing to allow for axial shaft expansion. Move the bearing axially in the housing in both directions as far as it will go and determine the centered position. It will be necessary to relieve the bearing load while moving the assembly.

**NOTE:** The "free" bearing has no exposed snap ring and has no "H" in the designation suffix.

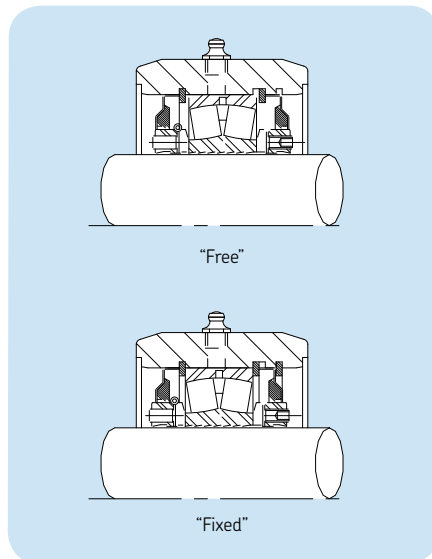

### Step 8

Count the number of setscrews on the "MOUNTING" side collar and see diagram below for the proper tightening pattern.

**CAUTION:** Tighten screws in the appropriate number pattern shown to prevent cocking of the inner ring and sleeve, which can result in the bearing eventually working its way loose from the shaft.

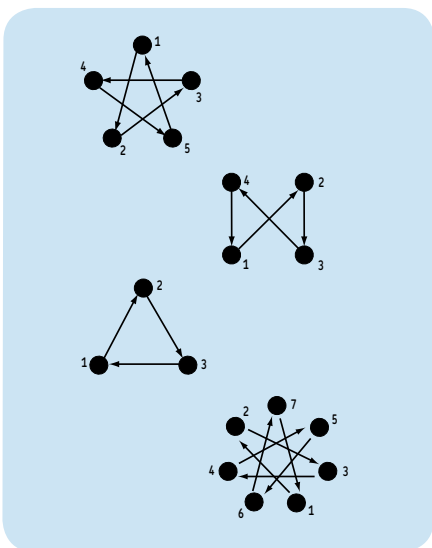

### Step 9

Tighten the mounting screws located in the “MOUNTING” side collar a total of 1/2 turn by alternately tightening in two increments (1/4 turn and 1/4 turn).

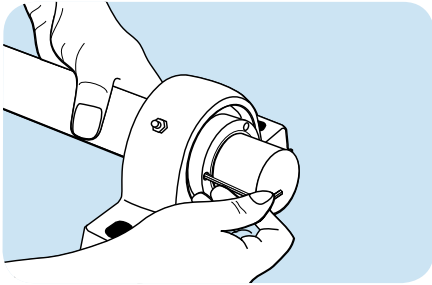

### Step 10

Lastly tighten each setscrew, starting with the screw opposite the split in the sleeve, until the long end of the supplied allen wrench comes in contact with supplied torque indicator

**CAUTION:** Do not use auxiliary equipment such as a hammer or pipe in tightening the screws.

If a torque wrench is used, tighten the setscrews to a torque value of 66 in-lbs (7.4 Nm) which represents approximately 3/4” deflection of the allen wrench under finger pressure.

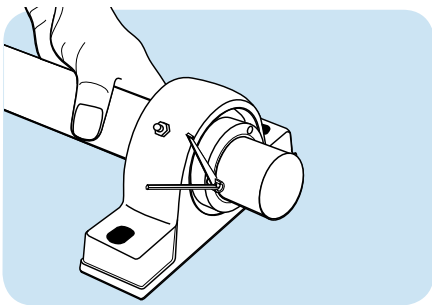

### Misalignment

The misalignment capability of SKF Concentra mount roller units is a maximum of 1.5°. Even though the bearing inside the housing can accommodate more misalignment, the limiting component is the seal. The optimum contact seal performance is obtained when shaft misalignment and run-out are kept to a minimum.

### Lubrication

All SKF unit roller bearing pillow blocks and flanged housings are equipped with a grease fitting which allows the roller bearing to be relubricated in service. Suggestions for relubrication frequency and quantity are found on page 95. Relubrication cycles shorter than suggested on page 95 may be necessary where the bearing operates in severe conditions such as humid or excessively dirty environments. The standard bearing units are packed with SKF grease LGEP2, which is a lithium based NLGI No. 2 grease with EP additives and a base viscosity at 140° F (40° C) of 190 CST (mm<sup>2</sup>/s). When relubricating the bearing care must be taken to use greases that are compatible with LGEP2. SKF suggests medium temperature, lithium base NLGI grade No. 2 greases with oil viscosity of 150 to 220 CST (mm<sup>2</sup>/s) at 140° F (40° C) (750 to 1000 SUS at 100° F). When a unit is being relubricated, avoid excessive pressure, which may cause damage to the bearing seals. Should the bearing operating temperature be below 32° F (0° C) or above 200° F (93° C), consult SKF for lubrication recommendation.

### Dismounting instructions for Concentra mount roller unit pillow blocks and flanged housings

(For assemblies with access to “DISMOUNTING” collar)

#### Step 1

Remove any burrs or rust on the shaft with an emery cloth or a fine file.

#### Step 2

Re-tighten the “MOUNTING” side setscrews, per steps 8, 9, and 10 from the mounting procedure.

#### Step 3

Loosen the “MOUNTING” side setscrews 1 to 2 full turns.

### Step 4

Using a screw driver or other suitable tool, remove and discard the 2 plastic protection plugs from the “DISMOUNTING” collar.

### Step 5

Alternately tighten the dismounting screws in 1/4 turn increments until the bearing is released from the shaft. Often, a distinctive “pop” is heard or felt, indicating release. If the shaft is damaged or fretting corrosion has occurred it will not “pop”.

### Step 6

Loosen the “DISMOUNTING” setscrews, Unbolt the unit from the support structure and remove the complete assembly from the shaft.

**CAUTION:** If the bearing unit will not slip off the shaft during removal, do not continue to further tighten the “DISMOUNTING” setscrews. This may tend to reverse tighten the bearing to the shaft. In the unlikely event that reverse tightening occurs, loosen the “DISMOUNTING” screws and retighten the screws on the “MOUNTING” collar side following instructions. Repeat the dismounting procedure Steps 3 through 6 or see dismounting instructions

### For assemblies with no access to “DISMOUNTING” collar, below

Follow step 1, 2, 3 from the dismounting section and lightly impact the “MOUNTING” collar side of the shaft until the bearing releases from shaft. Remove assembly from the shaft.

## Mounting instructions for ball unit pillow blocks and flanged housings

### Step 1

Remove any burrs or rust on the shaft with an emery cloth or a fine file.



### Step 2

Wipe the shaft with a clean cloth.

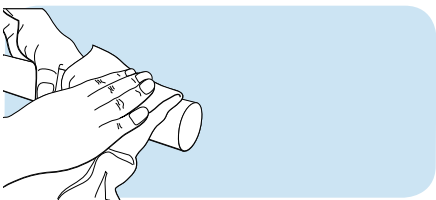

### Step 3

Check the shaft diameter.

#### Recommended shaft tolerances

Shaft diameter	Tolerance
Up to 1 <sup>15</sup> / <sub>16</sub> " (49.2 mm)	Nominal to -0.0005" (-0.013 mm)
2" to 4" (50.8 to 101.6 mm)	Nominal to -0.0010" (-0.025 mm)

**NOTE:** When the load is heavy,  
 $\frac{C}{P} < 6.6$   
 a press fit must be used.

### Step 4

Slide the bearing and housing onto the shaft and position. For eccentric lock-type units, leave the collar loose on the shaft.

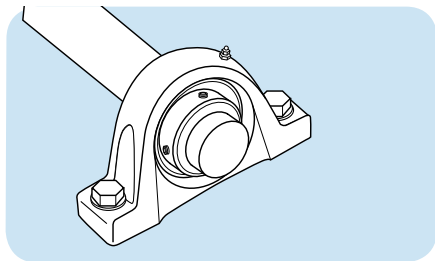

### Step 5

Clean the base of pillow block and the support surface on which it rests. Be sure the supporting surface is flat. If the pillow block elevation must be adjusted by shims, the shims **MUST** extend the full length and width of the support surface. Bolt pillow block securely to the support. With flanged housings, clean the flange and support surface. Be sure the support surface is flat. Bolt the flanged housing securely to the support.

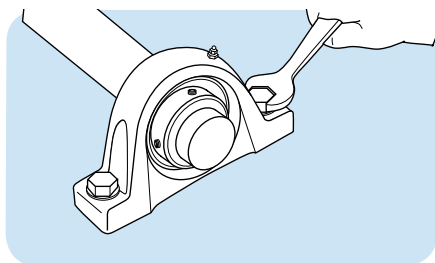

### Step 6

#### Setscrew lock (6A)

Tighten each setscrew alternately with proper hex head socket wrench until they stop turning and the hex head socket wrench starts to spring. The spring of the hex head socket wrench can be easily seen and felt when the extension is used (see **Table 13**). When both setscrews are tightened on the shaft, the bearing is firmly seated. This completes the procedure for mounting setscrew lock units.

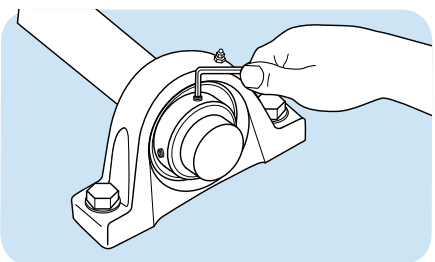

#### Eccentric lock (6B)

Slide the collar up to the bearing and turn it by hand in the direction of shaft rotation until it slips over the inner ring extension and engages the eccentric. Turn the collar quickly by hand in the direction of shaft rotation until the eccentric groove in the collar engages the eccentric on the inner ring and the two parts are locked together. This requires about 1/4 turn.

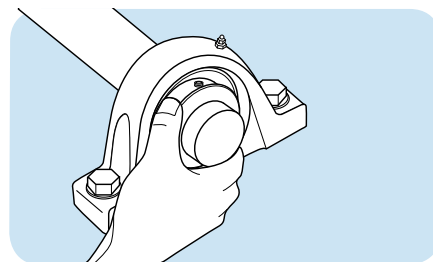

### Step 7

Place a punch or drift in the blind hole in the collar and strike it sharply with a hammer in the direction of shaft rotation to lock the collar and ring tightly together. This also tightens the inner ring on the shaft.

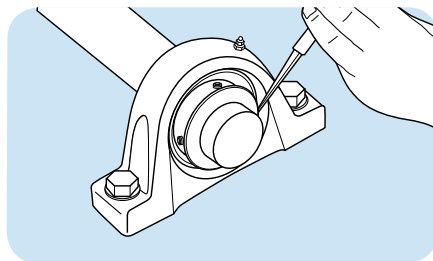

### Step 8

Tighten the collar setscrew with proper hex head socket wrench until the setscrew stops turning and the hex head socket wrench starts to spring. Proper tightness of setscrews is necessary to assure adequate bearing service life (see **Table 13**). The setscrew is an added locking device and should not be relied upon alone to lock the bearing to the shaft.

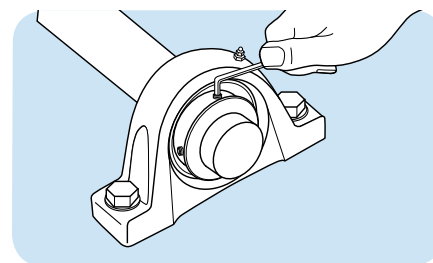

Table 13

## Tightening torque for setscrews

Setscrew size	Length in (mm)	Torque in-lbs(Nm)
#10-32	1/4 (6.35) and longer	36 (4.0)
1/4 (6.35) x 28	1/4 (6.35) and longer	87 (9.8)
5/16 (7.96) x 24	5/16 (7.96) and longer	165 (18.6)
3/8 (9.53) x 24	3/8 (9.53) and longer	290 (32.8)
7/16 (11.11) x 20	7/16 (11.11) and longer	430 (48.6)
1/2 (12.70) x 20	1/2 (12.70) and longer	620 (70.1)

## Misalignment

Ball bearing units can compensate for up to  $\pm 5^\circ$  of static misalignment. However, in the cast iron housings when it is desirable to relubricate the bearings, initial errors in alignment should not exceed  $\pm 2^\circ$  for basic bearings size 211 and smaller and  $\pm 1.5^\circ$  for larger sizes. Misalignment greater than this will prevent the lubrication holes in the outer ring of the bearing from lining up with the groove in the housing bore and the bearings will not be relubricated.

## Lubrication

Generally speaking, ball bearing units are designed to operate without relubrication under normal speed and operating conditions. All ball bearing units are sealed at both sides with rubbing contact seals and are filled with a special long life grease of NLGI consistency 2. The grease has good corrosion inhibiting properties and is suitable for operating temperatures between  $-4^\circ\text{F}$  and  $248^\circ\text{F}$ . However, under extreme conditions or in heavily contaminated environments, it may be necessary to relubricate the bearings.

Many SKF ball bearing units are equipped with a grease fitting that allows the bearing to be relubricated in service. When relubricating, care must be taken to use greases that are compatible with the original grease. SKF suggests a medium temperature, lithium calcium base, NLGI 2 grease having a base oil with a viscosity of 900 SUS ( $200\text{mm}^2/\text{s}$ ) at  $100^\circ\text{F}$  ( $40^\circ\text{C}$ ). When a unit is being relubricated, avoid excessive pressure, which may cause damage to the bearing seals.

See Lubrication section, page 87. Should the bearing temperature be below  $32^\circ\text{F}$  ( $0^\circ\text{C}$ ) or above  $200^\circ\text{F}$  ( $93^\circ\text{C}$ ), consult SKF for lubrication recommendations.

## Cages

Most ball bearing units are fitted with an injection molded, heat stabilized, glass fiber reinforced polyamide 6.6 cage that has a maximum operating temperature range of  $240^\circ\text{F}$ .

## Dismounting instructions for ball unit pillow blocks and flanged housings

## Setscrew lock

## Step 1

Loosen setscrews

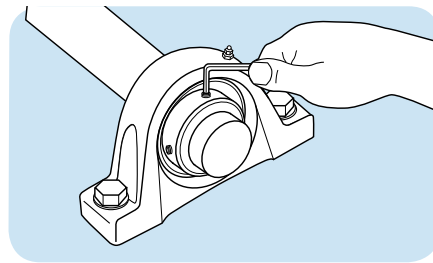

## Step 2

Unbolt the housing from its support. Complete bearing unit can then be removed from the shaft. It will be necessary to relieve the bearing load when removing the unit.

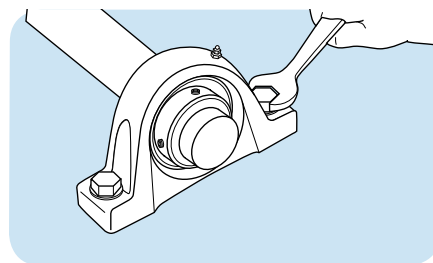

## Eccentric lock

## Step 1

First loosen setscrews.

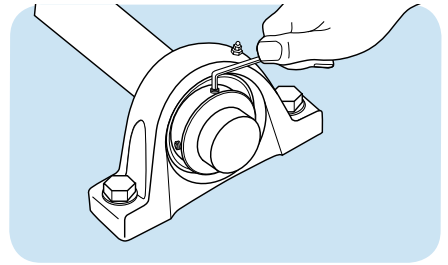

## Step 2

Place punch or drift in the blind hole in the collar and strike it sharply with a hammer in the opposite direction of shaft rotation.

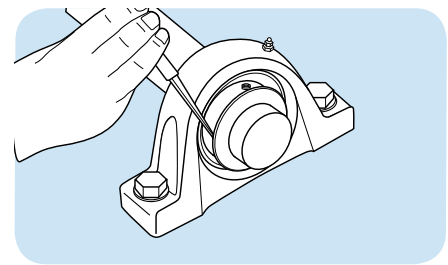

## Step 3

The collar can now be turned by hand and removed from the inner ring.

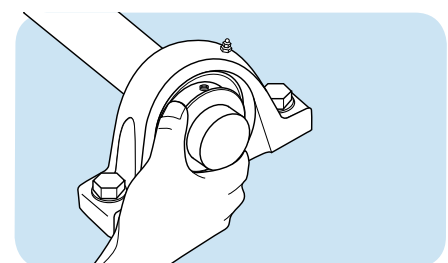

## Step 4

The housing can then be unbolted from its support and the complete bearing unit removed from the shaft. It will be necessary to relieve the bearing load while removing the bearing unit.

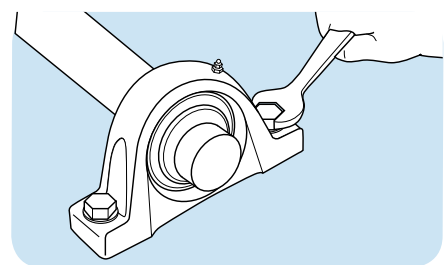

## To remove bearing from housing

### Setscrew lock

Tilt the bearing on its spherical seat 90° from its normal position and slide it out through the slots provided in the housing.

### Eccentric lock

Remove the collar first. Tilt the bearing on its spherical seat 90° from its normal position and slide it out through the slots provided in the housing.

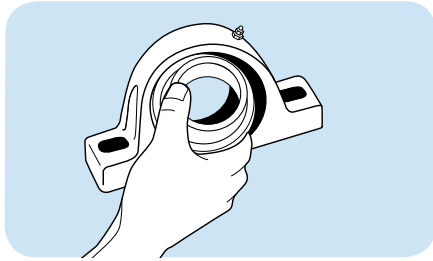

## Mounting instructions for Concentra ball unit pillow blocks and flanged housings

**NOTE:** This is a unit assembly. No attempt should be made to disassemble the bearing prior to installation. In the following instructions, provision has been made to achieve a tight interference fit on the shaft using commercial grade shafting.

**Read all instructions carefully before mounting or dismounting.**

### Step 1

Remove any burrs or rust on the shaft with an emery cloth or a fine file.

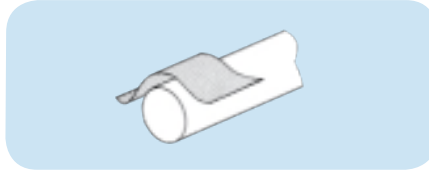

### Step 2

Wipe the shaft with a clean cloth.

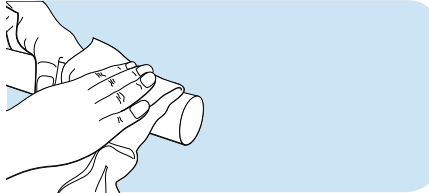

### Step 3

Check shaft diameter.

#### Recommended shaft tolerances

Shaft diameter	Tolerance
Up to 1 <sup>15</sup> / <sub>16</sub> "	+0.000" to -0.003"
Up to 55mm	+0.00 mm to -76 μm
2" to 2 <sup>15</sup> / <sub>16</sub> "	+0.000" to -0.004"
55mm to 75mm	+0.00 mm to -102 μm

### Step 4

Lubricate the shaft with light oil.

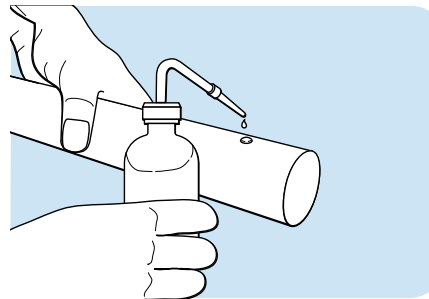

### Step 5

Clean the base of the pillow block and the support surface on which it rests. Be sure the supporting surface is flat. If the pillow block elevation must be adjusted by shims, the shims **MUST** extend the full length and width of the support surface.

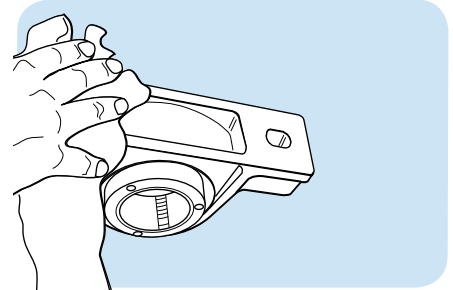

### Step 6

Slide the bearing and housing, with the mounting side facing outward, onto the shaft where the pillow block is to be secured. Bolt the pillow block securely to the support.

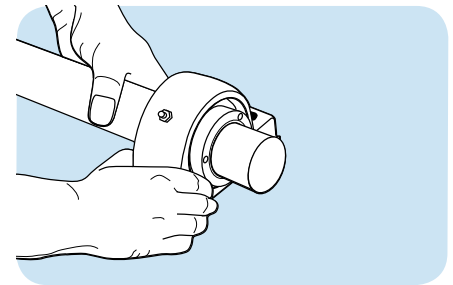

### Step 7

Position the collar so that a setscrew is directly opposite the split in the sleeve. Snug the mounting screws to finger tightness holding the short leg of the supplied allen wrench.

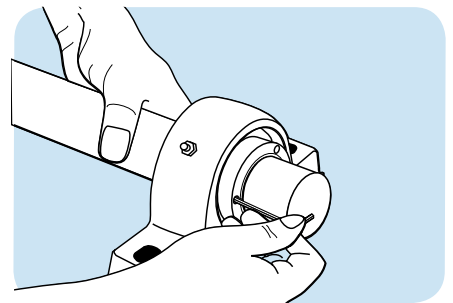



## Step 8

Tighten the mounting screws a total of 1/2 turn by alternately tightening in two increments (1/4 turn and 1/4 turn). Lastly tighten each setscrew, starting with the screw opposite the split in the sleeve, until the long end of the allen wrench comes in contact with supplied torque indicator or to a torque of (7,4 Nm) 5.5 ft. lbs.

**CAUTION:** Do not use auxiliary equipment such as a hammer or pipe in tightening the screws.

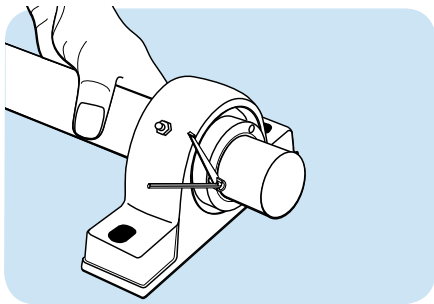

## Step 9

### *Pillow block housings – 2nd unit*

Position the second unit at its correct location on the shaft. Place the housing mounting bolts in their holes but do not tighten. Repeat steps 7 and 8. Tighten the housing mounting bolts to the correct torque.

### *Flange housings – 2nd unit*

Position the second bearing and housing at its location on the shaft. Snug the mounting screws to finger tightness (unit should be able to slide along shaft) holding the short leg of the supplied allen wrench. Bolt the flange securely to the mounting surface. Repeat steps 7 and 8.

## Misalignment

Ball bearing units can compensate for up to  $\pm 5^\circ$  of static misalignment. However, in the cast iron housings when it is desirable to relubricate the bearings, initial errors in alignment should not exceed  $\pm 2^\circ$  for basic bearings size 211 and smaller and  $\pm 1.5^\circ$  for larger sizes. Misalignment greater than this will prevent the lubrication holes in the outer ring of the bearing from lining up with the groove in the housing bore and the bearings will not be relubricated.

## Lubrication

Generally speaking, ball bearing units are designed to operate without relubrication under normal speed and operating conditions. All ball bearing units are sealed at both sides with rubbing contact seals and are filled with a special long life grease of NLGI consistency 2. The grease has good corrosion inhibiting properties and is suitable for operating temperatures between  $-4^\circ\text{F}$  and  $248^\circ\text{F}$ . However, under extreme conditions or in heavily contaminated environments, it may be necessary to relubricate the bearings.

Many SKF ball bearing units are equipped with a grease fitting that allows the bearing to be relubricated in service. When relubricating, care must be taken to use greases that are compatible with the original grease. SKF suggests a medium temperature, lithium calcium base, NLGI 2 grease having a base oil with a viscosity of 900 SUS (200mm<sup>2</sup>/s) at 100° F (40° C). When a unit is being relubricated, avoid excessive pressure, which may cause damage to the bearing seals.

See Lubrication section, page 87. Should the bearing temperature be below 32° F (0° C) or above 200° F (93° C), consult SKF for lubrication recommendations.

## Cages

Most ball bearing units are fitted with an injection molded, heat stabilized, glass fiber reinforced polyamide 6.6 cage that has a maximum operating temperature range of 240° F.

## Dismounting instructions for Concentra ball unit pillow blocks and flanged housings

### Step 1

It may be necessary to clean the shaft extension with emery cloth to remove rust or repair surface damage.

### Step 2

Loosen the mounting setscrews 1 to 2 full turns.

### Step 3

Lightly impact the bearing collar side of the shaft until the bearing releases from shaft. Remove complete unit from the shaft.

## Test running

After mounting a bearing, the prescribed lubricant is applied and a test run made so that noise and bearing temperature can be checked. The test run should be carried out under partial load and – where there is a wide speed range – at slow or moderate speed. Under no circumstances should a rolling bearing be allowed to start up unloaded and accelerated to high speed, as there is a danger that the rolling elements would slide on the raceways and damage them, or that the cage would be subjected to inadmissible stresses.

Normally, bearings produce an even “purring” noise. Whistling or screeching indicates inadequate lubrication. An uneven rumbling or hammering is due in most cases to the presence of contaminants in the bearing or to bearing damage caused during mounting.

An increase in bearing temperature immediately after start up is normal. For example, in the case of grease lubrication, the temperature will not drop until the grease has been evenly distributed in the bearing arrangement, after which an equilibrium temperature will be reached. Unusually high temperatures or constant peaking indicates that there may be too much lubricant in the arrangement or that the bearing is radially or axially distorted. Other causes are that the associated components have not been correctly made or mounted, or that the seals have excessive friction.

During the test run, or immediately afterwards, the seals should be checked to see that they perform correctly and any lubrication equipment, as well as the oil level of an oil bath, should be checked. It may be necessary to sample the lubricant to determine whether the bearing arrangement is contaminated or components of the arrangement have become worn.

## Dismounting methods

Dismounting of bearings may become necessary when a machine functions improperly or is being overhauled. Many precautions and operations used to dismount bearings are common to the mounting of bearings. The methods and tools depend on many factors such as bearing design, accessibility, type of fit, etc.

There are three dismounting methods: mechanical, hydraulic and oil injection.

- When dismounting bearings, never apply the force through the rolling elements.

## Interference fits on a cylindrical shaft

Bearings with a bore diameter up to 120 mm, mounted with an interference fit on the shaft, can be dismounted using a conventional puller. The puller should engage the inner ring, and the bearing is then removed with a steady force until the bearing bore completely clears the entire length of the cylindrical seating, see **Figure 15**.

Larger bearings with an interference fit on the shaft often require considerable dismounting force. In these cases a hydraulic tool is more suitable than a mechanical one.

Figure 15

The puller should engage the inner ring

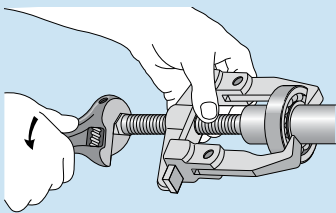

## Interference fit in the housing

A bearing mounted in a housing without shoulders can be removed by hammer blows directed on a sleeve that abuts the outer ring. Larger bearings require greater force to dismount, and the use of a press is recommended.

## Interference fit both in the housing and on the shaft

For bearings with an interference fit on both rings, the best method is to allow the bearing to be pressed out of the housing with the shaft. If this is not suitable, the opposite procedure – allowing the bearing to come off the shaft with the housing – can be used.

## Dismounting from a tapered shaft

Smaller bearings can be dismounted using a conventional puller, which engages the inner ring. Center the puller accurately to avoid damage to the bearing seating. Larger bearings may require considerable force to dismount, so a hydraulic withdrawal tool may be more suitable than a mechanical one. The best way to facilitate dismounting of inner rings is to utilize the SKF oil injection method. Detailed information is found at [www.skf.com/mount](http://www.skf.com/mount).

## Dismounting from sleeves

Adapter and withdrawal sleeves are often used. CARB toroidal roller bearings are, in principle, dismounted in the same way as other bearings. Detailed information is given at [www.skf.com/mount](http://www.skf.com/mount).

## Can the bearing be used again?

Always inspect a dismounted bearing, but don't try to judge whether it can be reused until after it has been cleaned. Treat it as new. Never spin a dirty bearing; instead, rotate it slowly while washing. Wash with a petroleum-based solvent. Dry with a clean, lint-free cloth or compressed clean, moisture-free air, taking care that no bearing part starts rotating. Contact your SKF Authorized Distributor for information on equipment for cleaning and drying.

Larger bearings with badly oxidized lubricant can be cleaned with a strong alkaline solution, for example, a solution containing up to 10% caustic soda. Add 1% of a suitable wetting agent. Take care when following this cleaning procedure: lye is harmful to skin, clothing and aluminum. Always use protective gloves, goggles and apron.

Examine a used bearing closely to determine whether it is reusable. Use a small mirror and a dental-type probe with a rounded point to inspect raceways, cage and rolling elements. Look for scratches, marks, streaks, cracks, discolorations, mirror-like surfaces and so on. Carefully rotate the bearing and listen to the sound. An undamaged bearing (i.e., one that has no marks or other defects and runs evenly without abnormally large radial internal clearance) can be remounted.

Before a large bearing is remounted for a critical application, ask SKF for examination. The cost of such inspection may actually save money.

Bearings with a shield or seal on one side should be cleaned, dried, inspected and handled in the same way as bearings without seals. However, never wash a bearing with seals or shields on both sides. They are sealed and lubricated for life and should be replaced if you suspect bearing or seal damage.

To prevent corrosion, use a rust preventative immediately after cleaning.

## Cleaning bearings

All lubricants have a tendency to deteriorate in the course of time, but at a greatly different rate. Therefore, sooner or later, it will be necessary to replace the old lubricant with new. Oils and greases should be removed in the early stages of deterioration so that removal does not become unnecessarily troublesome. Oils can be drained and the bearing flushed and washed, preferably with some solvents, kerosene or even with light oil. The solution should then be drained thoroughly and the bearing and housing flushed with some hot, light oil and again drained before adding new lubricant. Lighter petroleum solvents may be more effective for cleaning but are often objectionable, either because of flammability or because they may have a tendency to become corrosive, particularly in the presence of humidity. A grease is also more easily replenished in early stages of deterioration, for instance, by displacement with new grease, if the housing is designed so that this can be done. Bearings which are dismantled are, of course, much more easily cleaned than bearings which must stay

assembled in equipment. Solvents can then be used more freely for cleaning. Badly oxidized oil and grease, however, need a very thorough treatment for their removal; ordinary solvents are usually not satisfactory. The following methods for cleaning unshielded bearings, as suggested by ABEC (Annular Bearing Engineers' Committee) are recommended.

### **1. Cleaning unmounted bearings which have been in service**

Place bearings in a basket and suspend the basket in a suitable container of clean, cold petroleum solvent or kerosene and allow to soak, preferably overnight. In cases of badly oxidized grease, it may be found expedient to soak bearings in hot, light oil at 93° to 116° C (200° to 240° F), agitating the basket of bearings slowly through the oil from time to time. In extreme cases, boiling in emulsifiable cleaners diluted with water will usually soften the contaminating sludge. If the hot emulsion solutions are used, the bearings should be drained and spun individually until the water has completely evaporated. The bearings should be immediately washed in a second container of clean petroleum solvent or kerosene. Each bearing should be individually cleaned by revolving by hand with the bearing partly submerged in the solvent... turning slowly at first and working with a brush if necessary to dislodge chips or solid particles. The bearings may be judged for their condition by rotating by hand. After the bearings have been judged as being clean, they should immediately be spun in light oil to completely remove the solvent . . . coated with preservative if they are not to be reassembled immediately and wrapped at once in clean oil-proof paper while awaiting reassembly. The use of chlorinate solvents of any kind is not recommended in bearing cleaning operations because of the rust hazard involved. Nor is the use of compressed air found desirable in bearing cleaning operations.

### **2. Cleaning of bearings as assembled in an installation**

For cleaning bearings without dismounting, hot, light oil at 93° to 116° C (200° to 240° F) may be flushed through the housing while the shaft or spindle is slowly rotated. In cases of badly oxidized grease and oil, hot, aqueous emulsions may be run into the housings, preferably while rotating the bearings until the bearing is satisfactorily cleaned. The solution must then be drained thoroughly, providing rotation if possible, and the bearing and housing flushed with hot, light oil and again drained before adding new lubricant. In some very difficult cases an intermediate flushing with a mixture of alcohol and light mineral solvent after the emulsion treatment may be useful. If the bearing is to be relubricated with grease, some of the fresh grease may be forced through the bearing to purge any remaining contamination. This practice cannot be used unless there are drain plugs which can be removed so that the old grease may be forced out. Also, bearings should be operated for at least twenty minutes before drain plugs are replaced, as excess lubricant will cause serious overheating of the bearing.

### **3. Oils used for cleaning**

Light transformer oils, spindle oils, or automotive flushing oils are suitable for cleaning bearings, but anything heavier than light motor (SAE 10) is not recommended. An emulsifying solution made with grinding, cutting or floor cleaning compounds, etc., in hot water, has been found effective. Petroleum solvents must be used with the usual precautions associated with fire hazards.

#### **WARNING:**

When hot cleaning, use a thin, clean oil with a flash point of at least 480° F (250° C). Use protective gloves whenever possible. Regular contact with petroleum products may cause allergic reactions. Follow the Material Safety Data Sheet (MSDS) safety instructions included with the solvent you use to clean bearings.



# Shaft and housing fits

## Purpose of proper fits

In order for a bearing to function properly and achieve its load carrying ability, the fit between the shaft and the inner ring, and the fit between the outer ring and the housing must be suitable for the application. Although a bearing must satisfy a wide range of operating conditions, which determine the choice of fit, the tolerances for the bearing itself are standardized. Therefore, the desired fit can only be achieved by selecting the proper tolerance for the shaft diameter and housing bore. The fits must ensure that the rings are properly supported around their circumference as well as across their entire widths. The bearing seats must be made with adequate accuracy and their surface should be uninterrupted by grooves, holes or other features. In addition, the bearing rings must be properly secured to prevent them from turning relative to their seats under load.

## Suitable fits

Generally speaking, proper fits can only be obtained when the rings are mounted with an appropriate degree of interference. Improperly secured bearing rings generally cause damage to the bearings and associated components. However, when easy mounting and dismounting are desirable, or when axial displacement is required as with a non-locating bearing, an interference fit cannot always be used. In certain cases, where a loose fit is employed, it is necessary to take special precautions to limit the inevitable wear from creeping or turning of the bearing ring. Some examples of this are surface hardening of the bearing seating and abutments, lubrication of the mating surfaces via special lubrication grooves and the removal of wear particles, or slots in the bearing ring side faces to accommodate keys or other holding devices.

The system of limits and fits used by industry for all rolling bearings, except tapers (ISO Standard 286), contains a considerable choice of shaft and housing tolerances. When used with standard bearings, these will give any of the desired fits, from the tightest to the loosest required. A letter and numeral designate each tolerance. The letter (lower case for shaft diameters and capitalized for housing bores) locates the tolerance zone in relation to the nominal dimensions. The numeral portion provides the range of the tolerance zone. **Figure 1** illustrates this relation. The rectangles indicate the location and magnitude of the various shaft and housing tolerance zones, which are used for rolling bearings, superimposed on the bore and O.D. tolerance of the bearing rings.

## Selection of fit

The selection of the proper fit is dependant upon several factors, which include the size of the bearing, type of loading, magnitude of applied load, bearing internal clearance, temperature conditions, design and material of shaft and housing, ease of mounting and dismounting, displacement of the non-locating bearing, and running accuracy requirements. Consideration must also be given to the fact that a solid shaft deforms differently than a hollow one.

## Size of the bearing

As the overall size of the bearing increases, the magnitude of the fits typically increases as well. This is based on the assumption that the applied loads will be higher with larger bearings than with smaller bearings. Hence, the fit selection tables will show increasing fits as the bearing diameter increases.

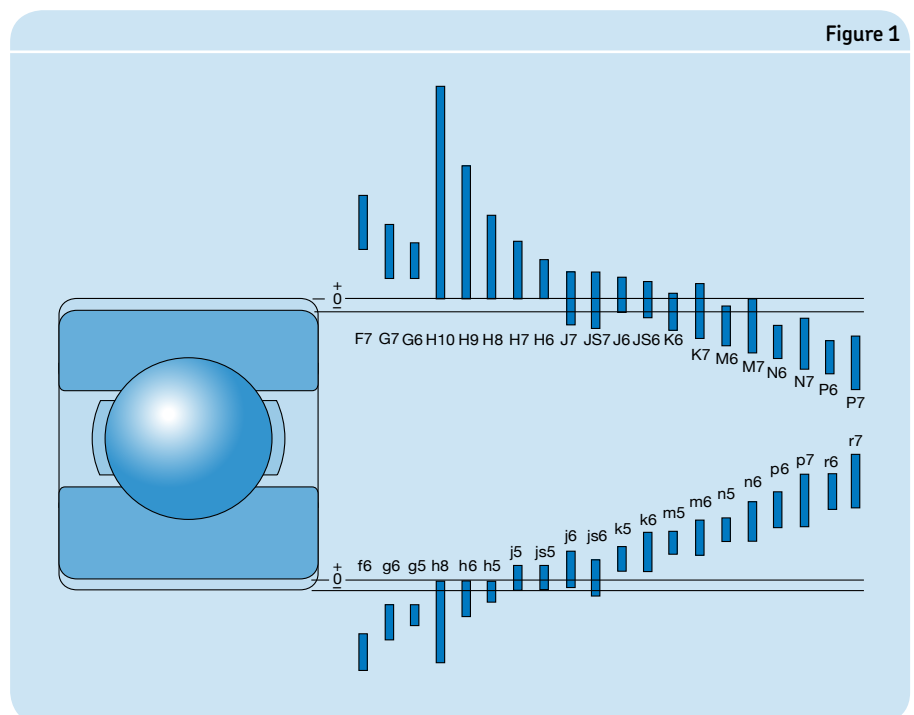
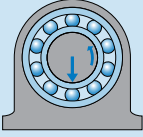
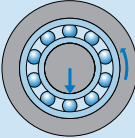
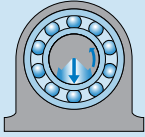
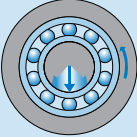

Table 1

Conditions of rotation and loading				
Operating conditions	Schematic illustration	Load condition	Example	Recommended fits
Rotating inner ring Stationary outer ring Constant load direction		Rotating load on inner ring Stationary load on outer ring	Belt-driven shafts	Interference fit for inner ring Loose fit for outer ring
Stationary inner ring Rotating outer ring Constant load direction		Stationary load on inner ring Rotating load on outer ring	Conveyor idlers Car wheel hub bearings	Loose fit for inner ring Interference fit for outer ring
Rotating inner ring Stationary outer ring Load rotates with inner ring		Stationary load on inner ring Rotating load on outer ring	Vibratory applications Vibrating screens or motors	Interference fit for outer ring Loose fit for inner ring
Stationary inner ring Rotating outer ring Load rotates with outer ring		Rotating load on inner ring Stationary load on outer ring	Gyratory crusher (Merry-go-round drives)	Interference fit for inner ring Loose fit for outer ring

## Type of loading (stationary or rotating)

Type of loading refers to the direction of the load relative to the bearing ring being considered. Essentially there are three different conditions: **rotating load**, **stationary load** and **direction of load indeterminate** (See Table 1).

**Rotating load** refers to a bearing ring that rotates while the direction of the applied load is stationary. A rotating load can also refer to a bearing ring that is stationary, and the direction of the applied load rotates so that all points on the raceway are sub-

jected to load in the course of one revolution. Heavy loads, which do not rotate but oscillate are generally considered as rotating loads. A bearing ring subjected to a rotating load will creep or turn on its seat if mounted with either a clearance fit or too light an interference fit. Fretting corrosion of the contact surfaces will result and eventual turning of the ring relative to its seat can occur, resulting in scored seats. To prevent this from happening, the proper interference fits must be selected and used.

**Stationary load** refers to a bearing ring that is stationary while the direction of the

applied load is also stationary. A stationary load can also refer to a bearing ring that rotates at the same speed as the load, so that the load is always directed towards the same position on the raceway. Under these conditions, a bearing ring will normally not turn on its seating. Therefore, an interference fit is not normally required unless it is required for other reasons.

**Direction of load indeterminate** refers to variable external loads, shock loads, vibrations and unbalance loads in high-speed machines. These give rise to changes in the direction of load, which cannot be

accurately predicted. When the direction of load is indeterminate, and particularly where heavy loads are involved, it is desirable for both rings to have an interference fit. For the inner ring, the recommended fit for a rotating load is normally used. However, when the outer ring must be free to move axially in the housing, and the load is not heavy, a somewhat looser fit than that recommended for a rotating load may be used.

### Magnitude of applied load

The interference fit of a bearing ring on its seat will be loosened with increasing load, since the ring can flex under load. If the ring is also exposed to a rotating load, it may begin to creep. Therefore, the amount of interference fit should be related to the magnitude of the applied load; the heavier the load, the greater the interference fit that is required. See Conditions column in **Tables 2, 4, and 5**.

### Bearing internal clearance

When a ring is pressed onto a shaft or into a housing, the interference fit causes the ring to either expand or compress, depending upon whether it is the inner ring or outer ring respectively. As a result, the bearing internal clearance is reduced. In order to avoid preloading a bearing and causing it to overheat, a minimum clearance should remain in the bearing after mounting. The initial clearance and permissible reduction depend on the type and size of the bearing. The reduction in clearance due to the interference fit can be so large that bearings with an initial clearance greater than Normal have to be used in order to prevent the bearing from becoming preloaded (**Figure 2**).

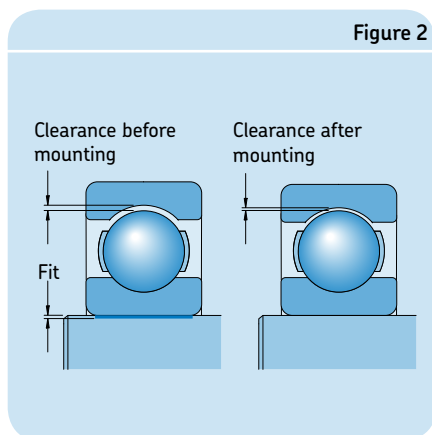

Figure 2

### Temperature conditions

In many applications the outer ring has a lower temperature in operation than the inner ring. This leads to a reduction of the radial internal clearance. When in service, bearing rings will normally reach a higher temperature than the components they are mounted to. This can result in a loosening of the inner ring press fit on the shaft, while the outer ring may expand into the housing and prevent the desired axial float of the ring. Temperature differences and the direction of heat flow in the bearing arrangement must therefore be carefully considered when selecting fits (**Figure 3**).

### Design and material of shaft and housing

The fit of a bearing ring on its seating must not be uneven, causing distortion or an out-of-round condition. This can be caused, for example, by discontinuities in the seating surface. For example, split housings are not generally suitable when an interference fit is required on an outer ring. To provide adequate support for bearing rings mounted in thin-walled housings, light alloy housings or on hollow shafts, heavier interference fits are typically required to account for the slight collapse of these components.

The component material that the bearing is mounted to is also of great importance in determining the proper fit tolerance. For instance, stainless steel shafts and aluminum housings have significantly different coefficients of thermal expansion than bearing steel and therefore will have slightly different fit requirements to account for this.

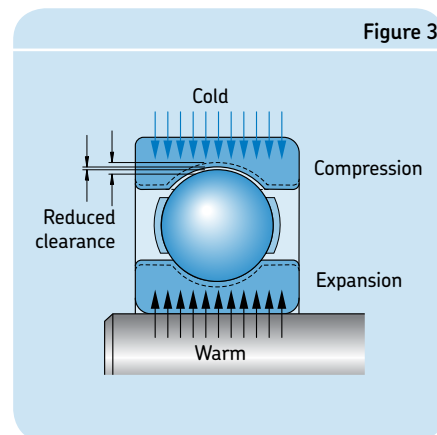

Figure 3

For applications with stainless steel bearings, the recommended tolerances in **Tables 2 thru 6** apply, but the restrictions in the **Footnotes 2 and 3 in Table 2** shall be taken into account. **Footnote 1 in Table 2** is not valid for stainless steel bearings. If tighter fits than those recommended in **Table 2** are needed, please contact SKF Application Engineering.

### Ease of mounting and dismounting

Bearings with clearance or loose fits are usually easier to mount or dismount than those with interference fits. When operating conditions necessitate interference fits and when it is essential that mounting and dismounting can be done easily, separable bearings, or bearings with a tapered bore may be used. Bearings with a tapered bore can be mounted either directly on a tapered shaft seating or via adapter or withdrawal sleeves on smooth or stepped cylindrical shafts.

### Displacement of the non-locating bearing

If a non-separable bearing is used as the non-locating bearing, it is imperative that one of the bearing rings is free to move axially at all times during operation. Using a clearance fit for the ring that has the stationary load will allow this (see **Table 1**). In addition to having a loose fit in the housing bore, the bearing should also be unrestricted to slide axially (i.e. no housing shoulders near the bearing outer ring). In the case of a stationary load on the inner ring of a bearing, the inner ring should have the loose fit and there should be a gap between it and the shaft shoulder to allow the shaft to expand through the bore of the inner ring.

If cylindrical roller bearings having one ring without flanges, needle roller bearings or CARB toroidal roller bearings are being used, both bearing rings may be mounted with an interference fit because axial displacement will take place within the bearing.

Table 2

## Shaft fit tolerances for solid steel shafts

Classification for metric radial ball and roller bearings with cylindrical bore, Classes ABEC-1, RBEC-1 (except inch dimensioned taper roller bearings)

Conditions	Examples	Shaft diameter, mm				Tolerance <sup>11)</sup>
		Ball bearings <sup>1)</sup>	Cylindrical roller bearings	Taper roller bearings	CARB and spherical roller bearings	
<b>Rotating inner ring load or direction of load indeterminate</b>						
Light and variable loads (P ≤ 0.05 C)	Conveyors, lightly loaded gearbox bearings	≤ 17	–	–	–	js5 (h5) <sup>2)</sup>
		18 to 100	≤ 25	≤ 25	–	j6 (js5) <sup>2)</sup>
		101 to 140	26 to 60	26 to 60	–	k6
		–	61 to 140	61 to 140	–	m6
Normal to heavy loads (P > 0.05 C)	Bearing applications generally, electric motors, turbines, pumps, gearing, wood working machines, windmills	≤ 10	–	–	–	js5
		11 to 17	–	–	–	j5 (js5) <sup>2)</sup>
		18 to 100	–	–	< 25	k5 <sup>3)</sup>
		–	≤ 30	≤ 40	–	k6
		101 to 140	31 to 50	–	25 to 40	m5
		141 to 200	–	41 to 65	–	m6
		–	51 to 65	–	41 to 60	n5 <sup>4)</sup>
		201 to 500	66 to 100	66 to 200	61 to 100	n6 <sup>4)</sup>
		–	101 to 280	201 to 360	101 to 200	p6 <sup>4)</sup>
		> 500	–	–	–	p7 <sup>4)</sup>
Heavy to very heavy loads and shock loads with difficult working conditions (P > 0.1 C)	Axle boxes for heavy railway vehicles, traction motors, rolling mills	–	51 to 65	–	51 to 70	n5 <sup>4)</sup>
		–	66 to 85	51 to 110	–	n6 <sup>4)</sup>
		–	86 to 140	111 to 200	71 to 140	p6 <sup>4)</sup>
		–	141 to 300	201 to 500	141 to 280	r6 <sup>4)</sup>
		–	301 to 500	–	281 to 400	s6min ± IT6/2 <sup>4) 6)</sup>
		–	> 500	> 500	> 400	s7min ± IT7/2 <sup>4) 6)</sup>
High demands on running accuracy with light loads (P ≤ 0.05 C)	Machine tools	8 to 240	–	–	–	js4
		–	25 to 40	25 to 40	–	js4 (j5) <sup>7)</sup>
		–	41 to 140	41 to 140	–	k4 (k5) <sup>7)</sup>
		–	141 to 200	141 to 200	–	m5
		–	201 to 500	201 to 500	–	n5
<b>Stationary inner ring load</b>						
Easy axial displacement of inner ring on shaft desirable	Wheels on non-rotating axles					g6 <sup>8)</sup>
Easy axial displacement of inner ring on shaft unnecessary	Tension pulleys, rope sheaves					h6
<b>Axial loads only</b>						
	Bearing applications of all kinds	≤ 250	≤ 250	≤ 250	≤ 250	j6
		> 250	> 250	> 250	> 250	js6

1) For normally to heavily loaded ball bearings (P > 0.05 C), radial clearance greater than Normal is often needed when the shaft tolerances in the table above are used. Sometimes the working conditions require tighter fits to prevent ball bearing inner rings from turning (creeping) on the shaft. If proper clearance, mostly larger than Normal clearance is selected, the tolerances below can then be used. For additional information please contact SKF Application Engineering.

k4 for shaft diameters 10 to 17 mm, k5 for shaft diameters 18 to 25 mm, m5 for shaft diameters 26 to 140 mm, n6 for shaft diameters 141 to 300 mm, p6 for shaft diameters 301 to 500 mm

2) The tolerance in brackets applies to stainless steel bearings

3) For stainless steel bearings within the diameter range 17 to 30 mm, tolerance j5 applies

4) Bearings with radial internal clearance greater than Normal are recommended.

5) Bearings with radial internal clearance greater than Normal are recommended for d ≤ 150 mm. For d > 150 mm bearings with radial internal clearance greater than Normal may be necessary.

6) Please consult SKF Application Engineering for tolerance values.

7) The tolerances in brackets apply to taper roller bearings. For lightly loaded taper roller bearings adjusted via the inner ring, js5 or js6 should be used

8) Tolerance f6 can be selected for large bearings to provide easy displacement

9) For ABEC-5 bearings, use Table 18; for higher precision bearings, other recommendations apply. Consult with SKF Application Engineering.

10) Shaft tolerances for Y-Bearings (setscrew mounted) are available from SKF Application Engineering.

11) See Table 8 for specific shaft diameters



Table 3

## Shaft fit tolerances for thrust bearings on solid steel shafts

Conditions	Shaft diameter, mm	Tolerance <sup>1)</sup>
<b>Axial loads only</b>		
Thrust ball bearings	–	h6
Cylindrical roller thrust bearings	–	h6 (h8)
Cylindrical roller and cage thrust assemblies	–	h8
<b>Combined radial and axial loads acting on spherical roller thrust bearings</b>		
Stationary load on shaft washer	≤ 250	j6
	> 250	js6
Rotating load on shaft washer, or direction of load indeterminate	≤ 200	k6
	201 to 400	m6
	> 400	n6

1) See **Table 8** for specific shaft diameters

Table 4

## Housing fit tolerances for cast Iron and steel housings (solid housings)

Classification for metric radial ball and roller bearings tolerance classes ABEC-1, RBEC-1 (except inch dimensioned taper roller bearings)

Conditions	Examples	Tolerance <sup>1) 4)</sup>	Displacement of outer ring
<b>Rotating outer ring load</b>			
Heavy loads on bearings in thin-walled housings, heavy shock loads (P > 0.10 C)	Roller bearing wheel hubs, big-end bearings	P7	Cannot be displaced
Normal to heavy loads (P > 0.05 C)	Ball bearing wheel hubs, big-end bearings, crane traveling wheels	N7	Cannot be displaced
Light and variable loads (P ≤ 0.05 C)	Conveyor rollers, rope sheaves, belt tensioner pulleys	M7	Cannot be displaced
<b>Direction of load indeterminate</b>			
Heavy shock loads	Electric traction motors	M7	Cannot be displaced
Normal and heavy loads (P > 0.06 C), axial displacement of outer ring unnecessary	Electric motors, pumps, crankshaft bearings	K7	Cannot be displaced as a rule
<b>Accurate or quiet running <sup>2)</sup></b>			
Ball bearings	Small electric motors	J6 <sup>3)</sup>	Can be displaced
Taper roller bearings	When adjusted via the outer ring	JS5	–
	Axially located outer ring	K5	–
	Rotating outer ring load	M5	–

1) For ball bearings with D ≤ 100 mm, tolerance grade IT6 is often preferable and is recommended for bearings with thin-walled rings, e.g. in the 7, 8 or 9 Dimension Series. For these series, cylindricity tolerances IT4 are also recommended.

2) For ABEC-5 bearings, use Table 19; For higher precision bearings, other recommendations apply. Contact SKF Application Engineering

3) When easy displacement is required use H6 instead of J6

4) See **Table 9** for specific housing bore diameters

## Dimensional, form, and running accuracy requirements

The accuracy of cylindrical bearing seatings on shafts and in housing bores should correspond to the accuracy of the bearings used. The following guideline values for dimensional, form and running accuracy are given for machining seatings and abutments.

## Dimensional tolerances

For bearings made with normal tolerances, the dimensional accuracy of the cylindrical seatings on the shaft is shown in **Tables 2** and **3**. For housings, see **Tables 4, 5** and **6**. For bearings with higher accuracy, correspondingly higher tolerances should be used; for ABEC 5 bearings see **Tables 18** and **19** (pages 85 and 86). Where adapter or withdrawal sleeves are used on cylindrical shafts, wider diameter tolerances can be permitted than for bearing seatings (see **Table 7** page 57 for inch sleeves and **Table 11** page 80 for metric sleeves). The basic tolerance for the standardized tolerance series to ISO/R286-1962 will be found in **Table 10** (page 80).

## Tolerances for cylindrical form

The cylindricity tolerance  $t$ , as defined in ISO 1101-1983 should be 1 to 2 IT grades better than the prescribed dimensional tolerance, depending on requirements. For example, if a bearing seating on a shaft has been machined to tolerance m6, then the accuracy of form should be to IT5 or IT4. The tolerance value  $t_1$  for cylindricity is obtained for an assumed shaft diameter of 150 mm from  $t_1 = IT5/2 = 18/2 = 9\mu\text{m}$  or from  $t_1 = IT4/2 = 12/2 = 6\mu\text{m}$ . **Table 13** (page 81) gives guideline values for the cylindrical form tolerance (and for the total runout tolerance  $t_3$  if preferred).

## Tolerance for perpendicularity

Abutments for bearing rings should have a rectangularity tolerance as defined in ISO 1101-1983, which is better by at least one IT grade than the diameter tolerance of the associated cylindrical seating. For thrust bearing washer seatings, the perpendicularity tolerance should not exceed the values to IT5. Guideline values for the rectangularity tolerance  $t_2$  (and for the total axial runout  $t_4$  will be found in **Table 13**.

Table 5

### Housing fit tolerances for cast iron and steel housings (split or solid housings)

Classification for metric radial ball and roller bearings tolerance classes ABEC-1, RBEC-1 (except inch dimensioned taper roller bearings)

Conditions	Examples	Tolerance <sup>1) 4)</sup>	Displacement of outer ring
<b>Direction of load indeterminate</b>			
Light to normal loads ( $P \leq 0.10 C$ ), axial displacement of outer ring desirable	Medium-sized electrical machines, pumps, crankshaft bearings	J7	Can be displaced as a rule
<b>Stationary outer ring load</b>			
Loads of all kinds railway axle boxes	General engineering,	H7 <sup>2)</sup>	Can be displaced
Light to normal loads ( $P \leq 0.10 C$ ) with simple working conditions	General engineering	H8 <sup>3)</sup>	Can be displaced
Heat conduction through shaft	Drying cylinders, large electrical machines with spherical roller bearings	G7 <sup>2)</sup>	Can be displaced

1) For ball bearings with  $D \leq 100$  mm, tolerance grade IT6 is often preferable and is recommended for bearings with thin-walled rings, e.g. in the 7, 8 or 9 Dimension Series. For these series, cylindricity tolerances IT4 are also recommended.

2) For large bearings ( $D > 250$  mm) and temperature differences between outer ring and housing  $> 10$  °C, the fit tolerance should be loosened one class, i.e. a G7 should be used instead of H7, and an F7 should be used instead of G7.

3) For applications such as electric motors and centrifugal pumps, an H6 should be used to reduce the amount of looseness in the housing, while still allowing the bearing to float.

4) See Table 9 for specific housing bore diameters

Table 6

### Housing fit tolerances for thrust bearings in cast iron and steel housings

Conditions	Tolerance <sup>1)</sup>	Remarks
<b>Axial loads only</b>		
Thrust ball bearings	H8	For less accurate bearing arrangements there can be a radial clearance of up to 0.001 D
Cylindrical roller thrust bearings	H7 (H9)	
Cylindrical roller and cage thrust assemblies	H10	
Spherical roller thrust bearings where separate bearings provide radial location	–	Housing washer must be fitted with adequate radial clearance so that no radial load whatsoever can act on the thrust bearings
<b>Combined radial and axial loads on spherical roller thrust bearings</b>		
Stationary load on housing washer	H7	
Rotating load on housing washer	M7	

1) See Table 9 for specific housing bore diameters

## Surface roughness of bearing seatings

The roughness of bearing seating surfaces does not have the same degree of influence on bearing performance as the dimensional, form and running accuracies. However, a desired interference fit is much more accurately obtained the smoother the mating surfaces are. For less critical bearing arrangements, relatively large surface roughness is permitted. For bearing arrangements where demands in respect to accuracy are high, guideline values for the mean surface roughness  $R_a$  are given in Table 12 (page 80) for different dimensional accuracies of the bearing seatings. These guideline values apply to ground seatings, which are normally assumed for shaft seatings. For fine turned seatings, the roughness may be a class or two higher.

## Fits for hollow shafts

If bearings are to be mounted with an interference fit on a hollow shaft it is generally necessary to use a heavier interference fit than would be used for a solid shaft in order to achieve the same surface pressure between the inner ring and shaft seating. The following diameter ratios are important when deciding on the fit to be used:

$$c_i = \frac{d_i}{d} \text{ and } c_e = \frac{d}{d_e}$$

The fit is not appreciably affected until the diameter ratio of the hollow shaft  $c_i \geq 0.5$ . If the outside diameter of the inner ring is not known, the diameter ratio  $c_e$  can be calculated with sufficient accuracy using the equation

$$c_e = \frac{d}{k(D - d) + d}$$

where

$c_i$  = diameter ratio of the hollow shaft

$c_e$  = diameter ratio of the inner ring

$d$  = outside diameter of the hollow shaft, bore diameter of bearing, mm

$d_i$  = internal diameter of the hollow shaft, mm

$d_e$  = average outside diameter of the inner ring, mm

$D$  = outside bearing diameter, mm

$k$  = a factor for the bearing type

for self-aligning ball bearings in the 22 and 23 series,  $k = 0.25$

for cylindrical roller bearings,  $k = 0.25$

for all other bearings,  $k = 0.3$

Table 7

Shaft tolerance limits for adapter mounting and pillow block seal seatings<sup>3</sup> (inch)

Nominal dia. inches	Over	Including	S-1 <sup>1)</sup>	Dia. tolerance limits inches S-2 and S-3 <sup>2)</sup>
1/2		1	0.000 -0.002	- -
1		2	0.000 -0.003	0.000 -0.003
2		4	0.000 -0.004	0.000 -0.003
4		6	0.000 -0.005	0.000 -0.003
6		10	0.000 -0.006	0.000 -0.004
10		15	0.000 -0.006	0.000 -0.005
15		-	0.000 -0.006	0.000 -0.006

- 1) "S-1" values are deviations from nominal shaft dimensions for mounting via an adapter or sleeve. The out-of-round (OOR) and cylindrical form tolerance for shaft diameters ≤ 4 inches: OOR ≤ .0005 in; ≥ 4 in. OOR ≤ .001 in; total indicated runout (TIR) ≤ 1/2 OOR.
- 2) "S-2" and "S-3" values are deviations for nominal shaft dimensions for pillow block mountings (except Unit Ball and Unit Roller). The shaft diameter recommendations assure proper operation of the seals, while the recommended shaft tolerance for the cylindrical bearing seat should be taken from Table 2.
- 3) See Table 11 for metric shaft tolerances

To determine the requisite interference fit for a bearing to be mounted on a hollow shaft, use the mean probable interference between the shaft seating and bearing bore obtained for the tolerance recommendation for a solid shaft of the same diameter. If the plastic deformation (smoothing) of the mating surfaces produced during mounting is neglected, then the effective interference can be equated to the mean probable interference.

The interference  $\Delta_H$  needed for a hollow steel shaft can then be determined in relation to the known interference  $\Delta_V$  for the solid shaft from **Diagram 1**.  $\Delta_V$  equals the mean value of the smallest and largest values of the probable interference for the solid shaft. The tolerance for the hollow shaft is then selected so that the mean probable interference is as close as possible to the interference  $\Delta_H$  obtained from **Diagram 1**.

**Example**

A 6208 deep groove ball bearing with  $d = 40$  mm and  $D = 80$  mm is to be mounted on a hollow shaft having a diameter ratio  $c_i = 0.8$ . From **Table 2** (page 54), the recommended shaft tolerance is "k5" resulting in an interference fit of 0.0001 in to 0.0010 in. The mean probable interference  $\Delta_V = (0.0001 + 0.0010)/2 = 0.00055$  in. For  $c_i = 0.8$  and

$$c_e = \frac{40}{0.3(80 - 40) + 40} = 0.77$$

so that from **Diagram 1** the ratio  $\Delta_H/\Delta_V = 1.7$ . Thus the requisite interference for the hollow shaft  $\Delta_H = 1.7 \times 0.00055$  in = 0.0009 in. Consequently, tolerance m6 is selected for the hollow shaft as this gives a mean probable interference of this order.

Diagram 1

Relation of interference  $\Delta_H$ , needed for a hollow steel shaft, to the known interference  $\Delta_V$  for a solid steel shaft

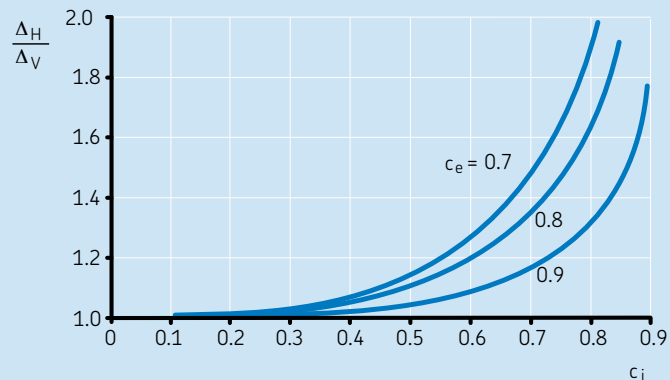
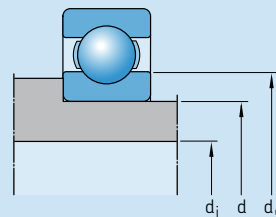

Table 8

## Shaft bearing-seat diameters (values in inches)

Bearing bore diameter		f7			g6			h5			h6			
mm	inches		Shaft dia.		Resultant fit <sup>1)</sup> in 0.0001"	Shaft dia.		Resultant fit <sup>1)</sup> in 0.0001"	Shaft dia.		Resultant fit <sup>1)</sup> in 0.0001"	Shaft dia.		Resultant fit <sup>1)</sup> in 0.0001"
	max.	min.	max.	min.		max.	min.		max.	min.		max.	min.	
4	0.1575	0.1572	0.1571	0.1566	9 L 1 L	0.1573	0.1570	5 L 1 T	0.1575	0.1573	2 L 3 T	0.1575	0.1572	3 L 3 T
5	0.1969	0.1966	0.1965	0.1960		0.1967	0.1964		0.1969	0.1967		0.1969	0.1966	
6	0.2362	0.2359	0.2358	0.2353		0.2360	0.2357		0.2362	0.2360		0.2362	0.2359	
7	0.2756	0.2753	0.2751	0.2745	11 L 2 L	0.2754	0.2750	6 L 1 T	0.2756	0.2754	2 L 3 T	0.2756	0.2752	4 L 3 T
8	0.3150	0.3147	0.3145	0.3139		0.3148	0.3144		0.3150	0.3148		0.3150	0.3146	
9	0.3543	0.3540	0.3538	0.3532		0.3541	0.3537		0.3543	0.3541		0.3543	0.3539	
10	0.3937	0.3934	0.3932	0.3926		0.3935	0.3931		0.3937	0.3935		0.3937	0.3933	
12	0.4724	0.4721	0.4718	0.4711	13 L 3 L	0.4722	0.4717	7 L 1 T	0.4724	0.4721	3 L 3 T	0.4724	0.4720	4 L 3 T
15	0.5906	0.5903	0.5900	0.5893		0.5904	0.5899		0.5906	0.5903		0.5906	0.5902	
17	0.6693	0.6690	0.6687	0.6680		0.6691	0.6686		0.6693	0.6690		0.6693	0.6689	
20	0.7874	0.7870	0.7866	0.7858	16 L 4 L	0.7871	0.7866	8 L 1 T	0.7874	0.7870	4 L 4 T	0.7874	0.7869	5 L 4 T
25	0.9843	0.9839	0.9835	0.9827		0.9840	0.9835		0.9843	0.9839		0.9843	0.9838	
30	1.1811	1.1807	1.1803	1.1795		1.1808	1.1803		1.1811	1.1807		1.1811	1.1806	
35	1.3780	1.3775	1.3770	1.3760	20 L 5 L	1.3776	1.3770	10 L 1 T	1.3780	1.3776	4 L 5 T	1.3780	1.3774	6 L 5 T
40	1.5748	1.5743	1.5738	1.5728		1.5744	1.5738		1.5748	1.5744		1.5748	1.5742	
45	1.7717	1.7712	1.7707	1.7697		1.7713	1.7707		1.7717	1.7713		1.7717	1.7711	
50	1.9685	1.9680	1.9675	1.9665		1.9681	1.9675		1.9685	1.9681		1.9685	1.9679	
55	2.1654	2.1648	2.1642	2.1630	24 L 6 L	2.1650	2.1643	11 L 2 T	2.1654	2.1649	5 L 6 T	2.1654	2.1647	7 L 6 T
60	2.3622	2.3616	2.3610	2.3598		2.3618	2.3611		2.3622	2.3617		2.3622	2.3615	
65	2.5591	2.5585	2.5579	2.5567		2.5587	2.5580		2.5591	2.5586		2.5591	2.5584	
70	2.7559	2.7553	2.7547	2.7535		2.7555	2.7548		2.7559	2.7554		2.7559	2.7552	
75	2.9528	2.9522	2.9516	2.9504		2.9524	2.9517		2.9528	2.9523		2.9528	2.9521	
80	3.1496	3.1490	3.1484	3.1472		3.1492	3.1485		3.1496	3.1491		3.1496	3.1489	
85	3.3465	3.3457	3.3451	3.3437	28 L 6 L	3.3460	3.3452	13 L 3 T	3.3465	3.3459	6 L 8 T	3.3465	3.3456	9 L 8 T
90	3.5433	3.5425	3.5419	3.5405		3.5428	3.5420		3.5433	3.5427		3.5433	3.5424	
95	3.7402	3.7394	3.7388	3.7374		3.7397	3.7389		3.7402	3.7396		3.7402	3.7393	
100	3.9370	3.9362	3.9356	3.9342		3.9365	3.9357		3.9370	3.9364		3.9370	3.9361	
105	4.1339	4.1331	4.1325	4.1311		4.1334	4.1326		4.1339	4.1333		4.1339	4.1330	
110	4.3307	4.3299	4.3293	4.3279		4.3302	4.3294		4.3307	4.3301		4.3307	4.3298	
115	4.5276	4.5268	4.5262	4.5248		4.5271	4.5263		4.5276	4.5270		4.5276	4.5267	
120	4.7244	4.7236	4.7230	4.7216		4.7239	4.7231		4.7244	4.7238		4.7244	4.7235	
125	4.9213	4.9203	4.9196	4.9180	33 L 7 L	4.9207	4.9198	15 L 4 T	4.9213	4.9206	7 L 10 T	4.9213	4.9203	10 L 10 T
130	5.1181	5.1171	5.1164	5.1148		5.1175	5.1166		5.1181	5.1174		5.1181	5.1171	
140	5.5118	5.5108	5.5101	5.5085		5.5112	5.5103		5.5118	5.5111		5.5118	5.5108	
150	5.9055	5.9045	5.9038	5.9022		5.9049	5.9040		5.9055	5.9048		5.9055	5.9045	
160	6.2992	6.2982	6.2975	6.2959		6.2986	6.2977		6.2992	6.2985		6.2992	6.2982	
170	6.6929	6.6919	6.6912	6.6896		6.6923	6.6914		6.6929	6.6922		6.6929	6.6919	
180	7.0866	7.0856	7.0849	7.0833		7.0860	7.0851		7.0866	7.0859		7.0866	7.0856	
190	7.4803	7.4791	7.4783	7.4765		38 L 8 L	7.4797		7.4786	17 L 6 T		7.4803	7.4795	
200	7.8740	7.8728	7.8720	7.8702	7.8734		7.8723	7.8740	7.8732		7.8740	7.8729		
220	8.6614	8.6602	8.6594	8.6576	8.6608		8.6597	8.6614	8.6606		8.6614	8.6603		
240	9.4488	9.4476	9.4468	9.4450	9.4482		9.4471	9.4488	9.4480		9.4488	9.4477		
250	9.8425	9.8413	9.8405	9.8387	9.8419		9.8408	9.8425	9.8417		9.8425	9.8414		

Note: To convert inches to mm, multiply inches by 25.4

<sup>1)</sup> L indicates "LOOSE" fit, T indicates "TIGHT" fit

Table 8

Shaft bearing-seat diameters (values in inches)														
Bearing bore diameter			f7			g6			h5			h6		
mm	inches		Shaft dia.		Resultant fit <sup>1)</sup> in 0.0001"	Shaft dia.		Resultant fit <sup>1)</sup> in 0.0001"	Shaft dia.		Resultant fit <sup>1)</sup> in 0.0001"	Shaft dia.		Resultant fit <sup>1)</sup> in 0.0001"
	max.	min.	max.	min.		max.	min.		max.	min.		max.	min.	
260	10.2362	10.2348	10.2340	10.2319		10.2355	10.2343		10.2362	10.2353		10.2362	10.2349	
280	11.0236	11.0222	11.0214	11.0193	43 L	11.0229	11.0217	19 L	11.0236	11.0227	9 L	11.0236	11.0223	13 L
300	11.8110	11.8096	11.8088	11.8067	8 L	11.8103	11.8091	7 T	11.8110	11.8101	14 T	11.8110	11.8097	14 T
310	12.2047	12.2033	12.2025	12.2004		12.2040	12.2028		12.2047	12.2038		12.2047	12.2034	
320	12.5984	12.5968	12.5959	12.5937		12.5977	12.5963		12.5984	12.5974		12.5984	12.5970	
340	13.3858	13.3842	13.3833	13.3811		13.3851	13.3837		13.3858	13.3848		13.3858	13.3844	
350	13.7795	13.7779	13.7770	13.7748	47 L	13.7788	13.7774	21 L	13.7795	13.7785	10 L	13.7795	13.7781	14 L
360	14.1732	14.1716	14.1707	14.1685	9 L	14.1725	14.1711	9 T	14.1732	14.1722	16 T	14.1732	14.1718	16 T
380	14.9606	14.9590	14.9581	14.9559		14.9599	14.9585		14.9606	14.9596		14.9606	14.9592	
400	15.7480	15.7464	15.7455	15.7433		15.7473	15.7459		15.7480	15.7470		15.7480	15.7466	
420	16.5354	16.5336	16.5327	16.5302		16.5346	16.5330		16.5354	16.5343		16.5354	16.5338	
440	17.3228	17.3210	17.3201	17.3176	52 L	17.3220	17.3204	24 L	17.3228	17.3217	11 L	17.3228	17.3212	16 L
460	18.1102	18.1084	18.1075	18.1050	9 L	18.1094	18.1078	10 T	18.1102	18.1091	18 T	18.1102	18.1086	18 T
480	18.8976	18.8958	18.8949	18.8924		18.8968	18.8952		18.8976	18.8965		18.8976	18.8960	
500	19.6850	19.6832	19.6823	19.6798		19.6842	19.6826		19.6850	19.6839		19.6850	19.6834	
530	20.8661	20.8641	20.8631	20.8605		20.8652	20.8635		—	—		20.8661	20.8644	
560	22.0472	22.0452	22.0442	22.0416	56 L	22.0463	22.0446	26 L	—	—		22.0472	22.0455	17 L
600	23.6220	23.6200	23.6190	23.6164	10 L	23.6211	23.6194	11 T	—	—		23.6220	23.6203	20 T
630	24.8031	24.8011	24.8001	24.7975		24.8022	24.8005		—	—		24.8031	24.8014	
660	25.9843	25.9813	25.9811	25.9782		25.9834	25.9814		—	—		25.9843	25.9823	
670	26.3780	26.3750	26.3748	26.3719		26.3771	26.3751		—	—		26.3780	26.3760	
710	27.9528	27.9498	27.9496	27.9467	61 L	27.9519	27.9499	29 L	—	—		27.9528	27.9508	20 L
750	29.5276	29.5246	29.5244	29.5215	2 L	29.5267	29.5247	21 T	—	—		29.5276	29.5256	30 T
780	30.7087	30.7057	30.7055	30.7026		30.7078	30.7058		—	—		30.7087	30.7067	
800	31.4961	31.4931	31.4929	31.4900		31.4952	31.4932		—	—		31.4961	31.4941	
850	33.4646	33.4607	33.4611	33.4577		33.4636	33.4614		—	—		33.4646	33.4624	
900	35.4331	35.4292	35.4296	35.4262	69 L	35.4321	35.4299	32 L	—	—		35.4331	35.4309	22 L
950	37.4016	37.3977	37.3981	37.3947	4 T	37.4006	37.3984	29 T	—	—		37.4016	37.3994	39 T
1000	39.3701	39.3662	39.3666	39.3632		39.3691	39.3669		—	—		39.3701	39.3679	
1060	41.7323	41.7274	41.7284	41.7247		41.7312	41.7286		—	—		41.7323	41.7297	
1120	44.0945	44.0896	44.0906	44.0869	76 L	44.0934	44.0908	37 L	—	—		44.0945	44.0919	26 L
1180	46.4567	46.4518	46.4528	46.4491	10 T	46.4556	46.4530	38 T	—	—		46.4567	46.4541	49 T
1250	49.2126	49.2077	49.2087	49.2050		49.2115	49.2089		—	—		49.2126	49.2100	

Note: To convert inches to mm, multiply inches by 25.4

<sup>1)</sup> L indicates "LOOSE" fit, T indicates "TIGHT" fit

Table 8

## Shaft bearing-seat diameters (values in inches)

Bearing bore diameter			h8			j5			j6			js4		
mm	inches		Shaft dia.		Resultant fit <sup>1)</sup> in 0.0001"	Shaft dia.		Resultant fit <sup>1)</sup> in 0.0001"	Shaft dia.		Resultant fit <sup>1)</sup> in 0.0001"	Shaft dia.		Resultant fit <sup>1)</sup> in 0.0001"
	max.	min.	max.	min.		max.	min.		max.	min.		max.	min.	
4	0.1575	0.1572	0.1575	0.1568	7 L 3 T	0.1576	0.1574	1 L 4 T	0.1577	0.1574	1 L 5 T	—	—	
5	0.1969	0.1966	0.1969	0.1962		0.1970	0.1968		0.1971	0.1968		—	—	
6	0.2362	0.2359	0.2362	0.2355		0.2363	0.2361		0.2364	0.2361		—	—	
7	0.2756	0.2753	0.2756	0.2747	9 L 3 T	0.2758	0.2755	1 L 5 T	0.2759	0.2755	1 L 6 T	0.2757	0.2755	1 L 4 T
8	0.3150	0.3147	0.3150	0.3141		0.3152	0.3149		0.3153	0.3149		0.3151	0.3149	
9	0.3543	0.3540	0.3543	0.3534		0.3545	0.3542		0.3546	0.3542		0.3544	0.3542	
10	0.3937	0.3934	0.3937	0.3928		0.3939	0.3936		0.3940	0.3936		0.3938	0.3936	
12	0.4724	0.4721	0.4724	0.4713	11 L 3 T	0.4726	0.4723	1 L 5 T	0.4727	0.4723	1 L 6 T	0.4725	0.4723	1 L 4 T
15	0.5906	0.5903	0.5906	0.5895		0.5908	0.5905		0.5909	0.5905		0.5907	0.5905	
17	0.6693	0.6690	0.6693	0.6682		0.6695	0.6692		0.6696	0.6692		0.6694	0.6692	
20	0.7874	0.7870	0.7874	0.7861	13 L 4 T	0.7876	0.7872	2 L 6 T	0.7878	0.7872	2 L 8 T	0.7875	0.7872	2 L 5 T
25	0.9843	0.9839	0.9843	0.9830		0.9845	0.9841		0.9847	0.9841		0.9844	0.9841	
30	1.1811	1.1807	1.1811	1.1798		1.1813	1.1809		1.1815	1.1809		1.1812	1.1809	
35	1.3780	1.3775	1.3780	1.3765	15 L 5 T	1.3782	1.3778	2 L 7 T	1.3784	1.3778	2 L 9 T	1.3781	1.3778	2 L 6 T
40	1.5748	1.5743	1.5748	1.5733		1.5750	1.5746		1.5752	1.5746		1.5749	1.5746	
45	1.7717	1.7712	1.7717	1.7702		1.7719	1.7715		1.7721	1.7715		1.7718	1.7715	
50	1.9685	1.9680	1.9685	1.9670		1.9687	1.9683		1.9689	1.9683		1.9686	1.9683	
55	2.1654	2.1648	2.1654	2.1636	18 L 6 T	2.1656	2.1651	3 L 8 T	2.1659	2.1651	3 L 11 T	2.1655	2.1652	2 L 7 T
60	2.3622	2.3616	2.3622	2.3604		2.3624	2.3619		2.3627	2.3619		2.3623	2.3620	
65	2.5591	2.5585	2.5591	2.5573		2.5593	2.5588		2.5596	2.5588		2.5592	2.5589	
70	2.7559	2.7553	2.7559	2.7541		2.7561	2.7556		2.7564	2.7556		2.7560	2.7557	
75	2.9528	2.9522	2.9528	2.9510		2.9530	2.9525		2.9533	2.9525		2.9529	2.9526	
80	3.1496	3.1490	3.1496	3.1478		3.1498	3.1493		3.1501	3.1493		3.1497	3.1494	
85	3.3465	3.3457	3.3465	3.3444	21 L 8 T	3.3467	3.3461	4 L 10 T	3.3470	3.3461	4 L 13 T	3.3467	3.3463	2 L 10 T
90	3.5433	3.5425	3.5433	3.5412		3.5435	3.5429		3.5438	3.5429		3.5435	3.5431	
95	3.7402	3.7394	3.7402	3.7381		3.7404	3.7398		3.7407	3.7398		3.7404	3.7400	
100	3.9370	3.9362	3.9370	3.9349		3.9372	3.9366		3.9375	3.9366		3.9372	3.9368	
105	4.1339	4.1331	4.1339	4.1318		4.1341	4.1335		4.1344	4.1335		4.1341	4.1337	
110	4.3307	4.3299	4.3307	4.3286		4.3309	4.3303		4.3312	4.3303		4.3309	4.3305	
115	4.5276	4.5268	4.5276	4.5255		4.5278	4.5272		4.5281	4.5272		4.5278	4.5274	
120	4.7244	4.7236	4.7244	4.7223		4.7246	4.7240		4.7249	4.7240		4.7246	4.7242	
125	4.9213	4.9203	4.9213	4.9188	25 L 10 T	4.9216	4.9209	4 L 13 T	4.9219	4.9209	4 L 16 T	4.9215	4.9210	3 L 12 T
130	5.1181	5.1171	5.1181	5.1156		5.1184	5.1177		5.1187	5.1177		5.1183	5.1178	
140	5.5118	5.5108	5.5118	5.5093		5.5121	5.5114		5.5124	5.5114		5.5120	5.5115	
150	5.9055	5.9045	5.9055	5.9030		5.9058	5.9051		5.9061	5.9051		5.9057	5.9052	
160	6.2992	6.2982	6.2992	6.2967		6.2995	6.2988		6.2998	6.2988		6.2994	6.2989	
170	6.6929	6.6919	6.6929	6.6904		6.6932	6.6925		6.6935	6.6925		6.6931	6.6926	
180	7.0866	7.0856	7.0866	7.0841		7.0869	7.0862		7.0872	7.0862		7.0868	7.0863	
190	7.4803	7.4791	7.4803	7.4775		28 L 12 T	7.4806		7.4798	5 L 15 T		7.4809	7.4798	
200	7.8740	7.8728	7.8740	7.8712	7.8743		7.8735	7.8746	7.8735		7.8743	7.8737		
220	8.6614	8.6602	8.6614	8.6586	8.6617		8.6609	8.6620	8.6609		8.6617	8.6611		
240	9.4488	9.4476	9.4488	9.4460	9.4491		9.4483	9.4494	9.4483		9.4491	9.4485		
250	9.8425	9.8413	9.8425	9.8397	9.8428		9.8420	9.8431	9.8420		9.8428	9.8422		

Note: To convert inches to mm, multiply inches by 25.4

<sup>1)</sup> L indicates "LOOSE" fit, T indicates "TIGHT" fit

Table 8

Shaft bearing-seat diameters (values in inches)														
Bearing bore diameter			h8			j5			j6			js4		
			Shaft dia.		Resultant fit <sup>1)</sup> in 0.0001"	Shaft dia.		Resultant fit <sup>1)</sup> in 0.0001"	Shaft dia.		Resultant fit <sup>1)</sup> in 0.0001"	Shaft dia.		Resultant fit <sup>1)</sup> in 0.0001"
mm	inches		max.	min.		max.	min.		max.	min.		max.	min.	
260	10.2362	10.2348	10.2362	10.2330		10.2365	10.2356		10.2368	10.2356		10.2365	10.2359	
280	11.0236	11.0222	11.0236	11.0204	32 L	11.0239	11.0230	6 L	11.0242	11.0230	6 L	11.0239	11.0233	
300	11.8110	11.8096	11.8110	11.8078	14 T	11.8113	11.8104	17 T	11.8116	11.8104	20 T	11.8113	11.8107	
310	12.2047	12.2033	12.2047	12.2015		12.2050	12.2041		12.2053	12.2041		12.2050	12.2044	
320	12.5984	12.5968	12.5984	12.5949		12.5987	12.5977		12.5991	12.5977		—	—	
340	13.3858	13.3842	13.3858	13.3823		13.3861	13.3851		13.3865	13.3851		—	—	
350	13.7795	13.7779	13.7795	13.7760	35 L	13.7798	13.7788	7 L	13.7802	13.7788	7 L	—	—	
360	14.1732	14.1716	14.1732	14.1697	16 T	14.1735	14.1725	19 T	14.1739	14.1725	23 T	—	—	
380	14.9606	14.9590	14.9606	14.9571		14.9609	14.9599		14.9613	14.9599		—	—	
400	15.7480	15.7464	15.7480	15.7445		15.7483	15.7473		15.7487	15.7473		—	—	
420	16.5354	16.5336	16.5354	16.5316		16.5357	16.5346		16.5362	16.5346		—	—	
440	17.3228	17.3210	17.3228	17.3190	38 L	17.3231	17.3220	8 L	17.3236	17.3220	8 L	—	—	
460	18.1102	18.1084	18.1102	18.1064	18 T	18.1105	18.1094	21 T	18.1110	18.1094	26 T	—	—	
480	18.8976	18.8958	18.8976	18.8938		18.8979	18.8968		18.8984	18.8968		—	—	
500	19.6850	19.6832	19.6850	19.6812		19.6853	19.6842		19.6858	19.6842		—	—	
530	20.8661	20.8641	20.8661	20.8618		—	—		20.8670	20.8652		—	—	
560	22.0472	22.0452	22.0472	22.0429	43 L	—	—		22.0481	22.0463	9 L	—	—	
600	23.6220	23.6200	23.6220	23.6177	20 T	—	—		23.6229	23.6211	29 T	—	—	
630	24.8031	24.8011	24.8031	24.7988		—	—		24.8040	24.8022		—	—	
660	25.9843	25.9813	25.9843	25.9794		—	—		25.9853	25.9833		—	—	
670	26.3780	26.3750	26.3780	26.3731		—	—		26.3790	26.3770		—	—	
710	27.9528	27.9498	27.9528	27.9479	49 L	—	—		27.9538	27.9518	10 L	—	—	
750	29.5276	29.5246	29.5276	29.5227	30 T	—	—		29.5286	29.5266	40 T	—	—	
780	30.7087	30.7057	30.7087	30.7038		—	—		30.7097	30.7077		—	—	
800	31.4961	31.4931	31.4961	31.4912		—	—		31.4971	31.4951		—	—	
850	33.4646	33.4607	33.4646	33.4591		—	—		33.4657	33.4635		—	—	
900	35.4331	35.4292	35.4331	35.4276	55 L	—	—		35.4342	35.4320	11 L	—	—	
950	37.4016	37.3977	37.4016	37.3961	39 T	—	—		37.4027	37.4005	50 T	—	—	
1000	39.3701	39.3662	39.3701	39.3646		—	—		39.3712	39.3690		—	—	
1060	41.7323	41.7274	41.7323	41.7258		—	—		41.7336	41.7310		—	—	
1120	44.0945	44.0896	44.0945	44.0880	65 L	—	—		44.0958	44.0932	13 L	—	—	
1180	46.4567	46.4518	46.4567	46.4502	49 T	—	—		46.4580	46.4554	62 T	—	—	
1250	49.2126	49.2077	49.2126	49.2061		—	—		49.2139	49.2113		—	—	

Note: To convert inches to mm, multiply inches by 25.4

<sup>1)</sup> L indicates "LOOSE" fit, T indicates "TIGHT" fit

Table 8

## Shaft bearing-seat diameters (values in inches)

Bearing bore diameter		js5				js6			k4			k5				
mm	inches		Shaft dia.		Resultant fit <sup>1)</sup> in 0.0001"	Shaft dia.		Resultant fit <sup>1)</sup> in 0.0001"	Shaft dia.		Resultant fit <sup>1)</sup> in 0.0001"	Shaft dia.		Resultant fit <sup>1)</sup> in 0.0001"		
	max.	min.	max.	min.		max.	min.		max.	min.		max.	min.			
4	0.1575	0.1572	0.1576	0.1574	1 L 4 T	0.1577	0.1573	2 L 5 T	0.1577	0.1575	0 T 5 T	0.1577	0.1575	0 T 5 T		
5	0.1969	0.1966	0.1970	0.1968		0.1971	0.1967		0.1971	0.1969		0.1971	0.1969		0.1971	0.1969
6	0.2362	0.2359	0.2363	0.2361		0.2364	0.2360		0.2364	0.2362		0.2364	0.2362		0.2364	0.2362
7	0.2756	0.2753	0.2757	0.2755	1 L 4 T	0.2758	0.2754	2 L 5 T	0.2758	0.2756	0 T 5 T	0.2759	0.2756	0 T 6 T		
8	0.3150	0.3147	0.3151	0.3149		0.3152	0.3148		0.3152	0.3150		0.3152	0.3150		0.3153	0.3150
9	0.3543	0.3540	0.3544	0.3542		0.3545	0.3541		0.3545	0.3543		0.3545	0.3543		0.3546	0.3543
10	0.3937	0.3934	0.3938	0.3936		0.3939	0.3935		0.3939	0.3937		0.3939	0.3937		0.3940	0.3937
12	0.4724	0.4721	0.4726	0.4722	2 L 5 T	0.4726	0.4722	2 L 5 T	0.4727	0.4724	0 T 6 T	0.4728	0.4724	0 T 7 T		
15	0.5906	0.5903	0.5908	0.5904		0.5908	0.5904		0.5909	0.5906		0.5909	0.5906		0.5910	0.5906
17	0.6693	0.6690	0.6695	0.6691		0.6695	0.6691		0.6696	0.6693		0.6696	0.6693		0.6697	0.6693
20	0.7874	0.7870	0.7876	0.7872	2 L 6 T	0.7876	0.7871	3 L 6 T	0.7877	0.7874	0 T 7 T	0.7878	0.7875	1 T 8 T		
25	0.9843	0.9839	0.9845	0.9841		0.9845	0.9840		0.9846	0.9843		0.9846	0.9843		0.9847	0.9844
30	1.1811	1.1807	1.1813	1.1809		1.1813	1.1808		1.1814	1.1811		1.1814	1.1811		1.1815	1.1812
35	1.3780	1.3775	1.3782	1.3778	2 L 7 T	1.3783	1.3777	3 L 8 T	1.3783	1.3781	1 T 8 T	1.3785	1.3781	1 T 10 T		
40	1.5748	1.5743	1.5750	1.5746		1.5751	1.5745		1.5751	1.5749		1.5751	1.5749		1.5753	1.5749
45	1.7717	1.7712	1.7719	1.7715		1.7720	1.7714		1.7720	1.7718		1.7720	1.7718		1.7722	1.7718
50	1.9685	1.9680	1.9687	1.9683		1.9688	1.9682		1.9688	1.9686		1.9688	1.9686		1.9690	1.9686
55	2.1654	2.1648	2.1656	2.1651	3 L 8 T	2.1658	2.1650	4 L 10 T	2.1658	2.1655	1 T 10 T	2.1660	2.1655	1 T 12 T		
60	2.3622	2.3616	2.3624	2.3619		2.3626	2.3618		2.3626	2.3623		2.3626	2.3623		2.3628	2.3623
65	2.5591	2.5585	2.5593	2.5588		2.5595	2.5587		2.5595	2.5592		2.5595	2.5592		2.5597	2.5592
70	2.7559	2.7553	2.7561	2.7556		2.7563	2.7555		2.7563	2.7560		2.7563	2.7560		2.7565	2.7560
75	2.9528	2.9522	2.9530	2.9525		2.9532	2.9524		2.9532	2.9529		2.9532	2.9529		2.9534	2.9529
80	3.1496	3.1490	3.1498	3.1493	3.1500	3.1492	3.1500	3.1497	3.1500	3.1497	3.1502	3.1497				
85	3.3465	3.3457	3.3468	3.3462	3 L 11 T	3.3469	3.3461	4 L 12 T	3.3470	3.3466	1 T 13 T	3.3472	3.3466	1 T 15 T		
90	3.5433	3.5425	3.5436	3.5430		3.5437	3.5429		3.5438	3.5434		3.5438	3.5434		3.5440	3.5434
95	3.7402	3.7394	3.7405	3.7399		3.7406	3.7398		3.7407	3.7403		3.7407	3.7403		3.7409	3.7403
100	3.9370	3.9362	3.9373	3.9367		3.9374	3.9366		3.9375	3.9371		3.9375	3.9371		3.9377	3.9371
105	4.1339	4.1331	4.1342	4.1336		4.1343	4.1335		4.1344	4.1340		4.1344	4.1340		4.1346	4.1340
110	4.3307	4.3299	4.3310	4.3304		4.3311	4.3303		4.3312	4.3308		4.3312	4.3308		4.3314	4.3308
115	4.5276	4.5268	4.5279	4.5273		4.5280	4.5272		4.5281	4.5277		4.5281	4.5277		4.5283	4.5277
120	4.7244	4.7236	4.7247	4.7241		4.7248	4.7240		4.7249	4.7245		4.7249	4.7245		4.7251	4.7245
125	4.9213	4.9203	4.9216	4.9209	4 L 13 T	4.9218	4.9208	5 L 15 T	4.9219	4.9214	1 T 16 T	4.9221	4.9214	1 T 18 T		
130	5.1181	5.1171	5.1184	5.1177		5.1186	5.1176		5.1187	5.1182		5.1187	5.1182		5.1189	5.1182
140	5.5118	5.5108	5.5121	5.5114		5.5123	5.5113		5.5124	5.5119		5.5124	5.5119		5.5126	5.5119
150	5.9055	5.9045	5.9058	5.9051		5.9060	5.9050		5.9061	5.9056		5.9061	5.9056		5.9063	5.9056
160	6.2992	6.2982	6.2995	6.2988		6.2997	6.2987		6.2998	6.2993		6.2998	6.2993		6.3000	6.2993
170	6.6929	6.6919	6.6932	6.6925		6.6934	6.6924		6.6935	6.6930		6.6935	6.6930		6.6937	6.6930
180	7.0866	7.0856	7.0869	7.0862		7.0871	7.0861		7.0872	7.0867		7.0872	7.0867		7.0874	7.0867
190	7.4803	7.4791	7.4807	7.4799		4 L 16 T	7.4809		7.4797	6 L 18 T		7.4810	7.4805		2 T 19 T	7.4812
200	7.8740	7.8728	7.8744	7.8736	7.8746		7.8734	7.8747	7.8742		7.8747	7.8742	7.8749	7.8742		
220	8.6614	8.6602	8.6618	8.6610	8.6620		8.6608	8.6621	8.6616		8.6621	8.6616	8.6623	8.6616		
240	9.4488	9.4476	9.4492	9.4484	9.4494		9.4482	9.4495	9.4490		9.4495	9.4490	9.4497	9.4490		
250	9.8425	9.8413	9.8429	9.8421	9.8431		9.8419	9.8432	9.8427		9.8432	9.8427	9.8434	9.8427		

Note: To convert inches to mm, multiply inches by 25.4

<sup>1)</sup> L indicates "LOOSE" fit, T indicates "TIGHT" fit



Table 8

Shaft bearing-seat diameters (values in inches)														
Bearing bore diameter			js5			js6			k4			k5		
mm	inches		Shaft dia.		Resultant fit <sup>1)</sup> in 0.0001"	Shaft dia.		Resultant fit <sup>1)</sup> in 0.0001"	Shaft dia.		Resultant fit <sup>1)</sup> in 0.0001"	Shaft dia.		Resultant fit <sup>1)</sup> in 0.0001"
	max.	min.	max.	min.		max.	min.		max.	min.		max.	min.	
260	10.2362	10.2348	10.2366	10.2357		10.2368	10.2356		10.2370	10.2364		10.2373	10.2364	
280	11.0236	11.0222	11.0240	11.0231	5 L	11.0242	11.0230	6 L	11.0244	11.0238	2 T	11.0247	11.0238	2 T
300	11.8110	11.8096	11.8114	11.8105	18 T	11.8116	11.8104	20 T	11.8118	11.8112	22 T	11.8121	11.8112	25 T
310	12.2047	12.2033	12.2051	12.2042		12.2053	12.2041		12.2055	12.2049		12.2058	12.2049	
320	12.5984	12.5968	12.5989	12.5979		12.5991	12.5977		12.5992	12.5986		12.5995	12.5986	
340	13.3858	13.3842	13.3863	13.3853		13.3865	13.3851		13.3866	13.3860		13.3869	13.3860	
350	13.7795	13.7779	13.7800	13.7790	5 L	13.7802	13.7788	7 L	13.7803	13.7797	2 T	13.7806	13.7797	2 T
360	14.1732	14.1716	14.1737	14.1727	21 T	14.1739	14.1725	23 T	14.1740	14.1734	24 T	14.1743	14.1734	27 T
380	14.9606	14.9590	14.9611	14.9601		14.9613	14.9599		14.9614	14.9608		14.9617	14.9608	
400	15.7480	15.7464	15.7485	15.7475		15.7487	15.7473		15.7488	15.7482		15.7491	15.7482	
420	16.5354	16.5336	16.5359	16.5349		16.5362	16.5346		16.5364	16.5356		16.5367	16.5356	
440	17.3228	17.3210	17.3233	17.3223	5 L	17.3236	17.3220	8 L	17.3238	17.3230	2 T	17.3241	17.3230	2 T
460	18.1102	18.1084	18.1107	18.1097	23 T	18.1110	18.1094	26 T	18.1112	18.1104	28 T	18.1115	18.1104	31 T
480	18.8976	18.8958	18.8981	18.8971		18.8984	18.8968		18.8986	18.8978		18.8989	18.8978	
500	19.6850	19.6832	19.6855	19.6845		19.6858	19.6842		19.6860	19.6852		19.6863	19.6852	
530	20.8661	20.8641	20.8666	20.8655		20.8669	20.8652		—	—		20.8673	20.8661	
560	22.0472	22.0452	22.0477	22.0466	6 L	22.0480	22.0463	9 L	—	—		22.0484	22.0472	0 T
600	23.6220	23.6200	23.6225	23.6214	25 T	23.6228	23.6211	28 T	—	—		23.6232	23.6220	32 T
630	24.8031	24.8011	24.8036	24.8025		24.8039	24.8022		—	—		24.8043	24.8031	
660	25.9843	25.9813	25.9849	25.9837		25.9852	25.9833		—	—		25.9857	25.9843	
670	26.3780	26.3750	26.3786	26.3774		26.3789	26.3770		—	—		26.3794	26.3780	
710	27.9528	27.9498	27.9534	27.9522	6 L	27.9537	27.9518	10 L	—	—		27.9542	27.9528	0 T
750	29.5276	29.5246	29.5282	29.5270	36 T	29.5285	29.5266	39 T	—	—		29.5290	29.5276	44 T
780	30.7087	30.7057	30.7093	30.7081		30.7096	30.7077		—	—		30.7101	30.7087	
800	31.4961	31.4931	31.4967	31.4955		31.4970	31.4951		—	—		31.4975	31.4961	
850	33.4646	33.4607	33.4653	33.4639		33.4657	33.4635		—	—		33.4662	33.4646	
900	35.4331	35.4292	35.4338	35.4324	7 L	35.4342	35.4320	11 L	—	—		35.4347	35.4331	0 T
950	37.4016	37.3977	37.4023	37.4009	46 T	37.4027	37.4005	50 T	—	—		37.4032	37.4016	55 T
1000	39.3701	39.3662	39.3708	39.3694		39.3712	39.3690		—	—		39.3717	39.3701	
1060	41.7323	41.7274	41.7331	41.7315		41.7336	41.7310		—	—		41.7341	41.7323	
1120	44.0945	44.0896	44.0953	44.0937	8 L	44.0958	44.0932	13 L	—	—		44.0963	44.0945	0 T
1180	46.4567	46.4518	46.4575	46.4559	57 T	46.4580	46.4554	62 T	—	—		46.4585	46.4567	67 T
1250	49.2126	49.2077	49.2134	49.2118		49.2139	49.2113		—	—		49.2144	49.2126	

Note: To convert inches to mm, multiply inches by 25.4

<sup>1)</sup> L indicates "LOOSE" fit, T indicates "TIGHT" fit

Table 8

Shaft bearing-seat diameters (values in inches)														
Bearing bore diameter			k6			m5			m6			n5		
			Shaft dia.		Resultant fit <sup>1)</sup> in 0.0001"	Shaft dia.		Resultant fit <sup>1)</sup> in 0.0001"	Shaft dia.		Resultant fit <sup>1)</sup> in 0.0001"	Shaft dia.		Resultant fit <sup>1)</sup> in 0.0001"
mm	inches		max.	min.		max.	min.		max.	min.		max.	min.	
4	0.1575	0.1572	0.1579	0.1575	0T	0.1579	0.1577		0.1580	0.1577		0.1580	0.1578	
5	0.1969	0.1966	0.1973	0.1969	7T	0.1973	0.1971	2T	0.1974	0.1971	2T	0.1974	0.1972	
6	0.2362	0.2359	0.2366	0.2362		0.2366	0.2364	7T	0.2367	0.2364	8T	0.2367	0.2365	
7	0.2756	0.2753	0.2760	0.2756		0.2761	0.2758		0.2762	0.2758		0.2762	0.2760	
8	0.3150	0.3147	0.3154	0.3150	0T	0.3155	0.3152	2T	0.3156	0.3152	2T	0.3156	0.3154	
9	0.3543	0.3540	0.3547	0.3543	7T	0.3548	0.3545	8T	0.3549	0.3545	9T	0.3549	0.3547	
10	0.3937	0.3934	0.3941	0.3937		0.3942	0.3939		0.3943	0.3939		0.3943	0.3941	
12	0.4724	0.4721	0.4729	0.4724	0T	0.4730	0.4727	3T	0.4731	0.4727	3T	0.4732	0.4729	
15	0.5906	0.5903	0.5911	0.5906	8T	0.5912	0.5909	9T	0.5913	0.5909	10T	0.5914	0.5911	
17	0.6693	0.6690	0.6698	0.6693		0.6699	0.6696		0.6700	0.6696		0.6701	0.6698	
20	0.7874	0.7870	0.7880	0.7875	1T	0.7881	0.7877	3T	0.7882	0.7877	3T	0.7883	0.7880	
25	0.9843	0.9839	0.9849	0.9844	10T	0.9850	0.9846	3T	0.9851	0.9846	3T	0.9852	0.9849	
30	1.1811	1.1807	1.1817	1.1812		1.1818	1.1814	11T	1.1819	1.1814	12T	1.1820	1.1817	
35	1.3780	1.3775	1.3787	1.3781	1T	1.3788	1.3784	4T	1.3790	1.3784	4T	1.3791	1.3787	
40	1.5748	1.5743	1.5755	1.5749	12T	1.5756	1.5752	4T	1.5758	1.5752	4T	1.5759	1.5755	
45	1.7717	1.7712	1.7724	1.7718		1.7725	1.7721	13T	1.7727	1.7721	15T	1.7728	1.7724	
50	1.9685	1.9680	1.9692	1.9686		1.9693	1.9689		1.9695	1.9689		1.9696	1.9692	
55	2.1654	2.1648	2.1662	2.1655		2.1663	2.1658		2.1666	2.1658		2.1667	2.1662	
60	2.3622	2.3616	2.3630	2.3623	1T	2.3631	2.3626	4T	2.3634	2.3626	4T	2.3635	2.3630	
65	2.5591	2.5585	2.5599	2.5592	14T	2.5600	2.5595	4T	2.5603	2.5595	4T	2.5604	2.5599	
70	2.7559	2.7553	2.7567	2.7560		2.7568	2.7563	15T	2.7571	2.7563	18T	2.7572	2.7567	
75	2.9528	2.9522	2.9536	2.9529		2.9537	2.9532		2.9540	2.9532		2.9541	2.9536	
80	3.1496	3.1490	3.1504	3.1497		3.1505	3.1500		3.1508	3.1500		3.1509	3.1504	
85	3.3465	3.3457	3.3475	3.3466		3.3476	3.3470		3.3479	3.3470		3.3480	3.3474	
90	3.5433	3.5425	3.5443	3.5434		3.5444	3.5438		3.5447	3.5438		3.5448	3.5442	
95	3.7402	3.7394	3.7412	3.7403	1T	3.7413	3.7407	5T	3.7416	3.7407	5T	3.7417	3.7411	
100	3.9370	3.9362	3.9380	3.9371	18T	3.9381	3.9375	5T	3.9384	3.9375	5T	3.9385	3.9379	
105	4.1339	4.1331	4.1349	4.1340		4.1350	4.1344	19T	4.1353	4.1344	22T	4.1354	4.1348	
110	4.3307	4.3299	4.3317	4.3308		4.3318	4.3312		4.3321	4.3312		4.3322	4.3316	
115	4.5276	4.5268	4.5286	4.5277		4.5287	4.5281		4.5290	4.5281		4.5291	4.5285	
120	4.7244	4.7236	4.7254	4.7245		4.7255	4.7249		4.7258	4.7249		4.7259	4.7253	
125	4.9213	4.9203	4.9224	4.9214		4.9226	4.9219		4.9229	4.9219		4.9231	4.9224	
130	5.1181	5.1171	5.1192	5.1182	1T	5.1194	5.1187	6T	5.1197	5.1187	6T	5.1199	5.1192	
140	5.5118	5.5108	5.5129	5.5119	21T	5.5131	5.5124	23T	5.5134	5.5124	26T	5.5136	5.5129	
150	5.9055	5.9045	5.9066	5.9056		5.9068	5.9061		5.9071	5.9061		5.9073	5.9066	
160	6.2992	6.2982	6.3003	6.2993		6.3005	6.2998		6.3008	6.2998		6.3010	6.3003	
170	6.6929	6.6919	6.6940	6.6930		6.6942	6.6935		6.6945	6.6935		6.6947	6.6940	
180	7.0866	7.0856	7.0877	7.0867		7.0879	7.0872		7.0882	7.0872		7.0884	7.0877	
190	7.4803	7.4791	7.4815	7.4805	2T	7.4818	7.4810	7T	7.4821	7.4810	7T	7.4823	7.4815	
200	7.8740	7.8728	7.8753	7.8742	25T	7.8755	7.8747	27T	7.8758	7.8747	30T	7.8760	7.8752	
220	8.6614	8.6602	8.6627	8.6616		8.6629	8.6621		8.6632	8.6621		8.6634	8.6626	
240	9.4488	9.4476	9.4501	9.4490		9.4503	9.4495		9.4506	9.4495		9.4508	9.4500	
250	9.8425	9.8413	9.8438	9.8427		9.8440	9.8432		9.8443	9.8432		9.8445	9.8437	

Note: To convert inches to mm, multiply inches by 25.4

<sup>1)</sup> L indicates "LOOSE" fit, T indicates "TIGHT" fit

Table 8

Shaft bearing-seat diameters (values in inches)														
Bearing bore diameter			k6			m5			m6			n5		
			Shaft dia.		Resultant fit <sup>1)</sup> in 0.0001"	Shaft dia.		Resultant fit <sup>1)</sup> in 0.0001"	Shaft dia.		Resultant fit <sup>1)</sup> in 0.0001"	Shaft dia.		Resultant fit <sup>1)</sup> in 0.0001"
mm	inches		max.	min.		max.	min.		max.	min.		max.	min.	
260	10.2362	10.2348	10.2376	10.2364		10.2379	10.2370		10.2382	10.2370		10.2384	10.2375	
280	11.0236	11.0222	11.0250	11.0238	2 T	11.0253	11.0244	8 T	11.0256	11.0244	8 T	11.0258	11.0249	
300	11.8110	11.8096	11.8124	11.8112	28 T	11.8127	11.8118	31 T	11.8130	11.8118	34 T	11.8132	11.8123	
310	12.2047	12.2033	12.2061	12.2049		12.2064	12.2055		12.2067	12.2055		12.2069	12.2060	
320	12.5984	12.5968	12.6000	12.5986		12.6002	12.5992		12.6006	12.5992		12.6008	12.5999	
340	13.3858	13.3842	13.3874	13.3860		13.3876	13.3866		13.3880	13.3866		13.3882	13.3873	
350	13.7795	13.7779	13.7811	13.7797	2 T	13.7813	13.7803	8 T	13.7817	13.7803	8 T	13.7819	13.7810	
360	14.1732	14.1716	14.1748	14.1734	32 T	14.1750	14.1740	34 T	14.1754	14.1740	38 T	14.1756	14.1747	
380	14.9606	14.9590	14.9622	14.9608		14.9624	14.9614		14.9628	14.9614		14.9630	14.9621	
400	15.7480	15.7464	15.7496	15.7482		15.7498	15.7488		15.7502	15.7488		15.7504	15.7495	
420	16.5354	16.5336	16.5372	16.5356		16.5374	16.5363		16.5379	16.5363		16.5380	16.5370	
440	17.3228	17.3210	17.3246	17.3230	2 T	17.3248	17.3237	9 T	17.3253	17.3237	9 T	17.3254	17.3244	
460	18.1102	18.1084	18.1120	18.1104	36 T	18.1122	18.1111	38 T	18.1127	18.1111	43 T	18.1128	18.1118	
480	18.8976	18.8958	18.8994	18.8978		18.8996	18.8985		18.9001	18.8985		18.9002	18.8992	
500	19.6850	19.6832	19.6868	19.6852		19.6870	19.6859		19.6875	19.6859		19.6876	19.6866	
530	20.8661	20.8641	20.8678	20.8661		20.8683	20.8671		—	—		20.8689	20.8678	
560	22.0472	22.0452	22.0489	22.0472	0 T	22.0494	22.0482	10 T	—	—		22.0500	22.0489	
600	23.6220	23.6200	23.6237	23.6220	37 T	23.6242	23.6230	42 T	—	—		23.6248	23.6237	
630	24.8031	24.8011	24.8048	24.8031		24.8053	24.8041		—	—		24.8059	24.8048	
660	25.9843	25.9813	25.9862	25.9843		25.9869	25.9855		—	—		25.9875	25.9863	
670	26.3780	26.3750	26.3799	26.3780		26.3806	26.3792		—	—		26.3812	26.3800	
710	27.9528	27.9498	27.9547	27.9528	0 T	27.9554	27.9540	12 T	—	—		27.9560	27.9548	
750	29.5276	29.5246	29.5295	29.5276	49 T	29.5302	29.5288	56 T	—	—		29.5308	29.5296	
780	30.7087	30.7057	30.7106	30.7087		30.7113	30.7099		—	—		30.7119	30.7107	
800	31.4961	31.4931	31.4980	31.4961		31.4987	31.4973		—	—		31.4993	31.4981	
850	33.4646	33.4607	33.4668	33.4646		33.4675	33.4659		—	—		33.4683	33.4668	
900	35.4331	35.4292	35.4353	35.4331	0 T	35.4360	35.4344	13 T	—	—		35.4368	35.4353	
950	37.4016	37.3977	37.4038	37.4016	61 T	37.4045	37.4029	68 T	—	—		37.4053	37.4038	
1000	39.3701	39.3662	39.3723	39.3701		39.3730	39.3714		—	—		39.3738	39.3723	
1060	41.7323	41.7274	41.7349	41.7323		41.7357	41.7339		—	—		41.7366	41.7349	
1120	44.0945	44.0896	44.0971	44.0945	0 T	44.0979	44.0961	16 T	—	—		44.0988	44.0971	
1180	46.4567	46.4518	46.4593	46.4567	75 T	46.4601	46.4583	83 T	—	—		46.4610	46.4593	
1250	49.2126	49.2077	49.2152	49.2126		49.2160	49.2142		—	—		49.2169	49.2152	

Note: To convert inches to mm, multiply inches by 25.4

<sup>1)</sup> L indicates "LOOSE" fit, T indicates "TIGHT" fit

Table 8

## Shaft bearing-seat diameters (values in inches)

Bearing bore diameter			n6			p6			r6			r7		
mm	inches		Shaft dia.		Resultant fit <sup>1)</sup> in 0.0001"	Shaft dia.		Resultant fit <sup>1)</sup> in 0.0001"	Shaft dia.		Resultant fit <sup>1)</sup> in 0.0001"	Shaft dia.		Resultant fit <sup>1)</sup> in 0.0001"
	max.	min.	max.	min.		max.	min.		max.	min.		max.	min.	
4	0.1575	0.1572	0.1581	0.1578		—	—		—	—		—	—	
5	0.1969	0.1966	0.1975	0.1972	3 T	—	—		—	—		—	—	
6	0.2362	0.2359	0.2368	0.2365	9 T	—	—		—	—		—	—	
7	0.2756	0.2753	0.2763	0.2760		—	—		—	—		—	—	
8	0.3150	0.3147	0.3157	0.3154	4 T	—	—		—	—		—	—	
9	0.3543	0.3540	0.3550	0.3547	10 T	—	—		—	—		—	—	
10	0.3937	0.3934	0.3944	0.3941		—	—		—	—		—	—	
12	0.4724	0.4721	0.4733	0.4729		—	—		—	—		—	—	
15	0.5906	0.5903	0.5915	0.5911	5 T	—	—		—	—		—	—	
17	0.6693	0.6690	0.6702	0.6698	12 T	—	—		—	—		—	—	
20	0.7874	0.7870	0.7885	0.7880		—	—		—	—		—	—	
25	0.9843	0.9839	0.9854	0.9849	6 T	—	—		—	—		—	—	
30	1.1811	1.1807	1.1822	1.1817	15 T	—	—		—	—		—	—	
35	1.3780	1.3775	1.3793	1.3787		—	—		—	—		—	—	
40	1.5748	1.5743	1.5761	1.5755	7 T	—	—		—	—		—	—	
45	1.7717	1.7712	1.7730	1.7724	18 T	—	—		—	—		—	—	
50	1.9685	1.9680	1.9698	1.9692		—	—		—	—		—	—	
55	2.1654	2.1648	2.1669	2.1662		—	—		—	—		—	—	
60	2.3622	2.3616	2.3637	2.3630		—	—		—	—		—	—	
65	2.5591	2.5585	2.5606	2.5599	8 T	—	—		—	—		—	—	
70	2.7559	2.7553	2.7574	2.7567	21 T	—	—		—	—		—	—	
75	2.9528	2.9522	2.9543	2.9536		—	—		—	—		—	—	
80	3.1496	3.1490	3.1511	3.1504		—	—		—	—		—	—	
85	3.3465	3.3457	3.3483	3.3474		3.3488	3.3480		—	—		—	—	
90	3.5433	3.5425	3.5451	3.5442		3.5456	3.5448		—	—		—	—	
95	3.7402	3.7394	3.7420	3.7411		3.7425	3.7417		—	—		—	—	
100	3.9370	3.9362	3.9388	3.9379	9 T	3.9393	3.9385	15 T	—	—		—	—	
105	4.1339	4.1331	4.1357	4.1348	26 T	4.1362	4.1354	31 T	—	—		—	—	
110	4.3307	4.3299	4.3325	4.3316		4.3330	4.3322		—	—		—	—	
115	4.5276	4.5268	4.5294	4.5285		4.5299	4.5291		—	—		—	—	
120	4.7244	4.7236	4.7262	4.7253		4.7267	4.7259		—	—		—	—	
125	4.9213	4.9203	4.9233	4.9224		4.9240	4.9230		4.9248	4.9239		—	—	
130	5.1181	5.1171	5.1201	5.1192		5.1208	5.1198		5.1216	5.1207		—	—	
140	5.5118	5.5108	5.5138	5.5129		5.5145	5.5135		5.5153	5.5144		—	—	
150	5.9055	5.9045	5.9075	5.9066	11 T	5.9082	5.9072	17 T	5.9090	5.9081	26 T	—	—	
160	6.2992	6.2982	6.3012	6.3003	30 T	6.3019	6.3009	37 T	6.3027	6.3018	45 T	—	—	
170	6.6929	6.6919	6.6949	6.6940		6.6956	6.6946		6.6964	6.6955		—	—	
180	7.0866	7.0856	7.0886	7.0877		7.0893	7.0883		7.0901	7.0892		—	—	
190	7.4803	7.4791	7.4827	7.4815		7.4834	7.4823		7.4845	7.4833	30 T	—	—	
200	7.8740	7.8728	7.8764	7.8752	12 T	7.8771	7.8760	20 T	7.8782	7.8770	54 T	—	—	
220	8.6614	8.6602	8.6638	8.6626	36 T	8.6645	8.6634	43 T	8.6657	8.6645	31/55 T/T	8.6664	8.6645	31/62 T/T
240	9.4488	9.4476	9.4512	9.4500		9.4519	9.4508		9.4532	9.4521	33 T	9.4539	9.4521	33 T
250	9.8425	9.8413	9.8449	9.8437		9.8456	9.8445		9.8469	9.8458	56 T	9.8476	9.8458	63 T

Note: To convert inches to mm, multiply inches by 25.4

<sup>1)</sup> L indicates "LOOSE" fit, T indicates "TIGHT" fit

Table 8

Shaft bearing-seat diameters (values in inches)														
Bearing bore diameter			n6			p6			r6			r7		
			Shaft dia.		Resultant fit <sup>1)</sup> in 0.0001"	Shaft dia.		Resultant fit <sup>1)</sup> in 0.0001"	Shaft dia.		Resultant fit <sup>1)</sup> in 0.0001"	Shaft dia.		Resultant fit <sup>1)</sup> in 0.0001"
mm	inches		max.	min.		max.	min.		max.	min.		max.	min.	
260	10.2362	10.2348	10.2388	10.2375		10.2397	10.2384		10.2412	10.2399	37 T	10.2419	10.2399	37 T
280	11.0236	11.0222	11.0262	11.0249	13 T	11.0271	11.0258	22 T	11.0286	11.0273	64 T	11.0293	11.0273	71 T
300	11.8110	11.8096	11.8136	11.8123	40 T	11.8145	11.8132	49 T	11.8161	11.8149	39 T	11.8169	11.8149	39 T
310	12.2047	12.2033	12.2073	12.2060		12.2082	12.2069		12.2098	12.2086	65 T	12.2106	12.2086	73 T
320	12.5984	12.5968	12.6013	12.5999		12.6023	12.6008		12.6041	12.6027	43 T	12.6049	12.6027	43 T
340	13.3858	13.3842	13.3887	13.3873		13.3897	13.3882		13.3915	13.3901	73 T	13.3923	13.3901	81 T
350	13.7795	13.7779	13.7824	13.7810	15 T	13.7834	13.7819	24 T	13.7852	13.7838		13.7860	13.7838	
360	14.1732	14.1716	14.1761	14.1747	45 T	14.1771	14.1756	55 T	14.1791	14.1777	45 T	14.1799	14.1777	45 T
380	14.9606	14.9590	14.9635	14.9621		14.9645	14.9630		14.9665	14.9651	75 T	14.9673	14.9651	83 T
400	15.7480	15.7464	15.7509	15.7495		15.7519	15.7504		15.7539	15.7525		15.7547	15.7525	
420	16.5354	16.5336	16.5385	16.5370		16.5397	16.5381		16.5419	16.5404	50 T	16.5428	16.5404	50 T
440	17.3228	17.3210	17.3259	17.3244	16 T	17.3271	17.3255	27 T	17.3293	17.3278	83 T	17.3302	17.3278	92 T
460	18.1102	18.1084	18.1133	18.1118	49 T	18.1145	18.1129	61 T	18.1170	18.1154	52 T	18.1179	18.1154	52 T
480	18.8976	18.8958	18.9007	18.8992		18.9019	18.9003		18.9044	18.9028	86 T	18.9053	18.9028	95 T
500	19.6850	19.6832	19.6881	19.6866		19.6893	19.6877		19.6918	19.6902		19.6927	19.6902	
530	20.8661	20.8641	20.8696	20.8678		20.8709	20.8692		20.8737	20.8720	59 T	20.8748	20.8720	59 T
560	22.0472	22.0452	22.0507	22.0489	17 T	22.0520	22.0503	31 T	22.0548	22.0531	96 T	22.0559	22.0531	107 T
600	23.6220	23.6200	23.6255	23.6237	55 T	23.6268	23.6251	68 T	23.6298	23.6281	61 T	23.6309	23.6281	61 T
630	24.8031	24.8011	24.8066	24.8048		24.8079	24.8062		24.8109	24.8092	98 T	24.8120	24.8092	109 T
660	25.9843	25.9813	25.9882	25.9863		25.9897	25.9878		25.9932	25.9912	69 T	25.9943	25.9911	68 T
670	26.3780	26.3750	26.3819	26.3800		26.3834	26.3815		26.3869	26.3849	119 T	26.3880	26.3848	130 T
710	27.9528	27.9498	27.9567	27.9548	20 T	27.9582	27.9563	35 T	27.9617	27.9597		27.9628	27.9596	
750	29.5276	29.5246	29.5315	29.5296	69 T	29.5330	29.5311	84 T	29.5369	29.5349	73 T	29.5380	29.5349	73 T
780	30.7087	30.7057	30.7126	30.7107		30.7141	30.7122		30.7180	30.7160	123 T	30.7191	30.7160	134 T
800	31.4961	31.4931	31.5000	31.4981		31.5015	31.4996		31.5054	31.5034		31.5065	31.5034	
850	33.4646	33.4607	33.4690	33.4668		33.4707	33.4685		33.4751	33.4729	83 T	33.4764	33.4729	83 T
900	35.4331	35.4292	35.4375	35.4353	22 T	35.4392	35.4370	39 T	35.4436	35.4414	144 T	35.4449	35.4414	157 T
950	37.4016	37.3977	37.4060	37.4038	83 T	37.4077	37.4055	100 T	37.4125	37.4103	87 T	37.4138	37.4103	87 T
1000	39.3701	39.3662	39.3745	39.3723		39.3762	39.3740		39.3810	39.3788	148 T	39.3823	39.3788	161 T
1060	41.7323	41.7274	41.7375	41.7349		41.7396	41.7370		41.7447	41.7421	98 T	41.7463	41.7421	98 T
1120	44.0945	44.0896	44.0997	44.0971	26 T	44.1018	44.0992	47 T	44.1069	44.1043	173 T	44.1085	44.1043	189 T
1180	46.4567	46.4518	46.4619	46.4593	101 T	46.4640	46.4614	122 T	46.4695	46.4669	102 T	46.4711	46.4669	102 T
1250	49.2126	49.2077	49.2178	49.2152		49.2199	49.2173		49.2254	49.2226	177 T	49.2270	49.2228	193 T

Note: To convert inches to mm, multiply inches by 25.4

<sup>1)</sup> L indicates "LOOSE" fit, T indicates "TIGHT" fit

Table 8

## Shaft bearing-seat diameters (values in inches)

Bearing bore diameter		s6		Resultant fit <sup>1)</sup> in 0.0001"	s7		Resultant fit <sup>1)</sup> in 0.0001"
		Shaft dia.			Shaft dia.		
mm	inches max. min.	max.	min.		max.	min.	
4	0.1575 0.1572	—	—		—	—	
5	0.1969 0.1966	—	—		—	—	
6	0.2362 0.2359	—	—		—	—	
7	0.2756 0.2753	—	—		—	—	
8	0.3150 0.3147	—	—		—	—	
9	0.3543 0.3540	—	—		—	—	
10	0.3937 0.3934	—	—		—	—	
12	0.4724 0.4721	—	—		—	—	
15	0.5906 0.5903	—	—		—	—	
17	0.6693 0.6690	—	—		—	—	
20	0.7874 0.7870	—	—		—	—	
25	0.9843 0.9839	—	—		—	—	
30	1.1811 1.1807	—	—		—	—	
35	1.3780 1.3775	—	—		—	—	
40	1.5748 1.5743	—	—		—	—	
45	1.7717 1.7712	—	—		—	—	
50	1.9685 1.9680	—	—		—	—	
55	2.1654 2.1648	—	—		—	—	
60	2.3622 2.3616	—	—		—	—	
65	2.5591 2.5585	—	—		—	—	
70	2.7559 2.7553	—	—		—	—	
75	2.9528 2.9522	—	—		—	—	
80	3.1496 3.1490	—	—		—	—	
85	3.3465 3.3457	—	—		—	—	
90	3.5433 3.5425	—	—		—	—	
95	3.7402 3.7394	—	—		—	—	
100	3.9370 3.9362	—	—		—	—	
105	4.1339 4.1331	—	—		—	—	
110	4.3307 4.3299	—	—		—	—	
115	4.5276 4.5268	—	—		—	—	
120	4.7244 4.7236	—	—		—	—	
125	4.9213 4.9203	—	—		—	—	
130	5.1181 5.1171	—	—		—	—	
140	5.5118 5.5108	—	—		—	—	
150	5.9055 5.9045	—	—		—	—	
160	6.2992 6.2982	—	—		—	—	
170	6.6929 6.6919	—	—		—	—	
180	7.0866 7.0856	—	—		—	—	
190	7.4803 7.4791	—	—		—	—	
200	7.8740 7.8728	—	—		—	—	
220	8.6614 8.6602	—	—		—	—	
240	9.4488 9.4476	—	—		—	—	
250	9.8425 9.8413	—	—		—	—	

Note: To convert inches to mm, multiply inches by 25.4

<sup>1)</sup> L indicates "LOOSE" fit, T indicates "TIGHT" fit

Table 8

Shaft bearing-seat diameters (values in inches)								
Bearing bore diameter			s6			s7		
mm	inches		Shaft dia.		Resultant fit <sup>1)</sup> in 0.0001"	Shaft dia.		Resultant fit <sup>1)</sup> in 0.0001"
	max.	min.	max.	min.		max.	min.	
260	10.2362	10.2348	—	—	62 T	—	—	62 T
280	11.0236	11.0222	11.0311	11.0298	89 T	11.0319	11.0298	97 T
300	11.8110	11.8096	11.8190	11.8177	67 T	11.8198	11.8177	67 T
310	12.2047	12.2033	12.2127	12.2114	94 T	12.2135	12.2114	102 T
320	12.5984	12.5968	12.6073	12.6059	75 T	12.6081	12.6059	75 T
340	13.3858	13.3842	13.3947	13.3933	105 T	13.3956	13.3933	114 T
350	13.7795	13.7779	13.7884	13.7870		13.7893	13.7870	
360	14.1732	14.1716	14.1828	14.1814		14.1837	14.1814	
380	14.9606	14.9590	14.9702	14.9688	82 T	14.9711	14.9688	82 T
400	15.7480	15.7464	15.7576	15.7562	112 T	15.7585	15.7562	121 T
420	16.5354	16.5336	16.5461	16.5446	92 T	16.5470	16.5446	92 T
440	17.3228	17.3210	17.3335	17.3320	125 T	17.3344	17.3320	134 T
460	18.1102	18.1084	18.1217	18.1202		18.1226	18.1202	
480	18.8976	18.8958	18.9091	18.9076	100 T	18.9100	18.9076	100 T
500	19.6850	19.6832	19.6965	19.6950	133 T	19.6974	19.6950	142 T
530	20.8661	20.8641	20.8789	20.8772	111 T	20.8799	20.8772	111 T
560	22.0472	22.0452	22.0600	22.0583	148 T	22.0610	22.0583	158 T
600	23.6220	23.6200	23.6360	23.6343	123 T	23.6370	23.6343	123 T
630	24.8031	24.8011	24.8171	24.8154	160 T	24.8181	24.8154	170 T
660	25.9843	25.9813	25.9996	25.9976		26.0008	25.9976	
670	26.3780	26.3750	26.3933	26.3913	133 T	26.3945	26.3913	133 T
710	27.9528	27.9498	27.9681	27.9661	183 T	27.9693	27.9661	195 T
750	29.5276	29.5246	29.5445	29.5425		29.5457	29.5425	
780	30.7087	30.7057	30.7256	30.7236	149 T	30.7268	30.7236	149 T
800	31.4961	31.4931	31.5130	31.5110	199 T	31.5142	31.5110	211 T
850	33.4646	33.4607	33.4837	33.4815	169 T	33.4850	33.4815	169 T
900	35.4331	35.4292	35.4522	35.4500	230 T	35.4535	35.4500	243 T
950	37.4016	37.3977	37.4223	37.4201	185 T	37.4236	37.4201	185 T
1000	39.3701	39.3662	39.3908	39.3886	246 T	39.3921	39.3886	259 T
1060	41.7323	41.7274	41.7554	41.7528	205 T	41.7569	41.7528	205 T
1120	44.0945	44.0896	44.1176	44.1150	280 T	44.1191	44.1150	295 T
1180	46.4567	46.4518	46.4821	46.4795	228 T	46.4837	46.4795	228 T
1250	49.2126	49.2077	49.2380	49.2354	303 T	49.2396	49.2354	319 T

Note: To convert inches to mm, multiply inches by 25.4

<sup>1)</sup> L indicates "LOOSE" fit, T indicates "TIGHT" fit

Table 9

Housing bearing-seat diameters (values in inches)														
Bearing outside diameter			F7			G7			H6			H7		
			Housing bore		Resultant fit <sup>1)</sup> in 0.0001"	Housing bore		Resultant fit <sup>1)</sup> in 0.0001"	Housing bore		Resultant fit <sup>1)</sup> in 0.0001"	Housing bore		Resultant fit <sup>1)</sup> in 0.0001"
mm	inches		min.	max.		min.	max.		min.	max.		min.	max.	
16	0.6299	0.6296	0.6305	0.6312	16 L 6 L	0.6301	0.6308	12 L 2 L	0.6299	0.6303	7 L 0 L	0.6299	0.6306	10 L 0 L
19	0.7480	0.7476	0.7488	0.7496		0.7483	0.7491		0.7480	0.7485		0.7480	0.7488	
22	0.8661	0.8657	0.8669	0.8677		0.8664	0.8672		0.8661	0.8666		0.8661	0.8669	
24	0.9449	0.9445	0.9457	0.9465	20 L	0.9452	0.9460	15 L	0.9449	0.9454	9 L	0.9449	0.9457	12 L
26	1.0236	1.0232	1.0244	1.0252	8 L	1.0239	1.0247	3 L	1.0236	1.0241	0 L	1.0236	1.0244	0 L
28	1.1024	1.1020	1.1032	1.1040		1.1027	1.1035		1.1024	1.1029		1.1024	1.1032	
30	1.1811	1.1807	1.1819	1.1827		1.1814	1.1822		1.1811	1.1816		1.1811	1.1819	
32	1.2598	1.2594	1.2608	1.2618		1.2602	1.2611		1.2598	1.2604		1.2598	1.2608	
35	1.3780	1.3776	1.3790	1.4000		1.3784	1.3793		1.3780	1.3786		1.3780	1.3790	
37	1.4567	1.4563	1.4577	1.4587	24 L	1.4571	1.4580	17 L	1.4567	1.4573	10 L	1.4567	1.4577	14 L
40	1.5748	1.5744	1.5758	1.5768	10 L	1.5752	1.5761	4 L	1.5748	1.5754	0 L	1.5748	1.5758	0 L
42	1.6535	1.6531	1.6545	1.6555		1.6539	1.6548		1.6535	1.6541		1.6535	1.6545	
47	1.8504	1.8500	1.8514	1.8524		1.8508	1.8517		1.8504	1.8510		1.8504	1.8514	
52	2.0472	2.0467	2.0484	2.0496		2.0476	2.0488		2.0472	2.0479		2.0472	2.0484	
55	2.1654	2.1649	2.1666	2.1678		2.1658	2.1670		2.1654	2.1661		2.1654	2.1666	
62	2.4409	2.4404	2.4421	2.4433	29 L	2.4413	2.4425	21 L	2.4409	2.4416	12 L	2.4409	2.4421	17 L
68	2.6772	2.6767	2.6784	2.6796	12 L	2.6776	2.6788	4 L	2.6772	2.6779	0 L	2.6772	2.6784	0 L
72	2.8346	2.8341	2.8358	2.8370		2.8350	2.8362		2.8346	2.8353		2.8346	2.8358	
75	2.9527	2.9522	2.9539	2.9551		2.9532	2.9543		2.9527	2.9534		2.9527	2.9539	
80	3.1496	3.1491	3.1508	3.1520		3.1500	3.1512		3.1496	3.1503		3.1496	3.1508	
85	3.3465	3.3459	3.3479	3.3493		3.3470	3.3484		3.3465	3.3474		3.3465	3.3479	
90	3.5433	3.5427	3.5447	3.5461		3.5438	3.5452		3.5433	3.5442		3.5433	3.5447	
95	3.7402	3.7396	3.7416	3.7430		3.7407	3.7421		3.7402	3.7411		3.7402	3.7416	
100	3.9370	3.9364	3.9384	3.9398	34 L	3.9375	3.9389	25 L	3.9370	3.9379	15 L	3.9370	3.9384	20 L
110	4.3307	4.3301	4.3321	4.3335	14 L	4.3312	4.3326	5 L	4.3307	4.3316	0 L	4.3307	4.3321	0 L
115	4.5276	4.5270	4.5290	4.5304		4.5281	4.5295		4.5276	4.5285		4.5276	4.5290	
120	4.7244	4.7238	4.7258	4.7272		4.7249	4.7263		4.7244	4.7253		4.7244	4.7258	
125	4.9213	4.9206	4.9230	4.9246		4.9219	4.9234		4.9213	4.9223		4.9213	4.9229	
130	5.1181	5.1174	5.1198	5.1214		5.1187	5.1202		5.1181	5.1191		5.1181	5.1197	
140	5.5118	5.5111	5.5135	5.5151	40 L	5.5124	5.5139	28 L	5.5118	5.5128	17 L	5.5118	5.5134	23 L
145	5.7087	5.7080	5.7104	5.7120	17 L	5.7093	5.7108	6 L	5.7087	5.7097	0 L	5.7087	5.7103	0 L
150	5.9055	5.9048	5.9072	5.9088		5.9061	5.9076		5.9055	5.9065		5.9055	5.9071	
160	6.2992	6.2982	6.3009	6.3025		6.2998	6.3013		6.2992	6.3002		6.2992	6.3008	
165	6.4961	6.4951	6.4978	6.4994	43 L	6.4967	6.4982	31 L	6.4961	6.4971	20 L	6.4961	6.4977	26 L
170	6.6929	6.6919	6.6946	6.6962	17 L	6.6935	6.6950	6 L	6.6929	6.6939	0 L	6.6929	6.6945	0 L
180	7.0866	7.0856	7.0883	7.0899		7.0872	7.0887		7.0866	7.0876		7.0866	7.0882	
190	7.4803	7.4791	7.4823	7.4841		7.4809	7.4827		7.4803	7.4814		7.4803	7.4821	
200	7.8740	7.8728	7.8760	7.8778		7.8746	7.8764		7.8740	7.8751		7.8740	7.8758	
210	8.2677	8.2665	8.2697	8.2715		8.2683	8.2701		8.2677	8.2688		8.2677	8.2695	
215	8.4646	8.4634	8.4666	8.4684	50 L	8.4652	8.4670	36 L	8.4646	8.4657	23 L	8.4646	8.4664	30 L
220	8.6614	8.6602	8.6634	8.6652	20 L	8.6620	8.6638	6 L	8.6614	8.6625	0 L	8.6614	8.6632	0 L
225	8.8583	8.8571	8.8603	8.8621		8.8589	8.8607		8.8583	8.8594		8.8583	8.8601	
230	9.0551	9.0539	9.0571	9.0589		9.0557	9.0575		9.0551	9.0562		9.0551	9.0569	
240	9.4488	9.4476	9.4508	9.4526		9.4494	9.4512		9.4488	9.4499		9.4488	9.4506	
250	9.8425	9.8413	9.8445	9.8463		9.8431	9.8449		9.8425	9.8436		9.8425	9.8443	

Note: To convert inches to mm, multiply inches by 25.4

<sup>1)</sup> L indicates "LOOSE" fit, T indicates "TIGHT" fit



Table 9

Housing bearing-seat diameters (values in inches)														
Bearing outside diameter			F7		Resultant fit <sup>1)</sup> in 0.0001"	G7		Resultant fit <sup>1)</sup> in 0.0001"	H6		Resultant fit <sup>1)</sup> in 0.0001"	H7		Resultant fit <sup>1)</sup> in 0.0001"
			Housing bore min.	Housing bore max.		Housing bore min.	Housing bore max.		Housing bore min.	Housing bore max.		Housing bore min.	Housing bore max.	
mm	inches max. min.		min.	max.		min.	max.		min.	max.		min.	max.	
260	10.2362	10.2348	10.2384	10.2405		10.2369	10.2389		10.2362	10.2375		10.2362	10.2382	
270	10.6299	10.6285	10.6321	10.6342		10.6306	10.6326		10.6299	10.6312		10.6299	10.6319	
280	11.0236	11.0222	11.0258	11.0279	57 L	11.0243	11.0263	41 L	11.0236	11.0249	27 L	11.0236	11.0256	34 L
290	11.4173	11.4159	11.4195	11.4216	22 L	11.4180	11.4200	7 L	11.4173	11.4186	0 L	11.4173	11.4193	0 L
300	11.8110	11.8096	11.8132	11.8153		11.8117	11.8137		11.8110	11.8123		11.8110	11.8130	
310	12.2047	12.2033	12.2069	12.2090		12.2054	12.2074		12.2047	12.2060		12.2047	12.2067	
320	12.5984	12.5968	12.6008	12.6031		12.5991	12.6014		12.5984	12.5998		12.5984	12.6006	
340	13.3858	13.3842	13.3882	13.3905		13.3865	13.3888		13.3858	13.3872		13.3858	13.3880	
360	14.1732	14.1716	14.1756	14.1779	63 L	14.1739	14.1762	46 L	14.1732	14.1746	30 L	14.1732	14.1754	38 L
370	14.5669	14.5654	14.5694	14.5717	24 L	14.5677	14.5700	7 L	14.5669	14.5684	0 L	14.5670	14.5692	0 L
380	14.9606	14.9590	14.9630	14.9653		14.9613	14.9636		14.9606	14.9620		14.9606	14.9628	
400	15.7480	15.7464	15.7504	15.7527		15.7487	15.7510		15.7480	15.7494		15.7480	15.7502	
420	16.5354	16.5336	16.5381	16.5406		16.5362	16.5387		16.5354	16.5370		16.5354	16.5379	
440	17.3228	17.3210	17.3255	17.3280	70 L	17.3236	17.3261	51 L	17.3228	17.3244	34 L	17.3228	17.3253	43 L
460	18.1102	18.1084	18.1129	18.1154	27 L	18.1110	18.1135	8 L	18.1102	18.1118	0 L	18.1102	18.1127	0 L
480	18.8976	18.8958	18.9003	18.9028		18.8984	18.9009		18.8976	18.8992		18.8976	18.9001	
500	19.6850	19.6832	19.6877	19.6902		19.6858	19.6883		19.6850	19.6866		19.6850	19.6875	
520	20.4724	20.4704	20.4754	20.4781		20.4733	20.4760		20.4724	20.4741		20.4724	20.4752	
540	21.2598	21.2578	21.2628	21.2655		21.2607	21.2634		21.2598	21.2615		21.2598	21.2626	
560	22.0472	22.0452	22.0502	22.0529	77 L	22.0481	22.0508	56 L	22.0472	22.0489	37 L	22.0472	22.0500	48 L
580	22.8346	22.8326	22.8376	22.8403	30 L	22.8355	22.8382	9 L	22.8346	22.8363	0 L	22.8346	22.8374	0 L
600	23.6220	23.6200	23.6250	23.6277		23.6229	23.6256		23.6220	23.6237		23.6220	23.6248	
620	24.4094	24.4074	24.4124	24.4151		24.4103	24.4130		24.4094	24.4111		24.4094	24.4122	
650	25.5906	25.5876	25.5937	25.5969		25.5915	25.5947		25.5906	25.5926		25.5906	25.5937	
670	26.3780	26.3750	26.3811	26.3843		26.3789	26.3821		26.3780	26.3800		26.3780	26.3811	
680	26.7717	26.7687	26.7748	26.7780		26.7726	26.7758		26.7717	26.7737		26.7717	26.7748	
700	27.5591	27.5561	27.5622	27.5654		27.5600	27.5632		27.5591	27.5611		27.5591	27.5622	
720	28.3465	28.3435	28.3496	28.3528	93 L	28.3474	28.3506	71 L	28.3465	28.3485	50 L	28.3465	28.3496	61 L
750	29.5276	29.5246	29.5307	29.5339	31 L	29.5285	29.5317	9 L	29.5276	29.5296	0 L	29.5276	29.5307	0 L
760	29.9213	29.9183	29.9244	29.9276		29.9222	29.9254		29.9213	29.9233		29.9213	29.9244	
780	30.7087	30.7057	30.7118	30.7150		30.7096	30.7128		30.7087	30.7107		30.7087	30.7118	
790	31.1024	31.0994	31.1055	31.1087		31.1033	31.1065		31.1024	31.1044		31.1024	31.1055	
800	31.4961	31.4931	31.4992	31.5024		31.4970	31.5002		31.4961	31.4981		31.4961	31.4992	
820	32.2835	32.2796	32.2869	32.2904		32.2845	32.2881		32.2835	32.2857		32.2835	32.2870	
830	32.6772	32.6733	32.6806	32.6841		32.6782	32.6818		32.6772	32.6794		32.6772	32.6807	
850	33.4646	33.4607	33.4680	33.4715		33.4656	33.4692		33.4646	33.4668		33.4646	33.4681	
870	34.2520	34.2481	34.2554	34.2589	108 L	34.2530	34.2566	85 L	34.2520	34.2542	61 L	34.2520	34.2555	74 L
920	36.2205	36.2166	36.2239	36.2274	34 L	36.2215	36.2251	10 L	36.2205	36.2227	0 L	36.2205	36.2240	0 L
950	37.4016	37.3977	37.4050	37.4085		37.4026	37.4062		37.4016	37.4038		37.4016	37.4051	
980	38.5827	38.5788	38.5861	38.5896		38.5837	38.5873		38.5827	38.5849		38.5827	38.5862	
1000	39.3701	39.3662	39.3735	39.3770		39.3711	39.3747		39.3701	39.3723		39.3701	39.3736	
1150	45.2756	45.2707	45.2795	45.2836	129 L	45.2767	45.2808	101 L	45.2756	45.2782	75 L	45.2756	45.2797	90 L
1250	49.2126	49.2077	49.2165	49.2206	39 L	49.2137	49.2178	11 L	49.2126	49.2152	0 L	49.2126	49.2167	0 L
1400	55.1181	55.1118	55.1224	55.1274	156 L	55.1193	55.1242	124 L	55.1181	55.1212	94 L	55.1181	55.1230	112 L
1600	62.9921	62.9858	62.9964	63.0014	43 L	62.9933	62.9982	12 L	62.9921	62.9952	0 L	62.9921	62.9970	0 L
1800	70.8661	70.8582	70.8708	70.8767	185 L	70.8674	70.8733	151 L	70.8661	70.8697	115 L	70.8661	70.8720	138 L
2000	78.7402	78.7323	78.7449	78.7508	47 L	78.7415	78.7474	13 L	78.7402	78.7438	0 L	78.7402	78.7461	0 L
2300	90.5512	90.5414	90.5563	90.5632	218 L	90.5525	90.5594	180 L	90.5512	90.5555	141 L	90.5512	90.5581	167 L
2500	98.4252	98.4154	98.4303	98.4372	51 L	98.4265	98.4334	13 L	98.4252	98.4295	0 L	98.4252	98.4321	0 L

Note: To convert inches to mm, multiply inches by 25.4

<sup>1)</sup> L indicates "LOOSE" fit, T indicates "TIGHT" fit

**Table 9**

Housing bearing-seat diameters (values in inches)														
Bearing outside diameter			H8			H9			H10			J6		
			Housing bore		Resultant fit <sup>1)</sup> in 0.0001"	Housing bore		Resultant fit <sup>1)</sup> in 0.0001"	Housing bore		Resultant fit <sup>1)</sup> in 0.0001"	Housing bore		Resultant fit <sup>1)</sup> in 0.0001"
mm	inches		min.	max.		min.	max.		min.	max.		min.	max.	
	max.	min.	min.	max.		min.	max.		min.	max.		min.	max.	
16	0.6299	0.6296	0.6299	0.6310	14L 0 L	0.6299	0.6316	20L 0 L	0.6299	0.6327	31L 0 L	0.6297	0.6301	5L 2 T
19	0.7480	0.7476	0.7480	0.7493		0.7480	0.7500		0.7480	0.7513		0.7478	0.7483	
22	0.8661	0.8657	0.8661	0.8674		0.8661	0.8681		0.8661	0.8694		0.8659	0.8664	
24	0.9449	0.9445	0.9449	0.9462	17 L	0.9449	0.9469	24 L	0.9449	0.9482	37 L	0.9447	0.9452	7 L
26	1.0236	1.0232	1.0236	1.0249	0 L	1.0236	1.0256	0 L	1.0236	1.0269	0 L	1.0234	1.0239	2 T
28	1.1024	1.1020	1.1024	1.1037		1.1024	1.1044		1.1024	1.1057		1.1022	1.1027	
30	1.1811	1.1807	1.1811	1.1824		1.1811	1.1831		1.1811	1.1844		1.1809	1.1814	
32	1.2598	1.2594	1.2598	1.2613		1.2598	1.2622		1.2598	1.2637		1.2596	1.2602	
35	1.3780	1.3776	1.3780	1.3795		1.3780	1.3804		1.3780	1.3819		1.3778	1.3784	
37	1.4567	1.4563	1.4567	1.4582	19 L	1.4567	1.4591	28 L	1.4567	1.4606	43 L	1.4565	1.4571	8 L
40	1.5748	1.5744	1.5748	1.5763	0 L	1.5748	1.5772	0 L	1.5748	1.5787	0 L	1.5746	1.5752	2 T
42	1.6535	1.6531	1.6535	1.6550		1.6535	1.6559		1.6535	1.6574		1.6533	1.6539	
47	1.8504	1.8500	1.8504	1.8519		1.8504	1.8528		1.8504	1.8543		1.8502	1.8508	
52	2.0472	2.0467	2.0472	2.0490		2.0472	2.0501		2.0472	2.0519		2.0470	2.0477	
55	2.1654	2.1649	2.1654	2.1672		2.1654	2.1683		2.1654	2.1701		2.1652	2.1659	
62	2.4409	2.4404	2.4409	2.4427	23 L	2.4409	2.4438	34 L	2.4409	2.4456	52 L	2.4407	2.4414	10 L
68	2.6772	2.6767	2.6772	2.6790	0 L	2.6772	2.6801	0 L	2.6772	2.6819	0 L	2.6770	2.6777	2 T
72	2.8346	2.8341	2.8346	2.8364		2.8346	2.8375		2.8346	2.8393		2.8344	2.8351	
75	2.9527	2.9522	2.9527	2.9545		2.9527	2.9556		2.9527	2.9574		2.9525	2.9532	
80	3.1496	3.1491	3.1496	3.1514		3.1496	3.1525		3.1496	3.1543		3.1494	3.1501	
85	3.3465	3.3459	3.3465	3.3486		3.3465	3.3499		3.3465	3.3520		3.3463	3.3471	
90	3.5433	3.5427	3.5433	3.5454		3.5433	3.5467		3.5433	3.5488		3.5431	3.5439	
95	3.7402	3.7396	3.7402	3.7423		3.7402	3.7436		3.7402	3.7457		3.7400	3.7408	
100	3.9370	3.9364	3.9370	3.9391	27 L	3.9370	3.9404	40 L	3.9370	3.9425	61 L	3.9368	3.9376	12 L
110	4.3307	4.3301	4.3307	4.3328	0 L	4.3307	4.3341	0 L	4.3307	4.3362	0 L	4.3305	4.3313	2 T
115	4.5276	4.5270	4.5276	4.5297		4.5276	4.5310		4.5276	4.5331		4.5274	4.5282	
120	4.7244	4.7238	4.7244	4.7265		4.7244	4.7278		4.7244	4.7299		4.7242	4.7250	
125	4.9213	4.9206	4.9213	4.9238		4.9213	4.9252		4.9213	4.9276		4.9210	4.9220	
130	5.1181	5.1174	5.1181	5.1206		5.1181	5.1220		5.1181	5.1244		5.1178	5.1188	
140	5.5118	5.5111	5.5118	5.5143	32 L	5.5118	5.5157	46 L	5.5118	5.5181	70 L	5.5115	5.5125	14 L
145	5.7087	5.7080	5.7087	5.7112	0 L	5.7087	5.7126	0 L	5.7087	5.7150	0 L	5.7084	5.7094	3 T
150	5.9055	5.9048	5.9055	5.9080		5.9055	5.9094		5.9055	5.9118		5.9052	5.9062	
160	6.2992	6.2982	6.2992	6.3017		6.2992	6.3031		6.2992	6.3055		6.2989	6.2999	
165	6.4961	6.4951	6.4961	6.4986	35 L	6.4961	6.5000	49 L	6.4961	6.5024	73 L	6.4958	6.4968	17 L
170	6.6929	6.6919	6.6929	6.6954	0 L	6.6929	6.6968	0 L	6.6929	6.6992	0 L	6.6926	6.6936	3 T
180	7.0866	7.0856	7.0866	7.0891		7.0866	7.0905		7.0866	7.0929		7.0863	7.0873	
190	7.4803	7.4791	7.4803	7.4831		7.4803	7.4848		7.4803	7.4876		7.4800	7.4812	
200	7.8740	7.8728	7.8740	7.8768		7.8740	7.8785		7.8740	7.8813		7.8737	7.8749	
210	8.2677	8.2665	8.2677	8.2705		8.2677	8.2722		8.2677	8.2750		8.2674	8.2686	
215	8.4646	8.4634	8.4646	8.4674	40 L	8.4646	8.4691	57 L	8.4646	8.4719	85 L	8.4643	8.4655	21 L
220	8.6614	8.6602	8.6614	8.6642	0 L	8.6614	8.6659	0 L	8.6614	8.6687	0 L	8.6611	8.6623	3 T
225	8.8583	8.8571	8.8583	8.8611		8.8583	8.8628		8.8583	8.8656		8.8580	8.8592	
230	9.0551	9.0539	9.0551	9.0579		9.0551	9.0596		9.0551	9.0624		9.0548	9.0560	
240	9.4488	9.4476	9.4488	9.4516		9.4488	9.4533		9.4488	9.4561		9.4485	9.4497	
250	9.8425	9.8413	9.8425	9.8453		9.8425	9.8470		9.8425	9.8498		9.8422	9.8434	

Note: To convert inches to mm, multiply inches by 25.4

<sup>1)</sup> L indicates "LOOSE" fit, T indicates "TIGHT" fit

**Table 9**

Housing bearing-seat diameters (values in inches)														
Bearing outside diameter			H8			H9			H10			J6		
			Housing bore		Resultant fit <sup>1)</sup> in	Housing bore		Resultant fit <sup>1)</sup> in	Housing bore		Resultant fit <sup>1)</sup> in	Housing bore		Resultant fit <sup>1)</sup> in
mm	inches		min.	max.	0.0001"	min.	max.	0.0001"	min.	max.	0.0001"	min.	max.	0.0001"
260	10.2362	10.2348	10.2362	10.2394		10.2362	10.2413		10.2362	10.2445		10.2359	10.2372	
270	10.6299	10.6285	10.6299	10.6331		10.6299	10.6350		10.6299	10.6382		10.6296	10.6309	
280	11.0236	11.0222	11.0236	11.0268	46 L	11.0236	11.0287	65 L	11.0236	11.0319	97 L	11.0233	11.0246	24 L
290	11.4173	11.4159	11.4173	11.4205	0 L	11.4173	11.4224	0 L	11.4173	11.4256	0 L	11.4170	11.4183	3 T
300	11.8110	11.8096	11.8110	11.8142		11.8110	11.8161		11.8110	11.8193		11.8107	11.8120	
310	12.2047	12.2033	12.2047	12.2079		12.2047	12.2098		12.2047	12.2130		12.2044	12.2057	
320	12.5984	12.5968	12.5984	12.6019		12.5984	12.6039		12.5984	12.6075		12.5981	12.5995	
340	13.3858	13.3842	13.3858	13.3893		13.3858	13.3913		13.3858	13.3949		13.3855	13.3869	
360	14.1732	14.1716	14.1732	14.1767	51 L	14.1732	14.1787	71 L	14.1732	14.1823	107 L	14.1729	14.1743	27 L
370	14.5669	14.5654	14.5670	14.5705	0 L	14.5669	14.5724	0 L	14.5670	14.5761	0 L	14.5666	14.5681	3 T
380	14.9606	14.9590	14.9606	14.9641		14.9606	14.9661		14.9606	14.9697		14.9603	14.9617	
400	15.7480	15.7464	15.7480	15.7515		15.7480	15.7535		15.7480	15.7571		15.7477	15.7491	
420	16.5354	16.5336	16.5354	16.5392		16.5354	16.5415		16.5354	16.5452		16.5351	16.5367	
440	17.3228	17.3210	17.3228	17.3266	56 L	17.3228	17.3289	79 L	17.3228	17.3326	116 L	17.3225	17.3241	31 L
460	18.1102	18.1084	18.1102	18.1140	0 L	18.1102	18.1163	0 L	18.1102	18.1200	0 L	18.1099	18.1115	3 T
480	18.8976	18.8958	18.8976	18.9014		18.8976	18.9037		18.8976	18.9074		18.8973	18.8989	
500	19.6850	19.6832	19.6850	19.6888		19.6850	19.6911		19.6850	19.6948		19.6847	19.6863	
520	20.4724	20.4704	20.4724	20.4767		20.4724	20.4793		20.4724	20.4834		20.4721	20.4739	
540	21.2598	21.2578	21.2598	21.2641		21.2598	21.2667		21.2598	21.2708		21.2595	21.2613	
560	22.0472	22.0452	22.0472	22.0515	63 L	22.0472	22.0541	89 L	22.0472	22.0582	130 L	22.0469	22.0487	35 L
580	22.8346	22.8326	22.8346	22.8389	0 L	22.8346	22.8415	0 L	22.8346	22.8456	0 L	22.8343	22.8361	3 T
600	23.6220	23.6200	23.6220	23.6263		23.6220	23.6289		23.6220	23.6330		23.6217	23.6235	
620	24.4094	24.4074	24.4094	24.4137		24.4094	24.4163		24.4094	24.4204		24.4091	24.4109	
650	25.5906	25.5876	25.5906	25.5955		25.5906	25.5985		25.5906	25.6032		25.5902	25.5922	
670	26.3780	26.3750	26.3780	26.3829		26.3780	26.3859		26.3780	26.3906		26.3776	26.3796	
680	26.7717	26.7687	26.7717	26.7766		26.7717	26.7796		26.7717	26.7843		26.7713	26.7733	
700	27.5591	27.5561	27.5591	27.5640		27.5591	27.5670		27.5591	27.5717		27.5587	27.5607	
720	28.3465	28.3435	28.3465	28.3514	79 L	28.3465	28.3544	109 L	28.3465	28.3591	156 L	28.3461	28.3481	46 L
750	29.5276	29.5246	29.5276	29.5325	0 L	29.5276	29.5355	0 L	29.5276	29.5402	0 L	29.5272	29.5292	4 T
760	29.9213	29.9183	29.9213	29.9262		29.9213	29.9292		29.9213	29.9339		29.9209	29.9229	
780	30.7087	30.7057	30.7087	30.7136		30.7087	30.7166		30.7087	30.7213		30.7083	30.7103	
790	31.1024	31.0994	31.1024	31.1073		31.1024	31.1103		31.1024	31.1150		31.1020	31.1040	
800	31.4961	31.4931	31.4961	31.5010		31.4961	31.5040		31.4961	31.5087		31.4957	31.4968	
820	32.2835	32.2796	32.2835	32.3890		32.2835	32.2926		32.2835	32.2977		32.2831	32.2853	
830	32.6772	32.6733	32.6772	32.6827		32.6772	32.6863		32.6772	32.6914		32.6768	32.6790	
850	33.4646	33.4607	33.4646	33.4701		33.4646	33.4737		33.4646	33.4788		33.4642	33.4664	
870	34.2520	34.2481	34.2520	34.2575	94 L	34.2520	34.2611	130 L	34.2520	34.2662	181 L	34.2516	34.2538	57 L
920	36.2205	36.2166	36.2205	36.2260	0 L	36.2205	36.2296	0 L	36.2205	36.2347	0 L	36.2201	36.2223	4 T
950	37.4016	37.3977	37.4016	37.4071		37.4016	37.4107		37.4016	37.4158		37.4012	37.4034	
980	38.5827	38.5788	38.5827	38.5882		38.5827	38.5918		38.5827	38.5969		38.5823	38.5845	
1000	39.3701	39.3662	39.3701	39.3756		39.3701	39.3792		39.3701	39.3843		—	—	
1150	45.2756	45.2707	45.2756	45.2821	114 L	45.2756	45.2858	151 L	45.2756	45.2921	214 L	—	—	
1250	49.2126	49.2077	49.2126	49.2191	0 L	49.2126	49.2228	0 L	49.2126	49.2291	0 L	—	—	
1400	55.1181	55.1118	55.1181	55.1258	140 L	55.1181	55.1303	185 L	55.1181	55.1378	260 L	—	—	
1600	62.9921	62.9858	62.9921	62.9998	0 L	62.9921	63.0043	0 L	62.9921	63.0118	0 L	—	—	
1800	70.8661	70.8582	70.8661	70.8752	170 L	70.8661	70.8807	225 L	70.8661	70.8897	315 L	—	—	
2000	78.7402	78.7323	78.7402	78.7493	0 L	78.7402	78.7548	0 L	78.7402	78.7638	0 L	—	—	
2300	90.5512	90.5414	90.5512	90.5622	208 L	90.5512	90.5685	271 L	90.5512	90.5788	374 L	—	—	
2500	98.4252	98.4154	98.4252	98.4362	0 L	98.4252	98.4425	0 L	98.4252	98.4528	0 L	—	—	

Note: To convert inches to mm, multiply inches by 25.4

<sup>1)</sup> L indicates "LOOSE" fit, T indicates "TIGHT" fit

**Table 9**

Housing bearing-seat diameters (values in inches)														
Bearing outside diameter			J7			JS5			K5			K6		
			Housing bore		Resultant fit <sup>1)</sup> in 0.0001"	Housing bore		Resultant fit <sup>1)</sup> in 0.0001"	Housing bore		Resultant fit <sup>1)</sup> in 0.0001"	Housing bore		Resultant fit <sup>1)</sup> in 0.0001"
mm	inches		min.	max.		min.	max.		min.	max.		min.	max.	
	max.	min.	min.	max.		min.	max.		min.	max.		min.	max.	
16	0.6299	0.6296	0.6296	0.6303	7 L 3 T	0.6297	0.6301	2 T 5 L	0.6297	0.6300	4 L 2 T	0.6295	0.6300	4 L 4 T
19	0.7480	0.7476	0.7476	0.7485		0.7478	0.7481		0.7477	0.7480		0.7476	0.7481	
22	0.8661	0.8657	0.8657	0.8666		0.8659	0.8662		0.8658	0.8661		0.8657	0.8662	
24	0.9449	0.9445	0.9445	0.9454	9 L	0.9447	0.9450	2 T	0.9446	0.9449	4 L	0.9445	0.9450	5 L
26	1.0236	1.0232	1.0232	1.0241	4 T	1.0234	1.0237	5 L	1.0233	1.0236	3 T	1.0232	1.0237	4 T
28	1.1024	1.1020	1.1020	1.1029		1.1022	1.1025		1.1021	1.1024		1.1020	1.1025	
30	1.1811	1.1807	1.1807	1.1816		1.1809	1.1812		1.1808	1.1811		1.1807	1.1812	
32	1.2598	1.2594	1.2594	1.2604		1.2596	1.2600		1.2594	1.2599		1.2593	1.2599	
35	1.3780	1.3776	1.3776	1.3786		1.3778	1.3782		1.3776	1.3781		1.3775	1.3781	
37	1.4567	1.4563	1.4563	1.4573	10 L	1.4565	1.4569	2 T	1.4563	1.4568	5 L	1.4562	1.4568	5 L
40	1.5748	1.5744	1.5744	1.5754	4 T	1.5746	1.5750	6 L	1.5744	1.5749	4 T	1.5743	1.5749	5 T
42	1.6535	1.6531	1.6531	1.6541		1.6533	1.6537		1.6531	1.6536		1.6530	1.6536	
47	1.8504	1.8500	1.8500	1.8510		1.8502	1.8506		1.8500	1.8505		1.8499	1.8505	
52	2.0472	2.0467	2.0467	2.0479		2.0469	2.0475		2.0468	2.0473		2.0466	2.0474	
55	2.1654	2.1649	2.1649	2.1661		2.1651	2.1657		2.1650	2.1655		2.1648	2.1656	
62	2.4409	2.4404	2.4404	2.4416	12 L	2.4406	2.4412	3 T	2.4405	2.4410	6 L	2.4403	2.4411	7 L
68	2.6772	2.6767	2.6767	2.6779	5 T	2.6769	2.6775	8 L	2.6768	2.6773	4 T	2.6766	2.6774	6 T
72	2.8346	2.8341	2.8341	2.8353		2.8343	2.8349		2.8342	2.8347		2.8340	2.8348	
75	2.9527	2.9522	2.9522	2.9534		2.9524	2.9530		2.9523	2.9528		2.9521	2.9529	
80	3.1496	3.1491	3.1491	3.1503		3.1493	3.1499		3.1492	3.1497		3.1490	3.1498	
85	3.3465	3.3459	3.3460	3.3474		3.3462	3.3468		3.3460	3.3466		3.3458	3.3467	
90	3.5433	3.5427	3.5428	3.5442		3.5430	3.5436		3.5428	3.5434		3.5426	3.5435	
95	3.7402	3.7396	3.7397	3.7411		3.7399	3.7405		3.7397	3.7403		3.7395	3.7404	
100	3.9370	3.9364	3.9365	3.9379	15 L	3.9367	3.9373	3 T	3.9365	3.9371	7 L	3.9363	3.9372	8 L
110	4.3307	4.3301	4.3302	4.3316	5 T	4.3304	4.3310	9 L	4.3302	4.3308	5 T	4.3300	4.3309	7 T
115	4.5276	4.5270	4.5271	4.5285		4.5273	4.5279		4.5271	4.5277		4.5269	4.5278	
120	4.7244	4.7238	4.7239	4.7253		4.7241	4.7247		4.7239	4.7245		4.7237	4.7246	
125	4.9213	4.9206	4.9207	4.9223		4.9209	4.9217		4.9207	4.9214		4.9205	4.9215	
130	5.1181	5.1174	5.1175	5.1191		5.1177	5.1185		5.1175	5.1182		5.1173	5.1183	
140	5.5118	5.5111	5.5112	5.5128	17 L	5.5114	5.5122	4 T	5.5112	5.5119	8 L	5.5110	5.5120	9 L
145	5.7087	5.7080	5.7081	5.7097	6 T	5.7083	5.7091	11 L	5.7081	5.7088	6 T	5.7079	5.7089	8 T
150	5.9055	5.9048	5.9049	5.9065		5.9051	5.9059		5.9049	5.9056		5.9047	5.9057	
160	6.2992	6.2982	6.2986	6.3002		6.2988	6.2995		6.2986	6.2993		6.2984	6.2994	
165	6.4961	6.4951	6.4955	6.4971	20 L	6.4957	6.4964	4 T	6.4955	6.4962	11 L	6.4953	6.4963	12 L
170	6.6929	6.6919	6.6923	6.6939	6 T	6.6925	6.6932	13 L	6.6923	6.6930	6 T	6.6921	6.6931	8 T
180	7.0866	7.0856	7.0860	7.0876		7.0862	7.0869		7.0860	7.0867		7.0858	7.0868	
190	7.4803	7.4791	7.4797	7.4815		7.4799	7.4807		7.4796	7.4804		7.4794	7.4805	
200	7.8740	7.8728	7.8734	7.8752		7.8736	7.8744		7.8733	7.8741		7.8731	7.8742	
210	8.2677	8.2665	8.2671	8.2689		8.2673	8.2681		8.2670	8.2678		8.2668	8.2679	
215	8.4646	8.4634	8.4640	8.4658	24 L	8.4642	8.4650	4 T	8.4639	8.4647	13 L	8.4637	8.4648	14 L
220	8.6614	8.6602	8.6608	8.6626	6 T	8.6610	8.6618	16 L	8.6607	8.6615	7 T	8.6605	8.6616	9 T
225	8.8583	8.8571	8.8577	8.8595		8.8579	8.8587		8.8576	8.8584		8.8574	8.8585	
230	9.0551	9.0539	9.0545	9.0563		9.0547	9.0555		9.0544	9.0552		9.0542	9.0553	
240	9.4488	9.4476	9.4482	9.4500		9.4484	9.4492		9.4481	9.4489		9.4479	9.4490	
250	9.8425	9.8413	9.8419	9.8437		9.8421	9.8429		9.8418	9.8426		9.8416	9.8427	

Note: To convert inches to mm, multiply inches by 25.4

<sup>1)</sup> L indicates "LOOSE" fit, T indicates "TIGHT" fit

Table 9

Housing bearing-seat diameters (values in inches)														
Bearing outside diameter			J7			J5			K5			K6		
			Housing bore		Resultant fit <sup>1)</sup> in 0.0001"	Housing bore		Resultant fit <sup>1)</sup> in 0.0001"	Housing bore		Resultant fit <sup>1)</sup> in 0.0001"	Housing bore		Resultant fit <sup>1)</sup> in 0.0001"
mm	inches		min.	max.		min.	max.		min.	max.		min.	max.	
260	10.2362	10.2348	10.2356	10.2376		10.2357	10.2366		10.2354	10.2363		10.2351	10.2364	
270	10.6299	10.6285	10.6293	10.6313		10.6294	10.6303		10.6291	10.6300		10.6288	10.6301	
280	11.0236	11.0222	11.0230	11.0250	28 L	11.0231	11.0240	5 T	11.0228	11.0237	15 L	11.0225	11.0238	
290	11.4173	11.4159	11.4167	11.4187	6 T	11.4168	11.4177	18 L	11.4165	11.4174	8 T	11.4162	11.4175	
300	11.8110	11.8096	11.8104	11.8124		11.8105	11.8114		11.8102	11.8111		11.8099	11.8112	
310	12.2047	12.2033	12.2041	12.2061		12.2042	12.2051		12.2039	12.2048		12.2036	12.2049	
320	12.5984	12.5968	12.5977	12.5999		12.5979	12.5989		12.5975	12.5985		12.5973	12.5986	
340	13.3858	13.3842	13.3851	13.3873		13.3853	13.3863		13.3849	13.3859		13.3847	13.3860	
360	14.1732	14.1716	14.1725	14.1747	31 L	14.1727	14.1737	5 T	14.1723	14.1733	17 L	14.1721	14.1734	
370	14.5669	14.5654	14.5662	14.5685	7 T	14.5664	14.5675	21 L	14.5660	14.5670	9 T	14.5658	14.5672	
380	14.9606	14.9590	14.9599	14.9621		14.9601	14.9611		14.9597	14.9607		14.9595	14.9608	
400	15.7480	15.7464	15.7473	15.7495		15.7475	15.7485		15.7471	15.7481		15.7469	15.7482	
420	16.5354	16.5336	16.5346	16.5371		16.5349	16.5359		16.5344	16.5355		16.5341	16.5356	
440	17.3228	17.3210	17.3220	17.3245	35 L	17.3223	17.3233	5 T	17.3218	17.3229	19 L	17.3215	17.3230	
460	18.1102	18.1084	18.1094	18.1119	8 T	18.1097	18.1107	23 L	18.1092	18.1103	10 T	18.1089	18.1104	
480	18.8976	18.8958	18.8968	18.8993		18.8971	18.8981		18.8966	18.8977		18.8963	18.8978	
500	19.6850	19.6832	19.6842	19.6867		19.6845	19.6855		19.6840	19.6851		19.6837	19.6852	
520	20.4724	20.4704	20.4715	20.4743		—	—		—	—		20.4707	20.4724	
540	21.2598	21.2578	21.2589	21.2617		—	—		—	—		21.2581	21.2598	
560	22.0472	22.0452	22.0463	22.0491	39 L	—	—		—	—		22.0455	22.0472	
580	22.8346	22.8326	22.8337	22.8365	9 T	—	—		—	—		22.8329	22.8346	
600	23.6220	23.6200	23.6211	23.6239		—	—		—	—		23.6203	23.6220	
620	24.4094	24.4074	24.4085	24.4113		—	—		—	—		24.4077	24.4094	
650	25.5906	25.5876	25.5897	25.5928		—	—		—	—		25.5886	25.5906	
670	26.3780	26.3750	26.3771	26.3802		—	—		—	—		26.3760	26.3780	
680	26.7717	26.7687	26.7708	26.7739		—	—		—	—		26.7697	26.7717	
700	27.5591	27.5561	27.5582	27.5613		—	—		—	—		27.5571	27.5591	
720	28.3465	28.3435	28.3456	28.3487	52 L	—	—		—	—		28.3445	28.3465	
750	29.5276	29.5246	29.5267	29.5298	9 T	—	—		—	—		29.5256	29.5276	
760	29.9213	29.9183	29.9204	29.9235		—	—		—	—		29.9193	29.9213	
780	30.7087	30.7057	30.7078	30.7109		—	—		—	—		30.7067	30.7087	
790	31.1024	31.0994	31.1015	31.1046		—	—		—	—		31.1004	31.1024	
800	31.4961	31.4931	31.4952	31.4974		—	—		—	—		31.4941	31.4952	
820	32.2835	32.2796	32.2825	32.2860		—	—		—	—		32.2813	32.2835	
830	32.6772	32.6733	32.6762	32.6797		—	—		—	—		32.6750	32.6772	
850	33.4646	33.4607	33.4636	33.4671		—	—		—	—		33.4624	33.4646	
870	34.2520	34.2481	34.2510	34.2545	64 L	—	—		—	—		34.2498	34.2520	
920	36.2205	36.2166	36.2195	36.2230	10 T	—	—		—	—		36.2183	36.2205	
950	37.4016	37.3977	37.4006	37.4041		—	—		—	—		37.3994	37.4016	
980	38.5827	38.5788	38.5817	38.5852		—	—		—	—		38.5805	38.5827	
1000	39.3701	39.3662	—	—		—	—		—	—		—	—	
1150	45.2756	45.2707	—	—		—	—		—	—		—	—	
1250	49.2126	49.2077	—	—		—	—		—	—		—	—	
1400	55.1181	55.1118	—	—		—	—		—	—		—	—	
1600	62.9921	62.9858	—	—		—	—		—	—		—	—	
1800	70.8661	70.8582	—	—		—	—		—	—		—	—	
2000	78.7402	78.7323	—	—		—	—		—	—		—	—	
2300	90.5512	90.5414	—	—		—	—		—	—		—	—	
2500	98.4252	98.4154	—	—		—	—		—	—		—	—	

Note: To convert inches to mm, multiply inches by 25.4

<sup>1)</sup> L indicates "LOOSE" fit, T indicates "TIGHT" fit

Table 9

Housing bearing-seat diameters (values in inches)														
Bearing outside diameter			K7			M5			M6			M7		
			Housing bore		Resultant fit <sup>1)</sup> in 0.0001"	Housing bore		Resultant fit <sup>1)</sup> in 0.0001"	Housing bore		Resultant fit <sup>1)</sup> in 0.0001"	Housing bore		Resultant fit <sup>1)</sup> in 0.0001"
mm	inches		min.	max.		min.	max.		min.	max.		min.	max.	
	max.	min.	min.	max.		min.	max.		min.	max.		min.	max.	
16	0.6299	0.6296	0.6294	0.6301	5 L 5 T	0.6294	0.6298	2 L 5 T	0.6293	0.6297	1 L 6 T	0.6292	0.6299	3 L 7 T
19	0.7480	0.7476	0.7474	0.7482		0.7474	0.7478		0.7473	0.7478		0.7472	0.7480	
22	0.8661	0.8657	0.8655	0.8663		0.8655	0.8659		0.8654	0.8659		0.8653	0.8661	
24	0.9449	0.9445	0.9443	0.9451	6 L	0.9443	0.9447	2 L	0.9442	0.9447	2 L	0.9441	0.9449	4 L
26	1.0236	1.0232	1.0230	1.0238	6 T	1.0230	1.0234	6 T	1.0229	1.0234	7 T	1.0228	1.0236	8 T
28	1.1024	1.1020	1.1018	1.1026		1.1018	1.1022		1.1017	1.1022		1.1016	1.1024	
30	1.1811	1.1807	1.1805	1.1813		1.1805	1.1809		1.1804	1.1809		1.1803	1.1811	
32	1.2598	1.2594	1.2591	1.2601		1.2592	1.2596		1.2590	1.2596		1.2588	1.2598	
35	1.3780	1.3776	1.3773	1.3783		1.3774	1.3778		1.3772	1.3778		1.3770	1.3780	
37	1.4567	1.4563	1.4560	1.4570	7 L	1.4561	1.4565	2 L	1.4559	1.4565		1.4557	1.4567	4 L
40	1.5748	1.5744	1.5741	1.5751	7 T	1.5742	1.5746	6 T	1.5740	1.5746	8 T	1.5738	1.5748	10 T
42	1.6535	1.6531	1.6528	1.6538		1.6529	1.6533		1.6527	1.6533		1.6525	1.6535	
47	1.8504	1.8500	1.8497	1.8507		1.8498	1.8502		1.8496	1.8502		1.8494	1.8504	
52	2.0472	2.0467	2.0464	2.0476		2.0465	2.0470		2.0463	2.0470		2.0460	2.0472	
55	2.1654	2.1649	2.1646	2.1658		2.1647	2.1652		2.1645	2.1652		2.1642	2.1654	
62	2.4409	2.4404	2.4401	2.4413	9 L	2.4402	2.4407	3 L	2.4400	2.4407	3 L	2.4397	2.4409	5 L
68	2.6772	2.6767	2.6764	2.6776	8 T	2.6765	2.6770	7 T	2.6763	2.6770	9 T	2.6760	2.6772	12 T
72	2.8346	2.8341	2.8338	2.8350		2.8339	2.8344		2.8337	2.8344		2.8334	2.8346	
75	2.9527	2.9522	2.9519	2.9531		2.9520	2.9525		2.9518	2.9525		2.9516	2.9528	
80	3.1496	3.1491	3.1488	3.1500		3.1489	3.1494		3.1487	3.1494		3.1484	3.1496	
85	3.3465	3.3459	3.3455	3.3469		3.3456	3.3462		3.3454	3.3463		3.3451	3.3465	
90	3.5433	3.5427	3.5423	3.5437		3.5424	3.5430		3.5422	3.5431		3.5419	3.5433	
95	3.7402	3.7396	3.7392	3.7406		3.7393	3.7399		3.7391	3.7400		3.7388	3.7402	
100	3.9370	3.9364	3.9360	3.9374	10 L	3.9361	3.9367	3 L	3.9359	3.9368	4 L	3.9356	3.9370	6 L
110	4.3307	4.3301	4.3297	4.3311	10 T	4.3298	4.3304	9 T	4.3296	4.3305	11 T	4.3293	4.3307	14 T
115	4.5276	4.5270	4.5266	4.5280		4.5265	4.5273		4.5265	4.5274		4.5262	4.5276	
120	4.7244	4.7238	4.7234	4.7248		4.7235	4.7241		4.7233	4.7242		4.7230	4.7244	
125	4.9213	4.9206	4.9202	4.9218		4.9202	4.9210		4.9200	4.9210		4.9197	4.9213	
130	5.1181	5.1174	5.1170	5.1186		5.1170	5.1178		5.1168	5.1178		5.1165	5.1181	
140	5.5118	5.5111	5.5107	5.5123	12 L	5.5107	5.5115	4 L	5.5105	5.5115	4 L	5.5102	5.5118	7 L
145	5.7087	5.7080	5.7076	5.7092	11 T	5.7076	5.7084	11 T	5.7074	5.7084	13 T	5.7071	5.7087	16 T
150	5.9055	5.9048	5.9044	5.9060		5.9044	5.9052		5.9042	5.9052		5.9039	5.9055	
160	6.2992	6.2982	6.2981	6.2997		6.2981	6.2988		6.2979	6.2989		6.2976	6.2992	
165	6.4961	6.4951	6.4950	6.4966	15 L	6.4950	6.4957	6 L	6.4948	6.4958	7 L	6.4945	6.4961	10 L
170	6.6929	6.6919	6.6918	6.6934	11 T	6.6918	6.6925	11 T	6.6916	6.6926	13 T	6.6913	6.6929	16 T
180	7.0866	7.0856	7.0855	7.0871		7.0855	7.0862		7.0853	7.0863		7.0850	7.0866	
190	7.4803	7.4791	7.4790	7.4808		7.4791	7.4798		7.4788	7.4800		7.4785	7.4803	
200	7.8740	7.8728	7.8727	7.8745		7.8728	7.8735		7.8725	7.8737		7.8722	7.8740	
210	8.2677	8.2665	8.2664	8.2682		8.2665	8.2672		8.2662	8.2674		8.2659	8.2677	
215	8.4646	8.4634	8.4633	8.4651	17 L	8.4634	8.4641	7 L	8.4631	8.4643	9 L	8.4628	8.4646	12 L
220	8.6614	8.6602	8.6601	8.6619	13 T	8.6602	8.6609	12 T	8.6599	8.6611	15 T	8.6596	8.6614	18 T
225	8.8583	8.8571	8.8570	8.8588		8.8571	8.8578		8.8568	8.8580		8.8565	8.8583	
230	9.0551	9.0539	9.0538	9.0556		9.0539	9.0546		9.0536	9.0548		9.0533	9.0551	
240	9.4488	9.4476	9.4475	9.4493		9.4476	9.4483		9.4473	9.4485		9.4470	9.4488	
250	9.8425	9.8413	9.8412	9.8430		9.8413	9.8420		9.8410	9.8422		9.8407	9.8425	

Note: To convert inches to mm, multiply inches by 25.4

<sup>1)</sup> L indicates "LOOSE" fit, T indicates "TIGHT" fit

Table 9

Housing bearing-seat diameters (values in inches)														
Bearing outside diameter			K7			M5			M6			M7		
mm	inches		Housing bore		Resultant fit <sup>1)</sup> in 0.0001"	Housing bore		Resultant fit <sup>1)</sup> in 0.0001"	Housing bore		Resultant fit <sup>1)</sup> in 0.0001"	Housing bore		Resultant fit <sup>1)</sup> in 0.0001"
	max.	min.	min.	max.		min.	max.		min.	max.		min.	max.	
260	10.2362	10.2348	10.2348	10.2368		10.2348	10.2357		10.2346	10.2364		10.2342	10.2362	
270	10.6299	10.6285	10.6285	10.6305		10.6285	10.6294		10.6283	10.6301		10.6279	10.6299	
280	11.0236	11.0222	11.0222	11.0242	20 L	11.0222	11.0231	9 L	11.0220	11.0238	10 L	11.0216	11.0236	14 L
290	11.4173	11.4159	11.4159	11.4179	14 T	11.4159	11.4168	14 T	11.4157	11.4175	16 T	11.4153	11.4173	20 T
300	11.8110	11.8096	11.8096	11.8116		11.8096	11.8105		11.8094	11.8112		11.8090	11.8110	
310	12.2047	12.2033	12.2033	12.2053		12.2033	12.2042		12.2031	12.2049		12.2027	12.2047	
320	12.5984	12.5968	12.5968	12.5991		12.5969	12.5978		12.5966	12.5986		12.5962	12.5984	
340	13.3858	13.3842	13.3842	13.3865		13.3843	13.3852		13.3840	13.3860		12.3836	12.3858	
360	14.1732	14.1716	14.1716	14.1739	23 L	14.1717	14.1726	10 L	14.1714	14.1734	12 L	14.1710	14.1732	16 L
370	14.5669	14.5654	14.5653	14.5677	16 T	14.5654	14.5664	15 T	14.5651	14.5672	18 T	14.5647	14.5669	22 T
380	14.9606	14.9590	14.9590	14.9613		14.9591	14.9600		14.9588	14.9608		14.9584	14.9606	
400	15.7480	15.7464	15.7464	15.7487		15.7465	15.7474		15.7462	15.7482		15.7458	15.7480	
420	16.5354	16.5336	16.5336	16.5361		16.5337	16.5347		16.5334	16.5356		16.5329	16.5354	
440	17.3228	17.3210	17.3210	17.3235	25 L	17.3211	17.3221	11 L	17.3208	17.3230	14 L	17.3203	17.3228	18 L
460	18.1102	18.1084	18.1084	18.1109	18 T	18.1085	18.1095	17 T	18.1082	18.1104	20 T	18.1077	18.1102	25 T
480	18.8976	18.8958	18.8958	18.8983		18.8959	18.8969		18.8956	18.8978		18.8951	18.8976	
500	19.6850	19.6832	19.6832	19.6857		19.6833	19.6843		19.6830	19.6852		19.6825	19.6850	
520	20.4724	20.4704	20.4696	20.4724		—	—		20.4696	20.4714		20.4686	20.4714	
540	21.2598	21.2578	21.2570	21.2598		—	—		21.2570	21.2588		21.2560	21.2588	
560	22.0472	22.0452	22.0444	22.0472	20 L	—	—		22.0444	22.0462	10 L	22.0435	22.0462	10 L
580	22.8346	22.8326	22.8318	22.8346	28 T	—	—		22.8318	22.8336	28 T	22.8308	22.8336	38 T
600	23.6220	23.6200	23.6192	23.6220		—	—		23.6192	23.6210		23.6182	23.6210	
620	24.4094	24.4074	24.4066	24.4094		—	—		24.4066	24.4084		24.4056	24.4084	
650	25.5906	25.5876	25.5875	25.5906		—	—		25.5875	25.5894		25.5863	25.5894	
670	26.3780	26.3750	26.3749	26.3780		—	—		26.3749	26.3768		26.3737	26.3768	
680	26.7717	26.7687	26.7686	26.7717		—	—		26.7686	26.7705		26.7674	26.7705	
700	27.5591	27.5561	27.5560	27.5591		—	—		27.5560	27.5579		27.5548	27.5579	
720	28.3465	28.3435	28.3434	28.3465	30 L	—	—		28.3434	28.3453	18 L	28.3422	28.3453	18 L
750	29.5276	29.5246	29.5245	29.5276	31 T	—	—		29.5245	29.5264	31 T	29.5233	29.5264	43 T
760	29.9213	29.9183	29.9182	29.9213		—	—		29.9182	29.9201		29.9169	29.9201	
780	30.7087	30.7057	30.7056	30.7087		—	—		30.7056	30.7075		30.7044	30.7075	
790	31.1024	31.0994	31.0993	31.1024		—	—		31.0993	31.1012		31.0981	31.1012	
800	31.4961	31.4931	31.4930	31.4952		—	—		31.4930	31.4940		31.4917	31.4949	
820	32.2835	32.2796	32.2800	32.2835		—	—		32.2800	32.2822		32.2786	32.2822	
830	32.6772	32.6733	32.6737	32.6772		—	—		32.6737	32.6759		32.6723	32.6758	
850	33.4646	33.4607	33.4611	33.4646		—	—		33.4611	33.4633		33.4597	33.4633	
870	34.2520	34.2481	34.2485	34.2520	39 L	—	—		34.2485	34.2507	26 L	34.2471	34.2507	26 L
920	36.2205	36.2166	36.2170	36.2205	35 T	—	—		36.2170	36.2192	35 T	36.2156	36.2192	49 T
950	37.4016	37.3977	37.3981	37.4016		—	—		37.3981	37.4003		37.3967	37.4003	
980	38.5827	38.5788	38.5792	38.5827		—	—		38.5792	38.5814		38.5778	38.5814	
1000	39.3701	39.3662	—	—		—	—		—	—		39.3652	39.3688	
1150	45.2756	45.2707	—	—		—	—		—	—		45.2699	45.2740	33 L
1250	49.2126	49.2077	—	—		—	—		—	—		49.2069	49.2110	57 T
1400	55.1181	55.1118	—	—		—	—		—	—		55.1113	55.1162	44 L
1600	62.9921	62.9858	—	—		—	—		—	—		62.9853	62.9902	68 T
1800	70.8661	70.8582	—	—		—	—		—	—		70.8579	70.8638	56 L
2000	78.7402	78.7323	—	—		—	—		—	—		78.7320	78.7379	82 T
2300	90.5512	90.5414	—	—		—	—		—	—		90.5416	90.5485	71 L
2500	98.4252	98.4154	—	—		—	—		—	—		98.4156	98.4225	96 T

Note: To convert inches to mm, multiply inches by 25.4

<sup>1)</sup> L indicates "LOOSE" fit, T indicates "TIGHT" fit

Table 9

Housing bearing-seat diameters (values in inches)														
Bearing outside diameter			N6			N7			P6			P7		
mm	inches		Housing bore		Resultant fit <sup>1)</sup> in 0.0001"	Housing bore		Resultant fit <sup>1)</sup> in 0.0001"	Housing bore		Resultant fit <sup>1)</sup> in 0.0001"	Housing bore		Resultant fit <sup>1)</sup> in 0.0001"
	max.	min.	min.	max.		min.	max.		min.	max.		min.	max.	
16	0.6299	0.6296	0.6291	0.6295	1 T 8 T	0.6290	0.6297	1 L 9 T	0.6289	0.6293	3 T 10 T	0.6288	0.6295	1 T 11 T
19	0.7480	0.7476	0.7471	0.7476		0.7469	0.7477		0.7468	0.7473		0.7466	0.7474	
22	0.8661	0.8657	0.8652	0.8657		0.8650	0.8658		0.8649	0.8654		0.8647	0.8655	
24	0.9449	0.9445	0.9440	0.9445	0 T	0.9438	0.9446	1 L	0.9437	0.9442	3 T	0.9435	0.9443	2 T
26	1.0236	1.0232	1.0227	1.0232	9 T	1.0225	1.0233	11 T	1.0224	1.0229	12 T	1.0222	1.0230	14 T
28	1.1024	1.1020	1.1015	1.1020		1.1013	1.1021		1.1012	1.1017		1.1010	1.1018	
30	1.1811	1.1807	1.1802	1.1807		1.1800	1.1808		1.1799	1.1804		1.1797	1.1805	
32	1.2598	1.2594	1.2587	1.2593		1.2585	1.2595		1.2583	1.2590		1.2581	1.2591	
35	1.3780	1.3776	1.3769	1.3775		1.3767	1.3777		1.3765	1.3772		1.3763	1.3773	
37	1.4567	1.4563	1.4556	1.4562	1 T	1.4554	1.4564	1 L	1.4552	1.4559	4 T	1.4550	1.4560	3 T
40	1.5748	1.5744	1.5737	1.5743	11 T	1.5735	1.5745	13 T	1.5733	1.5740	15 T	1.5731	1.5741	17 T
42	1.6535	1.6531	1.6524	1.6530		1.6522	1.6532		1.6520	1.6527		1.6518	1.6528	
47	1.8504	1.8500	1.8493	1.8499		1.8491	1.8501		1.8489	1.8496		1.8487	1.8497	
52	2.0472	2.0467	2.0459	2.0466		2.0457	2.0468		2.0454	2.0462		2.0452	2.0464	
55	2.1654	2.1649	2.1641	2.1648		2.1639	2.1650		2.1636	2.1644		2.1634	2.1646	
62	2.4409	2.4404	2.4396	2.4403	1 T	2.4394	2.4405	1 L	2.4391	2.4399	5 T	2.4389	2.4401	3 T
68	2.6772	2.6767	2.6759	2.6766	13 T	2.6760	2.6770	15 T	2.6750	2.6760	18 T	2.6752	2.6763	20 T
72	2.8346	2.8341	2.8333	2.8340		2.8331	2.8342		2.8328	2.8336		2.8326	2.8338	
75	2.9527	2.9522	2.9515	2.9522		2.9510	2.9520		2.9510	2.9520		2.9507	2.9519	
80	3.1496	3.1491	3.1483	3.1490		3.1481	3.1492		3.1478	3.1486		3.1476	3.1488	
85	3.3465	3.3459	3.3450	3.3459		3.3447	3.3461		3.3445	3.3453		3.3442	3.3456	
90	3.5433	3.5427	3.5418	3.5427		3.5415	3.5429		3.5413	3.5421		3.5410	3.5424	
95	3.7402	3.7396	3.7387	3.7396		3.7380	3.7400		3.7380	3.7390		3.7378	3.7392	
100	3.9370	3.9364	3.9355	3.9364	0 T	3.9352	3.9366	2 L	3.9350	3.9358	6 T	3.9347	3.9361	3 T
110	4.3307	4.3301	4.3292	4.3301	15 T	4.3289	4.3303	18 T	4.3287	4.3295	20 T	4.3284	4.3298	23 T
115	4.5276	4.5270	4.5261	4.5270		4.5258	4.5272		4.5256	4.5264		4.5253	4.5267	
120	4.7244	4.7238	4.7229	4.7238		4.7226	4.7240		4.7224	4.7232		4.7221	4.7235	
125	4.9213	4.9206	4.9195	4.9205		4.9193	4.9208		4.9189	4.9199		4.9186	4.9202	
130	5.1181	5.1174	5.1163	5.1173		5.1161	5.1176		5.1157	5.1167		5.1154	5.1170	
140	5.5118	5.5111	5.5100	5.5110	1 T	5.5098	5.5113	2 L	5.5094	5.5104	7 T	5.5091	5.5107	4 T
145	5.7087	5.7080	5.7069	5.7079	18 T	5.7067	5.7082	20 T	5.7063	5.7073	24 T	5.7060	5.7076	27 T
150	5.9055	5.9048	5.9037	5.9047		5.9035	5.9050		5.9031	5.9041		5.9028	5.9044	
160	6.2992	6.2982	6.2974	6.2984		6.2972	6.2987		6.2968	6.2978		6.2965	6.2981	
165	6.4961	6.4951	6.4943	6.4953	2 L	6.4940	6.4960	5 L	6.4940	6.4950	4 T	6.4934	6.4950	1 T
170	6.6929	6.6919	6.6911	6.6921	18 T	6.6909	6.6924	20 T	6.6905	6.6915	24 T	6.6902	6.6918	27 T
180	7.0866	7.0856	7.0848	7.0858		7.0846	7.0861		7.0842	7.0852		7.0839	7.0855	
190	7.4803	7.4791	7.4783	7.4794		7.4779	7.4797		7.4775	7.4787		7.4772	7.4790	
200	7.8740	7.8728	7.8720	7.8731		7.8716	7.8734		7.8712	7.8724		7.8709	7.8727	
210	8.2677	8.2665	8.2657	8.2668		8.2653	8.2671		8.2649	8.2661		8.2646	8.2664	
215	8.4646	8.4634	8.4626	8.4637	3 L	8.4622	8.4640	6 L	8.4618	8.4630	4 T	8.4615	8.4633	1 T
220	8.6614	8.6602	8.6594	8.6606	20 T	8.6590	8.6610	24 T	8.6590	8.6600	28 T	8.6583	8.6601	31 T
225	8.8583	8.8571	8.8563	8.8574		8.8559	8.8577		8.8555	8.8567		8.8552	8.8570	
230	9.0551	9.0539	9.0531	9.0543		9.0530	9.0550		9.0520	9.0540		9.0520	9.0538	
240	9.4488	9.4476	9.4468	9.4479		9.4464	9.4482		9.4460	9.4472		9.4457	9.4475	
250	9.8425	9.8413	9.8405	9.8416		9.8401	9.8419		9.8397	9.8409		9.8394	9.8412	

Note: To convert inches to mm, multiply inches by 25.4

<sup>1)</sup> L indicates "LOOSE" fit, T indicates "TIGHT" fit



Table 9

Housing bearing-seat diameters (values in inches)														
Bearing outside diameter			N6			N7			P6			P7		
			Housing bore		Resultant fit <sup>1)</sup> in 0.0001"	Housing bore		Resultant fit <sup>1)</sup> in 0.0001"	Housing bore		Resultant fit <sup>1)</sup> in 0.0001"	Housing bore		Resultant fit <sup>1)</sup> in 0.0001"
mm	inches		min.	max.		min.	max.		min.	max.		min.	max.	
	max.	min.												
260	10.2362	10.2348	10.2340	10.2352		10.2336	10.2356		10.2331	10.2343		10.2327	10.2348	
270	10.6299	10.6285	10.6277	10.6289		10.6270	10.6290		10.6270	10.6280		10.6265	10.6285	
280	11.0236	11.0222	11.0214	11.0226	4 L	11.0210	11.0230	8 L	11.0205	11.0217	5 T	11.0201	11.0222	0 T
290	11.4173	11.4159	11.4151	11.4163	22 T	11.4150	11.4170	26 T	11.4140	11.4150	31 T	11.4139	11.4159	35 T
300	11.8110	11.8096	11.8088	11.8100		11.8084	11.8104		11.8079	11.8091		11.8075	11.8096	
310	12.2047	12.2033	12.2025	12.2037		12.2021	12.2041		12.2016	12.2028		12.2012	12.2033	
320	12.5984	12.5968	12.5960	12.5974		12.5955	12.5978		12.5950	12.5964		12.5945	12.5968	
340	13.3858	13.3842	13.3834	13.3848		13.3829	13.3852		13.3824	13.3838		13.3819	13.3842	
360	14.1732	14.1716	14.1708	14.1722	6 L	14.1703	14.1726	10 L	14.1698	14.1712	4 T	14.1693	14.1716	0 T
370	14.5669	14.5654	14.5645	14.5659	24 T	14.5640	14.5660	29 T	14.5640	14.5650	34 T	14.5631	14.5653	39 T
380	14.9606	14.9590	14.9582	14.9596		14.9577	14.9600		14.9572	14.9586		14.9567	14.9590	
400	15.7480	15.7464	15.7456	15.7470		15.7451	15.7474		15.7446	15.7460		15.7441	15.7464	
420	16.5354	16.5336	16.5328	16.5343		16.5323	16.5347		16.5317	16.5332		16.5311	16.5336	
440	17.3228	17.3210	17.3202	17.3217	7 L	17.3197	17.3221	11 L	17.3191	17.3206	4 T	17.3185	17.3210	0 T
460	18.1102	18.1084	18.1076	18.1091	26 T	18.1071	18.1095	31 T	18.1065	18.1080	37 T	18.1059	18.1084	43 T
480	18.8976	18.8958	18.8950	18.8965		18.8945	18.8969		18.8939	18.8954		18.8933	18.8958	
500	19.6850	19.6832	19.6824	19.6839		19.6819	19.6843		19.6813	19.6828		19.6807	19.6832	
520	20.4724	20.4704	20.4689	20.4707		20.4679	20.4707		20.4676	20.4693		20.4666	20.4693	
540	21.2598	21.2578	21.2563	21.2581		21.2553	21.2581		21.2550	21.2567		21.2540	21.2567	
560	22.0472	22.0452	22.0438	22.0455	3 L	22.0430	22.0460	3 L	22.0420	22.0440	11 T	22.0414	22.0442	11 T
580	22.8346	22.8326	22.8311	22.8329	35 T	22.8301	22.8329	45 T	22.8298	22.8315	48 T	22.8288	22.8315	58 T
600	23.6220	23.6200	23.6185	23.6203		23.6175	23.6203		23.6172	23.6189		23.6162	23.6189	
620	24.4094	24.4074	24.4059	24.4077		24.4049	24.4077		24.4046	24.4063		24.4036	24.4063	
650	25.5906	25.5876	25.5867	25.5886		25.5855	25.5886		25.5852	25.5871		25.5840	25.5871	
670	26.3780	26.3750	26.3741	26.3760		26.3729	26.3760		26.3726	26.3745		26.3714	26.3745	
680	26.7717	26.7687	26.7678	26.7697		26.7666	26.7697		26.7663	26.7682		26.7651	26.7682	
700	27.5591	27.5561	27.5552	27.5571		27.5540	27.5571		27.5537	27.5556		27.5525	27.5556	
720	28.3465	28.3435	28.3426	28.3445	10 L	28.3414	28.3445	10 L	28.3411	28.3430	5 T	28.3399	28.3430	5 T
750	29.5276	29.5246	29.5237	29.5256	39 T	29.5225	29.5256	51 T	29.5222	29.5241	54 T	29.5210	29.5241	66 T
760	29.9213	29.9183	29.9173	29.9193		29.9160	29.9190		29.9160	29.9180		29.9146	29.9178	
780	30.7087	30.7057	30.7048	30.7067		30.7036	30.7077		30.7033	30.7052		30.7021	30.7052	
790	31.1024	31.0994	31.0985	31.1004		31.0973	31.1004		31.0970	31.0989		31.0958	31.0989	
800	31.4961	31.4931	31.4921	31.4941		31.4910	31.4940		31.4910	31.4930		31.4894	31.4926	
820	32.2835	32.2796	32.2791	32.2813		32.2778	32.2813		32.2774	32.2796		32.2760	32.2796	
830	32.6772	32.6733	32.6728	32.6750		32.6710	32.6750		32.6710	32.6730		32.6697	32.6732	
850	33.4646	33.4607	33.4602	33.4624		33.4589	33.4624		33.4585	33.4607		33.4571	33.4607	
870	34.2520	34.2481	34.2476	34.2498	17 L	34.2463	34.2498	17 L	34.2459	34.2481	0 T	34.2445	34.2481	0 T
920	36.2205	36.2166	36.2161	36.2183	44 T	36.2148	36.2183	57 T	36.2144	36.2166	61 T	36.2130	36.2166	75 T
950	37.4016	37.3977	37.3972	37.3994		37.3959	37.3994		37.3955	37.3977		37.3941	37.3977	
980	38.5827	38.5788	38.5783	38.5805		38.5770	38.5805		38.5766	38.5788		38.5752	38.5788	
1000	39.3701	39.3662	39.3657	39.3679		39.3644	39.3679		39.3640	39.3662		39.3626	39.3662	
1150	45.2756	45.2707	45.2704	45.2730	23 L	45.2689	45.2730	23 L	45.2683	45.2709	2 L	45.2667	45.2709	2 L
1250	49.2126	49.2077	49.2074	49.2100	52 T	49.2059	49.2100	67 T	49.2053	49.2079	73 T	49.2037	49.2079	89 T
1400	55.1181	55.1118	55.1120	55.1150	32 L	55.1101	55.1150	32 L	55.1095	55.1126	8 L	55.1077	55.1126	8 L
1600	62.9921	62.9858	62.9860	62.9890	61 T	62.9841	62.9890	80 T	62.9835	62.9866	86 T	62.9817	62.9866	104 T
1800	70.8661	70.8582	70.8589	70.8625	43 L	70.8566	70.8625	43 L	70.8558	70.8594	12 L	70.8535	70.8594	12 L
2000	78.7402	78.7323	78.7330	78.7366	72 T	78.7307	78.7366	95 T	78.7299	78.7335	103 T	78.7276	78.7335	126 T
2300	90.5512	90.5414	90.5425	90.5469	55 L	90.5400	90.5469	55 L	90.5392	90.5435	21 L	90.5366	90.5435	21 L
2500	98.4252	98.4154	98.4165	98.4209	87 T	98.4140	98.4209	112 T	98.4132	98.4175	120 T	98.4106	98.4175	146 T

Note: To convert inches to mm, multiply inches by 25.4

<sup>1)</sup> L indicates "LOOSE" fit, T indicates "TIGHT" fit

Table 10

## Limits for ISO tolerance grades for dimensions

Nominal dimension		Tolerance grades													
over	incl.	IT0	IT1	IT2	IT3	IT4	IT5	IT6	IT7	IT8	IT9	IT10	IT11	IT12	
mm		$\mu\text{m}$ (0.001 mm)*													
1	3	0.5	0.8	1.2	2	3	4	6	10	14	25	40	60	100	
3	6	0.6	1	1.5	2.5	4	5	8	12	18	30	48	75	120	
6	10	0.6	1	1.5	2.5	4	6	9	15	22	36	58	90	150	
10	18	0.8	1.2	2	3	5	8	11	18	27	43	70	110	180	
18	30	1	1.5	2.5	4	6	9	13	21	33	52	84	130	210	
30	50	1	1.5	2.5	4	7	11	16	25	39	62	100	160	250	
50	80	1.2	2	3	5	8	13	19	30	46	74	120	190	300	
80	120	1.5	2.5	4	6	10	15	22	35	54	87	140	220	350	
120	180	2	3.5	5	8	12	18	25	40	63	100	160	250	400	
180	250	3	4.5	7	10	14	20	29	46	72	115	185	290	460	
250	315	4	6	8	12	16	23	32	52	81	130	210	320	520	
315	400	5	7	9	13	18	25	36	57	89	140	230	360	570	
400	500	6	8	10	15	20	27	40	63	97	155	250	400	630	
500	630	—	—	—	—	—	28	44	70	110	175	280	440	700	
630	800	—	—	—	—	—	32	50	80	125	200	320	500	800	
800	1000	—	—	—	—	—	36	56	90	140	230	360	560	900	
1000	1250	—	—	—	—	—	42	66	105	165	260	420	660	1,050	
1250	1600	—	—	—	—	—	50	78	125	195	310	500	780	1,250	
1600	2000	—	—	—	—	—	60	92	150	230	370	600	920	1,500	
2000	2500	—	—	—	—	—	70	110	175	280	440	700	1,100	1,750	

\*For values in inches, divide by 25.4

Table 11

## Shaft tolerances for bearings mounted on metric sleeves

Shaft Diameter d		Diameter and form tolerances						
Nominal over	incl.	h9 Deviations		IT5/2		h10 Deviations		IT7/2
		high	low	max	high	low	max	
mm		$\mu\text{m}$						
10	18	0	-43	4	0	-70	9	
18	30	0	-52	4.5	0	-84	10.5	
30	50	0	-62	5.5	0	-100	12.5	
50	80	0	-74	6.5	0	-120	15	
80	120	0	-87	7.5	0	-140	17.5	
120	180	0	-100	9	0	-160	20	
180	250	0	-115	10	0	-185	23	
250	315	0	-130	11.5	0	-210	26	
315	400	0	-140	12.5	0	-230	28.5	
400	500	0	-155	13.5	0	-250	31.5	
500	630	0	-175	14	0	-280	35	
630	800	0	-200	16	0	-320	40	
800	1 000	0	-230	18	0	-360	45	
1 000	1 250	0	-260	21	0	-420	52.2	

Table 12

## Guideline values for surface roughness of bearing seatings

Diameter of seating d (D)		Recommended $R_a$ value for ground seatings		
over	incl.	Diameter tolerance to		
		IT7	IT6	IT5
mm		$\mu\text{m}$ (.001mm) ( $\mu\text{in}$ ) (.000001 in)		
—	80	1.6 (63)	0.8 (32)	0.4 (16)
80	500	1.6 (63)	1.6 (63)	0.8 (32)
500	1250	3.2 (126)	1.6 (63)	1.6 (63)

Accuracy of form and position for bearing seatings on shafts and in housings

Surface characteristic	Symbol for characteristic	Tolerance zone	Permissible deviations Bearings of tolerance class <sup>1)</sup>			
			Normal, CLN	P6	P5	
<b>Cylindrical seating</b>						
Cylindricity		$t_1$	$\frac{IT5}{2}$	$\frac{IT4}{2}$	$\frac{IT3}{2}$	$\frac{IT2}{2}$
(or total radial runout)		$(t_3)$				
<b>Flat abutment</b>						
Rectangularity		$t_2$	IT5	IT4	IT3	IT2
(or total axial runout)		$(t_4)$				

1) For bearings of higher accuracy (tolerance class P4 etc.) please contact SKF Application Engineering.

Explanation

For normal demands  
 For special demands in respect of running accuracy or even support

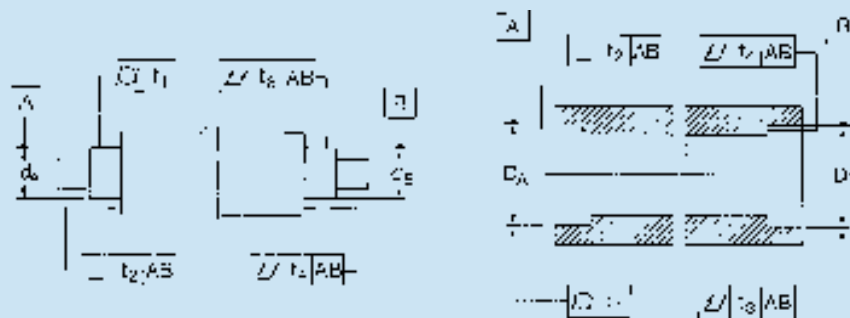

Table 14

**Shaft tolerances for standard inch size tapered roller bearings<sup>1 2)</sup>**  
 sizes and values in inches (classes 4 and 2)

Cone bore (Inner ring)		Shaft seat deviation from minimum cone bore and the resultant fit										
d			Rotating cone						Stationary cone			
			moderate loads <sup>3)</sup> no shock		heavy loads <sup>4)</sup> or high speed or shock		heavy loads <sup>4)</sup> or high speed or shock		moderate loads <sup>3)</sup> no shock		wheel spindles	
over incl.	tolerance	shaft seat deviation	resultant fit	shaft seat deviation	resultant fit	shaft seat deviation	resultant fit	shaft seat deviation	resultant fit	shaft seat deviation	resultant fit	
0 3	+0.0005 0	+0.0015 +0.0010	0.0005T 0.0015T	+0.0025 +0.0015	0.0010T 0.0025T	+0.0025 +0.0015	0.0010T 0.0025T	0 -0.0005	0.0010 L 0	-0.0002 -0.0007	0.0012 L 0.0002 L	
3 12	+0.0010 0	+0.0025 +0.0015	0.0005T 0.0025T	0.0005"/Inch Bearing Bore Avg. Tight Fit		0.0005"/Inch Bearing Bore Avg. Tight Fit		0 0.0010	0.0020 L 0	-0.0002 -0.0012	0.0022 L 0.0002 L	
12 24	+0.0020 0	+0.0050 +0.0030	0.0010T 0.0050T					0 -0.0020	0.0040 L 0	—	—	
24 36	+0.0030 0	+0.0075 +0.0045	0.0015T 0.0075T	+0.0150 +0.0120	0.0090T 0.0150T	+0.0150 +0.0120	0.0090T 0.0150T	0 -0.0030	0.0060 L 0	—	—	

1) For fitting practice for metric and J-prefix part number tapered roller bearings, see **Table 15**.

2) These recommendations not applicable to tapered bore cones. For recommendations, consult your SKF representative.

3)  $\frac{C}{P} \geq 8.3$

4)  $\frac{C}{P} < 8.3$

C is the basic load rating, P is the equivalent load. T indicates tight fit, L indicates loose fit.  $\geq$  equal or greater than. < less than.

Table 15

**Housing tolerance for standard inch size tapered roller bearings<sup>1)</sup>**  
 sizes and values in inches

Cup O.D. (Outer ring)		Housing seat deviation from minimum cup O.D. and the resultant fit										
D			Stationary cup						Rotating cup			
			floating or clamped		adjustable		non-adjustable or in carriers		non-adjustable or in carriers, sheaves-clamped		sheaves-unclamped	
over incl.	tolerance	housing seat deviation	resultant fit	housing seat deviation	resultant fit	housing seat deviation	resultant fit	housing seat deviation	resultant fit	housing seat deviation	resultant fit	
0 3	+0.0010 0	+0.0035 +0.0020	0.0030L 0.0010L	+0.0010 0	0.0010L 0.0010T	-0.0005 -0.0015	0.0005T 0.0025T	-0.0005 -0.0015	0.0005T 0.0015T	-0.0020 -0.0030	0.0020T 0.0040T	
3 5	+0.0010 0	+0.0030 +0.0020	0.0030L 0.0010L	+0.0010 0	0.0010L 0.0010T	-0.0010 -0.0020	0.0010T 0.0030T	-0.0010 -0.0020	0.0010T 0.0030T	-0.0020 -0.0030	0.0020T 0.0040T	
5 12	+0.0010 0	+0.0030 +0.0020	0.0030L 0.0010L	+0.0020 0	0.0020L 0.0010T	-0.0010 -0.0020	0.0010T 0.0030T	-0.0010 -0.0020	0.0010T 0.0030T	-0.0020 -0.0030	0.0020T 0.0040T	
12 24	+0.0020 0	+0.0060 +0.0040	0.0060L 0.0020L	+0.0020 +0.0010	0.0030L 0.0010T	-0.0010 -0.0030	0.0010T 0.0050T	-0.0010 -0.0030	0.0010T 0.0050T	-0.0020 -0.0040	0.0020T 0.0060T	
24 36	+0.0030 0	+0.0090 +0.0060	0.0090L 0.0030L	+0.0050 +0.0020	0.0050L 0.0010T	-0.0010 -0.0040	0.0010T 0.0070T	-0.0010 -0.0040	0.0010T 0.0070T	—	—	

Recommended fits above are for cast iron or steel housing. For housings of light metal, tolerances are generally selected which give a slightly tighter fit than those in the table.

1) For fitting practice for metric and J-prefix part number tapered roller bearings, see **Table 16**. T indicates tight fit, L indicates loose fit.

Shaft tolerances for metric and J-prefix inch series tapered roller bearings<sup>1)</sup>  
ISO class normal and ABMA class K and N  
values in inches

Cone bore (Inner ring)			Shaft seat deviation from maximum cone bore and the resultant fit											
d			Rotating cone						Stationary cone					
			constant loads <sup>2)</sup> with moderate shock			heavy loads <sup>3)</sup> or high speed or shock			tension pulley rope sheaves moderate loads <sup>2)</sup> no shock			wheel spindles moderate loads <sup>2)</sup> no shock		
over in mm	incl. in mm	tolerance (in)	shaft seat deviation	resultant fit	tolerance symbol	shaft seat deviation	resultant fit	tolerance symbol	shaft seat deviation	resultant fit	tolerance symbol	shaft seat deviation	resultant fit	tolerance symbol
0.3937 10	0.7087 18	0 -0.0005	+0.0004 +0.0001	0.0001T 0.0009T	k5	+0.0009 +0.0005	0.0005T 0.0014T	n6	0 -0.0004	0.0004 L 0.0005T	h6	-0.00025 -0.00065	0.00065 L 0.00025T	g6
0.7087 18	1.1811 30	0 -0.0005	+0.0005 +0.0001	0.0001T 0.0010T	k5	+0.0011 +0.0006	0.0006T 0.0016T	n6	0 -0.0005	0.0005 L 0.0005T	h6	-0.0003 -0.0008	0.0008 L 0.0002T	g6
1.1811 30	1.9685 50	0 -0.0005	+0.0008 +0.0004	0.0004T 0.0013T	m5	+0.0013 +0.0007	0.0007T 0.0018T	n6	0 -0.0006	0.0006 L 0.0005T	h6	-0.0004 -0.0010	0.0010 L 0.0001T	g6
1.9685 50	3.1496 80	0 -0.0006	+0.0010 +0.0005	0.0005T 0.0016T	m5	+0.0015 +0.0008	0.0008T 0.0021T	n6	0 -0.0007	0.0007 L 0.0006T	h6	-0.0004 -0.0011	0.0011 L 0.0002T	g6
3.1496 80	4.7244 120	0 -0.0008	+0.0014 +0.0005	0.0005T 0.0022T	m6	+0.0019 +0.0010	0.0010T 0.0027T	n6	0 -0.0009	0.0009 L 0.0008T	h6	-0.0005 -0.0014	0.0014 L 0.0003T	g6
4.7244 120	7.0866 180	0 -0.0010	+0.0022 +0.0012	0.0012T 0.0032T	n6	+0.0034 +0.0018	0.0018T 0.0044T	p6	0 -0.0010	0.0010 L 0.0010T	h6	-0.0006 -0.0016	0.0016 L 0.0004T	g6
7.0866 180	9.8425 250	0 -0.0012	+0.0026 +0.0014	0.0014T 0.0038T	n6	+0.0042 +0.0030	0.0030T 0.0054T	r6	0 -0.0012	0.0012 L 0.0012T	h6	-0.0006 -0.0018	0.0018 L 0.0006T	g6
9.8425 250	12.4016 315	0 -0.0014	+0.0034 +0.0022	0.0022T 0.0048T	p6	+0.0047 +0.0035	0.0035T 0.0061T	r6	0 -0.0012	0.0012 L 0.0014T	h6	-0.0007 -0.0019	0.0019 L 0.0007T	g6
12.4016 315	15.7480 400	0 -0.0016	+0.0039 +0.0025	0.0025T 0.0055T	p6	+0.0059 +0.0045	0.0045T 0.0065T	r6	0 -0.0014	0.0014 L 0.0016T	h6	-0.0007 -0.0029	0.0029 L 0.0009T	g7
15.7480 400	19.6850 500	0 -0.0018	+0.0044 +0.0028	0.0028T 0.0062T	p6	+0.0066 +0.0050	0.0050T 0.0084T	r6	0 -0.0016	0.0016 L 0.0018T	h6	-0.0008 -0.0033	0.0033 L 0.0010T	g7

Recommended fits above are for ground shaft seats.

Note: Assembly conditions may dictate tighter fits than recommended above. Consult your SKF representative where application conditions call for fitting practices not covered by these recommendations.

1) These recommendations not applicable to tapered bore cones. For recommendations, consult your SKF representative.

2)  $\frac{C}{P} \geq 8.3$

3)  $\frac{C}{P} < 8.3$

C is the basic load rating, P is the equivalent load. T indicates tight fit, L indicates loose fit. ≥ equal or greater than. < less than.

Table 17

Housing tolerances for metric and J-prefix inch series tapered roller bearing  
ISO class normal and ABMA class K and N  
values in inches

Cup O.D. (Outer ring)			Housing seat deviation from maximum cup O.D. and the resultant fit											
D			Stationary cup						Rotating cup					
			floating or clamped			adjustable			non-adjustable or in carriers			sheaves- unclamped		
over in mm	incl. in mm	toler- ance (in)	housing seat deviation	resultant fit	toler- ance symbol	housing seat deviation	resultant fit	toler- ance symbol	housing seat deviation	resultant fit	toler- ance symbol	housing seat deviation	resultant fit	toler- ance symbol
0.7087 18	1.1811 30	0 -0.0005	+ 0.0008 0	0.0013 L 0	H7	+ 0.0005 -0.0003	0.0010 L 0.0003T	J7	-0.0005 -0.0013	0 0.0013T	P7	-0.0009 -0.0017	0.0004T 0.0017T	R7
1.1811 30	1.9685 50	0 -0.0006	+ 0.0010 0	0.0016 L 0	H7	+ 0.0006 -0.0004	0.0012 L 0.0004T	J7	-0.0006 -0.0016	0 0.0016T	P7	-0.0010 -0.0020	0.0004T 0.0020T	R7
1.9685 50	3.1496 80	0 -0.0006	+ 0.0012 0	0.0018 L 0	H7	+ 0.0008 -0.0004	0.0014 L 0.0004T	J7	-0.0009 -0.0021	0.0003T 0.0021T	P7	-0.0011 -0.0023	0.0005T 0.0023T	R7
3.1496 80	4.7244 120	0 -0.0007	+ 0.0014 0	0.0021 L 0	H7	+ 0.0009 -0.0005	0.0016 L 0.0005T	J7	-0.0011 -0.0025	0.0004T 0.0025T	P7	-0.0015 -0.0029	0.0008T 0.0029T	R7
4.7244 120	5.9055 150	0 -0.0008	+ 0.0016 0	0.0024 L 0	H7	+ 0.0010 -0.0006	0.0018 L 0.0006T	J7	-0.0012 -0.0028	0.0004T 0.0028T	P7	-0.0019 -0.0035	0.0011T 0.0035T	R7
5.9055 150	7.0866 180	0 -0.0010	+ 0.0016 0	0.0026 L 0	H7	+ 0.0010 -0.0006	0.0020 L 0.0006T	J7	-0.0012 -0.0028	0.0002T 0.0028T	P7	-0.0019 -0.0035	0.0009T 0.0035T	R7
7.0866 180	9.8424 250	0 -0.0012	+ 0.0018 0	0.0030 L 0	H7	+ 0.0011 -0.0007	0.0023 L 0.0007T	J7	-0.0014 -0.0032	0.0002T 0.0032T	P7	-0.0024 -0.0042	0.0012T 0.0042T	R7
9.8425 250	12.4016 315	0 -0.0014	+ 0.0027 + 0.0007	0.0041 L 0.0007 L	G7	+ 0.0013 -0.0007	0.0027 L 0.0007T	J7	-0.0014 -0.0034	0 0.0034T	P7	-0.0027 -0.0047	0.0013T 0.0047T	R7
12.4016 315	15.7480 400	0 -0.0016	+ 0.0029 + 0.0007	0.0045 L 0.0007 L	G7	+ 0.0015 -0.0007	0.0031 L 0.0007T	J7	-0.0017 -0.0039	0.0001T 0.0039T	P7	-0.0037 -0.0059	0.0021T 0.0059T	R7
15.7480 400	19.6850 500	0 -0.0018	+ 0.0033 + 0.0008	0.0051 L 0.0008 L	G7	+ 0.0016 -0.0009	0.0034 L 0.0009T	J7	-0.0019 -0.0044	0.0001T 0.0044T	P7	-0.0041 -0.0066	0.0023T 0.0066T	R7

Recommendations above are for cast iron or steel housing. For housings of light metal, tolerances are generally selected which give a slightly tighter fit than those in the table.  
T indicates tight fit. L indicates loose fit.

**Bearing shaft – seat diameters<sup>1)</sup>**  
Precision (ABEC 5) deep groove ball bearings

mm	Bearing bore diameter		Shaft/seat diameter		Fit <sup>2)</sup> in .0001"
	inches maximum	inches minimum	inches maximum	inches minimum	
10	.3937	.3935	.3937	.3935	2 L, 2T
12	.4724	.4722	.4724	.4722	2 L, 2T
15	.5906	.5904	.5906	.5904	2 L, 2T
17	.6693	.6691	.6693	.6691	2 L, 2T
20	.7874	.7872	.7875	.7873	1 L, 3T
25	.9843	.9841	.9844	.9842	1 L, 3T
30	1.1811	1.1809	1.1812	1.1810	1 L, 3T
35	1.3780	1.3777	1.3782	1.3779	1 L, 5T
40	1.5748	1.5745	1.5750	1.5747	1 L, 5T
45	1.7717	1.7714	1.7719	1.7716	1 L, 5T
50	1.9685	1.9682	1.9687	1.9684	1 L, 5T
55	2.1654	2.1650	2.1656	2.1652	2 L, 6T
60	2.3622	2.3618	2.3624	2.3620	2 L, 6T
65	2.5591	2.5587	2.5593	2.5589	2 L, 6T
70	2.7559	2.7555	2.7561	2.7557	2 L, 6T
75	2.9528	2.9524	2.9530	2.9526	2 L, 6T
80	3.1496	3.1492	3.1498	3.1494	2 L, 6T
85	3.3465	3.3461	3.3467	3.3463	2 L, 6T
90	3.5433	3.5429	3.5435	3.5431	2 L, 6T
95	3.7402	3.7398	3.7404	3.7400	2 L, 6T
100	3.9370	3.9366	3.9372	3.9368	2 L, 6T
105	4.1339	4.1335	4.1341	4.1337	2 L, 6T
110	4.3307	4.3303	4.3309	4.3305	2 L, 6T
120	4.7244	4.7240	4.7246	4.7242	2 L, 6T

1) Use this table for ABEC 5 bearings; for higher precision bearings, other recommendations apply. contact SKF Application Engineering.

2) L indicates "LOOSE" fit. T indicates "TIGHT" fit

\*Note — These shaft dimensions are to be used when C/P > = 14.3 and the inner ring rotates in relation to the direction of the radial load. For heavier loads contact SKF Application Engineering.

Table 19

**Bearing housing – seat diameters<sup>1)</sup>**  
 Precision (ABEC 5) deep groove ball bearings

mm	Bearing outside diameter		Housing/seat diameter		Fit <sup>2)</sup> in .0001"
	inches maximum	minimum	inches minimum	maximum	
30	1.1811	1.1809	1.1810	1.1813	4 L, 1T
32	1.2598	1.2595	1.2597	1.2600	5 L, 1T
35	1.3780	1.3777	1.3779	1.3782	5 L, 1T
37	1.4567	1.4564	1.4566	1.4569	5 L, 1T
40	1.5748	1.5745	1.5747	1.5750	5 L, 1T
42	1.6535	1.6532	1.6534	1.6537	5 L, 1T
47	1.8504	1.8501	1.8503	1.8506	5 L, 1T
52	2.0472	2.0468	2.0471	2.0474	6 L, 1T
62	2.4409	2.4405	2.4408	2.4411	6 L, 1T
72	2.8346	2.8342	2.8345	2.8348	6 L, 1T
80	3.1496	3.1492	3.1495	3.1498	6 L, 1T
85	3.3465	3.3461	3.3464	3.3468	7 L, 1T
90	3.5433	3.5429	3.5432	3.5436	7 L, 1T
100	3.9370	3.9366	3.9369	3.9373	7 L, 1T
110	4.3307	4.3303	4.3306	4.3310	7 L, 1T
120	4.7244	4.7240	4.7243	4.7247	7 L, 1T
125	4.9213	4.9209	4.9211	4.9216	7 L, 2T
130	5.1181	5.1177	5.1179	5.1184	7 L, 2T
140	5.5118	5.5114	5.5116	5.5121	7 L, 2T
150	5.9055	5.9051	5.9053	5.9058	7 L, 2T
160	6.2992	6.2987	6.2990	6.2995	8 L, 2T
170	6.6929	6.6924	6.6927	6.6932	8 L, 2T
180	7.0866	7.0861	7.0864	7.0869	8 L, 2T
190	7.4803	7.4797	7.4801	7.4807	10 L, 2T
200	7.8740	7.8734	7.8738	7.8744	10 L, 2T

1) Use this table for ABEC 5 bearings; for higher precision bearings, other recommendations apply, contact SKF Application Engineering.

2) L indicates "LOOSE" fit. T indicates "TIGHT" fit

\*Note — These housing dimensions are to be used when the outer ring is stationary in relation to the direction of the radial load.

For applications with rotating outer ring loads contact SKF Application Engineering.



# Lubrication

## Functions of a lubricant

If rolling bearings are to operate reliably they must be adequately lubricated to prevent metal-to-metal contact between the rolling elements, raceways and cages. Separation of the surfaces in the bearing is the primary function of the lubricant, which must also inhibit wear and protect the bearing surfaces against corrosion. In some applications the lubricant is also used to carry away heat. The choice of a suitable lubricant and method of lubrication for each individual bearing application is therefore important, as is correct maintenance.

Lubricants for rolling bearings serve the following functions:

- Separate the rolling contact surfaces in the bearing;
- Separate the sliding contact surfaces in the bearing;
- Protect highly finished bearing surfaces from corrosion;
- Provide sealing against contaminants (in the case of grease);
- Provide a heat transfer medium (in the case of oil).

A wide selection of oils and greases are available for the lubrication of rolling bearings. There are also various types of solid lubricants available on the market for extreme temperature conditions. The actual choice of a lubricant depends primarily on the operating conditions, i.e. the temperature range, speeds, and the influence of the surroundings.

Rolling bearings will generate the least amount of heat when the minimum amount of lubricant needed for reliable bearing lubrication is provided. However, it is generally impractical to use such small amounts of lubricant since the lubricant is also performing other functions such as sealing and heat removal. The lubricant in a bearing arrangement gradually loses its lubricating properties as a result of mechanical working, aging and the build-up of contamination. It is therefore necessary for oil to be filtered and changed at regular intervals and grease to be replenished or renewed. Details regarding relubrication intervals and quantities appear elsewhere in this section.

### SKF on-line programs for lubrication

Viscosity calculations can be made with the “SKF Interactive Engineering” Catalog accessed through [www.skf.com](http://www.skf.com). Select the “Calculations” icon and select “Viscosity.”

Relubrication intervals can be calculated in the same manner as above: SKF Interactive Engineering Catalog accessed through [www.skf.com](http://www.skf.com). Select the “Calculations” icon and select “Relubrication intervals.”

Grease selection can be made by using SKF LubeSelect, available on-line through the @ptitudeXchange subscription service.

SKF greases can be found on-line at [www.skf.com](http://www.skf.com) under “SKF Maintenance and Lubrication Products”. The program SKF LubeSelect, available through the @ptitudeXchange subscription service, can also be used to select greases for specific applications or sets of application conditions.

## Selection of oil

Oil is generally used for rolling bearing lubrication when high speeds, high temperatures, or lubricant life preclude the use of grease. It is also used when heat has to be removed from the bearing position, or when adjacent components (gears etc.) are lubricated with oil.

The most important property of lubricating oil is its viscosity. Viscosity is a measure of a fluid's resistance to flow. A high viscosity oil will flow less readily than a thinner, low viscosity oil. The viscosity of a lubricant is directly related to the amount of film thickness it can generate, and film thickness is the most critical component to separate the rolling and sliding surfaces within a bearing. This separation is critical to reduce friction and heat, and to minimize wear. The units of measurement for oil viscosity are Saybolt Universal Seconds (SUS) and centistokes ( $\text{mm}^2/\text{s}$ , cSt). The viscosity-temperature relationship of oil is characterized by the viscosity index VI. For rolling bearing lubrication, oils having a high viscosity index (little change with temperature) of at least 95 are recommended.

Mineral oils are generally favored for rolling bearing lubrication. Rust and oxidation inhibitors are typical additives. Synthetic oils are generally considered for bearing lubrication in extreme cases, e.g. at very low or very high operating temperatures. The term synthetic oil covers a wide range of different base stocks. The main ones are polyalphaolefins (PAO), esters and polyalkylene glycols (PAG). These synthetic oils have different properties than mineral oils. Accurate information should always be sought from the individual lubricant supplier.

In order for a sufficiently thick oil film to be formed in the contact area between rolling elements and raceways, the oil must have a specific kinematic viscosity,  $v_1$ , at the bearing operating temperature. That minimum viscosity can be determined from **Figure 1**, provided a mineral oil is used and the bearing size and speed are known.

Bearing size is expressed along the horizontal axis as the mean diameter ( $d_m$ ) in

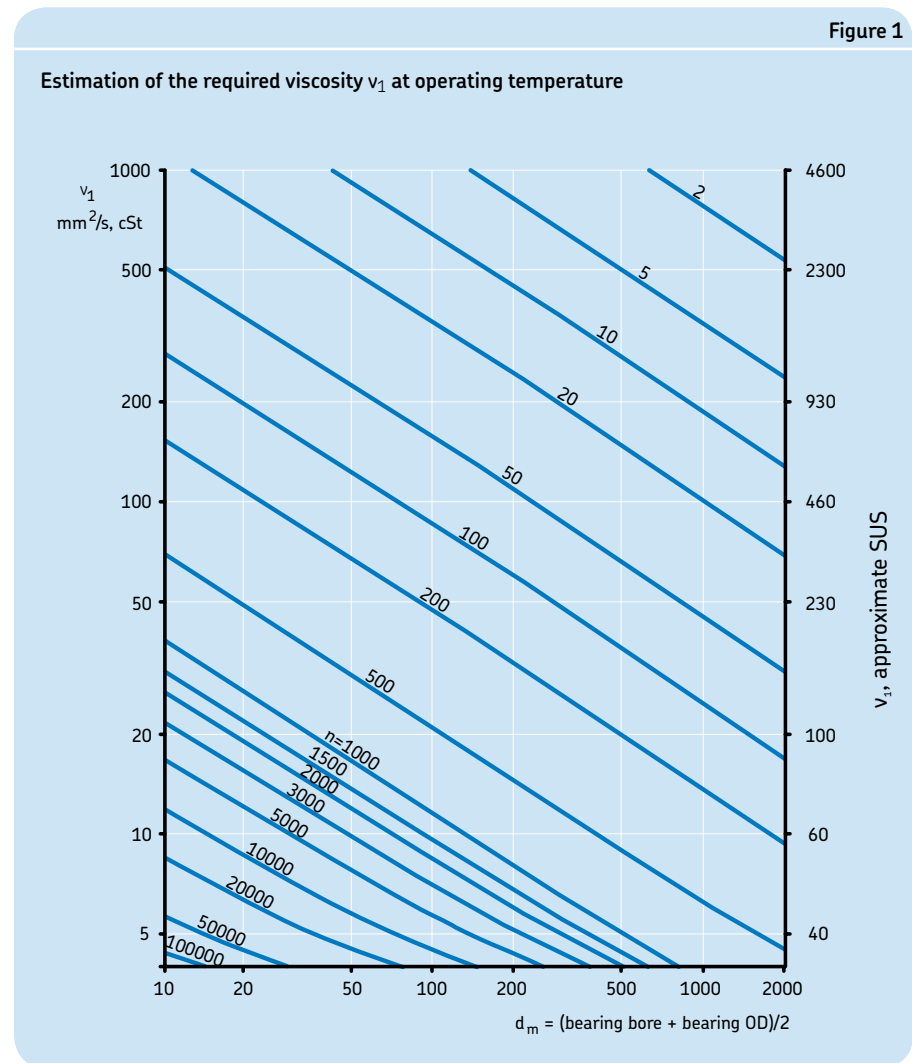

millimeters, where  $d_m = (\text{bearing bore} + \text{bearing OD})/2$ . Speed, in rpm, is given on the diagonal lines. To determine the minimum required viscosity at the bearing operating temperature, find the point where the mean diameter and speed lines intersect – then read across horizontally to the vertical axis on the left to determine the minimum required viscosity in centistokes, or to the right to determine the minimum required viscosity on Saybolt Universal Seconds.

The effectiveness of a particular lubricant is determined by the viscosity ratio, or Kappa value,  $\kappa$ .  $\kappa$  is the ratio of the actual operating viscosity,  $v$ , to the required kinematic viscos-

ity,  $v_1$  found from **Figure 1**. If  $\kappa \geq 1$  the rolling contact surfaces in the bearing are fully separated by a film of oil. Both  $v$  and  $v_1$  are to be considered at the bearing operating temperature.

$$\kappa = v / v_1$$

where

$\kappa$  = viscosity ratio

$v$  = actual operating viscosity of the lubricant ( $\text{mm}^2/\text{s}$ , cSt)

$v_1$  = minimum required viscosity depending on bearing size and speed ( $\text{mm}^2/\text{s}$ , cSt)

Bearing life may be extended by selecting an oil that provides a  $\kappa \geq 1$ , or when  $v > v_1$ . This can be obtained by choosing a mineral oil with a higher ISO VG or by using an

Figure 2

Estimation of viscosity,  $\nu$  at operating temperature assumes VI=95 and a mineral oil

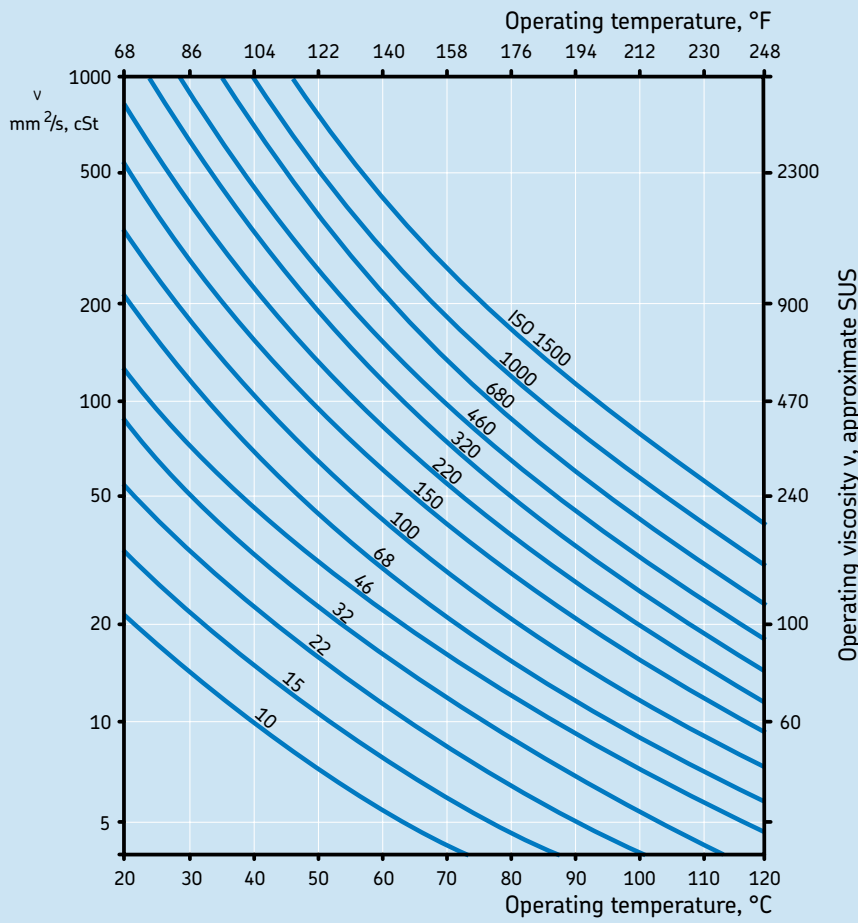

oil with a higher viscosity index VI. However, since increasing viscosity can raise the bearing operating temperature, there is a practical limit to the lubrication improvement that can be obtained by this means.

When  $\kappa < 1$ , an oil containing EP/AW additives is recommended. It should also be noted that some EP additives may cause adverse effects, see section "Load carrying ability, EP and AW additives" page 94. For exceptionally low or high speeds, for critical loading conditions, or for unusual lubricating conditions, please consult SKF Application Engineering.

For cases where bearing size or operating speed are unknown or cannot be determined, several "rules of thumb" have traditionally been applied. For ball bearings and

cylindrical roller bearings, a minimum of 70 SUS (13 centistokes) viscosity at the bearing operating temperature is required. For spherical roller bearings, toroidal roller bearings, and taper roller bearings, a minimum of 100 SUS (21 centistokes) viscosity at the bearing operating temperature is required. For spherical roller thrust bearings, a minimum of 150 SUS (32 centistokes) viscosity at the bearing operating temperature is required. These "rules of thumb" values are typically not appropriate for relatively slow or high rotational speeds. Many operating considerations are involved in the proper viscosity selection. Therefore, the "rules of thumb" should be used sparingly and only in the absence of sufficient information for a proper selection.

The viscosity obtained from **Figure 1** or from the "rules of thumb" is the viscosity required at the **bearing operating temperature**. Since viscosity is temperature dependent, it is necessary to reference temperature when referring to viscosity.

Manufacturers of oil and grease typically publish the viscosity of the oil, or base oil, at reference temperatures 40° C (104° F) and 100° C (212° F). With this information it is possible to calculate that specific oil's viscosity at all other temperatures. ISO also has an established standard for referring to the viscosity of oil: the ISO Viscosity Grade (VG) is simply the oil viscosity at 40° C (104° F). As an example, an ISO VG 68 oil or grease has a viscosity of approximately 68 cSt at 40° C.

**Figure 2** can be used to select the appropriate ISO Viscosity Grade (VG) for an application. It shows the relationship between viscosity and temperature for common industrial mineral oils or base oils in greases. To determine the appropriate ISO VG for an application, find the point where the previously determined minimum required viscosity intersects the expected bearing operating temperature. The first diagonal line to the right of this point is the minimum ISO VG that should be used in the application.

**Note that the viscosity lines on Figure 2 represent oils and base oils with a Viscosity Index of 95 (VI 95).** Some lubricants have viscosity indexes other than the VI 95. In these cases, plot the two reference points on the chart and connect with a straight line to determine their profile.

For all calculations, the viscosity should be expressed in mm<sup>2</sup>/s (cSt). See **Figure 3** for conversion to other viscosity units and grades.

Viscosity equivalents

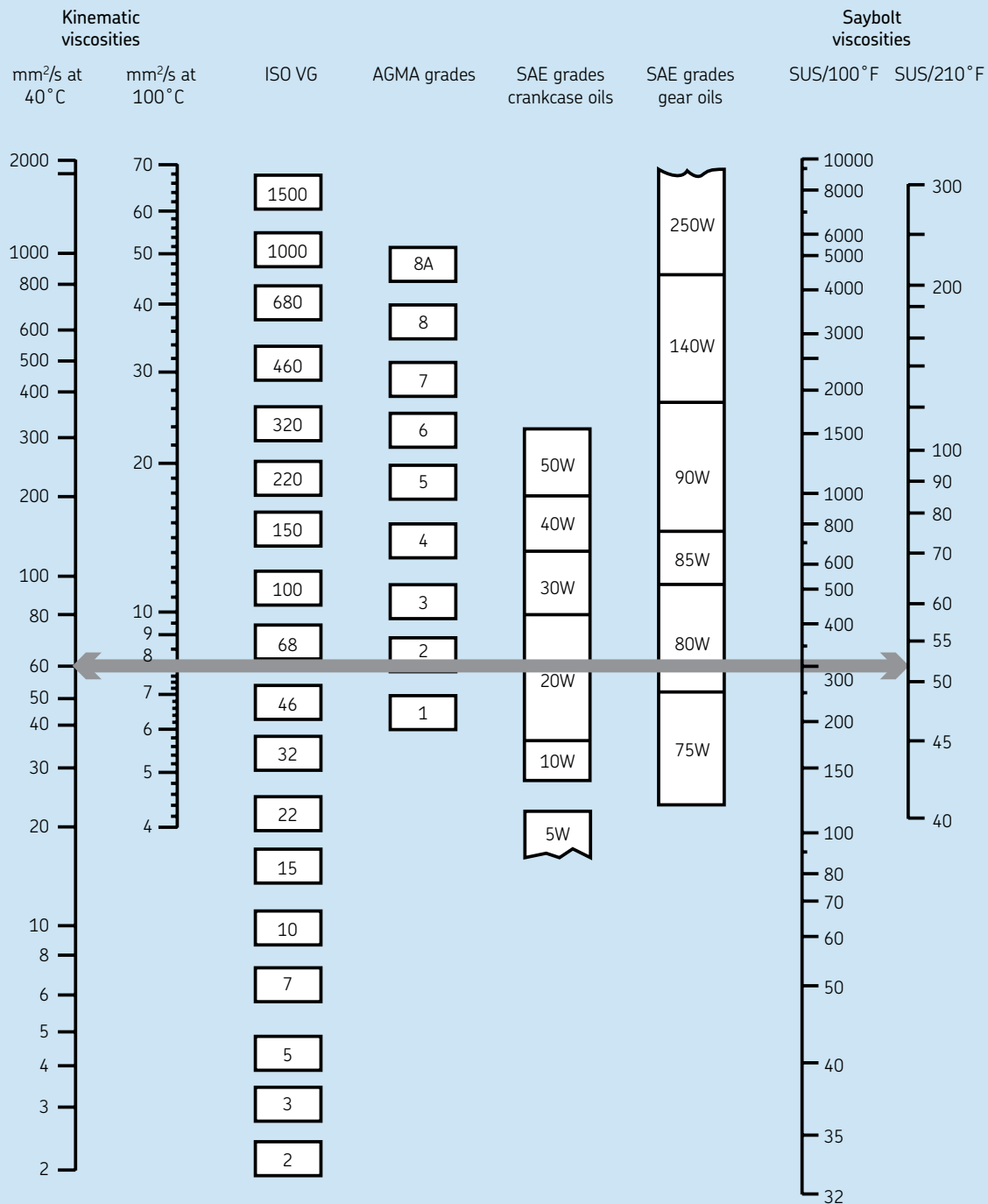

Viscosities based on 95 VI single-grade oils.  
 ISO grades are specified at 40° C.  
 AGMA grades are specified at 100° F.  
 SAE 75W, 80W, 85W, and 5 and 10W specified at low temperature (below -17° F = 0° C).  
 Equivalent viscosities for 100° F and 210° F are shown.  
 SAE 90 to 250 and 20 to 50 specified at 210° F (100° C).

Comparison of various viscosity classification methods

## Methods of oil lubrication

Since oils are liquid, suitable enclosures must be provided to prevent leakage and they should receive careful consideration.

### Oil bath

A simple oil bath method, shown in **Figure 4**, is satisfactory for low and moderate speeds. The oil, which is picked up by the rotating components of the bearing, is distributed within the bearing and then flows back to the oil bath. The oil level at standstill must not be higher than the center of the lowest ball or roller. The static oil level must be checked only at standstill. A reliable sight-glass gauge should be provided to permit an easy check. It is common to have two levels marked on the sight glass, one for static and one for dynamic conditions. They should be clearly labeled to avoid confusion.

### Oil pick-up ring

For those bearing applications with higher speeds and operating temperatures, an oil pick-up ring lubrication method may be more appropriate than a simple static oil bath, shown in **Figure 5**. The pick-up ring serves to bring about oil circulation. The ring hangs loosely on a sleeve on the shaft at one side of the bearing and dips into the oil in the lower half of the housing. As the shaft rotates, the ring follows and transports oil from the bottom to a collecting trough. The oil then flows through the bearing back into the reservoir at the bottom. This method eliminates the bearing "plowing" through the static oil level in the sump and reduces the bearing operating temperature. This method of oil lubrication is only effective for horizontal applications because of the oil ring dynamics.

### Circulating systems

Operation at high speeds will cause the operating temperature to increase and will accelerate aging of the oil. To avoid frequent oil changes as well as achieve a  $\kappa$  ratio of 1, the circulating oil lubrication method is generally preferred, shown in **Figure 6**. Circulating oil simplifies maintenance, particularly on large machines, and prolongs the life of the oil where operating conditions are

usually severe, such as high ambient temperatures and steadily increasing power inputs and speeds. Oil is circulated to the bearing with the aid of a pump. The oil flows through the bearing, drains from the housing, returns to the reservoir where it is filtered and, if required, cooled before being returned to the bearing.

If the bearing is provided with a relubrication feature such as an oil groove and holes in the outer or inner ring, supplying the oil through the relubrication feature in the center of the bearing near the top of the housing is preferred. Draining the oil for the center feed method is best done by a two drain system, one on each side of the housing leading downward immediately outside the housing. Horizontal drains should be avoided to prevent back up of the oil in the housing. An alternate method is to have the inlet on one side, below the horizontal center, and drain from the opposite side of the bearing. The outlet should be larger than the inlet to prevent accumulation of oil in the bearing housing.

The amount of oil retained in the housing is controlled by the location of the outlet(s). For a "wet sump", the oil level at a standstill must not be higher than the center of the lowest ball or roller. A reliable sight-glass gauge should be provided to permit an easy check. Where there is extreme heat, the "dry sump" design is preferred, permitting the oil to drain out immediately after it has passed through the bearing. The outlets are then located at the lowest point on both sides of the housing. It has been found that with this arrangement the bearings remain cleaner since there is less chance of carbonized oil being retained in the housing. When the outlets, or drains, are located at the lowest point on both sides of the housing, an arrangement is necessary to indicate when oil flow is impaired or stopped. Electrically interlocking the oil pump motor with the motor driving the machine can provide this protection. Note that with many bearing types, the groove or sphere in the outer ring on horizontal mountings will always retain some oil. The bearing will therefore have some oil when it starts to rotate.

Figure 4

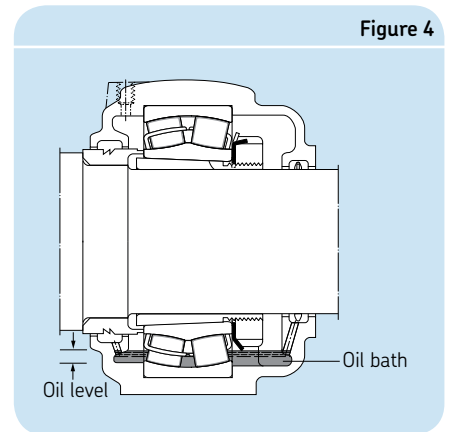

Figure 5

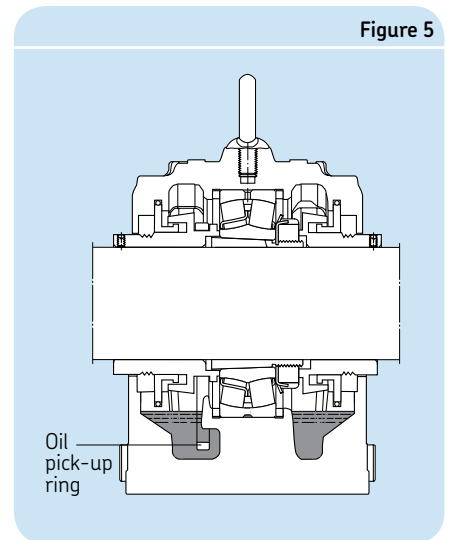

Figure 6

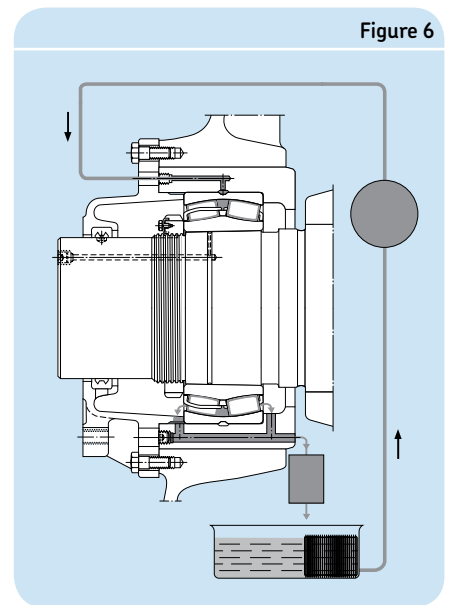
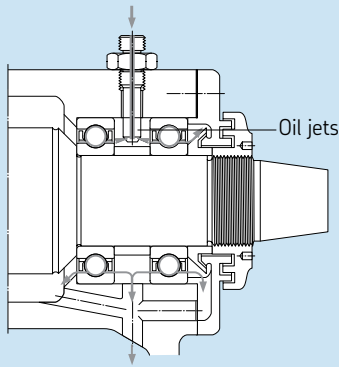

Figure 7



## Oil jet

For very high-speed operation, a sufficient but not excessive amount of oil must be supplied to the bearing to provide adequate lubrication without increasing the operating temperature more than necessary. One particularly efficient method of achieving this is the oil jet method shown in **Figure 7**, where a jet of oil under high pressure is directed at the side of the bearing. The velocity of the oil jet must be high enough (at least 15 m/s) to penetrate the turbulence surrounding the rotating bearing.

Figure 8

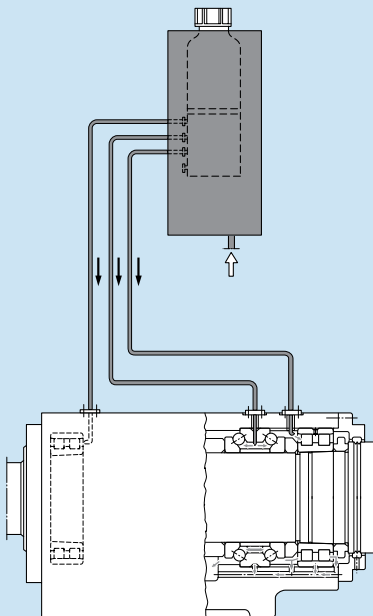

## Oil mist

This method consists of a mixture of air and atomized oil being supplied to the bearing housing under suitable pressure. It is important that the air be sufficiently clean and dry. Oil mist lubrication vents into the atmosphere, resulting in unpleasant surroundings and possible environmental effects. As a result, it should only be utilized in specific applications and, when used, certain precautions should be employed. New oil mist generators and special seal designs limit the amount of stray mist. In case synthetic non-toxic oil is used, the environmental effects are even further reduced. Oil mist lubrication today is used in unique applications.

## Air/oil lubrication

The air/oil method of lubrication, sometimes called the oil-spot method, uses compressed air to transport a very precise amount of lubricant directly to a bearing. This minimum quantity of oil enables bearings to operate at lower temperatures or at higher speeds than any other method of lubrication. Oil is metered into the airstream of the supply lines to the bearing housings at set time intervals, monitored by a programmable controller. The oil coats the inside of the supply lines and “spirals/creeps” in the direction of the airflow.

**Figure 8** shows a typical air/oil system configuration.

In contrast to oil mist methods, the air/oil method involves no atomization of the air and oil. Air/oil allows more effective use of higher viscosity base oils and air/oil uses less oil. Both the oil mist and air/oil methods build and maintain internal bearing pressures, which help repel contaminants.

## Oil relubrication intervals

The frequency at which the oil must be changed is mainly dependent on the operating conditions and on the quantity of oil used. Oil sample analysis will help establish an appropriate oil change schedule. Generally, the oil should be changed once a year, provided the operating temperature does not exceed 122° F (50° C) and there is little risk of contamination. Higher temperatures call for more frequent oil changes, e.g. for operating temperatures around 212° F (100° C), the oil should be changed every three months. Frequent oil changes are also needed if other operating conditions are more demanding.

With circulating oil lubrication, the period between oil changes is determined by how frequently the total oil quantity is circulated and whether or not the oil is cooled. It is generally only possible to determine a suitable interval by test runs and by regular inspection of the condition of the oil to see that it is not contaminated and is not excessively oxidized. The same applies for oil jet lubrication. With oil spot lubrication the oil only passes through the bearing once and is not re-circulated.

## Grease lubrication

Lubricating greases usually consist of a mineral or synthetic oil suspended in a thickener, with the oil typically making up 75% or more of the grease volume. Chemicals (additives) are added to grease to achieve or enhance certain performance properties. As a result of having a thickener package, grease is more easily retained in the bearing arrangement, particularly where shafts are inclined or vertical. Grease also helps to seal bearings against solid and moisture contamination.

Excessive amounts of grease, as well as oil, will cause the operating temperature in the bearing to rise rapidly, particularly when running at high speeds. As a general rule for grease lubricated bearings, only the bearing should be completely filled with grease prior to start-up and the free space in the housing should be partially filled. Before operating at full speed, the excess grease in the bearing must be allowed to settle or escape into the housing cavity during a running-in period. At the end of the running-in period, the operating temperature will drop considerably indicating that the grease has been distributed in the bearing arrangement.

Where bearings are to operate at very low speeds and good protection against contamination and corrosion is required, it is advisable to fill the housing completely with grease.

### Grease selection

When selecting a grease for bearing lubrication, the base oil viscosity, consistency, operating temperature range, oil bleed rate, rust inhibiting properties and the load carrying ability are the most important factors to be considered.

### Grease thickener

There are a wide variety of different thickeners available, each with specific benefits directed at application problems. The thickener composition is critical to grease performance, particularly with respect to temperature capability, water resistance, and bleed rates. The broadest classification of thickeners is divided into two classes: soaps and non-soaps. Soap, in grease terminology, refers to a fatty acid and a metal. Common metals include Aluminum, Lithium, Calcium, and Sodium. Non-soap thickeners include organic and inorganic. Organic thickeners include ureas, amides, and dyes. Inorganic thickeners include various clays such as bentonite. Since each specific thickener type has its own advantages and disadvantages, the lubricant manufacturer should be consulted when selecting a specific grease type based on the application conditions.

### Grease consistency

Greases are divided into various consistency classes according to the National Lubricating Grease Institute (NLGI) scale. Greases that soften at elevated temperatures may leak from the bearing arrangement. Those that stiffen at low temperatures may restrict rotation of the bearing or have insufficient oil bleeding.

Metallic soap thickened greases, with an NLGI consistency of 1, 2 or 3 are used for rolling bearings, with the most common being NLGI 2. Lower consistency greases are preferred for low temperature applications, or for improved pumpability. NLGI 3 greases are recommended for bearing arrangements with a vertical shaft, where a baffle plate is arranged beneath the bearing to prevent the grease from leaving the bearing.

In applications subjected to vibration, a grease with very good mechanical stability is required to prevent hardening or softening under conditions of vibration and shear. Higher consistency greases may help here, but stiffness alone does not guarantee good performance. Lithium and lithium complex greases typically have good mechanical stability.

### Operating temperature

The temperature range over which a grease can be used depends largely on the type of base oil and thickener used as well as the additives. Very low temperatures may result in excessive rotating torque or insufficient oil bleed from the grease pack. At very high temperatures the rate of oxidation (deterioration) of the grease is accelerated and evaporation losses are magnified. Oxidation by-products are detrimental to bearing lubrication. When bearing operating temperatures are below  $-4^{\circ}\text{F}$  ( $-20^{\circ}\text{C}$ ) or above  $250^{\circ}\text{F}$  ( $121^{\circ}\text{C}$ ) grease lubrication with conventional grease may not be acceptable. Specialty greases or other lubrication methods (i.e. circulating oil) should be considered at that time. In these cases it is advisable to consult with SKF Application Engineering and the grease supplier to determine the lubricant that will be most suitable for the application.

**NOTE: The operating temperature limits that a lubricant manufacturer provides are based on grease chemical properties. This does not mean that the grease will properly lubricate bearings within those same temperature ranges. The viscosity of the base oil is usually too low to adequately lubricate a bearing at the temperature limits the lubricant manufacturer provides. For low operating temperatures, the oil bleed rate needs to be considered when selecting a grease.**

## Oil bleed rate

Grease must release some of its oil during operation to properly lubricate the bearing. The rate at which the oil is released is the bleed rate or the oil separation rate. One industry standard test for determining oil bleed rate is DIN Standard 51817. Typical oil bleed rates of greases used for bearing lubrication are 1 to 5%. The base oil viscosity of the greases normally used for rolling bearings lies between 15 and 500 mm<sup>2</sup>/s at 104° F (40° C). Greases with base oils having higher viscosities than 1000 mm<sup>2</sup>/s at 104° F (40° C) bleed oil so slowly that the bearing may not be adequately lubricated. Therefore, if the calculated minimum required viscosity is above 1000 mm<sup>2</sup>/s, it is better to use a grease with a maximum viscosity of 1000 mm<sup>2</sup>/s at the operating temperature and good oil bleeding properties or to apply oil lubrication.

## Rust/corrosion protection and behavior in the presence of water

Grease should protect the bearing against corrosion and should not be washed out of the bearing arrangement in cases of water penetration. The thickener type solely determines the resistance to water: lithium complex, calcium complex and polyurea greases usually have very good resistance to washout. Most sodium soap greases emulsify and thin out when mixed with water. No lubricating grease is completely water resistant. Even those classified as water insoluble or water resistant can be washed out if exposed to large volumes of water. The type of rust inhibitor additive mainly determines the rust inhibiting properties of greases.

At very low speeds, a full grease pack of the bearing and housing is beneficial for corrosion protection and preventing water ingress, and frequent relubrication is also recommended to flush out contaminated grease.

## Load carrying ability: EP and AW additives

Bearing life is shortened if the lubricant film thickness is not sufficient to fully separate the rolling contact surfaces. This is usually very common for very slow rotating bearings. One option to overcome this is to use a lubricant with Extreme Pressure (EP) and Anti-Wear (AW) additives. High temperatures induced by local asperity contact, activate these additives promoting mild wear at the points of contact. The result is a smoother surface with lower contact stresses and an increase in service life. However, if the lubricant film thickness is sufficient, SKF does not generally recommend the use of EP and AW additives. The reason is that some of these additives can become reactive at temperatures as low as 180° F (82° C). When they become reactive, they can promote corrosion and micro-pitting. Therefore, SKF recommends the use of less reactive EP additives for operating temperatures above 180° F (82° C) and does not recommend EP additives at all above 210° F (99° C).

AW additives have a function similar to that of EP additives, i.e. to prevent severe metal-to-metal contact. AW additives build a protective layer that adheres to the surface. The asperities are then sliding over each other without metallic contact. The roughness is therefore not reduced by mild wear as in the case of EP additives. AW additives may contain elements that, in the same way as the EP additives, can migrate into the bearing steel and weaken the structure.

For very low speeds, solid lubricant additives such as graphite and molybdenum disulphide (MoS<sub>2</sub>) are sometimes included in the additive package to enhance the EP effect. These additives should have a high purity level and a very small particle size; otherwise dents due to over rolling of the particles might reduce bearing fatigue life.

## Compatibility

If it becomes necessary to change from one grease to another, the compatibility of the greases should be considered.

**CAUTION:** If incompatible greases are mixed, the resulting consistency can change significantly and bearing damage due to lubricant leakage or lubricant hardening can result.

Greases having the same thickener and similar base oils can generally be mixed without any problems, e.g. a lithium thickener/mineral oil grease can generally be mixed with another lithium thickener/mineral oil grease. Also, some greases with different thickeners, e.g. calcium complex and lithium complex greases, can be mixed. However, it is generally good practice not to mix greases. The only way to be absolutely certain about the compatibility of two different greases is to perform a compatibility test with the two specific greases in question. Often the lubricant manufacturers for common industrial greases have already performed these tests and they can provide those results if requested.

The preservative with which SKF bearings are treated is compatible with the majority of rolling bearing greases with the possible exception of polyurea greases. Modern polyurea greases tend to be more compatible with preservatives than some of the older polyurea greases.

## SKF greases

SKF has a full range of bearing lubricating greases covering virtually all application requirements. These greases have been developed based on the latest information regarding rolling bearing lubrication and have been thoroughly tested both in the laboratory and in the field. Their quality is regularly monitored by SKF.



## Grease relubrication

In order for a bearing to be properly lubricated with grease, oil must bleed from the grease. The oil that is picked up by the bearing components is gradually broken down by oxidation or lost by evaporation, centrifugal force, etc. In time, the grease will oxidize or the oil in the grease near the bearing will be depleted. Therefore, depending upon the life requirement for the bearing, relubrication may be necessary. There are two critical factors to proper relubrication: the quantity of grease supplied and the frequency at which it is supplied.

If the service life of the grease is shorter than the expected service life of the bearing, the bearing has to be relubricated. Relubrication should occur when the condition of the existing lubricant is still satisfactory. The relubrication interval depends on many related factors. These include bearing type and size, speed, operating temperature, grease type, space around the bearing, and the bearing environment. The relubrication charts and information provided are based on statistical rules. The SKF relubrication intervals are defined as the time period, at the end of which 99% of the bearings are still reliably lubricated. This represents the  $L_1$  grease life.

### Bearings with integral seals and shields

The information and recommendations below relate to bearings without integral seals or shields. Bearings and bearing units with integral seals and shields on both sides are typically already supplied with grease from the manufacturer. Bearings with integral seals and shields are very difficult to re-grease. Therefore, when estimating the service life of sealed or shielded bearings, consideration needs to be given to bearing fatigue life and grease life. The service life of a bearing with integral seals or shields is determined by the shorter of the two lives. For information about the grease life of a bearing with integral seals or shields, SKF should be contacted.

## Relubrication intervals

The relubrication intervals  $t_r$  for bearings with rotating inner ring on horizontal shafts under normal and clean conditions can be obtained from **Figure 9** as a function of:

- the bearing rotational speed ( $n$ ), rpm
- the bearing pitch diameter ( $d_m$ )  
 $d_m = [\text{bearing bore(mm)} + \text{bearing OD(mm)}]/2$
- the relevant bearing factor,  $b_f$ , depending on bearing type and load conditions, (see **Table 1**)
- the load ratio (Dynamic capacity / Applied resultant load),  $C/P$

The relubrication interval  $t_r$  is an estimated value based on an operating temperature of 70°C (158°F), using good quality lithium thickener/mineral oil greases. When bearing operating conditions differ, adjust the relubrication intervals obtained from **Figure 9**, according to the information given under “Relubrication interval adjustments” (page 96).

If the  $n \times d_m$  exceeds 70% of the recommended limit according to **Table 1** (page 96) or if ambient temperatures are high, then extra consideration should be given to the lubrication methods. When using high performance greases, a longer relubrication interval can be achieved. SKF Application Engineering should be consulted in these instances.

Figure 9

Relubrication intervals at 158° F (70° C)

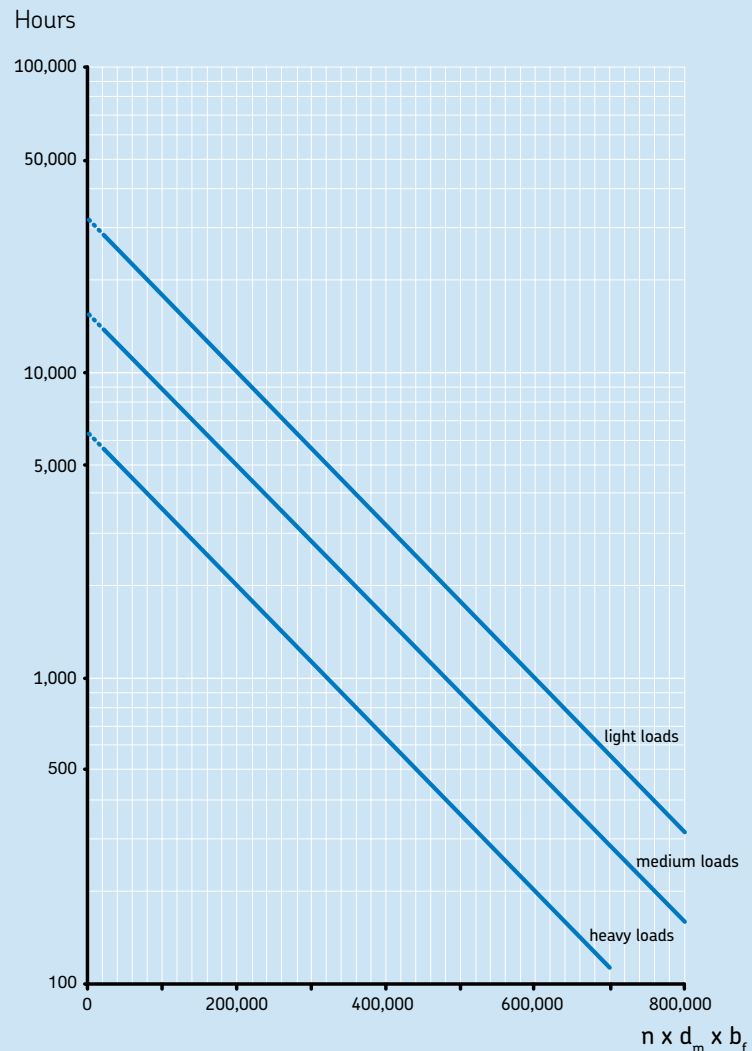

# Relubrication interval adjustments

## Operating temperature

Since grease aging is accelerated with increasing temperature, it is recommended to halve the intervals obtained from **Figure 9** for every 27° F (15° C) increase in operating temperature above 158° F (70° C). The alternate also applies for lower temperatures. The relubrication interval  $t_r$  may be extended at temperatures below 158° F

(70° C) if the temperature is not so low as to prevent the grease from bleeding oil. In the case of full complement bearings and thrust roller bearings,  $t_r$  values obtained from **Figure 9** should not be extended. It is also not advisable to use relubrication intervals in excess of 30,000 hours.

In general, specialty greases are required for bearing temperatures in excess of 210° F (100° C). In addition, the material limitations of the bearing components should also be taken into consideration such as the cage, seals, and the temperature stability of the bearing steel.

## Vertical shaft

For bearings on vertical shafts, the intervals obtained from **Figure 9** should be halved. A good seal or retaining shield below the bearing is required to prevent the grease from exiting the bearing cavity. As a reminder, NLGI 3 greases help reduce the amount of grease leakage and churning that occurs in vertical shaft applications.

## Vibration

Moderate vibration should not have a negative effect on grease life. But high vibration

Table 1

Bearing factors and recommended limits for  $n \times d_m$

Bearing type <sup>1)</sup>	Bearing factor $b_f$	Recommended limits for $n \times d_m$		
		light load	medium load	heavy load
Deep groove ball bearings	1	500,000	400,000	300,000
Y-bearings	1	500,000	400,000	300,000
Angular contact ball bearings	1	500,000	400,000	300,000
Self-aligning ball bearings	1	500,000	400,000	300,000
Cylindrical roller bearings				
– non-locating bearing	1,5	450,000	300,000	150,000
– locating bearing, without external axial loads or with light but alternating axial loads	2	300,000	200,000	100,000
– locating bearing, with constantly acting light axial load	4	200,000	120,000	60,000
– without a cage, full complement <sup>2)</sup>	Contact the SKF application engineering service.			
Needle roller bearings				
– with a cage	3	350,000	200,000	100,000
– without a cage, full complement	1,5	450,000	300,000	150,000
Tapered roller bearings	2	350,000	300,000	200,000
Spherical roller bearings				
– when load ratio $F_a/F_r \leq e$ and $d_m \leq 800$ mm				
series 213, 222, 238, 239	2	350,000	200,000	100,000
series 223, 230, 231, 232, 240, 248, 249	2	250,000	150,000	80,000
series 241	2	150,000	80,000 <sup>4)</sup>	50,000 <sup>4)</sup>
– when load ratio $F_a/F_r \leq e$ and $d_m > 800$ mm				
series 238, 239	2	230,000	130,000	65,000
series 230, 231, 232, 240, 248, 249	2	170,000	100,000	50,000
series 241	2	100,000	50,000 <sup>4)</sup>	30,000 <sup>4)</sup>
– when load ratio $F_a/F_r > e$				
all series	6	150,000	50,000 <sup>4)</sup>	30,000 <sup>4)</sup>
CARB toroidal roller bearings				
– with cage	2	350,000	200,000	100,000
– without cage, full complement <sup>2)</sup>	4	NA <sup>3)</sup>	NA <sup>3)</sup>	20,000
Thrust ball bearings	2	200,000	150,000	100,000
Cylindrical roller thrust bearings	10	100,000	60,000	30,000
Needle roller thrust bearings	10	100,000	60,000	30,000
Spherical roller thrust bearings				
– rotating shaft washer	4	200,000	120,000	60,000

1) The bearing factors and recommended practical  $n \times d_m$  limits apply to bearings with standard internal geometry and standard cage execution. For alternative internal bearing design and special cage execution, please contact the SKF application engineering service

2) The  $t_r$  value obtained from **Figure 9** needs to be divided by a factor of 10

3) Not applicable, for these C/P values a caged bearing is recommended instead

4) For higher speeds oil lubrication is recommended

and shock levels, such as those in vibrating screen applications, can cause the grease to “slump” more quickly, resulting in churning. In these cases the relubrication interval should be reduced. If the grease becomes too soft, grease with a better mechanical stability or grease with higher stiffness up to NLGI 3 should be used.

## Outer ring rotation

In applications where the outer ring rotates or where there is an eccentric shaft weight, the speed factor  $n \times d_m$  is calculated differently: in this case use the bearing outside diameter  $D$  instead of  $d_m$ . The use of a good sealing mechanism is also required to avoid grease loss.

Under conditions of high outer ring speeds (i.e. > 40% of the bearing reference speed), greases with reduced bleed rates should be selected. For spherical roller thrust bearings with a rotating housing washer, oil lubrication is recommended.

## Contamination

When considering contamination, grease aging isn't as much an issue as the detrimental effects of the contaminants to the bearing surfaces. Therefore, more frequent relubrication than indicated by the relubrication interval will reduce the negative effects of foreign particles on the grease while reducing the damaging effects caused by over-rolling the particles. Fluid contaminants (water, process fluids, etc.) also call for a reduced interval. In case of severe contamination, continuous relubrication should be considered.

Since there are no formulas to determine the frequency of relubrication because of contamination, experience is the best indicator of how often to relubricate. It is generally accepted that the more frequent the relubrication the better. However, care should be taken to avoid overgreasing a bearing in an attempt to flush out contaminated grease. Using less grease on a more frequent basis rather than the full amount of grease each time is recommended. Excessive regreasing without the ability to purge will cause higher operating temperatures because of churning. The grease amount required for relubrication is discussed later in this section.

## Very low speeds

Bearings that operate at very low speeds under light loads call for a grease with low consistency while bearings that operate at low speeds and heavy loads require a grease having a high viscosity, and if possible, good EP characteristics. Selecting the proper grease and grease fill is important in low speed applications. In some cases, 100% fills may be appropriate. In general, grease aging is not an issue for very low speed applications when bearing temperatures are less than 158° F (70° C), so relubrication is rarely needed unless contamination is an issue.

## High speeds

Relubrication intervals for bearings used at high speeds, i.e. above the speed factor  $n \times d_m$  in **Table 1**, only apply when using special greases or special bearings, e.g. hybrid bearings. In these cases continuous relubrication techniques such as circulating oil, oil-spot, etc. are more suitable than grease lubrication.

## Very heavy loads

For bearings operating at a speed factor  $n \times d_m > 20,000$  and with a load ratio  $C/P < 4$ , the relubrication interval should be reduced. Under these very heavy load conditions, continuous grease relubrication or oil bath lubrication is recommended.

In applications where the speed factor  $n \times d_m < 20,000$  and the load ratio  $C/P = 1-2$ , see information under “Very low speeds”, above. For heavy loads and high speeds, circulating oil lubrication with cooling is generally recommended.

## Very light loads

In many cases the relubrication interval may be extended if the loads are light ( $C/P = 30$  to 50). Be aware that bearings do have minimum load requirements for satisfactory operation.

## Misalignment

A constant misalignment within the permissible limits of the bearing does not adversely affect the grease life in self-aligning type bearings. However, misalignment in other

bearing types will typically generate higher operating temperatures and require more frequent relubrication. Reference “Operating temperature” (page 96).

## Large bearings

To establish a proper relubrication interval for large roller bearings ( $d > 300$  mm) used in critical bearing arrangements in process industries, an interactive procedure is recommended. In these cases it is advisable to initially relubricate more frequently and adhere strictly to the recommended regreasing quantities (see “grease relubrication procedures”, page 98). Before regreasing, the appearance of the used grease and the degree of contamination due to particles and water should be checked. The seals should also be checked for wear, damage and leaks. When the condition of the grease and associated components is found to be satisfactory, the relubrication interval can be gradually increased.

## Very short intervals

If the determined value for the relubrication interval  $t_r$  is too short for a particular application, it is recommended to:

- check the bearing operating temperature,
- check whether the grease is contaminated by solid particles or fluids,
- check the bearing application conditions such as load or misalignment,
- consider a more suitable grease.

## Grease relubrication procedures

The choice of the relubrication procedure generally depends on the application and on the relubrication interval  $t_r$  obtained. There are three primary options for grease relubrication including: replenishment, renewal, and continuous relubrication.

**Replenishment** is a convenient and preferred procedure if the relubrication interval is shorter than six months. It allows uninterrupted operation and provides a lower steady state temperature than continuous relubrication.

**Renewing** the grease fill is generally recommended when the relubrication interval is longer than six months. This procedure is often applied as part of a bearing maintenance schedule, e.g. in railway applications.

**Continuous relubrication** is used when the estimated relubrication interval is short, e.g. due to the adverse effects of contamination, or when other procedures of relubrication are inconvenient because access to the bearing is difficult. However, continuous relubrication is not recommended for applications with high rotational speeds since the intensive churning of the grease can lead to very high operating temperatures and destruction of the grease thickener structure.

When using different bearings in an assembly, it is common practice to apply the lowest estimated relubrication interval for both bearings. The guidelines and grease quantities for the three alternative procedures are given in the following sections.

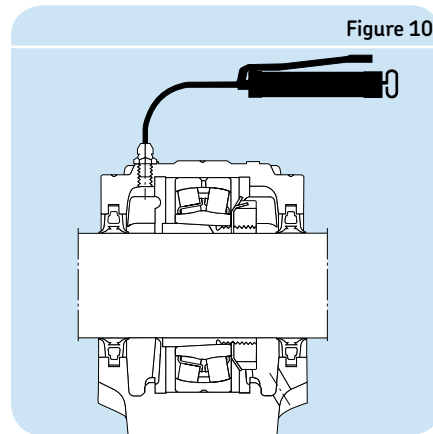

Figure 10

### Replenishment

At initial installation, the bearing should be completely filled with grease, while the free space in the housing should be partly filled. Depending on the intended method of replenishment, the following grease fill percentages for this free space in the housing are recommended:

- 40% when grease is added from the side of the bearing (**Figure 10**),
- 20% when grease is added through the annular groove and lubrication holes in the bearing outer or inner ring (**Figure 11**).

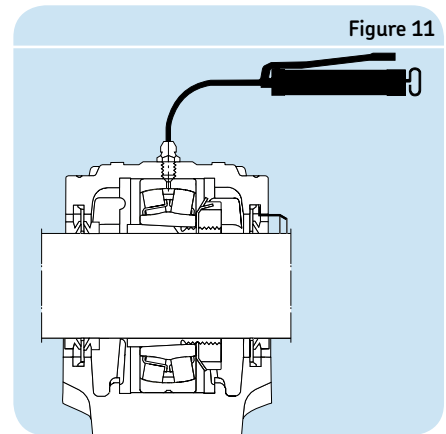

Figure 11

Suitable quantities for replenishment are as follows:

- $G_p$  (oz) =  $D(\text{in}) \times B(\text{in}) \times 0.1$  for relubrication from the side of a bearing
- $G_p$  (g) =  $D(\text{mm}) \times B(\text{mm}) \times 0.005$  for relubrication from the side of a bearing
- $G_p$  (oz) =  $D(\text{in}) \times B(\text{in}) \times 0.04$  for relubrication through the outer or inner ring
- $G_p$  (g) =  $D(\text{mm}) \times B(\text{mm}) \times 0.002$  for relubrication through the outer or inner ring

where

$G_p$  (oz) = grease quantity in ounces to be added when replenishing

$G_p$  (g) = grease quantity in grams to be added when replenishing

$D$  = bearing outside diameter

$B$  = total bearing width

If contact seals are used in the bearing arrangement, attention should be given to the direction of the contact lip. If the lip is facing the bearing, then purging is unlikely and an exit hole in the housing should also be provided (**Figure 10**) so that excessive amounts of grease will not build up in the space surrounding the bearing. An excessive build-up of grease can result in a permanent increase in bearing temperature. The exit hole should be plugged if high-pressure water is used for cleaning.

To be sure that fresh grease actually reaches the bearing and replaces the old grease, the lubrication duct in the housing should either feed the grease adjacent to the outer ring side face (**Figure 10** and **Figure 12**) or, better still, into the bearing. To facilitate efficient lubrication of some bearing types, e.g. spherical roller bearings, are provided with an annular groove and/or lubrication holes in the outer or inner ring (**Figure 11** and **Figure 13**).

To effectively replace old grease, replenish while the machine is operating. In cases where the machine is not in operation, if possible, the bearing should be rotated during replenishment. When lubricating the bearing directly through the inner or outer ring, the fresh grease is most effective in replenishment; therefore, the amount of grease needed is reduced when compared with relubricating from the side. It is assumed that the lubrication ducts were already filled with grease during the mounting process. If not, a greater relubrication quantity during the first replenishment is needed to compensate for the empty ducts.

Where long lubrication ducts are used, check whether the grease can be adequately pumped if ambient temperatures are low.

The complete grease fill should be replaced when the free space in the housing can no longer accommodate additional grease, i.e. approximately above 75% of the housing free volume. When relubricating from the side and starting with 40% initial fill of the housing, the complete grease fill should be replaced after approximately five replenishments. Since replenishment involves a lower initial fill of the housing and a reduced topping-up quantity when relubricating the bearing directly through inner or outer ring, renewal will only be required in exceptional cases.

## Renewing the grease fill

When renewal of the grease fill is made at the estimated relubrication interval or after a certain number of replenishments, the used grease in the bearing arrangement should be completely removed and replaced by fresh grease. Filling the bearing and housing with grease should be done in accordance with the guidelines given under "Replenishment", page 98.

To enable renewal of the grease fill, the bearing housing should be easily accessible and easily opened. The cap of split housings and the covers of one-piece housings can usually be removed to expose the bearing cavity. After removing the used grease, fresh grease should first be packed into the bearing (between the rolling elements). Care should be taken to see that contaminants are not introduced into the bearing or housing when relubricating, and the grease itself should be protected. The use of grease resistant gloves is recommended to prevent any allergic skin reactions.

When housings are less accessible but are provided with grease nipples and exit holes, it is possible to completely renew the grease fill by relubricating several times in close succession until it can be assumed that all old grease has been pressed out of the housing. This procedure requires much more grease than is needed for manual renewal of the grease fill. In addition, this method of renewal has a limitation with respect to operational speeds: at high speeds it can lead to unacceptably high operating temperatures caused by excessive churning of the grease.

## Continuous relubrication

This procedure is used when the calculated relubrication interval is very short, i.e. due to the adverse effects of contamination, or when other procedures of relubrication are inconvenient, e.g. access to the bearing is difficult. Due to the excessive churning of the grease, which can lead to increased temperature, continuous lubrication is only recommended when rotational speeds are low i.e. at speed factor:

- $n \times d_m < 150,000$  for ball bearing
- $n \times d_m < 75,000$  for roller bearings

In these cases the initial grease fill of the housing may be 100% and the quantity for

Figure 12

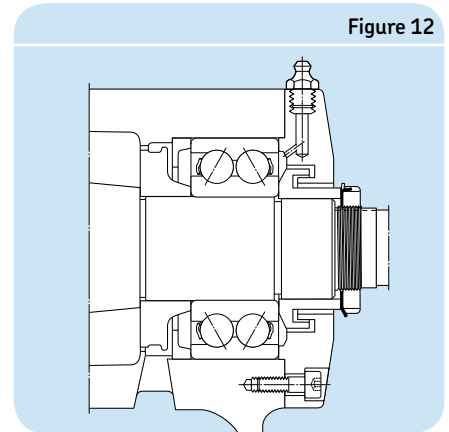
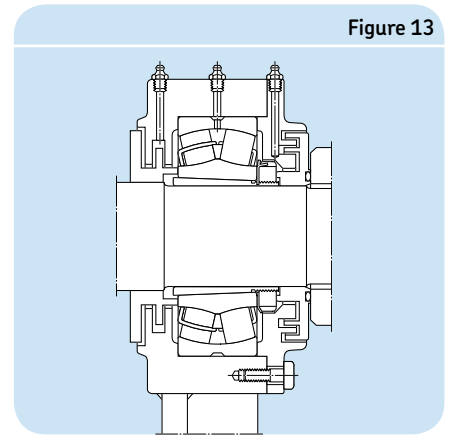

Figure 13



relubrication per time unit is derived from the equations for  $G_p$  under "Replenishment" by spreading the relevant quantity over the relubrication interval. When using continuous relubrication, check whether the grease can be adequately pumped if ambient temperatures are low. Continuous lubrication can be achieved via single-point or multi-point automatic lubricators, e.g. SKF SYSTEM 24<sup>®</sup> or SYSTEM MultiPoint.

## SKF solid oil (W64)

### SKF Solid Oil – The third lubrication choice

SKF Solid Oil has been developed specifically for applications where conventional lubrication either cannot be used or has been unsuccessful and extended service life is desired. These can include applications where lack of accessibility makes lubrication impossible or when very good contaminant exclusion is required.

Solid Oil is a polymer matrix, saturated with a lubricating oil, which completely fills the internal space in a bearing, and encapsulates the cage and rolling elements. The oil-filled polymer material is pressed into the bearing. Solid Oil uses the cage as a reinforcement element and rotates with the cage. The oil within the Solid Oil pack is released and retained on the bearing surfaces by surface tension. Oil comprises approximately 70% of the weight of the Solid Oil pack.

### Limitations

The operating range for Solid Oil is  $-40^{\circ}\text{F}$  to  $185^{\circ}\text{F}$  ( $-40^{\circ}\text{C}$  to  $85^{\circ}\text{C}$ ), although brief periods of operation up to  $200^{\circ}\text{F}$  ( $93^{\circ}\text{C}$ ) can be tolerated. The limiting speed is lower than standard grease lubrication, and this speed depends on the bearing type.

### Unique advantages of solid oil

- It keeps the oil in position
- It keeps contaminants out
- It makes maintenance unnecessary (no relubrication needed)
- It is environmentally friendly
- It is resistant to most chemicals
- It can withstand large “g” forces

SKF bearing type	Maximum $N_{dm}$ with Solid Oil
Single row deep groove ball	300,000
Angular contact ball	150,000
Self-aligning ball	150,000
Cylindrical roller	150,000
Spherical roller “E” type	42,500
Spherical roller “non-E” type	85,000
Taper roller	45,000
Ball bearing with nylon cages (included Y-range unit ball bearings)	40,000
Needle roller	not recommended
Toroidal roller	not recommended
$N_{dm} = \text{RPM} \times (\text{bore} + \text{OD}) / 2$ in mm	
* Maximum $N_{dm}$ values are for open and shielded bearings. For sealed bearings, use 80% of the value listed.	

Version	Description	Approximate oil viscosity (cSt)	
		@ $104^{\circ}\text{F}$ ( $40^{\circ}\text{C}$ )	@ $212^{\circ}\text{F}$ ( $100^{\circ}\text{C}$ )
W64	Standard	143	18
W64E	Medium load	430	49
W64H	Heavy load	933	80
W64F	Food grade (USDA H1)	214	25
W64J	Low temperature	2	6
W64JW	Silicon free	150	28

# SKF lubrication systems

SKF offers a variety of lubrication systems for industrial machinery. These systems are categorized as centralized and minimum quantity lubrication.

## Centralized lubrication

A pump delivers grease or oil from a central reservoir to the friction points and machine elements in a fully automated manner. The lubrication is supplied as often as necessary and in the correct quantity, providing all lube points with an optimal supply of lubricant. These types of systems considerably reduce the consumption of lubricant.

- Total loss lubrication systems (single-line)
- Total loss lubrication systems (dual-line)
- Total loss progressive systems
- Circulating oil lubrication systems
- Hydrostatic lubrication systems
- Special solutions (chain)

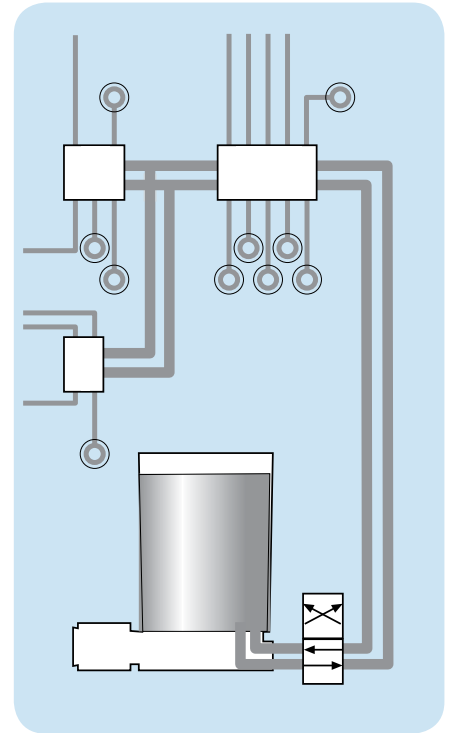
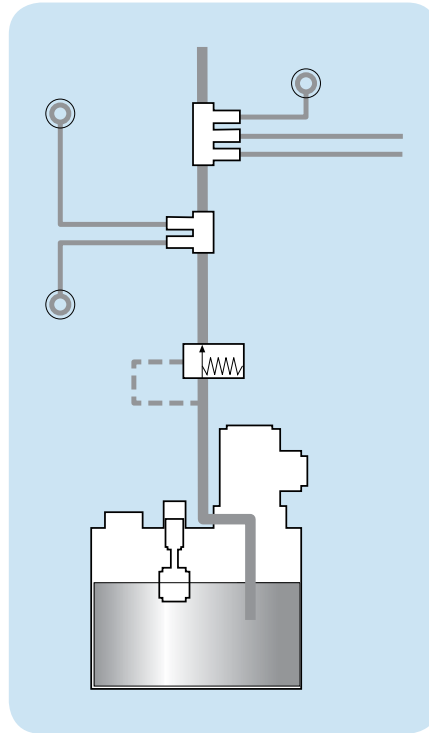

## Minimal quantity lubrication

With minimal quantity lubrication, it's possible to achieve effective lubrication of the cutting process with extremely small quantities of oil. The result is not only higher productivity due to faster cutting speeds but also longer tool lives and savings on cooling lubricants in the value-added process.

Air-oil lubrication systems  
Compressed air-oiling  
LubriLean®

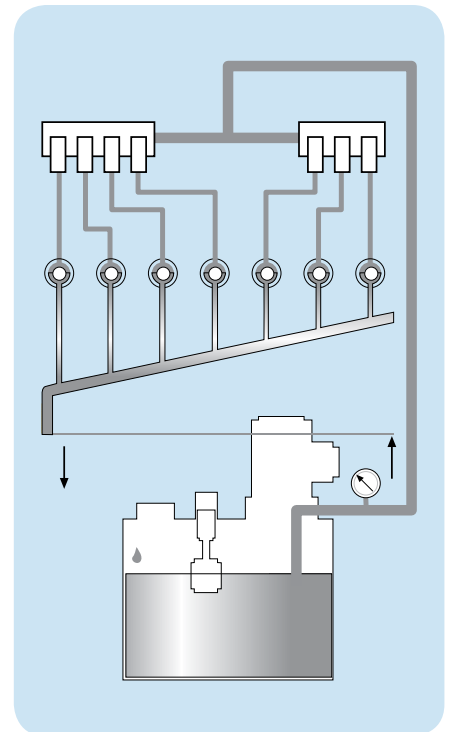
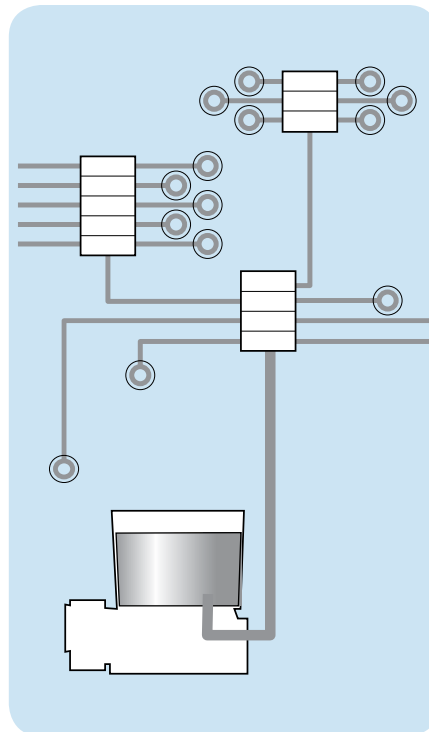





# Troubleshooting

Bearings that are not operating properly usually exhibit identifiable symptoms. This section presents some useful hints to help identify the most common causes of these symptoms as well as practical solutions wherever possible. Depending on the degree of bearing damage, some symptoms may be misleading and in many cases are the result of secondary damage. To effectively troubleshoot bearing problems, it is necessary to analyze the symptoms according to those first observed in the applica-

tions. Symptoms of bearing trouble can usually be reduced to a few classifications, which are listed below. Each symptom shown below is broken down into categories of conditions that lead to those symptoms. Each condition has a numerical code that can be referenced for practical solutions to that specific condition. Additional solutions appear throughout this guide.

**Note:** Troubleshooting information shown on these pages should be used as guidelines only. Consult your SKF representative or

machine manufacturer for specific maintenance information.

## Common bearing symptoms

- Excessive heat
- Excessive noise
- Excessive vibration
- Excessive shaft movement
- Excessive torque to rotate shaft

## Common bearing symptoms

Solution code	
	<b>Excessive heat</b>
	<b>Lubrication</b>
1	Wrong type of lubricant, i.e. NLGI # of grease or Viscosity Grade (VG) of oil
2	Wrong lubrication system – Ex. circulating oil required but bearing is on static oil
3	Insufficient lubrication – Too low oil level or too little grease, e.g. excessive leakage
4	Excessive lubrication – Too high oil level or too much grease without a chance to purge
	<b>Insufficient bearing internal clearance</b>
5	Wrong bearing internal clearance selection
6	Excessive shaft interference fit or oversized shaft diameter
7	Excessive housing interference fit or undersized housing bore diameter
8	Excessive out-of-round condition of shaft or housing – Bearing is pinched in warped housing
9	Excessive drive-up on tapered seat
10	Large temperature difference between shaft and housing (housing is much cooler than shaft)
11	Shaft material expands more than bearing steel (300 series stainless steel shaft)
	<b>Improper bearing loading</b>
12	Skidding rolling elements as a result of insufficient load
13	Bearings are excessively preloaded as a result of adjustment
14	Bearings are cross-located and shaft can no longer expand, inducing excessive thrust loads on bearings
15	Unbalanced or out-of-balance condition creating increased loading on bearing
16	Overloaded bearings as a result of changing application parameters, ex. going from a coupling to a belt drive
17	Linear misalignment of shaft relative to the housing is generating multiple load zones and higher internal loads
18	Angular misalignment of shaft relative to the housing is generating a rotating misalignment condition
19	Wrong bearing is fixed
20	Bearing installed backwards causing unloading of angular contact type bearings or filling notch bearings

## Common bearing symptoms

Solution code	
	<b>Excessive heat</b>
	<b>Sealing conditions</b>
21	Housing seals are too tight or are rubbing against another component other than the shaft
22	Multiple seals in housing
23	Misalignment of housing seals
24	Operating speed too high for contact seals in bearing
25	Seals not properly lubricated, i.e. felt seals not oiled
26	Seals oriented in the wrong direction and not allowing grease purge
	<b>Excessive noise</b>
	<b>Metal-to-metal contact</b>
1	Oil film too thin for operating conditions <ul style="list-style-type: none"> <li>• Temperature too high</li> <li>• Speed very slow</li> </ul>
3	Insufficient quantity of lubrication <ul style="list-style-type: none"> <li>• Never lubricated bearing</li> <li>• Leakage from worn or improper seals</li> <li>• Leakage from incompatibility</li> </ul>
12	Rolling elements skidding <ul style="list-style-type: none"> <li>• Inadequate loading to properly seat rolling elements</li> <li>• Lubricant too stiff</li> </ul>
	<b>Contamination</b>
27	Solid particle contamination entering the bearing and denting the rolling surfaces
28	Solids left in the housing from manufacturing or previous bearing failures
29	Liquid contamination reducing the lubricant viscosity
	<b>Looseness</b>
30	Inner ring turning on shaft because of undersized or worn shaft
31	Outer ring turning in housing because of oversized or worn housing bore
32	Locknut is loose on the shaft or tapered sleeve
33	Bearing not clamped securely against mating components
34	Too much radial / axial internal clearance in bearings
	<b>Surface damage</b>
35	Rolling surfaces are dented from impact or shock loading
36	Rolling surfaces are false-brinelled from static vibration
37	Rolling surfaces are spalled from fatigue
38	Rolling surfaces are spalled from surface initiated damage
39	Static etching of rolling surface from chemical/liquid contamination
27	Particle denting of rolling surfaces from solid contamination
40	Fluting of rolling surfaces from electric arcing
41	Pitting of rolling surfaces from moisture or electric current
1, 2, 3, 4	Wear from ineffective lubrication
12	Smearing damage from rolling element skidding

## Common bearing symptoms

Solution code	
	<b>Excessive noise</b>
	<b>Rubbing</b>
23	Housing seals are misaligned causing rubbing, i.e. insufficient clearance in labyrinth seals
42	Locknut tabs are bent and are rubbing against bearing seals or cage
32	Adapter sleeve not properly clamped and is turning on the shaft
33	Spacer rings are not properly clamped and are turning relative to the bearing face
	<b>Excessive vibration</b>
	<b>Metal-to-metal contact</b>
12	Rolling elements skidding <ul style="list-style-type: none"> <li>• Inadequate loading to properly seat rolling elements</li> <li>• Lubricant too stiff</li> </ul>
	<b>Contamination</b>
27	Solid particle contamination entering the bearing and denting the rolling surfaces
28	Solids left in the housing from manufacturing or previous bearing failures
	<b>Looseness</b>
30	Inner ring turning on shaft because of undersized or worn shaft
31	Outer ring turning in housing because of oversized or worn housing bore
	<b>Surface damage</b>
35	Rolling surfaces are dented from impact or shock loading
36	Rolling surfaces are false-brinelled from static vibration
37	Rolling surfaces are spalled from fatigue
38	Rolling surfaces are spalled from surface initiated damage
39	Static etching of rolling surface from chemical/liquid contamination
27	Particle denting of rolling surfaces from solid contamination
40	Fluting of rolling surfaces from electric arcing
41	Pitting of rolling surfaces from moisture or electric current
1, 2, 3, 4	Wear from ineffective lubrication
12	Smearing damage from rolling element skidding
	<b>Excessive shaft movement</b>
	<b>Looseness</b>
30	Inner ring loose on shaft because of undersized or worn shaft
31	Outer ring excessively loose in housing because of oversized or worn housing bore
33	Bearing not properly clamped on shaft / in housing
	<b>Surface damage</b>
37	Rolling surfaces are spalled from fatigue
38	Rolling surfaces are spalled from surface initiated damage
1, 2, 3, 4	Wear from ineffective lubrication
	<b>Design</b>
5	Wrong bearing clearance selected for application, i.e. too much endplay in bearing



## Common bearing symptoms

Solution code	
	<b>Excessive torque to rotate shaft</b>
<p>6, 7 8 8 9 10 11 5</p>	<p><b>Preloaded bearing</b></p> <p>Excessive shaft and housing fits</p> <p>Excessive out-of-round condition of shaft or housing causing egg-shaped condition</p> <p>Excessive out-of-round condition of shaft or housing</p> <ul style="list-style-type: none"> <li>• Bearing is pinched in warped housing</li> </ul> <p>Excessive drive-up on tapered seat</p> <p>Large temperature difference between shaft and housing (housing is much cooler than shaft)</p> <p>Shaft material expands more than bearing steel (stainless steel shaft)</p> <p>Wrong clearance selected for replacement bearing, i.e. preloaded bearing instead of clearance bearing</p>
<p>21 22 23 25</p>	<p><b>Sealing drag</b></p> <p>Housing seals are too tight or are rubbing against another component other than the shaft</p> <p>Multiple seals in housing</p> <p>Misalignment of housing seals</p> <p>Seals not properly lubricated, i.e. felt seals not oiled</p>
<p>37 38 40</p>	<p><b>Surface damage</b></p> <p>Rolling surfaces are spalled from fatigue</p> <p>Rolling surfaces are spalled from surface initiated damage</p> <p>Fluting of rolling surfaces from electric arcing</p>
<p>43 44</p>	<p><b>Design</b></p> <p>Shaft and/or housing shoulders are out of square</p> <p>Shaft shoulder too large and is rubbing against seals/shields</p>

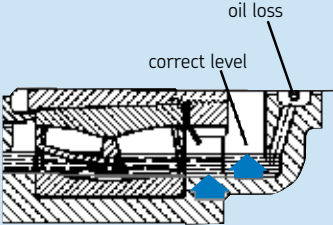
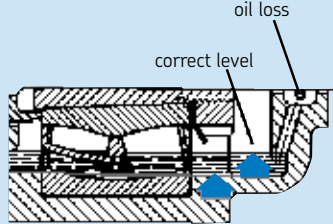
## Trouble conditions and their solutions

Solution code	Condition	Practical solution
1	Wrong type of lubricant	Review application to determine the correct base oil viscosity grade (VG) and NLGI required for the specific operating conditions. Reference page 87 of this catalog for specific lubrication guidelines. Metal-to-metal contact can lead to excessive heat and premature wear, ultimately leading to more noise.
2	Wrong lubrication system	Review the bearing speed and operating temperature to determine if grease, static oil, circulating oil, oil mist, or jet oil is required. Example: bearing may be operating too fast for static oil and may require the cooling effects of circulating oil. Consult the equipment manufacturer for specific requirements or the bearing manufacturer. Also reference the speed rating values provided in the manufacturer's product guide. The SKF values can be found in the Interactive Engineering Catalog: <a href="http://www.skf.com/portal/skf/home/products">www.skf.com/portal/skf/home/products</a> .
3	Insufficient lubrication	<p>Static oil level should be at the center of the bottommost rolling element when the equipment is not rotating. Ensure the housing is vented properly to avoid back pressure, which can cause a malfunction of constant oilers. Check seals for wear. Check housing split for leaks and apply a thin layer of gasket cement if necessary. The grease pack should be 100% of the bearing and up to the bottom of the shaft in the housing. If there is very little housing cavity alongside the bearing, then the grease quantity may need to be reduced slightly to avoid overheating from churning. See the Lubrication section starting on page 87.</p> 
4	Excessive lubrication	<p>Too much lubrication can cause excessive churning and elevated temperatures. Make sure the oil level is set to the middle of the bottommost rolling element in a static condition. Inspect oil return holes for blockages. For grease lubrication, the bearing should be packed 100% full and the housing cavity should be filled up to the bottom of the shaft. If there is very little housing cavity alongside the bearing, then the grease quantity may need to be reduced slightly to avoid overheating. Make sure grease purging is possible, either through the seals or a drain plug. Make sure the seals are oriented properly to allow excess lubricant purge while keeping contaminant out. See the Lubrication section starting on page 87.</p> 

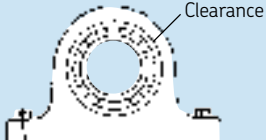
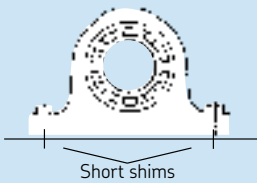

## Trouble conditions and their solutions

Solution code	Condition	Practical solution
5	Wrong bearing internal clearance selection	<p>Check whether overheated bearing had internal clearance according to original design specification. If more clearance is required for the application, SKF Applications Engineering should be consulted for the effects of additional clearance on the equipment as well as the bearing.</p> 
6	Excessive shaft interference fit or oversized shaft diameter	<p>Interference fits will reduce bearing internal clearance. Therefore, the proper fits must be selected based on the application conditions. Using an interference fit on both the shaft and in the housing will more than likely eliminate all internal bearing clearance, resulting in a hot running bearing. Reference page 54 for proper fit tolerances.</p> 
7	Excessive housing interference fit or undersized housing bore diameter	<p>Housing interference will reduce bearing internal clearance by compressing the outer ring. Therefore, the proper fits must be selected based on the application conditions. Reference page 55 for proper fit selection. For a rotating inner ring load, an interference fit in the housing will cause the “floating” bearing to become fixed, generating thrust load and excessive heat.</p> 
8	Bearing is mounted on/in an out-of-round component	<p>Check the housing bore for roundness and re-machine if necessary. Ensure that the supporting surface is flat to avoid soft foot. Any shims should cover the entire area of the housing base. Make sure the housing support surface is rigid enough to avoid flexing. Also inspect the shaft to ensure that it is not egg shaped. Specific tolerances are provided on page 81. In addition to generating more heat, an egg shaped housing can also cause the outer ring of the bearing to become pinched and restrict its axial expansion if it is the “floating” bearing.</p> 

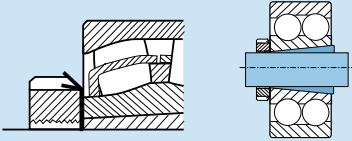
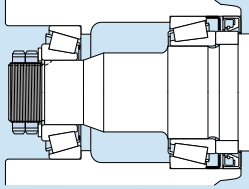
## Trouble Conditions and their Solutions

Solution code	Condition	Practical solution
9	Excessive drive-up on tapered seat	<p>Excessive drive-up on a tapered seat will reduce the bearing internal clearance and cause higher operating temperatures and risk of ring fracture. Loosen the locknut and sleeve assembly. Retighten it sufficiently to clamp the sleeve onto the shaft but be sure the bearing turns freely. Use the clearance reduction method for spherical roller bearings (page 18) and the axial drive-up/tightening angle method (page 15) for self-aligning ball bearings. You may also use <a href="http://www.skf.com/mount">www.skf.com/mount</a> for mounting instructions.</p> 
10	Large temperature difference between shaft and housing	<p>When the shaft is much hotter than the housing, bearing internal clearance is reduced and a preloaded bearing can result, causing high operating temperatures. A bearing with increased internal clearance is recommended for such applications to prevent preloading, e.g. CN to C3, C3 to C4, etc.</p>
11	Shaft material expands more than bearing steel	<p>When the shaft material has a higher coefficient of thermal expansion than the bearing, internal clearance is reduced. Therefore, for certain stainless steel shafting (300 series), either a slightly looser shaft fit is required or a bearing with increased radial internal clearance is required, e.g. CN to C3, C3 to C4, etc. The inverse applies to housing materials with greater expansion rates than bearing steel, e.g. aluminum. A slighter tighter fit may be required to prevent the outer ring from turning when the equipment comes up to equilibrium temperature.</p>
12	Skidding rolling elements as a result of insufficient load	<p>Every bearing requires a minimum load to ensure proper rolling and avoid skidding of the rolling elements. If the minimum load requirements cannot be met, then external spring type devices are required or perhaps a different bearing style with a different internal clearance is required. This problem is more common in pumps with paired angular contact ball bearings when there is a primary thrust in one direction and the back bearing becomes unloaded. The skidding of the rolling elements generates excessive heat and noise. Extremely stiff greases can also contribute to this condition, especially in very cold climates. Reference the SKF Interactive Engineering Catalog at <a href="http://www.skf.com/portal/skf/home/products">www.skf.com/portal/skf/home/products</a> for specific minimum load values.</p>
13	Bearings are excessively preloaded as a result of adjustment	<p>If the bearings have to be manually adjusted in order to set the endplay in a shaft, over-tightening the adjustment device (locknut) can result in a preloaded bearing arrangement and excessive operating temperatures. In addition to high operating temperatures, increased torque will also result. Ex. taper roller bearings or angular contact ball bearings with one bearing on each end of the shaft. Check with the equipment manufacturer for the proper mounting procedures to set the endplay in the equipment. The use of a dial indicator is usually required to measure the shaft movement during adjustment.</p> 

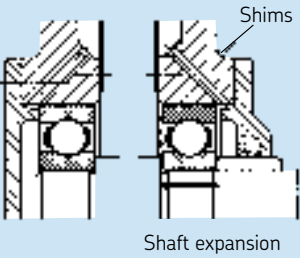
## Trouble conditions and their solutions

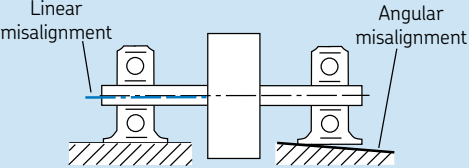

Solution code	Condition	Practical solution
14	Bearings are cross-located and shaft expansion can no longer occur	<p>When bearings are cross located and shaft expansion can no longer occur, thrust loading will be generated between both bearings, causing excessive operating temperature and increased torque. In addition, higher internal loading also occurs, which can lead to premature fatigue spalling. Insert shim between housing and cover flange to relieve axial preloading of bearing. Move the covers in one of the housings outwards and use shims to obtain adequate clearance between the housing cover and the outer ring sideface. Apply an axial spring load on the outer ring, if possible, to reduce axial play of the shaft. Determining the expected shaft growth should help establish how much clearance is required between the bearing outer ring side face and the housing cover.</p> 
15	Unbalanced or out-of-balanced condition creating increased loading and heat on bearing	<p>An unbalanced loading condition can generate a rotating outer ring load zone that will significantly increase the operating temperature of the bearing, as well as increasing the load on the bearing. It will also cause vibration and outer ring creeping/turning. Inspect the rotor for a build-up of dirt/contaminant. Rebalance the equipment.</p> 
16	Overloaded bearings as a result of changing application parameters. Ex. Going from a coupling to a belt drive	<p>Increasing the external loading on a bearing will generate more heat within the bearing. Therefore, if a design change is made on a piece of equipment, the loading should be reviewed to make sure it has not increased. Examples would be going from a coupling to a sheave, increasing the speed of a piece of equipment, etc. The changes in the performance of the equipment should be reviewed with the original equipment manufacturer.</p>
17	Linear misalignment of shaft relative to the housing is generating multiple load zones and higher internal loads	<p>This type of misalignment will cause an additional load zone within the bearing, assuming it is not a misalignable bearing, and will lead to additional loading and heat generation. The alignment of the equipment should be checked and corrected to the original equipment manufacturer's specifications or within the bearing's misalignment limitations.</p> 

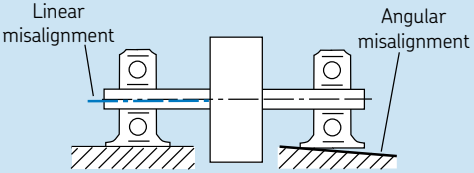
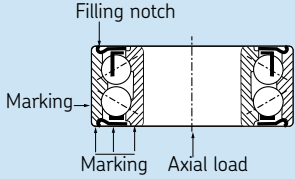
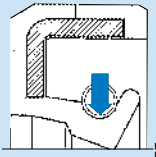

## Trouble conditions and their solutions

Solution code	Condition	Practical solution
18	Angular misalignment of shaft relative to the housing is generating a rotating misalignment condition	<p>This type of misalignment refers to a bent shaft, which causes the rolling elements to shift positions across the raceways. This shifting of load zone position causes internal sliding and elevated temperatures. The shaft should be inspected and repaired accordingly.</p> 
19	Wrong bearing is fixed	<p>Depending upon the type of loading and bearings used in an application, if the radial bearing is accidentally "fixed" and it is not a thrust type bearing, excessive temperatures can result. In addition, in the case of a lightly loaded double row bearing, thrust load can cause unloading of the inactive row and cause smearing damage. Make sure the bearing positions are noted and the new bearings replaced according to the manufacturer's recommendations. If no records are available and the equipment manufacturer is no longer around, then the bearing manufacturer should be consulted to determine the proper bearing orientation.</p>
20	Bearing installed backwards	<p>Separable bearings as well as directional type bearings must be installed in the proper orientation to function properly. Single row angular contact ball bearings as well as taper roller bearings are directional and will separate if installed backwards. Filling notch bearing types such as double row angular contact ball bearings are also directional because of the filling notch. Check the equipment manual or consult with the bearing manufacturer for proper orientation.</p> 
21	Housing seals are too tight or are rubbing against another component other than the shaft	<p>Make sure the shaft diameter is correct for the specific spring-type seal being used to avoid excessive friction. Also investigate the mating components next to the seals and eliminate any rubbing that is not appropriate. Make sure the seals are lubricated properly, i.e. felt seals should be soaked in oil prior to installation.</p> 
22	Multiple seals in housing	<p>If multiple contact seals are being used to help keep out contamination, increased friction and therefore heat will result. Before adding additional seals to an application, the thermal effects on the bearing and lubricant should be considered in addition to the extra power required to rotate the equipment.</p>

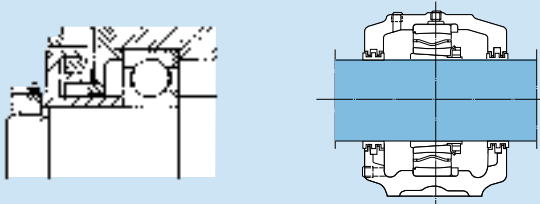
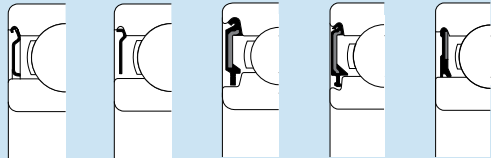

## Trouble conditions and their solutions

Solution code	Condition	Practical solution
23	Misalignment of housing seals	<p>Any misalignment of the shaft relative to the housing can cause a clearance or gap type seal to rub. This condition can cause elevated temperatures, noise, and wear during the initial run-in period, not to mention compromising the sealing integrity. The alignment should be checked and corrected accordingly.</p> 
24	Operating speed too high for contact seals in bearing	<p>If the speed of the equipment has been increased or if a different sealing closure is being used, the bearing should be checked to make sure it can handle the speed. Contact seals will add more heat compared to an open or shielded bearing. The bearing manufacturer should be contacted to ensure that the new operating conditions are within the speed limitations of the bearing.</p> 
25	Seals not properly lubricated, i.e. felt seals not oiled	<p>Dry running contact seals can add significant heat to the system. Therefore, make sure the seals are properly lubricated upon start up of new or rebuilt equipment. Normally the lubricant in the housing will get thrown outward towards the seals and automatically lubricate them. Properly lubricated seals will run cooler and will also be more effective at sealing since any gaps between the contacts will be filled with a lubricant barrier. Proper lubrication will also reduce premature wear of the seals.</p>
26	Seals oriented in the wrong direction and not allowing grease purge	<p>Depending upon the requirements of the application, the contact seals may need to be oriented in a specific direction to allow purging of lubricant and keep out contamination, or the opposite in order to prevent oil leakage. Check with the equipment manufacturer to determine the proper orientation of the seals for the equipment. Seal lips that face outward will usually allow purging of excess lubricant and prevent ingress of external contaminants. For SKF Mounted Products, see the mounting instructions section starting on page 38.</p> 

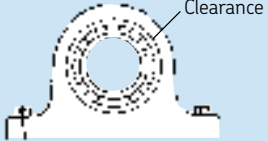
## Trouble conditions and their solutions

Solution code	Condition	Practical solution
27	Solid particle contamination entering the bearing and denting the rolling surfaces	<p>External contamination will cause surface damage to the rolling surfaces and result in increased noise, vibration, and temperature rise in some cases. The seals should be inspected and the relubrication interval may need to be shortened. Supplying smaller quantities of fresh grease on a more frequent basis will help purge contaminated grease from the bearing/housing cavity. Reference the Lubrication section on Page 87 for proper relubrication intervals and avoid over lubricating as this can lead to even a further increase in bearing operating temperature.</p> 
28	Solids left in the housing from manufacturing or previous bearing failures	<p>Particle denting can also occur as a result of solids left in the bearing housing from a previous failure. Thoroughly clean the housing before placing a new bearing in it. Remove any burrs and ensure that all machined surfaces are smooth. As with external contamination, internal contamination will also dent the rolling surfaces and result in increased noise, vibration, and temperature.</p>
29	Liquid contamination reducing the lubricant viscosity	<p>Liquid contamination will reduce the viscosity of a lubricant and permit metal-to-metal contact. In addition, corrosive etching of the rolling surfaces can also take place. These conditions will lead to increased temperature, wear, and noise. The housing seals should be checked to ensure that they are capable of preventing the ingress of liquid contamination. The relubrication interval may need to be shortened. Supplying smaller quantities of fresh grease on a more frequent basis will help purge contaminated grease from the bearing/housing cavity.</p>
30	Inner ring turning on shaft because of undersized or worn shaft	<p>When an inner ring turns relative to the shaft, increased noise can occur as well as wear. Proper performance of bearings is highly dependent on correct fits. Most applications have a rotating shaft in which the load is always directed in one direction. This is considered a rotating inner ring load and requires a press fit to prevent relative movement. See page 51 for the proper fitting practice.</p>
31	Outer ring turning in housing because of oversized or worn housing bore	<p>When an outer ring turns relative to the housing, increased noise can occur as well as wear. Proper performance of bearings is highly dependent on correct fits. Most applications have a stationary housing in which the load is always directed in one direction. This is considered a stationary outer ring load and can have a loose fit with no relative movement. See page 51 for the proper fitting practice. An unbalanced shaft load can also lead to a outer ring turning condition, even when the fits are correct. Eliminate the source of the unbalance.</p> 

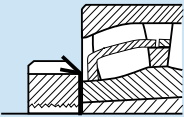
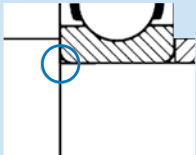
## Trouble conditions and their solutions

Solution code	Condition	Practical solution
32	Locknut is loose on the shaft or tapered sleeve	<p>A loose locknut or washer on the shaft or adapter sleeve will lead to increased noise, not to mention poor clamping and positioning of the bearing. Make sure the locknut is properly locked with the lockwasher tab when the mounting is completed. See mounting instructions starting on page 11.</p> 
33	Bearing not clamped securely against mating components	<p>A bearing that is not properly clamped against its adjacent components will cause increased noise as well as potential problems with the bearing performance. An example would be a pair of angular contact ball bearings that are not properly clamped. This would cause an increase in axial clearance in the bearing pair and potentially lead to skidding damage, noise, and lubrication problems. Not properly clamping the bearing will also effect to positioning of the shaft. Make sure the bearing is properly locked against its shaft shoulders or spacers with its locking device.</p> 
34	Too much radial/axial internal clearance in bearings	<p>Too much radial or axial clearance between the raceways and rolling elements can lead to increased noise as a result of the balls/rollers being free to move around once outside the load zone area. The use of springs or wave washers can provide adequate side load to keep the rolling elements loaded at all times. In addition to noise, too much clearance can also detrimentally effect the performance of the bearings by allowing skidding of the rolling elements.</p>
35	Rolling surfaces are dented from impact or shock loading	<p>Impact or shock load will lead to brinelling or denting of the rolling surfaces. This condition will lead to increased noise, vibration, and temperature. Review the mounting procedures and ensure that no impact is passed through the rollers. For example, if the inner ring has a press fit onto the shaft, do not apply pressure to the outer ring side face in order to push the inner ring onto the shaft. Never hammer any part of a bearing when mounting. Always use a mounting sleeve. The source of impact or shock loading needs to be identified and eliminated.</p> 

## Trouble conditions and their solutions

Solution code	Condition	Practical solution
36	Rolling surfaces are false-brinelled from static vibration	Static vibration while the equipment is not rotating will lead to false-brinelling of the rolling surfaces. This damage typically occurs at ball or roller spaced intervals and is predominantly on the raceway surfaces. This common problem leads to noise in equipment that sits idle for longer periods of time next to other equipment that is operating, i.e. back-up equipment. Periodic rotation of the shaft will help minimize the effects of the static vibration. Isolating the equipment from the vibration would be the ideal solution but isn't always realistic.
37	Rolling surfaces are spalled from fatigue	Spalling from fatigue is rare since most bearings rarely reach their design lives ( $L_{10}$ ). There is usually another condition that will lead to bearing failure such as contamination, poor lubrication, etc. Review the bearing life calculations based on the application loads and speeds.
38	Rolling surfaces are spalled from surface initiated damage	<p>Surface initiated damage includes conditions such as brinelling from impact, false brinelling from vibration, water etching, particle denting, arcing, etc. These types of conditions create surface disparities that can eventually lead to spalling. Identify the source of the condition and correct accordingly, e.g. eliminate impact through the rolling elements during mounting, replacing seals to prevent ingress of contamination, ground equipment properly, etc.</p> 
39	Static etching of rolling surface from chemical/liquid contamination (Water, acids, paints or other corrosives)	Static etching from chemical /liquid contamination typically occurs when the equipment is idle and is most common for grease lubricated bearings. The damage usually occurs at intervals equal to the rolling element spacing. For grease lubrication, more frequent relubrication with smaller quantities of grease will help flush out the contaminated grease. Also, periodic rotation of the shaft is also beneficial in minimizing the static etching damage. Improving the sealing by installing a protective shield and/or flinger to guard against foreign matter would be helpful.
40	Fluting of rolling surfaces from electric arcing	Fluting of the rolling surface is most commonly attributed to passage of electric current across the bearing. However, in some rare cases, a washboard appearance can be the result of static vibration. For electric arcing damage, grounding the equipment properly is the first recommendation. If proper grounding does not correct the problem, then alternative solutions include an insulating sleeve in the housing bore, a bearing with an insulated outer ring (SKF VL0241 suffix), or a hybrid bearing with ceramic rolling elements (SKF HC5 suffix, MRC HYB#1 suffix).
41	Pitting of rolling surfaces from moisture or electric current	Pitting of the rolling surfaces is the result of either corrosive contamination or electric pitting. Both of these conditions will cause increased noise. See solution codes 39 and 40 above.

## Trouble conditions and their solutions

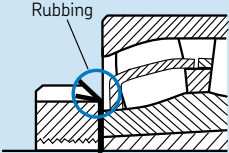
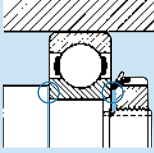
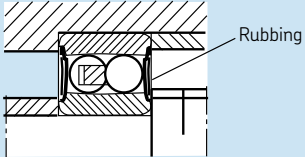
Solution code	Condition	Practical solution
42	Lockwasher tabs are bent and are rubbing against bearing seals or cage	<p>New locknuts and washers are recommended for new bearing replacements. Old lock washers may have bent tabs that can rub against the bearing cage or seals and generate noise in addition to wear. Used lock washers may also have a damaged locking tab or anti-rotation tab that isn't apparent and may shear off later.</p> 
43	Shaft and/or housing shoulders are out of square with the bearing seat	<p>Out of square shaft/housing shoulders can result in increased rotational torque as well as increased friction and heat. See also solution codes 17 and 18. Re-machine parts to obtain correct squareness. Reference page 81.</p> 
44	Shaft shoulder is too large and is rubbing against seals/shields	<p>Re-machine the shaft shoulder to clear the seals/shields. Check that the shoulder diameter is in accordance with SKF recommendations shown in the SKF General Catalog.</p> 

# Bearing damages and their causes

Rolling bearings are one of the most important components in today's high-tech machinery. When bearings fail, costly machine downtime can occur. Selecting the correct bearing for the application is only the first step to help ensure reliable equipment performance. The machine operating parameters such as loads, speed, temperature, running accuracy, and operating requirements are needed to select the correct bearing type and size from a range of products available.

The calculated life expectancy of any bearing is based on five assumptions:

1. Good lubrication in proper quantity will always be available to the bearing.
2. The bearing will be mounted correctly.
3. Dimensions of parts related to the bearing will be correct.
4. There are no defects inherent in the bearing.
5. Recommended maintenance followed.

If all of these conditions are met, then the only reason for a bearing to fail would be from material fatigue. Fatigue is the result of shear stresses cyclically applied

immediately below the load carrying surfaces and is observed as the spalling (or flaking) away of surface metal, as seen in the progression of **Figure 1** through **Figure 3**. The actual beginning of fatigue spalling is usually below the surface. The first sign is a microscopic subsurface crack, which cannot be seen nor can its effects be heard while the machine operates. By the time this subsurface crack reaches proportions shown in **Figure 2**, the condition should be audible. If the surrounding noise level is too great, a bearing's condition can be evaluated by using a vibration monitoring device, which is typically capable of detecting the spall shown in **Figure 1**. The time between beginning and advanced spalling varies with speed and load, but in any event it is typically not a sudden condition that will cause destructive failure within a matter of hours. Complete bearing failure and consequent damage to machine parts is usually avoided because of the noise the bearing will produce and the erratic performance of the shaft supported by the bearing.

Unfortunately, rarely all five conditions listed above are satisfied, allowing the bearing to achieve its design life. A common mis-

take in the field is to assume that if a bearing failed, it was because it did not have enough capacity. Because of this rationale, many people go through expensive retrofits to increase bearing capacity, and end up with additional bearing failures. Identifying the root cause of the bearing failure is the next step in ensuring reliable equipment performance. One of the most difficult tasks is identifying the primary failure mode and filtering out any secondary conditions that resulted from the primary mode of failure. This section of the Bearing Installation and Maintenance Guide will provide you with the tools to make an initial evaluation of the cause of your bearing problems.

Most bearing failures can be classified into two damage modes: pre-operational and operational. Pre-operational damage modes occur prior to or during bearing installation, while operational damage modes occur during the bearing service period.

Figure 1



Early fatigue spalling

Figure 2



More advanced spalling

Figure 3

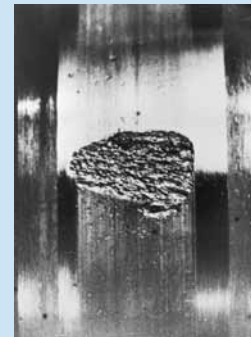

Greatly advanced spalling

### Pre-operational damage mode causes

1. Incorrect shaft and housing fits.
2. Defective bearing seats on shafts and in housings.
3. Static misalignment.
4. Faulty mounting practice.
5. Passage of electric current through the bearing.
6. Transportation and storage.

### Operational damage mode causes

7. Ineffective lubrication.
8. Ineffective sealing.
9. Static vibration.
10. Operational misalignment.
11. Passage of electric current through the bearing.

Because of the increasing attention given to rectifying bearing failures, the International Organization for Standardization (ISO) has developed a methodology for classifying bearing failures (ISO Standard 15243-2004E). This standard recognizes six primary failure modes, related to post-manufacturing sustained damage, and identifies the mechanisms involved in each type of failure (ISO terminology will be in *italic*). Most bearing damage can be linked back to the six modes shown below as well as their various subgroups. Most damage resulting

from these mechanisms is readily detected and monitored using vibration analysis and applicable devices. Thus condition monitoring techniques are vital to ensuring that bearings are removed before catastrophic damage occurs, preserving the failure evidence while preventing costly machine damage and loss of operation time.

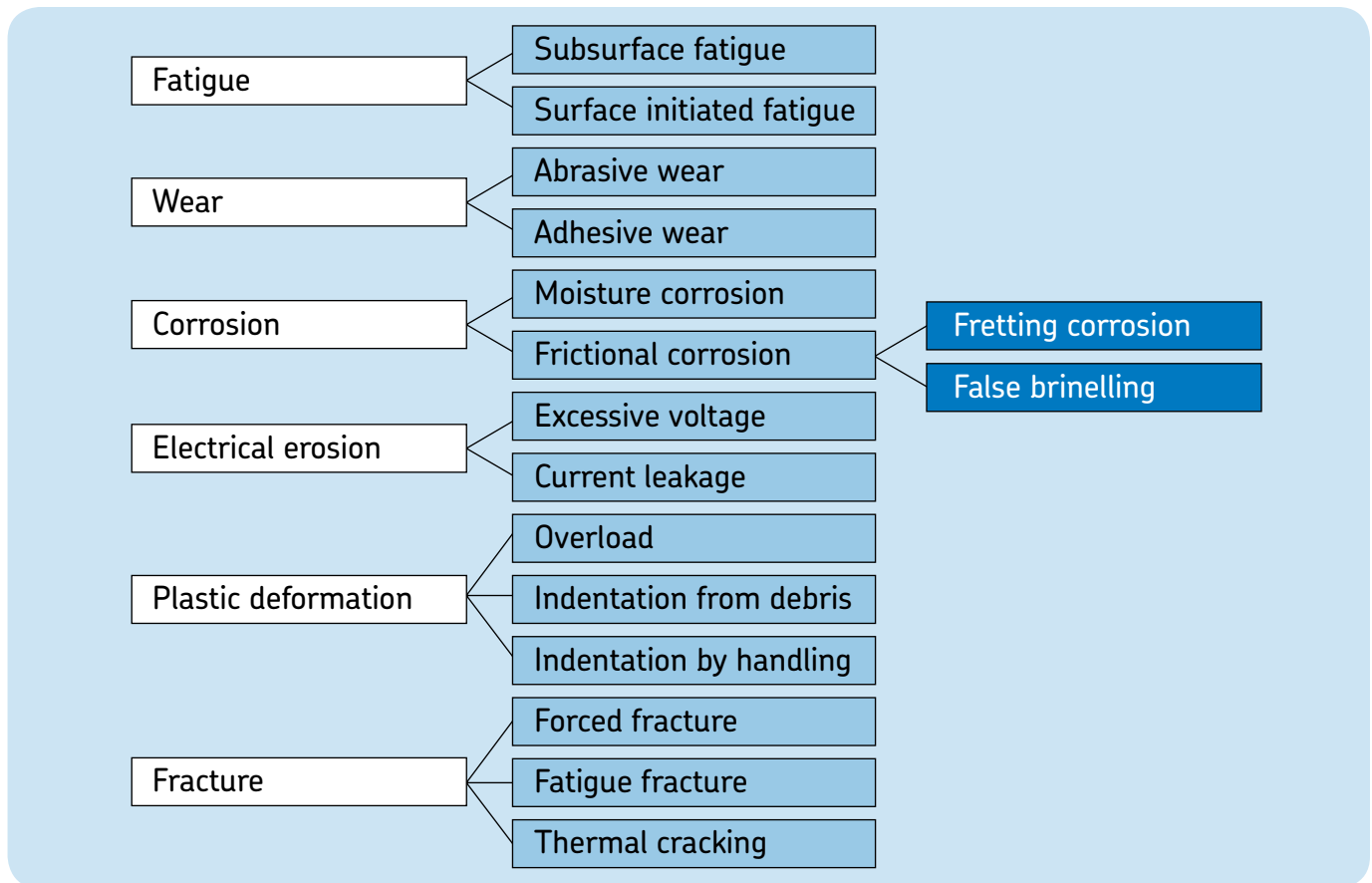



## Definitions

**Fatigue** – a change in the material structure caused by the repeated stresses developed in the contacts between the rolling elements and raceways.

**Subsurface fatigue** – the initiation of micro-cracks at a certain depth under the surface.

**Surface initiated fatigue** – flaking that originates at the rolling surfaces as opposed to subsurface.

**Wear** – the progressive removal of material resulting from the interaction of the asperities of two sliding or rolling contacting surfaces during service.

**Abrasive wear** – wear that occurs as a result of inadequate lubrication or contamination ingress.

**Adhesive wear (smearing)** – a transfer of material from one surface to another.

**Corrosion** – a chemical reaction on a metal surface.

**Moisture corrosion** – the formation of corrosion pits as a result of oxidation of the surfaces in the presence of moisture.

**Frictional corrosion (fretting corrosion)** – the oxidation and wear of surface asperities under oscillating micro-movements.

**Frictional corrosion (false brinelling)** – a formation of shallow depressions resulting from micro-movements under cyclic vibrations.

**Electrical erosion** – the removal of material from the contact surfaces caused by the passage of electric current.

**Excessive voltage (electrical pitting)** – sparking and localized heating from current passage in the contact area because of ineffective insulation.

**Current leakage (electrical fluting)** – the generation of shallow craters that develop into flutes that are equally spaced.

**Plastic deformation** – permanent deformation that occurs when the yield strength of the material is exceeded.

**Overload (true brinelling)** – the formation of shallow depressions or flutes in the raceways.

**Indents from debris** – when particles are over-rolled

**Indents from handling** – when bearing surfaces are dented or gouged by hard, sharp objects.

**Fracture** – when the ultimate tensile strength of the material is exceeded and complete separation of a part of the component occurs.

**Forced fracture** – a fracture resulting from a stress concentration in excess of the material's tensile strength.

**Fatigue fracture** – a fracture resulting from frequently exceeding the fatigue strength limit of the material.

**Thermal cracking (heat cracking)** – cracks that are generated by high frictional heating and usually occur perpendicular to the direction of the sliding motion.

## Loading patterns for bearings

Now that the six bearing failure modes and eleven pre-operational and operational causes have been defined and identified respectively, we can proceed and help you identify the cause of your specific bearing problems. The pattern or load zone produced by the applied load and the rolling elements on the internal surfaces of the bearing can be an indication of the cause of failure. However, to benefit from a study of load zones, one must be able to differentiate between normal and abnormal loading patterns.

**Figure 4** and **Figure 5** illustrate how an applied radial load of constant direction is distributed among the rolling elements of a

rotating inner ring bearing. The large arrow in the 12 o'clock position represents the applied load and the series of small arrows from 4 o'clock to 8 o'clock represent how the load is shared/supported by the rolling elements in the bearing. The rotating ring will have a rotating 360° load zone while the stationary outer ring will show a constant or stationary load zone of approximately 150°.

**Figure 6** and **Figure 7** illustrate how an applied load of constant direction is distributed among the rolling elements of a rotating outer ring bearing. The large arrow in the 12 o'clock position represents the applied load and the series of small arrows from 10 o'clock to 2 o'clock represent how the load is shared/supported by the rolling elements in the bearing. The rotating outer ring will have a rotating 360° load zone

while the stationary inner ring will show a constant or stationary load zone of approximately 150°. These load zone patterns are also expected when the inner ring rotates and the load also rotates in phase with the shaft (i.e. imbalanced or eccentric loads). Even though the inner ring is rotating, its load zone is stationary relative to the inner ring and vice versa for the outer ring.

**Figure 8** illustrates the effect of thrust load on a deep groove ball bearing load zone pattern. In addition, it also shows the effects of an excessive thrust load condition which forces the ball set to roll up towards the shoulder edge. Excessive thrust load is one condition where the load zones are a full 360° on both rings.

**Figure 9** illustrates a combination of thrust and radial load on a deep groove ball

Load distribution within a bearing

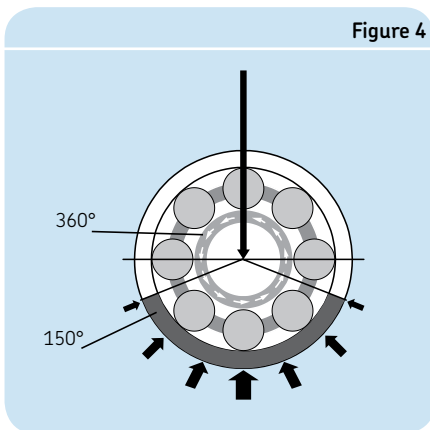

Normal load zone inner ring rotating relative to load

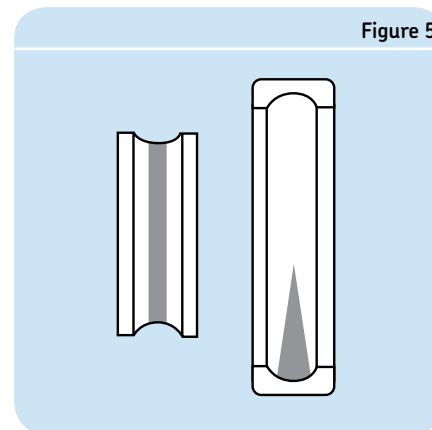

Outer ring rotating load zone, e.g. boat trailer wheel

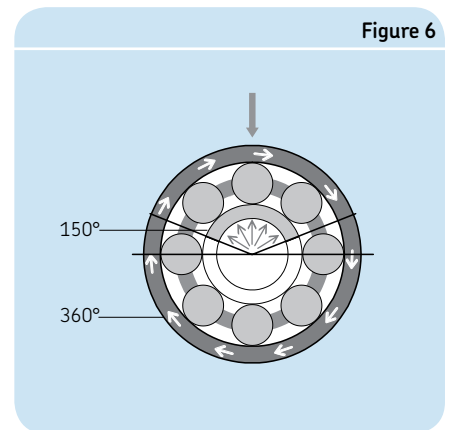

Normal load zone outer ring rotating relative to load or load rotating in phase with inner ring

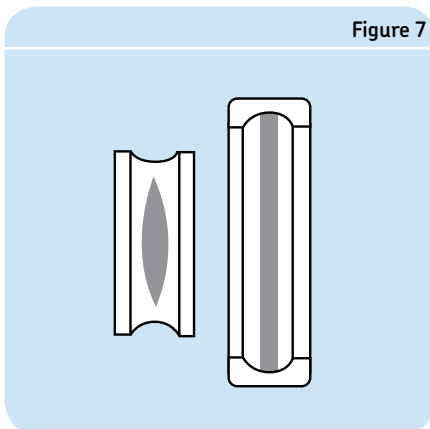

Load zone when thrust loads are excessive

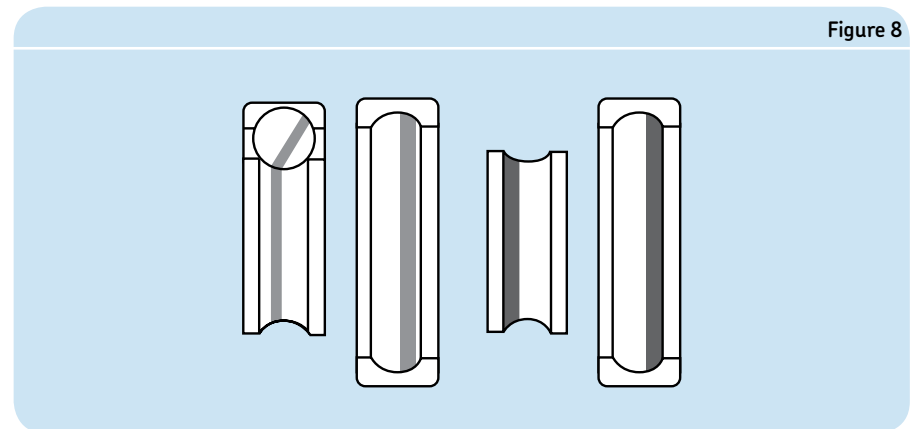

bearing. This produces a load zone pattern that is somewhere in between the two as shown. When a combined load exists, the load zone of the inner ring is slightly off center and the length of the load zone of the outer is greater than that produced by just radial load, but not necessarily 360°. For double row bearings, a combined load condition will produce load zones of unequal length. The thrust-carrying row will have a longer stationary load zone. If the thrust load is of sufficient magnitude, one row of rolling elements can become completely unloaded.

**Figure 10** illustrates an internally preloaded bearing that is supporting primarily radial load. Both rings are loaded through 360°, but the pattern will usually be wider in the stationary ring where the applied load

is combined with the internal preload. This condition can be the result of excessive interference fits on the shaft and in the housing. If the fits are too tight, the bearing can become internally preloaded by compressing the rolling elements between the two rings. Another possible cause for this condition is an excessive temperature difference between the shaft and housing. This too will significantly reduce the bearing internal clearance. Different shaft and housing materials having different thermal expansion coefficients can also contribute to this clearance reduction condition. A discussion of fitting practices appears on page 51.

**Figure 11** illustrates the load zone found in a bearing that is radially pinched. The housing bore that the bearing was mounted into was initially out-of-round or became out-of-round when the housing was bolted to a non-flat surface. In this case, the outer ring shows two load zones. However, two or more load zones are possible in some cases depending upon the chuck that holds the housing during machining. An example would be a 3-point out-of-round condition. Multiple load zones will dramatically increase the bearing operating temperature as well as the internal loads.

**Figure 12** illustrates the load zone produced when the outer ring is misaligned relative to the shaft axis. This condition can occur when the shaft deflects or if the bearings are in separate housings that do not have concentric housing bores.

Load zone when thrust loads are excessive

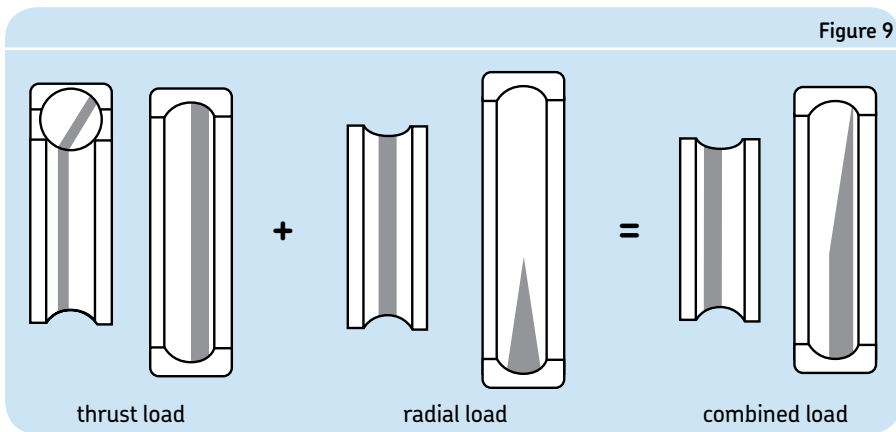

Load zone from internally preloaded bearing supporting radial load

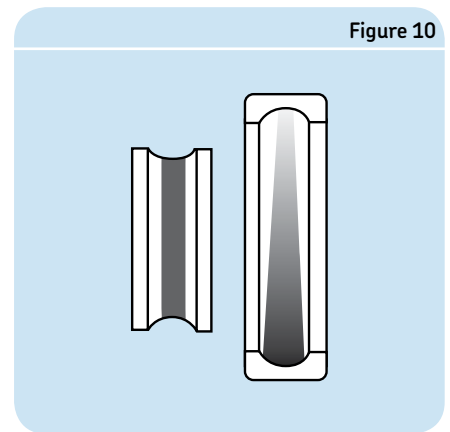

Load zones produced by out-of-round housing pinching outer ring

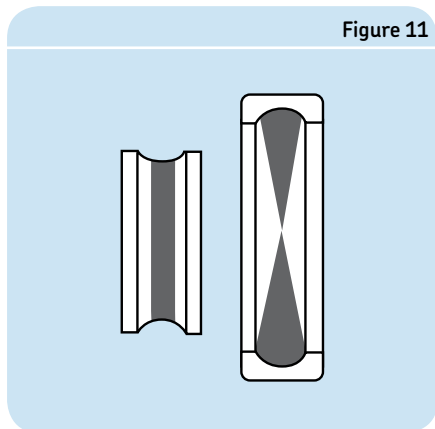

Load zone when outer ring is misaligned relative to shaft axis (e.g. shaft deflection)

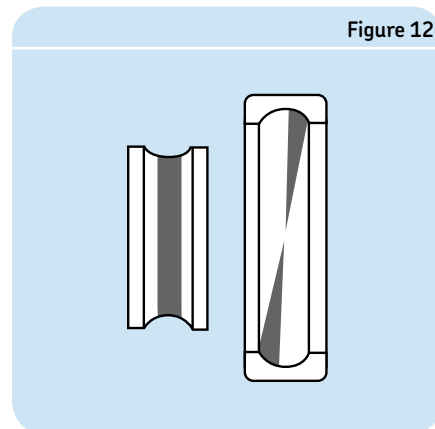

Load zones when inner ring is misaligned relative to shaft axis (e.g. bent shaft)

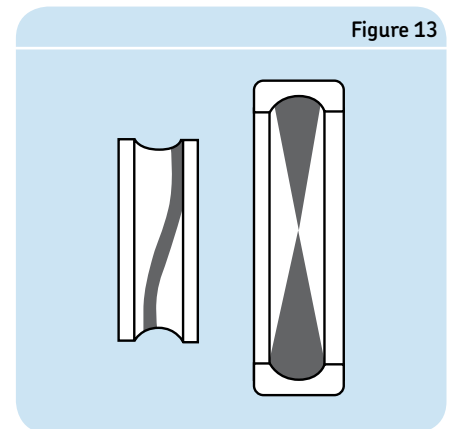

**Figure 13** illustrates the load zone produced when the inner ring is misaligned relative to the shaft axis. This condition can occur when the shaft is bent and generates what is referred to as a dynamic misalignment condition.

Being familiar with the basic load zone patterns and descriptions, the following damage mode causes should be more meaningful. As mentioned earlier, most bearing failures can be classified into two damage modes: pre-operational and operational. Pre-operational damage modes that occur prior to or during bearing installation, are discussed first.

## Pre-operational damage mode causes

### Incorrect shaft and housing fits.

If an incorrect fit is used, bearing damage can occur in several forms: fretting corrosion, cracked rings, spinning rings on their seats, reduced bearing capacity, damage from impact because of difficult mounting, parasitic loads, and excessive operating temperatures from preloading. Therefore, selection of the proper fit is critical to ensure that the bearing performs according to its intended use.

If a bearing ring rotates relative to the load direction, an interference fit is required. The degree of interference or tightness is governed by the type of bearing, magnitude of load, and speed. Typically, the heavier the applied load, the higher the required press fit. If a bearing ring is stationary relative to the load direction, it is typically fitted with

clearance or has what is referred to as a loose fit. The recommended fitting tolerances are shown in the “Shaft and housing fits” section of this catalog found on page 51.

The presence of shock load or continuous vibration calls for heavier interference fit of the ring that rotates relative to the load. In the case of a ring with a rotating load zone, lightly loaded rings, or rings that operate at extremely slow speeds may use a lighter fit or, in some cases, a slip fit. Sometimes, it is impossible to assemble a piece of equipment if the proper fitting practices are used. The bearing manufacturer should be consulted in those cases for an explanation of the potential problems that may be encountered.

Consider two examples. In an automobile front wheel, the direction of the load is constant, i.e. the pavement is always exerting an upward force on the wheel. Thus, the rotating outer rings or cups have an interference fit in the wheel hub while the stationary inner rings have a loose fit on the

*Scoring or inner ring bore caused by “creep”*

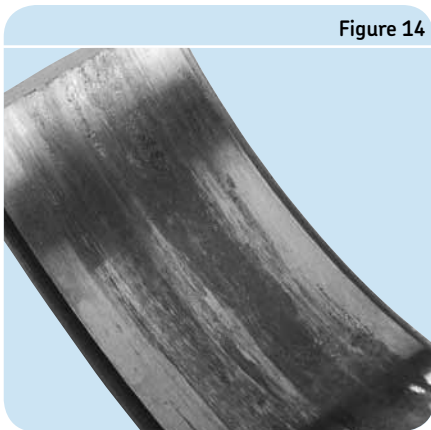

**Figure 14**

*Smearing caused by contact with the shaft shoulder while bearing ring rotated*



**Figure 15**

*Wear due to “creep”*

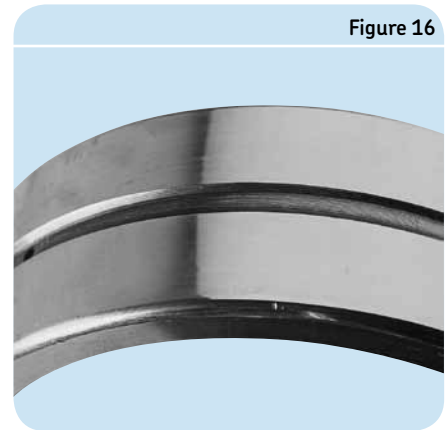

**Figure 16**

axle spindle. On the other hand, the bearings of a conventional electric motor have their outer rings stationary relative to the load and have a loose housing fit but the inner rings rotate relative to the load and are mounted with an interference fit. There are some cases where it appears necessary to mount both inner and outer rings of a bearing with interference fits due to a combination of stationary and rotating loads or loads of undetermined amounts. Such cases are designed with bearings that can allow axial expansion within the bearing itself rather than through the bearing seat. This mounting would consist of a cylindrical roller bearing, or CARB, at one end of the shaft and a shaft locating bearing at the other end.

Some examples of poor fitting follow. **Figure 14** shows the bore surface of an inner ring that has been damaged by relative movement between itself and an undersized shaft while rotating under a constant direction load. This relative move-

ment, called creep, can result in the adhesive smearing, polishing, and *fretting corrosion* shown. An improper shaft interference fit can allow creep and the damage is not always confined to the bore surface, but can have its effect on the side faces of the ring as shown in **Figure 15**. Wear between a press fitted ring and its seat is an accumulative damage. The initial *adhesive wear* accelerates and produces more wear, the ring loses adequate support, develops cracks [*fatigue fracture*], and the wear products become foreign matter that *abrasively wear* and *debris dent* the bearing internally.

Housing fits that are unnecessarily loose allow the outer ring to creep or turn resulting in wear and / or polishing of the bearing OD and housing bore. **Figure 16** is a good example of such looseness.

Excessive interference fits result in *forced fractures* by inducing dangerously high hoop stresses in the inner ring. **Figure 17** and **Figure 18** illustrate inner rings that cracked

because of excessive interference fit.

**Figure 17** is a deep groove ball bearing that was mounted on a cylindrical bearing seat and **Figure 18** is a spherical roller bearing that was driven too far up a tapered seat. The fretting corrosion in **Figure 17** covers a large portion of the surface of both the inner ring bore and the journal and was the result of the ring looseness generated by an excessive fit *force fracture*.

Inner ring fractured due to excessive hoop stress which then caused fretting

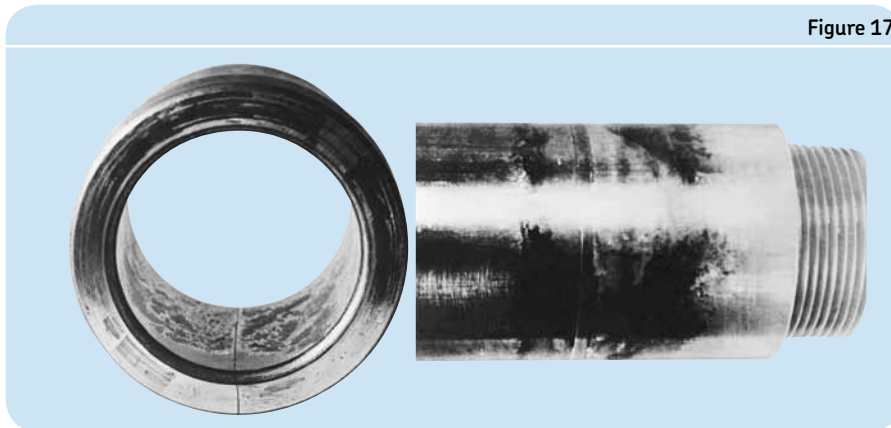

Figure 17

Axial cracks caused by an excessive interference fit



Figure 18

## Failure due to defective shaft or housing seats

The calculated life expectancy of a rolling bearing presupposes that its comparatively thin rings will be fitted on shafts or in housings that are as geometrically true as modern machine shop techniques can produce. Unfortunately, there are mitigating factors that produce shaft and housing seats that are deformed, i.e. tapered, out-of-round, out-of-square, or thermally distorted. While the incorrect shaft and housing fit section dealt with poorly selected fits, this section focuses on poorly formed bearing seats and the damage they can cause.

When the contact between a bearing and its seat is not proper, small movements due to ring flexing can produce *fretting corrosion* as shown in **Figure 19** and **Figure 20**.

*Fretting corrosion* is the mechanical wearing of surfaces other than rolling contact, resulting from movement that produces oxidation or rust colored appearance. The spalling and fracture seen in **Figure 19** was caused by the uneven support associated with the fretting. In the case of **Figure 19**, *fretting corrosion* led to spalling (*surface initiated fatigue*) and a *fatigue fracture*. *Fretting corrosion* is common in applications where machining of the seats is accurate but because of service conditions, the seats deform under load. This type of fretting corrosion on the outer ring does not, as a rule, detrimentally affect the life of the bearing.

**Figure 21** shows the condition that resulted when a cylindrical roller bearing outer ring was not fully supported, resulting

in a *surface initiated fatigue*. The impression made on the bearing O.D. by a turning chip left in the housing when the bearing was installed is seen in the left hand view. Subsequently, the entire load was concentrated over a much smaller load zone than the normal 150° load zone. Premature raceway spalling resulted as seen in the right-hand view, i.e. the OD chip mark is on the O.D. of the outer ring with the spalling. On both sides of the spalled area there is fragment denting (*indentation from debris*), which occurred when spalling fragments were trapped between the rollers and the raceway.

Wear due to fretting corrosion



Advanced wear and cracking due to fretting corrosion



Fatigue from chip in housing bore

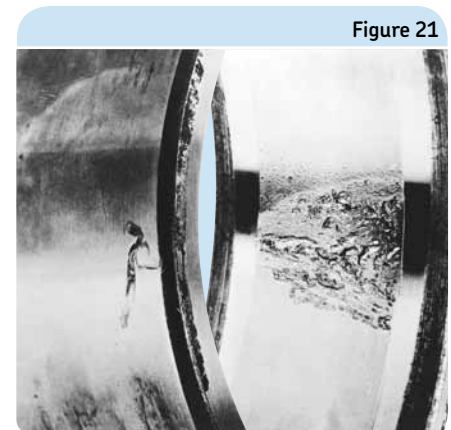

Cracks caused by faulty housing fit



Mirror view shows how raceway is affected by out-of-round housing

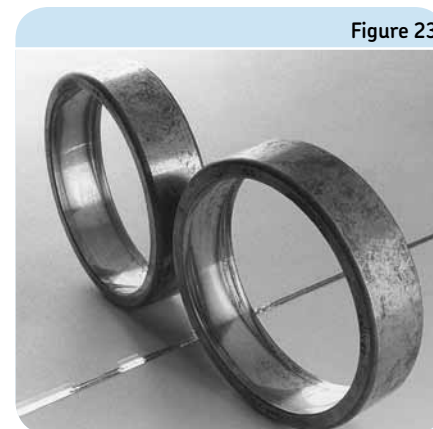

Spalling from parasitic thrust

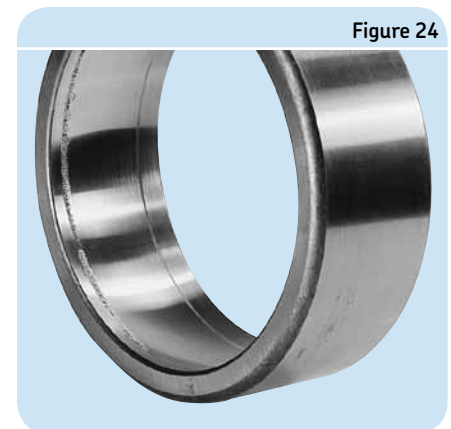

Bearing seats that are concave, convex, or tapered cause a bearing ring to make poor contact across its width. The ring therefore deflects under load and *fatigue fractures* commonly appear circumferentially along the raceway. Cracks caused by faulty contact between a ring and a poorly formed housing are shown in **Figure 22**.

**Figure 23** is a mirror picture of a self-aligning ball bearing outer ring mounted in an out-of-round housing bore. The stationary outer ring was pinched in two places – 180° apart - resulting in preload at these two locations. The preload generated excessive forces and heat and rendered the lubricant ineffective, resulting in *adhesive wear*.

## Static misalignment

Misalignment is a common source of overheating and/or premature spalling. Misalignment occurs when an inner ring is seated against a shaft shoulder that is not square with the journal seat, when a housing shoulder is out-of-square with the housing bore, and when two housing bores are not concentric or coaxial. A bearing ring can be misaligned when not pressed fitted properly against its shoulder and left cocked on its seat. Likewise, bearing outer rings in slip-fitted housings that are cocked across their opposite corners can also result in misalignment. Using self-aligning bearings does not necessarily cure some of the foregoing misalignment faults. For example, when the inner ring of a self-aligning

bearing is not square with its shaft seat, it will wobble as it rotates. This condition is referred to as a dynamic misalignment and results in smearing and early fatigue. When a normally floating outer ring is cocked in its housing across corners, it can become axially held in its housing and not float properly with the shaft, resulting in parasitic thrust. The effect of parasitic thrust creates an overload that results in excessive forces and temperature, rendering the lubricant inadequate and resulting in *adhesive wear*.

**Figure 24** shows the result of such thrusting in a self-aligning ball bearing.

Ball thrust bearings suffer early fatigue when mounted on supports that are not perpendicular because only one short section (*arc*) of the stationary ring carries the

Smearing in a ball thrust bearing

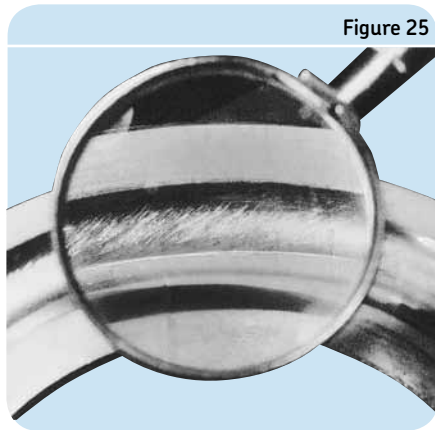

Figure 25

Fatigue caused by edge loading



Figure 26

Advanced spalling caused by edge-loading

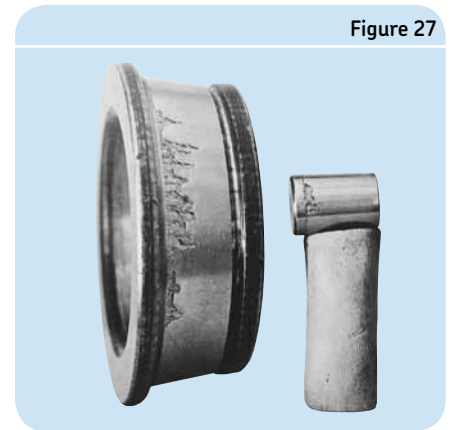

Figure 27

Fatigue caused by impact damage during handling or mounting

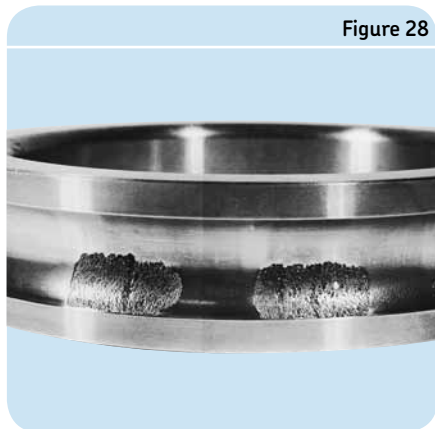

Figure 28

Smearing caused by excessive force in mounting



Figure 29

Smearing, enlarged 8X from Figure 29

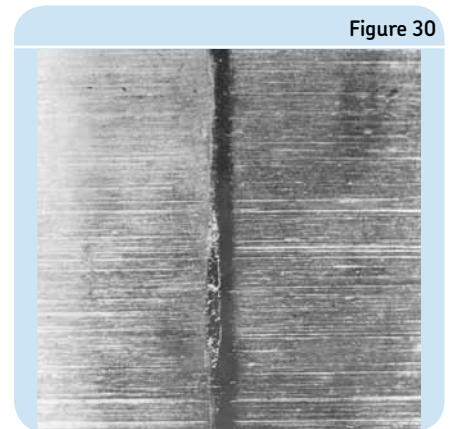

Figure 30

entire load. When the rotating ring of the ball thrust bearing is mounted on an out-of-square shaft shoulder, the ring wobbles as it rotates. The wobbling rotating ring loads only a small portion of the stationary ring and causes early fatigue. **Figure 25** illustrates “skid” smearing (*adhesive wear*) within a ball thrust bearing when the two rings are either not parallel to each other or if the load is insufficient at the operating speed. If the rings are parallel to each other but the speed is too high in relation to the load, centrifugal force causes the balls to spin instead of roll at their contact with the raceway and subsequent skidding (*adhesive wear*) results. Smearing from misalignment will be localized in one zone of the stationary ring whereas smearing from gyroscopic forces will be evenly distributed around both rings.

Where two housings supporting the same shaft do not have a common center line, only self-aligning ball or roller bearings will be able to function without inducing bending

moments. Cylindrical and taper roller bearings can accommodate only very small misalignments – even if crowned – and if appreciable, edge loading results, a source of premature fatigue. Edge loading from housing misalignment was responsible for the spalling in the bearing ring shown in **Figure 26**. Advanced spalling due to the inner ring deflection misalignment is seen on the inner ring and a roller of the tapered roller bearing in **Figure 27**. **Tables 7 through 9** (beginning on page 57) provide guidelines for the proper tolerancing of shaft and housing components to prevent the above described fitting and form issues.

## Faulty mounting practices

Premature fatigue and other failures are often due to abuse and neglect before and during mounting. Prominent among causes of early fatigue is the presence of foreign matter in the bearing and its housing during operation. The effect of trapping a chip between the O.D. of the bearing and the bore of the housing was shown in **Figure 15**. Impact damage during handling, mounting, storage, and/or operation results in brinell depressions that become the start of premature fatigue. An example of this is shown in **Figure 28**, where the spacing of spalling, caused by *overload plastic deformation*, corresponds to the normal distance between the balls.

Cylindrical roller bearings are easily damaged during mounting, especially when the shaft-mounted inner ring is assembled into the stationary outer ring and roller set. **Figure 29** shows such axial *indentation by handling* caused by the rollers sliding forcibly across the inner ring during assembly. Here again the spacing of the damage is equally spaced with respect to the normal distance between rollers. One of the smeared streaks in **Figure 29** is shown enlarged 8X in **Figure 30**.

Spalling from excessive thrust

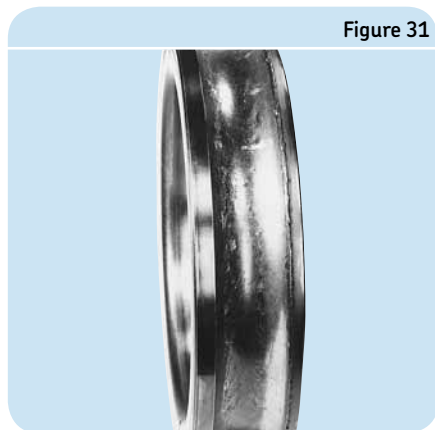

Figure 31

Electric pitting on surface of spherical outer raceway caused by passage of relatively large current

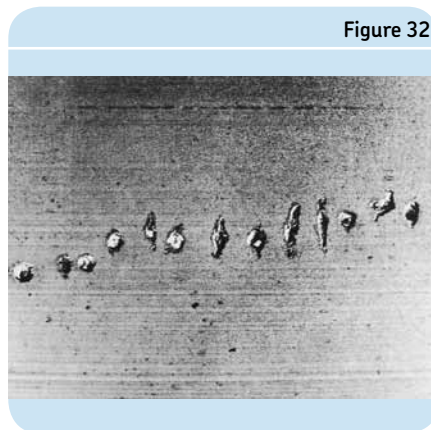

Figure 32

Electric pitting on surface of spherical roller caused by passage of relatively large current

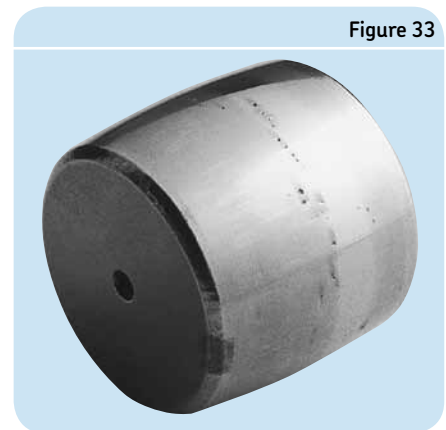

Figure 33



Bearings subjected to loads greater than those calculated to arrive at the life expectancy, will fatigue prematurely. Unanticipated parasitic loads can arise from faulty mounting practice. An example of parasitic load can be found in the procedure of mounting the front wheel of a mining truck. If the locknut is not backed off after the specific torque to seat the bearing is applied, parasitic load may result. Another example would be any application where a bearing should be free in its housing, but because of pinching or cocking, it cannot move with thermal expansion. **Figure 31** shows the effect of a parasitic thrust load. The damaged area is not in the center of the ball groove as it should be, but is high on the shoulder of the groove.

### Passage of excessive electric voltage through bearings (pre-operational)

In certain machinery applications, there is the possibility that electric potential will pass through a bearing seeking ground. For example, when repairing a shaft, excessive voltage potentials can result from improperly grounding the welding equipment so that the resulting current passes through the bearing to ground. As electricity arcs from the bearing rings to the rolling elements severe damage occurs. **Figure 32** and **Figure 33** show such excessive voltage (arc welding) damage on the raceway and roller surfaces of a rotating spherical roller bearing. Although this type of damage is classified as pre-operational, this type of damage typically occurs during operation.

### Transportation and storage damage

Damages typically associated with transportation include brinelling (*overload*) from shock loading or *false-brinelling* from vibration. Shock loading from improper handling of the equipment results in brinelling damage at ball/roller spaced intervals. Such *overload* marks increase noise and vibration depending upon the severity of the damage. Since a brinell is the result of an impact, the original grinding lines are still intact and visible under magnification. **Figure 34** is a 100X magnification of a brinell mark.

*False-brinelling* damage also occurs at ball/roller spaced intervals as shown in **Figure 35**. However, since it is caused by vibration, when looked at under magnification, the grinding lines are no longer present, as shown in **Figure 36**. False brinelling will also lead to increased noise and vibration depending upon the severity.

Example of true brinelling—100X

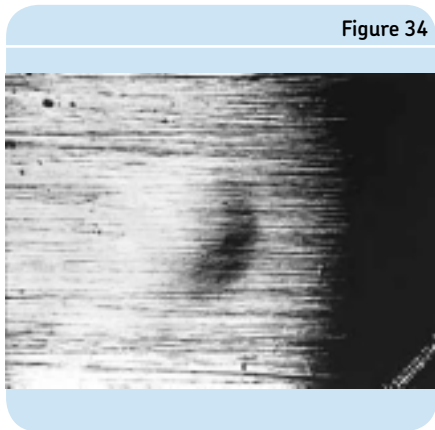

False brinelling caused by vibration with bearing stationary

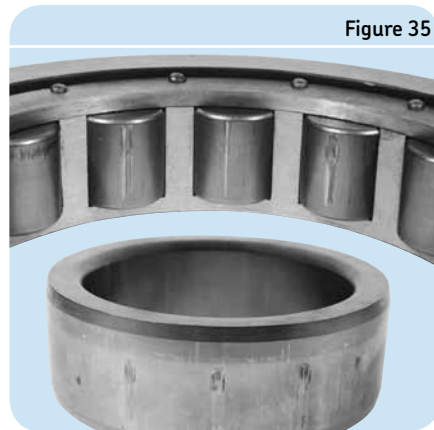

Example of false brinelling—100X

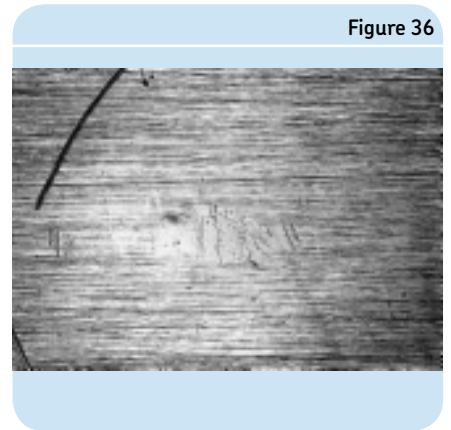
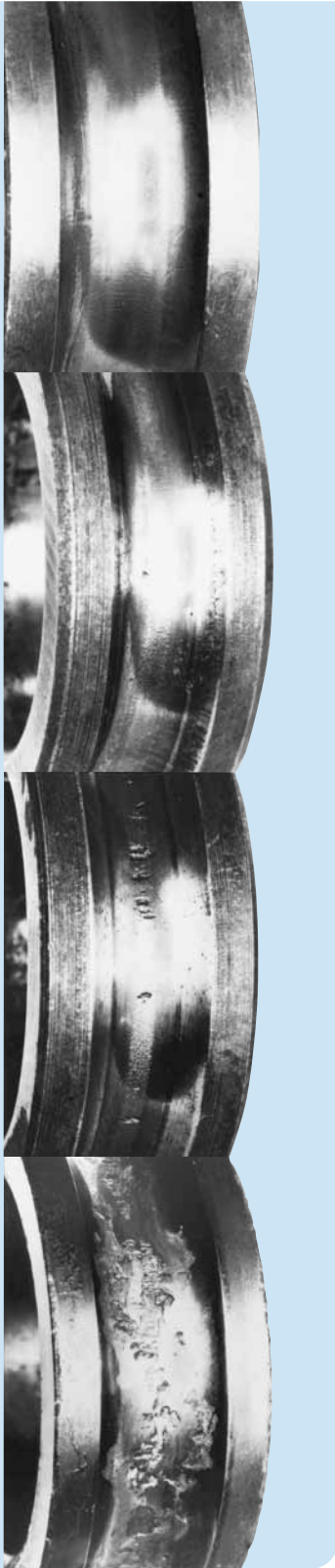

Figure 37



## Operational damage mode causes

### Ineffective lubrication

One of the primary assumptions made in the calculated life expectancy of a bearing is that of adequate lubrication, i.e. lubricant in the correct quantity and type. All bearings require lubrication for reliable operation. The lubricant separates the rolling elements, cage and raceways, in both the rolling and the sliding regions of contact. Without effective lubrication, metal-to-metal contact occurs between the rolling elements and the raceways, causing wear of the internal rolling surfaces.

The term “lubrication failure” is too often taken to imply that there was no oil or grease in the bearing. While this does happen occasionally, a bearing damage analysis is normally not that simple. Many cases suffer from insufficient lubricant viscosity, excessive lubricant viscosity, over-lubrication, contamination of the lubricant and inadequate quantity of lubrication. Thus a thorough examination of the lubricant’s

properties, the amount of lubricant applied to the bearing, and the operating conditions are pertinent to any lubrication damage analysis.

When lubrication is ineffective, *abrasive* and *adhesive wear* surface damage results. This damage progresses rapidly to failures that are often difficult to differentiate from a failure due to material fatigue or spalling. Spalling will occur and often destroy the evidence of inadequate lubrication. However, if caught soon enough, indications that pinpoint the real cause of the short bearing life can be found. Stages of *abrasive wear* due to inadequate lubrication are shown in **Figure 37**. The first visible indication of trouble is usually a fine roughening or waviness on the surface. Later, fine cracks develop, followed by spalling. If there is insufficient heat removal, the temperature may rise high enough to cause discoloration and softening of the hardened bearing steel. This happened to the bearing shown in **Figure 38**.

Figure 38

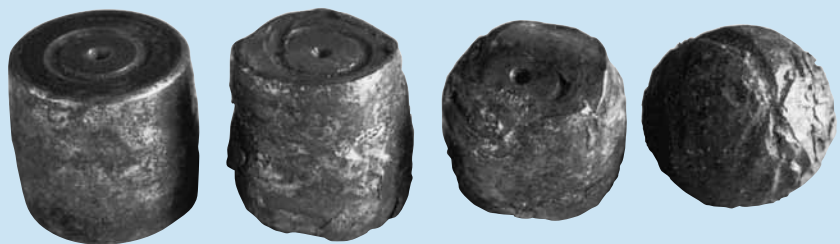

Progressive stages of spalling caused by inadequate lubrication

Discoloration and softening of metal caused by inadequate lubrication and excessive heat

In some cases, inadequate lubrication initially appears as a highly glazed or glossy surface (*abrasive wear*), which, as damage progresses, takes on a “frosty” appearance (*adhesive wear*) and eventually spalls (*surface initiated fatigue*). An example of a highly glazed surface is shown in **Figure 39**.

In the frosting stage, it is sometimes possible to feel the “nap” of fine slivers of metal pulled from the bearing raceway by the rolling element. The frosted area will feel smooth in one direction, but have distinct roughness in the other. As metal is pulled

from the surface, pits appear and frosting advances to pulling as shown in **Figure 40**.

Another form of surface damage is called smearing (*adhesive wear*). It occurs when two surfaces slide and the lubricant cannot prevent adhesion of the surfaces. Minute pieces of one surface are torn away and re-welded to either surface. Examples are shown in **Figures 41** through **44**. Areas subject to sliding friction such as locating flanges and the ends of rollers in a roller bearing are usually the first parts to be affected.

Glazing by inadequate lubrication

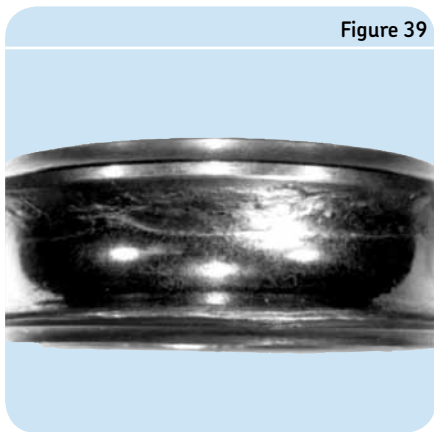

Figure 39

Effects of rollers pulling metal from the bearing raceway (frosting)

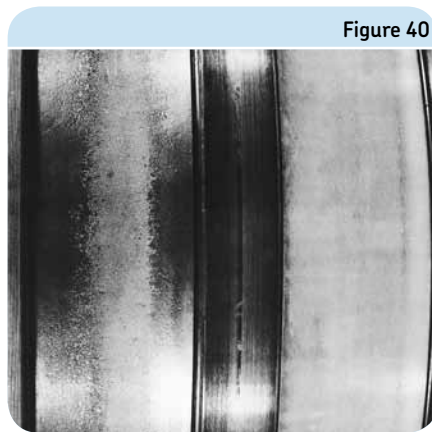

Figure 40

Smearing on spherical roller end

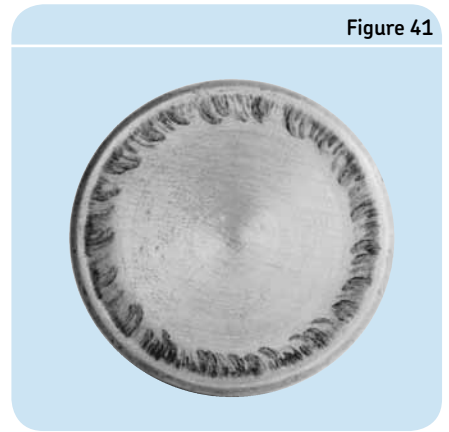

Figure 41

Smearing on spherical roller caused by ineffective lubrication

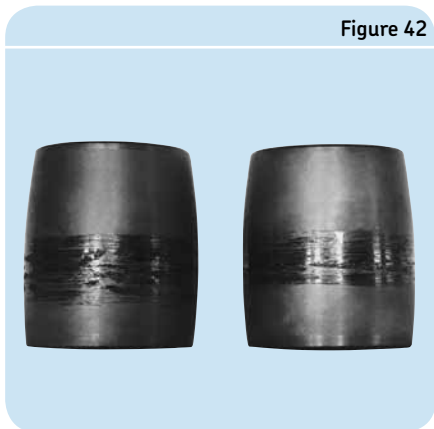

Figure 42

Smearing on cage pockets caused by ineffective lubrication

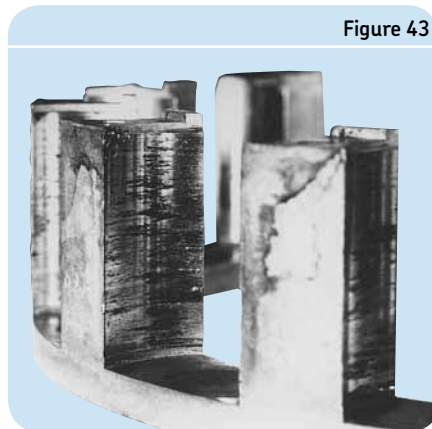

Figure 43

Smearing on inner ring of spherical roller bearing

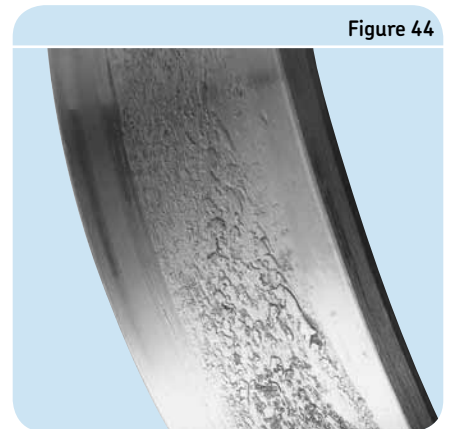

Figure 44

Another type of smearing is referred to as “skid-smearing”. This condition occurs when rolling elements slide as they pass from the unloaded to the loaded zone in bearings that may have insufficient load, a lubricant that is too stiff, excessive clearance, and or insufficient lubrication in the load zone. **Figure 45** exhibits patches of skid-smearing, one in each row of a spherical roller bearing.

Wear of the bearing as a whole also results from inadequate lubrication. **Figure 46** and **Figure 47** illustrate such damage.

**Figure 48** shows a large bore tapered roller bearing that failed due to an insufficient flow of circulating oil. The area between the guide flange and the large end of the roller is subjected to sliding motion, which as mentioned previously, is the first area to be effected during periods of inadequate lubrication. The heat generated at the flange caused the discoloration of the bearing and resulted in some of the rollers being welded to the guide flange. Information on how to select the proper oil viscosity can be found in the Lubrication section of this catalog on page 88 or at the Calculations section, on the “Services” page of [www.skf.com](http://www.skf.com).

### Ineffective sealing

Bearing manufacturers realize the damaging effects of dirt and take extreme precautions to deliver clean bearings. Freedom from abrasive matter is so important that some bearings are assembled in air-conditioned clean rooms. **Figure 49** shows the inner ring of a bearing where large, tough, soft foreign matter (such as steel or paper debris) was trapped between the raceway and the rollers causing *plastic deformation* depressions known as particle denting. When spalling debris causes this condition,

Skid smearing on spherical outer raceway

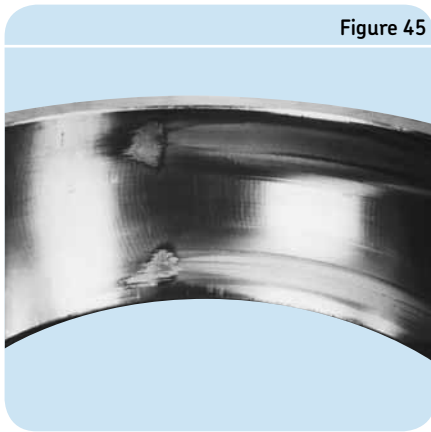

Figure 45

Grooves caused by wear due to inadequate lubrication

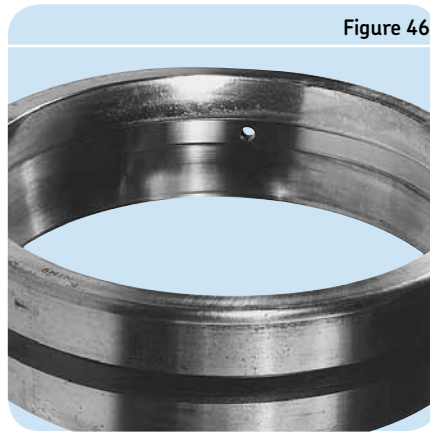

Figure 46

Grooves caused by wear due to inadequate lubrication



Figure 47

Roller welded to rib because of ineffective lubrication

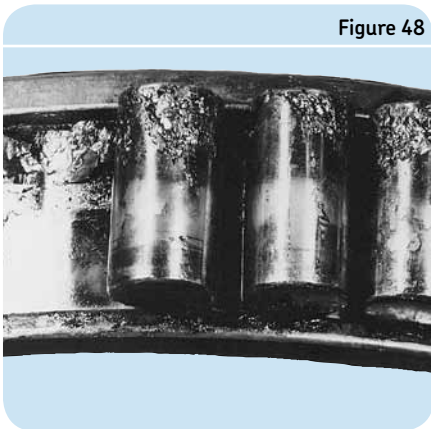

Figure 48

Fragment denting

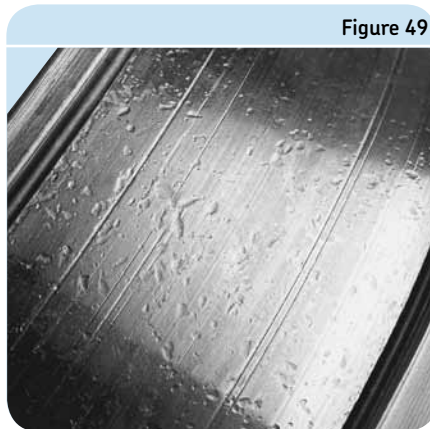

Figure 49

Advanced abrasive wear



Figure 50

it is typically called fragment denting. Each of these small dents is the potential start of premature fatigue. Small hard particles of foreign matter cause *abrasive wear*, and when the original internal geometry is changed significantly, the calculated life expectancy will not be achieved. In addition to reduced life, the accuracy of the bearing is greatly reduced, which can also cause equipment problems with positioning. Dramatic examples of abrasive wear and moisture corrosion, both due to ineffective sealing, are shown in **Figure 50** and **Figure 51**.

**Figure 52** shows a deep groove ball bearing where the balls have worn to such an extent due to abrasive particles that they no longer support the cage, allowing it to rub on the lands of both rings.

In addition to abrasive matter, corrosive agents should be excluded from bearings as well. Water, acid, and many cleaning agents deteriorate lubricants resulting in corrosion. Acids form in the lubricant in the presence of excessive moisture and etch the surface black as shown in **Figures 53** through **55**.

The corroded areas on the rollers of **Figure 56** occurred while the bearing was not rotating. A combination of abrasive contamination and vibration in the rolling bearing can be seen in the wavy pattern shown in **Figure 57**. When the waves are more closely spaced, the pattern is called fluting and appears similar to cases that will be shown in section "Passage of electric current through the bearing" on page 133.

*Advanced abrasive wear*



**Figure 51**

*Advanced abrasive wear*

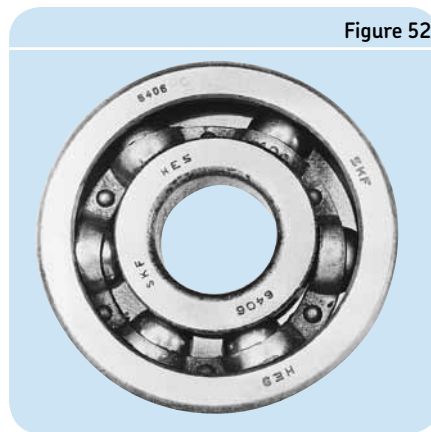

**Figure 52**

*Rust on end of roller caused by moisture in lubricant*



**Figure 53**

*Corrosion streaks caused by water in the lubricant while the bearing rotated*



**Figure 54**

*Corrosion of roller surface caused by formation of acids in lubrication with some moisture present*



**Figure 55**

*Corrosion on roller surface caused by water in lubricant while bearing was standing still*



**Figure 56**

## Static vibration

As with those damages that occur during transportation and storage, bearings do not have to be rotating to be damaged in an application. In cases where a vital piece of equipment has a back-up unit standing by, damage from transient vibrations is caused by moving machinery. Depending on the proximity of the idle unit to the operating one(s), vibrations created from the running equipment cause the rolling elements in the bearing of the static machine to vibrate. These movements of the rolling elements on the raceway create a condition referred to as *false brinelling*, a wearing away of the raceway surface in an oblong or circular shape. When the stand-by equipment is finally put into service, the bearings are usually noisy and require replacement.

## Operational misalignment

Misalignments that occur during operation are indicated by the bearing similarly to those produced by static misalignment; i.e. load zones that are not parallel to the raceway grooves. Although these causes can in some instances be detected prior to operation (as is the case of a permanently bent shaft), detection is not always possible. Additional causes of operational misalignment are shafts which deflect due to a loading condition change during operation, such as in belt re-tensioning or situations where a radial imbalance creates shaft deflections at operating speed.

As mentioned earlier in the “Loading patterns for bearings” section, static and dynamic misalignment have two different effects on bearings. Static is a one-time misalignment that occurs and remains constant throughout the operation of the equipment. An example would be a shaft that is deflected under load. The axis of the

inner ring is constant relative to the outer ring and therefore the loading pattern shown in **Figure 12** (page 121) would occur. This condition causes higher internal loads as well as increased temperatures because of the additional load zone in the outer ring. However, in the case of a dynamic misalignment, the rotational axis of the inner ring is constantly changing relative to the outer ring and therefore the loading pattern shown in **Figure 13** (page 121) would occur. An example would be a permanently bent shaft. As the horizontal shaft rotates, the inner ring of the bearing moves from side to side through each revolution. This condition causes the same increase in internal loads and operating temperatures as a static misalignment, but in addition sliding friction is introduced into the bearing and additional heat and wear can occur.

*False brinelling caused by vibration in presence of abrasive dirt while bearing was rotating*

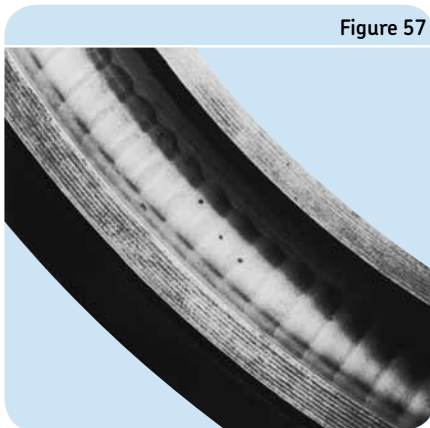

**Figure 57**

*Fluting on raceway of ball bearing caused by prolonged passage of relatively small electric current*

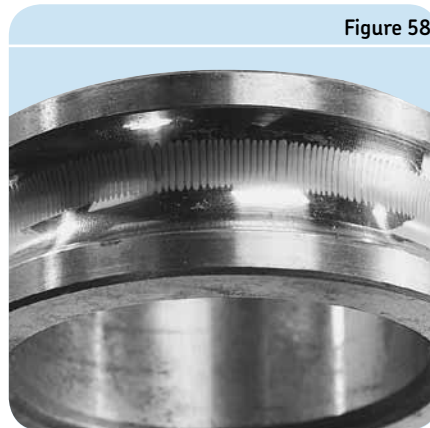

**Figure 58**

*Fluting on surface of spherical roller caused by prolonged passage of electric current*

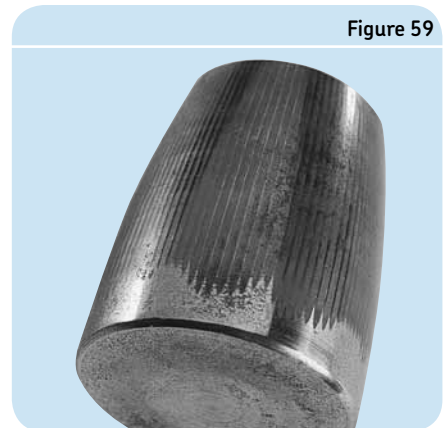

**Figure 59**

## Passage of electric current through the bearing

Passage of excessive voltage during pre-operation was discussed in the section “Passage of excessive electric voltage through bearings (pre-operational)” on page 127 and was basically limited to improper grounding during welding. However, one possible way for electric currents to develop is by static electricity emanating from charged belts or from manufacturing processes involving leather, paper, cloth or rubber. This current will pass through the shaft and through the bearing to ground. When the current bridges the lubrication film between the rolling elements and raceways, microscopic arcing results. This produces very localized and extreme temperatures that melt the crossover point. The overall damage to the bearing is in proportion to the number and size of individual damage points.

*Electrical erosion* fluting due to *current leakage* occurs when these moderate voltage small currents arc over during prolonged periods and the microscopic pits accumulate drastically. The result is shown in **Figures 58** through **60**. This condition can

occur in ball or roller bearings. Flutes can develop considerable depth, producing noise and vibration during operation and eventual fatigue. Individual electric marks, pits, and fluting have been produced in test bearings. Both alternating and direct current can cause *electric erosion*, but through different mechanisms.

Other than the obvious fluting pattern on the rings and rollers of the bearings shown below, there is one other sign of current leakage that can occur. A darkened gray matte discoloration of the rolling elements and a very fine darkened gray matte discolored load zone can potentially point to an electric discharge problem. The remainder of the bearing surfaces are normal and do not exhibit any discoloration. **Figure 61** is an example of a ball from a standard deep groove ball bearing and a ball that has been exposed to electric discharge. See SKF INSOCOAT® and Hybrid bearings for solutions to arcing problems at [www.skf.com](http://www.skf.com).

Fluting on inner raceway

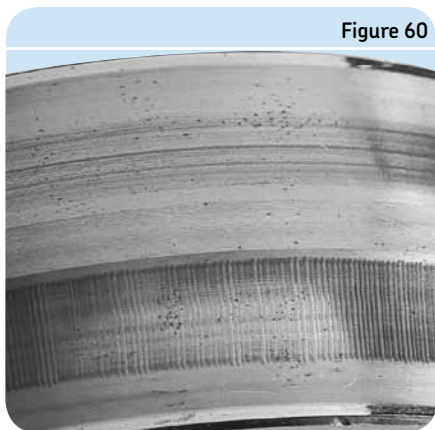

Figure 60

Arcing damage ball versus standard ball

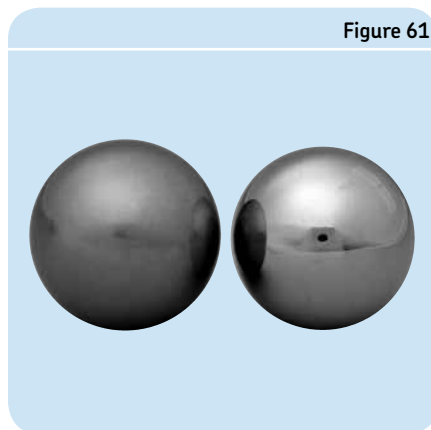

Figure 61

## SKF damage analysis service

Bearing damage analysis provides insight into equipment operation and bearing damage. Evidence needs to be collected and interpreted correctly to establish exactly what occurred and to reveal what was responsible for it. Knowledge and experience are required to separate useful information from false or misleading clues. This is why SKF offers professional damage analysis support.

A standard damage analysis establishes the likely cause of bearing damage based on visual examination and a limited application review. A Bearing Damage Analysis report, containing conclusions and recommendations to prevent future failures, is issued to the customer by SKF Engineers. Observations that led to the conclusions are documented in the report along with photographs of significant evidence. The reports draw upon SKF's extensive bearing failure knowledge and application experience.

Advanced damage analysis support is also available through SKF. The technical competence and capabilities of the SKF North American Technical Center (NATC) can be used to support high level bearing failure investigations. SKF Engineers couple the NATC's findings with a detailed application review to provide the most conclusive report possible on the bearing damage and potential solutions.

Please contact your local SKF Authorized Distributors for further information on bearing analysis.





# Additional resources

## Maintenance and lubrication products

SKF develops and markets maintenance tools, lubricants and lubricators to optimize mounting, dismounting and lubrication of bearings. The product assortment includes mechanical tools, heaters, oil injection equipment, instruments, lubricants and lubricators.

### Mechanical tools

Mechanical tools are used mainly for mounting and dismounting small and medium-sized bearings. The SKF range comprises tools for the installation and removal of bearings and locking devices.

- Hook and impact spanners
- Lock nut spanners and axial lock nut sockets
- Bearing fitting tools
- Jaw pullers
- Strong back pullers
- Internal and blind pullers



*Jaw pullers*

## Lubricants and lubricators

The formulation of all SKF bearing greases is based on extensive research, grease performance testing and field experience. SKF developed many of the internationally accepted bearing-related grease testing parameters. For correct lubricant application, a range of lubrication equipment is available from SKF.

- Greases
- Grease guns and pumps
- Grease meter
- SYSTEM 24<sup>®</sup> single point automatic lubricator
- SYSTEM MultiPoint<sup>®</sup> automatic lubricator
- Oil leveller

## Hydraulic tools

A variety of hydraulic tools is available to mount and dismount bearings in a safe and controlled manner. The SKF oil injection method enables easy working while the SKF Drive-up Method provides accurate results.

- Hydraulic nuts
- Hydraulic pumps and oil injectors
- Hydraulic accessories



*Hydraulic pumps*

## Instruments

To realize maximum bearing life, it is important to determine the operating condition of machinery and their bearings. With the SKF measuring instrument range, critical environmental conditions can be analyzed to achieve optimum bearing performance.

- Tachometers
- Thermometers
- Electronic stethoscope
- Oil check monitor
- Alignment instruments and shims
- Thermal cameras

## Bearing heaters

A fast and very efficient way to heat a bearing for mounting is to use an induction heater. These heaters, which only heat metallic components, control bearing temperature safely and accurately, to minimize the risk of bearing damage caused by excessive heat.

- Induction heaters
- Portable induction heaters
- Hot plates
- Heating devices to remove inner rings
- Gloves

For additional information on SKF Maintenance Products, please visit [www.mapro.skf.com](http://www.mapro.skf.com) or order catalog MP/P1 03000.



*Shaft alignment tool*

# Reliability Maintenance Institute®

## Training to get more from your machines

Delivering the highest quality goods at the best value requires highly skilled employees and optimum machine reliability. Meeting increasingly stringent safety and environmental regulations can also affect your operational costs. These factors make maximizing machine reliability and maintenance costs crucial. But training your team on these critical skills as they juggle daily tasks is difficult at best. With Reliability Maintenance Institute (RMI) courses from SKF, it's never been easier.

## World-class maintenance and reliability instruction

SKF offers a comprehensive suite of RMI training courses designed to help plants reduce machinery problems and achieve maximum reliability and productivity. Offered by skill level and structured to reflect the SKF Asset Efficiency Optimization workflow process, the training covers most aspects of machine maintenance and reliability, from bearing basics and lubrication to maintenance strategy and asset management.



## Why SKF for reliability maintenance training?

Because SKF Reliability Maintenance Institute courses are backed by 100 years of experience and knowledge of rotating machine reliability that is unmatched in the world. Close working partnerships with our clients have given us a unique and intimate understanding of the processes and challenges specific to every major industry, from paper, power and petroleum, to metals, mining and food processing. And as a technical partner to original equipment manufacturers worldwide, we likely have had a role in the design of machinery in your plant.

This extensive expertise forms both our Asset Efficiency Optimization workflow concept and our comprehensive training courses, which cover every aspect of machine reliability, from the shop floor to executive offices. No matter what industry you're in or what machinery you use, SKF can show you how to maintain and manage your assets more productively.

## Training options

The Reliability Maintenance Institute (RMI) can work with you to arrange a training program that is convenient for you. From asset management to basic maintenance skills, RMI can develop a solution for you and your team. We have a full schedule of training courses held at a variety of locations across the country—or we can bring our classes to you!



## RMI classroom

Traditional RMI classroom courses are offered at the two full-time SKF training centers located in Norristown, PA – approximately 20 miles outside of Philadelphia – and San Diego, CA. Courses held in Norristown are at the SKF USA Inc. headquarters. Classes held in San Diego are in the SKF Reliability Systems complex and include a tour of the facility in which condition monitoring equipment is designed and manufactured.

## RMI regional classroom

RMI public courses are also offered regionally across the country at locations that vary from year to year. If there is not a course scheduled in your neighborhood, or if you have several plant locations in a certain area, we can arrange a regional class for your part of the country.

## On-site classroom courses

All RMI classroom courses can be held on-site in your plant at any time. On-site training brings the instructor and the expertise directly into your plant so you can apply the training directly to your equipment.

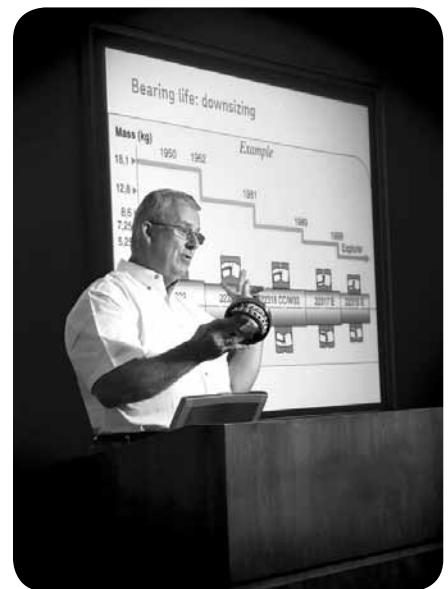

## On-site customized training

If you have a training need that doesn't fit a particular RMI course or program description, the RMI can create a custom training program for you. For employee skills, process or equipment training, RMI specialists will perform job, task and skills analysis to determine training needs, develop course materials and delivery methods and implement the training on your schedule. Custom courses can be taught by a qualified RMI instructor, or we can train your trainer to teach the material supplied by the RMI.

## Performance support

Periodic training enhances employee performance and ensures that the most current practices are being properly applied in the field. RMI Performance Support systems can be used for instructor/mentored training, self-directed training, and for training needs assessments. Complete packages consist of tools, demonstration units, comprehensive instructions for proper use and application, and assessment testing procedures. Packages are tailored to client's specific machinery types and maintenance practices. Contact RMI and we will evaluate your needs and design a performance support system to meet your training requirements.



## SmartStart™ on-site product start-up training

SmartStart is an on-site product start-up service that focuses on a specific product and is designed to get that product up and running, your employees trained, and your program implemented quickly and effectively. The training takes the form of mentoring rather than classroom instruction, and the site instructor will offer guidance in applicable product and/or database optimization and functionality.

## SiteMentor on-site training

Training can be brought directly to your employees at your site through the SiteMentor program. Designed as an extension of the typical classroom instruction offered by the RMI, the program places an RMI instructor and/or technical expert side-by-side with your employees to train them in the specific skills they need in bearings, precision skills or condition monitoring. Class size is typically limited to maximize hands-on participation for all students. While at your site, the RMI instructor will also assess maintenance skills and practices, and identify other improvement opportunities and training needs.

## Root cause success analysis

A solid foundation in proactive maintenance practices is critical to achieve maximum machine reliability and performance. To help you uncover problem areas and implement improvement methods, the RMI now offers Root Cause Success Analysis services. This service is custom tailored to your industry and working environment, and requires from two to five days on-site.

## Testing and certification

The SKF Reliability Maintenance Institute is pleased to announce that most courses will now include a certification test. Upon passing, the individual will become SKF Certified in the specific course taken. Your SKF certificate will include the course number and course name.

Participants who chose not to take the test or who do not pass the test will receive a certificate of attendance.

## SKF Reliability Maintenance Institute On-line

### Learn at your own place and pace

The on-line area of SKF Reliability Maintenance Institute (RMI) offers an expanding range of e-learning courses covering a range of topics. This enables self-paced learning to be enjoyed by the participant at the time and place that best suits their situation.

### Tutor support

Our "ask the expert" functionality provides the learner with direct access to our extensive network of subject matter experts, ensuring maximum effectiveness of the learning experience.

### Certification

On completion of the course the learner can take a test and receive a certificate in the mail.

### Structured learning path

These e-learning courses are an integral part of Reliability Maintenance Institute's extensive training portfolio. They are designed to complement the higher level courses that are delivered by our specialist training staff. Like RMI's face-to-face training, RMI On-line courses are structured according to the five facets of SKF's Asset Efficiency Optimization (AEO) process.

To learn more about all the training opportunities with the Reliability Maintenance Institute contact your local SKF representative.

## Reliability and services

SKF has been a leader and innovator in bearing technology since 1907. The evolution of SKF expertise in machine reliability stems from the very nature of bearings and their applications. SKF's understanding of a bearing's performance in an application requires an equally extensive knowledge of the machines and the processes. The thorough understanding of machine components, systems and related processes, enables SKF to create and provide realistic solutions for optimum machine and process reliability and productivity.

Through SKF Reliability Systems, SKF provides a single source for a complete productivity solution. The goal is to help customers reduce total machine related costs, enhance productivity and strengthen profitability. Whatever the requirements, SKF Reliability Systems offers the knowledge, services and products needed to achieve specific business goals.

## The Asset Efficiency Optimization™ concept

The Asset Efficiency Optimization™ (AEO) concept from SKF picks up where most plant asset management programs typically stop. Using this concept enables a plant to produce the same amount for less cost, or to produce more for the same costs. It is a system for organizing and applying assets – from personnel to machinery – bringing together knowledge and technology to achieve the greatest return on investment.

By applying the power of SKF's technology and service solutions, you can benefit from a program that assists in achieving your organization's overall business objectives. These include reduced costs, greater productivity, better utilization of resources, and as a result, increased bottom line profitability (Diagram 1).

## SKF technology and service solutions

The following summarizes the most important services and products that SKF Reliability Systems offers to provide solutions to the real-life application conditions. For detailed information on the SKF Reliability Systems program please refer to publication 5160 E "The Guide to Asset Efficiency Optimization™ for Improved Profitability" or visit [www.skfreliability.com](http://www.skfreliability.com) to see the latest information on strategies and services.

### Assessment

An assessment can include one or all of the following areas.

- Determination of current situation
- Maintenance
- Supply and stores processes
- Predictive maintenance

### Maintenance strategy

SKF can help to establish a comprehensive maintenance strategy, designed to make sure that productivity, as well as safety and integrity issues, receive the attention they require. **Diagram 1** illustrates the range and ranking of maintenance practices.

## Maintenance engineering

Maintenance engineering is putting the strategy to work and includes, for example, the implementation of a "Computerized Maintenance Management System" (CMMS) with all the data and process information needed to achieve maintenance strategy goals.

## Supply process

This service is an integral part of increasing profitability by reducing transaction costs, releasing capital tied up in spare inventory and making sure that the spares are available when needed.

## Proactive Reliability Maintenance

Following the Proactive Reliability Maintenance process helps to provide best return on plant assets. It addresses failures and implements the processes necessary to prevent recurrence. The SKF Proactive Reliability process is based on four key steps:

- Predictive maintenance,
- Diagnostics and Root Cause Analysis (RCA)
- Key performance indicators
- Periodic operational reviews

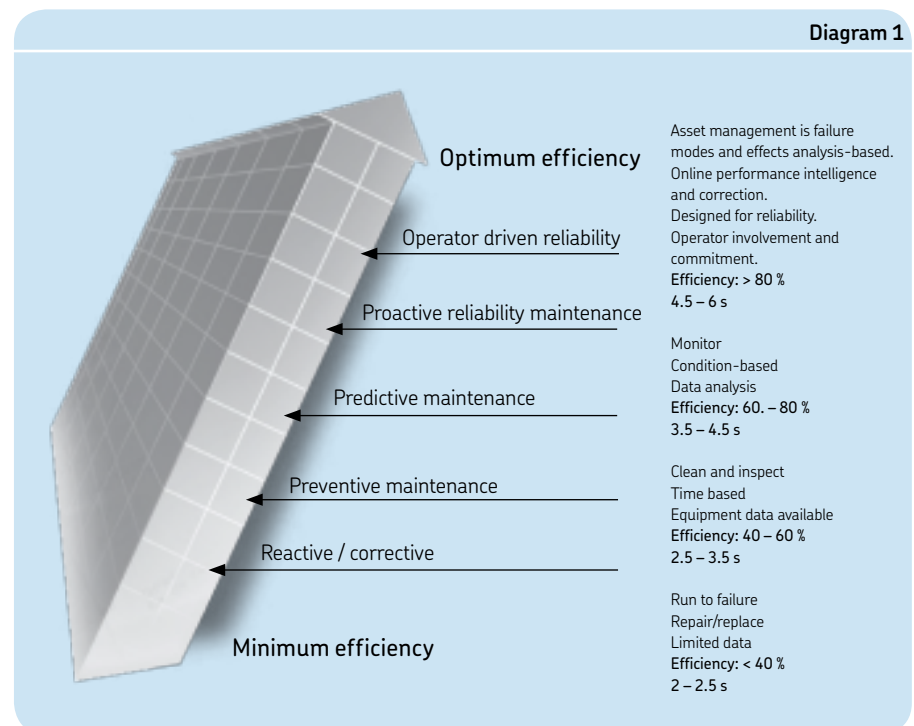

## Machine maintenance

SKF Reliability Systems has developed its most comprehensive service program for rotating equipment to drive machine maintenance in the most cost effective ways. This program includes products and services such as:

- Machine alignment
- Precision balancing
- Lubrication management
- Bearing analysis
- Technology advice and machine upgrades
- Bearing installation

## Machine improvement

To remain competitive, plants must keep pace with new machine technologies. SKF can help to keep pace – without the need to invest in new machines. Recommendations can include one, or a combination of actions:

- Upgrade, rebuild and re-design
- Design engineering
- Refurbishment of bearings
- Repair and upgrade machine tool spindles
- Instrument/equipment calibrations

## Integrated Maintenance Solutions

An Integrated Maintenance Solution (IMS) agreement brings together all areas of expertise offered by SKF, establishing a continuous process of maintenance monitoring, analysis and improvement. It provides a planned skills transfer program for maintenance and operations personnel, and technology upgrades where required.



## Condition monitoring

As a leading supplier of condition monitoring products, SKF offers a complete range – from hand-held data collectors/analyzers to online surveillance and machine protection systems. These products provide interface with condition monitoring analysis software and other plantwide systems

## @ptitude Industrial Decision Support System

The @ptitude Industrial Decision Support System from SKF is a knowledge management system that incorporates today's most advanced technologies to integrate data from multiple sources into an easy to use reliability maintenance application. It enhances the user ability to make the right decision at the right time, providing a structured approach to capturing and applying knowledge. A key element of the @ptitude system is its online, web-enabled asset management knowledge bank: @ptitudeXchange subscribers have access to articles, technical handbooks, white papers, best practices and benchmarking information, interactive decision-support programs and an information network for expert advice and services.

For additional information, please visit [www.apitudexchange.com](http://www.apitudexchange.com).



## SKF Machine Health Reporting Program

### A partnership—you collect the data, SKF analyzes it

The SKF Machine Health Reporting Program is a partnership offering that can help your plant enjoy many of the benefits of a comprehensive predictive maintenance program — without the need to invest in condition monitoring equipment or specialized data analysis training that a PdM program requires. SKF instructs your maintenance personnel how to use an SKF handheld data collector to capture vibration data during their normal duties. Collected data is transmitted to SKF via the Internet, then analyzed by a certified SKF Reliability Engineer who identifies problems and recommends actions to avoid unplanned downtime.

### Program highlights

The SKF Machine Health Reporting Program allows your team to tap into decades of SKF predictive maintenance and rotating machinery analysis expertise, even as it enables them to focus on more production-related activities. For a monthly fee based on the number of machines you choose to monitor, the program delivers many benefits. Highlights include:

- SKF provides a state-of-the-art data collector and on-site instruction
- Your own people collect the vibration data
- SKF certified Reliability Engineers manage your database using specialized software
- SKF analyzes your data and publishes monthly Machine Health Reports on a private web page
- SKF calls to alert you to urgent machinery health conditions
- SKF keeps your program on track with quarterly visits and up to 12 out-of-schedule analyses







© SKF is a registered trademark of SKF USA Inc.

The contents of this publication are the copyright of the publisher and may not be reproduced (even extracts) unless prior written permission is granted. Every care has been taken to ensure the accuracy of the information contained in this publication but no liability can be accepted for any loss or damage whether direct, indirect or consequential arising out of use of the information contained herein.