

PALLMER

DURECON WOOD  
SHELVING  
SPECIFICATION GUIDE  
& PRICE LIST **2022**

### WOODS & FINISHES:

#### Natural Maple Standard

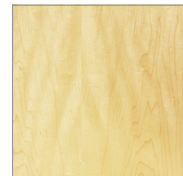

Natural Clear – M-NA

#### Maple Finishes

The following stains are available, add 10% to list



Castle Oak – M-CO



Honey Oak – M-HO

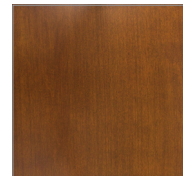

English Oak – M-EN

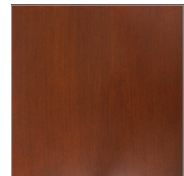

Victorian Cherry – M-VI



Richmond Cherry – M-RC



Mahogany – M-MA



Java – M-JA



Wenge – M-WE

#### Natural Red Oak Standard

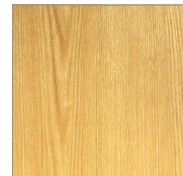

Natural Clear – O-NA

#### Red Oak Finishes

The following stains are available, add 10% to list

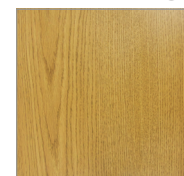

Castle Oak – O-CO



Honey Oak – O-HO

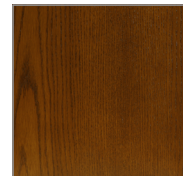

English Oak – O-EN

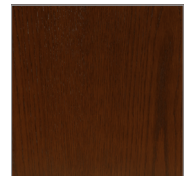

Victorian Cherry – O-VI



Richmond Cherry – O-RC



Mahogany – O-MA



Java – O-JA



Wenge – O-WE

#### Natural Cherry

Add 20% to list



Natural Clear – C-NA

#### Cherry Finishes

The following stains are available, add 30% to list

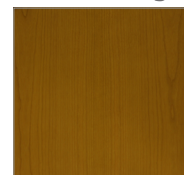

Honey Oak – C-HO

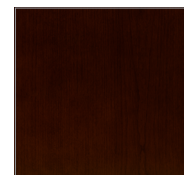

Richmond Cherry – C-RC

#### Natural Walnut

Add 20% to list



Natural Clear – W-NA

#### Walnut Finishes

The following stain is available, add 30% to list

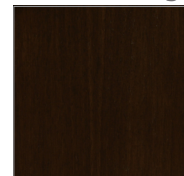

Java – W-JA

### WILSONART® LAMINATES:

Solid, Abstract and Wood Grain Options



Frosty White  
1573-60



Natural Almond  
D30-60

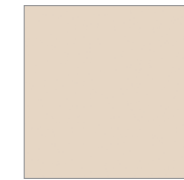

Beige  
1530-60



Fashion Grey  
D381-60



Dove Grey  
D92-60



Slate Grey  
D91-60



Black  
1595-60



Indigo  
D379-60



Maroochy Brush  
4745-60



Woolamai Brush  
4746-60

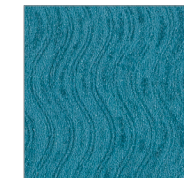

Blue Agave  
4919-60

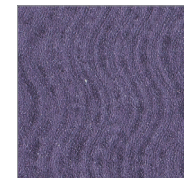

Eggplant  
4913-60



Spiced Zephyr  
4859-60



Morro Zephyr  
4846-60



Fusion Maple  
7909-60



Bannister Oak  
7806-60



Mambo  
7948-60

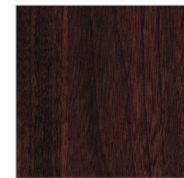

Cocobala  
7942-38



Walnut Heights  
7965-38



Wild Cherry  
7054-60



Phantom Pearl  
8211-38



White Driftwood  
8200-38



Grey Elm  
8201-38



Phantom Cocoa  
8213-38



Studio Teak  
7960-38



Skyline Walnut  
7964-38



Phantom Charcoal  
8214-38



Asian Night  
7949-38

### ABET LAMINATES:

Solid Colour Options

						
Bianco Ghiaccio 410	Beige 416	West Brown 892	Fondente 1828	Grigio Chiaro 478	Grigio Plomo 480	Grigio Scuro 871
						
Grigio Grafite 879	Nero 421	Giallo Pom Pom 463	Giallo Africa 469	Verde Erbetta 460	Sempreverde 451	Verde Biliardo 440
						
Verde Lauro 450	Verde Versailles 845	Bleu Panarea 482	Blu Amorgos 1824	Bleu California 499	Bleu Primario 838	Blu Cobalto 851
						
Blu Pavone 849	Blu Tenebre 1804	Blu Zaffiro 484	Blu Intenso 1818	Viola Madras 423	Viola Tramonto 424	Rosso Prugna 836
						
Rosso Antico 435	Rosso 431	Rosso Cavallino 1822	Arancio Canyon 835	Giallo Pop 861	Viola Sacro 1821	Fucsia 1840
						
Orchidea 1881	Viola Campanula 1827					

### METAL PAINT:

Thermal Paint Colours

						
White PS-111-W374	Antique White W11	Telegrey 4 RAL 7047	Grey A16	Zinc A67	Charcoal A230	Black N49
						
Black Sandtex N31	Sparkle Silver S11	Champagne S14	Pebble M237	Zinc Yellow RAL 1018	Traffic Yellow RAL 1023	Deep Orange RAL 2011
						
Traffic Red RAL 3020	Carmine Red RAL 3002	Purple Red RAL 3004	Claret Violet RAL 4004	Signa Violet RAL 4008	Traffic Purple RAL 4006	Blue Lilac RAL 4005
						
Yellow Green RAL 6018	Signal Green RAL 6032	Turquoise Green RAL 6016	Light Blue RAL 5012	Sky Blue RAL 5015	Gentian Blue RAL 5010	Cobalt Blue RAL 5013

### EDGE BAND COLOURS:

PVC edge band colour options



**HARDWOODS:** All hardwood materials used in the manufacturing of Palmieri products shall be Northern grown hardwoods. Hardwoods will be air and kiln dried to a moisture content of 5-7%. All hardwoods shall be of grade "A" material, free of material stains, imperfections, conformity of grain, texture and color. Hardwood species shall be Northern grown Red Oak, Clear White Northern Maple and Birch. American Cherry and Honduras Mahogany and Walnut are available. Please inquire for pricing.

**VENEER:** Exposed face veneers shall be not less than 1/28" thick plain sliced veneers. Veneers are to be selected for conformity of grain direction and color. Veneers are to be stitched tightly in a book match, slip match or plain sliced configuration. Unexposed veneers are to be of hardwood but not selected for color, or grain quality. Veneers are not to be lap joined or reveal any tape or glue lines.

**PARTICLE BOARD CORE:** The particleboard shall be formed of wood chips, bonded with a water resistance adhesive. The particleboard material is to be of a high density 45 lbs/cu. ft. having a minimum average modulus of rupture of 2400 psi and a minimum average modulus of elasticity of 4,000,000 psi.

**VENEER CORE:** Veneer core is to be constructed with odd numbers of plies. Each ply is to be laminated in pairs and cross banded in opposite directions with grain direction at a 90 degree angle to the grain of the center core. All plies are to be free from knots, wrinkles, laps or other natural or manufacturing defects.

**LUMBER CORE:** Lumber core is to be of the highest quality grade. Grade "A" select stock. Lumber core shall be constructed of solid random width strips not less than 2" wide nor more than 3 1/2" wide by 1" thick. Wood strips will be free from knots or other defects. All strips will be tightly joined using water resistance adhesives.

**HIGH PRESSURE LAMINATE:** Work surface laminate shall be .050" thick and used with balancing backer sheet of no less than .028" thick. Laminate shall conform to standards set by the American Standards Institute/National Electrical Manufacturers Association (ANSI/NEMA) for thickness, performance and appearance. Printed colours, abstract patterns and wood grains are reproduced from representative segments of large sheets and may differ slightly from the actual product.

**FINISHING PROCEDURES:** All materials shall be inspected and treated with a final sanding and polishing operation before any staining and final finishing can be performed. All machine and mill marks are to be removed. Once the polishing and sanding has been performed, the furniture will then undergo the following stain and finishing procedures:

- Step 1 A base stain will be uniformly applied, wiped and then allowed to dry under factory controlled conditions.
- Step 2 A uniform coat of sealer will be applied and allowed to dry.
- Step 3 Sealer will be lightly sanded using 240 grit silicon paper.
- Step 4 A catalytic lacquer of 34-45 degree sheen is evenly applied and allowed to dry under factory controlled conditions.

**METAL FINISHING PROCEDURES:** All metal components are thoroughly cleaned and coated electrostatically with an epoxy powder coat paint finish. The metal components are then oven baked and cured for a lasting finish.

**EDGE BANDS:** All edge bands are manufactured in PVC, semi-rigid (Flex) and ABS. Standard edging size are normally 1.25" wide x 2 mm thick. These are made of the highest grade polymers and its materials are extensively tested prior to production using special test procedures and industry specification and quality standards.



MODEL NUMBER	PRODUCT	WIDTH	DEPTH	HEIGHT	SHELF DEPTH	# OF SHELVES	# OF OPENINGS	WEIGHT	VOLUME	LIST PRICE	DESCRIPTION
 DW-3010-S-24	Single Face Starter	25 <sup>1</sup> / <sub>4</sub> "	10 <sup>1</sup> / <sub>8</sub> "	30"	9 <sup>1</sup> / <sub>2</sub> "	1	2			\$ 1,400	End, Mid, Top and Base Panels to be constructed from 1" thick 11-ply solid core, veneered 2 sides. Vertical, top and bottom edges banded with 1/4" external hardwood edging, edges to be eased. Front Edge: 3/4" thick x 2 <sup>1</sup> / <sub>2</sub> " high fascia - tongue and grooved to top.
DW-3010-A-24	Single Face Adder	24 <sup>1</sup> / <sub>4</sub> "	10 <sup>1</sup> / <sub>8</sub> "	30"	9 <sup>1</sup> / <sub>2</sub> "	1	2			\$ 1,049	
DW-3012-S-24	Single Face Starter	25 <sup>1</sup> / <sub>4</sub> "	12 <sup>1</sup> / <sub>8</sub> "	30"	11 <sup>1</sup> / <sub>2</sub> "	1	2			\$ 1,447	
DW-3012-A-24	Single Face Adder	24 <sup>1</sup> / <sub>4</sub> "	12 <sup>1</sup> / <sub>8</sub> "	30"	11 <sup>1</sup> / <sub>2</sub> "	1	2			\$ 1,112	
DW-3010-S-30	Single Face Starter	31 <sup>1</sup> / <sub>4</sub> "	10 <sup>1</sup> / <sub>8</sub> "	30"	9 <sup>1</sup> / <sub>2</sub> "	1	2			\$ 1,400	
DW-3010-A-30	Single Face Adder	30 <sup>1</sup> / <sub>4</sub> "	10 <sup>1</sup> / <sub>8</sub> "	30"	9 <sup>1</sup> / <sub>2</sub> "	1	2			\$ 1,049	
DW-3012-S-30	Single Face Starter	31 <sup>1</sup> / <sub>4</sub> "	12 <sup>1</sup> / <sub>8</sub> "	30"	11 <sup>1</sup> / <sub>2</sub> "	1	2			\$ 1,447	
DW-3012-A-30	Single Face Adder	30 <sup>1</sup> / <sub>4</sub> "	12 <sup>1</sup> / <sub>8</sub> "	30"	11 <sup>1</sup> / <sub>2</sub> "	1	2			\$ 1,112	
DW-3010-S-36	Single Face Starter	37 <sup>1</sup> / <sub>4</sub> "	10 <sup>1</sup> / <sub>8</sub> "	30"	9 <sup>1</sup> / <sub>2</sub> "	1	2			\$ 1,220	
DW-3010-A-36	Single Face Adder	36 <sup>1</sup> / <sub>4</sub> "	10 <sup>1</sup> / <sub>8</sub> "	30"	9 <sup>1</sup> / <sub>2</sub> "	1	2			\$ 871	
DW-3012-S-36	Single Face Starter	37 <sup>1</sup> / <sub>4</sub> "	12 <sup>1</sup> / <sub>8</sub> "	30"	11 <sup>1</sup> / <sub>2</sub> "	1	2			\$ 1,268	
DW-3012-A-36	Single Face Adder	36 <sup>1</sup> / <sub>4</sub> "	12 <sup>1</sup> / <sub>8</sub> "	30"	11 <sup>1</sup> / <sub>2</sub> "	1	2			\$ 825	
DW-3610-S-24	Single Face Starter	25 <sup>1</sup> / <sub>4</sub> "	10 <sup>1</sup> / <sub>8</sub> "	36"	9 <sup>1</sup> / <sub>2</sub> "	1	2			\$ 1,344	
DW-3610-A-24	Single Face Adder	24 <sup>1</sup> / <sub>4</sub> "	10 <sup>1</sup> / <sub>8</sub> "	36"	9 <sup>1</sup> / <sub>2</sub> "	1	2			\$ 971	
DW-3612-S-24	Single Face Starter	25 <sup>1</sup> / <sub>4</sub> "	12 <sup>1</sup> / <sub>8</sub> "	36"	11 <sup>1</sup> / <sub>2</sub> "	1	2			\$ 1,400	
DW-3612-A-24	Single Face Adder	24 <sup>1</sup> / <sub>4</sub> "	12 <sup>1</sup> / <sub>8</sub> "	36"	11 <sup>1</sup> / <sub>2</sub> "	1	2			\$ 1,011	
DW-3614-S-24	Single Face Starter	25 <sup>1</sup> / <sub>4</sub> "	14 <sup>5</sup> / <sub>8</sub> "	36"	14"	1	2			\$ 1,563	
DW-3614-A-24	Single Face Adder	24 <sup>1</sup> / <sub>4</sub> "	14 <sup>5</sup> / <sub>8</sub> "	36"	14"	1	2			\$ 1,135	
DW-3610-S-30	Single Face Starter	31 <sup>1</sup> / <sub>4</sub> "	10 <sup>1</sup> / <sub>8</sub> "	36"	9 <sup>1</sup> / <sub>2</sub> "	1	2			\$ 1,344	
DW-3610-A-30	Single Face Adder	30 <sup>1</sup> / <sub>4</sub> "	10 <sup>1</sup> / <sub>8</sub> "	36"	9 <sup>1</sup> / <sub>2</sub> "	1	2			\$ 971	
DW-3612-S-30	Single Face Starter	31 <sup>1</sup> / <sub>4</sub> "	12 <sup>1</sup> / <sub>8</sub> "	36"	11 <sup>1</sup> / <sub>2</sub> "	1	2			\$ 1,400	
DW-3612-A-30	Single Face Adder	30 <sup>1</sup> / <sub>4</sub> "	12 <sup>1</sup> / <sub>8</sub> "	36"	11 <sup>1</sup> / <sub>2</sub> "	1	2			\$ 1,011	
DW-3614-S-30	Single Face Starter	31 <sup>1</sup> / <sub>4</sub> "	14 <sup>5</sup> / <sub>8</sub> "	36"	14"	1	2			\$ 1,563	
DW-3614-A-30	Single Face Adder	30 <sup>1</sup> / <sub>4</sub> "	14 <sup>5</sup> / <sub>8</sub> "	36"	14"	1	2			\$ 1,135	
DW-3610-S-36	Single Face Starter	37 <sup>1</sup> / <sub>4</sub> "	10 <sup>1</sup> / <sub>8</sub> "	36"	9 <sup>1</sup> / <sub>2</sub> "	1	2	50.6 Lbs.	4 Cu Ft	\$ 1,166	
DW-3610-A-36	Single Face Adder	36 <sup>1</sup> / <sub>4</sub> "	10 <sup>1</sup> / <sub>8</sub> "	36"	9 <sup>1</sup> / <sub>2</sub> "	1	2	46 Lbs.	4 Cu Ft	\$ 793	
DW-3612-S-36	Single Face Starter	37 <sup>1</sup> / <sub>4</sub> "	12 <sup>1</sup> / <sub>8</sub> "	36"	11 <sup>1</sup> / <sub>2</sub> "	1	2	50.6 Lbs.	5 Cu Ft	\$ 1,220	
DW-3612-A-36	Single Face Adder	36 <sup>1</sup> / <sub>4</sub> "	12 <sup>1</sup> / <sub>8</sub> "	36"	11 <sup>1</sup> / <sub>2</sub> "	1	2	47.2 Lbs.	5 Cu Ft	\$ 825	
DW-3614-S-36	Single Face Starter	37 <sup>1</sup> / <sub>4</sub> "	14 <sup>5</sup> / <sub>8</sub> "	36"	14"	1	2	74.8 Lbs.	6 Cu Ft	\$ 1,375	
DW-3614-A-36	Single Face Adder	36 <sup>1</sup> / <sub>4</sub> "	14 <sup>5</sup> / <sub>8</sub> "	36"	14"	1	2	63.3 Lbs.	6 Cu Ft	\$ 957	







MODEL NUMBER	PRODUCT	WIDTH	DEPTH	HEIGHT	SHELF DEPTH	# OF SHELVES	# OF OPENINGS	WEIGHT	VOLUME	LIST PRICE	DESCRIPTION
DW-4210-S-24	Single Face Starter	25 <sup>1</sup> / <sub>4</sub> "	10 <sup>1</sup> / <sub>8</sub> "	42"	9 <sup>1</sup> / <sub>2</sub> "	2	3			\$ 1,454	End, Mid, Top and Base Panels to be constructed from 1" thick 11-ply solid core, veneered 2 sides. Vertical, top and bottom edges banded with 1/4" external hardwood edging, edges to be eased. Front Edge: 3/4" thick x 2 1/2" high fascia - tongue and grooved to top.
DW-4210-A-24	Single Face Adder	24 <sup>1</sup> / <sub>4</sub> "	10 <sup>1</sup> / <sub>8</sub> "	42"	9 <sup>1</sup> / <sub>2</sub> "	2	3			\$ 1,088	
DW-4212-S-24	Single Face Starter	25 <sup>1</sup> / <sub>4</sub> "	12 <sup>1</sup> / <sub>8</sub> "	42"	11 <sup>1</sup> / <sub>2</sub> "	2	3			\$ 1,508	
DW-4212-A-24	Single Face Adder	24 <sup>1</sup> / <sub>4</sub> "	12 <sup>1</sup> / <sub>8</sub> "	42"	11 <sup>1</sup> / <sub>2</sub> "	2	3			\$ 1,119	
DW-4214-S-24	Single Face Starter	25 <sup>1</sup> / <sub>4</sub> "	14 <sup>5</sup> / <sub>8</sub> "	42"	14"	2	3			\$ 1,710	
DW-4214-A-24	Single Face Adder	24 <sup>1</sup> / <sub>4</sub> "	14 <sup>5</sup> / <sub>8</sub> "	42"	14"	2	3			\$ 1,282	
DW-4210-S-30	Single Face Starter	31 <sup>1</sup> / <sub>4</sub> "	10 <sup>1</sup> / <sub>8</sub> "	42"	9 <sup>1</sup> / <sub>2</sub> "	2	3			\$ 1,454	
DW-4210-A-30	Single Face Adder	30 <sup>1</sup> / <sub>4</sub> "	10 <sup>1</sup> / <sub>8</sub> "	42"	9 <sup>1</sup> / <sub>2</sub> "	2	3			\$ 1,088	
DW-4212-S-30	Single Face Starter	31 <sup>1</sup> / <sub>4</sub> "	12 <sup>1</sup> / <sub>8</sub> "	42"	11 <sup>1</sup> / <sub>2</sub> "	2	3			\$ 1,508	
DW-4212-A-30	Single Face Adder	30 <sup>1</sup> / <sub>4</sub> "	12 <sup>1</sup> / <sub>8</sub> "	42"	11 <sup>1</sup> / <sub>2</sub> "	2	3			\$ 1,119	
DW-4214-S-30	Single Face Starter	31 <sup>1</sup> / <sub>4</sub> "	14 <sup>5</sup> / <sub>8</sub> "	42"	14"	2	3			\$ 1,710	
DW-4214-A-30	Single Face Adder	30 <sup>1</sup> / <sub>4</sub> "	14 <sup>5</sup> / <sub>8</sub> "	42"	14"	2	3			\$ 1,282	
DW-4210-S-36	Single Face Starter	37 <sup>1</sup> / <sub>4</sub> "	10 <sup>1</sup> / <sub>8</sub> "	42"	9 <sup>1</sup> / <sub>2</sub> "	2	3	55 Lbs.	5 Cu Ft	\$ 1,268	
DW-4210-A-36	Single Face Adder	36 <sup>1</sup> / <sub>4</sub> "	10 <sup>1</sup> / <sub>8</sub> "	42"	9 <sup>1</sup> / <sub>2</sub> "	2	3	52 Lbs.	5 Cu Ft	\$ 902	
DW-4212-S-36	Single Face Starter	37 <sup>1</sup> / <sub>4</sub> "	12 <sup>1</sup> / <sub>8</sub> "	42"	11 <sup>1</sup> / <sub>2</sub> "	2	3	60 Lbs.	5 Cu Ft	\$ 1,329	
DW-4212-A-36	Single Face Adder	36 <sup>1</sup> / <sub>4</sub> "	12 <sup>1</sup> / <sub>8</sub> "	42"	11 <sup>1</sup> / <sub>2</sub> "	2	3	53 Lbs.	5 Cu Ft	\$ 934	
DW-4214-S-36	Single Face Starter	37 <sup>1</sup> / <sub>4</sub> "	14 <sup>5</sup> / <sub>8</sub> "	42"	14"	2	3	79 Lbs.	6 Cu Ft	\$ 1,524	
DW-4214-A-36	Single Face Adder	36 <sup>1</sup> / <sub>4</sub> "	14 <sup>5</sup> / <sub>8</sub> "	42"	14"	2	3	68 Lbs.	6 Cu Ft	\$ 1,095	
DW-4810-S-24	Single Face Starter	25 <sup>1</sup> / <sub>4</sub> "	10 <sup>1</sup> / <sub>8</sub> "	48"	9 <sup>1</sup> / <sub>2</sub> "	2	3			\$ 1,531	
DW-4810-A-24	Single Face Adder	24 <sup>1</sup> / <sub>4</sub> "	10 <sup>1</sup> / <sub>8</sub> "	48"	9 <sup>1</sup> / <sub>2</sub> "	2	3			\$ 1,143	
DW-4812-S-24	Single Face Starter	25 <sup>1</sup> / <sub>4</sub> "	12 <sup>1</sup> / <sub>8</sub> "	48"	11 <sup>1</sup> / <sub>2</sub> "	2	3			\$ 1,547	
DW-4812-A-24	Single Face Adder	24 <sup>1</sup> / <sub>4</sub> "	12 <sup>1</sup> / <sub>8</sub> "	48"	11 <sup>1</sup> / <sub>2</sub> "	2	3			\$ 1,143	
DW-4814-S-24	Single Face Starter	25 <sup>1</sup> / <sub>4</sub> "	14 <sup>5</sup> / <sub>8</sub> "	48"	14"	2	3			\$ 1,748	
DW-4814-A-24	Single Face Adder	24 <sup>1</sup> / <sub>4</sub> "	14 <sup>5</sup> / <sub>8</sub> "	48"	14"	2	3			\$ 1,313	
DW-4810-S-30	Single Face Starter	31 <sup>1</sup> / <sub>4</sub> "	10 <sup>1</sup> / <sub>8</sub> "	48"	9 <sup>1</sup> / <sub>2</sub> "	2	3			\$ 1,531	
DW-4810-A-30	Single Face Adder	30 <sup>1</sup> / <sub>4</sub> "	10 <sup>1</sup> / <sub>8</sub> "	48"	9 <sup>1</sup> / <sub>2</sub> "	2	3			\$ 1,143	
DW-4812-S-30	Single Face Starter	31 <sup>1</sup> / <sub>4</sub> "	12 <sup>1</sup> / <sub>8</sub> "	48"	11 <sup>1</sup> / <sub>2</sub> "	2	3			\$ 1,547	
DW-4812-A-30	Single Face Adder	30 <sup>1</sup> / <sub>4</sub> "	12 <sup>1</sup> / <sub>8</sub> "	48"	11 <sup>1</sup> / <sub>2</sub> "	2	3			\$ 1,143	
DW-4814-S-30	Single Face Starter	31 <sup>1</sup> / <sub>4</sub> "	14 <sup>5</sup> / <sub>8</sub> "	48"	14"	2	3			\$ 1,748	
DW-4814-A-30	Single Face Adder	30 <sup>1</sup> / <sub>4</sub> "	14 <sup>5</sup> / <sub>8</sub> "	48"	14"	2	3			\$ 1,313	
DW-4810-S-36	Single Face Starter	37 <sup>1</sup> / <sub>4</sub> "	10 <sup>1</sup> / <sub>8</sub> "	48"	9 <sup>1</sup> / <sub>2</sub> "	2	3	74.8 Lbs.	5 Cu Ft	\$ 1,344	
DW-4810-A-36	Single Face Adder	36 <sup>1</sup> / <sub>4</sub> "	10 <sup>1</sup> / <sub>8</sub> "	48"	9 <sup>1</sup> / <sub>2</sub> "	2	3	65.5 Lbs.	5 Cu Ft	\$ 957	
DW-4812-S-36	Single Face Starter	37 <sup>1</sup> / <sub>4</sub> "	12 <sup>1</sup> / <sub>8</sub> "	48"	11 <sup>1</sup> / <sub>2</sub> "	2	3	82.8 Lbs.	6 Cu Ft	\$ 1,369	
DW-4812-A-36	Single Face Adder	36 <sup>1</sup> / <sub>4</sub> "	12 <sup>1</sup> / <sub>8</sub> "	48"	11 <sup>1</sup> / <sub>2</sub> "	2	3	71.3 Lbs.	6 Cu Ft	\$ 957	
DW-4814-S-36	Single Face Starter	37 <sup>1</sup> / <sub>4</sub> "	14 <sup>5</sup> / <sub>8</sub> "	48"	14"	2	3	108 Lbs.	7 Cu Ft	\$ 1,571	
DW-4814-A-36	Single Face Adder	36 <sup>1</sup> / <sub>4</sub> "	14 <sup>5</sup> / <sub>8</sub> "	48"	14"	2	3	92 Lbs.	7 Cu Ft	\$ 1,127	



Model Shown  
DW-4212-S-36



Model Shown  
DW-4212-A-36

MODEL NUMBER	PRODUCT	WIDTH	DEPTH	HEIGHT	SHELF DEPTH	# OF SHELVES	# OF OPENINGS	WEIGHT	VOLUME	LIST PRICE	DESCRIPTION
 Model Shown DW-6012-S-36	DW-6010-S-24	Single Face Starter	25 <sup>1</sup> / <sub>4</sub> "	10 <sup>1</sup> / <sub>8</sub> "	60"	9 <sup>1</sup> / <sub>2</sub> "	3			\$ 1,563	End, Mid, Top and Base Panels to be constructed from 1" thick 11-ply solid core, veneered 2 sides. Vertical, top and bottom edges banded with 1/4" external hardwood edging, edges to be eased. Front Edge: 3/4" thick x 2 1/2" high fascia - tongue and grooved to top.
	DW-6010-A-24	Single Face Adder	24 <sup>1</sup> / <sub>4</sub> "	10 <sup>1</sup> / <sub>8</sub> "	60"	9 <sup>1</sup> / <sub>2</sub> "	3			\$ 1,189	
	DW-6012-S-24	Single Face Starter	25 <sup>1</sup> / <sub>4</sub> "	12 <sup>1</sup> / <sub>8</sub> "	60"	11 <sup>1</sup> / <sub>2</sub> "	3			\$ 1,617	
	DW-6012-A-24	Single Face Adder	24 <sup>1</sup> / <sub>4</sub> "	12 <sup>1</sup> / <sub>8</sub> "	60"	11 <sup>1</sup> / <sub>2</sub> "	3			\$ 1,229	
	DW-6014-S-24	Single Face Starter	25 <sup>1</sup> / <sub>4</sub> "	14 <sup>5</sup> / <sub>8</sub> "	60"	14"	3			\$ 1,851	
	DW-6014-A-24	Single Face Adder	24 <sup>1</sup> / <sub>4</sub> "	14 <sup>5</sup> / <sub>8</sub> "	60"	14"	3			\$ 1,431	
 Model Shown DW-6012-A-36	DW-6010-S-30	Single Face Starter	31 <sup>1</sup> / <sub>4</sub> "	10 <sup>1</sup> / <sub>8</sub> "	60"	9 <sup>1</sup> / <sub>2</sub> "	3			\$ 1,563	
	DW-6010-A-30	Single Face Adder	30 <sup>1</sup> / <sub>4</sub> "	10 <sup>1</sup> / <sub>8</sub> "	60"	9 <sup>1</sup> / <sub>2</sub> "	3			\$ 1,189	
	DW-6012-S-30	Single Face Starter	31 <sup>1</sup> / <sub>4</sub> "	12 <sup>1</sup> / <sub>8</sub> "	60"	11 <sup>1</sup> / <sub>2</sub> "	3			\$ 1,617	
	DW-6012-A-30	Single Face Adder	30 <sup>1</sup> / <sub>4</sub> "	12 <sup>1</sup> / <sub>8</sub> "	60"	11 <sup>1</sup> / <sub>2</sub> "	3			\$ 1,229	
	DW-6014-S-30	Single Face Starter	31 <sup>1</sup> / <sub>4</sub> "	14 <sup>5</sup> / <sub>8</sub> "	60"	14"	3			\$ 1,851	
	DW-6014-A-30	Single Face Adder	30 <sup>1</sup> / <sub>4</sub> "	14 <sup>5</sup> / <sub>8</sub> "	60"	14"	3			\$ 1,431	
 Model Shown DW-6012-A-36	DW-6010-S-36	Single Face Starter	37 <sup>1</sup> / <sub>4</sub> "	10 <sup>1</sup> / <sub>8</sub> "	60"	9 <sup>1</sup> / <sub>2</sub> "	3			\$ 1,383	
	DW-6010-A-36	Single Face Adder	36 <sup>1</sup> / <sub>4</sub> "	10 <sup>1</sup> / <sub>8</sub> "	60"	9 <sup>1</sup> / <sub>2</sub> "	3	100 Lbs.	6 Cu Ft	\$ 1,011	
	DW-6012-S-36	Single Face Starter	37 <sup>1</sup> / <sub>4</sub> "	12 <sup>1</sup> / <sub>8</sub> "	60"	11 <sup>1</sup> / <sub>2</sub> "	3	116 Lbs.	8 Cu Ft	\$ 1,439	
	DW-6012-A-36	Single Face Adder	36 <sup>1</sup> / <sub>4</sub> "	12 <sup>1</sup> / <sub>8</sub> "	60"	11 <sup>1</sup> / <sub>2</sub> "	3	95.5 Lbs.	7 Cu Ft	\$ 1,049	
	DW-6014-S-36	Single Face Starter	37 <sup>1</sup> / <sub>4</sub> "	14 <sup>5</sup> / <sub>8</sub> "	60"	14"	3	141 Lbs.	9 Cu Ft	\$ 1,671	
	DW-6014-A-36	Single Face Adder	36 <sup>1</sup> / <sub>4</sub> "	14 <sup>5</sup> / <sub>8</sub> "	60"	14"	3	121 Lbs.	8 Cu Ft	\$ 1,244	
 Model Shown DW-7212-S-36	DW-7210-S-24	Single Face Starter	25 <sup>1</sup> / <sub>4</sub> "	10 <sup>1</sup> / <sub>8</sub> "	72"	9 <sup>1</sup> / <sub>2</sub> "	4			\$ 1,671	
	DW-7210-A-24	Single Face Adder	24 <sup>1</sup> / <sub>4</sub> "	10 <sup>1</sup> / <sub>8</sub> "	72"	9 <sup>1</sup> / <sub>2</sub> "	4			\$ 1,290	
	DW-7212-S-24	Single Face Starter	25 <sup>1</sup> / <sub>4</sub> "	12 <sup>1</sup> / <sub>8</sub> "	72"	11 <sup>1</sup> / <sub>2</sub> "	4			\$ 1,734	
	DW-7212-A-24	Single Face Adder	24 <sup>1</sup> / <sub>4</sub> "	12 <sup>1</sup> / <sub>8</sub> "	72"	11 <sup>1</sup> / <sub>2</sub> "	4			\$ 1,344	
	DW-7214-S-24	Single Face Starter	25 <sup>1</sup> / <sub>4</sub> "	14 <sup>5</sup> / <sub>8</sub> "	72"	14"	4			\$ 1,976	
	DW-7214-A-24	Single Face Adder	24 <sup>1</sup> / <sub>4</sub> "	14 <sup>5</sup> / <sub>8</sub> "	72"	14"	4			\$ 1,563	
 Model Shown DW-7212-A-36	DW-7210-S-30	Single Face Starter	31 <sup>1</sup> / <sub>4</sub> "	10 <sup>1</sup> / <sub>8</sub> "	72"	9 <sup>1</sup> / <sub>2</sub> "	4			\$ 1,671	
	DW-7210-A-30	Single Face Adder	30 <sup>1</sup> / <sub>4</sub> "	10 <sup>1</sup> / <sub>8</sub> "	72"	9 <sup>1</sup> / <sub>2</sub> "	4			\$ 1,290	
	DW-7212-S-30	Single Face Starter	31 <sup>1</sup> / <sub>4</sub> "	12 <sup>1</sup> / <sub>8</sub> "	72"	11 <sup>1</sup> / <sub>2</sub> "	4			\$ 1,734	
	DW-7212-A-30	Single Face Adder	30 <sup>1</sup> / <sub>4</sub> "	12 <sup>1</sup> / <sub>8</sub> "	72"	11 <sup>1</sup> / <sub>2</sub> "	4			\$ 1,344	
	DW-7214-S-30	Single Face Starter	31 <sup>1</sup> / <sub>4</sub> "	14 <sup>5</sup> / <sub>8</sub> "	72"	14"	4			\$ 1,976	
	DW-7214-A-30	Single Face Adder	30 <sup>1</sup> / <sub>4</sub> "	14 <sup>5</sup> / <sub>8</sub> "	72"	14"	4			\$ 1,563	
 Model Shown DW-7212-A-36	DW-7210-S-36	Single Face Starter	37 <sup>1</sup> / <sub>4</sub> "	10 <sup>1</sup> / <sub>8</sub> "	72"	9 <sup>1</sup> / <sub>2</sub> "	4			\$ 1,486	
	DW-7210-A-36	Single Face Adder	36 <sup>1</sup> / <sub>4</sub> "	10 <sup>1</sup> / <sub>8</sub> "	72"	9 <sup>1</sup> / <sub>2</sub> "	4	115 Lbs.	7 Cu Ft	\$ 1,105	
	DW-7212-S-36	Single Face Starter	37 <sup>1</sup> / <sub>4</sub> "	12 <sup>1</sup> / <sub>8</sub> "	72"	11 <sup>1</sup> / <sub>2</sub> "	4	131 Lbs.	8 Cu Ft	\$ 1,555	
	DW-7212-A-36	Single Face Adder	36 <sup>1</sup> / <sub>4</sub> "	12 <sup>1</sup> / <sub>8</sub> "	72"	11 <sup>1</sup> / <sub>2</sub> "	4	109 Lbs.	8 Cu Ft	\$ 1,158	
	DW-7214-S-36	Single Face Starter	37 <sup>1</sup> / <sub>4</sub> "	14 <sup>5</sup> / <sub>8</sub> "	72"	14"	4	159 Lbs.	10 Cu Ft	\$ 1,788	
	DW-7214-A-36	Single Face Adder	36 <sup>1</sup> / <sub>4</sub> "	14 <sup>5</sup> / <sub>8</sub> "	72"	14"	4	132 Lbs.	9 Cu Ft	\$ 1,375	

MODEL NUMBER	PRODUCT	WIDTH	DEPTH	HEIGHT	SHELF DEPTH	# OF SHELVES	# OF OPENINGS	WEIGHT	VOLUME	LIST PRICE	DESCRIPTION
DW-8210-S-24	Single Face Starter	25 1/4"	10 1/8"	82"	9 1/2"	5	6			\$ 1,780	End, Mid, Top and Base Panels to be constructed from 1" thick 11-ply solid core, veneered 2 sides. Vertical, top and bottom edges banded with 1/4" external hardwood edging, edges to be eased. Front Edge: 3/4" thick x 2 1/2" high fascia - tongue and grooved to top.
DW-8210-A-24	Single Face Adder	24 1/4"	10 1/8"	82"	9 1/2"	5	6			\$ 1,400	
DW-8212-S-24	Single Face Starter	25 1/4"	12 1/8"	82"	11 1/2"	5	6			\$ 1,841	
DW-8212-A-24	Single Face Adder	24 1/4"	12 1/8"	82"	11 1/2"	5	6			\$ 1,454	
DW-8214-S-24	Single Face Starter	25 1/4"	14 5/8"	82"	14"	5	6			\$ 2,060	
DW-8214-A-24	Single Face Adder	24 1/4"	14 5/8"	82"	14"	5	6			\$ 1,710	
DW-8210-S-30	Single Face Starter	31 1/4"	10 1/8"	82"	9 1/2"	5	6			\$ 1,780	
DW-8210-A-30	Single Face Adder	30 1/4"	10 1/8"	82"	9 1/2"	5	6			\$ 1,400	
DW-8212-S-30	Single Face Starter	31 1/4"	12 1/8"	82"	11 1/2"	5	6			\$ 1,841	
DW-8212-A-30	Single Face Adder	30 1/4"	12 1/8"	82"	11 1/2"	5	6			\$ 1,454	
DW-8214-S-30	Single Face Starter	31 1/4"	14 5/8"	82"	14"	5	6			\$ 2,060	
DW-8214-A-30	Single Face Adder	30 1/4"	14 5/8"	82"	14"	5	6			\$ 1,710	
DW-8210-S-36	Single Face Starter	37 1/4"	10 1/8"	82"	9 1/2"	5	6	129 Lbs.	8 Cu Ft	\$ 1,593	
DW-8210-A-36	Single Face Adder	36 1/4"	10 1/8"	82"	9 1/2"	5	6	107 Lbs.	7 Cu Ft	\$ 1,220	
DW-8212-S-36	Single Face Starter	37 1/4"	12 1/8"	82"	11 1/2"	5	6	145 Lbs.	9 Cu Ft	\$ 1,664	
DW-8212-A-36	Single Face Adder	36 1/4"	12 1/8"	82"	11 1/2"	5	6	122 Lbs.	8 Cu Ft	\$ 1,268	
DW-8214-S-36	Single Face Starter	37 1/4"	14 5/8"	82"	14"	5	6	175 Lbs.	11 Cu Ft	\$ 1,873	
DW-8214-A-36	Single Face Adder	36 1/4"	14 5/8"	82"	14"	5	6	143 Lbs.	10 Cu Ft	\$ 1,531	
DW-9610-S-24	Single Face Starter	25 1/4"	10 1/8"	96"	9 1/2"	6	7			\$ 1,873	
DW-9610-A-24	Single Face Adder	24 1/4"	10 1/8"	96"	9 1/2"	6	7			\$ 1,500	
DW-9612-S-24	Single Face Starter	25 1/4"	12 1/8"	96"	11 1/2"	6	7			\$ 1,958	
DW-9612-A-24	Single Face Adder	24 1/4"	12 1/8"	96"	11 1/2"	6	7			\$ 1,563	
DW-9614-S-24	Single Face Starter	25 1/4"	14 5/8"	96"	14"	6	7			\$ 2,277	
DW-9614-A-24	Single Face Adder	24 1/4"	14 5/8"	96"	14"	6	7			\$ 1,819	
DW-9610-S-30	Single Face Starter	31 1/4"	10 1/8"	96"	9 1/2"	6	7			\$ 1,873	
DW-9610-A-30	Single Face Adder	30 1/4"	10 1/8"	96"	9 1/2"	6	7			\$ 1,500	
DW-9612-S-30	Single Face Starter	31 1/4"	12 1/8"	96"	11 1/2"	6	7			\$ 1,958	
DW-9612-A-30	Single Face Adder	30 1/4"	12 1/8"	96"	11 1/2"	6	7			\$ 1,563	
DW-9614-S-30	Single Face Starter	31 1/4"	14 5/8"	96"	14"	6	7			\$ 2,277	
DW-9614-A-30	Single Face Adder	30 1/4"	14 5/8"	96"	14"	6	7			\$ 1,819	
DW-9610-S-36	Single Face Starter	37 1/4"	10 1/8"	96"	9 1/2"	6	7	156 Lbs.	9 Cu Ft	\$ 1,695	
DW-9610-A-36	Single Face Adder	36 1/4"	10 1/8"	96"	9 1/2"	6	7	128 Lbs.	8 Cu Ft	\$ 1,313	
DW-9612-S-36	Single Face Starter	37 1/4"	12 1/8"	96"	11 1/2"	6	7	177 Lbs.	10 Cu Ft	\$ 1,780	
DW-9612-A-36	Single Face Adder	36 1/4"	12 1/8"	96"	11 1/2"	6	7	145 Lbs.	9 Cu Ft	\$ 1,383	
DW-9614-S-36	Single Face Starter	37 1/4"	14 5/8"	96"	14"	6	7	213 Lbs.	12 Cu Ft	\$ 2,100	
DW-9614-A-36	Single Face Adder	36 1/4"	14 5/8"	96"	14"	6	7	175 Lbs.	11 Cu Ft	\$ 1,641	



Model Shown  
DW-8212-S-36



Model Shown  
DW-8212-A-36











Model Shown  
DW-9612-S-36



Model Shown  
DW-9612-A-36



MODEL NUMBER	PRODUCT	WIDTH	DEPTH	HEIGHT	SHELF DEPTH	# OF SHELVES	# OF OPENINGS	WEIGHT	VOLUME	LIST PRICE	DESCRIPTION
 Model Shown DW-3624-S-36	DW-3620-S-24	Double Face Starter	25 1/4"	19 1/2"	36"	9 1/2"	2			\$ 2,379	End, Mid, Top and Base Panels to be constructed from 1" thick 11-ply solid core, veneered 2 sides. Vertical, top and bottom edges banded with 1/4" external hardwood edging, edges to be eased. Front Edge: 3/4" thick x 2 1/2" high fascia - tongue and grooved to top.
	DW-3620-A-24	Double Face Adder	24 1/4"	19 1/2"	36"	9 1/2"	2			\$ 1,734	
	DW-3624-S-24	Double Face Starter	25 1/4"	23 1/2"	36"	11 1/2"	2			\$ 2,425	
	DW-3624-A-24	Double Face Adder	24 1/4"	23 1/2"	36"	11 1/2"	2			\$ 1,748	
	DW-3628-S-24	Double Face Starter	25 1/4"	28 1/2"	36"	14"	2			\$ 2,791	
	DW-3628-A-24	Double Face Adder	24 1/4"	28 1/2"	36"	14"	2			\$ 2,053	
 Model Shown DW-3624-A-36	DW-3620-S-30	Double Face Starter	31 1/4"	19 1/2"	36"	9 1/2"	2			\$ 2,379	
	DW-3620-A-30	Double Face Adder	30 1/4"	19 1/2"	36"	9 1/2"	2			\$ 1,734	
	DW-3624-S-30	Double Face Starter	31 1/4"	23 1/2"	36"	11 1/2"	2			\$ 2,425	
	DW-3624-A-30	Double Face Adder	30 1/4"	23 1/2"	36"	11 1/2"	2			\$ 1,748	
	DW-3628-S-30	Double Face Starter	31 1/4"	28 1/2"	36"	14"	2			\$ 2,791	
	DW-3628-A-30	Double Face Adder	30 1/4"	28 1/2"	36"	14"	2			\$ 2,053	
	DW-3620-S-36	Double Face Starter	37 1/4"	19 1/2"	36"	9 1/2"	2			\$ 2,107	
	DW-3620-A-36	Double Face Adder	36 1/4"	19 1/2"	36"	9 1/2"	2	88.6 Lbs.	7 Cu Ft	\$ 1,454	
	DW-3624-S-36	Double Face Starter	37 1/4"	23 1/2"	36"	11 1/2"	2	73.6 Lbs.	6 Cu Ft	\$ 2,153	
	DW-3624-A-36	Double Face Adder	36 1/4"	23 1/2"	36"	11 1/2"	2	110 Lbs.	10 Cu Ft	\$ 1,478	
	DW-3628-S-36	Double Face Starter	37 1/4"	28 1/2"	36"	14"	2	88.6 Lbs.	9 Cu Ft	\$ 2,512	
	DW-3628-A-36	Double Face Adder	36 1/4"	28 1/2"	36"	14"	2	132 Lbs.	11 Cu Ft	\$ 1,772	
 Model Shown DW-4224-S-36	DW-4220-S-24	Double Face Starter	25 1/4"	19 1/2"	42"	9 1/2"	4			\$ 2,598	
	DW-4220-A-24	Double Face Adder	24 1/4"	19 1/2"	42"	9 1/2"	4			\$ 1,952	
	DW-4224-S-24	Double Face Starter	25 1/4"	23 1/2"	42"	11 1/2"	4			\$ 2,659	
	DW-4224-A-24	Double Face Adder	24 1/4"	23 1/2"	42"	11 1/2"	4			\$ 1,983	
	DW-4228-S-24	Double Face Starter	25 1/4"	28 1/2"	42"	14"	4			\$ 3,095	
	DW-4228-A-24	Double Face Adder	24 1/4"	28 1/2"	42"	14"	4			\$ 2,356	
 Model Shown DW-4224-A-36	DW-4220-S-30	Double Face Starter	31 1/4"	19 1/2"	42"	9 1/2"	4			\$ 2,598	
	DW-4220-A-30	Double Face Adder	30 1/4"	19 1/2"	42"	9 1/2"	4			\$ 1,952	
	DW-4224-S-30	Double Face Starter	31 1/4"	23 1/2"	42"	11 1/2"	4			\$ 2,659	
	DW-4224-A-30	Double Face Adder	30 1/4"	23 1/2"	42"	11 1/2"	4			\$ 1,983	
	DW-4228-S-30	Double Face Starter	31 1/4"	28 1/2"	42"	14"	4			\$ 3,095	
	DW-4228-A-30	Double Face Adder	30 1/4"	28 1/2"	42"	14"	4			\$ 2,356	
	DW-4220-S-36	Double Face Starter	37 1/4"	19 1/2"	42"	9 1/2"	4			\$ 2,324	
	DW-4220-A-36	Double Face Adder	36 1/4"	19 1/2"	42"	9 1/2"	4	94 Lbs.	7 Cu Ft	\$ 1,671	
	DW-4224-S-36	Double Face Starter	37 1/4"	23 1/2"	42"	11 1/2"	4	78 Lbs.	7 Cu Ft	\$ 2,379	
	DW-4224-A-36	Double Face Adder	36 1/4"	23 1/2"	42"	11 1/2"	4	115 Lbs.	10 Cu Ft	\$ 1,703	
	DW-4228-S-36	Double Face Starter	37 1/4"	28 1/2"	42"	14"	4	113 Lbs.	10 Cu Ft	\$ 2,815	
	DW-4228-A-36	Double Face Adder	36 1/4"	28 1/2"	42"	14"	4	183 Lbs.	13 Cu Ft	\$ 2,076	

MODEL NUMBER	PRODUCT	WIDTH	DEPTH	HEIGHT	SHELF DEPTH	# OF SHELVES	# OF OPENINGS	WEIGHT	VOLUME	LIST PRICE	DESCRIPTION	
 Model Shown DW-4224-S-36	DW-4820-S-24	Double Face Starter	25 1/4"	19 1/2"	48"	9 1/2"	4	6		\$ 2,690	End, Mid, Top and Base Panels to be constructed from 1" thick 11-ply solid core, veneered 2 sides. Vertical, top and bottom edges banded with 1/4" external hardwood edging, edges to be eased. Front Edge: 3/4" thick x 2 1/2" high fascia - tongue and grooved to top.	
	DW-4820-A-24	Double Face Adder	24 1/4"	19 1/2"	48"	9 1/2"	4	6		\$ 2,014		
	DW-4824-S-24	Double Face Starter	25 1/4"	23 1/2"	48"	11 1/2"	4	6		\$ 2,752		
	DW-4824-A-24	Double Face Adder	24 1/4"	23 1/2"	48"	11 1/2"	4	6		\$ 2,045		
	DW-4828-S-24	Double Face Starter	25 1/4"	28 1/2"	48"	14"	4	6		\$ 3,203		
	DW-4828-A-24	Double Face Adder	24 1/4"	28 1/2"	48"	14"	4	6		\$ 2,433		
 Model Shown DW-4224-A-36	DW-4820-S-30	Double Face Starter	31 1/4"	19 1/2"	48"	9 1/2"	4	6		\$ 2,690		
	DW-4820-A-30	Double Face Adder	30 1/4"	19 1/2"	48"	9 1/2"	4	6		\$ 2,014		
	DW-4824-S-30	Double Face Starter	31 1/4"	23 1/2"	48"	11 1/2"	4	6		\$ 2,752		
	DW-4824-A-30	Double Face Adder	30 1/4"	23 1/2"	48"	11 1/2"	4	6		\$ 2,045		
	DW-4828-S-30	Double Face Starter	31 1/4"	28 1/2"	48"	14"	4	6		\$ 3,203		
	DW-4828-A-30	Double Face Adder	30 1/4"	28 1/2"	48"	14"	4	6		\$ 2,433		
	DW-4820-S-36	Double Face Starter	37 1/4"	19 1/2"	48"	9 1/2"	4	6	132 Lbs.	9 Cu Ft		\$ 2,410
	DW-4820-A-36	Double Face Adder	36 1/4"	19 1/2"	48"	9 1/2"	4	6	109 Lbs.	8 Cu Ft		\$ 1,741
	DW-4824-S-36	Double Face Starter	37 1/4"	23 1/2"	48"	11 1/2"	4	6	155 Lbs.	11 Cu Ft		\$ 2,473
	DW-4824-A-36	Double Face Adder	36 1/4"	23 1/2"	48"	11 1/2"	4	6	127 Lbs.	10 Cu Ft		\$ 1,772
	DW-4828-S-36	Double Face Starter	37 1/4"	28 1/2"	48"	14"	4	6	178 Lbs.	13 Cu Ft		\$ 2,930
	DW-4828-A-36	Double Face Adder	36 1/4"	28 1/2"	48"	14"	4	6	144 Lbs.	12 Cu Ft		\$ 2,162
 Model Shown DW-6024-S-36	DW-6020-S-24	Double Face Starter	25 1/4"	19 1/2"	60"	9 1/2"	6	8		\$ 2,783		
	DW-6020-A-24	Double Face Adder	24 1/4"	19 1/2"	60"	9 1/2"	6	8		\$ 2,115		
	DW-6024-S-24	Double Face Starter	25 1/4"	23 1/2"	60"	11 1/2"	6	8		\$ 2,846		
	DW-6024-A-24	Double Face Adder	24 1/4"	23 1/2"	60"	11 1/2"	6	8		\$ 2,169		
	DW-6028-S-24	Double Face Starter	25 1/4"	28 1/2"	60"	14"	6	8		\$ 3,351		
	DW-6028-A-24	Double Face Adder	24 1/4"	28 1/2"	60"	14"	6	8		\$ 2,588		
 Model Shown DW-6024-A-36	DW-6020-S-30	Double Face Starter	31 1/4"	19 1/2"	60"	9 1/2"	6	8		\$ 2,783		
	DW-6020-A-30	Double Face Adder	30 1/4"	19 1/2"	60"	9 1/2"	6	8		\$ 2,115		
	DW-6024-S-30	Double Face Starter	31 1/4"	23 1/2"	60"	11 1/2"	6	8		\$ 2,846		
	DW-6024-A-30	Double Face Adder	30 1/4"	23 1/2"	60"	11 1/2"	6	8		\$ 2,169		
	DW-6028-S-30	Double Face Starter	31 1/4"	28 1/2"	60"	14"	6	8		\$ 3,351		
	DW-6028-A-30	Double Face Adder	30 1/4"	28 1/2"	60"	14"	6	8		\$ 2,588		
	DW-6020-S-36	Double Face Starter	37 1/4"	19 1/2"	60"	9 1/2"	6	8	176 Lbs.	11 Cu Ft	\$ 2,504	
	DW-6020-A-36	Double Face Adder	36 1/4"	19 1/2"	60"	9 1/2"	6	8	145 Lbs.	10 Cu Ft	\$ 1,834	
	DW-6024-S-36	Double Face Starter	37 1/4"	23 1/2"	60"	11 1/2"	6	8	200 Lbs.	12 Cu Ft	\$ 2,566	
	DW-6024-A-36	Double Face Adder	36 1/4"	23 1/2"	60"	11 1/2"	6	8	164 Lbs.	11 Cu Ft	\$ 1,889	
	DW-6028-S-36	Double Face Starter	37 1/4"	28 1/2"	60"	14"	6	8	224 Lbs.	13 Cu Ft	\$ 3,070	
	DW-6028-A-36	Double Face Adder	36 1/4"	28 1/2"	60"	14"	6	8	184 Lbs.	12 Cu Ft	\$ 2,309	

MODEL NUMBER	PRODUCT	WIDTH	DEPTH	HEIGHT	SHELF DEPTH	# OF SHELVES	# OF OPENINGS	WEIGHT	VOLUME	LIST PRICE	DESCRIPTION
--------------	---------	-------	-------	--------	-------------	--------------	---------------	--------	--------	------------	-------------



Model Shown  
DW-7224-S-36

DW-7220-S-24	Double Face Starter	25 1/4"	19 1/2"	72"	9 1/2"	8	10			\$ 3,000	End, Mid, Top and Base Panels to be constructed from 1" thick 11-ply solid core, veneered 2 sides. Vertical, top and bottom edges banded with 1/4" external hardwood edging, edges to be eased. Front Edge: 3/4" thick x 2 1/2" high fascia - tongue and grooved to top.
DW-7220-A-24	Double Face Adder	24 1/4"	19 1/2"	72"	9 1/2"	8	10			\$ 2,324	
DW-7224-S-24	Double Face Starter	25 1/4"	23 1/2"	72"	11 1/2"	8	10			\$ 3,064	
DW-7224-A-24	Double Face Adder	24 1/4"	23 1/2"	72"	11 1/2"	8	10			\$ 2,379	
DW-7228-S-24	Double Face Starter	25 1/4"	28 1/2"	72"	14"	8	10			\$ 3,593	
DW-7228-A-24	Double Face Adder	24 1/4"	28 1/2"	72"	14"	8	10			\$ 2,846	

DW-7220-S-30	Double Face Starter	31 1/4"	19 1/2"	72"	9 1/2"	8	10			\$ 3,000
DW-7220-A-30	Double Face Adder	30 1/4"	19 1/2"	72"	9 1/2"	8	10			\$ 2,324
DW-7224-S-30	Double Face Starter	31 1/4"	23 1/2"	72"	11 1/2"	8	10			\$ 3,064
DW-7224-A-30	Double Face Adder	30 1/4"	23 1/2"	72"	11 1/2"	8	10			\$ 2,379
DW-7228-S-30	Double Face Starter	31 1/4"	28 1/2"	72"	14"	8	10			\$ 3,593
DW-7228-A-30	Double Face Adder	30 1/4"	28 1/2"	72"	14"	8	10			\$ 2,846



Model Shown  
DW-7224-A-36

DW-7220-S-36	Double Face Starter	37 1/4"	19 1/2"	72"	9 1/2"	8	10	200 Lbs.	12 Cu Ft	\$ 2,722
DW-7220-A-36	Double Face Adder	36 1/4"	19 1/2"	72"	9 1/2"	8	10	164 Lbs.	11 Cu Ft	\$ 2,045
DW-7224-S-36	Double Face Starter	37 1/4"	23 1/2"	72"	11 1/2"	8	10	229 Lbs.	13 Cu Ft	\$ 2,783
DW-7224-A-36	Double Face Adder	36 1/4"	23 1/2"	72"	11 1/2"	8	10	186 Lbs.	12 Cu Ft	\$ 2,107
DW-7228-S-36	Double Face Starter	37 1/4"	28 1/2"	72"	14"	8	10	256 Lbs.	14 Cu Ft	\$ 3,319
DW-7228-A-36	Double Face Adder	36 1/4"	28 1/2"	72"	14"	8	10	207 Lbs.	13 Cu Ft	\$ 2,566



Model Shown  
DW-8224-S-36

DW-8220-S-24	Double Face Starter	25 1/4"	19 1/2"	82"	9 1/2"	10	12			\$ 3,203
DW-8220-A-24	Double Face Adder	24 1/4"	19 1/2"	82"	9 1/2"	10	12			\$ 2,527
DW-8224-S-24	Double Face Starter	25 1/4"	23 1/2"	82"	11 1/2"	10	12			\$ 3,281
DW-8224-A-24	Double Face Adder	24 1/4"	23 1/2"	82"	11 1/2"	10	12			\$ 2,612
DW-8228-S-24	Double Face Starter	25 1/4"	28 1/2"	82"	14"	10	12			\$ 4,175
DW-8228-A-24	Double Face Adder	24 1/4"	28 1/2"	82"	14"	10	12			\$ 3,250

DW-8220-S-30	Double Face Starter	31 1/4"	19 1/2"	82"	9 1/2"	10	12			\$ 3,203
DW-8220-A-30	Double Face Adder	30 1/4"	19 1/2"	82"	9 1/2"	10	12			\$ 2,527
DW-8224-S-30	Double Face Starter	31 1/4"	23 1/2"	82"	11 1/2"	10	12			\$ 3,281
DW-8224-A-30	Double Face Adder	30 1/4"	23 1/2"	82"	11 1/2"	10	12			\$ 2,612
DW-8228-S-30	Double Face Starter	31 1/4"	28 1/2"	82"	14"	10	12			\$ 4,175
DW-8228-A-30	Double Face Adder	30 1/4"	28 1/2"	82"	14"	10	12			\$ 3,250



Model Shown  
DW-8224-A-36

DW-8220-S-36	Double Face Starter	37 1/4"	19 1/2"	82"	9 1/2"	10	12	224 Lbs.	12 Cu Ft	\$ 2,923
DW-8220-A-36	Double Face Adder	36 1/4"	19 1/2"	82"	9 1/2"	10	12	184 Lbs.	11 Cu Ft	\$ 2,246
DW-8224-S-36	Double Face Starter	37 1/4"	23 1/2"	82"	11 1/2"	10	12	256 Lbs.	14 Cu Ft	\$ 3,000
DW-8224-A-36	Double Face Adder	36 1/4"	23 1/2"	82"	11 1/2"	10	12	207 Lbs.	12 Cu Ft	\$ 2,332
DW-8228-S-36	Double Face Starter	37 1/4"	28 1/2"	82"	14"	10	12	289 Lbs.	16 Cu Ft	\$ 3,903
DW-8228-A-36	Double Face Adder	36 1/4"	28 1/2"	82"	14"	10	12	230 Lbs.	14 Cu Ft	\$ 2,977





Model Shown  
DW-9612-S-36







Model Shown  
DW-9612-A-36





MODEL NUMBER	PRODUCT	WIDTH	DEPTH	HEIGHT	SHELF DEPTH	# OF SHELVES	# OF OPENINGS	WEIGHT	VOLUME	LIST PRICE	DESCRIPTION
DW-9620-S-24	Double Face Starter	25 1/4"	19 1/2"	96"	9 1/2"	12	14			\$ 3,412	End, Mid, Top and Base Panels to be constructed from 1" thick 11-ply solid core, veneered 2 sides. Vertical, top and bottom edges banded with 1/4" external hardwood edging, edges to be eased. Front Edge: 3/4" thick x 2 1/2" high fascia - tongue and grooved to top.
DW-9620-A-24	Double Face Adder	24 1/4"	19 1/2"	96"	9 1/2"	12	14			\$ 2,736	
DW-9624-S-24	Double Face Starter	25 1/4"	23 1/2"	96"	11 1/2"	12	14			\$ 3,506	
DW-9624-A-24	Double Face Adder	24 1/4"	23 1/2"	96"	11 1/2"	12	14			\$ 2,836	
DW-9628-S-24	Double Face Starter	25 1/4"	28 1/2"	96"	14"	12	14			\$ 4,416	
DW-9628-A-24	Double Face Adder	24 1/4"	28 1/2"	96"	14"	12	14			\$ 3,514	
DW-9620-S-30	Double Face Starter	31 1/4"	19 1/2"	96"	9 1/2"	12	14			\$ 3,412	
DW-9620-A-30	Double Face Adder	30 1/4"	19 1/2"	96"	9 1/2"	12	14			\$ 2,736	
DW-9624-S-30	Double Face Starter	31 1/4"	23 1/2"	96"	11 1/2"	12	14			\$ 3,506	
DW-9624-A-30	Double Face Adder	30 1/4"	23 1/2"	96"	11 1/2"	12	14			\$ 2,836	
DW-9628-S-30	Double Face Starter	31 1/4"	28 1/2"	96"	14"	12	14			\$ 4,416	
DW-9628-A-30	Double Face Adder	30 1/4"	28 1/2"	96"	14"	12	14			\$ 3,514	
DW-9620-S-36	Double Face Starter	37 1/4"	19 1/2"	96"	9 1/2"	12	14	276 Lbs.	13 Cu Ft	\$ 3,134	
DW-9620-A-36	Double Face Adder	36 1/4"	19 1/2"	96"	9 1/2"	12	14	220 Lbs.	12 Cu Ft	\$ 2,463	
DW-9624-S-36	Double Face Starter	37 1/4"	23 1/2"	96"	11 1/2"	12	14	315 Lbs.	15 Cu Ft	\$ 3,227	
DW-9624-A-36	Double Face Adder	36 1/4"	23 1/2"	96"	11 1/2"	12	14	247 Lbs.	13 Cu Ft	\$ 2,558	
DW-9628-S-36	Double Face Starter	37 1/4"	28 1/2"	96"	14"	12	14	353 Lbs.	17 Cu Ft	\$ 4,143	
DW-9628-A-36	Double Face Adder	36 1/4"	28 1/2"	96"	14"	12	14	275 Lbs.	15 Cu Ft	\$ 3,234	







	MODEL NUMBER	PRODUCT	WIDTH	DEPTH	HEIGHT	SHELF DEPTH	# OF SHELVES	# OF OPENINGS	WEIGHT	VOLUME	LIST PRICE	DESCRIPTION
	DW-3010-S-24-IPT	Single Face Starter	25 <sup>1</sup> / <sub>4</sub> "	10 <sup>1</sup> / <sub>8</sub> "	30"	9 <sup>1</sup> / <sub>2</sub> "	1	2			\$ 1,493	End, Mid, Top and Base Panels to be constructed from 1" thick 11-ply solid core, veneered 2 sides. Vertical, top and bottom edges banded with 1/4" external hardwood edging, edges to be eased. Front Edge: 3/4" thick x 2 <sup>1</sup> / <sub>2</sub> " high fascia - tongue and grooved to top.
	DW-3010-A-24-IPT	Single Face Adder	24 <sup>1</sup> / <sub>4</sub> "	10 <sup>1</sup> / <sub>8</sub> "	30"	9 <sup>1</sup> / <sub>2</sub> "	1	2			\$ 1,143	
	DW-3012-S-24-IPT	Single Face Starter	25 <sup>1</sup> / <sub>4</sub> "	12 <sup>1</sup> / <sub>8</sub> "	30"	11 <sup>1</sup> / <sub>2</sub> "	1	2			\$ 2,682	
	DW-3012-A-24-IPT	Single Face Adder	24 <sup>1</sup> / <sub>4</sub> "	12 <sup>1</sup> / <sub>8</sub> "	30"	11 <sup>1</sup> / <sub>2</sub> "	1	2			\$ 1,205	
 Model Shown DW-3612-S-36-IPT	DW-3010-S-30-IPT	Single Face Starter	31 <sup>1</sup> / <sub>4</sub> "	10 <sup>1</sup> / <sub>8</sub> "	30"	9 <sup>1</sup> / <sub>2</sub> "	1	2			\$ 1,493	
	DW-3010-A-30-IPT	Single Face Adder	30 <sup>1</sup> / <sub>4</sub> "	10 <sup>1</sup> / <sub>8</sub> "	30"	9 <sup>1</sup> / <sub>2</sub> "	1	2			\$ 1,143	
	DW-3012-S-30-IPT	Single Face Starter	31 <sup>1</sup> / <sub>4</sub> "	12 <sup>1</sup> / <sub>8</sub> "	30"	11 <sup>1</sup> / <sub>2</sub> "	1	2			\$ 2,682	
	DW-3012-A-30-IPT	Single Face Adder	30 <sup>1</sup> / <sub>4</sub> "	12 <sup>1</sup> / <sub>8</sub> "	30"	11 <sup>1</sup> / <sub>2</sub> "	1	2			\$ 1,205	
 Model Shown DW-3612-A-36-IPT	DW-3010-S-36-IPT	Single Face Starter	37 <sup>1</sup> / <sub>4</sub> "	10 <sup>1</sup> / <sub>8</sub> "	30"	9 <sup>1</sup> / <sub>2</sub> "	1	2			\$ 1,313	
	DW-3010-A-36-IPT	Single Face Adder	36 <sup>1</sup> / <sub>4</sub> "	10 <sup>1</sup> / <sub>8</sub> "	30"	9 <sup>1</sup> / <sub>2</sub> "	1	2			\$ 964	
	DW-3012-S-36-IPT	Single Face Starter	37 <sup>1</sup> / <sub>4</sub> "	12 <sup>1</sup> / <sub>8</sub> "	30"	11 <sup>1</sup> / <sub>2</sub> "	1	2			\$ 1,360	
	DW-3012-A-36-IPT	Single Face Adder	36 <sup>1</sup> / <sub>4</sub> "	12 <sup>1</sup> / <sub>8</sub> "	30"	11 <sup>1</sup> / <sub>2</sub> "	1	2			\$ 1,383	
	DW-3610-S-24-IPT	Single Face Starter	25 <sup>1</sup> / <sub>4</sub> "	10 <sup>1</sup> / <sub>8</sub> "	36"	9 <sup>1</sup> / <sub>2</sub> "	1	2			\$ 1,439	
	DW-3610-A-24-IPT	Single Face Adder	24 <sup>1</sup> / <sub>4</sub> "	10 <sup>1</sup> / <sub>8</sub> "	36"	9 <sup>1</sup> / <sub>2</sub> "	1	2			\$ 1,065	
	DW-3612-S-24-IPT	Single Face Starter	25 <sup>1</sup> / <sub>4</sub> "	12 <sup>1</sup> / <sub>8</sub> "	36"	11 <sup>1</sup> / <sub>2</sub> "	1	2			\$ 1,493	
	DW-3612-A-24-IPT	Single Face Adder	24 <sup>1</sup> / <sub>4</sub> "	12 <sup>1</sup> / <sub>8</sub> "	36"	11 <sup>1</sup> / <sub>2</sub> "	1	2			\$ 1,105	
	DW-3614-S-24-IPT	Single Face Starter	25 <sup>1</sup> / <sub>4</sub> "	14 <sup>5</sup> / <sub>8</sub> "	36"	14"	1	2			\$ 1,656	
	DW-3614-A-24-IPT	Single Face Adder	24 <sup>1</sup> / <sub>4</sub> "	14 <sup>5</sup> / <sub>8</sub> "	36"	14"	1	2			\$ 1,229	
	DW-3610-S-30-IPT	Single Face Starter	31 <sup>1</sup> / <sub>4</sub> "	10 <sup>1</sup> / <sub>8</sub> "	36"	9 <sup>1</sup> / <sub>2</sub> "	1	2			\$ 1,439	
	DW-3610-A-30-IPT	Single Face Adder	30 <sup>1</sup> / <sub>4</sub> "	10 <sup>1</sup> / <sub>8</sub> "	36"	9 <sup>1</sup> / <sub>2</sub> "	1	2			\$ 1,065	
	DW-3612-S-30-IPT	Single Face Starter	31 <sup>1</sup> / <sub>4</sub> "	12 <sup>1</sup> / <sub>8</sub> "	36"	11 <sup>1</sup> / <sub>2</sub> "	1	2			\$ 1,493	
	DW-3612-A-30-IPT	Single Face Adder	30 <sup>1</sup> / <sub>4</sub> "	12 <sup>1</sup> / <sub>8</sub> "	36"	11 <sup>1</sup> / <sub>2</sub> "	1	2			\$ 1,105	
	DW-3614-S-30-IPT	Single Face Starter	31 <sup>1</sup> / <sub>4</sub> "	14 <sup>5</sup> / <sub>8</sub> "	36"	14"	1	2			\$ 1,656	
	DW-3614-A-30-IPT	Single Face Adder	30 <sup>1</sup> / <sub>4</sub> "	14 <sup>5</sup> / <sub>8</sub> "	36"	14"	1	2			\$ 1,229	
	DW-3610-S-36-IPT	Single Face Starter	37 <sup>1</sup> / <sub>4</sub> "	10 <sup>1</sup> / <sub>8</sub> "	36"	9 <sup>1</sup> / <sub>2</sub> "	1	2	50.6 Lbs.	4 Cu Ft	\$ 1,259	
	DW-3610-A-36-IPT	Single Face Adder	36 <sup>1</sup> / <sub>4</sub> "	10 <sup>1</sup> / <sub>8</sub> "	36"	9 <sup>1</sup> / <sub>2</sub> "	1	2	46 Lbs.	4 Cu Ft	\$ 887	
	DW-3612-S-36-IPT	Single Face Starter	37 <sup>1</sup> / <sub>4</sub> "	12 <sup>1</sup> / <sub>8</sub> "	36"	11 <sup>1</sup> / <sub>2</sub> "	1	2	50.6 Lbs.	5 Cu Ft	\$ 1,313	
	DW-3612-A-36-IPT	Single Face Adder	36 <sup>1</sup> / <sub>4</sub> "	12 <sup>1</sup> / <sub>8</sub> "	36"	11 <sup>1</sup> / <sub>2</sub> "	1	2	47.2 Lbs.	5 Cu Ft	\$ 918	
	DW-3614-S-36-IPT	Single Face Starter	37 <sup>1</sup> / <sub>4</sub> "	14 <sup>5</sup> / <sub>8</sub> "	36"	14"	1	2	74.8 Lbs.	6 Cu Ft	\$ 1,469	
	DW-3614-A-36-IPT	Single Face Adder	36 <sup>1</sup> / <sub>4</sub> "	14 <sup>5</sup> / <sub>8</sub> "	36"	14"	1	2	63.3 Lbs.	6 Cu Ft	\$ 1,049	

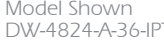



	MODEL NUMBER	PRODUCT	WIDTH	DEPTH	HEIGHT	SHELF DEPTH	# OF SHELVES	# OF OPENINGS	WEIGHT	VOLUME	LIST PRICE	DESCRIPTION
 Model Shown DW-4824-S-36-IPT	DW-4210-S-24-IPT	Single Face Starter	25 <sup>1</sup> / <sub>4</sub> "	10 <sup>1</sup> / <sub>8</sub> "	42"	9 <sup>1</sup> / <sub>2</sub> "	2	3			\$ 1,547	End, Mid, Top and Base Panels to be constructed from 1" thick 11-ply solid core, veneered 2 sides. Vertical, top and bottom edges banded with 1/4" external hardwood edging, edges to be eased. Front Edge: 3/4" thick x 2 1/2" high fascia - tongue and grooved to top.
	DW-4210-A-24-IPT	Single Face Adder	24 <sup>1</sup> / <sub>4</sub> "	10 <sup>1</sup> / <sub>8</sub> "	42"	9 <sup>1</sup> / <sub>2</sub> "	2	3			\$ 1,182	
	DW-4212-S-24-IPT	Single Face Starter	25 <sup>1</sup> / <sub>4</sub> "	12 <sup>1</sup> / <sub>8</sub> "	42"	11 <sup>1</sup> / <sub>2</sub> "	2	3			\$ 1,602	
	DW-4212-A-24-IPT	Single Face Adder	24 <sup>1</sup> / <sub>4</sub> "	12 <sup>1</sup> / <sub>8</sub> "	42"	11 <sup>1</sup> / <sub>2</sub> "	2	3			\$ 1,212	
	DW-4214-S-24-IPT	Single Face Starter	25 <sup>1</sup> / <sub>4</sub> "	14 <sup>5</sup> / <sub>8</sub> "	42"	14"	2	3			\$ 1,804	
	DW-4214-A-24-IPT	Single Face Adder	24 <sup>1</sup> / <sub>4</sub> "	14 <sup>5</sup> / <sub>8</sub> "	42"	14"	2	3			\$ 1,375	
	DW-4210-S-30-IPT	Single Face Starter	31 <sup>1</sup> / <sub>4</sub> "	10 <sup>1</sup> / <sub>8</sub> "	42"	9 <sup>1</sup> / <sub>2</sub> "	2	3			\$ 1,547	
	DW-4210-A-30-IPT	Single Face Adder	30 <sup>1</sup> / <sub>4</sub> "	10 <sup>1</sup> / <sub>8</sub> "	42"	9 <sup>1</sup> / <sub>2</sub> "	2	3			\$ 1,182	
DW-4212-S-30-IPT	Single Face Starter	31 <sup>1</sup> / <sub>4</sub> "	12 <sup>1</sup> / <sub>8</sub> "	42"	11 <sup>1</sup> / <sub>2</sub> "	2	3			\$ 1,602		
DW-4212-A-30-IPT	Single Face Adder	30 <sup>1</sup> / <sub>4</sub> "	12 <sup>1</sup> / <sub>8</sub> "	42"	11 <sup>1</sup> / <sub>2</sub> "	2	3			\$ 1,212		
DW-4214-S-30-IPT	Single Face Starter	31 <sup>1</sup> / <sub>4</sub> "	14 <sup>5</sup> / <sub>8</sub> "	42"	14"	2	3			\$ 1,804		
DW-4214-A-30-IPT	Single Face Adder	30 <sup>1</sup> / <sub>4</sub> "	14 <sup>5</sup> / <sub>8</sub> "	42"	14"	2	3			\$ 1,375		
 Model Shown DW-4824-A-36-IPT	DW-4210-S-36-IPT	Single Face Starter	37 <sup>1</sup> / <sub>4</sub> "	10 <sup>1</sup> / <sub>8</sub> "	42"	9 <sup>1</sup> / <sub>2</sub> "	2	3	55 Lbs.	5 Cu Ft	\$ 1,360	
	DW-4210-A-36-IPT	Single Face Adder	36 <sup>1</sup> / <sub>4</sub> "	10 <sup>1</sup> / <sub>8</sub> "	42"	9 <sup>1</sup> / <sub>2</sub> "	2	3	52 Lbs.	5 Cu Ft	\$ 995	
	DW-4212-S-36-IPT	Single Face Starter	37 <sup>1</sup> / <sub>4</sub> "	12 <sup>1</sup> / <sub>8</sub> "	42"	11 <sup>1</sup> / <sub>2</sub> "	2	3	60 Lbs.	5 Cu Ft	\$ 1,423	
	DW-4212-A-36-IPT	Single Face Adder	36 <sup>1</sup> / <sub>4</sub> "	12 <sup>1</sup> / <sub>8</sub> "	42"	11 <sup>1</sup> / <sub>2</sub> "	2	3	53 Lbs.	5 Cu Ft	\$ 1,027	
	DW-4214-S-36-IPT	Single Face Starter	37 <sup>1</sup> / <sub>4</sub> "	14 <sup>5</sup> / <sub>8</sub> "	42"	14"	2	3	79 Lbs.	6 Cu Ft	\$ 1,617	
	DW-4214-A-36-IPT	Single Face Adder	36 <sup>1</sup> / <sub>4</sub> "	14 <sup>5</sup> / <sub>8</sub> "	42"	14"	2	3	68 Lbs.	6 Cu Ft	\$ 1,189	
	DW-4810-S-24-IPT	Single Face Starter	25 <sup>1</sup> / <sub>4</sub> "	10 <sup>1</sup> / <sub>8</sub> "	48"	9 <sup>1</sup> / <sub>2</sub> "	2	3			\$ 1,624	
	DW-4810-A-24-IPT	Single Face Adder	24 <sup>1</sup> / <sub>4</sub> "	10 <sup>1</sup> / <sub>8</sub> "	48"	9 <sup>1</sup> / <sub>2</sub> "	2	3			\$ 1,236	
DW-4812-S-24-IPT	Single Face Starter	25 <sup>1</sup> / <sub>4</sub> "	12 <sup>1</sup> / <sub>8</sub> "	48"	11 <sup>1</sup> / <sub>2</sub> "	2	3			\$ 1,641		
DW-4812-A-24-IPT	Single Face Adder	24 <sup>1</sup> / <sub>4</sub> "	12 <sup>1</sup> / <sub>8</sub> "	48"	11 <sup>1</sup> / <sub>2</sub> "	2	3			\$ 1,236		
DW-4814-S-24-IPT	Single Face Starter	25 <sup>1</sup> / <sub>4</sub> "	14 <sup>5</sup> / <sub>8</sub> "	48"	14"	2	3			\$ 1,841		
DW-4814-A-24-IPT	Single Face Adder	24 <sup>1</sup> / <sub>4</sub> "	14 <sup>5</sup> / <sub>8</sub> "	48"	14"	2	3			\$ 1,406		
DW-4810-S-30-IPT	Single Face Starter	31 <sup>1</sup> / <sub>4</sub> "	10 <sup>1</sup> / <sub>8</sub> "	48"	9 <sup>1</sup> / <sub>2</sub> "	2	3			\$ 1,624		
DW-4810-A-30-IPT	Single Face Adder	30 <sup>1</sup> / <sub>4</sub> "	10 <sup>1</sup> / <sub>8</sub> "	48"	9 <sup>1</sup> / <sub>2</sub> "	2	3			\$ 1,236		
DW-4812-S-30-IPT	Single Face Starter	31 <sup>1</sup> / <sub>4</sub> "	12 <sup>1</sup> / <sub>8</sub> "	48"	11 <sup>1</sup> / <sub>2</sub> "	2	3			\$ 1,641		
DW-4812-A-30-IPT	Single Face Adder	30 <sup>1</sup> / <sub>4</sub> "	12 <sup>1</sup> / <sub>8</sub> "	48"	11 <sup>1</sup> / <sub>2</sub> "	2	3			\$ 1,236		
DW-4814-S-30-IPT	Single Face Starter	31 <sup>1</sup> / <sub>4</sub> "	14 <sup>5</sup> / <sub>8</sub> "	48"	14"	2	3			\$ 1,841		
DW-4814-A-30-IPT	Single Face Adder	30 <sup>1</sup> / <sub>4</sub> "	14 <sup>5</sup> / <sub>8</sub> "	48"	14"	2	3			\$ 1,406		
DW-4810-S-36-IPT	Single Face Starter	37 <sup>1</sup> / <sub>4</sub> "	10 <sup>1</sup> / <sub>8</sub> "	48"	9 <sup>1</sup> / <sub>2</sub> "	2	3	74.8 Lbs.	5 Cu Ft	\$ 1,439		
DW-4810-A-36-IPT	Single Face Adder	36 <sup>1</sup> / <sub>4</sub> "	10 <sup>1</sup> / <sub>8</sub> "	48"	9 <sup>1</sup> / <sub>2</sub> "	2	3	65.5 Lbs.	5 Cu Ft	\$ 1,049		
DW-4812-S-36-IPT	Single Face Starter	37 <sup>1</sup> / <sub>4</sub> "	12 <sup>1</sup> / <sub>8</sub> "	48"	11 <sup>1</sup> / <sub>2</sub> "	2	3	82.8 Lbs.	6 Cu Ft	\$ 1,462		
DW-4812-A-36-IPT	Single Face Adder	36 <sup>1</sup> / <sub>4</sub> "	12 <sup>1</sup> / <sub>8</sub> "	48"	11 <sup>1</sup> / <sub>2</sub> "	2	3	71.3 Lbs.	6 Cu Ft	\$ 1,049		
DW-4814-S-36-IPT	Single Face Starter	37 <sup>1</sup> / <sub>4</sub> "	14 <sup>5</sup> / <sub>8</sub> "	48"	14"	2	3	108 Lbs.	7 Cu Ft	\$ 1,664		
DW-4814-A-36-IPT	Single Face Adder	36 <sup>1</sup> / <sub>4</sub> "	14 <sup>5</sup> / <sub>8</sub> "	48"	14"	2	3	92 Lbs.	7 Cu Ft	\$ 1,220		



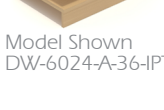

	MODEL NUMBER	PRODUCT	WIDTH	DEPTH	HEIGHT	SHELF DEPTH	# OF SHELVES	# OF OPENINGS	WEIGHT	VOLUME	LIST PRICE	DESCRIPTION
	DW-6010-S-24-IPT	Single Face Starter	25 1/4"	10 1/8"	60"	9 1/2"	3	4			\$ 1,656	End, Mid, Top and Base Panels to be constructed from 1" thick 11-ply solid core, veneered 2 sides. Vertical, top and bottom edges banded with 1/4" external hardwood edging, edges to be eased. Front Edge: 3/4" thick x 2 1/2" high fascia - tongue and grooved to top.
	DW-6010-A-24-IPT	Single Face Adder	24 1/4"	10 1/8"	60"	9 1/2"	3	4			\$ 1,282	
	DW-6012-S-24-IPT	Single Face Starter	25 1/4"	12 1/8"	60"	11 1/2"	3	4			\$ 1,710	
	DW-6012-A-24-IPT	Single Face Adder	24 1/4"	12 1/8"	60"	11 1/2"	3	4			\$ 1,323	
	DW-6014-S-24-IPT	Single Face Starter	25 1/4"	14 5/8"	60"	14"	3	4			\$ 1,945	
	DW-6014-A-24-IPT	Single Face Adder	24 1/4"	14 5/8"	60"	14"	3	4			\$ 1,524	
	DW-6010-S-30-IPT	Single Face Starter	31 1/4"	10 1/8"	60"	9 1/2"	3	4			\$ 1,656	
	DW-6010-A-30-IPT	Single Face Adder	30 1/4"	10 1/8"	60"	9 1/2"	3	4			\$ 1,282	
	DW-6012-S-30-IPT	Single Face Starter	31 1/4"	12 1/8"	60"	11 1/2"	3	4			\$ 1,710	
	DW-6012-A-30-IPT	Single Face Adder	30 1/4"	12 1/8"	60"	11 1/2"	3	4			\$ 1,323	
	DW-6014-S-30-IPT	Single Face Starter	31 1/4"	14 5/8"	60"	14"	3	4			\$ 1,945	
	DW-6014-A-30-IPT	Single Face Adder	30 1/4"	14 5/8"	60"	14"	3	4			\$ 1,524	
	DW-6010-S-36-IPT	Single Face Starter	37 1/4"	10 1/8"	60"	9 1/2"	3	4	100 Lbs.	6 Cu Ft	\$ 1,478	
	DW-6010-A-36-IPT	Single Face Adder	36 1/4"	10 1/8"	60"	9 1/2"	3	4	86.3 Lbs.	6 Cu Ft	\$ 1,105	
	DW-6012-S-36-IPT	Single Face Starter	37 1/4"	12 1/8"	60"	11 1/2"	3	4	116 Lbs.	8 Cu Ft	\$ 1,531	
	DW-6012-A-36-IPT	Single Face Adder	36 1/4"	12 1/8"	60"	11 1/2"	3	4	95.5 Lbs.	7 Cu Ft	\$ 1,143	
	DW-6014-S-36-IPT	Single Face Starter	37 1/4"	14 5/8"	60"	14"	3	4	141 Lbs.	9 Cu Ft	\$ 1,765	
	DW-6014-A-36-IPT	Single Face Adder	36 1/4"	14 5/8"	60"	14"	3	4	121 Lbs.	8 Cu Ft	\$ 1,336	







	MODEL NUMBER	PRODUCT	WIDTH	DEPTH	HEIGHT	SHELF DEPTH	# OF SHELVES	# OF OPENINGS	WEIGHT	VOLUME	LIST PRICE	DESCRIPTION
 <p>Model Shown DW-3624-S-36-IPT</p>	DW-3620-S-24-IPT	Double Face Starter	25 1/4"	19 1/2"	36"	9 1/2"	2	4			\$ 2,566	End, Mid, Top and Base Panels to be constructed from 1" thick 11-ply solid core, veneered 2 sides. Vertical, top and bottom edges banded with 1/4" external hardwood edging, edges to be eased. Front Edge: 3/4" thick x 2 1/2" high fascia - tongue and grooved to top.
	DW-3620-A-24-IPT	Double Face Adder	24 1/4"	19 1/2"	36"	9 1/2"	2	4			\$ 1,920	
	DW-3624-S-24-IPT	Double Face Starter	25 1/4"	23 1/2"	36"	11 1/2"	2	4			\$ 2,612	
	DW-3624-A-24-IPT	Double Face Adder	24 1/4"	23 1/2"	36"	11 1/2"	2	4			\$ 1,935	
	DW-3628-S-24-IPT	Double Face Starter	25 1/4"	28 1/2"	36"	14"	2	4			\$ 2,977	
	DW-3628-A-24-IPT	Double Face Adder	24 1/4"	28 1/2"	36"	14"	2	4			\$ 2,239	
 <p>Model Shown DW-3624-A-36-IPT</p>	DW-3620-S-30-IPT	Double Face Starter	31 1/4"	19 1/2"	36"	9 1/2"	2	4			\$ 2,566	
	DW-3620-A-30-IPT	Double Face Adder	30 1/4"	19 1/2"	36"	9 1/2"	2	4			\$ 1,920	
	DW-3624-S-30-IPT	Double Face Starter	31 1/4"	23 1/2"	36"	11 1/2"	2	4			\$ 2,612	
	DW-3624-A-30-IPT	Double Face Adder	30 1/4"	23 1/2"	36"	11 1/2"	2	4			\$ 1,935	
	DW-3628-S-30-IPT	Double Face Starter	31 1/4"	28 1/2"	36"	14"	2	4			\$ 2,977	
	DW-3628-A-30-IPT	Double Face Adder	30 1/4"	28 1/2"	36"	14"	2	4			\$ 2,239	
	DW-3620-S-36-IPT	Double Face Starter	37 1/4"	19 1/2"	36"	9 1/2"	2	4	88.6 Lbs.	7 Cu Ft	\$ 2,293	
	DW-3620-A-36-IPT	Double Face Adder	36 1/4"	19 1/2"	36"	9 1/2"	2	4	73.6 Lbs.	6 Cu Ft	\$ 1,641	
	DW-3624-S-36-IPT	Double Face Starter	37 1/4"	23 1/2"	36"	11 1/2"	2	4	110 Lbs.	10 Cu Ft	\$ 2,339	
	DW-3624-A-36-IPT	Double Face Adder	36 1/4"	23 1/2"	36"	11 1/2"	2	4	88.6 Lbs.	9 Cu Ft	\$ 1,664	
	DW-3628-S-36-IPT	Double Face Starter	37 1/4"	28 1/2"	36"	14"	2	4	132 Lbs.	11 Cu Ft	\$ 2,698	
	DW-3628-A-36-IPT	Double Face Adder	36 1/4"	28 1/2"	36"	14"	2	4	104 Lbs.	10 Cu Ft	\$ 1,958	
 <p>Model Shown DW-4824-S-36-IPT</p>	DW-4220-S-24-IPT	Double Face Starter	25 1/4"	19 1/2"	42"	9 1/2"	4	6			\$ 2,783	
	DW-4220-A-24-IPT	Double Face Adder	24 1/4"	19 1/2"	42"	9 1/2"	4	6			\$ 2,139	
	DW-4224-S-24-IPT	Double Face Starter	25 1/4"	23 1/2"	42"	11 1/2"	4	6			\$ 2,846	
	DW-4224-A-24-IPT	Double Face Adder	24 1/4"	23 1/2"	42"	11 1/2"	4	6			\$ 2,169	
	DW-4228-S-24-IPT	Double Face Starter	25 1/4"	28 1/2"	42"	14"	4	6			\$ 3,281	
	DW-4228-A-24-IPT	Double Face Adder	24 1/4"	28 1/2"	42"	14"	4	6			\$ 2,542	
 <p>Model Shown DW-4824-A-36-IPT</p>	DW-4220-S-30-IPT	Double Face Starter	31 1/4"	19 1/2"	42"	9 1/2"	4	6			\$ 2,783	
	DW-4220-A-30-IPT	Double Face Adder	30 1/4"	19 1/2"	42"	9 1/2"	4	6			\$ 2,139	
	DW-4224-S-30-IPT	Double Face Starter	31 1/4"	23 1/2"	42"	11 1/2"	4	6			\$ 2,846	
	DW-4224-A-30-IPT	Double Face Adder	30 1/4"	23 1/2"	42"	11 1/2"	4	6			\$ 2,169	
	DW-4228-S-30-IPT	Double Face Starter	31 1/4"	28 1/2"	42"	14"	4	6			\$ 3,281	
	DW-4228-A-30-IPT	Double Face Adder	30 1/4"	28 1/2"	42"	14"	4	6			\$ 2,542	
 <p>Model Shown DW-4824-A-36-IPT</p>	DW-4220-S-36-IPT	Double Face Starter	37 1/4"	19 1/2"	42"	9 1/2"	4	6	94 Lbs.	7 Cu Ft	\$ 2,512	
	DW-4220-A-36-IPT	Double Face Adder	36 1/4"	19 1/2"	42"	9 1/2"	4	6	78 Lbs.	7 Cu Ft	\$ 1,858	
	DW-4224-S-36-IPT	Double Face Starter	37 1/4"	23 1/2"	42"	11 1/2"	4	6	115 Lbs.	10 Cu Ft	\$ 2,566	
	DW-4224-A-36-IPT	Double Face Adder	36 1/4"	23 1/2"	42"	11 1/2"	4	6	113 Lbs.	10 Cu Ft	\$ 1,889	
	DW-4228-S-36-IPT	Double Face Starter	37 1/4"	28 1/2"	42"	14"	4	6	183 Lbs.	13 Cu Ft	\$ 3,000	
	DW-4228-A-36-IPT	Double Face Adder	36 1/4"	28 1/2"	42"	14"	4	6	109 Lbs.	13 Cu Ft	\$ 2,263	



	MODEL NUMBER	PRODUCT	WIDTH	DEPTH	HEIGHT	SHELF DEPTH	# OF SHELVES	# OF OPENINGS	WEIGHT	VOLUME	LIST PRICE	DESCRIPTION
	DW-4820-S-24-IPT	Double Face Starter	25 1/4"	19 1/2"	48"	9 1/2"	4	6			\$ 2,876	End, Mid, Top and Base Panels to be constructed from 1" thick 11-ply solid core, veneered 2 sides. Vertical, top and bottom edges banded with 1/4" external hardwood edging, edges to be eased. Front Edge: 3/4" thick x 2 1/2" high fascia - tongue and grooved to top.
	DW-4820-A-24-IPT	Double Face Adder	24 1/4"	19 1/2"	48"	9 1/2"	4	6			\$ 2,200	
	DW-4824-S-24-IPT	Double Face Starter	25 1/4"	23 1/2"	48"	11 1/2"	4	6			\$ 2,939	
	DW-4824-A-24-IPT	Double Face Adder	24 1/4"	23 1/2"	48"	11 1/2"	4	6			\$ 2,231	
	DW-4828-S-24-IPT	Double Face Starter	25 1/4"	28 1/2"	48"	14"	4	6			\$ 3,389	
	DW-4828-A-24-IPT	Double Face Adder	24 1/4"	28 1/2"	48"	14"	4	6			\$ 2,619	
	DW-4820-S-30-IPT	Double Face Starter	31 1/4"	19 1/2"	48"	9 1/2"	4	6			\$ 2,876	
	DW-4820-A-30-IPT	Double Face Adder	30 1/4"	19 1/2"	48"	9 1/2"	4	6			\$ 2,200	
	DW-4824-S-30-IPT	Double Face Starter	31 1/4"	23 1/2"	48"	11 1/2"	4	6			\$ 2,939	
	DW-4824-A-30-IPT	Double Face Adder	30 1/4"	23 1/2"	48"	11 1/2"	4	6			\$ 2,231	
	DW-4828-S-30-IPT	Double Face Starter	31 1/4"	28 1/2"	48"	14"	4	6			\$ 3,389	
	DW-4828-A-30-IPT	Double Face Adder	30 1/4"	28 1/2"	48"	14"	4	6			\$ 2,619	
	DW-4820-S-36-IPT	Double Face Starter	37 1/4"	19 1/2"	48"	9 1/2"	4	6	132 Lbs.	9 Cu Ft	\$ 2,598	
	DW-4820-A-36-IPT	Double Face Adder	36 1/4"	19 1/2"	48"	9 1/2"	4	6	109 Lbs.	8 Cu Ft	\$ 1,929	
	DW-4824-S-36-IPT	Double Face Starter	37 1/4"	23 1/2"	48"	11 1/2"	4	6	155 Lbs.	11 Cu Ft	\$ 2,659	
	DW-4824-A-36-IPT	Double Face Adder	36 1/4"	23 1/2"	48"	11 1/2"	4	6	127 Lbs.	10 Cu Ft	\$ 1,958	
	DW-4828-S-36-IPT	Double Face Starter	37 1/4"	28 1/2"	48"	14"	4	6	178 Lbs.	13 Cu Ft	\$ 3,116	
	DW-4828-A-36-IPT	Double Face Adder	36 1/4"	28 1/2"	48"	14"	4	6	144 Lbs.	12 Cu Ft	\$ 2,348	
	DW-6020-S-24-IPT	Double Face Starter	25 1/4"	19 1/2"	60"	9 1/2"	6	8			\$ 2,970	
	DW-6020-A-24-IPT	Double Face Adder	24 1/4"	19 1/2"	60"	9 1/2"	6	8			\$ 2,301	
	DW-6024-S-24-IPT	Double Face Starter	25 1/4"	23 1/2"	60"	11 1/2"	6	8			\$ 3,033	
	DW-6024-A-24-IPT	Double Face Adder	24 1/4"	23 1/2"	60"	11 1/2"	6	8			\$ 2,356	
	DW-6028-S-24-IPT	Double Face Starter	25 1/4"	28 1/2"	60"	14"	6	8			\$ 3,536	
	DW-6028-A-24-IPT	Double Face Adder	24 1/4"	28 1/2"	60"	14"	6	8			\$ 2,775	
	DW-6020-S-30-IPT	Double Face Starter	31 1/4"	19 1/2"	60"	9 1/2"	6	8			\$ 2,970	
	DW-6020-A-30-IPT	Double Face Adder	30 1/4"	19 1/2"	60"	9 1/2"	6	8			\$ 2,301	
	DW-6024-S-30-IPT	Double Face Starter	31 1/4"	23 1/2"	60"	11 1/2"	6	8			\$ 3,033	
	DW-6024-A-30-IPT	Double Face Adder	30 1/4"	23 1/2"	60"	11 1/2"	6	8			\$ 2,356	
	DW-6028-S-30-IPT	Double Face Starter	31 1/4"	28 1/2"	60"	14"	6	8			\$ 3,536	
	DW-6028-A-30-IPT	Double Face Adder	30 1/4"	28 1/2"	60"	14"	6	8			\$ 2,775	
	DW-6020-S-36-IPT	Double Face Starter	37 1/4"	19 1/2"	60"	9 1/2"	6	8	176 Lbs.	11 Cu Ft	\$ 2,690	
	DW-6020-A-36-IPT	Double Face Adder	36 1/4"	19 1/2"	60"	9 1/2"	6	8	145 Lbs.	10 Cu Ft	\$ 2,022	
	DW-6024-S-36-IPT	Double Face Starter	37 1/4"	23 1/2"	60"	11 1/2"	6	8	200 Lbs.	12 Cu Ft	\$ 2,752	
	DW-6024-A-36-IPT	Double Face Adder	36 1/4"	23 1/2"	60"	11 1/2"	6	8	164 Lbs.	11 Cu Ft	\$ 2,076	
	DW-6028-S-36-IPT	Double Face Starter	37 1/4"	28 1/2"	60"	14"	6	8	224 Lbs.	13 Cu Ft	\$ 3,258	
	DW-6028-A-36-IPT	Double Face Adder	36 1/4"	28 1/2"	60"	14"	6	8	184 Lbs.	12 Cu Ft	\$ 2,494	

MODEL NUMBER	PRODUCT	WIDTH	DEPTH	HEIGHT	SHELF DEPTH	# OF SHELVES	# OF OPENINGS	WEIGHT	VOLUME	LIST PRICE	DESCRIPTION
 Model Shown DW-3612-S-36-WG	DW-3610-S-24-WG	Single Face Starter	25 <sup>1</sup> / <sub>4</sub> "	10 <sup>1</sup> / <sub>8</sub> "	36"	8 <sup>1</sup> / <sub>2</sub> "	1			\$ 2,512	End, Mid, Top and Base Panels to be constructed from 1" thick 11-ply solid core, veneered 2 sides. Vertical, top and bottom edges banded with 1/4" external hardwood edging, edges to be eased. Front Edge: 3/4" thick x 2 1/2" high fascia - tongue and grooved to top.
	DW-3610-A-24-WG	Single Face Adder	24 <sup>1</sup> / <sub>4</sub> "	10 <sup>1</sup> / <sub>8</sub> "	36"	8 <sup>1</sup> / <sub>2</sub> "	1			\$ 2,139	
	DW-3612-S-24-WG	Single Face Starter	25 <sup>1</sup> / <sub>4</sub> "	12 <sup>1</sup> / <sub>8</sub> "	36"	10 <sup>1</sup> / <sub>2</sub> "	1			\$ 2,566	
	DW-3612-A-24-WG	Single Face Adder	24 <sup>1</sup> / <sub>4</sub> "	12 <sup>1</sup> / <sub>8</sub> "	36"	10 <sup>1</sup> / <sub>2</sub> "	1			\$ 2,177	
	DW-3614-S-24-WG	Single Face Starter	25 <sup>1</sup> / <sub>4</sub> "	14 <sup>5</sup> / <sub>8</sub> "	36"	13 <sup>1</sup> / <sub>2</sub> "	1			\$ 2,729	
	DW-3614-A-24-WG	Single Face Adder	24 <sup>1</sup> / <sub>4</sub> "	14 <sup>5</sup> / <sub>8</sub> "	36"	13 <sup>1</sup> / <sub>2</sub> "	1			\$ 2,301	
 Model Shown DW-3612-A-36-WG	DW-3610-S-30-WG	Single Face Starter	31 <sup>1</sup> / <sub>4</sub> "	10 <sup>1</sup> / <sub>8</sub> "	36"	8 <sup>1</sup> / <sub>2</sub> "	1			\$ 2,512	
	DW-3610-A-30-WG	Single Face Adder	30 <sup>1</sup> / <sub>4</sub> "	10 <sup>1</sup> / <sub>8</sub> "	36"	8 <sup>1</sup> / <sub>2</sub> "	1			\$ 2,139	
	DW-3612-S-30-WG	Single Face Starter	31 <sup>1</sup> / <sub>4</sub> "	12 <sup>1</sup> / <sub>8</sub> "	36"	10 <sup>1</sup> / <sub>2</sub> "	1			\$ 2,566	
	DW-3612-A-30-WG	Single Face Adder	30 <sup>1</sup> / <sub>4</sub> "	12 <sup>1</sup> / <sub>8</sub> "	36"	10 <sup>1</sup> / <sub>2</sub> "	1			\$ 2,177	
	DW-3614-S-30-WG	Single Face Starter	31 <sup>1</sup> / <sub>4</sub> "	14 <sup>5</sup> / <sub>8</sub> "	36"	13 <sup>1</sup> / <sub>2</sub> "	1			\$ 2,729	
	DW-3614-A-30-WG	Single Face Adder	30 <sup>1</sup> / <sub>4</sub> "	14 <sup>5</sup> / <sub>8</sub> "	36"	13 <sup>1</sup> / <sub>2</sub> "	1			\$ 2,301	
	DW-3610-S-36-WG	Single Face Starter	37 <sup>1</sup> / <sub>4</sub> "	10 <sup>1</sup> / <sub>8</sub> "	36"	8 <sup>1</sup> / <sub>2</sub> "	1			\$ 2,332	
	DW-3610-A-36-WG	Single Face Adder	36 <sup>1</sup> / <sub>4</sub> "	10 <sup>1</sup> / <sub>8</sub> "	36"	8 <sup>1</sup> / <sub>2</sub> "	1	50.6 Lbs.	4 Cu Ft	\$ 1,958	
	DW-3612-S-36-WG	Single Face Starter	37 <sup>1</sup> / <sub>4</sub> "	12 <sup>1</sup> / <sub>8</sub> "	36"	10 <sup>1</sup> / <sub>2</sub> "	1	46 Lbs.	4 Cu Ft	\$ 2,387	
	DW-3612-A-36-WG	Single Face Adder	36 <sup>1</sup> / <sub>4</sub> "	12 <sup>1</sup> / <sub>8</sub> "	36"	10 <sup>1</sup> / <sub>2</sub> "	1	50.6 Lbs.	5 Cu Ft	\$ 1,989	
	DW-3614-S-36-WG	Single Face Starter	37 <sup>1</sup> / <sub>4</sub> "	14 <sup>5</sup> / <sub>8</sub> "	36"	13 <sup>1</sup> / <sub>2</sub> "	1	47.2 Lbs.	5 Cu Ft	\$ 2,542	
	DW-3614-A-36-WG	Single Face Adder	36 <sup>1</sup> / <sub>4</sub> "	14 <sup>5</sup> / <sub>8</sub> "	36"	13 <sup>1</sup> / <sub>2</sub> "	1	74.8 Lbs.	6 Cu Ft	\$ 2,122	
 Model Shown DW-4212-S-36-WG	DW-4210-S-24-WG	Single Face Starter	25 <sup>1</sup> / <sub>4</sub> "	10 <sup>1</sup> / <sub>8</sub> "	42"	8 <sup>1</sup> / <sub>2</sub> "	2			\$ 2,619	
	DW-4210-A-24-WG	Single Face Adder	24 <sup>1</sup> / <sub>4</sub> "	10 <sup>1</sup> / <sub>8</sub> "	42"	8 <sup>1</sup> / <sub>2</sub> "	2			\$ 2,254	
	DW-4212-S-24-WG	Single Face Starter	25 <sup>1</sup> / <sub>4</sub> "	12 <sup>1</sup> / <sub>8</sub> "	42"	10 <sup>1</sup> / <sub>2</sub> "	2			\$ 2,675	
	DW-4212-A-24-WG	Single Face Adder	24 <sup>1</sup> / <sub>4</sub> "	12 <sup>1</sup> / <sub>8</sub> "	42"	10 <sup>1</sup> / <sub>2</sub> "	2			\$ 2,286	
	DW-4214-S-24-WG	Single Face Starter	25 <sup>1</sup> / <sub>4</sub> "	14 <sup>5</sup> / <sub>8</sub> "	42"	13 <sup>1</sup> / <sub>2</sub> "	2			\$ 2,876	
	DW-4214-A-24-WG	Single Face Adder	24 <sup>1</sup> / <sub>4</sub> "	14 <sup>5</sup> / <sub>8</sub> "	42"	13 <sup>1</sup> / <sub>2</sub> "	2			\$ 2,448	
 Model Shown DW-4212-A-36-WG	DW-4210-S-30-WG	Single Face Starter	31 <sup>1</sup> / <sub>4</sub> "	10 <sup>1</sup> / <sub>8</sub> "	42"	8 <sup>1</sup> / <sub>2</sub> "	2			\$ 2,619	
	DW-4210-A-30-WG	Single Face Adder	30 <sup>1</sup> / <sub>4</sub> "	10 <sup>1</sup> / <sub>8</sub> "	42"	8 <sup>1</sup> / <sub>2</sub> "	2			\$ 2,254	
	DW-4212-S-30-WG	Single Face Starter	31 <sup>1</sup> / <sub>4</sub> "	12 <sup>1</sup> / <sub>8</sub> "	42"	10 <sup>1</sup> / <sub>2</sub> "	2			\$ 2,675	
	DW-4212-A-30-WG	Single Face Adder	30 <sup>1</sup> / <sub>4</sub> "	12 <sup>1</sup> / <sub>8</sub> "	42"	10 <sup>1</sup> / <sub>2</sub> "	2			\$ 2,286	
	DW-4214-S-30-WG	Single Face Starter	31 <sup>1</sup> / <sub>4</sub> "	14 <sup>5</sup> / <sub>8</sub> "	42"	13 <sup>1</sup> / <sub>2</sub> "	2			\$ 2,876	
	DW-4214-A-30-WG	Single Face Adder	30 <sup>1</sup> / <sub>4</sub> "	14 <sup>5</sup> / <sub>8</sub> "	42"	13 <sup>1</sup> / <sub>2</sub> "	2			\$ 2,448	
	DW-4210-S-36-WG	Single Face Starter	37 <sup>1</sup> / <sub>4</sub> "	10 <sup>1</sup> / <sub>8</sub> "	42"	8 <sup>1</sup> / <sub>2</sub> "	2			\$ 2,433	
	DW-4210-A-36-WG	Single Face Adder	36 <sup>1</sup> / <sub>4</sub> "	10 <sup>1</sup> / <sub>8</sub> "	42"	8 <sup>1</sup> / <sub>2</sub> "	2	55 Lbs.	5 Cu Ft	\$ 2,069	
	DW-4212-S-36-WG	Single Face Starter	37 <sup>1</sup> / <sub>4</sub> "	12 <sup>1</sup> / <sub>8</sub> "	42"	10 <sup>1</sup> / <sub>2</sub> "	2	52 Lbs.	5 Cu Ft	\$ 2,494	
	DW-4212-A-36-WG	Single Face Adder	36 <sup>1</sup> / <sub>4</sub> "	12 <sup>1</sup> / <sub>8</sub> "	42"	10 <sup>1</sup> / <sub>2</sub> "	2	60 Lbs.	5 Cu Ft	\$ 2,100	
	DW-4214-S-36-WG	Single Face Starter	37 <sup>1</sup> / <sub>4</sub> "	14 <sup>5</sup> / <sub>8</sub> "	42"	13 <sup>1</sup> / <sub>2</sub> "	2	53 Lbs.	5 Cu Ft	\$ 2,690	
	DW-4214-A-36-WG	Single Face Adder	36 <sup>1</sup> / <sub>4</sub> "	14 <sup>5</sup> / <sub>8</sub> "	42"	13 <sup>1</sup> / <sub>2</sub> "	2	79 Lbs.	6 Cu Ft	\$ 2,263	

MODEL NUMBER	PRODUCT	WIDTH	DEPTH	HEIGHT	SHELF DEPTH	# OF SHELVES	# OF OPENINGS	WEIGHT	VOLUME	LIST PRICE	DESCRIPTION
 Model Shown DW-4212-S-36-WG	DW-4810-S-24-WG	Single Face Starter	25 <sup>1</sup> / <sub>4</sub> "	10 <sup>1</sup> / <sub>8</sub> "	48"	8 <sup>1</sup> / <sub>2</sub> "	2			\$ 2,698	End, Mid, Top and Base Panels to be constructed from 1" thick 11-ply solid core, veneered 2 sides. Vertical, top and bottom edges banded with 1/4" external hardwood edging, edges to be eased. Front Edge: 3/4" thick x 2 1/2" high fascia - tongue and grooved to top.
	DW-4810-A-24-WG	Single Face Adder	24 <sup>1</sup> / <sub>4</sub> "	10 <sup>1</sup> / <sub>8</sub> "	48"	8 <sup>1</sup> / <sub>2</sub> "	2			\$ 2,309	
	DW-4812-S-24-WG	Single Face Starter	25 <sup>1</sup> / <sub>4</sub> "	12 <sup>1</sup> / <sub>8</sub> "	48"	10 <sup>1</sup> / <sub>2</sub> "	2			\$ 2,712	
	DW-4812-A-24-WG	Single Face Adder	24 <sup>1</sup> / <sub>4</sub> "	12 <sup>1</sup> / <sub>8</sub> "	48"	10 <sup>1</sup> / <sub>2</sub> "	2			\$ 2,309	
	DW-4814-S-24-WG	Single Face Starter	25 <sup>1</sup> / <sub>4</sub> "	14 <sup>5</sup> / <sub>8</sub> "	48"	13 <sup>1</sup> / <sub>2</sub> "	2			\$ 2,915	
	DW-4814-A-24-WG	Single Face Adder	24 <sup>1</sup> / <sub>4</sub> "	14 <sup>5</sup> / <sub>8</sub> "	48"	13 <sup>1</sup> / <sub>2</sub> "	2			\$ 2,481	
 Model Shown DW-4212-A-36-WG	DW-4810-S-30-WG	Single Face Starter	31 <sup>1</sup> / <sub>4</sub> "	10 <sup>1</sup> / <sub>8</sub> "	48"	8 <sup>1</sup> / <sub>2</sub> "	2			\$ 2,698	
	DW-4810-A-30-WG	Single Face Adder	30 <sup>1</sup> / <sub>4</sub> "	10 <sup>1</sup> / <sub>8</sub> "	48"	8 <sup>1</sup> / <sub>2</sub> "	2			\$ 2,309	
	DW-4812-S-30-WG	Single Face Starter	31 <sup>1</sup> / <sub>4</sub> "	12 <sup>1</sup> / <sub>8</sub> "	48"	10 <sup>1</sup> / <sub>2</sub> "	2			\$ 2,712	
	DW-4812-A-30-WG	Single Face Adder	30 <sup>1</sup> / <sub>4</sub> "	12 <sup>1</sup> / <sub>8</sub> "	48"	10 <sup>1</sup> / <sub>2</sub> "	2			\$ 2,309	
	DW-4814-S-30-WG	Single Face Starter	31 <sup>1</sup> / <sub>4</sub> "	14 <sup>5</sup> / <sub>8</sub> "	48"	13 <sup>1</sup> / <sub>2</sub> "	2			\$ 2,915	
	DW-4814-A-30-WG	Single Face Adder	30 <sup>1</sup> / <sub>4</sub> "	14 <sup>5</sup> / <sub>8</sub> "	48"	13 <sup>1</sup> / <sub>2</sub> "	2			\$ 2,481	
	DW-4810-S-36-WG	Single Face Starter	37 <sup>1</sup> / <sub>4</sub> "	10 <sup>1</sup> / <sub>8</sub> "	48"	8 <sup>1</sup> / <sub>2</sub> "	2			\$ 2,512	
	DW-4810-A-36-WG	Single Face Adder	36 <sup>1</sup> / <sub>4</sub> "	10 <sup>1</sup> / <sub>8</sub> "	48"	8 <sup>1</sup> / <sub>2</sub> "	2	74.8 Lbs.	5 Cu Ft	\$ 2,122	
	DW-4812-S-36-WG	Single Face Starter	37 <sup>1</sup> / <sub>4</sub> "	12 <sup>1</sup> / <sub>8</sub> "	48"	10 <sup>1</sup> / <sub>2</sub> "	2	82.8 Lbs.	6 Cu Ft	\$ 2,535	
	DW-4812-A-36-WG	Single Face Adder	36 <sup>1</sup> / <sub>4</sub> "	12 <sup>1</sup> / <sub>8</sub> "	48"	10 <sup>1</sup> / <sub>2</sub> "	2	71.3 Lbs.	6 Cu Ft	\$ 2,122	
	DW-4814-S-36-WG	Single Face Starter	37 <sup>1</sup> / <sub>4</sub> "	14 <sup>5</sup> / <sub>8</sub> "	48"	13 <sup>1</sup> / <sub>2</sub> "	2	108 Lbs.	7 Cu Ft	\$ 2,736	
	DW-4814-A-36-WG	Single Face Adder	36 <sup>1</sup> / <sub>4</sub> "	14 <sup>5</sup> / <sub>8</sub> "	48"	13 <sup>1</sup> / <sub>2</sub> "	2	92 Lbs.	7 Cu Ft	\$ 2,293	
 Model Shown DW-6012-S-36-WG	DW-6010-S-24-WG	Single Face Starter	25 <sup>1</sup> / <sub>4</sub> "	10 <sup>1</sup> / <sub>8</sub> "	60"	8 <sup>1</sup> / <sub>2</sub> "	3			\$ 3,428	
	DW-6010-A-24-WG	Single Face Adder	24 <sup>1</sup> / <sub>4</sub> "	10 <sup>1</sup> / <sub>8</sub> "	60"	8 <sup>1</sup> / <sub>2</sub> "	3			\$ 3,056	
	DW-6012-S-24-WG	Single Face Starter	25 <sup>1</sup> / <sub>4</sub> "	12 <sup>1</sup> / <sub>8</sub> "	60"	10 <sup>1</sup> / <sub>2</sub> "	3			\$ 3,482	
	DW-6012-A-24-WG	Single Face Adder	24 <sup>1</sup> / <sub>4</sub> "	12 <sup>1</sup> / <sub>8</sub> "	60"	10 <sup>1</sup> / <sub>2</sub> "	3			\$ 3,095	
	DW-6014-S-24-WG	Single Face Starter	25 <sup>1</sup> / <sub>4</sub> "	14 <sup>5</sup> / <sub>8</sub> "	60"	13 <sup>1</sup> / <sub>2</sub> "	3			\$ 3,717	
	DW-6014-A-24-WG	Single Face Adder	24 <sup>1</sup> / <sub>4</sub> "	14 <sup>5</sup> / <sub>8</sub> "	60"	13 <sup>1</sup> / <sub>2</sub> "	3			\$ 3,297	
 Model Shown DW-6012-A-36-WG	DW-6010-S-30-WG	Single Face Starter	31 <sup>1</sup> / <sub>4</sub> "	10 <sup>1</sup> / <sub>8</sub> "	60"	8 <sup>1</sup> / <sub>2</sub> "	3			\$ 3,428	
	DW-6010-A-30-WG	Single Face Adder	30 <sup>1</sup> / <sub>4</sub> "	10 <sup>1</sup> / <sub>8</sub> "	60"	8 <sup>1</sup> / <sub>2</sub> "	3			\$ 3,056	
	DW-6012-S-30-WG	Single Face Starter	31 <sup>1</sup> / <sub>4</sub> "	12 <sup>1</sup> / <sub>8</sub> "	60"	10 <sup>1</sup> / <sub>2</sub> "	3			\$ 3,482	
	DW-6012-A-30-WG	Single Face Adder	30 <sup>1</sup> / <sub>4</sub> "	12 <sup>1</sup> / <sub>8</sub> "	60"	10 <sup>1</sup> / <sub>2</sub> "	3			\$ 3,095	
	DW-6014-S-30-WG	Single Face Starter	31 <sup>1</sup> / <sub>4</sub> "	14 <sup>5</sup> / <sub>8</sub> "	60"	13 <sup>1</sup> / <sub>2</sub> "	3			\$ 3,717	
	DW-6014-A-30-WG	Single Face Adder	30 <sup>1</sup> / <sub>4</sub> "	14 <sup>5</sup> / <sub>8</sub> "	60"	13 <sup>1</sup> / <sub>2</sub> "	3			\$ 3,297	
 Model Shown DW-6012-A-36-WG	DW-6010-S-36-WG	Single Face Starter	37 <sup>1</sup> / <sub>4</sub> "	10 <sup>1</sup> / <sub>8</sub> "	60"	8 <sup>1</sup> / <sub>2</sub> "	3			\$ 3,250	
	DW-6010-A-36-WG	Single Face Adder	36 <sup>1</sup> / <sub>4</sub> "	10 <sup>1</sup> / <sub>8</sub> "	60"	8 <sup>1</sup> / <sub>2</sub> "	3	100 Lbs.	6 Cu Ft	\$ 2,876	
	DW-6012-S-36-WG	Single Face Starter	37 <sup>1</sup> / <sub>4</sub> "	12 <sup>1</sup> / <sub>8</sub> "	60"	10 <sup>1</sup> / <sub>2</sub> "	3	86.3 Lbs.	6 Cu Ft	\$ 3,304	
	DW-6012-A-36-WG	Single Face Adder	36 <sup>1</sup> / <sub>4</sub> "	12 <sup>1</sup> / <sub>8</sub> "	60"	10 <sup>1</sup> / <sub>2</sub> "	3	116 Lbs.	8 Cu Ft	\$ 2,915	
	DW-6014-S-36-WG	Single Face Starter	37 <sup>1</sup> / <sub>4</sub> "	14 <sup>5</sup> / <sub>8</sub> "	60"	13 <sup>1</sup> / <sub>2</sub> "	3	95.5 Lbs.	7 Cu Ft	\$ 3,536	
	DW-6014-A-36-WG	Single Face Adder	36 <sup>1</sup> / <sub>4</sub> "	14 <sup>5</sup> / <sub>8</sub> "	60"	13 <sup>1</sup> / <sub>2</sub> "	3	141 Lbs.	9 Cu Ft	\$ 3,110	

MODEL NUMBER	PRODUCT	WIDTH	DEPTH	HEIGHT	SHELF DEPTH	# OF SHELVES	# OF OPENINGS	WEIGHT	VOLUME	LIST PRICE	DESCRIPTION
 Model Shown DW-7212-S-36-WG	DW-7210-S-24-WG	Single Face Starter	25 1/4"	10 1/8"	72"	8 1/2"	4			\$ 3,536	End, Mid, Top and Base Panels to be constructed from 1" thick 11-ply solid core, veneered 2 sides. Vertical, top and bottom edges banded with 1/4" external hardwood edging, edges to be eased. Front Edge: 3/4" thick x 2 1/2" high fascia - tongue and grooved to top.
	DW-7210-A-24-WG	Single Face Adder	24 1/4"	10 1/8"	72"	8 1/2"	4			\$ 3,157	
	DW-7212-S-24-WG	Single Face Starter	25 1/4"	12 1/8"	72"	10 1/2"	4			\$ 3,599	
	DW-7212-A-24-WG	Single Face Adder	24 1/4"	12 1/8"	72"	10 1/2"	4			\$ 3,210	
	DW-7214-S-24-WG	Single Face Starter	25 1/4"	14 5/8"	72"	13 1/2"	4			\$ 3,841	
	DW-7214-A-24-WG	Single Face Adder	24 1/4"	14 5/8"	72"	13 1/2"	4			\$ 3,428	
 Model Shown DW-7212-A-36-WG	DW-7210-S-30-WG	Single Face Starter	31 1/4"	10 1/8"	72"	8 1/2"	4			\$ 3,536	
	DW-7210-A-30-WG	Single Face Adder	30 1/4"	10 1/8"	72"	8 1/2"	4			\$ 3,157	
	DW-7212-S-30-WG	Single Face Starter	31 1/4"	12 1/8"	72"	10 1/2"	4			\$ 3,599	
	DW-7212-A-30-WG	Single Face Adder	30 1/4"	12 1/8"	72"	10 1/2"	4			\$ 3,210	
	DW-7214-S-30-WG	Single Face Starter	31 1/4"	14 5/8"	72"	13 1/2"	4			\$ 3,841	
	DW-7214-A-30-WG	Single Face Adder	30 1/4"	14 5/8"	72"	13 1/2"	4			\$ 3,428	
 Model Shown DW-7212-A-36-WG	DW-7210-S-36-WG	Single Face Starter	37 1/4"	10 1/8"	72"	8 1/2"	4			\$ 3,351	
	DW-7210-A-36-WG	Single Face Adder	36 1/4"	10 1/8"	72"	8 1/2"	4	115 Lbs.	7 Cu Ft	\$ 2,970	
	DW-7212-S-36-WG	Single Face Starter	37 1/4"	12 1/8"	72"	10 1/2"	4	131 Lbs.	8 Cu Ft	\$ 3,421	
	DW-7212-A-36-WG	Single Face Adder	36 1/4"	12 1/8"	72"	10 1/2"	4	109 Lbs.	8 Cu Ft	\$ 3,023	
	DW-7214-S-36-WG	Single Face Starter	37 1/4"	14 5/8"	72"	13 1/2"	4	159 Lbs.	10 Cu Ft	\$ 3,654	
	DW-7214-A-36-WG	Single Face Adder	36 1/4"	14 5/8"	72"	13 1/2"	4	132 Lbs.	9 Cu Ft	\$ 3,241	
 Model Shown DW-8212-S-36-WG	DW-8210-S-24-WG	Single Face Starter	25 1/4"	10 1/8"	82"	8 1/2"	5			\$ 3,645	
	DW-8210-A-24-WG	Single Face Adder	24 1/4"	10 1/8"	82"	8 1/2"	5			\$ 3,265	
	DW-8212-S-24-WG	Single Face Starter	25 1/4"	12 1/8"	82"	10 1/2"	5			\$ 3,708	
	DW-8212-A-24-WG	Single Face Adder	24 1/4"	12 1/8"	82"	10 1/2"	5			\$ 3,319	
	DW-8214-S-24-WG	Single Face Starter	25 1/4"	14 5/8"	82"	13 1/2"	5			\$ 3,926	
	DW-8214-A-24-WG	Single Face Adder	24 1/4"	14 5/8"	82"	13 1/2"	5			\$ 3,575	
 Model Shown DW-8212-A-36-WG	DW-8210-S-30-WG	Single Face Starter	31 1/4"	10 1/8"	82"	8 1/2"	5			\$ 3,645	
	DW-8210-A-30-WG	Single Face Adder	30 1/4"	10 1/8"	82"	8 1/2"	5			\$ 3,265	
	DW-8212-S-30-WG	Single Face Starter	31 1/4"	12 1/8"	82"	10 1/2"	5			\$ 3,708	
	DW-8212-A-30-WG	Single Face Adder	30 1/4"	12 1/8"	82"	10 1/2"	5			\$ 3,319	
	DW-8214-S-30-WG	Single Face Starter	31 1/4"	14 5/8"	82"	13 1/2"	5			\$ 3,926	
	DW-8214-A-30-WG	Single Face Adder	30 1/4"	14 5/8"	82"	13 1/2"	5			\$ 3,575	
 Model Shown DW-8212-A-36-WG	DW-8210-S-36-WG	Single Face Starter	37 1/4"	10 1/8"	82"	8 1/2"	5			\$ 3,458	
	DW-8210-A-36-WG	Single Face Adder	36 1/4"	10 1/8"	82"	8 1/2"	5	129 Lbs.	8 Cu Ft	\$ 3,085	
	DW-8212-S-36-WG	Single Face Starter	37 1/4"	12 1/8"	82"	10 1/2"	5	145 Lbs.	9 Cu Ft	\$ 3,529	
	DW-8212-A-36-WG	Single Face Adder	36 1/4"	12 1/8"	82"	10 1/2"	5	122 Lbs.	8 Cu Ft	\$ 3,134	
	DW-8214-S-36-WG	Single Face Starter	37 1/4"	14 5/8"	82"	13 1/2"	5	175 Lbs.	11 Cu Ft	\$ 3,739	
	DW-8214-A-36-WG	Single Face Adder	36 1/4"	14 5/8"	82"	13 1/2"	5	143 Lbs.	10 Cu Ft	\$ 3,397	







MODEL NUMBER	PRODUCT	WIDTH	DEPTH	HEIGHT	SHELF DEPTH	# OF SHELVES	# OF OPENINGS	WEIGHT	VOLUME	LIST PRICE	DESCRIPTION
DW-9610-S-24-WG	Single Face Starter	25 <sup>1</sup> / <sub>4</sub> "	10 <sup>1</sup> / <sub>8</sub> "	96"	8 <sup>1</sup> / <sub>2</sub> "	6	7			\$ 3,739	End, Mid, Top and Base Panels to be constructed from 1" thick 11-ply solid core, veneered 2 sides. Vertical, top and bottom edges banded with 1/4" external hardwood edging, edges to be eased. Front Edge: 3/4" thick x 2 1/2" high fascia - tongue and grooved to top.
DW-9610-A-24-WG	Single Face Adder	24 <sup>1</sup> / <sub>4</sub> "	10 <sup>1</sup> / <sub>8</sub> "	96"	8 <sup>1</sup> / <sub>2</sub> "	6	7			\$ 3,365	
DW-9612-S-24-WG	Single Face Starter	25 <sup>1</sup> / <sub>4</sub> "	12 <sup>1</sup> / <sub>8</sub> "	96"	10 <sup>1</sup> / <sub>2</sub> "	6	7			\$ 3,824	
DW-9612-A-24-WG	Single Face Adder	24 <sup>1</sup> / <sub>4</sub> "	12 <sup>1</sup> / <sub>8</sub> "	96"	10 <sup>1</sup> / <sub>2</sub> "	6	7			\$ 3,428	
DW-9614-S-24-WG	Single Face Starter	25 <sup>1</sup> / <sub>4</sub> "	14 <sup>5</sup> / <sub>8</sub> "	96"	13 <sup>1</sup> / <sub>2</sub> "	6	7			\$ 4,143	
DW-9614-A-24-WG	Single Face Adder	24 <sup>1</sup> / <sub>4</sub> "	14 <sup>5</sup> / <sub>8</sub> "	96"	13 <sup>1</sup> / <sub>2</sub> "	6	7			\$ 3,686	
DW-9610-S-30-WG	Single Face Starter	31 <sup>1</sup> / <sub>4</sub> "	10 <sup>1</sup> / <sub>8</sub> "	96"	8 <sup>1</sup> / <sub>2</sub> "	6	7			\$ 3,739	
DW-9610-A-30-WG	Single Face Adder	30 <sup>1</sup> / <sub>4</sub> "	10 <sup>1</sup> / <sub>8</sub> "	96"	8 <sup>1</sup> / <sub>2</sub> "	6	7			\$ 3,365	
DW-9612-S-30-WG	Single Face Starter	31 <sup>1</sup> / <sub>4</sub> "	12 <sup>1</sup> / <sub>8</sub> "	96"	10 <sup>1</sup> / <sub>2</sub> "	6	7			\$ 3,824	
DW-9612-A-30-WG	Single Face Adder	30 <sup>1</sup> / <sub>4</sub> "	12 <sup>1</sup> / <sub>8</sub> "	96"	10 <sup>1</sup> / <sub>2</sub> "	6	7			\$ 3,428	
DW-9614-S-30-WG	Single Face Starter	31 <sup>1</sup> / <sub>4</sub> "	14 <sup>5</sup> / <sub>8</sub> "	96"	13 <sup>1</sup> / <sub>2</sub> "	6	7			\$ 4,143	
DW-9614-A-30-WG	Single Face Adder	30 <sup>1</sup> / <sub>4</sub> "	14 <sup>5</sup> / <sub>8</sub> "	96"	13 <sup>1</sup> / <sub>2</sub> "	6	7			\$ 3,686	
DW-9610-S-36-WG	Single Face Starter	37 <sup>1</sup> / <sub>4</sub> "	10 <sup>1</sup> / <sub>8</sub> "	96"	8 <sup>1</sup> / <sub>2</sub> "	6	7	156 Lbs.	9 Cu Ft	\$ 3,560	
DW-9610-A-36-WG	Single Face Adder	36 <sup>1</sup> / <sub>4</sub> "	10 <sup>1</sup> / <sub>8</sub> "	96"	8 <sup>1</sup> / <sub>2</sub> "	6	7	128 Lbs.	8 Cu Ft	\$ 3,180	
DW-9612-S-36-WG	Single Face Starter	37 <sup>1</sup> / <sub>4</sub> "	12 <sup>1</sup> / <sub>8</sub> "	96"	10 <sup>1</sup> / <sub>2</sub> "	6	7	177 Lbs.	10 Cu Ft	\$ 3,645	
DW-9612-A-36-WG	Single Face Adder	36 <sup>1</sup> / <sub>4</sub> "	12 <sup>1</sup> / <sub>8</sub> "	96"	10 <sup>1</sup> / <sub>2</sub> "	6	7	145 Lbs.	9 Cu Ft	\$ 3,250	
DW-9614-S-36-WG	Single Face Starter	37 <sup>1</sup> / <sub>4</sub> "	14 <sup>5</sup> / <sub>8</sub> "	96"	13 <sup>1</sup> / <sub>2</sub> "	6	7	213 Lbs.	12 Cu Ft	\$ 3,965	
DW-9614-A-36-WG	Single Face Adder	36 <sup>1</sup> / <sub>4</sub> "	14 <sup>5</sup> / <sub>8</sub> "	96"	13 <sup>1</sup> / <sub>2</sub> "	6	7	175 Lbs.	11 Cu Ft	\$ 3,506	



Model Shown  
DW-9612-S-36-WG



Model Shown  
DW-9612-A-36-WG

	MODEL NUMBER	PRODUCT	WIDTH	DEPTH	HEIGHT	SHELF DEPTH	# OF SHELVES	# OF OPENINGS	WEIGHT	VOLUME	LIST PRICE	DESCRIPTION
 Model Shown DW-3624-S-36-WG	DW-3620-S-24-WG	Double Face Starter	25 1/4"	19 1/2"	36"	8 1/2"	2	4			\$ 4,944	End, Mid, Top and Base Panels to be constructed from 1" thick 11-ply solid core, veneered 2 sides. Vertical, top and bottom edges banded with 1/4" external hardwood edging, edges to be eased. Front Edge: 3/4" thick x 2 1/2" high fascia - tongue and grooved to top.
	DW-3620-A-24-WG	Double Face Adder	24 1/4"	19 1/2"	36"	8 1/2"	2	4			\$ 4,299	
	DW-3624-S-24-WG	Double Face Starter	25 1/4"	23 1/2"	36"	10 1/2"	2	4			\$ 4,991	
	DW-3624-A-24-WG	Double Face Adder	24 1/4"	23 1/2"	36"	10 1/2"	2	4			\$ 4,315	
	DW-3628-S-24-WG	Double Face Starter	25 1/4"	28 1/2"	36"	13 1/2"	2	4			\$ 5,356	
	DW-3628-A-24-WG	Double Face Adder	24 1/4"	28 1/2"	36"	13 1/2"	2	4			\$ 4,617	
 Model Shown DW-3624-A-36-WG	DW-3620-S-30-WG	Double Face Starter	31 1/4"	19 1/2"	36"	8 1/2"	2	4			\$ 4,944	
	DW-3620-A-30-WG	Double Face Adder	30 1/4"	19 1/2"	36"	8 1/2"	2	4			\$ 4,299	
	DW-3624-S-30-WG	Double Face Starter	31 1/4"	23 1/2"	36"	10 1/2"	2	4			\$ 4,991	
	DW-3624-A-30-WG	Double Face Adder	30 1/4"	23 1/2"	36"	10 1/2"	2	4			\$ 4,315	
	DW-3628-S-30-WG	Double Face Starter	31 1/4"	28 1/2"	36"	13 1/2"	2	4			\$ 5,356	
	DW-3628-A-30-WG	Double Face Adder	30 1/4"	28 1/2"	36"	13 1/2"	2	4			\$ 4,617	
	DW-3620-S-36-WG	Double Face Starter	37 1/4"	19 1/2"	36"	8 1/2"	2	4	88.6 Lbs.	7 Cu Ft	\$ 4,671	
	DW-3620-A-36-WG	Double Face Adder	36 1/4"	19 1/2"	36"	8 1/2"	2	4	73.6 Lbs.	6 Cu Ft	\$ 4,018	
	DW-3624-S-36-WG	Double Face Starter	37 1/4"	23 1/2"	36"	10 1/2"	2	4	110 Lbs.	10 Cu Ft	\$ 4,718	
	DW-3624-A-36-WG	Double Face Adder	36 1/4"	23 1/2"	36"	10 1/2"	2	4	88.6 Lbs.	9 Cu Ft	\$ 4,042	
	DW-3628-S-36-WG	Double Face Starter	37 1/4"	28 1/2"	36"	13 1/2"	2	4	132 Lbs.	11 Cu Ft	\$ 5,075	
	DW-3628-A-36-WG	Double Face Adder	36 1/4"	28 1/2"	36"	13 1/2"	2	4	104 Lbs.	10 Cu Ft	\$ 4,339	
 Model Shown DW-4224-S-36-WG	DW-4220-S-24-WG	Double Face Starter	25 1/4"	19 1/2"	42"	8 1/2"	4	6			\$ 5,162	
	DW-4220-A-24-WG	Double Face Adder	24 1/4"	19 1/2"	42"	8 1/2"	4	6			\$ 4,509	
	DW-4224-S-24-WG	Double Face Starter	25 1/4"	23 1/2"	42"	10 1/2"	4	6			\$ 5,223	
	DW-4224-A-24-WG	Double Face Adder	24 1/4"	23 1/2"	42"	10 1/2"	4	6			\$ 4,547	
	DW-4228-S-24-WG	Double Face Starter	25 1/4"	28 1/2"	42"	13 1/2"	4	6			\$ 5,659	
	DW-4228-A-24-WG	Double Face Adder	24 1/4"	28 1/2"	42"	13 1/2"	4	6			\$ 4,921	
 Model Shown DW-4224-A-36-WG	DW-4220-S-30-WG	Double Face Starter	31 1/4"	19 1/2"	42"	8 1/2"	4	6			\$ 5,162	
	DW-4220-A-30-WG	Double Face Adder	30 1/4"	19 1/2"	42"	8 1/2"	4	6			\$ 4,509	
	DW-4224-S-30-WG	Double Face Starter	31 1/4"	23 1/2"	42"	10 1/2"	4	6			\$ 5,223	
	DW-4224-A-30-WG	Double Face Adder	30 1/4"	23 1/2"	42"	10 1/2"	4	6			\$ 4,547	
	DW-4228-S-30-WG	Double Face Starter	31 1/4"	28 1/2"	42"	13 1/2"	4	6			\$ 5,659	
	DW-4228-A-30-WG	Double Face Adder	30 1/4"	28 1/2"	42"	13 1/2"	4	6			\$ 4,921	
	DW-4220-S-36-WG	Double Face Starter	37 1/4"	19 1/2"	42"	8 1/2"	4	6	94 Lbs.	7 Cu Ft	\$ 4,882	
	DW-4220-A-36-WG	Double Face Adder	36 1/4"	19 1/2"	42"	8 1/2"	4	6	78 Lbs.	7 Cu Ft	\$ 4,235	
	DW-4224-S-36-WG	Double Face Starter	37 1/4"	23 1/2"	42"	10 1/2"	4	6	115 Lbs.	10 Cu Ft	\$ 4,944	
	DW-4224-A-36-WG	Double Face Adder	36 1/4"	23 1/2"	42"	10 1/2"	4	6	113 Lbs.	10 Cu Ft	\$ 4,268	
	DW-4228-S-36-WG	Double Face Starter	37 1/4"	28 1/2"	42"	13 1/2"	4	6	183 Lbs.	13 Cu Ft	\$ 5,380	
	DW-4228-A-36-WG	Double Face Adder	36 1/4"	28 1/2"	42"	13 1/2"	4	6	109 Lbs.	13 Cu Ft	\$ 4,640	

MODEL NUMBER	PRODUCT	WIDTH	DEPTH	HEIGHT	SHELF DEPTH	# OF SHELVES	# OF OPENINGS	WEIGHT	VOLUME	LIST PRICE	DESCRIPTION
--------------	---------	-------	-------	--------	-------------	--------------	---------------	--------	--------	------------	-------------



Model Shown  
DW-4224-S-36-WG



Model Shown  
DW-4224-A-36-WG

DW-4820-S-24-WG	Double Face Starter	25 1/4"	19 1/2"	48"	8 1/2"	4	6			\$ 5,418	End, Mid, Top and Base Panels to be constructed from 1" thick 11-ply solid core, veneered 2 sides. Vertical, top and bottom edges banded with 1/4" external hardwood edging, edges to be eased. Front Edge: 3/4" thick x 2 1/2" high fascia - tongue and grooved to top.
DW-4820-A-24-WG	Double Face Adder	24 1/4"	19 1/2"	48"	8 1/2"	4	6			\$ 4,733	
DW-4824-S-24-WG	Double Face Starter	25 1/4"	23 1/2"	48"	10 1/2"	4	6			\$ 5,480	
DW-4824-A-24-WG	Double Face Adder	24 1/4"	23 1/2"	48"	10 1/2"	4	6			\$ 4,774	
DW-4828-S-24-WG	Double Face Starter	25 1/4"	28 1/2"	48"	13 1/2"	4	6			\$ 5,939	
DW-4828-A-24-WG	Double Face Adder	24 1/4"	28 1/2"	48"	13 1/2"	4	6			\$ 5,162	

DW-4820-S-30-WG	Double Face Starter	31 1/4"	19 1/2"	48"	8 1/2"	4	6			\$ 5,418
DW-4820-A-30-WG	Double Face Adder	30 1/4"	19 1/2"	48"	8 1/2"	4	6			\$ 4,733
DW-4824-S-30-WG	Double Face Starter	31 1/4"	23 1/2"	48"	10 1/2"	4	6			\$ 5,480
DW-4824-A-30-WG	Double Face Adder	30 1/4"	23 1/2"	48"	10 1/2"	4	6			\$ 4,774
DW-4828-S-30-WG	Double Face Starter	31 1/4"	28 1/2"	48"	13 1/2"	4	6			\$ 5,939
DW-4828-A-30-WG	Double Face Adder	30 1/4"	28 1/2"	48"	13 1/2"	4	6			\$ 5,162

DW-4820-S-36-WG	Double Face Starter	37 1/4"	19 1/2"	48"	8 1/2"	4	6	132 Lbs.	9 Cu Ft	\$ 5,130
DW-4820-A-36-WG	Double Face Adder	36 1/4"	19 1/2"	48"	8 1/2"	4	6	109 Lbs.	8 Cu Ft	\$ 4,446
DW-4824-S-36-WG	Double Face Starter	37 1/4"	23 1/2"	48"	10 1/2"	4	6	155 Lbs.	11 Cu Ft	\$ 5,192
DW-4824-A-36-WG	Double Face Adder	36 1/4"	23 1/2"	48"	10 1/2"	4	6	127 Lbs.	10 Cu Ft	\$ 4,485
DW-4828-S-36-WG	Double Face Starter	37 1/4"	28 1/2"	48"	13 1/2"	4	6	178 Lbs.	13 Cu Ft	\$ 5,644
DW-4828-A-36-WG	Double Face Adder	36 1/4"	28 1/2"	48"	13 1/2"	4	6	144 Lbs.	12 Cu Ft	\$ 4,875



Model Shown  
DW-6024-S-36-WG











Model Shown  
DW-6024-A-36-WG

DW-6020-S-24-WG	Double Face Starter	25 1/4"	19 1/2"	60"	8 1/2"	6	8			\$ 6,887
DW-6020-A-24-WG	Double Face Adder	24 1/4"	19 1/2"	60"	8 1/2"	6	8			\$ 6,211
DW-6024-S-24-WG	Double Face Starter	25 1/4"	23 1/2"	60"	10 1/2"	6	8			\$ 6,951
DW-6024-A-24-WG	Double Face Adder	24 1/4"	23 1/2"	60"	10 1/2"	6	8			\$ 6,273
DW-6028-S-24-WG	Double Face Starter	25 1/4"	28 1/2"	60"	13 1/2"	6	8			\$ 7,455
DW-6028-A-24-WG	Double Face Adder	24 1/4"	28 1/2"	60"	13 1/2"	6	8			\$ 6,692

DW-6020-S-30-WG	Double Face Starter	31 1/4"	19 1/2"	60"	8 1/2"	6	8			\$ 6,887
DW-6020-A-30-WG	Double Face Adder	30 1/4"	19 1/2"	60"	8 1/2"	6	8			\$ 6,211
DW-6024-S-30-WG	Double Face Starter	31 1/4"	23 1/2"	60"	10 1/2"	6	8			\$ 6,951
DW-6024-A-30-WG	Double Face Adder	30 1/4"	23 1/2"	60"	10 1/2"	6	8			\$ 6,273
DW-6028-S-30-WG	Double Face Starter	31 1/4"	28 1/2"	60"	13 1/2"	6	8			\$ 7,455
DW-6028-A-30-WG	Double Face Adder	30 1/4"	28 1/2"	60"	13 1/2"	6	8			\$ 6,692

DW-6020-S-36-WG	Double Face Starter	37 1/4"	19 1/2"	60"	8 1/2"	6	8	176 Lbs.	11 Cu Ft	\$ 6,608
DW-6020-A-36-WG	Double Face Adder	36 1/4"	19 1/2"	60"	8 1/2"	6	8	145 Lbs.	10 Cu Ft	\$ 5,939
DW-6024-S-36-WG	Double Face Starter	37 1/4"	23 1/2"	60"	10 1/2"	6	8	200 Lbs.	12 Cu Ft	\$ 6,670
DW-6024-A-36-WG	Double Face Adder	36 1/4"	23 1/2"	60"	10 1/2"	6	8	164 Lbs.	11 Cu Ft	\$ 5,994
DW-6028-S-36-WG	Double Face Starter	37 1/4"	28 1/2"	60"	13 1/2"	6	8	224 Lbs.	13 Cu Ft	\$ 7,175
DW-6028-A-36-WG	Double Face Adder	36 1/4"	28 1/2"	60"	13 1/2"	6	8	184 Lbs.	12 Cu Ft	\$ 6,414





	MODEL NUMBER	PRODUCT	WIDTH	DEPTH	HEIGHT	SHELF DEPTH	# OF SHELVES	# OF OPENINGS	WEIGHT	VOLUME	LIST PRICE	DESCRIPTION
	DW-7220-S-24-WG	Double Face Starter	25 1/4"	19 1/2"	72"	8 1/2"	8	10			\$ 7,105	End, Mid, Top and Base Panels to be constructed from 1" thick 11-ply solid core, veneered 2 sides. Vertical, top and bottom edges banded with 1/4" external hardwood edging, edges to be eased. Front Edge: 3/4" thick x 2 1/2" high fascia - tongue and grooved to top.
	DW-7220-A-24-WG	Double Face Adder	24 1/4"	19 1/2"	72"	8 1/2"	8	10			\$ 6,422	
	DW-7224-S-24-WG	Double Face Starter	25 1/4"	23 1/2"	72"	10 1/2"	8	10			\$ 7,168	
	DW-7224-A-24-WG	Double Face Adder	24 1/4"	23 1/2"	72"	10 1/2"	8	10			\$ 6,483	
	DW-7228-S-24-WG	Double Face Starter	25 1/4"	28 1/2"	72"	13 1/2"	8	10			\$ 7,697	
	DW-7228-A-24-WG	Double Face Adder	24 1/4"	28 1/2"	72"	13 1/2"	8	10			\$ 6,951	
	DW-7220-S-30-WG	Double Face Starter	31 1/4"	19 1/2"	72"	8 1/2"	8	10			\$ 7,105	
	DW-7220-A-30-WG	Double Face Adder	30 1/4"	19 1/2"	72"	8 1/2"	8	10			\$ 6,422	
	DW-7224-S-30-WG	Double Face Starter	31 1/4"	23 1/2"	72"	10 1/2"	8	10			\$ 7,168	
	DW-7224-A-30-WG	Double Face Adder	30 1/4"	23 1/2"	72"	10 1/2"	8	10			\$ 6,483	
	DW-7228-S-30-WG	Double Face Starter	31 1/4"	28 1/2"	72"	13 1/2"	8	10			\$ 7,697	
	DW-7228-A-30-WG	Double Face Adder	30 1/4"	28 1/2"	72"	13 1/2"	8	10			\$ 6,951	
	DW-7220-S-36-WG	Double Face Starter	37 1/4"	19 1/2"	72"	8 1/2"	8	10	200 Lbs.	12 Cu Ft	\$ 6,826	
	DW-7220-A-36-WG	Double Face Adder	36 1/4"	19 1/2"	72"	8 1/2"	8	10	164 Lbs.	11 Cu Ft	\$ 6,149	
	DW-7224-S-36-WG	Double Face Starter	37 1/4"	23 1/2"	72"	10 1/2"	8	10	229 Lbs.	13 Cu Ft	\$ 6,887	
	DW-7224-A-36-WG	Double Face Adder	36 1/4"	23 1/2"	72"	10 1/2"	8	10	186 Lbs.	12 Cu Ft	\$ 6,211	
	DW-7228-S-36-WG	Double Face Starter	37 1/4"	28 1/2"	72"	13 1/2"	8	10	256 Lbs.	14 Cu Ft	\$ 7,423	
	DW-7228-A-36-WG	Double Face Adder	36 1/4"	28 1/2"	72"	13 1/2"	8	10	207 Lbs.	13 Cu Ft	\$ 6,670	
	DW-8220-S-24-WG	Double Face Starter	25 1/4"	19 1/2"	82"	8 1/2"	10	12			\$ 7,307	
	DW-8220-A-24-WG	Double Face Adder	24 1/4"	19 1/2"	82"	8 1/2"	10	12			\$ 6,631	
	DW-8224-S-24-WG	Double Face Starter	25 1/4"	23 1/2"	82"	10 1/2"	10	12			\$ 7,385	
	DW-8224-A-24-WG	Double Face Adder	24 1/4"	23 1/2"	82"	10 1/2"	10	12			\$ 6,716	
	DW-8228-S-24-WG	Double Face Starter	25 1/4"	28 1/2"	82"	13 1/2"	10	12			\$ 8,279	
	DW-8228-A-24-WG	Double Face Adder	24 1/4"	28 1/2"	82"	13 1/2"	10	12			\$ 7,354	
	DW-8220-S-30-WG	Double Face Starter	31 1/4"	19 1/2"	82"	8 1/2"	10	12			\$ 7,307	
	DW-8220-A-30-WG	Double Face Adder	30 1/4"	19 1/2"	82"	8 1/2"	10	12			\$ 6,631	
	DW-8224-S-30-WG	Double Face Starter	31 1/4"	23 1/2"	82"	10 1/2"	10	12			\$ 7,385	
	DW-8224-A-30-WG	Double Face Adder	30 1/4"	23 1/2"	82"	10 1/2"	10	12			\$ 6,716	
	DW-8228-S-30-WG	Double Face Starter	31 1/4"	28 1/2"	82"	13 1/2"	10	12			\$ 8,279	
	DW-8228-A-30-WG	Double Face Adder	30 1/4"	28 1/2"	82"	13 1/2"	10	12			\$ 7,354	
	DW-8220-S-36-WG	Double Face Starter	37 1/4"	19 1/2"	82"	8 1/2"	10	12	224 Lbs.	12 Cu Ft	\$ 7,028	
	DW-8220-A-36-WG	Double Face Adder	36 1/4"	19 1/2"	82"	8 1/2"	10	12	184 Lbs.	11 Cu Ft	\$ 6,350	
	DW-8224-S-36-WG	Double Face Starter	37 1/4"	23 1/2"	82"	10 1/2"	10	12	256 Lbs.	14 Cu Ft	\$ 7,105	
	DW-8224-A-36-WG	Double Face Adder	36 1/4"	23 1/2"	82"	10 1/2"	10	12	207 Lbs.	12 Cu Ft	\$ 6,437	
	DW-8228-S-36-WG	Double Face Starter	37 1/4"	28 1/2"	82"	13 1/2"	10	12	289 Lbs.	16 Cu Ft	\$ 7,998	
	DW-8228-A-36-WG	Double Face Adder	36 1/4"	28 1/2"	82"	13 1/2"	10	12	230 Lbs.	14 Cu Ft	\$ 7,075	

MODEL NUMBER	PRODUCT	WIDTH	DEPTH	HEIGHT	SHELF DEPTH	# OF SHELVES	# OF OPENINGS	WEIGHT	VOLUME	LIST PRICE	DESCRIPTION
	DW-9620-S-24-WG	25 1/4"	19 1/2"	96"	8 1/2"	12	14			\$ 7,516	End, Mid, Top and Base Panels to be constructed from 1" thick 11-ply solid core, veneered 2 sides. Vertical, top and bottom edges banded with 1/4" external hardwood edging, edges to be eased. Front Edge: 3/4" thick x 2 1/2" high fascia - tongue and grooved to top.
	DW-9620-A-24-WG	24 1/4"	19 1/2"	96"	8 1/2"	12	14			\$ 6,840	
	DW-9624-S-24-WG	25 1/4"	23 1/2"	96"	10 1/2"	12	14			\$ 7,603	
	DW-9624-A-24-WG	24 1/4"	23 1/2"	96"	10 1/2"	12	14			\$ 6,933	
	DW-9628-S-24-WG	25 1/4"	28 1/2"	96"	13 1/2"	12	14			\$ 8,520	
	DW-9628-A-24-WG	24 1/4"	28 1/2"	96"	13 1/2"	12	14			\$ 7,618	
	DW-9620-S-30-WG	31 1/4"	19 1/2"	96"	8 1/2"	12	14			\$ 7,516	
	DW-9620-A-30-WG	30 1/4"	19 1/2"	96"	8 1/2"	12	14			\$ 6,840	
	DW-9624-S-30-WG	31 1/4"	23 1/2"	96"	10 1/2"	12	14			\$ 7,603	
	DW-9624-A-30-WG	30 1/4"	23 1/2"	96"	10 1/2"	12	14			\$ 6,933	
	DW-9628-S-30-WG	31 1/4"	28 1/2"	96"	13 1/2"	12	14			\$ 8,520	
	DW-9628-A-30-WG	30 1/4"	28 1/2"	96"	13 1/2"	12	14			\$ 7,618	
	DW-9620-S-36-WG	37 1/4"	19 1/2"	96"	8 1/2"	12	14	276 Lbs.	13 Cu Ft	\$ 7,238	
	DW-9620-A-36-WG	36 1/4"	19 1/2"	96"	8 1/2"	12	14	220 Lbs.	12 Cu Ft	\$ 6,561	
	DW-9624-S-36-WG	37 1/4"	23 1/2"	96"	10 1/2"	12	14	315 Lbs.	15 Cu Ft	\$ 7,331	
	DW-9624-A-36-WG	36 1/4"	23 1/2"	96"	10 1/2"	12	14	247 Lbs.	13 Cu Ft	\$ 6,662	
	DW-9628-S-36-WG	37 1/4"	28 1/2"	96"	13 1/2"	12	14	353 Lbs.	17 Cu Ft	\$ 8,248	
	DW-9628-A-36-WG	36 1/4"	28 1/2"	96"	13 1/2"	12	14	275 Lbs.	15 Cu Ft	\$ 7,338	

Model Shown  
DW-9624-S-36-WG

Model Shown  
DW-9624-A-36-WG



	MODEL NUMBER	PRODUCT	WIDTH	DEPTH	HEIGHT	SHELF DEPTH	# OF SHELVES	# OF OPENINGS	WEIGHT	VOLUME	LIST PRICE	DESCRIPTION
 Model Shown DW-3612-S-36-WG-G	DW-3610-S-24-WG-G	Single Face Starter	25 <sup>1</sup> / <sub>4</sub> "	10 <sup>1</sup> / <sub>8</sub> "	36"	8 <sup>1</sup> / <sub>2</sub> "	1	2			\$ 2,551	End, Mid, Top and Base Panels to be constructed from 1" thick 11-ply solid core, veneered 2 sides. Vertical, top and bottom edges banded with 1/4" external hardwood edging, edges to be eased. Front Edge: 3/4" thick x 2 1/2" high fascia - tongue and grooved to top.
	DW-3610-A-24-WG-G	Single Face Adder	24 <sup>1</sup> / <sub>4</sub> "	10 <sup>1</sup> / <sub>8</sub> "	36"	8 <sup>1</sup> / <sub>2</sub> "	1	2			\$ 2,177	
	DW-3612-S-24-WG-G	Single Face Starter	25 <sup>1</sup> / <sub>4</sub> "	12 <sup>1</sup> / <sub>8</sub> "	36"	10 <sup>1</sup> / <sub>2</sub> "	1	2			\$ 2,612	
	DW-3612-A-24-WG-G	Single Face Adder	24 <sup>1</sup> / <sub>4</sub> "	12 <sup>1</sup> / <sub>8</sub> "	36"	10 <sup>1</sup> / <sub>2</sub> "	1	2			\$ 2,224	
	DW-3614-S-24-WG-G	Single Face Starter	25 <sup>1</sup> / <sub>4</sub> "	14 <sup>5</sup> / <sub>8</sub> "	36"	13 <sup>1</sup> / <sub>2</sub> "	1	2			\$ 2,799	
	DW-3614-A-24-WG-G	Single Face Adder	24 <sup>1</sup> / <sub>4</sub> "	14 <sup>5</sup> / <sub>8</sub> "	36"	13 <sup>1</sup> / <sub>2</sub> "	1	2			\$ 2,370	
 Model Shown DW-3612-A-36-WG-G	DW-3610-S-30-WG-G	Single Face Starter	31 <sup>1</sup> / <sub>4</sub> "	10 <sup>1</sup> / <sub>8</sub> "	36"	8 <sup>1</sup> / <sub>2</sub> "	1	2			\$ 2,551	
	DW-3610-A-30-WG-G	Single Face Adder	30 <sup>1</sup> / <sub>4</sub> "	10 <sup>1</sup> / <sub>8</sub> "	36"	8 <sup>1</sup> / <sub>2</sub> "	1	2			\$ 2,177	
	DW-3612-S-30-WG-G	Single Face Starter	31 <sup>1</sup> / <sub>4</sub> "	12 <sup>1</sup> / <sub>8</sub> "	36"	10 <sup>1</sup> / <sub>2</sub> "	1	2			\$ 2,612	
	DW-3612-A-30-WG-G	Single Face Adder	30 <sup>1</sup> / <sub>4</sub> "	12 <sup>1</sup> / <sub>8</sub> "	36"	10 <sup>1</sup> / <sub>2</sub> "	1	2			\$ 2,224	
	DW-3614-S-30-WG-G	Single Face Starter	31 <sup>1</sup> / <sub>4</sub> "	14 <sup>5</sup> / <sub>8</sub> "	36"	13 <sup>1</sup> / <sub>2</sub> "	1	2			\$ 2,799	
	DW-3614-A-30-WG-G	Single Face Adder	30 <sup>1</sup> / <sub>4</sub> "	14 <sup>5</sup> / <sub>8</sub> "	36"	13 <sup>1</sup> / <sub>2</sub> "	1	2			\$ 2,370	
	DW-3610-S-36-WG-G	Single Face Starter	37 <sup>1</sup> / <sub>4</sub> "	10 <sup>1</sup> / <sub>8</sub> "	36"	8 <sup>1</sup> / <sub>2</sub> "	1	2	50.6 Lbs.	4 Cu Ft	\$ 2,370	
	DW-3610-A-36-WG-G	Single Face Adder	36 <sup>1</sup> / <sub>4</sub> "	10 <sup>1</sup> / <sub>8</sub> "	36"	8 <sup>1</sup> / <sub>2</sub> "	1	2	46 Lbs.	4 Cu Ft	\$ 1,998	
	DW-3612-S-36-WG-G	Single Face Starter	37 <sup>1</sup> / <sub>4</sub> "	12 <sup>1</sup> / <sub>8</sub> "	36"	10 <sup>1</sup> / <sub>2</sub> "	1	2	50.6 Lbs.	5 Cu Ft	\$ 2,433	
	DW-3612-A-36-WG-G	Single Face Adder	36 <sup>1</sup> / <sub>4</sub> "	12 <sup>1</sup> / <sub>8</sub> "	36"	10 <sup>1</sup> / <sub>2</sub> "	1	2	47.2 Lbs.	5 Cu Ft	\$ 2,037	
	DW-3614-S-36-WG-G	Single Face Starter	37 <sup>1</sup> / <sub>4</sub> "	14 <sup>5</sup> / <sub>8</sub> "	36"	13 <sup>1</sup> / <sub>2</sub> "	1	2	74.8 Lbs.	6 Cu Ft	\$ 2,612	
	DW-3614-A-36-WG-G	Single Face Adder	36 <sup>1</sup> / <sub>4</sub> "	14 <sup>5</sup> / <sub>8</sub> "	36"	13 <sup>1</sup> / <sub>2</sub> "	1	2	63.3 Lbs.	6 Cu Ft	\$ 2,193	
 Model Shown DW-4212-S-36-WG-G	DW-4210-S-24-WG-G	Single Face Starter	25 <sup>1</sup> / <sub>4</sub> "	10 <sup>1</sup> / <sub>8</sub> "	42"	8 <sup>1</sup> / <sub>2</sub> "	2	3			\$ 2,698	
	DW-4210-A-24-WG-G	Single Face Adder	24 <sup>1</sup> / <sub>4</sub> "	10 <sup>1</sup> / <sub>8</sub> "	42"	8 <sup>1</sup> / <sub>2</sub> "	2	3			\$ 2,332	
	DW-4212-S-24-WG-G	Single Face Starter	25 <sup>1</sup> / <sub>4</sub> "	12 <sup>1</sup> / <sub>8</sub> "	42"	10 <sup>1</sup> / <sub>2</sub> "	2	3			\$ 2,768	
	DW-4212-A-24-WG-G	Single Face Adder	24 <sup>1</sup> / <sub>4</sub> "	12 <sup>1</sup> / <sub>8</sub> "	42"	10 <sup>1</sup> / <sub>2</sub> "	2	3			\$ 2,379	
	DW-4214-S-24-WG-G	Single Face Starter	25 <sup>1</sup> / <sub>4</sub> "	14 <sup>5</sup> / <sub>8</sub> "	42"	13 <sup>1</sup> / <sub>2</sub> "	2	3			\$ 3,016	
	DW-4214-A-24-WG-G	Single Face Adder	24 <sup>1</sup> / <sub>4</sub> "	14 <sup>5</sup> / <sub>8</sub> "	42"	13 <sup>1</sup> / <sub>2</sub> "	2	3			\$ 2,588	
 Model Shown DW-4212-A-36-WG-G	DW-4210-S-30-WG-G	Single Face Starter	31 <sup>1</sup> / <sub>4</sub> "	10 <sup>1</sup> / <sub>8</sub> "	42"	8 <sup>1</sup> / <sub>2</sub> "	2	3			\$ 2,698	
	DW-4210-A-30-WG-G	Single Face Adder	30 <sup>1</sup> / <sub>4</sub> "	10 <sup>1</sup> / <sub>8</sub> "	42"	8 <sup>1</sup> / <sub>2</sub> "	2	3			\$ 2,332	
	DW-4212-S-30-WG-G	Single Face Starter	31 <sup>1</sup> / <sub>4</sub> "	12 <sup>1</sup> / <sub>8</sub> "	42"	10 <sup>1</sup> / <sub>2</sub> "	2	3			\$ 2,768	
	DW-4212-A-30-WG-G	Single Face Adder	30 <sup>1</sup> / <sub>4</sub> "	12 <sup>1</sup> / <sub>8</sub> "	42"	10 <sup>1</sup> / <sub>2</sub> "	2	3			\$ 2,379	
	DW-4214-S-30-WG-G	Single Face Starter	31 <sup>1</sup> / <sub>4</sub> "	14 <sup>5</sup> / <sub>8</sub> "	42"	13 <sup>1</sup> / <sub>2</sub> "	2	3			\$ 3,016	
	DW-4214-A-30-WG-G	Single Face Adder	30 <sup>1</sup> / <sub>4</sub> "	14 <sup>5</sup> / <sub>8</sub> "	42"	13 <sup>1</sup> / <sub>2</sub> "	2	3			\$ 2,588	
	DW-4210-S-36-WG-G	Single Face Starter	37 <sup>1</sup> / <sub>4</sub> "	10 <sup>1</sup> / <sub>8</sub> "	42"	8 <sup>1</sup> / <sub>2</sub> "	2	3	55 Lbs.	5 Cu Ft	\$ 2,512	
	DW-4210-A-36-WG-G	Single Face Adder	36 <sup>1</sup> / <sub>4</sub> "	10 <sup>1</sup> / <sub>8</sub> "	42"	8 <sup>1</sup> / <sub>2</sub> "	2	3	52 Lbs.	5 Cu Ft	\$ 2,146	
	DW-4212-S-36-WG-G	Single Face Starter	37 <sup>1</sup> / <sub>4</sub> "	12 <sup>1</sup> / <sub>8</sub> "	42"	10 <sup>1</sup> / <sub>2</sub> "	2	3	60 Lbs.	5 Cu Ft	\$ 2,588	
	DW-4212-A-36-WG-G	Single Face Adder	36 <sup>1</sup> / <sub>4</sub> "	12 <sup>1</sup> / <sub>8</sub> "	42"	10 <sup>1</sup> / <sub>2</sub> "	2	3	53 Lbs.	5 Cu Ft	\$ 2,193	
	DW-4214-S-36-WG-G	Single Face Starter	37 <sup>1</sup> / <sub>4</sub> "	14 <sup>5</sup> / <sub>8</sub> "	42"	13 <sup>1</sup> / <sub>2</sub> "	2	3	79 Lbs.	6 Cu Ft	\$ 2,829	
	DW-4214-A-36-WG-G	Single Face Adder	36 <sup>1</sup> / <sub>4</sub> "	14 <sup>5</sup> / <sub>8</sub> "	42"	13 <sup>1</sup> / <sub>2</sub> "	2	3	68 Lbs.	6 Cu Ft	\$ 2,401	



Model Shown  
DW-4212-S-36-WG-G



Model Shown  
DW-4212-A-36-WG-G



Model Shown  
DW-6012-S-36-WG-G



Model Shown  
DW-6012-A-36-WG-G

MODEL NUMBER	PRODUCT	WIDTH	DEPTH	HEIGHT	SHELF DEPTH	# OF SHELVES	# OF OPENINGS	WEIGHT	VOLUME	LIST PRICE	DESCRIPTION
DW-4810-S-24-WG-G	Single Face Starter	25 1/4"	10 1/8"	48"	8 1/2"	2	3			\$ 2,775	End, Mid, Top and Base Panels to be constructed from 1" thick 11-ply solid core, veneered 2 sides. Vertical, top and bottom edges banded with 1/4" external hardwood edging, edges to be eased. Front Edge: 3/4" thick x 2 1/2" high fascia - tongue and grooved to top.
DW-4810-A-24-WG-G	Single Face Adder	24 1/4"	10 1/8"	48"	8 1/2"	2	3			\$ 2,387	
DW-4812-S-24-WG-G	Single Face Starter	25 1/4"	12 1/8"	48"	10 1/2"	2	3			\$ 2,806	
DW-4812-A-24-WG-G	Single Face Adder	24 1/4"	12 1/8"	48"	10 1/2"	2	3			\$ 2,401	
DW-4814-S-24-WG-G	Single Face Starter	25 1/4"	14 5/8"	48"	13 1/2"	2	3			\$ 3,056	
DW-4814-A-24-WG-G	Single Face Adder	24 1/4"	14 5/8"	48"	13 1/2"	2	3			\$ 2,619	
DW-4810-S-30-WG-G	Single Face Starter	31 1/4"	10 1/8"	48"	8 1/2"	2	3			\$ 2,775	
DW-4810-A-30-WG-G	Single Face Adder	30 1/4"	10 1/8"	48"	8 1/2"	2	3			\$ 2,387	
DW-4812-S-30-WG-G	Single Face Starter	31 1/4"	12 1/8"	48"	10 1/2"	2	3			\$ 2,806	
DW-4812-A-30-WG-G	Single Face Adder	30 1/4"	12 1/8"	48"	10 1/2"	2	3			\$ 2,401	
DW-4814-S-30-WG-G	Single Face Starter	31 1/4"	14 5/8"	48"	13 1/2"	2	3			\$ 3,056	
DW-4814-A-30-WG-G	Single Face Adder	30 1/4"	14 5/8"	48"	13 1/2"	2	3			\$ 2,619	
DW-4810-S-36-WG-G	Single Face Starter	37 1/4"	10 1/8"	48"	8 1/2"	2	3	74.8 Lbs.	5 Cu Ft	\$ 2,588	
DW-4810-A-36-WG-G	Single Face Adder	36 1/4"	10 1/8"	48"	8 1/2"	2	3	65.5 Lbs.	5 Cu Ft	\$ 2,200	
DW-4812-S-36-WG-G	Single Face Starter	37 1/4"	12 1/8"	48"	10 1/2"	2	3	82.8 Lbs.	6 Cu Ft	\$ 2,628	
DW-4812-A-36-WG-G	Single Face Adder	36 1/4"	12 1/8"	48"	10 1/2"	2	3	71.3 Lbs.	6 Cu Ft	\$ 2,215	
DW-4814-S-36-WG-G	Single Face Starter	37 1/4"	14 5/8"	48"	13 1/2"	2	3	108 Lbs.	7 Cu Ft	\$ 2,876	
DW-4814-A-36-WG-G	Single Face Adder	36 1/4"	14 5/8"	48"	13 1/2"	2	3	92 Lbs.	7 Cu Ft	\$ 2,433	
DW-6010-S-24-WG-G	Single Face Starter	25 1/4"	10 1/8"	60"	8 1/2"	3	4			\$ 3,545	
DW-6010-A-24-WG-G	Single Face Adder	24 1/4"	10 1/8"	60"	8 1/2"	3	4			\$ 3,172	
DW-6012-S-24-WG-G	Single Face Starter	25 1/4"	12 1/8"	60"	10 1/2"	3	4			\$ 3,622	
DW-6012-A-24-WG-G	Single Face Adder	24 1/4"	12 1/8"	60"	10 1/2"	3	4			\$ 3,234	
DW-6014-S-24-WG-G	Single Face Starter	25 1/4"	14 5/8"	60"	13 1/2"	3	4			\$ 3,926	
DW-6014-A-24-WG-G	Single Face Adder	24 1/4"	14 5/8"	60"	13 1/2"	3	4			\$ 3,506	
DW-6010-S-30-WG-G	Single Face Starter	31 1/4"	10 1/8"	60"	8 1/2"	3	4			\$ 3,545	
DW-6010-A-30-WG-G	Single Face Adder	30 1/4"	10 1/8"	60"	8 1/2"	3	4			\$ 3,172	
DW-6012-S-30-WG-G	Single Face Starter	31 1/4"	12 1/8"	60"	10 1/2"	3	4			\$ 3,622	
DW-6012-A-30-WG-G	Single Face Adder	30 1/4"	12 1/8"	60"	10 1/2"	3	4			\$ 3,234	
DW-6014-S-30-WG-G	Single Face Starter	31 1/4"	14 5/8"	60"	13 1/2"	3	4			\$ 3,926	
DW-6014-A-30-WG-G	Single Face Adder	30 1/4"	14 5/8"	60"	13 1/2"	3	4			\$ 3,506	
DW-6010-S-36-WG-G	Single Face Starter	37 1/4"	10 1/8"	60"	8 1/2"	3	4	100 Lbs.	6 Cu Ft	\$ 3,365	
DW-6010-A-36-WG-G	Single Face Adder	36 1/4"	10 1/8"	60"	8 1/2"	3	4	86.3 Lbs.	6 Cu Ft	\$ 2,992	
DW-6012-S-36-WG-G	Single Face Starter	37 1/4"	12 1/8"	60"	10 1/2"	3	4	116 Lbs.	8 Cu Ft	\$ 3,444	
DW-6012-A-36-WG-G	Single Face Adder	36 1/4"	12 1/8"	60"	10 1/2"	3	4	95.5 Lbs.	7 Cu Ft	\$ 3,056	
DW-6014-S-36-WG-G	Single Face Starter	37 1/4"	14 5/8"	60"	13 1/2"	3	4	141 Lbs.	9 Cu Ft	\$ 3,747	
DW-6014-A-36-WG-G	Single Face Adder	36 1/4"	14 5/8"	60"	13 1/2"	3	4	121 Lbs.	8 Cu Ft	\$ 3,319	



Model Shown  
DW-7212-S-36-WG-G



Model Shown  
DW-7212-A-36-WG-G





Model Shown  
DW-8212-S-36-WG-G







Model Shown  
DW-8212-A-36-WG-G



MODEL NUMBER	PRODUCT	WIDTH	DEPTH	HEIGHT	SHELF DEPTH	# OF SHELVES	# OF OPENINGS	WEIGHT	VOLUME	LIST PRICE	DESCRIPTION
DW-7210-S-24-WG-G	Single Face Starter	25 1/4"	10 1/8"	72"	8 1/2"	4	5			\$ 3,693	End, Mid, Top and Base Panels to be constructed from 1" thick 11-ply solid core, veneered 2 sides. Vertical, top and bottom edges banded with 1/4" external hardwood edging, edges to be eased. Front Edge: 3/4" thick x 2 1/2" high fascia - tongue and grooved to top.
DW-7210-A-24-WG-G	Single Face Adder	24 1/4"	10 1/8"	72"	8 1/2"	4	5			\$ 3,312	
DW-7212-S-24-WG-G	Single Face Starter	25 1/4"	12 1/8"	72"	10 1/2"	4	5			\$ 3,786	
DW-7212-A-24-WG-G	Single Face Adder	24 1/4"	12 1/8"	72"	10 1/2"	4	5			\$ 3,397	
DW-7214-S-24-WG-G	Single Face Starter	25 1/4"	14 5/8"	72"	13 1/2"	4	5			\$ 4,120	
DW-7214-A-24-WG-G	Single Face Adder	24 1/4"	14 5/8"	72"	13 1/2"	4	5			\$ 3,708	
DW-7210-S-30-WG-G	Single Face Starter	31 1/4"	10 1/8"	72"	8 1/2"	4	5			\$ 3,693	
DW-7210-A-30-WG-G	Single Face Adder	30 1/4"	10 1/8"	72"	8 1/2"	4	5			\$ 3,312	
DW-7212-S-30-WG-G	Single Face Starter	31 1/4"	12 1/8"	72"	10 1/2"	4	5			\$ 3,786	
DW-7212-A-30-WG-G	Single Face Adder	30 1/4"	12 1/8"	72"	10 1/2"	4	5			\$ 3,397	
DW-7214-S-30-WG-G	Single Face Starter	31 1/4"	14 5/8"	72"	13 1/2"	4	5			\$ 4,120	
DW-7214-A-30-WG-G	Single Face Adder	30 1/4"	14 5/8"	72"	13 1/2"	4	5			\$ 3,708	
DW-7210-S-36-WG-G	Single Face Starter	37 1/4"	10 1/8"	72"	8 1/2"	4	5	115 Lbs.	7 Cu Ft	\$ 3,506	
DW-7210-A-36-WG-G	Single Face Adder	36 1/4"	10 1/8"	72"	8 1/2"	4	5	96.6 Lbs.	7 Cu Ft	\$ 3,125	
DW-7212-S-36-WG-G	Single Face Starter	37 1/4"	12 1/8"	72"	10 1/2"	4	5	131 Lbs.	8 Cu Ft	\$ 3,606	
DW-7212-A-36-WG-G	Single Face Adder	36 1/4"	12 1/8"	72"	10 1/2"	4	5	109 Lbs.	8 Cu Ft	\$ 3,210	
DW-7214-S-36-WG-G	Single Face Starter	37 1/4"	14 5/8"	72"	13 1/2"	4	5	159 Lbs.	10 Cu Ft	\$ 3,934	
DW-7214-A-36-WG-G	Single Face Adder	36 1/4"	14 5/8"	72"	13 1/2"	4	5	132 Lbs.	9 Cu Ft	\$ 3,521	
DW-8210-S-24-WG-G	Single Face Starter	25 1/4"	10 1/8"	82"	8 1/2"	5	6			\$ 3,841	
DW-8210-A-24-WG-G	Single Face Adder	24 1/4"	10 1/8"	82"	8 1/2"	5	6			\$ 3,458	
DW-8212-S-24-WG-G	Single Face Starter	25 1/4"	12 1/8"	82"	10 1/2"	5	6			\$ 3,941	
DW-8212-A-24-WG-G	Single Face Adder	24 1/4"	12 1/8"	82"	10 1/2"	5	6			\$ 3,552	
DW-8214-S-24-WG-G	Single Face Starter	25 1/4"	14 5/8"	82"	13 1/2"	5	6			\$ 4,276	
DW-8214-A-24-WG-G	Single Face Adder	24 1/4"	14 5/8"	82"	13 1/2"	5	6			\$ 3,926	
DW-8210-S-30-WG-G	Single Face Starter	31 1/4"	10 1/8"	82"	8 1/2"	5	6			\$ 3,841	
DW-8210-A-30-WG-G	Single Face Adder	30 1/4"	10 1/8"	82"	8 1/2"	5	6			\$ 3,458	
DW-8212-S-30-WG-G	Single Face Starter	31 1/4"	12 1/8"	82"	10 1/2"	5	6			\$ 3,941	
DW-8212-A-30-WG-G	Single Face Adder	30 1/4"	12 1/8"	82"	10 1/2"	5	6			\$ 3,552	
DW-8214-S-30-WG-G	Single Face Starter	31 1/4"	14 5/8"	82"	13 1/2"	5	6			\$ 4,276	
DW-8214-A-30-WG-G	Single Face Adder	30 1/4"	14 5/8"	82"	13 1/2"	5	6			\$ 3,926	
DW-8210-S-36-WG-G	Single Face Starter	37 1/4"	10 1/8"	82"	8 1/2"	5	6	129 Lbs.	8 Cu Ft	\$ 3,654	
DW-8210-A-36-WG-G	Single Face Adder	36 1/4"	10 1/8"	82"	8 1/2"	5	6	107 Lbs.	7 Cu Ft	\$ 3,281	
DW-8212-S-36-WG-G	Single Face Starter	37 1/4"	12 1/8"	82"	10 1/2"	5	6	145 Lbs.	9 Cu Ft	\$ 3,763	
DW-8212-A-36-WG-G	Single Face Adder	36 1/4"	12 1/8"	82"	10 1/2"	5	6	122 Lbs.	8 Cu Ft	\$ 3,365	
DW-8214-S-36-WG-G	Single Face Starter	37 1/4"	14 5/8"	82"	13 1/2"	5	6	175 Lbs.	11 Cu Ft	\$ 4,089	
DW-8214-A-36-WG-G	Single Face Adder	36 1/4"	14 5/8"	82"	13 1/2"	5	6	143 Lbs.	10 Cu Ft	\$ 3,747	







MODEL NUMBER	PRODUCT	WIDTH	DEPTH	HEIGHT	SHELF DEPTH	# OF SHELVES	# OF OPENINGS	WEIGHT	VOLUME	LIST PRICE	DESCRIPTION
 Model Shown DW-9612-S-36-WG-G	DW-9610-S-24-WG-G	25 <sup>1</sup> / <sub>4</sub> "	10 <sup>1</sup> / <sub>8</sub> "	96"	8 <sup>1</sup> / <sub>2</sub> "	6	7			\$ 3,973	End, Mid, Top and Base Panels to be constructed from 1" thick 11-ply solid core, veneered 2 sides. Vertical, top and bottom edges banded with 1/4" external hardwood edging, edges to be eased. Front Edge: 3/4" thick x 2 1/2" high fascia - tongue and grooved to top.
	DW-9610-A-24-WG-G	24 <sup>1</sup> / <sub>4</sub> "	10 <sup>1</sup> / <sub>8</sub> "	96"	8 <sup>1</sup> / <sub>2</sub> "	6	7			\$ 3,599	
	DW-9612-S-24-WG-G	25 <sup>1</sup> / <sub>4</sub> "	12 <sup>1</sup> / <sub>8</sub> "	96"	10 <sup>1</sup> / <sub>2</sub> "	6	7			\$ 4,104	
	DW-9612-A-24-WG-G	24 <sup>1</sup> / <sub>4</sub> "	12 <sup>1</sup> / <sub>8</sub> "	96"	10 <sup>1</sup> / <sub>2</sub> "	6	7			\$ 3,708	
	DW-9614-S-24-WG-G	25 <sup>1</sup> / <sub>4</sub> "	14 <sup>5</sup> / <sub>8</sub> "	96"	13 <sup>1</sup> / <sub>2</sub> "	6	7			\$ 4,563	
	DW-9614-A-24-WG-G	24 <sup>1</sup> / <sub>4</sub> "	14 <sup>5</sup> / <sub>8</sub> "	96"	13 <sup>1</sup> / <sub>2</sub> "	6	7			\$ 4,104	
 Model Shown DW-9612-A-36-WG-G	DW-9610-S-30-WG-G	31 <sup>1</sup> / <sub>4</sub> "	10 <sup>1</sup> / <sub>8</sub> "	96"	8 <sup>1</sup> / <sub>2</sub> "	6	7			\$ 3,973	
	DW-9610-A-30-WG-G	30 <sup>1</sup> / <sub>4</sub> "	10 <sup>1</sup> / <sub>8</sub> "	96"	8 <sup>1</sup> / <sub>2</sub> "	6	7			\$ 3,599	
	DW-9612-S-30-WG-G	31 <sup>1</sup> / <sub>4</sub> "	12 <sup>1</sup> / <sub>8</sub> "	96"	10 <sup>1</sup> / <sub>2</sub> "	6	7			\$ 4,104	
	DW-9612-A-30-WG-G	30 <sup>1</sup> / <sub>4</sub> "	12 <sup>1</sup> / <sub>8</sub> "	96"	10 <sup>1</sup> / <sub>2</sub> "	6	7			\$ 3,708	
	DW-9614-S-30-WG-G	31 <sup>1</sup> / <sub>4</sub> "	14 <sup>5</sup> / <sub>8</sub> "	96"	13 <sup>1</sup> / <sub>2</sub> "	6	7			\$ 4,563	
	DW-9614-A-30-WG-G	30 <sup>1</sup> / <sub>4</sub> "	14 <sup>5</sup> / <sub>8</sub> "	96"	13 <sup>1</sup> / <sub>2</sub> "	6	7			\$ 4,104	
	DW-9610-S-36-WG-G	37 <sup>1</sup> / <sub>4</sub> "	10 <sup>1</sup> / <sub>8</sub> "	96"	8 <sup>1</sup> / <sub>2</sub> "	6	7	156 Lbs.	9 Cu Ft	\$ 3,794	
	DW-9610-A-36-WG-G	36 <sup>1</sup> / <sub>4</sub> "	10 <sup>1</sup> / <sub>8</sub> "	96"	8 <sup>1</sup> / <sub>2</sub> "	6	7	128 Lbs.	8 Cu Ft	\$ 3,412	
	DW-9612-S-36-WG-G	37 <sup>1</sup> / <sub>4</sub> "	12 <sup>1</sup> / <sub>8</sub> "	96"	10 <sup>1</sup> / <sub>2</sub> "	6	7	177 Lbs.	10 Cu Ft	\$ 3,926	
	DW-9612-A-36-WG-G	36 <sup>1</sup> / <sub>4</sub> "	12 <sup>1</sup> / <sub>8</sub> "	96"	10 <sup>1</sup> / <sub>2</sub> "	6	7	145 Lbs.	9 Cu Ft	\$ 3,529	
	DW-9614-S-36-WG-G	37 <sup>1</sup> / <sub>4</sub> "	14 <sup>5</sup> / <sub>8</sub> "	96"	13 <sup>1</sup> / <sub>2</sub> "	6	7	213 Lbs.	12 Cu Ft	\$ 4,385	
	DW-9614-A-36-WG-G	36 <sup>1</sup> / <sub>4</sub> "	14 <sup>5</sup> / <sub>8</sub> "	96"	13 <sup>1</sup> / <sub>2</sub> "	6	7	175 Lbs.	11 Cu Ft	\$ 3,926	





	MODEL NUMBER	PRODUCT	WIDTH	DEPTH	HEIGHT	SHELF DEPTH	# OF SHELVES	# OF OPENINGS	WEIGHT	VOLUME	LIST PRICE	DESCRIPTION
 <p>Model Shown DW-3624-S-36-WG-G</p>	DW-3620-S-24-WG-G	Double Face Starter	25 1/4"	19 1/2"	36"	8 1/2"	2	4			\$ 5,022	End, Mid, Top and Base Panels to be constructed from 1" thick 11-ply solid core, veneered 2 sides. Vertical, top and bottom edges banded with 1/4" external hardwood edging, edges to be eased. Front Edge: 3/4" thick x 2 1/2" high fascia - tongue and grooved to top.
	DW-3620-A-24-WG-G	Double Face Adder	24 1/4"	19 1/2"	36"	8 1/2"	2	4			\$ 4,377	
	DW-3624-S-24-WG-G	Double Face Starter	25 1/4"	23 1/2"	36"	10 1/2"	2	4			\$ 5,085	
	DW-3624-A-24-WG-G	Double Face Adder	24 1/4"	23 1/2"	36"	10 1/2"	2	4			\$ 4,408	
	DW-3628-S-24-WG-G	Double Face Starter	25 1/4"	28 1/2"	36"	13 1/2"	2	4			\$ 5,497	
	DW-3628-A-24-WG-G	Double Face Adder	24 1/4"	28 1/2"	36"	13 1/2"	2	4			\$ 4,758	
 <p>Model Shown DW-3624-A-36-WG-G</p>	DW-3620-S-30-WG-G	Double Face Starter	31 1/4"	19 1/2"	36"	8 1/2"	2	4			\$ 5,022	
	DW-3620-A-30-WG-G	Double Face Adder	30 1/4"	19 1/2"	36"	8 1/2"	2	4			\$ 4,377	
	DW-3624-S-30-WG-G	Double Face Starter	31 1/4"	23 1/2"	36"	10 1/2"	2	4			\$ 5,085	
	DW-3624-A-30-WG-G	Double Face Adder	30 1/4"	23 1/2"	36"	10 1/2"	2	4			\$ 4,408	
	DW-3628-S-30-WG-G	Double Face Starter	31 1/4"	28 1/2"	36"	13 1/2"	2	4			\$ 5,497	
	DW-3628-A-30-WG-G	Double Face Adder	30 1/4"	28 1/2"	36"	13 1/2"	2	4			\$ 4,758	
	DW-3620-S-36-WG-G	Double Face Starter	37 1/4"	19 1/2"	36"	8 1/2"	2	4	88.6 Lbs.	7 Cu Ft	\$ 4,751	
	DW-3620-A-36-WG-G	Double Face Adder	36 1/4"	19 1/2"	36"	8 1/2"	2	4	73.6 Lbs.	6 Cu Ft	\$ 4,097	
	DW-3624-S-36-WG-G	Double Face Starter	37 1/4"	23 1/2"	36"	10 1/2"	2	4	110 Lbs.	10 Cu Ft	\$ 4,812	
	DW-3624-A-36-WG-G	Double Face Adder	36 1/4"	23 1/2"	36"	10 1/2"	2	4	88.6 Lbs.	9 Cu Ft	\$ 4,135	
	DW-3628-S-36-WG-G	Double Face Starter	37 1/4"	28 1/2"	36"	13 1/2"	2	4	132 Lbs.	11 Cu Ft	\$ 5,216	
	DW-3628-A-36-WG-G	Double Face Adder	36 1/4"	28 1/2"	36"	13 1/2"	2	4	104 Lbs.	10 Cu Ft	\$ 4,477	
 <p>Model Shown DW-4224-S-36-WG-G</p>	DW-4220-S-24-WG-G	Double Face Starter	25 1/4"	19 1/2"	42"	8 1/2"	4	6			\$ 5,316	
	DW-4220-A-24-WG-G	Double Face Adder	24 1/4"	19 1/2"	42"	8 1/2"	4	6			\$ 4,664	
	DW-4224-S-24-WG-G	Double Face Starter	25 1/4"	23 1/2"	42"	10 1/2"	4	6			\$ 5,411	
	DW-4224-A-24-WG-G	Double Face Adder	24 1/4"	23 1/2"	42"	10 1/2"	4	6			\$ 4,733	
	DW-4228-S-24-WG-G	Double Face Starter	25 1/4"	28 1/2"	42"	13 1/2"	4	6			\$ 5,785	
	DW-4228-A-24-WG-G	Double Face Adder	24 1/4"	28 1/2"	42"	13 1/2"	4	6			\$ 5,199	
 <p>Model Shown DW-4224-A-36-WG-G</p>	DW-4220-S-30-WG-G	Double Face Starter	31 1/4"	19 1/2"	42"	8 1/2"	4	6			\$ 5,316	
	DW-4220-A-30-WG-G	Double Face Adder	30 1/4"	19 1/2"	42"	8 1/2"	4	6			\$ 4,664	
	DW-4224-S-30-WG-G	Double Face Starter	31 1/4"	23 1/2"	42"	10 1/2"	4	6			\$ 5,411	
	DW-4224-A-30-WG-G	Double Face Adder	30 1/4"	23 1/2"	42"	10 1/2"	4	6			\$ 4,733	
	DW-4228-S-30-WG-G	Double Face Starter	31 1/4"	28 1/2"	42"	13 1/2"	4	6			\$ 5,785	
	DW-4228-A-30-WG-G	Double Face Adder	30 1/4"	28 1/2"	42"	13 1/2"	4	6			\$ 5,199	
	DW-4220-S-36-WG-G	Double Face Starter	37 1/4"	19 1/2"	42"	8 1/2"	4	6	94 Lbs.	7 Cu Ft	\$ 5,038	
	DW-4220-A-36-WG-G	Double Face Adder	36 1/4"	19 1/2"	42"	8 1/2"	4	6	78 Lbs.	7 Cu Ft	\$ 4,392	
	DW-4224-S-36-WG-G	Double Face Starter	37 1/4"	23 1/2"	42"	10 1/2"	4	6	115 Lbs.	10 Cu Ft	\$ 5,130	
	DW-4224-A-36-WG-G	Double Face Adder	36 1/4"	23 1/2"	42"	10 1/2"	4	6	113 Lbs.	10 Cu Ft	\$ 4,453	
	DW-4228-S-36-WG-G	Double Face Starter	37 1/4"	28 1/2"	42"	13 1/2"	4	6	183 Lbs.	13 Cu Ft	\$ 5,659	
	DW-4228-A-36-WG-G	Double Face Adder	36 1/4"	28 1/2"	42"	13 1/2"	4	6	109 Lbs.	13 Cu Ft	\$ 4,921	

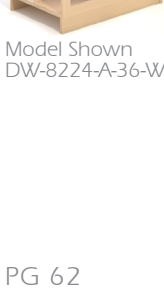





	MODEL NUMBER	PRODUCT	WIDTH	DEPTH	HEIGHT	SHELF DEPTH	# OF SHELVES	# OF OPENINGS	WEIGHT	VOLUME	LIST PRICE	DESCRIPTION
 <p>Model Shown DW-4224-S-36-WG-G</p>	DW-4820-S-24-WG-G	Double Face Starter	25 1/4"	19 1/2"	48"	8 1/2"	4	6			\$ 5,573	End, Mid, Top and Base Panels to be constructed from 1" thick 11-ply solid core, veneered 2 sides. Vertical, top and bottom edges banded with 1/4" external hardwood edging, edges to be eased. Front Edge: 3/4" thick x 2 1/2" high fascia - tongue and grooved to top.
	DW-4820-A-24-WG-G	Double Face Adder	24 1/4"	19 1/2"	48"	8 1/2"	4	6			\$ 4,889	
	DW-4824-S-24-WG-G	Double Face Starter	25 1/4"	23 1/2"	48"	10 1/2"	4	6			\$ 5,667	
	DW-4824-A-24-WG-G	Double Face Adder	24 1/4"	23 1/2"	48"	10 1/2"	4	6			\$ 4,960	
	DW-4828-S-24-WG-G	Double Face Starter	25 1/4"	28 1/2"	48"	13 1/2"	4	6			\$ 6,219	
	DW-4828-A-24-WG-G	Double Face Adder	24 1/4"	28 1/2"	48"	13 1/2"	4	6			\$ 5,441	
	DW-4820-S-30-WG-G	Double Face Starter	31 1/4"	19 1/2"	48"	8 1/2"	4	6			\$ 5,573	
	DW-4820-A-30-WG-G	Double Face Adder	30 1/4"	19 1/2"	48"	8 1/2"	4	6			\$ 4,889	
DW-4824-S-30-WG-G	Double Face Starter	31 1/4"	23 1/2"	48"	10 1/2"	4	6			\$ 5,667		
DW-4824-A-30-WG-G	Double Face Adder	30 1/4"	23 1/2"	48"	10 1/2"	4	6			\$ 4,960		
DW-4828-S-30-WG-G	Double Face Starter	31 1/4"	28 1/2"	48"	13 1/2"	4	6			\$ 6,219		
DW-4828-A-30-WG-G	Double Face Adder	30 1/4"	28 1/2"	48"	13 1/2"	4	6			\$ 5,441		
DW-4820-S-36-WG-G	Double Face Starter	37 1/4"	19 1/2"	48"	8 1/2"	4	6	132 Lbs.	9 Cu Ft	\$ 5,287		
DW-4820-A-36-WG-G	Double Face Adder	36 1/4"	19 1/2"	48"	8 1/2"	4	6	109 Lbs.	8 Cu Ft	\$ 4,602		
DW-4824-S-36-WG-G	Double Face Starter	37 1/4"	23 1/2"	48"	10 1/2"	4	6	155 Lbs.	11 Cu Ft	\$ 5,380		
DW-4824-A-36-WG-G	Double Face Adder	36 1/4"	23 1/2"	48"	10 1/2"	4	6	127 Lbs.	10 Cu Ft	\$ 4,671		
DW-4828-S-36-WG-G	Double Face Starter	37 1/4"	28 1/2"	48"	13 1/2"	4	6	178 Lbs.	13 Cu Ft	\$ 5,924		
DW-4828-A-36-WG-G	Double Face Adder	36 1/4"	28 1/2"	48"	13 1/2"	4	6	144 Lbs.	12 Cu Ft	\$ 5,153		
 <p>Model Shown DW-6024-S-36-WG-G</p>	DW-6020-S-24-WG-G	Double Face Starter	25 1/4"	19 1/2"	60"	8 1/2"	6	8			\$ 7,121	
	DW-6020-A-24-WG-G	Double Face Adder	24 1/4"	19 1/2"	60"	8 1/2"	6	8			\$ 6,443	
	DW-6024-S-24-WG-G	Double Face Starter	25 1/4"	23 1/2"	60"	10 1/2"	6	8			\$ 7,229	
	DW-6024-A-24-WG-G	Double Face Adder	24 1/4"	23 1/2"	60"	10 1/2"	6	8			\$ 6,553	
	DW-6028-S-24-WG-G	Double Face Starter	25 1/4"	28 1/2"	60"	13 1/2"	6	8			\$ 7,874	
	DW-6028-A-24-WG-G	Double Face Adder	24 1/4"	28 1/2"	60"	13 1/2"	6	8			\$ 7,114	
	DW-6020-S-30-WG-G	Double Face Starter	31 1/4"	19 1/2"	60"	8 1/2"	6	8			\$ 7,121	
	DW-6020-A-30-WG-G	Double Face Adder	30 1/4"	19 1/2"	60"	8 1/2"	6	8			\$ 6,443	
DW-6024-S-30-WG-G	Double Face Starter	31 1/4"	23 1/2"	60"	10 1/2"	6	8			\$ 7,229		
DW-6024-A-30-WG-G	Double Face Adder	30 1/4"	23 1/2"	60"	10 1/2"	6	8			\$ 6,553		
DW-6028-S-30-WG-G	Double Face Starter	31 1/4"	28 1/2"	60"	13 1/2"	6	8			\$ 7,874		
DW-6028-A-30-WG-G	Double Face Adder	30 1/4"	28 1/2"	60"	13 1/2"	6	8			\$ 7,114		
DW-6020-S-36-WG-G	Double Face Starter	37 1/4"	19 1/2"	60"	8 1/2"	6	8	176 Lbs.	11 Cu Ft	\$ 6,840		
DW-6020-A-36-WG-G	Double Face Adder	36 1/4"	19 1/2"	60"	8 1/2"	6	8	145 Lbs.	10 Cu Ft	\$ 6,173		
DW-6024-S-36-WG-G	Double Face Starter	37 1/4"	23 1/2"	60"	10 1/2"	6	8	200 Lbs.	12 Cu Ft	\$ 6,951		
DW-6024-A-36-WG-G	Double Face Adder	36 1/4"	23 1/2"	60"	10 1/2"	6	8	164 Lbs.	11 Cu Ft	\$ 6,273		
DW-6028-S-36-WG-G	Double Face Starter	37 1/4"	28 1/2"	60"	13 1/2"	6	8	224 Lbs.	13 Cu Ft	\$ 7,593		
DW-6028-A-36-WG-G	Double Face Adder	36 1/4"	28 1/2"	60"	13 1/2"	6	8	184 Lbs.	12 Cu Ft	\$ 6,833		

MODEL NUMBER	PRODUCT	WIDTH	DEPTH	HEIGHT	SHELF DEPTH	# OF SHELVES	# OF OPENINGS	WEIGHT	VOLUME	LIST PRICE	DESCRIPTION
	DW-7220-S-24-WG-G	Double Face Starter	25 1/4"	19 1/2"	72"	8 1/2"	8			\$ 7,416	End, Mid, Top and Base Panels to be constructed from 1" thick 11-ply solid core, veneered 2 sides. Vertical, top and bottom edges banded with 1/4" external hardwood edging, edges to be eased. Front Edge: 3/4" thick x 2 1/2" high fascia - tongue and grooved to top.
	DW-7220-A-24-WG-G	Double Face Adder	24 1/4"	19 1/2"	72"	8 1/2"	8			\$ 6,732	
	DW-7224-S-24-WG-G	Double Face Starter	25 1/4"	23 1/2"	72"	10 1/2"	8			\$ 7,541	
	DW-7224-A-24-WG-G	Double Face Adder	24 1/4"	23 1/2"	72"	10 1/2"	8			\$ 6,856	
	DW-7228-S-24-WG-G	Double Face Starter	25 1/4"	28 1/2"	72"	13 1/2"	8			\$ 8,256	
	DW-7228-A-24-WG-G	Double Face Adder	24 1/4"	28 1/2"	72"	13 1/2"	8			\$ 7,509	
	DW-7220-S-30-WG-G	Double Face Starter	31 1/4"	19 1/2"	72"	8 1/2"	8			\$ 7,416	
	DW-7220-A-30-WG-G	Double Face Adder	30 1/4"	19 1/2"	72"	8 1/2"	8			\$ 6,732	
	DW-7224-S-30-WG-G	Double Face Starter	31 1/4"	23 1/2"	72"	10 1/2"	8			\$ 7,541	
	DW-7224-A-30-WG-G	Double Face Adder	30 1/4"	23 1/2"	72"	10 1/2"	8			\$ 6,856	
	DW-7228-S-30-WG-G	Double Face Starter	31 1/4"	28 1/2"	72"	13 1/2"	8			\$ 8,256	
	DW-7228-A-30-WG-G	Double Face Adder	30 1/4"	28 1/2"	72"	13 1/2"	8			\$ 7,509	
	DW-7220-S-36-WG-G	Double Face Starter	37 1/4"	19 1/2"	72"	8 1/2"	8			\$ 7,137	
	DW-7220-A-36-WG-G	Double Face Adder	36 1/4"	19 1/2"	72"	8 1/2"	8	200 Lbs.	12 Cu Ft	\$ 6,461	
	DW-7224-S-36-WG-G	Double Face Starter	37 1/4"	23 1/2"	72"	10 1/2"	8	164 Lbs.	11 Cu Ft	\$ 7,261	
	DW-7224-A-36-WG-G	Double Face Adder	36 1/4"	23 1/2"	72"	10 1/2"	8	229 Lbs.	13 Cu Ft	\$ 6,585	
	DW-7228-S-36-WG-G	Double Face Starter	37 1/4"	28 1/2"	72"	13 1/2"	8	186 Lbs.	12 Cu Ft	\$ 7,984	
	DW-7228-A-36-WG-G	Double Face Adder	36 1/4"	28 1/2"	72"	13 1/2"	8	256 Lbs.	14 Cu Ft	\$ 7,229	
	DW-8220-S-24-WG-G	Double Face Starter	25 1/4"	19 1/2"	82"	8 1/2"	10			\$ 7,697	
	DW-8220-A-24-WG-G	Double Face Adder	24 1/4"	19 1/2"	82"	8 1/2"	10			\$ 7,003	
	DW-8224-S-24-WG-G	Double Face Starter	25 1/4"	23 1/2"	82"	10 1/2"	10			\$ 7,851	
	DW-8224-A-24-WG-G	Double Face Adder	24 1/4"	23 1/2"	82"	10 1/2"	10			\$ 7,182	
	DW-8228-S-24-WG-G	Double Face Starter	25 1/4"	28 1/2"	82"	13 1/2"	10			\$ 8,979	
	DW-8228-A-24-WG-G	Double Face Adder	24 1/4"	28 1/2"	82"	13 1/2"	10			\$ 8,052	
	DW-8220-S-30-WG-G	Double Face Starter	31 1/4"	19 1/2"	82"	8 1/2"	10			\$ 7,697	
	DW-8220-A-30-WG-G	Double Face Adder	30 1/4"	19 1/2"	82"	8 1/2"	10			\$ 7,003	
	DW-8224-S-30-WG-G	Double Face Starter	31 1/4"	23 1/2"	82"	10 1/2"	10			\$ 7,851	
	DW-8224-A-30-WG-G	Double Face Adder	30 1/4"	23 1/2"	82"	10 1/2"	10			\$ 7,182	
	DW-8228-S-30-WG-G	Double Face Starter	31 1/4"	28 1/2"	82"	13 1/2"	10			\$ 8,979	
	DW-8228-A-30-WG-G	Double Face Adder	30 1/4"	28 1/2"	82"	13 1/2"	10			\$ 8,052	
	DW-8220-S-36-WG-G	Double Face Starter	37 1/4"	19 1/2"	82"	8 1/2"	10	224 Lbs.	12 Cu Ft	\$ 7,416	
	DW-8220-A-36-WG-G	Double Face Adder	36 1/4"	19 1/2"	82"	8 1/2"	10	184 Lbs.	11 Cu Ft	\$ 6,740	
	DW-8224-S-36-WG-G	Double Face Starter	37 1/4"	23 1/2"	82"	10 1/2"	10	256 Lbs.	14 Cu Ft	\$ 7,603	
	DW-8224-A-36-WG-G	Double Face Adder	36 1/4"	23 1/2"	82"	10 1/2"	10	207 Lbs.	12 Cu Ft	\$ 6,903	
	DW-8228-S-36-WG-G	Double Face Starter	37 1/4"	28 1/2"	82"	13 1/2"	10	289 Lbs.	16 Cu Ft	\$ 8,699	
	DW-8228-A-36-WG-G	Double Face Adder	36 1/4"	28 1/2"	82"	13 1/2"	10	230 Lbs.	14 Cu Ft	\$ 7,774	





	MODEL NUMBER	PRODUCT	WIDTH	DEPTH	HEIGHT	SHELF DEPTH	# OF SHELVES	# OF OPENINGS	WEIGHT	VOLUME	LIST PRICE	DESCRIPTION
	DW-9620-S-24-WG-G	Double Face Starter	25 1/4"	19 1/2"	96"	8 1/2"	12	14			\$ 8,380	End, Mid, Top and Base Panels to be constructed from 1" thick 11-ply solid core, veneered 2 sides. Vertical, top and bottom edges banded with 1/4" external hardwood edging, edges to be eased. Front Edge: 3/4" thick x 2 1/2" high fascia - tongue and grooved to top.
	DW-9620-A-24-WG-G	Double Face Adder	24 1/4"	19 1/2"	96"	8 1/2"	12	14			\$ 7,673	
	DW-9624-S-24-WG-G	Double Face Starter	25 1/4"	23 1/2"	96"	10 1/2"	12	14			\$ 8,738	
	DW-9624-A-24-WG-G	Double Face Adder	24 1/4"	23 1/2"	96"	10 1/2"	12	14			\$ 8,038	
	DW-9628-S-24-WG-G	Double Face Starter	25 1/4"	28 1/2"	96"	13 1/2"	12	14			\$ 9,833	
	DW-9628-A-24-WG-G	Double Face Adder	24 1/4"	28 1/2"	96"	13 1/2"	12	14			\$ 8,878	
	DW-9620-S-30-WG-G	Double Face Starter	31 1/4"	19 1/2"	96"	8 1/2"	12	14			\$ 8,380	
	DW-9620-A-30-WG-G	Double Face Adder	30 1/4"	19 1/2"	96"	8 1/2"	12	14			\$ 7,673	
	DW-9624-S-30-WG-G	Double Face Starter	31 1/4"	23 1/2"	96"	10 1/2"	12	14			\$ 8,738	
	DW-9624-A-30-WG-G	Double Face Adder	30 1/4"	23 1/2"	96"	10 1/2"	12	14			\$ 8,038	
	DW-9628-S-30-WG-G	Double Face Starter	31 1/4"	28 1/2"	96"	13 1/2"	12	14			\$ 9,833	
	DW-9628-A-30-WG-G	Double Face Adder	30 1/4"	28 1/2"	96"	13 1/2"	12	14			\$ 8,878	
	DW-9620-S-36-WG-G	Double Face Starter	37 1/4"	19 1/2"	96"	8 1/2"	12	14	276 Lbs.	13 Cu Ft	\$ 7,984	
	DW-9620-A-36-WG-G	Double Face Adder	36 1/4"	19 1/2"	96"	8 1/2"	12	14	220 Lbs.	12 Cu Ft	\$ 7,307	
	DW-9624-S-36-WG-G	Double Face Starter	37 1/4"	23 1/2"	96"	10 1/2"	12	14	315 Lbs.	15 Cu Ft	\$ 8,318	
	DW-9624-A-36-WG-G	Double Face Adder	36 1/4"	23 1/2"	96"	10 1/2"	12	14	247 Lbs.	13 Cu Ft	\$ 7,493	
	DW-9628-S-36-WG-G	Double Face Starter	37 1/4"	28 1/2"	96"	13 1/2"	12	14	353 Lbs.	17 Cu Ft	\$ 9,360	
	DW-9628-A-36-WG-G	Double Face Adder	36 1/4"	28 1/2"	96"	13 1/2"	12	14	275 Lbs.	15 Cu Ft	\$ 8,457	

Model Shown  
DW-9624-S-36-WG-G







Model Shown  
DW-9624-A-36-WG-G

MODEL NUMBER	PRODUCT	WIDTH	DEPTH	HEIGHT	SHELF DEPTH	# OF SHELVES	# OF OPENINGS	WEIGHT	VOLUME	LIST PRICE	DESCRIPTION
 Model Shown DW-3612-S-36-WH	DW-3610-S-24-WH	Single Face Starter	25 1/4"	10 1/8"	36"	8 1/2"	1			\$ 2,558	End, Mid, Top and Base Panels to be constructed from 1" thick 11-ply solid core, veneered 2 sides. Vertical, top and bottom edges banded with 1/4" external hardwood edging, edges to be eased. Front Edge: 3/4" thick x 2 1/2" high fascia - tongue and grooved to top.
	DW-3610-A-24-WH	Single Face Adder	24 1/4"	10 1/8"	36"	8 1/2"	1			\$ 2,184	
	DW-3612-S-24-WH	Single Face Starter	25 1/4"	12 1/8"	36"	10 1/2"	1			\$ 2,612	
	DW-3612-A-24-WH	Single Face Adder	24 1/4"	12 1/8"	36"	10 1/2"	1			\$ 2,224	
	DW-3614-S-24-WH	Single Face Starter	25 1/4"	14 5/8"	36"	13 1/2"	1			\$ 2,775	
	DW-3614-A-24-WH	Single Face Adder	24 1/4"	14 5/8"	36"	13 1/2"	1			\$ 2,348	
 Model Shown DW-3612-A-36-WH	DW-3610-S-30-WH	Single Face Starter	31 1/4"	10 1/8"	36"	8 1/2"	1			\$ 2,558	
	DW-3610-A-30-WH	Single Face Adder	30 1/4"	10 1/8"	36"	8 1/2"	1			\$ 2,184	
	DW-3612-S-30-WH	Single Face Starter	31 1/4"	12 1/8"	36"	10 1/2"	1			\$ 2,612	
	DW-3612-A-30-WH	Single Face Adder	30 1/4"	12 1/8"	36"	10 1/2"	1			\$ 2,224	
	DW-3614-S-30-WH	Single Face Starter	31 1/4"	14 5/8"	36"	13 1/2"	1			\$ 2,775	
	DW-3614-A-30-WH	Single Face Adder	30 1/4"	14 5/8"	36"	13 1/2"	1			\$ 2,348	
	DW-3610-S-36-WH	Single Face Starter	37 1/4"	10 1/8"	36"	8 1/2"	1			\$ 2,379	
	DW-3610-A-36-WH	Single Face Adder	36 1/4"	10 1/8"	36"	8 1/2"	1	50.6 Lbs.	4 Cu Ft	\$ 2,006	
	DW-3612-S-36-WH	Single Face Starter	37 1/4"	12 1/8"	36"	10 1/2"	1	46 Lbs.	4 Cu Ft	\$ 2,433	
	DW-3612-A-36-WH	Single Face Adder	36 1/4"	12 1/8"	36"	10 1/2"	1	50.6 Lbs.	5 Cu Ft	\$ 2,037	
	DW-3614-S-36-WH	Single Face Starter	37 1/4"	14 5/8"	36"	13 1/2"	1	47.2 Lbs.	5 Cu Ft	\$ 2,588	
	DW-3614-A-36-WH	Single Face Adder	36 1/4"	14 5/8"	36"	13 1/2"	1	74.8 Lbs.	6 Cu Ft	\$ 2,169	
 Model Shown DW-4212-S-36-WH	DW-4210-S-24-WH	Single Face Starter	25 1/4"	10 1/8"	42"	8 1/2"	2			\$ 2,666	
	DW-4210-A-24-WH	Single Face Adder	24 1/4"	10 1/8"	42"	8 1/2"	2			\$ 2,293	
	DW-4212-S-24-WH	Single Face Starter	25 1/4"	12 1/8"	42"	10 1/2"	2			\$ 2,722	
	DW-4212-A-24-WH	Single Face Adder	24 1/4"	12 1/8"	42"	10 1/2"	2			\$ 2,332	
	DW-4214-S-24-WH	Single Face Starter	25 1/4"	14 5/8"	42"	13 1/2"	2			\$ 2,923	
	DW-4214-A-24-WH	Single Face Adder	24 1/4"	14 5/8"	42"	13 1/2"	2			\$ 2,494	
 Model Shown DW-4212-A-36-WH	DW-4210-S-30-WH	Single Face Starter	31 1/4"	10 1/8"	42"	8 1/2"	2			\$ 2,666	
	DW-4210-A-30-WH	Single Face Adder	30 1/4"	10 1/8"	42"	8 1/2"	2			\$ 2,293	
	DW-4212-S-30-WH	Single Face Starter	31 1/4"	12 1/8"	42"	10 1/2"	2			\$ 2,722	
	DW-4212-A-30-WH	Single Face Adder	30 1/4"	12 1/8"	42"	10 1/2"	2			\$ 2,332	
	DW-4214-S-30-WH	Single Face Starter	31 1/4"	14 5/8"	42"	13 1/2"	2			\$ 2,923	
	DW-4214-A-30-WH	Single Face Adder	30 1/4"	14 5/8"	42"	13 1/2"	2			\$ 2,494	
	DW-4210-S-36-WH	Single Face Starter	37 1/4"	10 1/8"	42"	8 1/2"	2			\$ 2,481	
	DW-4210-A-36-WH	Single Face Adder	36 1/4"	10 1/8"	42"	8 1/2"	2	55 Lbs.	5 Cu Ft	\$ 2,115	
	DW-4212-S-36-WH	Single Face Starter	37 1/4"	12 1/8"	42"	10 1/2"	2	52 Lbs.	5 Cu Ft	\$ 2,542	
	DW-4212-A-36-WH	Single Face Adder	36 1/4"	12 1/8"	42"	10 1/2"	2	60 Lbs.	5 Cu Ft	\$ 2,146	
	DW-4214-S-36-WH	Single Face Starter	37 1/4"	14 5/8"	42"	13 1/2"	2	53 Lbs.	5 Cu Ft	\$ 2,736	
	DW-4214-A-36-WH	Single Face Adder	36 1/4"	14 5/8"	42"	13 1/2"	2	79 Lbs.	6 Cu Ft	\$ 2,309	



	MODEL NUMBER	PRODUCT	WIDTH	DEPTH	HEIGHT	SHELF DEPTH	# OF SHELVES	# OF OPENINGS	WEIGHT	VOLUME	LIST PRICE	DESCRIPTION
 <p>Model Shown DW-4212-S-36-WH</p>	DW-4810-S-24-WH	Single Face Starter	25 1/4"	10 1/8"	48"	8 1/2"	2	3			\$ 2,744	End, Mid, Top and Base Panels to be constructed from 1" thick 11-ply solid core, veneered 2 sides. Vertical, top and bottom edges banded with 1/4" external hardwood edging, edges to be eased. Front Edge: 3/4" thick x 2 1/2" high fascia - tongue and grooved to top.
	DW-4810-A-24-WH	Single Face Adder	24 1/4"	10 1/8"	48"	8 1/2"	2	3			\$ 2,356	
	DW-4812-S-24-WH	Single Face Starter	25 1/4"	12 1/8"	48"	10 1/2"	2	3			\$ 2,760	
	DW-4812-A-24-WH	Single Face Adder	24 1/4"	12 1/8"	48"	10 1/2"	2	3			\$ 2,356	
	DW-4814-S-24-WH	Single Face Starter	25 1/4"	14 5/8"	48"	13 1/2"	2	3			\$ 2,961	
	DW-4814-A-24-WH	Single Face Adder	24 1/4"	14 5/8"	48"	13 1/2"	2	3			\$ 2,527	
 <p>Model Shown DW-4212-A-36-WH</p>	DW-4810-S-30-WH	Single Face Starter	31 1/4"	10 1/8"	48"	8 1/2"	2	3			\$ 2,744	
	DW-4810-A-30-WH	Single Face Adder	30 1/4"	10 1/8"	48"	8 1/2"	2	3			\$ 2,356	
	DW-4812-S-30-WH	Single Face Starter	31 1/4"	12 1/8"	48"	10 1/2"	2	3			\$ 2,760	
	DW-4812-A-30-WH	Single Face Adder	30 1/4"	12 1/8"	48"	10 1/2"	2	3			\$ 2,356	
	DW-4814-S-30-WH	Single Face Starter	31 1/4"	14 5/8"	48"	13 1/2"	2	3			\$ 2,961	
	DW-4814-A-30-WH	Single Face Adder	30 1/4"	14 5/8"	48"	13 1/2"	2	3			\$ 2,527	
	DW-4810-S-36-WH	Single Face Starter	37 1/4"	10 1/8"	48"	8 1/2"	2	3	74.8 Lbs.	5 Cu Ft	\$ 2,558	
	DW-4810-A-36-WH	Single Face Adder	36 1/4"	10 1/8"	48"	8 1/2"	2	3	65.5 Lbs.	5 Cu Ft	\$ 2,169	
	DW-4812-S-36-WH	Single Face Starter	37 1/4"	12 1/8"	48"	10 1/2"	2	3	82.8 Lbs.	6 Cu Ft	\$ 2,581	
	DW-4812-A-36-WH	Single Face Adder	36 1/4"	12 1/8"	48"	10 1/2"	2	3	71.3 Lbs.	6 Cu Ft	\$ 2,169	
	DW-4814-S-36-WH	Single Face Starter	37 1/4"	14 5/8"	48"	13 1/2"	2	3	108 Lbs.	7 Cu Ft	\$ 2,783	
	DW-4814-A-36-WH	Single Face Adder	36 1/4"	14 5/8"	48"	13 1/2"	2	3	92 Lbs.	7 Cu Ft	\$ 2,339	
 <p>Model Shown DW-6012-S-36-WH</p>	DW-6010-S-24-WH	Single Face Starter	25 1/4"	10 1/8"	60"	8 1/2"	3	4			\$ 2,985	
	DW-6010-A-24-WH	Single Face Adder	24 1/4"	10 1/8"	60"	8 1/2"	3	4			\$ 2,605	
	DW-6012-S-24-WH	Single Face Starter	25 1/4"	12 1/8"	60"	10 1/2"	3	4			\$ 3,033	
	DW-6012-A-24-WH	Single Face Adder	24 1/4"	12 1/8"	60"	10 1/2"	3	4			\$ 2,651	
	DW-6014-S-24-WH	Single Face Starter	25 1/4"	14 5/8"	60"	13 1/2"	3	4			\$ 3,273	
	DW-6014-A-24-WH	Single Face Adder	24 1/4"	14 5/8"	60"	13 1/2"	3	4			\$ 2,846	
 <p>Model Shown DW-6012-A-36-WH</p>	DW-6010-S-30-WH	Single Face Starter	31 1/4"	10 1/8"	60"	8 1/2"	3	4			\$ 2,985	
	DW-6010-A-30-WH	Single Face Adder	30 1/4"	10 1/8"	60"	8 1/2"	3	4			\$ 2,605	
	DW-6012-S-30-WH	Single Face Starter	31 1/4"	12 1/8"	60"	10 1/2"	3	4			\$ 3,033	
	DW-6012-A-30-WH	Single Face Adder	30 1/4"	12 1/8"	60"	10 1/2"	3	4			\$ 2,651	
	DW-6014-S-30-WH	Single Face Starter	31 1/4"	14 5/8"	60"	13 1/2"	3	4			\$ 3,273	
	DW-6014-A-30-WH	Single Face Adder	30 1/4"	14 5/8"	60"	13 1/2"	3	4			\$ 2,846	
 <p>Model Shown DW-6012-A-36-WH</p>	DW-6010-S-36-WH	Single Face Starter	37 1/4"	10 1/8"	60"	8 1/2"	3	4	100 Lbs.	6 Cu Ft	\$ 2,799	
	DW-6010-A-36-WH	Single Face Adder	36 1/4"	10 1/8"	60"	8 1/2"	3	4	86.3 Lbs.	6 Cu Ft	\$ 2,425	
	DW-6012-S-36-WH	Single Face Starter	37 1/4"	12 1/8"	60"	10 1/2"	3	4	116 Lbs.	8 Cu Ft	\$ 2,853	
	DW-6012-A-36-WH	Single Face Adder	36 1/4"	12 1/8"	60"	10 1/2"	3	4	95.5 Lbs.	7 Cu Ft	\$ 2,463	
	DW-6014-S-36-WH	Single Face Starter	37 1/4"	14 5/8"	60"	13 1/2"	3	4	141 Lbs.	9 Cu Ft	\$ 3,085	
	DW-6014-A-36-WH	Single Face Adder	36 1/4"	14 5/8"	60"	13 1/2"	3	4	121 Lbs.	8 Cu Ft	\$ 2,666	



MODEL NUMBER	PRODUCT	WIDTH	DEPTH	HEIGHT	SHELF DEPTH	# OF SHELVES	# OF OPENINGS	WEIGHT	VOLUME	LIST PRICE	DESCRIPTION
	DW-7210-S-24-WH	25 1/4"	10 1/8"	72"	8 1/2"	4	5			\$ 3,085	End, Mid, Top and Base Panels to be constructed from 1" thick 11-ply solid core, veneered 2 sides. Vertical, top and bottom edges banded with 1/4" external hardwood edging, edges to be eased. Front Edge: 3/4" thick x 2 1/2" high fascia - tongue and grooved to top.
	DW-7210-A-24-WH	24 1/4"	10 1/8"	72"	8 1/2"	4	5			\$ 2,705	
	DW-7212-S-24-WH	25 1/4"	12 1/8"	72"	10 1/2"	4	5			\$ 3,157	
	DW-7212-A-24-WH	24 1/4"	12 1/8"	72"	10 1/2"	4	5			\$ 2,760	
	DW-7214-S-24-WH	25 1/4"	14 5/8"	72"	13 1/2"	4	5			\$ 3,389	
	DW-7214-A-24-WH	24 1/4"	14 5/8"	72"	13 1/2"	4	5			\$ 2,977	
	DW-7210-S-30-WH	31 1/4"	10 1/8"	72"	8 1/2"	4	5			\$ 3,085	
	DW-7210-A-30-WH	30 1/4"	10 1/8"	72"	8 1/2"	4	5			\$ 2,705	
	DW-7212-S-30-WH	31 1/4"	12 1/8"	72"	10 1/2"	4	5			\$ 3,157	
	DW-7212-A-30-WH	30 1/4"	12 1/8"	72"	10 1/2"	4	5			\$ 2,760	
	DW-7214-S-30-WH	31 1/4"	14 5/8"	72"	13 1/2"	4	5			\$ 3,389	
	DW-7214-A-30-WH	30 1/4"	14 5/8"	72"	13 1/2"	4	5			\$ 2,977	
	DW-7210-S-36-WH	37 1/4"	10 1/8"	72"	8 1/2"	4	5	115 Lbs.	7 Cu Ft	\$ 2,907	
	DW-7210-A-36-WH	36 1/4"	10 1/8"	72"	8 1/2"	4	5	96.6 Lbs.	7 Cu Ft	\$ 2,527	
	DW-7212-S-36-WH	37 1/4"	12 1/8"	72"	10 1/2"	4	5	131 Lbs.	8 Cu Ft	\$ 2,970	
	DW-7212-A-36-WH	36 1/4"	12 1/8"	72"	10 1/2"	4	5	109 Lbs.	8 Cu Ft	\$ 2,581	
	DW-7214-S-36-WH	37 1/4"	14 5/8"	72"	13 1/2"	4	5	159 Lbs.	10 Cu Ft	\$ 3,210	
	DW-7214-A-36-WH	36 1/4"	14 5/8"	72"	13 1/2"	4	5	132 Lbs.	9 Cu Ft	\$ 2,799	
	DW-8210-S-24-WH	25 1/4"	10 1/8"	82"	8 1/2"	5	6			\$ 3,195	
	DW-8210-A-24-WH	24 1/4"	10 1/8"	82"	8 1/2"	5	6			\$ 2,815	
	DW-8212-S-24-WH	25 1/4"	12 1/8"	82"	10 1/2"	5	6			\$ 3,265	
	DW-8212-A-24-WH	24 1/4"	12 1/8"	82"	10 1/2"	5	6			\$ 2,868	
	DW-8214-S-24-WH	25 1/4"	14 5/8"	82"	13 1/2"	5	6			\$ 3,475	
	DW-8214-A-24-WH	24 1/4"	14 5/8"	82"	13 1/2"	5	6			\$ 3,134	
	DW-8210-S-30-WH	31 1/4"	10 1/8"	82"	8 1/2"	5	6			\$ 3,195	
	DW-8210-A-30-WH	30 1/4"	10 1/8"	82"	8 1/2"	5	6			\$ 2,815	
	DW-8212-S-30-WH	31 1/4"	12 1/8"	82"	10 1/2"	5	6			\$ 3,265	
	DW-8212-A-30-WH	30 1/4"	12 1/8"	82"	10 1/2"	5	6			\$ 2,868	
	DW-8214-S-30-WH	31 1/4"	14 5/8"	82"	13 1/2"	5	6			\$ 3,475	
	DW-8214-A-30-WH	30 1/4"	14 5/8"	82"	13 1/2"	5	6			\$ 3,134	
	DW-8210-S-36-WH	37 1/4"	10 1/8"	82"	8 1/2"	5	6	129 Lbs.	8 Cu Ft	\$ 3,010	
	DW-8210-A-36-WH	36 1/4"	10 1/8"	82"	8 1/2"	5	6	107 Lbs.	7 Cu Ft	\$ 2,636	
	DW-8212-S-36-WH	37 1/4"	12 1/8"	82"	10 1/2"	5	6	145 Lbs.	9 Cu Ft	\$ 3,077	
	DW-8212-A-36-WH	36 1/4"	12 1/8"	82"	10 1/2"	5	6	122 Lbs.	8 Cu Ft	\$ 2,690	
	DW-8214-S-36-WH	37 1/4"	14 5/8"	82"	13 1/2"	5	6	175 Lbs.	11 Cu Ft	\$ 3,297	
	DW-8214-A-36-WH	36 1/4"	14 5/8"	82"	13 1/2"	5	6	143 Lbs.	10 Cu Ft	\$ 2,946	





MODEL NUMBER	PRODUCT	WIDTH	DEPTH	HEIGHT	SHELF DEPTH	# OF SHELVES	# OF OPENINGS	WEIGHT	VOLUME	LIST PRICE	DESCRIPTION
DW-9610-S-24-WH	Single Face Starter	25 <sup>1</sup> / <sub>4</sub> "	10 <sup>1</sup> / <sub>8</sub> "	96"	8 <sup>1</sup> / <sub>2</sub> "	6	7			\$ 3,288	End, Mid, Top and Base Panels to be constructed from 1" thick 11-ply solid core, veneered 2 sides. Vertical, top and bottom edges banded with 1/4" external hardwood edging, edges to be eased. Front Edge: 3/4" thick x 2 1/2" high fascia - tongue and grooved to top.
DW-9610-A-24-WH	Single Face Adder	24 <sup>1</sup> / <sub>4</sub> "	10 <sup>1</sup> / <sub>8</sub> "	96"	8 <sup>1</sup> / <sub>2</sub> "	6	7			\$ 2,915	
DW-9612-S-24-WH	Single Face Starter	25 <sup>1</sup> / <sub>4</sub> "	12 <sup>1</sup> / <sub>8</sub> "	96"	10 <sup>1</sup> / <sub>2</sub> "	6	7			\$ 3,382	
DW-9612-A-24-WH	Single Face Adder	24 <sup>1</sup> / <sub>4</sub> "	12 <sup>1</sup> / <sub>8</sub> "	96"	10 <sup>1</sup> / <sub>2</sub> "	6	7			\$ 2,985	
DW-9614-S-24-WH	Single Face Starter	25 <sup>1</sup> / <sub>4</sub> "	14 <sup>5</sup> / <sub>8</sub> "	96"	13 <sup>1</sup> / <sub>2</sub> "	6	7			\$ 3,700	
DW-9614-A-24-WH	Single Face Adder	24 <sup>1</sup> / <sub>4</sub> "	14 <sup>5</sup> / <sub>8</sub> "	96"	13 <sup>1</sup> / <sub>2</sub> "	6	7			\$ 3,241	
DW-9610-S-30-WH	Single Face Starter	31 <sup>1</sup> / <sub>4</sub> "	10 <sup>1</sup> / <sub>8</sub> "	96"	8 <sup>1</sup> / <sub>2</sub> "	6	7			\$ 3,288	
DW-9610-A-30-WH	Single Face Adder	30 <sup>1</sup> / <sub>4</sub> "	10 <sup>1</sup> / <sub>8</sub> "	96"	8 <sup>1</sup> / <sub>2</sub> "	6	7			\$ 2,915	
DW-9612-S-30-WH	Single Face Starter	31 <sup>1</sup> / <sub>4</sub> "	12 <sup>1</sup> / <sub>8</sub> "	96"	10 <sup>1</sup> / <sub>2</sub> "	6	7			\$ 3,382	
DW-9612-A-30-WH	Single Face Adder	30 <sup>1</sup> / <sub>4</sub> "	12 <sup>1</sup> / <sub>8</sub> "	96"	10 <sup>1</sup> / <sub>2</sub> "	6	7			\$ 2,985	
DW-9614-S-30-WH	Single Face Starter	31 <sup>1</sup> / <sub>4</sub> "	14 <sup>5</sup> / <sub>8</sub> "	96"	13 <sup>1</sup> / <sub>2</sub> "	6	7			\$ 3,700	
DW-9614-A-30-WH	Single Face Adder	30 <sup>1</sup> / <sub>4</sub> "	14 <sup>5</sup> / <sub>8</sub> "	96"	13 <sup>1</sup> / <sub>2</sub> "	6	7			\$ 3,241	
DW-9610-S-36-WH	Single Face Starter	37 <sup>1</sup> / <sub>4</sub> "	10 <sup>1</sup> / <sub>8</sub> "	96"	8 <sup>1</sup> / <sub>2</sub> "	6	7	156 Lbs.	9 Cu Ft	\$ 3,110	
DW-9610-A-36-WH	Single Face Adder	36 <sup>1</sup> / <sub>4</sub> "	10 <sup>1</sup> / <sub>8</sub> "	96"	8 <sup>1</sup> / <sub>2</sub> "	6	7	128 Lbs.	8 Cu Ft	\$ 2,736	
DW-9612-S-36-WH	Single Face Starter	37 <sup>1</sup> / <sub>4</sub> "	12 <sup>1</sup> / <sub>8</sub> "	96"	10 <sup>1</sup> / <sub>2</sub> "	6	7	177 Lbs.	10 Cu Ft	\$ 3,195	
DW-9612-A-36-WH	Single Face Adder	36 <sup>1</sup> / <sub>4</sub> "	12 <sup>1</sup> / <sub>8</sub> "	96"	10 <sup>1</sup> / <sub>2</sub> "	6	7	145 Lbs.	9 Cu Ft	\$ 2,799	
DW-9614-S-36-WH	Single Face Starter	37 <sup>1</sup> / <sub>4</sub> "	14 <sup>5</sup> / <sub>8</sub> "	96"	13 <sup>1</sup> / <sub>2</sub> "	6	7	213 Lbs.	12 Cu Ft	\$ 3,514	
DW-9614-A-36-WH	Single Face Adder	36 <sup>1</sup> / <sub>4</sub> "	14 <sup>5</sup> / <sub>8</sub> "	96"	13 <sup>1</sup> / <sub>2</sub> "	6	7	175 Lbs.	11 Cu Ft	\$ 3,056	













Model Shown  
DW-9612-S-36-WH



Model Shown  
DW-9612-A-36-WH

	MODEL NUMBER	PRODUCT	WIDTH	DEPTH	HEIGHT	SHELF DEPTH	# OF SHELVES	# OF OPENINGS	WEIGHT	VOLUME	LIST PRICE	DESCRIPTION
 <p>Model Shown DW-3624-S-36-WH</p>	DW-3620-S-24-WH	Double Face Starter	25 1/4"	19 1/2"	36"	8 1/2"	2	4			\$ 4,805	End, Mid, Top and Base Panels to be constructed from 1" thick 11-ply solid core, veneered 2 sides. Vertical, top and bottom edges banded with 1/4" external hardwood edging, edges to be eased. Front Edge: 3/4" thick x 2 1/2" high fascia - tongue and grooved to top.
	DW-3620-A-24-WH	Double Face Adder	24 1/4"	19 1/2"	36"	8 1/2"	2	4			\$ 4,158	
	DW-3624-S-24-WH	Double Face Starter	25 1/4"	23 1/2"	36"	10 1/2"	2	4			\$ 4,851	
	DW-3624-A-24-WH	Double Face Adder	24 1/4"	23 1/2"	36"	10 1/2"	2	4			\$ 4,175	
	DW-3628-S-24-WH	Double Face Starter	25 1/4"	28 1/2"	36"	13 1/2"	2	4			\$ 5,216	
	DW-3628-A-24-WH	Double Face Adder	24 1/4"	28 1/2"	36"	13 1/2"	2	4			\$ 4,477	
 <p>Model Shown DW-3624-A-36-WH</p>	DW-3620-S-30-WH	Double Face Starter	31 1/4"	19 1/2"	36"	8 1/2"	2	4			\$ 4,805	
	DW-3620-A-30-WH	Double Face Adder	30 1/4"	19 1/2"	36"	8 1/2"	2	4			\$ 4,158	
	DW-3624-S-30-WH	Double Face Starter	31 1/4"	23 1/2"	36"	10 1/2"	2	4			\$ 4,851	
	DW-3624-A-30-WH	Double Face Adder	30 1/4"	23 1/2"	36"	10 1/2"	2	4			\$ 4,175	
	DW-3628-S-30-WH	Double Face Starter	31 1/4"	28 1/2"	36"	13 1/2"	2	4			\$ 5,216	
	DW-3628-A-30-WH	Double Face Adder	30 1/4"	28 1/2"	36"	13 1/2"	2	4			\$ 4,477	
	DW-3620-S-36-WH	Double Face Starter	37 1/4"	19 1/2"	36"	8 1/2"	2	4	88.6 Lbs.	7 Cu Ft	\$ 4,532	
	DW-3620-A-36-WH	Double Face Adder	36 1/4"	19 1/2"	36"	8 1/2"	2	4	73.6 Lbs.	6 Cu Ft	\$ 3,880	
	DW-3624-S-36-WH	Double Face Starter	37 1/4"	23 1/2"	36"	10 1/2"	2	4	110 Lbs.	10 Cu Ft	\$ 4,578	
	DW-3624-A-36-WH	Double Face Adder	36 1/4"	23 1/2"	36"	10 1/2"	2	4	88.6 Lbs.	9 Cu Ft	\$ 3,903	
	DW-3628-S-36-WH	Double Face Starter	37 1/4"	28 1/2"	36"	13 1/2"	2	4	132 Lbs.	11 Cu Ft	\$ 4,936	
	DW-3628-A-36-WH	Double Face Adder	36 1/4"	28 1/2"	36"	13 1/2"	2	4	104 Lbs.	10 Cu Ft	\$ 4,198	
 <p>Model Shown DW-4224-S-36-WH</p>	DW-4220-S-24-WH	Double Face Starter	25 1/4"	19 1/2"	42"	8 1/2"	4	6			\$ 5,022	
	DW-4220-A-24-WH	Double Face Adder	24 1/4"	19 1/2"	42"	8 1/2"	4	6			\$ 4,377	
	DW-4224-S-24-WH	Double Face Starter	25 1/4"	23 1/2"	42"	10 1/2"	4	6			\$ 5,085	
	DW-4224-A-24-WH	Double Face Adder	24 1/4"	23 1/2"	42"	10 1/2"	4	6			\$ 4,408	
	DW-4228-S-24-WH	Double Face Starter	25 1/4"	28 1/2"	42"	13 1/2"	4	6			\$ 5,511	
	DW-4228-A-24-WH	Double Face Adder	24 1/4"	28 1/2"	42"	13 1/2"	4	6			\$ 4,781	
 <p>Model Shown DW-4224-A-36-WH</p>	DW-4220-S-30-WH	Double Face Starter	31 1/4"	19 1/2"	42"	8 1/2"	4	6			\$ 5,022	
	DW-4220-A-30-WH	Double Face Adder	30 1/4"	19 1/2"	42"	8 1/2"	4	6			\$ 4,377	
	DW-4224-S-30-WH	Double Face Starter	31 1/4"	23 1/2"	42"	10 1/2"	4	6			\$ 5,085	
	DW-4224-A-30-WH	Double Face Adder	30 1/4"	23 1/2"	42"	10 1/2"	4	6			\$ 4,408	
	DW-4228-S-30-WH	Double Face Starter	31 1/4"	28 1/2"	42"	13 1/2"	4	6			\$ 5,511	
	DW-4228-A-30-WH	Double Face Adder	30 1/4"	28 1/2"	42"	13 1/2"	4	6			\$ 4,781	
	DW-4220-S-36-WH	Double Face Starter	37 1/4"	19 1/2"	42"	8 1/2"	4	6	94 Lbs.	7 Cu Ft	\$ 4,751	
	DW-4220-A-36-WH	Double Face Adder	36 1/4"	19 1/2"	42"	8 1/2"	4	6	78 Lbs.	7 Cu Ft	\$ 4,097	
	DW-4224-S-36-WH	Double Face Starter	37 1/4"	23 1/2"	42"	10 1/2"	4	6	115 Lbs.	10 Cu Ft	\$ 4,805	
	DW-4224-A-36-WH	Double Face Adder	36 1/4"	23 1/2"	42"	10 1/2"	4	6	113 Lbs.	10 Cu Ft	\$ 4,129	
	DW-4228-S-36-WH	Double Face Starter	37 1/4"	28 1/2"	42"	13 1/2"	4	6	183 Lbs.	13 Cu Ft	\$ 5,239	
	DW-4228-A-36-WH	Double Face Adder	36 1/4"	28 1/2"	42"	13 1/2"	4	6	109 Lbs.	13 Cu Ft	\$ 4,501	

	MODEL NUMBER	PRODUCT	WIDTH	DEPTH	HEIGHT	SHELF DEPTH	# OF SHELVES	# OF OPENINGS	WEIGHT	VOLUME	LIST PRICE	DESCRIPTION
 <p>Model Shown DW-4224-S-36-WH</p>	DW-4820-S-24-WH	Double Face Starter	25 1/4"	19 1/2"	48"	8 1/2"	4	6			\$ 5,115	End, Mid, Top and Base Panels to be constructed from 1" thick 11-ply solid core, veneered 2 sides. Vertical, top and bottom edges banded with 1/4" external hardwood edging, edges to be eased. Front Edge: 3/4" thick x 2 1/2" high fascia - tongue and grooved to top.
	DW-4820-A-24-WH	Double Face Adder	24 1/4"	19 1/2"	48"	8 1/2"	4	6			\$ 4,439	
	DW-4824-S-24-WH	Double Face Starter	25 1/4"	23 1/2"	48"	10 1/2"	4	6			\$ 5,177	
	DW-4824-A-24-WH	Double Face Adder	24 1/4"	23 1/2"	48"	10 1/2"	4	6			\$ 4,470	
	DW-4828-S-24-WH	Double Face Starter	25 1/4"	28 1/2"	48"	13 1/2"	4	6			\$ 5,628	
	DW-4828-A-24-WH	Double Face Adder	24 1/4"	28 1/2"	48"	13 1/2"	4	6			\$ 4,858	
 <p>Model Shown DW-4224-A-36-WH</p>	DW-4820-S-30-WH	Double Face Starter	31 1/4"	19 1/2"	48"	8 1/2"	4	6			\$ 5,115	
	DW-4820-A-30-WH	Double Face Adder	30 1/4"	19 1/2"	48"	8 1/2"	4	6			\$ 4,439	
	DW-4824-S-30-WH	Double Face Starter	31 1/4"	23 1/2"	48"	10 1/2"	4	6			\$ 5,177	
	DW-4824-A-30-WH	Double Face Adder	30 1/4"	23 1/2"	48"	10 1/2"	4	6			\$ 4,470	
	DW-4828-S-30-WH	Double Face Starter	31 1/4"	28 1/2"	48"	13 1/2"	4	6			\$ 5,628	
	DW-4828-A-30-WH	Double Face Adder	30 1/4"	28 1/2"	48"	13 1/2"	4	6			\$ 4,858	
	DW-4820-S-36-WH	Double Face Starter	37 1/4"	19 1/2"	48"	8 1/2"	4	6	132 Lbs.	9 Cu Ft	\$ 4,836	
	DW-4820-A-36-WH	Double Face Adder	36 1/4"	19 1/2"	48"	8 1/2"	4	6	109 Lbs.	8 Cu Ft	\$ 4,168	
	DW-4824-S-36-WH	Double Face Starter	37 1/4"	23 1/2"	48"	10 1/2"	4	6	155 Lbs.	11 Cu Ft	\$ 4,898	
	DW-4824-A-36-WH	Double Face Adder	36 1/4"	23 1/2"	48"	10 1/2"	4	6	127 Lbs.	10 Cu Ft	\$ 4,198	
	DW-4828-S-36-WH	Double Face Starter	37 1/4"	28 1/2"	48"	13 1/2"	4	6	178 Lbs.	13 Cu Ft	\$ 5,356	
	DW-4828-A-36-WH	Double Face Adder	36 1/4"	28 1/2"	48"	13 1/2"	4	6	144 Lbs.	12 Cu Ft	\$ 4,587	
 <p>Model Shown DW-6024-S-36-WH</p>	DW-6020-S-24-WH	Double Face Starter	25 1/4"	19 1/2"	60"	8 1/2"	6	8			\$ 5,621	
	DW-6020-A-24-WH	Double Face Adder	24 1/4"	19 1/2"	60"	8 1/2"	6	8			\$ 4,951	
	DW-6024-S-24-WH	Double Face Starter	25 1/4"	23 1/2"	60"	10 1/2"	6	8			\$ 5,675	
	DW-6024-A-24-WH	Double Face Adder	24 1/4"	23 1/2"	60"	10 1/2"	6	8			\$ 5,006	
	DW-6028-S-24-WH	Double Face Starter	25 1/4"	28 1/2"	60"	13 1/2"	6	8			\$ 6,187	
	DW-6028-A-24-WH	Double Face Adder	24 1/4"	28 1/2"	60"	13 1/2"	6	8			\$ 5,427	
 <p>Model Shown DW-6024-A-36-WH</p>	DW-6020-S-30-WH	Double Face Starter	31 1/4"	19 1/2"	60"	8 1/2"	6	8			\$ 5,621	
	DW-6020-A-30-WH	Double Face Adder	30 1/4"	19 1/2"	60"	8 1/2"	6	8			\$ 4,951	
	DW-6024-S-30-WH	Double Face Starter	31 1/4"	23 1/2"	60"	10 1/2"	6	8			\$ 5,675	
	DW-6024-A-30-WH	Double Face Adder	30 1/4"	23 1/2"	60"	10 1/2"	6	8			\$ 5,006	
	DW-6028-S-30-WH	Double Face Starter	31 1/4"	28 1/2"	60"	13 1/2"	6	8			\$ 6,187	
	DW-6028-A-30-WH	Double Face Adder	30 1/4"	28 1/2"	60"	13 1/2"	6	8			\$ 5,427	
	DW-6020-S-36-WH	Double Face Starter	37 1/4"	19 1/2"	60"	8 1/2"	6	8	176 Lbs.	11 Cu Ft	\$ 5,341	
	DW-6020-A-36-WH	Double Face Adder	36 1/4"	19 1/2"	60"	8 1/2"	6	8	145 Lbs.	10 Cu Ft	\$ 4,671	
	DW-6024-S-36-WH	Double Face Starter	37 1/4"	23 1/2"	60"	10 1/2"	6	8	200 Lbs.	12 Cu Ft	\$ 5,403	
	DW-6024-A-36-WH	Double Face Adder	36 1/4"	23 1/2"	60"	10 1/2"	6	8	164 Lbs.	11 Cu Ft	\$ 4,727	
	DW-6028-S-36-WH	Double Face Starter	37 1/4"	28 1/2"	60"	13 1/2"	6	8	224 Lbs.	13 Cu Ft	\$ 5,909	
	DW-6028-A-36-WH	Double Face Adder	36 1/4"	28 1/2"	60"	13 1/2"	6	8	184 Lbs.	12 Cu Ft	\$ 5,146	

MODEL NUMBER	PRODUCT	WIDTH	DEPTH	HEIGHT	SHELF DEPTH	# OF SHELVES	# OF OPENINGS	WEIGHT	VOLUME	LIST PRICE	DESCRIPTION
 Model Shown DW-7224-S-36-WH	DW-7220-S-24-WH	Double Face Starter	25 1/4"	19 1/2"	72"	8 1/2"	8			\$ 5,839	End, Mid, Top and Base Panels to be constructed from 1" thick 11-ply solid core, veneered 2 sides. Vertical, top and bottom edges banded with 1/4" external hardwood edging, edges to be eased. Front Edge: 3/4" thick x 2 1/2" high fascia - tongue and grooved to top.
	DW-7220-A-24-WH	Double Face Adder	24 1/4"	19 1/2"	72"	8 1/2"	8			\$ 5,153	
	DW-7224-S-24-WH	Double Face Starter	25 1/4"	23 1/2"	72"	10 1/2"	8			\$ 5,899	
	DW-7224-A-24-WH	Double Face Adder	24 1/4"	23 1/2"	72"	10 1/2"	8			\$ 5,216	
	DW-7228-S-24-WH	Double Face Starter	25 1/4"	28 1/2"	72"	13 1/2"	8			\$ 6,428	
	DW-7228-A-24-WH	Double Face Adder	24 1/4"	28 1/2"	72"	13 1/2"	8			\$ 5,675	
 Model Shown DW-7224-A-36-WH	DW-7220-S-30-WH	Double Face Starter	31 1/4"	19 1/2"	72"	8 1/2"	8			\$ 5,839	
	DW-7220-A-30-WH	Double Face Adder	30 1/4"	19 1/2"	72"	8 1/2"	8			\$ 5,153	
	DW-7224-S-30-WH	Double Face Starter	31 1/4"	23 1/2"	72"	10 1/2"	8			\$ 5,899	
	DW-7224-A-30-WH	Double Face Adder	30 1/4"	23 1/2"	72"	10 1/2"	8			\$ 5,216	
	DW-7228-S-30-WH	Double Face Starter	31 1/4"	28 1/2"	72"	13 1/2"	8			\$ 6,428	
	DW-7228-A-30-WH	Double Face Adder	30 1/4"	28 1/2"	72"	13 1/2"	8			\$ 5,675	
 Model Shown DW-7224-A-36-WH	DW-7220-S-36-WH	Double Face Starter	37 1/4"	19 1/2"	72"	8 1/2"	8			\$ 5,558	
	DW-7220-A-36-WH	Double Face Adder	36 1/4"	19 1/2"	72"	8 1/2"	8	200 Lbs.	12 Cu Ft	\$ 4,882	
	DW-7224-S-36-WH	Double Face Starter	37 1/4"	23 1/2"	72"	10 1/2"	8	229 Lbs.	13 Cu Ft	\$ 5,621	
	DW-7224-A-36-WH	Double Face Adder	36 1/4"	23 1/2"	72"	10 1/2"	8	186 Lbs.	12 Cu Ft	\$ 4,944	
	DW-7228-S-36-WH	Double Face Starter	37 1/4"	28 1/2"	72"	13 1/2"	8	256 Lbs.	14 Cu Ft	\$ 6,149	
	DW-7228-A-36-WH	Double Face Adder	36 1/4"	28 1/2"	72"	13 1/2"	8	207 Lbs.	13 Cu Ft	\$ 5,403	
 Model Shown DW-8224-S-36-WH	DW-8220-S-24-WH	Double Face Starter	25 1/4"	19 1/2"	82"	8 1/2"	10			\$ 6,033	
	DW-8220-A-24-WH	Double Face Adder	24 1/4"	19 1/2"	82"	8 1/2"	10			\$ 5,364	
	DW-8224-S-24-WH	Double Face Starter	25 1/4"	23 1/2"	82"	10 1/2"	10			\$ 6,118	
	DW-8224-A-24-WH	Double Face Adder	24 1/4"	23 1/2"	82"	10 1/2"	10			\$ 5,449	
	DW-8228-S-24-WH	Double Face Starter	25 1/4"	28 1/2"	82"	13 1/2"	10			\$ 7,012	
	DW-8228-A-24-WH	Double Face Adder	24 1/4"	28 1/2"	82"	13 1/2"	10			\$ 6,087	
 Model Shown DW-8224-A-36-WH	DW-8220-S-30-WH	Double Face Starter	31 1/4"	19 1/2"	82"	8 1/2"	10			\$ 6,033	
	DW-8220-A-30-WH	Double Face Adder	30 1/4"	19 1/2"	82"	8 1/2"	10			\$ 5,364	
	DW-8224-S-30-WH	Double Face Starter	31 1/4"	23 1/2"	82"	10 1/2"	10			\$ 6,118	
	DW-8224-A-30-WH	Double Face Adder	30 1/4"	23 1/2"	82"	10 1/2"	10			\$ 5,449	
	DW-8228-S-30-WH	Double Face Starter	31 1/4"	28 1/2"	82"	13 1/2"	10			\$ 7,012	
	DW-8228-A-30-WH	Double Face Adder	30 1/4"	28 1/2"	82"	13 1/2"	10			\$ 6,087	
 Model Shown DW-8224-A-36-WH	DW-8220-S-36-WH	Double Face Starter	37 1/4"	19 1/2"	82"	8 1/2"	10	224 Lbs.	12 Cu Ft	\$ 5,760	
	DW-8220-A-36-WH	Double Face Adder	36 1/4"	19 1/2"	82"	8 1/2"	10	184 Lbs.	11 Cu Ft	\$ 5,085	
	DW-8224-S-36-WH	Double Face Starter	37 1/4"	23 1/2"	82"	10 1/2"	10	256 Lbs.	14 Cu Ft	\$ 5,839	
	DW-8224-A-36-WH	Double Face Adder	36 1/4"	23 1/2"	82"	10 1/2"	10	207 Lbs.	12 Cu Ft	\$ 5,169	
	DW-8228-S-36-WH	Double Face Starter	37 1/4"	28 1/2"	82"	13 1/2"	10	289 Lbs.	16 Cu Ft	\$ 6,732	
	DW-8228-A-36-WH	Double Face Adder	36 1/4"	28 1/2"	82"	13 1/2"	10	230 Lbs.	14 Cu Ft	\$ 5,806	









MODEL NUMBER	PRODUCT	WIDTH	DEPTH	HEIGHT	SHELF DEPTH	# OF SHELVES	# OF OPENINGS	WEIGHT	VOLUME	LIST PRICE	DESCRIPTION
DW-9620-S-24-WH	Double Face Starter	25 1/4"	19 1/2"	96"	8 1/2"	12	14			\$ 6,250	End, Mid, Top and Base Panels to be constructed from 1" thick 11-ply solid core, veneered 2 sides. Vertical, top and bottom edges banded with 1/4" external hardwood edging, edges to be eased. Front Edge: 3/4" thick x 2 1/2" high fascia - tongue and grooved to top.
DW-9620-A-24-WH	Double Face Adder	24 1/4"	19 1/2"	96"	8 1/2"	12	14			\$ 5,573	
DW-9624-S-24-WH	Double Face Starter	25 1/4"	23 1/2"	96"	10 1/2"	12	14			\$ 6,335	
DW-9624-A-24-WH	Double Face Adder	24 1/4"	23 1/2"	96"	10 1/2"	12	14			\$ 5,667	
DW-9628-S-24-WH	Double Face Starter	25 1/4"	28 1/2"	96"	13 1/2"	12	14			\$ 7,252	
DW-9628-A-24-WH	Double Face Adder	24 1/4"	28 1/2"	96"	13 1/2"	12	14			\$ 6,343	
DW-9620-S-30-WH	Double Face Starter	31 1/4"	19 1/2"	96"	8 1/2"	12	14			\$ 6,250	
DW-9620-A-30-WH	Double Face Adder	30 1/4"	19 1/2"	96"	8 1/2"	12	14			\$ 5,573	
DW-9624-S-30-WH	Double Face Starter	31 1/4"	23 1/2"	96"	10 1/2"	12	14			\$ 6,335	
DW-9624-A-30-WH	Double Face Adder	30 1/4"	23 1/2"	96"	10 1/2"	12	14			\$ 5,667	
DW-9628-S-30-WH	Double Face Starter	31 1/4"	28 1/2"	96"	13 1/2"	12	14			\$ 7,252	
DW-9628-A-30-WH	Double Face Adder	30 1/4"	28 1/2"	96"	13 1/2"	12	14			\$ 6,343	
DW-9620-S-36-WH	Double Face Starter	37 1/4"	19 1/2"	96"	8 1/2"	12	14	276 Lbs.	13 Cu Ft	\$ 5,970	
DW-9620-A-36-WH	Double Face Adder	36 1/4"	19 1/2"	96"	8 1/2"	12	14	220 Lbs.	12 Cu Ft	\$ 5,293	
DW-9624-S-36-WH	Double Face Starter	37 1/4"	23 1/2"	96"	10 1/2"	12	14	315 Lbs.	15 Cu Ft	\$ 6,063	
DW-9624-A-36-WH	Double Face Adder	36 1/4"	23 1/2"	96"	10 1/2"	12	14	247 Lbs.	13 Cu Ft	\$ 5,395	
DW-9628-S-36-WH	Double Face Starter	37 1/4"	28 1/2"	96"	13 1/2"	12	14	353 Lbs.	17 Cu Ft	\$ 6,980	
DW-9628-A-36-WH	Double Face Adder	36 1/4"	28 1/2"	96"	13 1/2"	12	14	275 Lbs.	15 Cu Ft	\$ 6,070	











Model Shown  
DW-9624-S-36-WH



Model Shown  
DW-9624-A-36-WH

MODEL NUMBER	PRODUCT	WIDTH	DEPTH	HEIGHT	SHELF DEPTH	# OF SHELVES	# OF OPENINGS	WEIGHT	VOLUME	LIST PRICE	DESCRIPTION
 Model Shown DW-3612-S-36-SG	DW-3610-S-24-SG	Single Face Starter	25 1/4"	10 1/8"	36"	8 1/2"	1			\$ 2,387	End, Mid, Top and Base Panels to be constructed from 1" thick 11-ply solid core, veneered 2 sides. Vertical, top and bottom edges banded with 1/4" external hardwood edging, edges to be eased. Front Edge: 3/4" thick x 2 1/2" high fascia - tongue and grooved to top.
	DW-3610-A-24-SG	Single Face Adder	24 1/4"	10 1/8"	36"	8 1/2"	1			\$ 2,037	
	DW-3612-S-24-SG	Single Face Starter	25 1/4"	12 1/8"	36"	10 1/2"	1			\$ 2,433	
	DW-3612-A-24-SG	Single Face Adder	24 1/4"	12 1/8"	36"	10 1/2"	1			\$ 2,069	
	DW-3614-S-24-SG	Single Face Starter	25 1/4"	14 5/8"	36"	13 1/2"	1			\$ 2,588	
	DW-3614-A-24-SG	Single Face Adder	24 1/4"	14 5/8"	36"	13 1/2"	1			\$ 2,184	
 Model Shown DW-3612-A-36-SG	DW-3610-S-30-SG	Single Face Starter	31 1/4"	10 1/8"	36"	8 1/2"	1			\$ 2,387	
	DW-3610-A-30-SG	Single Face Adder	30 1/4"	10 1/8"	36"	8 1/2"	1			\$ 2,037	
	DW-3612-S-30-SG	Single Face Starter	31 1/4"	12 1/8"	36"	10 1/2"	1			\$ 2,433	
	DW-3612-A-30-SG	Single Face Adder	30 1/4"	12 1/8"	36"	10 1/2"	1			\$ 2,069	
	DW-3614-S-30-SG	Single Face Starter	31 1/4"	14 5/8"	36"	13 1/2"	1			\$ 2,588	
	DW-3614-A-30-SG	Single Face Adder	30 1/4"	14 5/8"	36"	13 1/2"	1			\$ 2,184	
 Model Shown DW-4212-S-36-SG	DW-3610-S-36-SG	Single Face Starter	37 1/4"	10 1/8"	36"	8 1/2"	1			\$ 2,215	
	DW-3610-A-36-SG	Single Face Adder	36 1/4"	10 1/8"	36"	8 1/2"	1	50.6 Lbs.	4 Cu Ft	\$ 1,858	
	DW-3612-S-36-SG	Single Face Starter	37 1/4"	12 1/8"	36"	10 1/2"	1	46 Lbs.	4 Cu Ft	\$ 2,263	
	DW-3612-A-36-SG	Single Face Adder	36 1/4"	12 1/8"	36"	10 1/2"	1	50.6 Lbs.	5 Cu Ft	\$ 1,889	
	DW-3614-S-36-SG	Single Face Starter	37 1/4"	14 5/8"	36"	13 1/2"	1	47.2 Lbs.	5 Cu Ft	\$ 2,417	
	DW-3614-A-36-SG	Single Face Adder	36 1/4"	14 5/8"	36"	13 1/2"	1	74.8 Lbs.	6 Cu Ft	\$ 2,014	
 Model Shown DW-4212-A-36-SG	DW-4210-S-24-SG	Single Face Starter	25 1/4"	10 1/8"	42"	8 1/2"	2			\$ 2,487	
	DW-4210-A-24-SG	Single Face Adder	24 1/4"	10 1/8"	42"	8 1/2"	2			\$ 2,139	
	DW-4212-S-24-SG	Single Face Starter	25 1/4"	12 1/8"	42"	10 1/2"	2			\$ 2,542	
	DW-4212-A-24-SG	Single Face Adder	24 1/4"	12 1/8"	42"	10 1/2"	2			\$ 2,169	
	DW-4214-S-24-SG	Single Face Starter	25 1/4"	14 5/8"	42"	13 1/2"	2			\$ 2,729	
	DW-4214-A-24-SG	Single Face Adder	24 1/4"	14 5/8"	42"	13 1/2"	2			\$ 2,324	
 Model Shown DW-4212-A-36-SG	DW-4210-S-30-SG	Single Face Starter	31 1/4"	10 1/8"	42"	8 1/2"	2			\$ 2,487	
	DW-4210-A-30-SG	Single Face Adder	30 1/4"	10 1/8"	42"	8 1/2"	2			\$ 2,139	
	DW-4212-S-30-SG	Single Face Starter	31 1/4"	12 1/8"	42"	10 1/2"	2			\$ 2,542	
	DW-4212-A-30-SG	Single Face Adder	30 1/4"	12 1/8"	42"	10 1/2"	2			\$ 2,169	
	DW-4214-S-30-SG	Single Face Starter	31 1/4"	14 5/8"	42"	13 1/2"	2			\$ 2,729	
	DW-4214-A-30-SG	Single Face Adder	30 1/4"	14 5/8"	42"	13 1/2"	2			\$ 2,324	
 Model Shown DW-4212-A-36-SG	DW-4210-S-36-SG	Single Face Starter	37 1/4"	10 1/8"	42"	8 1/2"	2			\$ 2,317	
	DW-4210-A-36-SG	Single Face Adder	36 1/4"	10 1/8"	42"	8 1/2"	2	55 Lbs.	5 Cu Ft	\$ 1,965	
	DW-4212-S-36-SG	Single Face Starter	37 1/4"	12 1/8"	42"	10 1/2"	2	52 Lbs.	5 Cu Ft	\$ 2,370	
	DW-4212-A-36-SG	Single Face Adder	36 1/4"	12 1/8"	42"	10 1/2"	2	60 Lbs.	5 Cu Ft	\$ 1,998	
	DW-4214-S-36-SG	Single Face Starter	37 1/4"	14 5/8"	42"	13 1/2"	2	53 Lbs.	5 Cu Ft	\$ 2,558	
	DW-4214-A-36-SG	Single Face Adder	36 1/4"	14 5/8"	42"	13 1/2"	2	79 Lbs.	6 Cu Ft	\$ 2,153	

	MODEL NUMBER	PRODUCT	WIDTH	DEPTH	HEIGHT	SHELF DEPTH	# OF SHELVES	# OF OPENINGS	WEIGHT	VOLUME	LIST PRICE	DESCRIPTION
 <p>Model Shown DW-4212-S-36-SG</p>	DW-4810-S-24-SG	Single Face Starter	25 1/4"	10 1/8"	48"	8 1/2"	2	3			\$ 2,558	End, Mid, Top and Base Panels to be constructed from 1" thick 11-ply solid core, veneered 2 sides. Vertical, top and bottom edges banded with 1/4" external hardwood edging, edges to be eased. Front Edge: 3/4" thick x 2 1/2" high fascia - tongue and grooved to top.
	DW-4810-A-24-SG	Single Face Adder	24 1/4"	10 1/8"	48"	8 1/2"	2	3			\$ 2,193	
	DW-4812-S-24-SG	Single Face Starter	25 1/4"	12 1/8"	48"	10 1/2"	2	3			\$ 2,581	
	DW-4812-A-24-SG	Single Face Adder	24 1/4"	12 1/8"	48"	10 1/2"	2	3			\$ 2,193	
	DW-4814-S-24-SG	Single Face Starter	25 1/4"	14 5/8"	48"	13 1/2"	2	3			\$ 2,768	
	DW-4814-A-24-SG	Single Face Adder	24 1/4"	14 5/8"	48"	13 1/2"	2	3			\$ 2,356	
 <p>Model Shown DW-4212-A-36-SG</p>	DW-4810-S-30-SG	Single Face Starter	31 1/4"	10 1/8"	48"	8 1/2"	2	3			\$ 2,558	
	DW-4810-A-30-SG	Single Face Adder	30 1/4"	10 1/8"	48"	8 1/2"	2	3			\$ 2,193	
	DW-4812-S-30-SG	Single Face Starter	31 1/4"	12 1/8"	48"	10 1/2"	2	3			\$ 2,581	
	DW-4812-A-30-SG	Single Face Adder	30 1/4"	12 1/8"	48"	10 1/2"	2	3			\$ 2,193	
	DW-4814-S-30-SG	Single Face Starter	31 1/4"	14 5/8"	48"	13 1/2"	2	3			\$ 2,768	
	DW-4814-A-30-SG	Single Face Adder	30 1/4"	14 5/8"	48"	13 1/2"	2	3			\$ 2,356	
	DW-4810-S-36-SG	Single Face Starter	37 1/4"	10 1/8"	48"	8 1/2"	2	3	74.8 Lbs.	5 Cu Ft	\$ 2,387	
	DW-4810-A-36-SG	Single Face Adder	36 1/4"	10 1/8"	48"	8 1/2"	2	3	65.5 Lbs.	5 Cu Ft	\$ 2,014	
	DW-4812-S-36-SG	Single Face Starter	37 1/4"	12 1/8"	48"	10 1/2"	2	3	82.8 Lbs.	6 Cu Ft	\$ 2,401	
	DW-4812-A-36-SG	Single Face Adder	36 1/4"	12 1/8"	48"	10 1/2"	2	3	71.3 Lbs.	6 Cu Ft	\$ 2,022	
	DW-4814-S-36-SG	Single Face Starter	37 1/4"	14 5/8"	48"	13 1/2"	2	3	108 Lbs.	7 Cu Ft	\$ 2,598	
	DW-4814-A-36-SG	Single Face Adder	36 1/4"	14 5/8"	48"	13 1/2"	2	3	92 Lbs.	7 Cu Ft	\$ 2,184	
 <p>Model Shown DW-6012-S-36-SG</p>	DW-6010-S-24-SG	Single Face Starter	25 1/4"	10 1/8"	60"	8 1/2"	3	4			\$ 3,258	
	DW-6010-A-24-SG	Single Face Adder	24 1/4"	10 1/8"	60"	8 1/2"	3	4			\$ 2,899	
	DW-6012-S-24-SG	Single Face Starter	25 1/4"	12 1/8"	60"	10 1/2"	3	4			\$ 3,312	
	DW-6012-A-24-SG	Single Face Adder	24 1/4"	12 1/8"	60"	10 1/2"	3	4			\$ 2,939	
	DW-6014-S-24-SG	Single Face Starter	25 1/4"	14 5/8"	60"	13 1/2"	3	4			\$ 3,536	
	DW-6014-A-24-SG	Single Face Adder	24 1/4"	14 5/8"	60"	13 1/2"	3	4			\$ 3,134	
 <p>Model Shown DW-6012-A-36-SG</p>	DW-6010-S-30-SG	Single Face Starter	31 1/4"	10 1/8"	60"	8 1/2"	3	4			\$ 3,258	
	DW-6010-A-30-SG	Single Face Adder	30 1/4"	10 1/8"	60"	8 1/2"	3	4			\$ 2,899	
	DW-6012-S-30-SG	Single Face Starter	31 1/4"	12 1/8"	60"	10 1/2"	3	4			\$ 3,312	
	DW-6012-A-30-SG	Single Face Adder	30 1/4"	12 1/8"	60"	10 1/2"	3	4			\$ 2,939	
	DW-6014-S-30-SG	Single Face Starter	31 1/4"	14 5/8"	60"	13 1/2"	3	4			\$ 3,536	
	DW-6014-A-30-SG	Single Face Adder	30 1/4"	14 5/8"	60"	13 1/2"	3	4			\$ 3,134	
	DW-6010-S-36-SG	Single Face Starter	37 1/4"	10 1/8"	60"	8 1/2"	3	4	100 Lbs.	6 Cu Ft	\$ 3,085	
	DW-6010-A-36-SG	Single Face Adder	36 1/4"	10 1/8"	60"	8 1/2"	3	4	86.3 Lbs.	6 Cu Ft	\$ 2,729	
	DW-6012-S-36-SG	Single Face Starter	37 1/4"	12 1/8"	60"	10 1/2"	3	4	116 Lbs.	8 Cu Ft	\$ 3,134	
	DW-6012-A-36-SG	Single Face Adder	36 1/4"	12 1/8"	60"	10 1/2"	3	4	95.5 Lbs.	7 Cu Ft	\$ 2,768	
	DW-6014-S-36-SG	Single Face Starter	37 1/4"	14 5/8"	60"	13 1/2"	3	4	141 Lbs.	9 Cu Ft	\$ 3,358	
	DW-6014-A-36-SG	Single Face Adder	36 1/4"	14 5/8"	60"	13 1/2"	3	4	121 Lbs.	8 Cu Ft	\$ 2,953	

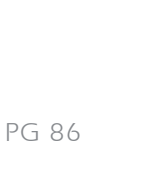
MODEL NUMBER	PRODUCT	WIDTH	DEPTH	HEIGHT	SHELF DEPTH	# OF SHELVES	# OF OPENINGS	WEIGHT	VOLUME	LIST PRICE	DESCRIPTION
 Model Shown DW-7212-S-36-SG	DW-7210-S-24-SG	Single Face Starter	25 1/4"	10 1/8"	72"	8 1/2"	4			\$ 3,358	End, Mid, Top and Base Panels to be constructed from 1" thick 11-ply solid core, veneered 2 sides. Vertical, top and bottom edges banded with 1/4" external hardwood edging, edges to be eased. Front Edge: 3/4" thick x 2 1/2" high fascia - tongue and grooved to top.
	DW-7210-A-24-SG	Single Face Adder	24 1/4"	10 1/8"	72"	8 1/2"	4			\$ 3,000	
	DW-7212-S-24-SG	Single Face Starter	25 1/4"	12 1/8"	72"	10 1/2"	4			\$ 3,421	
	DW-7212-A-24-SG	Single Face Adder	24 1/4"	12 1/8"	72"	10 1/2"	4			\$ 3,047	
	DW-7214-S-24-SG	Single Face Starter	25 1/4"	14 5/8"	72"	13 1/2"	4			\$ 3,645	
	DW-7214-A-24-SG	Single Face Adder	24 1/4"	14 5/8"	72"	13 1/2"	4			\$ 3,258	
 Model Shown DW-7212-A-36-SG	DW-7210-S-30-SG	Single Face Starter	31 1/4"	10 1/8"	72"	8 1/2"	4			\$ 3,358	
	DW-7210-A-30-SG	Single Face Adder	30 1/4"	10 1/8"	72"	8 1/2"	4			\$ 3,000	
	DW-7212-S-30-SG	Single Face Starter	31 1/4"	12 1/8"	72"	10 1/2"	4			\$ 3,421	
	DW-7212-A-30-SG	Single Face Adder	30 1/4"	12 1/8"	72"	10 1/2"	4			\$ 3,047	
	DW-7214-S-30-SG	Single Face Starter	31 1/4"	14 5/8"	72"	13 1/2"	4			\$ 3,645	
	DW-7214-A-30-SG	Single Face Adder	30 1/4"	14 5/8"	72"	13 1/2"	4			\$ 3,258	
 Model Shown DW-7212-A-36-SG	DW-7210-S-36-SG	Single Face Starter	37 1/4"	10 1/8"	72"	8 1/2"	4	115 Lbs.	7 Cu Ft	\$ 3,188	
	DW-7210-A-36-SG	Single Face Adder	36 1/4"	10 1/8"	72"	8 1/2"	4	96.6 Lbs.	7 Cu Ft	\$ 2,822	
	DW-7212-S-36-SG	Single Face Starter	37 1/4"	12 1/8"	72"	10 1/2"	4	131 Lbs.	8 Cu Ft	\$ 3,250	
	DW-7212-A-36-SG	Single Face Adder	36 1/4"	12 1/8"	72"	10 1/2"	4	109 Lbs.	8 Cu Ft	\$ 2,876	
	DW-7214-S-36-SG	Single Face Starter	37 1/4"	14 5/8"	72"	13 1/2"	4	159 Lbs.	10 Cu Ft	\$ 3,475	
	DW-7214-A-36-SG	Single Face Adder	36 1/4"	14 5/8"	72"	13 1/2"	4	132 Lbs.	9 Cu Ft	\$ 3,077	
 Model Shown DW-8212-S-36-SG	DW-8210-S-24-SG	Single Face Starter	25 1/4"	10 1/8"	82"	8 1/2"	5			\$ 3,458	
	DW-8210-A-24-SG	Single Face Adder	24 1/4"	10 1/8"	82"	8 1/2"	5			\$ 3,102	
	DW-8212-S-24-SG	Single Face Starter	25 1/4"	12 1/8"	82"	10 1/2"	5			\$ 3,529	
	DW-8212-A-24-SG	Single Face Adder	24 1/4"	12 1/8"	82"	10 1/2"	5			\$ 3,157	
	DW-8214-S-24-SG	Single Face Starter	25 1/4"	14 5/8"	82"	13 1/2"	5			\$ 3,732	
	DW-8214-A-24-SG	Single Face Adder	24 1/4"	14 5/8"	82"	13 1/2"	5			\$ 3,397	
 Model Shown DW-8212-A-36-SG	DW-8210-S-30-SG	Single Face Starter	31 1/4"	10 1/8"	82"	8 1/2"	5			\$ 3,458	
	DW-8210-A-30-SG	Single Face Adder	30 1/4"	10 1/8"	82"	8 1/2"	5			\$ 3,102	
	DW-8212-S-30-SG	Single Face Starter	31 1/4"	12 1/8"	82"	10 1/2"	5			\$ 3,529	
	DW-8212-A-30-SG	Single Face Adder	30 1/4"	12 1/8"	82"	10 1/2"	5			\$ 3,157	
	DW-8214-S-30-SG	Single Face Starter	31 1/4"	14 5/8"	82"	13 1/2"	5			\$ 3,732	
	DW-8214-A-30-SG	Single Face Adder	30 1/4"	14 5/8"	82"	13 1/2"	5			\$ 3,397	
 Model Shown DW-8212-A-36-SG	DW-8210-S-36-SG	Single Face Starter	37 1/4"	10 1/8"	82"	8 1/2"	5	129 Lbs.	8 Cu Ft	\$ 3,288	
	DW-8210-A-36-SG	Single Face Adder	36 1/4"	10 1/8"	82"	8 1/2"	5	107 Lbs.	7 Cu Ft	\$ 2,930	
	DW-8212-S-36-SG	Single Face Starter	37 1/4"	12 1/8"	82"	10 1/2"	5	145 Lbs.	9 Cu Ft	\$ 3,351	
	DW-8212-A-36-SG	Single Face Adder	36 1/4"	12 1/8"	82"	10 1/2"	5	122 Lbs.	8 Cu Ft	\$ 2,977	
	DW-8214-S-36-SG	Single Face Starter	37 1/4"	14 5/8"	82"	13 1/2"	5	175 Lbs.	11 Cu Ft	\$ 3,552	
	DW-8214-A-36-SG	Single Face Adder	36 1/4"	14 5/8"	82"	13 1/2"	5	143 Lbs.	10 Cu Ft	\$ 3,227	

MODEL NUMBER	PRODUCT	WIDTH	DEPTH	HEIGHT	SHELF DEPTH	# OF SHELVES	# OF OPENINGS	WEIGHT	VOLUME	LIST PRICE	DESCRIPTION
DW-9610-S-24-SG	Single Face Starter	25 <sup>1</sup> / <sub>4</sub> "	10 <sup>1</sup> / <sub>8</sub> "	96"	8 <sup>1</sup> / <sub>2</sub> "	6	7			\$ 3,552	End, Mid, Top and Base Panels to be constructed from 1" thick 11-ply solid core, veneered 2 sides. Vertical, top and bottom edges banded with 1/4" external hardwood edging, edges to be eased. Front Edge: 3/4" thick x 2 1/2" high fascia - tongue and grooved to top.
DW-9610-A-24-SG	Single Face Adder	24 <sup>1</sup> / <sub>4</sub> "	10 <sup>1</sup> / <sub>8</sub> "	96"	8 <sup>1</sup> / <sub>2</sub> "	6	7			\$ 3,195	
DW-9612-S-24-SG	Single Face Starter	25 <sup>1</sup> / <sub>4</sub> "	12 <sup>1</sup> / <sub>8</sub> "	96"	10 <sup>1</sup> / <sub>2</sub> "	6	7			\$ 3,639	
DW-9612-A-24-SG	Single Face Adder	24 <sup>1</sup> / <sub>4</sub> "	12 <sup>1</sup> / <sub>8</sub> "	96"	10 <sup>1</sup> / <sub>2</sub> "	6	7			\$ 3,258	
DW-9614-S-24-SG	Single Face Starter	25 <sup>1</sup> / <sub>4</sub> "	14 <sup>5</sup> / <sub>8</sub> "	96"	13 <sup>1</sup> / <sub>2</sub> "	6	7			\$ 3,934	
DW-9614-A-24-SG	Single Face Adder	24 <sup>1</sup> / <sub>4</sub> "	14 <sup>5</sup> / <sub>8</sub> "	96"	13 <sup>1</sup> / <sub>2</sub> "	6	7			\$ 3,506	
DW-9610-S-30-SG	Single Face Starter	31 <sup>1</sup> / <sub>4</sub> "	10 <sup>1</sup> / <sub>8</sub> "	96"	8 <sup>1</sup> / <sub>2</sub> "	6	7			\$ 3,552	
DW-9610-A-30-SG	Single Face Adder	30 <sup>1</sup> / <sub>4</sub> "	10 <sup>1</sup> / <sub>8</sub> "	96"	8 <sup>1</sup> / <sub>2</sub> "	6	7			\$ 3,195	
DW-9612-S-30-SG	Single Face Starter	31 <sup>1</sup> / <sub>4</sub> "	12 <sup>1</sup> / <sub>8</sub> "	96"	10 <sup>1</sup> / <sub>2</sub> "	6	7			\$ 3,639	
DW-9612-A-30-SG	Single Face Adder	30 <sup>1</sup> / <sub>4</sub> "	12 <sup>1</sup> / <sub>8</sub> "	96"	10 <sup>1</sup> / <sub>2</sub> "	6	7			\$ 3,258	
DW-9614-S-30-SG	Single Face Starter	31 <sup>1</sup> / <sub>4</sub> "	14 <sup>5</sup> / <sub>8</sub> "	96"	13 <sup>1</sup> / <sub>2</sub> "	6	7			\$ 3,934	
DW-9614-A-30-SG	Single Face Adder	30 <sup>1</sup> / <sub>4</sub> "	14 <sup>5</sup> / <sub>8</sub> "	96"	13 <sup>1</sup> / <sub>2</sub> "	6	7			\$ 3,506	
DW-9610-S-36-SG	Single Face Starter	37 <sup>1</sup> / <sub>4</sub> "	10 <sup>1</sup> / <sub>8</sub> "	96"	8 <sup>1</sup> / <sub>2</sub> "	6	7	156 Lbs.	9 Cu Ft	\$ 3,382	
DW-9610-A-36-SG	Single Face Adder	36 <sup>1</sup> / <sub>4</sub> "	10 <sup>1</sup> / <sub>8</sub> "	96"	8 <sup>1</sup> / <sub>2</sub> "	6	7	128 Lbs.	8 Cu Ft	\$ 3,023	
DW-9612-S-36-SG	Single Face Starter	37 <sup>1</sup> / <sub>4</sub> "	12 <sup>1</sup> / <sub>8</sub> "	96"	10 <sup>1</sup> / <sub>2</sub> "	6	7	177 Lbs.	10 Cu Ft	\$ 3,458	
DW-9612-A-36-SG	Single Face Adder	36 <sup>1</sup> / <sub>4</sub> "	12 <sup>1</sup> / <sub>8</sub> "	96"	10 <sup>1</sup> / <sub>2</sub> "	6	7	145 Lbs.	9 Cu Ft	\$ 3,085	
DW-9614-S-36-SG	Single Face Starter	37 <sup>1</sup> / <sub>4</sub> "	14 <sup>5</sup> / <sub>8</sub> "	96"	13 <sup>1</sup> / <sub>2</sub> "	6	7	213 Lbs.	12 Cu Ft	\$ 3,763	
DW-9614-A-36-SG	Single Face Adder	36 <sup>1</sup> / <sub>4</sub> "	14 <sup>5</sup> / <sub>8</sub> "	96"	13 <sup>1</sup> / <sub>2</sub> "	6	7	175 Lbs.	11 Cu Ft	\$ 3,327	









Model Shown  
DW-9612-S-36-SG



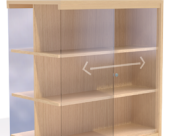



Model Shown  
DW-9612-A-36-SG



MODEL NUMBER	PRODUCT	WIDTH	DEPTH	HEIGHT	SHELF DEPTH	# OF SHELVES	# OF OPENINGS	WEIGHT	VOLUME	LIST PRICE	DESCRIPTION
 Model Shown DW-3624-S-36-SG	DW-3620-S-24-SG	Double Face Starter	25 1/4"	19 1/2"	36"	8 1/2"	2			\$ 4,702	End, Mid, Top and Base Panels to be constructed from 1" thick 11-ply solid core, veneered 2 sides. Vertical, top and bottom edges banded with 1/4" external hardwood edging, edges to be eased. Front Edge: 3/4" thick x 2 1/2" high fascia - tongue and grooved to top.
	DW-3620-A-24-SG	Double Face Adder	24 1/4"	19 1/2"	36"	8 1/2"	2			\$ 4,080	
	DW-3624-S-24-SG	Double Face Starter	25 1/4"	23 1/2"	36"	10 1/2"	2			\$ 4,741	
	DW-3624-A-24-SG	Double Face Adder	24 1/4"	23 1/2"	36"	10 1/2"	2			\$ 4,104	
	DW-3628-S-24-SG	Double Face Starter	25 1/4"	28 1/2"	36"	13 1/2"	2			\$ 5,092	
	DW-3628-A-24-SG	Double Face Adder	24 1/4"	28 1/2"	36"	13 1/2"	2			\$ 4,369	
 Model Shown DW-3624-A-36-SG	DW-3620-S-30-SG	Double Face Starter	31 1/4"	19 1/2"	36"	8 1/2"	2			\$ 4,702	
	DW-3620-A-30-SG	Double Face Adder	30 1/4"	19 1/2"	36"	8 1/2"	2			\$ 4,080	
	DW-3624-S-30-SG	Double Face Starter	31 1/4"	23 1/2"	36"	10 1/2"	2			\$ 4,741	
	DW-3624-A-30-SG	Double Face Adder	30 1/4"	23 1/2"	36"	10 1/2"	2			\$ 4,104	
	DW-3628-S-30-SG	Double Face Starter	31 1/4"	28 1/2"	36"	13 1/2"	2			\$ 5,092	
	DW-3628-A-30-SG	Double Face Adder	30 1/4"	28 1/2"	36"	13 1/2"	2			\$ 4,369	
	DW-3620-S-36-SG	Double Face Starter	37 1/4"	19 1/2"	36"	8 1/2"	2			\$ 4,439	
	DW-3620-A-36-SG	Double Face Adder	36 1/4"	19 1/2"	36"	8 1/2"	2	88.6 Lbs.	7 Cu Ft	\$ 3,817	
	DW-3624-S-36-SG	Double Face Starter	37 1/4"	23 1/2"	36"	10 1/2"	2	73.6 Lbs.	6 Cu Ft	\$ 4,477	
	DW-3624-A-36-SG	Double Face Adder	36 1/4"	23 1/2"	36"	10 1/2"	2	110 Lbs.	10 Cu Ft	\$ 3,841	
	DW-3628-S-36-SG	Double Face Starter	37 1/4"	28 1/2"	36"	13 1/2"	2	88.6 Lbs.	9 Cu Ft	\$ 4,820	
	DW-3628-A-36-SG	Double Face Adder	36 1/4"	28 1/2"	36"	13 1/2"	2	132 Lbs.	11 Cu Ft	\$ 4,120	
 Model Shown DW-4224-S-36-SG	DW-4220-S-24-SG	Double Face Starter	25 1/4"	19 1/2"	42"	8 1/2"	4			\$ 4,905	
	DW-4220-A-24-SG	Double Face Adder	24 1/4"	19 1/2"	42"	8 1/2"	4			\$ 4,283	
	DW-4224-S-24-SG	Double Face Starter	25 1/4"	23 1/2"	42"	10 1/2"	4			\$ 4,960	
	DW-4224-A-24-SG	Double Face Adder	24 1/4"	23 1/2"	42"	10 1/2"	4			\$ 4,315	
	DW-4228-S-24-SG	Double Face Starter	25 1/4"	28 1/2"	42"	13 1/2"	4			\$ 5,372	
	DW-4228-A-24-SG	Double Face Adder	24 1/4"	28 1/2"	42"	13 1/2"	4			\$ 4,671	
 Model Shown DW-4224-A-36-SG	DW-4220-S-30-SG	Double Face Starter	31 1/4"	19 1/2"	42"	8 1/2"	4			\$ 4,905	
	DW-4220-A-30-SG	Double Face Adder	30 1/4"	19 1/2"	42"	8 1/2"	4			\$ 4,283	
	DW-4224-S-30-SG	Double Face Starter	31 1/4"	23 1/2"	42"	10 1/2"	4			\$ 4,960	
	DW-4224-A-30-SG	Double Face Adder	30 1/4"	23 1/2"	42"	10 1/2"	4			\$ 4,315	
	DW-4228-S-30-SG	Double Face Starter	31 1/4"	28 1/2"	42"	13 1/2"	4			\$ 5,372	
	DW-4228-A-30-SG	Double Face Adder	30 1/4"	28 1/2"	42"	13 1/2"	4			\$ 4,671	
	DW-4220-S-36-SG	Double Face Starter	37 1/4"	19 1/2"	42"	8 1/2"	4			\$ 4,640	
	DW-4220-A-36-SG	Double Face Adder	36 1/4"	19 1/2"	42"	8 1/2"	4	94 Lbs.	7 Cu Ft	\$ 4,027	
	DW-4224-S-36-SG	Double Face Starter	37 1/4"	23 1/2"	42"	10 1/2"	4	78 Lbs.	7 Cu Ft	\$ 4,694	
	DW-4224-A-36-SG	Double Face Adder	36 1/4"	23 1/2"	42"	10 1/2"	4	115 Lbs.	10 Cu Ft	\$ 4,050	
	DW-4228-S-36-SG	Double Face Starter	37 1/4"	28 1/2"	42"	13 1/2"	4	113 Lbs.	10 Cu Ft	\$ 5,106	
	DW-4228-A-36-SG	Double Face Adder	36 1/4"	28 1/2"	42"	13 1/2"	4	183 Lbs.	13 Cu Ft	\$ 4,408	

	MODEL NUMBER	PRODUCT	WIDTH	DEPTH	HEIGHT	SHELF DEPTH	# OF SHELVES	# OF OPENINGS	WEIGHT	VOLUME	LIST PRICE	DESCRIPTION
 <p>Model Shown DW-4224-S-36-SG</p>	DW-4820-S-24-SG	Double Face Starter	25 1/4"	19 1/2"	48"	8 1/2"	4	6			\$ 5,146	End, Mid, Top and Base Panels to be constructed from 1" thick 11-ply solid core, veneered 2 sides. Vertical, top and bottom edges banded with 1/4" external hardwood edging, edges to be eased. Front Edge: 3/4" thick x 2 1/2" high fascia - tongue and grooved to top.
	DW-4820-A-24-SG	Double Face Adder	24 1/4"	19 1/2"	48"	8 1/2"	4	6			\$ 4,501	
	DW-4824-S-24-SG	Double Face Starter	25 1/4"	23 1/2"	48"	10 1/2"	4	6			\$ 5,210	
	DW-4824-A-24-SG	Double Face Adder	24 1/4"	23 1/2"	48"	10 1/2"	4	6			\$ 4,532	
	DW-4828-S-24-SG	Double Face Starter	25 1/4"	28 1/2"	48"	13 1/2"	4	6			\$ 5,644	
	DW-4828-A-24-SG	Double Face Adder	24 1/4"	28 1/2"	48"	13 1/2"	4	6			\$ 4,905	
 <p>Model Shown DW-4224-A-36-SG</p>	DW-4820-S-30-SG	Double Face Starter	31 1/4"	19 1/2"	48"	8 1/2"	4	6			\$ 5,146	
	DW-4820-A-30-SG	Double Face Adder	30 1/4"	19 1/2"	48"	8 1/2"	4	6			\$ 4,501	
	DW-4824-S-30-SG	Double Face Starter	31 1/4"	23 1/2"	48"	10 1/2"	4	6			\$ 5,210	
	DW-4824-A-30-SG	Double Face Adder	30 1/4"	23 1/2"	48"	10 1/2"	4	6			\$ 4,532	
	DW-4828-S-30-SG	Double Face Starter	31 1/4"	28 1/2"	48"	13 1/2"	4	6			\$ 5,644	
	DW-4828-A-30-SG	Double Face Adder	30 1/4"	28 1/2"	48"	13 1/2"	4	6			\$ 4,905	
	DW-4820-S-36-SG	Double Face Starter	37 1/4"	19 1/2"	48"	8 1/2"	4	6	132 Lbs.	9 Cu Ft	\$ 4,875	
	DW-4820-A-36-SG	Double Face Adder	36 1/4"	19 1/2"	48"	8 1/2"	4	6	109 Lbs.	8 Cu Ft	\$ 4,222	
	DW-4824-S-36-SG	Double Face Starter	37 1/4"	23 1/2"	48"	10 1/2"	4	6	155 Lbs.	11 Cu Ft	\$ 4,929	
	DW-4824-A-36-SG	Double Face Adder	36 1/4"	23 1/2"	48"	10 1/2"	4	6	127 Lbs.	10 Cu Ft	\$ 4,260	
	DW-4828-S-36-SG	Double Face Starter	37 1/4"	28 1/2"	48"	13 1/2"	4	6	178 Lbs.	13 Cu Ft	\$ 5,364	
	DW-4828-A-36-SG	Double Face Adder	36 1/4"	28 1/2"	48"	13 1/2"	4	6	144 Lbs.	12 Cu Ft	\$ 4,633	
 <p>Model Shown DW-6024-S-36-SG</p>	DW-6020-S-24-SG	Double Face Starter	25 1/4"	19 1/2"	60"	8 1/2"	6	8			\$ 6,546	
	DW-6020-A-24-SG	Double Face Adder	24 1/4"	19 1/2"	60"	8 1/2"	6	8			\$ 5,899	
	DW-6024-S-24-SG	Double Face Starter	25 1/4"	23 1/2"	60"	10 1/2"	6	8			\$ 6,585	
	DW-6024-A-24-SG	Double Face Adder	24 1/4"	23 1/2"	60"	10 1/2"	6	8			\$ 5,956	
	DW-6028-S-24-SG	Double Face Starter	25 1/4"	28 1/2"	60"	13 1/2"	6	8			\$ 7,082	
	DW-6028-A-24-SG	Double Face Adder	24 1/4"	28 1/2"	60"	13 1/2"	6	8			\$ 6,358	
 <p>Model Shown DW-6024-A-36-SG</p>	DW-6020-S-30-SG	Double Face Starter	31 1/4"	19 1/2"	60"	8 1/2"	6	8			\$ 6,546	
	DW-6020-A-30-SG	Double Face Adder	30 1/4"	19 1/2"	60"	8 1/2"	6	8			\$ 5,899	
	DW-6024-S-30-SG	Double Face Starter	31 1/4"	23 1/2"	60"	10 1/2"	6	8			\$ 6,585	
	DW-6024-A-30-SG	Double Face Adder	30 1/4"	23 1/2"	60"	10 1/2"	6	8			\$ 5,956	
	DW-6028-S-30-SG	Double Face Starter	31 1/4"	28 1/2"	60"	13 1/2"	6	8			\$ 7,082	
	DW-6028-A-30-SG	Double Face Adder	30 1/4"	28 1/2"	60"	13 1/2"	6	8			\$ 6,358	
	DW-6020-S-36-SG	Double Face Starter	37 1/4"	19 1/2"	60"	8 1/2"	6	8	176 Lbs.	11 Cu Ft	\$ 6,281	
	DW-6020-A-36-SG	Double Face Adder	36 1/4"	19 1/2"	60"	8 1/2"	6	8	145 Lbs.	10 Cu Ft	\$ 5,644	
	DW-6024-S-36-SG	Double Face Starter	37 1/4"	23 1/2"	60"	10 1/2"	6	8	200 Lbs.	12 Cu Ft	\$ 6,335	
	DW-6024-A-36-SG	Double Face Adder	36 1/4"	23 1/2"	60"	10 1/2"	6	8	164 Lbs.	11 Cu Ft	\$ 5,690	
	DW-6028-S-36-SG	Double Face Starter	37 1/4"	28 1/2"	60"	13 1/2"	6	8	224 Lbs.	13 Cu Ft	\$ 6,816	
	DW-6028-A-36-SG	Double Face Adder	36 1/4"	28 1/2"	60"	13 1/2"	6	8	184 Lbs.	12 Cu Ft	\$ 6,094	

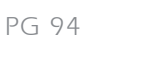
MODEL NUMBER	PRODUCT	WIDTH	DEPTH	HEIGHT	SHELF DEPTH	# OF SHELVES	# OF OPENINGS	WEIGHT	VOLUME	LIST PRICE	DESCRIPTION	
 Model Shown DW-7224-S-36-SG	DW-7220-S-24-SG	Double Face Starter	25 1/4"	19 1/2"	72"	8 1/2"	8	10		\$ 6,747	End, Mid, Top and Base Panels to be constructed from 1" thick 11-ply solid core, veneered 2 sides. Vertical, top and bottom edges banded with 1/4" external hardwood edging, edges to be eased. Front Edge: 3/4" thick x 2 1/2" high fascia - tongue and grooved to top.	
	DW-7220-A-24-SG	Double Face Adder	24 1/4"	19 1/2"	72"	8 1/2"	8	10		\$ 6,102		
	DW-7224-S-24-SG	Double Face Starter	25 1/4"	23 1/2"	72"	10 1/2"	8	10		\$ 6,662		
	DW-7224-A-24-SG	Double Face Adder	24 1/4"	23 1/2"	72"	10 1/2"	8	10		\$ 6,164		
	DW-7228-S-24-SG	Double Face Starter	25 1/4"	28 1/2"	72"	13 1/2"	8	10		\$ 7,307		
	DW-7228-A-24-SG	Double Face Adder	24 1/4"	28 1/2"	72"	13 1/2"	8	10		\$ 6,608		
 Model Shown DW-7224-A-36-SG	DW-7220-S-30-SG	Double Face Starter	31 1/4"	19 1/2"	72"	8 1/2"	8	10		\$ 6,747		
	DW-7220-A-30-SG	Double Face Adder	30 1/4"	19 1/2"	72"	8 1/2"	8	10		\$ 6,102		
	DW-7224-S-30-SG	Double Face Starter	31 1/4"	23 1/2"	72"	10 1/2"	8	10		\$ 6,662		
	DW-7224-A-30-SG	Double Face Adder	30 1/4"	23 1/2"	72"	10 1/2"	8	10		\$ 6,164		
	DW-7228-S-30-SG	Double Face Starter	31 1/4"	28 1/2"	72"	13 1/2"	8	10		\$ 7,307		
	DW-7228-A-30-SG	Double Face Adder	30 1/4"	28 1/2"	72"	13 1/2"	8	10		\$ 6,608		
 Model Shown DW-7224-A-36-SG	DW-7220-S-36-SG	Double Face Starter	37 1/4"	19 1/2"	72"	8 1/2"	8	10	200 Lbs.	12 Cu Ft		\$ 6,483
	DW-7220-A-36-SG	Double Face Adder	36 1/4"	19 1/2"	72"	8 1/2"	8	10	164 Lbs.	11 Cu Ft		\$ 5,839
	DW-7224-S-36-SG	Double Face Starter	37 1/4"	23 1/2"	72"	10 1/2"	8	10	229 Lbs.	13 Cu Ft		\$ 6,546
	DW-7224-A-36-SG	Double Face Adder	36 1/4"	23 1/2"	72"	10 1/2"	8	10	186 Lbs.	12 Cu Ft		\$ 5,899
	DW-7228-S-36-SG	Double Face Starter	37 1/4"	28 1/2"	72"	13 1/2"	8	10	256 Lbs.	14 Cu Ft		\$ 7,051
	DW-7228-A-36-SG	Double Face Adder	36 1/4"	28 1/2"	72"	13 1/2"	8	10	207 Lbs.	13 Cu Ft		\$ 6,335
 Model Shown DW-8224-S-36-SG	DW-8220-S-24-SG	Double Face Starter	25 1/4"	19 1/2"	82"	8 1/2"	10	12		\$ 6,940		
	DW-8220-A-24-SG	Double Face Adder	24 1/4"	19 1/2"	82"	8 1/2"	10	12		\$ 6,304		
	DW-8224-S-24-SG	Double Face Starter	25 1/4"	23 1/2"	82"	10 1/2"	10	12		\$ 7,012		
	DW-8224-A-24-SG	Double Face Adder	24 1/4"	23 1/2"	82"	10 1/2"	10	12		\$ 6,381		
	DW-8228-S-24-SG	Double Face Starter	25 1/4"	28 1/2"	82"	13 1/2"	10	12		\$ 7,867		
	DW-8228-A-24-SG	Double Face Adder	24 1/4"	28 1/2"	82"	13 1/2"	10	12		\$ 6,989		
 Model Shown DW-8224-A-36-SG	DW-8220-S-30-SG	Double Face Starter	31 1/4"	19 1/2"	82"	8 1/2"	10	12		\$ 6,940		
	DW-8220-A-30-SG	Double Face Adder	30 1/4"	19 1/2"	82"	8 1/2"	10	12		\$ 6,304		
	DW-8224-S-30-SG	Double Face Starter	31 1/4"	23 1/2"	82"	10 1/2"	10	12		\$ 7,012		
	DW-8224-A-30-SG	Double Face Adder	30 1/4"	23 1/2"	82"	10 1/2"	10	12		\$ 6,381		
	DW-8228-S-30-SG	Double Face Starter	31 1/4"	28 1/2"	82"	13 1/2"	10	12		\$ 7,867		
	DW-8228-A-30-SG	Double Face Adder	30 1/4"	28 1/2"	82"	13 1/2"	10	12		\$ 6,989		
 Model Shown DW-8224-A-36-SG	DW-8220-S-36-SG	Double Face Starter	37 1/4"	19 1/2"	82"	8 1/2"	10	12	224 Lbs.	12 Cu Ft	\$ 6,678	
	DW-8220-A-36-SG	Double Face Adder	36 1/4"	19 1/2"	82"	8 1/2"	10	12	184 Lbs.	11 Cu Ft	\$ 6,040	
	DW-8224-S-36-SG	Double Face Starter	37 1/4"	23 1/2"	82"	10 1/2"	10	12	256 Lbs.	14 Cu Ft	\$ 6,732	
	DW-8224-A-36-SG	Double Face Adder	36 1/4"	23 1/2"	82"	10 1/2"	10	12	207 Lbs.	12 Cu Ft	\$ 6,118	
	DW-8228-S-36-SG	Double Face Starter	37 1/4"	28 1/2"	82"	13 1/2"	10	12	289 Lbs.	16 Cu Ft	\$ 7,603	
	DW-8228-A-36-SG	Double Face Adder	36 1/4"	28 1/2"	82"	13 1/2"	10	12	230 Lbs.	14 Cu Ft	\$ 6,723	





MODEL NUMBER	PRODUCT	WIDTH	DEPTH	HEIGHT	SHELF DEPTH	# OF SHELVES	# OF OPENINGS	WEIGHT	VOLUME	LIST PRICE	DESCRIPTION
DW-9620-S-24-SG	Double Face Starter	25 1/4"	19 1/2"	96"	8 1/2"	12	14			\$ 7,137	End, Mid, Top and Base Panels to be constructed from 1" thick 11-ply solid core, veneered 2 sides. Vertical, top and bottom edges banded with 1/4" external hardwood edging, edges to be eased. Front Edge: 3/4" thick x 2 1/2" high fascia - tongue and grooved to top.
DW-9620-A-24-SG	Double Face Adder	24 1/4"	19 1/2"	96"	8 1/2"	12	14			\$ 6,499	
DW-9624-S-24-SG	Double Face Starter	25 1/4"	23 1/2"	96"	10 1/2"	12	14			\$ 7,245	
DW-9624-A-24-SG	Double Face Adder	24 1/4"	23 1/2"	96"	10 1/2"	12	14			\$ 6,592	
DW-9628-S-24-SG	Double Face Starter	25 1/4"	28 1/2"	96"	13 1/2"	12	14			\$ 8,099	
DW-9628-A-24-SG	Double Face Adder	24 1/4"	28 1/2"	96"	13 1/2"	12	14			\$ 7,238	
DW-9620-S-30-SG	Double Face Starter	31 1/4"	19 1/2"	96"	8 1/2"	12	14			\$ 7,137	
DW-9620-A-30-SG	Double Face Adder	30 1/4"	19 1/2"	96"	8 1/2"	12	14			\$ 6,499	
DW-9624-S-30-SG	Double Face Starter	31 1/4"	23 1/2"	96"	10 1/2"	12	14			\$ 7,245	
DW-9624-A-30-SG	Double Face Adder	30 1/4"	23 1/2"	96"	10 1/2"	12	14			\$ 6,592	
DW-9628-S-30-SG	Double Face Starter	31 1/4"	28 1/2"	96"	13 1/2"	12	14			\$ 8,099	
DW-9628-A-30-SG	Double Face Adder	30 1/4"	28 1/2"	96"	13 1/2"	12	14			\$ 7,238	
DW-9620-S-36-SG	Double Face Starter	37 1/4"	19 1/2"	96"	8 1/2"	12	14	276 Lbs.	13 Cu Ft	\$ 6,879	
DW-9620-A-36-SG	Double Face Adder	36 1/4"	19 1/2"	96"	8 1/2"	12	14	220 Lbs.	12 Cu Ft	\$ 6,234	
DW-9624-S-36-SG	Double Face Starter	37 1/4"	23 1/2"	96"	10 1/2"	12	14	315 Lbs.	15 Cu Ft	\$ 6,964	
DW-9624-A-36-SG	Double Face Adder	36 1/4"	23 1/2"	96"	10 1/2"	12	14	247 Lbs.	13 Cu Ft	\$ 6,328	
DW-9628-S-36-SG	Double Face Starter	37 1/4"	28 1/2"	96"	13 1/2"	12	14	353 Lbs.	17 Cu Ft	\$ 7,835	
DW-9628-A-36-SG	Double Face Adder	36 1/4"	28 1/2"	96"	13 1/2"	12	14	275 Lbs.	15 Cu Ft	\$ 6,972	







Model Shown  
DW-9624-S-36-SG







Model Shown  
DW-9624-A-36-SG

	MODEL NUMBER	PRODUCT	WIDTH	DEPTH	HEIGHT	SHELF DEPTH	# OF SHELVES	# OF OPENINGS	WEIGHT	VOLUME	LIST PRICE	DESCRIPTION
 <p>Model Shown DW-3612-S-36-SG-G</p>	DW-3610-S-24-SG-G	Single Face Starter	25 1/4"	10 1/8"	36"	8 1/2"	1	2			\$ 2,425	End, Mid, Top and Base Panels to be constructed from 1" thick 11-ply solid core, veneered 2 sides. Vertical, top and bottom edges banded with 1/4" external hardwood edging, edges to be eased. Front Edge: 3/4" thick x 2 1/2" high fascia - tongue and grooved to top.
	DW-3610-A-24-SG-G	Single Face Adder	24 1/4"	10 1/8"	36"	8 1/2"	1	2			\$ 2,076	
	DW-3612-S-24-SG-G	Single Face Starter	25 1/4"	12 1/8"	36"	10 1/2"	1	2			\$ 2,481	
	DW-3612-A-24-SG-G	Single Face Adder	24 1/4"	12 1/8"	36"	10 1/2"	1	2			\$ 2,115	
	DW-3614-S-24-SG-G	Single Face Starter	25 1/4"	14 5/8"	36"	13 1/2"	1	2			\$ 2,659	
	DW-3614-A-24-SG-G	Single Face Adder	24 1/4"	14 5/8"	36"	13 1/2"	1	2			\$ 2,254	
 <p>Model Shown DW-3612-A-36-SG-G</p>	DW-3610-S-30-SG-G	Single Face Starter	31 1/4"	10 1/8"	36"	8 1/2"	1	2			\$ 2,425	
	DW-3610-A-30-SG-G	Single Face Adder	30 1/4"	10 1/8"	36"	8 1/2"	1	2			\$ 2,076	
	DW-3612-S-30-SG-G	Single Face Starter	31 1/4"	12 1/8"	36"	10 1/2"	1	2			\$ 2,481	
	DW-3612-A-30-SG-G	Single Face Adder	30 1/4"	12 1/8"	36"	10 1/2"	1	2			\$ 2,115	
	DW-3614-S-30-SG-G	Single Face Starter	31 1/4"	14 5/8"	36"	13 1/2"	1	2			\$ 2,659	
	DW-3614-A-30-SG-G	Single Face Adder	30 1/4"	14 5/8"	36"	13 1/2"	1	2			\$ 2,254	
	DW-3610-S-36-SG-G	Single Face Starter	37 1/4"	10 1/8"	36"	8 1/2"	1	2	50.6 Lbs.	4 Cu Ft	\$ 2,254	
	DW-3610-A-36-SG-G	Single Face Adder	36 1/4"	10 1/8"	36"	8 1/2"	1	2	46 Lbs.	4 Cu Ft	\$ 1,897	
	DW-3612-S-36-SG-G	Single Face Starter	37 1/4"	12 1/8"	36"	10 1/2"	1	2	50.6 Lbs.	5 Cu Ft	\$ 2,309	
	DW-3612-A-36-SG-G	Single Face Adder	36 1/4"	12 1/8"	36"	10 1/2"	1	2	47.2 Lbs.	5 Cu Ft	\$ 1,935	
	DW-3614-S-36-SG-G	Single Face Starter	37 1/4"	14 5/8"	36"	13 1/2"	1	2	74.8 Lbs.	6 Cu Ft	\$ 2,487	
	DW-3614-A-36-SG-G	Single Face Adder	36 1/4"	14 5/8"	36"	13 1/2"	1	2	63.3 Lbs.	6 Cu Ft	\$ 2,083	
 <p>Model Shown DW-4212-S-36-SG-G</p>	DW-4210-S-24-SG-G	Single Face Starter	25 1/4"	10 1/8"	42"	8 1/2"	2	3			\$ 2,566	
	DW-4210-A-24-SG-G	Single Face Adder	24 1/4"	10 1/8"	42"	8 1/2"	2	3			\$ 2,215	
	DW-4212-S-24-SG-G	Single Face Starter	25 1/4"	12 1/8"	42"	10 1/2"	2	3			\$ 2,636	
	DW-4212-A-24-SG-G	Single Face Adder	24 1/4"	12 1/8"	42"	10 1/2"	2	3			\$ 2,263	
	DW-4214-S-24-SG-G	Single Face Starter	25 1/4"	14 5/8"	42"	13 1/2"	2	3			\$ 2,853	
	DW-4214-A-24-SG-G	Single Face Adder	24 1/4"	14 5/8"	42"	13 1/2"	2	3			\$ 2,463	
 <p>Model Shown DW-4212-A-36-SG-G</p>	DW-4210-S-30-SG-G	Single Face Starter	31 1/4"	10 1/8"	42"	8 1/2"	2	3			\$ 2,566	
	DW-4210-A-30-SG-G	Single Face Adder	30 1/4"	10 1/8"	42"	8 1/2"	2	3			\$ 2,215	
	DW-4212-S-30-SG-G	Single Face Starter	31 1/4"	12 1/8"	42"	10 1/2"	2	3			\$ 2,636	
	DW-4212-A-30-SG-G	Single Face Adder	30 1/4"	12 1/8"	42"	10 1/2"	2	3			\$ 2,263	
	DW-4214-S-30-SG-G	Single Face Starter	31 1/4"	14 5/8"	42"	13 1/2"	2	3			\$ 2,853	
	DW-4214-A-30-SG-G	Single Face Adder	30 1/4"	14 5/8"	42"	13 1/2"	2	3			\$ 2,463	
	DW-4210-S-36-SG-G	Single Face Starter	37 1/4"	10 1/8"	42"	8 1/2"	2	3	55 Lbs.	5 Cu Ft	\$ 2,394	
	DW-4210-A-36-SG-G	Single Face Adder	36 1/4"	10 1/8"	42"	8 1/2"	2	3	52 Lbs.	5 Cu Ft	\$ 2,045	
	DW-4212-S-36-SG-G	Single Face Starter	37 1/4"	12 1/8"	42"	10 1/2"	2	3	60 Lbs.	5 Cu Ft	\$ 2,463	
	DW-4212-A-36-SG-G	Single Face Adder	36 1/4"	12 1/8"	42"	10 1/2"	2	3	53 Lbs.	5 Cu Ft	\$ 2,091	
	DW-4214-S-36-SG-G	Single Face Starter	37 1/4"	14 5/8"	42"	13 1/2"	2	3	79 Lbs.	6 Cu Ft	\$ 2,698	
	DW-4214-A-36-SG-G	Single Face Adder	36 1/4"	14 5/8"	42"	13 1/2"	2	3	68 Lbs.	6 Cu Ft	\$ 2,293	

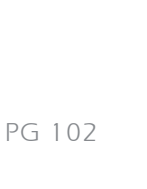

	MODEL NUMBER	PRODUCT	WIDTH	DEPTH	HEIGHT	SHELF DEPTH	# OF SHELVES	# OF OPENINGS	WEIGHT	VOLUME	LIST PRICE	DESCRIPTION
 <p>Model Shown DW-4212-S-36-SG-G</p>	DW-4810-S-24-SG-G	Single Face Starter	25 1/4"	10 1/8"	48"	8 1/2"	2	3			\$ 2,636	End, Mid, Top and Base Panels to be constructed from 1" thick 11-ply solid core, veneered 2 sides. Vertical, top and bottom edges banded with 1/4" external hardwood edging, edges to be eased. Front Edge: 3/4" thick x 2 1/2" high fascia - tongue and grooved to top.
	DW-4810-A-24-SG-G	Single Face Adder	24 1/4"	10 1/8"	48"	8 1/2"	2	3			\$ 2,270	
	DW-4812-S-24-SG-G	Single Face Starter	25 1/4"	12 1/8"	48"	10 1/2"	2	3			\$ 2,675	
	DW-4812-A-24-SG-G	Single Face Adder	24 1/4"	12 1/8"	48"	10 1/2"	2	3			\$ 2,286	
	DW-4814-S-24-SG-G	Single Face Starter	25 1/4"	14 5/8"	48"	13 1/2"	2	3			\$ 2,907	
	DW-4814-A-24-SG-G	Single Face Adder	24 1/4"	14 5/8"	48"	13 1/2"	2	3			\$ 2,494	
 <p>Model Shown DW-4212-A-36-SG-G</p>	DW-4810-S-30-SG-G	Single Face Starter	31 1/4"	10 1/8"	48"	8 1/2"	2	3			\$ 2,636	
	DW-4810-A-30-SG-G	Single Face Adder	30 1/4"	10 1/8"	48"	8 1/2"	2	3			\$ 2,270	
	DW-4812-S-30-SG-G	Single Face Starter	31 1/4"	12 1/8"	48"	10 1/2"	2	3			\$ 2,675	
	DW-4812-A-30-SG-G	Single Face Adder	30 1/4"	12 1/8"	48"	10 1/2"	2	3			\$ 2,286	
	DW-4814-S-30-SG-G	Single Face Starter	31 1/4"	14 5/8"	48"	13 1/2"	2	3			\$ 2,907	
	DW-4814-A-30-SG-G	Single Face Adder	30 1/4"	14 5/8"	48"	13 1/2"	2	3			\$ 2,494	
	DW-4810-S-36-SG-G	Single Face Starter	37 1/4"	10 1/8"	48"	8 1/2"	2	3	74.8 Lbs.	5 Cu Ft	\$ 2,463	
	DW-4810-A-36-SG-G	Single Face Adder	36 1/4"	10 1/8"	48"	8 1/2"	2	3	65.5 Lbs.	5 Cu Ft	\$ 2,091	
	DW-4812-S-36-SG-G	Single Face Starter	37 1/4"	12 1/8"	48"	10 1/2"	2	3	82.8 Lbs.	6 Cu Ft	\$ 2,494	
	DW-4812-A-36-SG-G	Single Face Adder	36 1/4"	12 1/8"	48"	10 1/2"	2	3	71.3 Lbs.	6 Cu Ft	\$ 2,115	
	DW-4814-S-36-SG-G	Single Face Starter	37 1/4"	14 5/8"	48"	13 1/2"	2	3	108 Lbs.	7 Cu Ft	\$ 2,736	
	DW-4814-A-36-SG-G	Single Face Adder	36 1/4"	14 5/8"	48"	13 1/2"	2	3	92 Lbs.	7 Cu Ft	\$ 2,324	
 <p>Model Shown DW-6012-S-36-SG-G</p>	DW-6010-S-24-SG-G	Single Face Starter	25 1/4"	10 1/8"	60"	8 1/2"	3	4			\$ 3,374	
	DW-6010-A-24-SG-G	Single Face Adder	24 1/4"	10 1/8"	60"	8 1/2"	3	4			\$ 3,016	
	DW-6012-S-24-SG-G	Single Face Starter	25 1/4"	12 1/8"	60"	10 1/2"	3	4			\$ 3,451	
	DW-6012-A-24-SG-G	Single Face Adder	24 1/4"	12 1/8"	60"	10 1/2"	3	4			\$ 3,077	
	DW-6014-S-24-SG-G	Single Face Starter	25 1/4"	14 5/8"	60"	13 1/2"	3	4			\$ 3,747	
	DW-6014-A-24-SG-G	Single Face Adder	24 1/4"	14 5/8"	60"	13 1/2"	3	4			\$ 3,343	
 <p>Model Shown DW-6012-A-36-SG-G</p>	DW-6010-S-30-SG-G	Single Face Starter	31 1/4"	10 1/8"	60"	8 1/2"	3	4			\$ 3,374	
	DW-6010-A-30-SG-G	Single Face Adder	30 1/4"	10 1/8"	60"	8 1/2"	3	4			\$ 3,016	
	DW-6012-S-30-SG-G	Single Face Starter	31 1/4"	12 1/8"	60"	10 1/2"	3	4			\$ 3,451	
	DW-6012-A-30-SG-G	Single Face Adder	30 1/4"	12 1/8"	60"	10 1/2"	3	4			\$ 3,077	
	DW-6014-S-30-SG-G	Single Face Starter	31 1/4"	14 5/8"	60"	13 1/2"	3	4			\$ 3,747	
	DW-6014-A-30-SG-G	Single Face Adder	30 1/4"	14 5/8"	60"	13 1/2"	3	4			\$ 3,343	
 <p>Model Shown DW-6012-A-36-SG-G</p>	DW-6010-S-36-SG-G	Single Face Starter	37 1/4"	10 1/8"	60"	8 1/2"	3	4	100 Lbs.	6 Cu Ft	\$ 3,203	
	DW-6010-A-36-SG-G	Single Face Adder	36 1/4"	10 1/8"	60"	8 1/2"	3	4	86.3 Lbs.	6 Cu Ft	\$ 2,846	
	DW-6012-S-36-SG-G	Single Face Starter	37 1/4"	12 1/8"	60"	10 1/2"	3	4	116 Lbs.	8 Cu Ft	\$ 3,273	
	DW-6012-A-36-SG-G	Single Face Adder	36 1/4"	12 1/8"	60"	10 1/2"	3	4	95.5 Lbs.	7 Cu Ft	\$ 2,907	
	DW-6014-S-36-SG-G	Single Face Starter	37 1/4"	14 5/8"	60"	13 1/2"	3	4	141 Lbs.	9 Cu Ft	\$ 3,568	
	DW-6014-A-36-SG-G	Single Face Adder	36 1/4"	14 5/8"	60"	13 1/2"	3	4	121 Lbs.	8 Cu Ft	\$ 3,164	

MODEL NUMBER	PRODUCT	WIDTH	DEPTH	HEIGHT	SHELF DEPTH	# OF SHELVES	# OF OPENINGS	WEIGHT	VOLUME	LIST PRICE	DESCRIPTION
 Model Shown DW-7212-S-36-SG-G	DW-7210-S-24-SG-G	25 1/4"	10 1/8"	72"	8 1/2"	4	5			\$ 3,514	End, Mid, Top and Base Panels to be constructed from 1" thick 11-ply solid core, veneered 2 sides. Vertical, top and bottom edges banded with 1/4" external hardwood edging, edges to be eased. Front Edge: 3/4" thick x 2 1/2" high fascia - tongue and grooved to top.
	DW-7210-A-24-SG-G	24 1/4"	10 1/8"	72"	8 1/2"	4	5			\$ 3,157	
	DW-7212-S-24-SG-G	25 1/4"	12 1/8"	72"	10 1/2"	4	5			\$ 3,606	
	DW-7212-A-24-SG-G	24 1/4"	12 1/8"	72"	10 1/2"	4	5			\$ 3,234	
	DW-7214-S-24-SG-G	25 1/4"	14 5/8"	72"	13 1/2"	4	5			\$ 3,926	
	DW-7214-A-24-SG-G	24 1/4"	14 5/8"	72"	13 1/2"	4	5			\$ 3,536	
 Model Shown DW-7212-A-36-SG-G	DW-7210-S-30-SG-G	31 1/4"	10 1/8"	72"	8 1/2"	4	5			\$ 3,514	
	DW-7210-A-30-SG-G	30 1/4"	10 1/8"	72"	8 1/2"	4	5			\$ 3,157	
	DW-7212-S-30-SG-G	31 1/4"	12 1/8"	72"	10 1/2"	4	5			\$ 3,606	
	DW-7212-A-30-SG-G	30 1/4"	12 1/8"	72"	10 1/2"	4	5			\$ 3,234	
	DW-7214-S-30-SG-G	31 1/4"	14 5/8"	72"	13 1/2"	4	5			\$ 3,926	
	DW-7214-A-30-SG-G	30 1/4"	14 5/8"	72"	13 1/2"	4	5			\$ 3,536	
 Model Shown DW-7212-A-36-SG-G	DW-7210-S-36-SG-G	37 1/4"	10 1/8"	72"	8 1/2"	4	5	115 Lbs.	7 Cu Ft	\$ 3,343	
	DW-7210-A-36-SG-G	36 1/4"	10 1/8"	72"	8 1/2"	4	5	96.6 Lbs.	7 Cu Ft	\$ 2,977	
	DW-7212-S-36-SG-G	37 1/4"	12 1/8"	72"	10 1/2"	4	5	131 Lbs.	8 Cu Ft	\$ 3,436	
	DW-7212-A-36-SG-G	36 1/4"	12 1/8"	72"	10 1/2"	4	5	109 Lbs.	8 Cu Ft	\$ 3,064	
	DW-7214-S-36-SG-G	37 1/4"	14 5/8"	72"	13 1/2"	4	5	159 Lbs.	10 Cu Ft	\$ 3,756	
	DW-7214-A-36-SG-G	36 1/4"	14 5/8"	72"	13 1/2"	4	5	132 Lbs.	9 Cu Ft	\$ 3,358	
 Model Shown DW-8212-S-36-SG-G	DW-8210-S-24-SG-G	25 1/4"	10 1/8"	82"	8 1/2"	5	6			\$ 3,654	
	DW-8210-A-24-SG-G	24 1/4"	10 1/8"	82"	8 1/2"	5	6			\$ 3,297	
	DW-8212-S-24-SG-G	25 1/4"	12 1/8"	82"	10 1/2"	5	6			\$ 3,763	
	DW-8212-A-24-SG-G	24 1/4"	12 1/8"	82"	10 1/2"	5	6			\$ 3,389	
	DW-8214-S-24-SG-G	25 1/4"	14 5/8"	82"	13 1/2"	5	6			\$ 4,080	
	DW-8214-A-24-SG-G	24 1/4"	14 5/8"	82"	13 1/2"	5	6			\$ 3,747	
 Model Shown DW-8212-A-36-SG-G	DW-8210-S-30-SG-G	31 1/4"	10 1/8"	82"	8 1/2"	5	6			\$ 3,654	
	DW-8210-A-30-SG-G	30 1/4"	10 1/8"	82"	8 1/2"	5	6			\$ 3,297	
	DW-8212-S-30-SG-G	31 1/4"	12 1/8"	82"	10 1/2"	5	6			\$ 3,763	
	DW-8212-A-30-SG-G	30 1/4"	12 1/8"	82"	10 1/2"	5	6			\$ 3,389	
	DW-8214-S-30-SG-G	31 1/4"	14 5/8"	82"	13 1/2"	5	6			\$ 4,080	
	DW-8214-A-30-SG-G	30 1/4"	14 5/8"	82"	13 1/2"	5	6			\$ 3,747	
 Model Shown DW-8212-A-36-SG-G	DW-8210-S-36-SG-G	37 1/4"	10 1/8"	82"	8 1/2"	5	6	129 Lbs.	8 Cu Ft	\$ 3,482	
	DW-8210-A-36-SG-G	36 1/4"	10 1/8"	82"	8 1/2"	5	6	107 Lbs.	7 Cu Ft	\$ 3,125	
	DW-8212-S-36-SG-G	37 1/4"	12 1/8"	82"	10 1/2"	5	6	145 Lbs.	9 Cu Ft	\$ 3,582	
	DW-8212-A-36-SG-G	36 1/4"	12 1/8"	82"	10 1/2"	5	6	122 Lbs.	8 Cu Ft	\$ 3,210	
	DW-8214-S-36-SG-G	37 1/4"	14 5/8"	82"	13 1/2"	5	6	175 Lbs.	11 Cu Ft	\$ 3,903	
	DW-8214-A-36-SG-G	36 1/4"	14 5/8"	82"	13 1/2"	5	6	143 Lbs.	10 Cu Ft	\$ 3,575	



MODEL NUMBER	PRODUCT	WIDTH	DEPTH	HEIGHT	SHELF DEPTH	# OF SHELVES	# OF OPENINGS	WEIGHT	VOLUME	LIST PRICE	DESCRIPTION
DW-9610-S-24-SG-G	Single Face Starter	25 1/4"	10 1/8"	96"	8 1/2"	6	7			\$ 3,786	End, Mid, Top and Base Panels to be constructed from 1" thick 11-ply solid core, veneered 2 sides. Vertical, top and bottom edges banded with 1/4" external hardwood edging, edges to be eased. Front Edge: 3/4" thick x 2 1/2" high fascia - tongue and grooved to top.
DW-9610-A-24-SG-G	Single Face Adder	24 1/4"	10 1/8"	96"	8 1/2"	6	7			\$ 3,428	
DW-9612-S-24-SG-G	Single Face Starter	25 1/4"	12 1/8"	96"	10 1/2"	6	7			\$ 3,918	
DW-9612-A-24-SG-G	Single Face Adder	24 1/4"	12 1/8"	96"	10 1/2"	6	7			\$ 3,536	
DW-9614-S-24-SG-G	Single Face Starter	25 1/4"	14 5/8"	96"	13 1/2"	6	7			\$ 4,353	
DW-9614-A-24-SG-G	Single Face Adder	24 1/4"	14 5/8"	96"	13 1/2"	6	7			\$ 3,926	
DW-9610-S-30-SG-G	Single Face Starter	31 1/4"	10 1/8"	96"	8 1/2"	6	7			\$ 3,786	
DW-9610-A-30-SG-G	Single Face Adder	30 1/4"	10 1/8"	96"	8 1/2"	6	7			\$ 3,428	
DW-9612-S-30-SG-G	Single Face Starter	31 1/4"	12 1/8"	96"	10 1/2"	6	7			\$ 3,918	
DW-9612-A-30-SG-G	Single Face Adder	30 1/4"	12 1/8"	96"	10 1/2"	6	7			\$ 3,536	
DW-9614-S-30-SG-G	Single Face Starter	31 1/4"	14 5/8"	96"	13 1/2"	6	7			\$ 4,353	
DW-9614-A-30-SG-G	Single Face Adder	30 1/4"	14 5/8"	96"	13 1/2"	6	7			\$ 3,926	
DW-9610-S-36-SG-G	Single Face Starter	37 1/4"	10 1/8"	96"	8 1/2"	6	7	156 Lbs.	9 Cu Ft	\$ 3,614	
DW-9610-A-36-SG-G	Single Face Adder	36 1/4"	10 1/8"	96"	8 1/2"	6	7	128 Lbs.	8 Cu Ft	\$ 3,258	
DW-9612-S-36-SG-G	Single Face Starter	37 1/4"	12 1/8"	96"	10 1/2"	6	7	177 Lbs.	10 Cu Ft	\$ 3,739	
DW-9612-A-36-SG-G	Single Face Adder	36 1/4"	12 1/8"	96"	10 1/2"	6	7	145 Lbs.	9 Cu Ft	\$ 3,365	
DW-9614-S-36-SG-G	Single Face Starter	37 1/4"	14 5/8"	96"	13 1/2"	6	7	213 Lbs.	12 Cu Ft	\$ 4,183	
DW-9614-A-36-SG-G	Single Face Adder	36 1/4"	14 5/8"	96"	13 1/2"	6	7	175 Lbs.	11 Cu Ft	\$ 3,747	





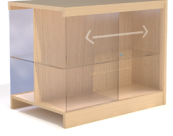

Model Shown  
DW-9612-S-36-SG-G







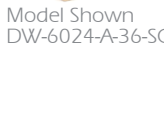

Model Shown  
DW-9612-A-36-SG-G



	MODEL NUMBER	PRODUCT	WIDTH	DEPTH	HEIGHT	SHELF DEPTH	# OF SHELVES	# OF OPENINGS	WEIGHT	VOLUME	LIST PRICE	DESCRIPTION
 Model Shown DW-3624-S-36-SG-G	DW-3620-S-24-SG-G	Double Face Starter	25 1/4"	19 1/2"	36"	8 1/2"	2	4			\$ 4,727	End, Mid, Top and Base Panels to be constructed from 1" thick 11-ply solid core, veneered 2 sides. Vertical, top and bottom edges banded with 1/4" external hardwood edging, edges to be eased. Front Edge: 3/4" thick x 2 1/2" high fascia - tongue and grooved to top.
	DW-3620-A-24-SG-G	Double Face Adder	24 1/4"	19 1/2"	36"	8 1/2"	2	4			\$ 4,111	
	DW-3624-S-24-SG-G	Double Face Starter	25 1/4"	23 1/2"	36"	10 1/2"	2	4			\$ 4,781	
	DW-3624-A-24-SG-G	Double Face Adder	24 1/4"	23 1/2"	36"	10 1/2"	2	4			\$ 4,143	
	DW-3628-S-24-SG-G	Double Face Starter	25 1/4"	28 1/2"	36"	13 1/2"	2	4			\$ 5,169	
	DW-3628-A-24-SG-G	Double Face Adder	24 1/4"	28 1/2"	36"	13 1/2"	2	4			\$ 4,470	
 Model Shown DW-3624-A-36-SG-G	DW-3620-S-30-SG-G	Double Face Starter	31 1/4"	19 1/2"	36"	8 1/2"	2	4			\$ 4,727	
	DW-3620-A-30-SG-G	Double Face Adder	30 1/4"	19 1/2"	36"	8 1/2"	2	4			\$ 4,111	
	DW-3624-S-30-SG-G	Double Face Starter	31 1/4"	23 1/2"	36"	10 1/2"	2	4			\$ 4,781	
	DW-3624-A-30-SG-G	Double Face Adder	30 1/4"	23 1/2"	36"	10 1/2"	2	4			\$ 4,143	
	DW-3628-S-30-SG-G	Double Face Starter	31 1/4"	28 1/2"	36"	13 1/2"	2	4			\$ 5,169	
	DW-3628-A-30-SG-G	Double Face Adder	30 1/4"	28 1/2"	36"	13 1/2"	2	4			\$ 4,470	
	DW-3620-S-36-SG-G	Double Face Starter	37 1/4"	19 1/2"	36"	8 1/2"	2	4	88.6 Lbs.	7 Cu Ft	\$ 4,509	
	DW-3620-A-36-SG-G	Double Face Adder	36 1/4"	19 1/2"	36"	8 1/2"	2	4	73.6 Lbs.	6 Cu Ft	\$ 3,856	
	DW-3624-S-36-SG-G	Double Face Starter	37 1/4"	23 1/2"	36"	10 1/2"	2	4	110 Lbs.	10 Cu Ft	\$ 4,524	
	DW-3624-A-36-SG-G	Double Face Adder	36 1/4"	23 1/2"	36"	10 1/2"	2	4	88.6 Lbs.	9 Cu Ft	\$ 3,887	
	DW-3628-S-36-SG-G	Double Face Starter	37 1/4"	28 1/2"	36"	13 1/2"	2	4	132 Lbs.	11 Cu Ft	\$ 4,905	
	DW-3628-A-36-SG-G	Double Face Adder	36 1/4"	28 1/2"	36"	13 1/2"	2	4	104 Lbs.	10 Cu Ft	\$ 4,215	
 Model Shown DW-4224-S-36-SG-G	DW-4220-S-24-SG-G	Double Face Starter	25 1/4"	19 1/2"	42"	8 1/2"	4	6			\$ 4,999	
	DW-4220-A-24-SG-G	Double Face Adder	24 1/4"	19 1/2"	42"	8 1/2"	4	6			\$ 4,385	
	DW-4224-S-24-SG-G	Double Face Starter	25 1/4"	23 1/2"	42"	10 1/2"	4	6			\$ 5,085	
	DW-4224-A-24-SG-G	Double Face Adder	24 1/4"	23 1/2"	42"	10 1/2"	4	6			\$ 4,446	
	DW-4228-S-24-SG-G	Double Face Starter	25 1/4"	28 1/2"	42"	13 1/2"	4	6			\$ 5,434	
	DW-4228-A-24-SG-G	Double Face Adder	24 1/4"	28 1/2"	42"	13 1/2"	4	6			\$ 4,889	
 Model Shown DW-4224-A-36-SG-G	DW-4220-S-30-SG-G	Double Face Starter	31 1/4"	19 1/2"	42"	8 1/2"	4	6			\$ 4,999	
	DW-4220-A-30-SG-G	Double Face Adder	30 1/4"	19 1/2"	42"	8 1/2"	4	6			\$ 4,385	
	DW-4224-S-30-SG-G	Double Face Starter	31 1/4"	23 1/2"	42"	10 1/2"	4	6			\$ 5,085	
	DW-4224-A-30-SG-G	Double Face Adder	30 1/4"	23 1/2"	42"	10 1/2"	4	6			\$ 4,446	
	DW-4228-S-30-SG-G	Double Face Starter	31 1/4"	28 1/2"	42"	13 1/2"	4	6			\$ 5,434	
	DW-4228-A-30-SG-G	Double Face Adder	30 1/4"	28 1/2"	42"	13 1/2"	4	6			\$ 4,889	
	DW-4220-S-36-SG-G	Double Face Starter	37 1/4"	19 1/2"	42"	8 1/2"	4	6	94 Lbs.	7 Cu Ft	\$ 4,741	
	DW-4220-A-36-SG-G	Double Face Adder	36 1/4"	19 1/2"	42"	8 1/2"	4	6	78 Lbs.	7 Cu Ft	\$ 4,129	
	DW-4224-S-36-SG-G	Double Face Starter	37 1/4"	23 1/2"	42"	10 1/2"	4	6	115 Lbs.	10 Cu Ft	\$ 4,827	
	DW-4224-A-36-SG-G	Double Face Adder	36 1/4"	23 1/2"	42"	10 1/2"	4	6	113 Lbs.	10 Cu Ft	\$ 4,191	
	DW-4228-S-36-SG-G	Double Face Starter	37 1/4"	28 1/2"	42"	13 1/2"	4	6	183 Lbs.	13 Cu Ft	\$ 5,316	
	DW-4228-A-36-SG-G	Double Face Adder	36 1/4"	28 1/2"	42"	13 1/2"	4	6	109 Lbs.	13 Cu Ft	\$ 4,626	



	MODEL NUMBER	PRODUCT	WIDTH	DEPTH	HEIGHT	SHELF DEPTH	# OF SHELVES	# OF OPENINGS	WEIGHT	VOLUME	LIST PRICE	DESCRIPTION
 <p>Model Shown DW-4224-S-36-SG-G</p>	DW-4820-S-24-SG-G	Double Face Starter	25 1/4"	19 1/2"	48"	8 1/2"	4	6			\$ 5,239	End, Mid, Top and Base Panels to be constructed from 1" thick 11-ply solid core, veneered 2 sides. Vertical, top and bottom edges banded with 1/4" external hardwood edging, edges to be eased. Front Edge: 3/4" thick x 2 1/2" high fascia - tongue and grooved to top.
	DW-4820-A-24-SG-G	Double Face Adder	24 1/4"	19 1/2"	48"	8 1/2"	4	6			\$ 4,602	
	DW-4824-S-24-SG-G	Double Face Starter	25 1/4"	23 1/2"	48"	10 1/2"	4	6			\$ 5,323	
	DW-4824-A-24-SG-G	Double Face Adder	24 1/4"	23 1/2"	48"	10 1/2"	4	6			\$ 4,664	
	DW-4828-S-24-SG-G	Double Face Starter	25 1/4"	28 1/2"	48"	13 1/2"	4	6			\$ 5,845	
	DW-4828-A-24-SG-G	Double Face Adder	24 1/4"	28 1/2"	48"	13 1/2"	4	6			\$ 5,115	
 <p>Model Shown DW-4224-A-36-SG-G</p>	DW-4820-S-30-SG-G	Double Face Starter	31 1/4"	19 1/2"	48"	8 1/2"	4	6			\$ 5,239	
	DW-4820-A-30-SG-G	Double Face Adder	30 1/4"	19 1/2"	48"	8 1/2"	4	6			\$ 4,602	
	DW-4824-S-30-SG-G	Double Face Starter	31 1/4"	23 1/2"	48"	10 1/2"	4	6			\$ 5,323	
	DW-4824-A-30-SG-G	Double Face Adder	30 1/4"	23 1/2"	48"	10 1/2"	4	6			\$ 4,664	
	DW-4828-S-30-SG-G	Double Face Starter	31 1/4"	28 1/2"	48"	13 1/2"	4	6			\$ 5,845	
	DW-4828-A-30-SG-G	Double Face Adder	30 1/4"	28 1/2"	48"	13 1/2"	4	6			\$ 5,115	
	DW-4820-S-36-SG-G	Double Face Starter	37 1/4"	19 1/2"	48"	8 1/2"	4	6	132 Lbs.	9 Cu Ft	\$ 4,968	
	DW-4820-A-36-SG-G	Double Face Adder	36 1/4"	19 1/2"	48"	8 1/2"	4	6	109 Lbs.	8 Cu Ft	\$ 4,329	
	DW-4824-S-36-SG-G	Double Face Starter	37 1/4"	23 1/2"	48"	10 1/2"	4	6	155 Lbs.	11 Cu Ft	\$ 5,053	
	DW-4824-A-36-SG-G	Double Face Adder	36 1/4"	23 1/2"	48"	10 1/2"	4	6	127 Lbs.	10 Cu Ft	\$ 4,392	
	DW-4828-S-36-SG-G	Double Face Starter	37 1/4"	28 1/2"	48"	13 1/2"	4	6	178 Lbs.	13 Cu Ft	\$ 5,573	
	DW-4828-A-36-SG-G	Double Face Adder	36 1/4"	28 1/2"	48"	13 1/2"	4	6	144 Lbs.	12 Cu Ft	\$ 4,844	
 <p>Model Shown DW-6024-S-36-SG-G</p>	DW-6020-S-24-SG-G	Double Face Starter	25 1/4"	19 1/2"	60"	8 1/2"	6	8			\$ 6,692	
	DW-6020-A-24-SG-G	Double Face Adder	24 1/4"	19 1/2"	60"	8 1/2"	6	8			\$ 6,063	
	DW-6024-S-24-SG-G	Double Face Starter	25 1/4"	23 1/2"	60"	10 1/2"	6	8			\$ 6,794	
	DW-6024-A-24-SG-G	Double Face Adder	24 1/4"	23 1/2"	60"	10 1/2"	6	8			\$ 6,157	
	DW-6028-S-24-SG-G	Double Face Starter	25 1/4"	28 1/2"	60"	13 1/2"	6	8			\$ 7,400	
	DW-6028-A-24-SG-G	Double Face Adder	24 1/4"	28 1/2"	60"	13 1/2"	6	8			\$ 6,685	
 <p>Model Shown DW-6024-A-36-SG-G</p>	DW-6020-S-30-SG-G	Double Face Starter	31 1/4"	19 1/2"	60"	8 1/2"	6	8			\$ 6,692	
	DW-6020-A-30-SG-G	Double Face Adder	30 1/4"	19 1/2"	60"	8 1/2"	6	8			\$ 6,063	
	DW-6024-S-30-SG-G	Double Face Starter	31 1/4"	23 1/2"	60"	10 1/2"	6	8			\$ 6,794	
	DW-6024-A-30-SG-G	Double Face Adder	30 1/4"	23 1/2"	60"	10 1/2"	6	8			\$ 6,157	
	DW-6028-S-30-SG-G	Double Face Starter	31 1/4"	28 1/2"	60"	13 1/2"	6	8			\$ 7,400	
	DW-6028-A-30-SG-G	Double Face Adder	30 1/4"	28 1/2"	60"	13 1/2"	6	8			\$ 6,685	
 <p>Model Shown DW-6024-S-36-SG-G</p>	DW-6020-S-36-SG-G	Double Face Starter	37 1/4"	19 1/2"	60"	8 1/2"	6	8	176 Lbs.	11 Cu Ft	\$ 6,437	
	DW-6020-A-36-SG-G	Double Face Adder	36 1/4"	19 1/2"	60"	8 1/2"	6	8	145 Lbs.	10 Cu Ft	\$ 5,799	
	DW-6024-S-36-SG-G	Double Face Starter	37 1/4"	23 1/2"	60"	10 1/2"	6	8	200 Lbs.	12 Cu Ft	\$ 6,530	
	DW-6024-A-36-SG-G	Double Face Adder	36 1/4"	23 1/2"	60"	10 1/2"	6	8	164 Lbs.	11 Cu Ft	\$ 5,899	
	DW-6028-S-36-SG-G	Double Face Starter	37 1/4"	28 1/2"	60"	13 1/2"	6	8	224 Lbs.	13 Cu Ft	\$ 7,137	
	DW-6028-A-36-SG-G	Double Face Adder	36 1/4"	28 1/2"	60"	13 1/2"	6	8	184 Lbs.	12 Cu Ft	\$ 6,422	









MODEL NUMBER	PRODUCT	WIDTH	DEPTH	HEIGHT	SHELF DEPTH	# OF SHELVES	# OF OPENINGS	WEIGHT	VOLUME	LIST PRICE	DESCRIPTION	
 Model Shown DW-7224-S-36-SG-G	DW-7220-S-24-SG-G	Double Face Starter	25 1/4"	19 1/2"	72"	8 1/2"	8	10		\$ 6,972	End, Mid, Top and Base Panels to be constructed from 1" thick 11-ply solid core, veneered 2 sides. Vertical, top and bottom edges banded with 1/4" external hardwood edging, edges to be eased. Front Edge: 3/4" thick x 2 1/2" high fascia - tongue and grooved to top.	
	DW-7220-A-24-SG-G	Double Face Adder	24 1/4"	19 1/2"	72"	8 1/2"	8	10		\$ 6,328		
	DW-7224-S-24-SG-G	Double Face Starter	25 1/4"	23 1/2"	72"	10 1/2"	8	10		\$ 7,090		
	DW-7224-A-24-SG-G	Double Face Adder	24 1/4"	23 1/2"	72"	10 1/2"	8	10		\$ 6,443		
	DW-7228-S-24-SG-G	Double Face Starter	25 1/4"	28 1/2"	72"	13 1/2"	8	10		\$ 7,758		
	DW-7228-A-24-SG-G	Double Face Adder	24 1/4"	28 1/2"	72"	13 1/2"	8	10		\$ 7,058		
 Model Shown DW-7224-A-36-SG-G	DW-7220-S-30-SG-G	Double Face Starter	31 1/4"	19 1/2"	72"	8 1/2"	8	10		\$ 6,972		
	DW-7220-A-30-SG-G	Double Face Adder	30 1/4"	19 1/2"	72"	8 1/2"	8	10		\$ 6,328		
	DW-7224-S-30-SG-G	Double Face Starter	31 1/4"	23 1/2"	72"	10 1/2"	8	10		\$ 7,090		
	DW-7224-A-30-SG-G	Double Face Adder	30 1/4"	23 1/2"	72"	10 1/2"	8	10		\$ 6,443		
	DW-7228-S-30-SG-G	Double Face Starter	31 1/4"	28 1/2"	72"	13 1/2"	8	10		\$ 7,758		
	DW-7228-A-30-SG-G	Double Face Adder	30 1/4"	28 1/2"	72"	13 1/2"	8	10		\$ 7,058		
 Model Shown DW-7224-A-36-SG-G	DW-7220-S-36-SG-G	Double Face Starter	37 1/4"	19 1/2"	72"	8 1/2"	8	10	200 Lbs.	12 Cu Ft		\$ 6,709
	DW-7220-A-36-SG-G	Double Face Adder	36 1/4"	19 1/2"	72"	8 1/2"	8	10	164 Lbs.	11 Cu Ft		\$ 6,070
	DW-7224-S-36-SG-G	Double Face Starter	37 1/4"	23 1/2"	72"	10 1/2"	8	10	229 Lbs.	13 Cu Ft		\$ 6,826
	DW-7224-A-36-SG-G	Double Face Adder	36 1/4"	23 1/2"	72"	10 1/2"	8	10	186 Lbs.	12 Cu Ft		\$ 6,187
	DW-7228-S-36-SG-G	Double Face Starter	37 1/4"	28 1/2"	72"	13 1/2"	8	10	256 Lbs.	14 Cu Ft		\$ 7,501
	DW-7228-A-36-SG-G	Double Face Adder	36 1/4"	28 1/2"	72"	13 1/2"	8	10	207 Lbs.	13 Cu Ft		\$ 6,794
 Model Shown DW-8224-S-36-SG-G	DW-8220-S-24-SG-G	Double Face Starter	25 1/4"	19 1/2"	82"	8 1/2"	10	12		\$ 7,229		
	DW-8220-A-24-SG-G	Double Face Adder	24 1/4"	19 1/2"	82"	8 1/2"	10	12		\$ 6,585		
	DW-8224-S-24-SG-G	Double Face Starter	25 1/4"	23 1/2"	82"	10 1/2"	10	12		\$ 7,376		
	DW-8224-A-24-SG-G	Double Face Adder	24 1/4"	23 1/2"	82"	10 1/2"	10	12		\$ 6,755		
	DW-8228-S-24-SG-G	Double Face Starter	25 1/4"	28 1/2"	82"	13 1/2"	10	12		\$ 8,443		
	DW-8228-A-24-SG-G	Double Face Adder	24 1/4"	28 1/2"	82"	13 1/2"	10	12		\$ 7,573		
 Model Shown DW-8224-S-36-SG-G	DW-8220-S-30-SG-G	Double Face Starter	31 1/4"	19 1/2"	82"	8 1/2"	10	12		\$ 7,229		
	DW-8220-A-30-SG-G	Double Face Adder	30 1/4"	19 1/2"	82"	8 1/2"	10	12		\$ 6,585		
	DW-8224-S-30-SG-G	Double Face Starter	31 1/4"	23 1/2"	82"	10 1/2"	10	12		\$ 7,376		
	DW-8224-A-30-SG-G	Double Face Adder	30 1/4"	23 1/2"	82"	10 1/2"	10	12		\$ 6,755		
	DW-8228-S-30-SG-G	Double Face Starter	31 1/4"	28 1/2"	82"	13 1/2"	10	12		\$ 8,443		
	DW-8228-A-30-SG-G	Double Face Adder	30 1/4"	28 1/2"	82"	13 1/2"	10	12		\$ 7,573		
 Model Shown DW-8224-A-36-SG-G	DW-8220-S-36-SG-G	Double Face Starter	37 1/4"	19 1/2"	82"	8 1/2"	10	12	224 Lbs.	12 Cu Ft	\$ 6,972	
	DW-8220-A-36-SG-G	Double Face Adder	36 1/4"	19 1/2"	82"	8 1/2"	10	12	184 Lbs.	11 Cu Ft	\$ 6,335	
	DW-8224-S-36-SG-G	Double Face Starter	37 1/4"	23 1/2"	82"	10 1/2"	10	12	256 Lbs.	14 Cu Ft	\$ 7,144	
	DW-8224-A-36-SG-G	Double Face Adder	36 1/4"	23 1/2"	82"	10 1/2"	10	12	207 Lbs.	12 Cu Ft	\$ 6,492	
	DW-8228-S-36-SG-G	Double Face Starter	37 1/4"	28 1/2"	82"	13 1/2"	10	12	289 Lbs.	16 Cu Ft	\$ 8,178	
	DW-8228-A-36-SG-G	Double Face Adder	36 1/4"	28 1/2"	82"	13 1/2"	10	12	230 Lbs.	14 Cu Ft	\$ 7,307	

	MODEL NUMBER	PRODUCT	WIDTH	DEPTH	HEIGHT	SHELF DEPTH	# OF SHELVES	# OF OPENINGS	WEIGHT	VOLUME	LIST PRICE	DESCRIPTION
	DW-9620-S-24-SG-G	Double Face Starter	25 1/4"	19 1/2"	96"	8 1/2"	12	14			\$ 7,874	End, Mid, Top and Base Panels to be constructed from 1" thick 11-ply solid core, veneered 2 sides. Vertical, top and bottom edges banded with 1/4" external hardwood edging, edges to be eased. Front Edge: 3/4" thick x 2 1/2" high fascia - tongue and grooved to top.
	DW-9620-A-24-SG-G	Double Face Adder	24 1/4"	19 1/2"	96"	8 1/2"	12	14			\$ 7,214	
	DW-9624-S-24-SG-G	Double Face Starter	25 1/4"	23 1/2"	96"	10 1/2"	12	14			\$ 8,209	
	DW-9624-A-24-SG-G	Double Face Adder	24 1/4"	23 1/2"	96"	10 1/2"	12	14			\$ 7,549	
	DW-9628-S-24-SG-G	Double Face Starter	25 1/4"	28 1/2"	96"	13 1/2"	12	14			\$ 9,243	
	DW-9628-A-24-SG-G	Double Face Adder	24 1/4"	28 1/2"	96"	13 1/2"	12	14			\$ 8,340	
	DW-9620-S-30-SG-G	Double Face Starter	31 1/4"	19 1/2"	96"	8 1/2"	12	14			\$ 7,874	
	DW-9620-A-30-SG-G	Double Face Adder	30 1/4"	19 1/2"	96"	8 1/2"	12	14			\$ 7,214	
	DW-9624-S-30-SG-G	Double Face Starter	31 1/4"	23 1/2"	96"	10 1/2"	12	14			\$ 8,209	
	DW-9624-A-30-SG-G	Double Face Adder	30 1/4"	23 1/2"	96"	10 1/2"	12	14			\$ 7,549	
	DW-9628-S-30-SG-G	Double Face Starter	31 1/4"	28 1/2"	96"	13 1/2"	12	14			\$ 9,243	
	DW-9628-A-30-SG-G	Double Face Adder	30 1/4"	28 1/2"	96"	13 1/2"	12	14			\$ 8,340	
	DW-9620-S-36-SG-G	Double Face Starter	37 1/4"	19 1/2"	96"	8 1/2"	12	14	276 Lbs.	13 Cu Ft	\$ 7,501	
	DW-9620-A-36-SG-G	Double Face Adder	36 1/4"	19 1/2"	96"	8 1/2"	12	14	220 Lbs.	12 Cu Ft	\$ 6,872	
	DW-9624-S-36-SG-G	Double Face Starter	37 1/4"	23 1/2"	96"	10 1/2"	12	14	315 Lbs.	15 Cu Ft	\$ 7,821	
	DW-9624-A-36-SG-G	Double Face Adder	36 1/4"	23 1/2"	96"	10 1/2"	12	14	247 Lbs.	13 Cu Ft	\$ 7,044	
	DW-9628-S-36-SG-G	Double Face Starter	37 1/4"	28 1/2"	96"	13 1/2"	12	14	353 Lbs.	17 Cu Ft	\$ 8,799	
	DW-9628-A-36-SG-G	Double Face Adder	36 1/4"	28 1/2"	96"	13 1/2"	12	14	275 Lbs.	15 Cu Ft	\$ 7,945	

Model Shown  
DW-9624-S-36-SG-G

Model Shown  
DW-9624-A-36-SG-G

	MODEL NUMBER	PRODUCT	WIDTH	DEPTH	HEIGHT	SHELF DEPTH	# OF SHELVES	# OF OPENINGS	WEIGHT	VOLUME	LIST PRICE	DESCRIPTION
 Model Shown DW-3612-S-M-36	DW-3612-S-M-24	Single Face Starter	25 1/4"	12 1/8"	36"		1	2			\$ 1,834	End, Mid, Top and Base Panels to be constructed from 1" thick 11-ply solid core, veneered 2 sides. Vertical, top and bottom edges banded with 1/4" external hardwood edging, edges to be eased. Front Edge: 3/4" thick x 2 1/2" high fascia - tongue and grooved to top.
	DW-3612-A-M-24	Single Face Adder	24 1/4"	12 1/8"	36"		1	2			\$ 1,439	
	DW-3612-S-M-30	Single Face Starter	31 1/4"	12 1/8"	36"		1	2			\$ 1,834	
	DW-3612-A-M-30	Single Face Adder	30 1/4"	12 1/8"	36"		1	2			\$ 1,439	
	DW-3612-S-M-36	Single Face Starter	37 1/4"	12 1/8"	36"		1	2	80.5 Lbs.	6 Cu Ft	\$ 1,648	
	DW-3612-A-M-36	Single Face Adder	36 1/4"	12 1/8"	36"		1	2	77.1 Lbs.	6 Cu Ft	\$ 1,259	
 Model Shown DW-3612-A-M-36	DW-4212-S-M-24	Single Face Starter	25 1/4"	12 1/8"	42"		2	3			\$ 2,162	
	DW-4212-A-M-24	Single Face Adder	24 1/4"	12 1/8"	42"		2	3			\$ 1,765	
	DW-4212-S-M-30	Single Face Starter	31 1/4"	12 1/8"	42"		2	3			\$ 2,162	
	DW-4212-A-M-30	Single Face Adder	30 1/4"	12 1/8"	42"		2	3			\$ 1,765	
	DW-4212-S-M-36	Single Face Starter	37 1/4"	12 1/8"	42"		2	3	82.5 Lbs.	7 Cu Ft	\$ 1,976	
	DW-4212-A-M-36	Single Face Adder	36 1/4"	12 1/8"	42"		2	3	80 Lbs.	7 Cu Ft	\$ 1,586	
 Model Shown DW-4212-S-M-36	DW-4812-S-M-24	Single Face Starter	25 1/4"	12 1/8"	48"		2	3			\$ 2,162	
	DW-4812-A-M-24	Single Face Adder	24 1/4"	12 1/8"	48"		2	3			\$ 1,765	
	DW-4812-S-M-30	Single Face Starter	31 1/4"	12 1/8"	48"		2	3			\$ 2,162	
	DW-4812-A-M-30	Single Face Adder	30 1/4"	12 1/8"	48"		2	3			\$ 1,765	
	DW-4812-S-M-36	Single Face Starter	37 1/4"	12 1/8"	48"		2	3	128 Lbs.	7 Cu Ft	\$ 1,976	
	DW-4812-A-M-36	Single Face Adder	36 1/4"	12 1/8"	48"		2	3	116 Lbs.	7 Cu Ft	\$ 1,586	
 Model Shown DW-4212-A-M-36	DW-6012-S-M-24	Single Face Starter	25 1/4"	12 1/8"	60"		3	4			\$ 2,481	
	DW-6012-A-M-24	Single Face Adder	24 1/4"	12 1/8"	60"		3	4			\$ 2,091	
	DW-6012-S-M-30	Single Face Starter	31 1/4"	12 1/8"	60"		3	4			\$ 2,481	
	DW-6012-A-M-30	Single Face Adder	30 1/4"	12 1/8"	60"		3	4			\$ 2,091	
	DW-6012-S-M-36	Single Face Starter	37 1/4"	12 1/8"	60"		3	4	176 Lbs.	10 Cu Ft	\$ 2,293	
	DW-6012-A-M-36	Single Face Adder	36 1/4"	12 1/8"	60"		3	4	155 Lbs.	9 Cu Ft	\$ 1,904	
 Model Shown DW-6012-S-M-36	DW-6012-S-M-36	Single Face Starter	37 1/4"	12 1/8"	60"		3	4	176 Lbs.	10 Cu Ft	\$ 2,293	
	DW-6012-A-M-36	Single Face Adder	36 1/4"	12 1/8"	60"		3	4	155 Lbs.	9 Cu Ft	\$ 1,904	
	DW-6012-S-M-36	Single Face Starter	37 1/4"	12 1/8"	60"		3	4	176 Lbs.	10 Cu Ft	\$ 2,293	
	DW-6012-A-M-36	Single Face Adder	36 1/4"	12 1/8"	60"		3	4	155 Lbs.	9 Cu Ft	\$ 1,904	
	DW-6012-S-M-36	Single Face Starter	37 1/4"	12 1/8"	60"		3	4	176 Lbs.	10 Cu Ft	\$ 2,293	
	DW-6012-A-M-36	Single Face Adder	36 1/4"	12 1/8"	60"		3	4	155 Lbs.	9 Cu Ft	\$ 1,904	
 Model Shown DW-6012-A-M-36	DW-6012-S-M-36	Single Face Starter	37 1/4"	12 1/8"	60"		3	4	176 Lbs.	10 Cu Ft	\$ 2,293	
	DW-6012-A-M-36	Single Face Adder	36 1/4"	12 1/8"	60"		3	4	155 Lbs.	9 Cu Ft	\$ 1,904	
	DW-6012-S-M-36	Single Face Starter	37 1/4"	12 1/8"	60"		3	4	176 Lbs.	10 Cu Ft	\$ 2,293	
	DW-6012-A-M-36	Single Face Adder	36 1/4"	12 1/8"	60"		3	4	155 Lbs.	9 Cu Ft	\$ 1,904	
	DW-6012-S-M-36	Single Face Starter	37 1/4"	12 1/8"	60"		3	4	176 Lbs.	10 Cu Ft	\$ 2,293	
	DW-6012-A-M-36	Single Face Adder	36 1/4"	12 1/8"	60"		3	4	155 Lbs.	9 Cu Ft	\$ 1,904	

MODEL NUMBER	PRODUCT	WIDTH	DEPTH	HEIGHT	SHELF DEPTH	# OF SHELVES	# OF OPENINGS	WEIGHT	VOLUME	LIST PRICE	DESCRIPTION
DW-7212-S-M-24	Single Face Starter	25 1/4"	12 1/8"	72"		4	5			\$ 2,815	End, Mid, Top and Base Panels to be constructed from 1" thick 11-ply solid core, veneered 2 sides. Vertical, top and bottom edges banded with 1/4" external hardwood edging, edges to be eased. Front Edge: 3/4" thick x 2 1/2" high fascia - tongue and grooved to top.
DW-7212-A-M-24	Single Face Adder	24 1/4"	12 1/8"	72"		4	5			\$ 2,417	
DW-7212-S-M-30	Single Face Starter	31 1/4"	12 1/8"	72"		4	5			\$ 2,815	
DW-7212-A-M-30	Single Face Adder	30 1/4"	12 1/8"	72"		4	5			\$ 2,417	
DW-7212-S-M-36	Single Face Starter	37 1/4"	12 1/8"	72"		4	5	206 Lbs.	11 Cu Ft	\$ 2,636	
DW-7212-A-M-36	Single Face Adder	36 1/4"	12 1/8"	72"		4	5	184 Lbs.	10 Cu Ft	\$ 2,239	



Model Shown  
DW-7212-S-M-36



Model Shown  
DW-7212-A-M-36







DW-8212-S-M-24	Single Face Starter	25 1/4"	12 1/8"	82"		5	6			\$ 3,165	
DW-8212-A-M-24	Single Face Adder	24 1/4"	12 1/8"	82"		5	6			\$ 2,746	
DW-8212-S-M-30	Single Face Starter	31 1/4"	12 1/8"	82"		5	6			\$ 3,165	
DW-8212-A-M-30	Single Face Adder	30 1/4"	12 1/8"	82"		5	6			\$ 2,746	
DW-8212-S-M-36	Single Face Starter	37 1/4"	12 1/8"	82"		5	6	236 Lbs.	12 Cu Ft	\$ 3,000	
DW-8212-A-M-36	Single Face Adder	36 1/4"	12 1/8"	82"		5	6	213 Lbs.	11 Cu Ft	\$ 2,589	



Model Shown  
DW-8212-S-M-36



Model Shown  
DW-8212-A-M-36

	MODEL NUMBER	PRODUCT	WIDTH	DEPTH	HEIGHT	SHELF DEPTH	# OF SHELVES	# OF OPENINGS	WEIGHT	VOLUME	LIST PRICE	DESCRIPTION	
 <p>Model Shown DW-3624-S-M-36</p>	DW-3624-S-M-24	Double Face Starter	25 1/4"	23 1/2"	36"		2	4			\$ 3,288	End, Mid, Top and Base Panels to be constructed from 1" thick 11-ply solid core, veneered 2 sides. Vertical, top and bottom edges banded with 1/4" external hardwood edging, edges to be eased. Front Edge: 3/4" thick x 2 1/2" high fascia - tongue and grooved to top.	
	DW-3624-A-M-24	Double Face Adder	24 1/4"	23 1/2"	36"		2	4			\$ 2,619		
	DW-3624-S-M-30	Double Face Starter	31 1/4"	23 1/2"	36"		2	4			\$ 3,288		
	DW-3624-A-M-30	Double Face Adder	30 1/4"	23 1/2"	36"		2	4			\$ 2,619		
	DW-3624-S-M-36	Double Face Starter	37 1/4"	23 1/2"	36"		2	4	170 Lbs.	12 Cu Ft	\$ 3,010		
	DW-3624-A-M-36	Double Face Adder	36 1/4"	23 1/2"	36"		2	4	148 Lbs.	11 Cu Ft	\$ 2,339		
 <p>Model Shown DW-3624-A-M-36</p>													
 <p>Model Shown DW-4224-S-M-36</p>	DW-4224-S-M-24	Double Face Starter	25 1/4"	23 1/2"	42"		4	6			\$ 3,949		
	DW-4224-A-M-24	Double Face Adder	24 1/4"	23 1/2"	42"		4	6			\$ 3,273		
	DW-4224-S-M-30	Double Face Starter	31 1/4"	23 1/2"	42"		4	6			\$ 3,949		
	DW-4224-A-M-30	Double Face Adder	30 1/4"	23 1/2"	42"		4	6			\$ 3,273		
	DW-4224-S-M-36	Double Face Starter	37 1/4"	23 1/2"	42"		4	6	180 Lbs.	13 Cu Ft	\$ 3,670		
	DW-4224-A-M-36	Double Face Adder	36 1/4"	23 1/2"	42"		4	6	158 Lbs.	12 Cu Ft	\$ 3,000		
 <p>Model Shown DW-4224-A-M-36</p>	DW-4824-S-M-24	Double Face Starter	25 1/4"	23 1/2"	48"		4	6			\$ 3,949		
	DW-4824-A-M-24	Double Face Adder	24 1/4"	23 1/2"	48"		4	6			\$ 3,273		
	DW-4824-S-M-30	Double Face Starter	31 1/4"	23 1/2"	48"		4	6			\$ 3,949		
	DW-4824-A-M-30	Double Face Adder	30 1/4"	23 1/2"	48"		4	6			\$ 3,273		
	DW-4824-S-M-36	Double Face Starter	37 1/4"	23 1/2"	48"		4	6	245 Lbs.	14 Cu Ft	\$ 3,670		
	DW-4824-A-M-36	Double Face Adder	36 1/4"	23 1/2"	48"		4	6	216 Lbs.	13 Cu Ft	\$ 3,000		
 <p>Model Shown DW-6024-S-M-36</p>	DW-6024-S-M-24	Double Face Starter	25 1/4"	23 1/2"	60"		6	8			\$ 4,563		
	DW-6024-A-M-24	Double Face Adder	24 1/4"	23 1/2"	60"		6	8			\$ 3,894		
	DW-6024-S-M-30	Double Face Starter	31 1/4"	23 1/2"	60"		6	8			\$ 4,563		
	DW-6024-A-M-30	Double Face Adder	30 1/4"	23 1/2"	60"		6	8			\$ 3,894		
	DW-6024-S-M-36	Double Face Starter	37 1/4"	23 1/2"	60"		6	8	320 Lbs.	16 Cu Ft	\$ 4,292		
	DW-6024-A-M-36	Double Face Adder	36 1/4"	23 1/2"	60"		6	8	284 Lbs.	15 Cu Ft	\$ 3,614		
 <p>Model Shown DW-6024-A-M-36</p>													



MODEL NUMBER	PRODUCT	WIDTH	DEPTH	HEIGHT	SHELF DEPTH	# OF SHELVES	# OF OPENINGS	WEIGHT	VOLUME	LIST PRICE	DESCRIPTION
DW-7224-S-M-24	Double Face Starter	25 1/4"	23 1/2"	72"		8	10			\$ 5,216	End, Mid, Top and Base Panels to be constructed from 1" thick 11-ply solid core, veneered 2 sides. Vertical, top and bottom edges banded with 1/4" external hardwood edging, edges to be eased. Front Edge: 3/4" thick x 2 1/2" high fascia - tongue and grooved to top.
DW-7224-A-M-24	Double Face Adder	24 1/4"	23 1/2"	72"		8	10			\$ 4,540	
DW-7224-S-M-30	Double Face Starter	31 1/4"	23 1/2"	72"		8	10			\$ 5,216	
DW-7224-A-M-30	Double Face Adder	30 1/4"	23 1/2"	72"		8	10			\$ 4,540	
DW-7224-S-M-36	Double Face Starter	37 1/4"	23 1/2"	72"		8	10	378 Lbs.	18 Cu Ft	\$ 4,936	
DW-7224-A-M-36	Double Face Adder	36 1/4"	23 1/2"	72"		8	10	336 Lbs.	17 Cu Ft	\$ 4,260	



Model Shown  
DW-7224-S-M-36



Model Shown  
DW-7224-A-M-36







DW-8224-S-M-24	Double Face Starter	25 1/4"	23 1/2"	82"		10	12			\$ 5,909	
DW-8224-A-M-24	Double Face Adder	24 1/4"	23 1/2"	82"		10	12			\$ 5,210	
DW-8224-S-M-30	Double Face Starter	31 1/4"	23 1/2"	82"		10	12			\$ 5,909	
DW-8224-A-M-30	Double Face Adder	30 1/4"	23 1/2"	82"		10	12			\$ 5,210	
DW-8224-S-M-36	Double Face Starter	37 1/4"	23 1/2"	82"		10	12	436 Lbs.	20 Cu Ft	\$ 5,568	
DW-8224-A-M-36	Double Face Adder	36 1/4"	23 1/2"	82"		10	12	388 Lbs.	19 Cu Ft	\$ 4,937	









Model Shown  
DW-8224-S-M-36



Model Shown  
DW-8224-A-M-36

	MODEL NUMBER	PRODUCT	WIDTH	DEPTH	HEIGHT	SHELF DEPTH	# OF SHELVES	# OF OPENINGS	WEIGHT	VOLUME	LIST PRICE	DESCRIPTION
 Model Shown DW-3612-S-M-36-IPT	DW-3612-S-M-24-IPT	Single Face Starter	25 1/4"	12 1/8"	36"		1	2			\$ 1,929	End, Mid, Top and Base Panels to be constructed from 1" thick 11-ply solid core, veneered 2 sides. Vertical, top and bottom edges banded with 1/4" external hardwood edging, edges to be eased. Front Edge: 3/4" thick x 2 1/2" high fascia - tongue and grooved to top.
	DW-3612-A-M-24-IPT	Single Face Adder	24 1/4"	12 1/8"	36"		1	2			\$ 1,531	
	DW-3612-S-M-30-IPT	Single Face Starter	31 1/4"	12 1/8"	36"		1	2			\$ 1,929	
	DW-3612-A-M-30-IPT	Single Face Adder	30 1/4"	12 1/8"	36"		1	2			\$ 1,531	
	DW-3612-S-M-36-IPT	Single Face Starter	37 1/4"	12 1/8"	36"		1	2	80.5 Lbs.	6 Cu Ft	\$ 1,741	
	DW-3612-A-M-36-IPT	Single Face Adder	36 1/4"	12 1/8"	36"		1	2	77.1 Lbs.	6 Cu Ft	\$ 1,344	
 Model Shown DW-3612-A-M-36-IPT	DW-4212-S-M-24-IPT	Single Face Starter	25 1/4"	12 1/8"	42"		2	3			\$ 2,254	
	DW-4212-A-M-24-IPT	Single Face Adder	24 1/4"	12 1/8"	42"		2	3			\$ 1,858	
	DW-4212-S-M-30-IPT	Single Face Starter	31 1/4"	12 1/8"	42"		2	3			\$ 2,254	
	DW-4212-A-M-30-IPT	Single Face Adder	30 1/4"	12 1/8"	42"		2	3			\$ 1,858	
	DW-4212-S-M-36-IPT	Single Face Starter	37 1/4"	12 1/8"	42"		2	3	82.5 Lbs.	7 Cu Ft	\$ 2,069	
	DW-4212-A-M-36-IPT	Single Face Adder	36 1/4"	12 1/8"	42"		2	3	80 Lbs.	7 Cu Ft	\$ 1,680	
 Model Shown DW-4212-S-M-36-IPT	DW-4812-S-M-24-IPT	Single Face Starter	25 1/4"	12 1/8"	48"		2	3			\$ 2,254	
	DW-4812-A-M-24-IPT	Single Face Adder	24 1/4"	12 1/8"	48"		2	3			\$ 1,858	
	DW-4812-S-M-30-IPT	Single Face Starter	31 1/4"	12 1/8"	48"		2	3			\$ 2,254	
	DW-4812-A-M-30-IPT	Single Face Adder	30 1/4"	12 1/8"	48"		2	3			\$ 1,858	
	DW-4812-S-M-36-IPT	Single Face Starter	37 1/4"	12 1/8"	48"		2	3	128 Lbs.	7 Cu Ft	\$ 2,069	
	DW-4812-A-M-36-IPT	Single Face Adder	36 1/4"	12 1/8"	48"		2	3	116 Lbs.	7 Cu Ft	\$ 1,680	
 Model Shown DW-4212-A-M-36-IPT	DW-6012-S-M-24-IPT	Single Face Starter	25 1/4"	12 1/8"	60"		3	4			\$ 2,574	
	DW-6012-A-M-24-IPT	Single Face Adder	24 1/4"	12 1/8"	60"		3	4			\$ 2,184	
	DW-6012-S-M-30-IPT	Single Face Starter	31 1/4"	12 1/8"	60"		3	4			\$ 2,574	
	DW-6012-A-M-30-IPT	Single Face Adder	30 1/4"	12 1/8"	60"		3	4			\$ 2,184	
	DW-6012-S-M-36-IPT	Single Face Starter	37 1/4"	12 1/8"	60"		3	4	176 Lbs.	10 Cu Ft	\$ 2,387	
	DW-6012-A-M-36-IPT	Single Face Adder	36 1/4"	12 1/8"	60"		3	4	155 Lbs.	9 Cu Ft	\$ 1,998	
 Model Shown DW-6012-S-M-36-IPT												
 Model Shown DW-6012-A-M-36-IPT												

	MODEL NUMBER	PRODUCT	WIDTH	DEPTH	HEIGHT	SHELF DEPTH	# OF SHELVES	# OF OPENINGS	WEIGHT	VOLUME	LIST PRICE	DESCRIPTION
 <p>Model Shown DW-3624-S-M-36-IPT</p>	DW-3624-S-M-24-IPT	Double Face Starter	25 1/4"	23 1/2"	36"		2	4			\$ 3,475	End, Mid, Top and Base Panels to be constructed from 1" thick 11-ply solid core, veneered 2 sides. Vertical, top and bottom edges banded with 1/4" external hardwood edging, edges to be eased. Front Edge: 3/4" thick x 2 1/2" high fascia - tongue and grooved to top.
	DW-3624-A-M-24-IPT	Double Face Adder	24 1/4"	23 1/2"	36"		2	4			\$ 2,806	
	DW-3624-S-M-30-IPT	Double Face Starter	31 1/4"	23 1/2"	36"		2	4			\$ 3,475	
	DW-3624-A-M-30-IPT	Double Face Adder	30 1/4"	23 1/2"	36"		2	4			\$ 2,806	
	DW-3624-S-M-36-IPT	Double Face Starter	37 1/4"	23 1/2"	36"		2	4	170 Lbs.	12 Cu Ft	\$ 3,195	
	DW-3624-A-M-36-IPT	Double Face Adder	36 1/4"	23 1/2"	36"		2	4	148 Lbs.	11 Cu Ft	\$ 2,527	
 <p>Model Shown DW-3624-A-M-36-IPT</p>	DW-4224-S-M-24-IPT	Double Face Starter	25 1/4"	23 1/2"	42"		4	6			\$ 4,135	
	DW-4224-A-M-24-IPT	Double Face Adder	24 1/4"	23 1/2"	42"		4	6			\$ 3,458	
	DW-4224-S-M-30-IPT	Double Face Starter	31 1/4"	23 1/2"	42"		4	6			\$ 4,135	
	DW-4224-A-M-30-IPT	Double Face Adder	30 1/4"	23 1/2"	42"		4	6			\$ 3,458	
	DW-4224-S-M-36-IPT	Double Face Starter	37 1/4"	23 1/2"	42"		4	6	180 Lbs.	13 Cu Ft	\$ 4,120	
	DW-4224-A-M-36-IPT	Double Face Adder	36 1/4"	23 1/2"	42"		4	6	158 Lbs.	12 Cu Ft	\$ 3,180	
 <p>Model Shown DW-4224-S-M-36-IPT</p>	DW-4824-S-M-24-IPT	Double Face Starter	25 1/4"	23 1/2"	48"		4	6			\$ 4,339	
	DW-4824-A-M-24-IPT	Double Face Adder	24 1/4"	23 1/2"	48"		4	6			\$ 3,631	
	DW-4824-S-M-30-IPT	Double Face Starter	31 1/4"	23 1/2"	48"		4	6			\$ 4,339	
	DW-4824-A-M-30-IPT	Double Face Adder	30 1/4"	23 1/2"	48"		4	6			\$ 3,631	
	DW-4824-S-M-36-IPT	Double Face Starter	37 1/4"	23 1/2"	48"		4	6	245 Lbs.	14 Cu Ft	\$ 4,050	
	DW-4824-A-M-36-IPT	Double Face Adder	36 1/4"	23 1/2"	48"		4	6	216 Lbs.	13 Cu Ft	\$ 3,343	
 <p>Model Shown DW-4224-A-M-36-IPT</p>	DW-6024-S-M-24-IPT	Double Face Starter	25 1/4"	23 1/2"	60"		6	8			\$ 4,751	
	DW-6024-A-M-24-IPT	Double Face Adder	24 1/4"	23 1/2"	60"		6	8			\$ 4,080	
	DW-6024-S-M-30-IPT	Double Face Starter	31 1/4"	23 1/2"	60"		6	8			\$ 4,751	
	DW-6024-A-M-30-IPT	Double Face Adder	30 1/4"	23 1/2"	60"		6	8			\$ 4,080	
	DW-6024-S-M-36-IPT	Double Face Starter	37 1/4"	23 1/2"	60"		6	8	320 Lbs.	16 Cu Ft	\$ 4,477	
	DW-6024-A-M-36-IPT	Double Face Adder	36 1/4"	23 1/2"	60"		6	8	284 Lbs.	15 Cu Ft	\$ 3,801	
 <p>Model Shown DW-6024-S-M-36-IPT</p>												
 <p>Model Shown DW-6024-A-M-36-IPT</p>												

MODEL NUMBER	PRODUCT	WIDTH	DEPTH	HEIGHT	SHELF DEPTH	# OF SHELVES	# OF OPENINGS	WEIGHT	VOLUME	LIST PRICE	DESCRIPTION
--------------	---------	-------	-------	--------	-------------	--------------	---------------	--------	--------	------------	-------------

DW-3612-S-P-24	Single Face Starter	25 <sup>1</sup> / <sub>4</sub> "	12 <sup>1</sup> / <sub>8</sub> "	36"		1	2			\$ 1,610	End, Mid, Top and Base Panels to be constructed from 1" thick 11-ply solid core, veneered 2 sides. Vertical, top and bottom edges banded with <sup>1</sup> / <sub>4</sub> " external hardwood edging, edges to be eased. Front Edge: <sup>3</sup> / <sub>4</sub> " thick x 2 <sup>1</sup> / <sub>2</sub> " high fascia - tongue and grooved to top.
DW-3612-A-P-24	Single Face Adder	24 <sup>1</sup> / <sub>4</sub> "	12 <sup>1</sup> / <sub>8</sub> "	36"		1	2			\$ 1,198	
DW-3612-S-P-30	Single Face Starter	31 <sup>1</sup> / <sub>4</sub> "	12 <sup>1</sup> / <sub>8</sub> "	36"		1	2			\$ 1,610	
DW-3612-A-P-30	Single Face Adder	30 <sup>1</sup> / <sub>4</sub> "	12 <sup>1</sup> / <sub>8</sub> "	36"		1	2			\$ 1,198	
DW-3612-S-P-36	Single Face Starter	37 <sup>1</sup> / <sub>4</sub> "	12 <sup>1</sup> / <sub>8</sub> "	36"		1	2	52.9 Lbs.	5 Cu Ft	\$ 1,454	
DW-3612-A-P-36	Single Face Adder	36 <sup>1</sup> / <sub>4</sub> "	12 <sup>1</sup> / <sub>8</sub> "	36"		1	2	49.5 Lbs.	5 Cu Ft	\$ 1,042	



Model Shown  
DW-3612-S-P-36



Model Shown  
DW-3612-A-P-36

DW-4212-S-P-24	Single Face Starter	25 <sup>1</sup> / <sub>4</sub> "	12 <sup>1</sup> / <sub>8</sub> "	42"		2	3			\$ 1,710	
DW-4212-A-P-24	Single Face Adder	24 <sup>1</sup> / <sub>4</sub> "	12 <sup>1</sup> / <sub>8</sub> "	42"		2	3			\$ 1,275	
DW-4212-S-P-30	Single Face Starter	31 <sup>1</sup> / <sub>4</sub> "	12 <sup>1</sup> / <sub>8</sub> "	42"		2	3			\$ 1,710	
DW-4212-A-P-30	Single Face Adder	30 <sup>1</sup> / <sub>4</sub> "	12 <sup>1</sup> / <sub>8</sub> "	42"		2	3			\$ 1,275	
DW-4212-S-P-36	Single Face Starter	37 <sup>1</sup> / <sub>4</sub> "	12 <sup>1</sup> / <sub>8</sub> "	42"		2	3	58 Lbs.	6 Cu Ft	\$ 1,547	
DW-4212-A-P-36	Single Face Adder	36 <sup>1</sup> / <sub>4</sub> "	12 <sup>1</sup> / <sub>8</sub> "	42"		2	3	56 Lbs.	6 Cu Ft	\$ 1,112	







Model Shown  
DW-4812-S-P-36





Model Shown  
DW-4812-A-P-36



DW-4812-S-P-24	Single Face Starter	25 <sup>1</sup> / <sub>4</sub> "	12 <sup>1</sup> / <sub>8</sub> "	48"		2	3			\$ 1,811	
DW-4812-A-P-24	Single Face Adder	24 <sup>1</sup> / <sub>4</sub> "	12 <sup>1</sup> / <sub>8</sub> "	48"		2	3			\$ 1,354	
DW-4812-S-P-30	Single Face Starter	31 <sup>1</sup> / <sub>4</sub> "	12 <sup>1</sup> / <sub>8</sub> "	48"		2	3			\$ 1,811	
DW-4812-A-P-30	Single Face Adder	30 <sup>1</sup> / <sub>4</sub> "	12 <sup>1</sup> / <sub>8</sub> "	48"		2	3			\$ 1,354	
DW-4812-S-P-36	Single Face Starter	37 <sup>1</sup> / <sub>4</sub> "	12 <sup>1</sup> / <sub>8</sub> "	48"		2	3	86.3 Lbs.	6 Cu Ft	\$ 1,617	
DW-4812-A-P-36	Single Face Adder	36 <sup>1</sup> / <sub>4</sub> "	12 <sup>1</sup> / <sub>8</sub> "	48"		2	3	74.8 Lbs.	6 Cu Ft	\$ 1,166	





MODEL NUMBER	PRODUCT	WIDTH	DEPTH	HEIGHT	SHELF DEPTH	# OF SHELVES	# OF OPENINGS	WEIGHT	VOLUME	LIST PRICE	DESCRIPTION
 Model Shown DW-3624-S-P-36	DW-3624-S-P-24	Double Face Starter	25 1/4"	23 1/2"	36"	2	4			\$ 2,722	End, Mid, Top and Base Panels to be constructed from 1" thick 11-ply solid core, veneered 2 sides. Vertical, top and bottom edges banded with 1/4" external hardwood edging, edges to be eased. Front Edge: 3/4" thick x 2 1/2" high fascia - tongue and grooved to top.
	DW-3624-A-P-24	Double Face Adder	24 1/4"	23 1/2"	36"	2	4			\$ 2,263	
	DW-3624-S-P-30	Double Face Starter	31 1/4"	23 1/2"	36"	2	4			\$ 2,722	
	DW-3624-A-P-30	Double Face Adder	30 1/4"	23 1/2"	36"	2	4			\$ 2,263	
	DW-3624-S-P-36	Double Face Starter	37 1/4"	23 1/2"	36"	2	4	115 Lbs.	10 Cu Ft	\$ 2,487	
	DW-3624-A-P-36	Double Face Adder	36 1/4"	23 1/2"	36"	2	4	93.2 Lbs.	9 Cu Ft	\$ 2,029	
 Model Shown DW-3624-A-P-36	DW-4224-S-P-24	Double Face Starter	25 1/4"	23 1/2"	42"	4	6			\$ 2,899	
	DW-4224-A-P-24	Double Face Adder	24 1/4"	23 1/2"	42"	4	6			\$ 2,410	
	DW-4224-S-P-30	Double Face Starter	31 1/4"	23 1/2"	42"	4	6			\$ 2,899	
	DW-4224-A-P-30	Double Face Adder	30 1/4"	23 1/2"	42"	4	6			\$ 2,410	
	DW-4224-S-P-36	Double Face Starter	37 1/4"	23 1/2"	42"	4	6	125 Lbs.	11 Cu Ft	\$ 2,643	
	DW-4224-A-P-36	Double Face Adder	36 1/4"	23 1/2"	42"	4	6	98 Lbs.	10 Cu Ft	\$ 2,162	
 Model Shown DW-4824-S-P-36	DW-4824-S-P-24	Double Face Starter	25 1/4"	23 1/2"	48"	4	6			\$ 3,219	
	DW-4824-A-P-24	Double Face Adder	24 1/4"	23 1/2"	48"	4	6			\$ 2,527	
	DW-4824-S-P-30	Double Face Starter	31 1/4"	23 1/2"	48"	4	6			\$ 3,219	
	DW-4824-A-P-30	Double Face Adder	30 1/4"	23 1/2"	48"	4	6			\$ 2,527	
	DW-4824-S-P-36	Double Face Starter	37 1/4"	23 1/2"	48"	4	6	162 Lbs.	11 Cu Ft	\$ 2,961	
	DW-4824-A-P-36	Double Face Adder	36 1/4"	23 1/2"	48"	4	6	133 Lbs.	10 Cu Ft	\$ 2,277	
 Model Shown DW-4824-A-P-36											

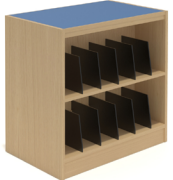

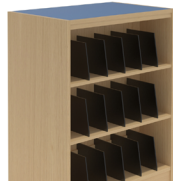
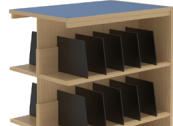



	MODEL NUMBER	PRODUCT	WIDTH	DEPTH	HEIGHT	SHELF DEPTH	# OF SHELVES	# OF OPENINGS	WEIGHT	VOLUME	LIST PRICE	DESCRIPTION
 <p>Model Shown DW-3612-S-P-36-IPT</p>	DW-3612-S-P-24-IPT	Single Face Starter	25 1/4"	12 1/8"	36"		1	2			\$ 1,703	End, Mid, Top and Base Panels to be constructed from 1" thick 11-ply solid core, veneered 2 sides. Vertical, top and bottom edges banded with 1/4" external hardwood edging, edges to be eased. Front Edge: 3/4" thick x 2 1/2" high fascia - tongue and grooved to top.
	DW-3612-A-P-24-IPT	Single Face Adder	24 1/4"	12 1/8"	36"		1	2			\$ 1,290	
	DW-3612-S-P-30-IPT	Single Face Starter	31 1/4"	12 1/8"	36"		1	2			\$ 1,703	
	DW-3612-A-P-30-IPT	Single Face Adder	30 1/4"	12 1/8"	36"		1	2			\$ 1,290	
	DW-3612-S-P-36-IPT	Single Face Starter	37 1/4"	12 1/8"	36"		1	2	52.9 Lbs.	5 Cu Ft	\$ 1,547	
	DW-3612-A-P-36-IPT	Single Face Adder	36 1/4"	12 1/8"	36"		1	2	49.5 Lbs.	5 Cu Ft	\$ 1,135	
 <p>Model Shown DW-3612-A-P-36-IPT</p>	DW-4212-S-P-24-IPT	Single Face Starter	25 1/4"	12 1/8"	42"		2	3			\$ 1,804	
	DW-4212-A-P-24-IPT	Single Face Adder	24 1/4"	12 1/8"	42"		2	3			\$ 1,369	
	DW-4212-S-P-30-IPT	Single Face Starter	31 1/4"	12 1/8"	42"		2	3			\$ 1,804	
	DW-4212-A-P-30-IPT	Single Face Adder	30 1/4"	12 1/8"	42"		2	3			\$ 1,369	
	DW-4212-S-P-36-IPT	Single Face Starter	37 1/4"	12 1/8"	42"		2	3	58 Lbs.	6 Cu Ft	\$ 1,641	
	DW-4212-A-P-36-IPT	Single Face Adder	36 1/4"	12 1/8"	42"		2	3	56 Lbs.	6 Cu Ft	\$ 1,205	
 <p>Model Shown DW-4812-S-P-36-IPT</p>	DW-4812-S-P-24-IPT	Single Face Starter	25 1/4"	12 1/8"	48"		2	3			\$ 1,904	
	DW-4812-A-P-24-IPT	Single Face Adder	24 1/4"	12 1/8"	48"		2	3			\$ 1,447	
	DW-4812-S-P-30-IPT	Single Face Starter	31 1/4"	12 1/8"	48"		2	3			\$ 1,904	
	DW-4812-A-P-30-IPT	Single Face Adder	30 1/4"	12 1/8"	48"		2	3			\$ 1,447	
	DW-4812-S-P-36-IPT	Single Face Starter	37 1/4"	12 1/8"	48"		2	3	86.3 Lbs.	6 Cu Ft	\$ 1,710	
	DW-4812-A-P-36-IPT	Single Face Adder	36 1/4"	12 1/8"	48"		2	3	74.8 Lbs.	6 Cu Ft	\$ 1,259	

Model Shown  
DW-4812-A-P-36-IPT





	MODEL NUMBER	PRODUCT	WIDTH	DEPTH	HEIGHT	SHELF DEPTH	# OF SHELVES	# OF OPENINGS	WEIGHT	VOLUME	LIST PRICE	DESCRIPTION
 <p>Model Shown DW-3624-S-P-36-IPT</p>	DW-3624-S-P-24-IPT	Double Face Starter	25 1/4"	23 1/2"	36"		2	4			\$ 2,907	End, Mid, Top and Base Panels to be constructed from 1" thick 11-ply solid core, veneered 2 sides. Vertical, top and bottom edges banded with 1/4" external hardwood edging, edges to be eased. Front Edge: 3/4" thick x 2 1/2" high fascia - tongue and grooved to top.
	DW-3624-A-P-24-IPT	Double Face Adder	24 1/4"	23 1/2"	36"		2	4			\$ 2,448	
	DW-3624-S-P-30-IPT	Double Face Starter	31 1/4"	23 1/2"	36"		2	4			\$ 2,907	
	DW-3624-A-P-30-IPT	Double Face Adder	30 1/4"	23 1/2"	36"		2	4			\$ 2,448	
	DW-3624-S-P-36-IPT	Double Face Starter	37 1/4"	23 1/2"	36"		2	4	115 Lbs.	10 Cu Ft	\$ 2,675	
	DW-3624-A-P-36-IPT	Double Face Adder	36 1/4"	23 1/2"	36"		2	4	93.2 Lbs.	9 Cu Ft	\$ 2,215	
 <p>Model Shown DW-3624-A-P-36-IPT</p>	DW-4224-S-P-24-IPT	Double Face Starter	25 1/4"	23 1/2"	42"		4	6			\$ 3,085	
	DW-4224-A-P-24-IPT	Double Face Adder	24 1/4"	23 1/2"	42"		4	6			\$ 2,598	
	DW-4224-S-P-30-IPT	Double Face Starter	31 1/4"	23 1/2"	42"		4	6			\$ 3,085	
	DW-4224-A-P-30-IPT	Double Face Adder	30 1/4"	23 1/2"	42"		4	6			\$ 2,598	
	DW-4224-S-P-36-IPT	Double Face Starter	37 1/4"	23 1/2"	42"		4	6	125 Lbs.	11 Cu Ft	\$ 2,829	
	DW-4224-A-P-36-IPT	Double Face Adder	36 1/4"	23 1/2"	42"		4	6	98 Lbs.	10 Cu Ft	\$ 2,348	
 <p>Model Shown DW-4824-S-P-36-IPT</p>	DW-4824-S-P-24-IPT	Double Face Starter	25 1/4"	23 1/2"	48"		4	6			\$ 3,405	
	DW-4824-A-P-24-IPT	Double Face Adder	24 1/4"	23 1/2"	48"		4	6			\$ 2,712	
	DW-4824-S-P-30-IPT	Double Face Starter	31 1/4"	23 1/2"	48"		4	6			\$ 3,405	
	DW-4824-A-P-30-IPT	Double Face Adder	30 1/4"	23 1/2"	48"		4	6			\$ 2,712	
	DW-4824-S-P-36-IPT	Double Face Starter	37 1/4"	23 1/2"	48"		4	6	162 Lbs.	11 Cu Ft	\$ 3,148	
	DW-4824-A-P-36-IPT	Double Face Adder	36 1/4"	23 1/2"	48"		4	6	133 Lbs.	10 Cu Ft	\$ 2,463	
 <p>Model Shown DW-4824-A-P-36-IPT</p>												

	MODEL NUMBER	PRODUCT	WIDTH	DEPTH	HEIGHT	SHELF DEPTH	# OF SHELVES	# OF OPENINGS	WEIGHT	VOLUME	LIST PRICE	DESCRIPTION
 <p>Model Shown DW-AF-4818-S-36</p>		A-Frame Shelving, Single Face										
	DW-AF-4818-S-36	Starter	37 <sup>3</sup> / <sub>8</sub> "	18"	48"	5 <sup>3</sup> / <sub>8</sub> "	3	4			\$ 1,811	
	DW-AF-4818-A-36	Adder	36 <sup>1</sup> / <sub>4</sub> "	18"	48"	5 <sup>3</sup> / <sub>8</sub> "	3	4			\$ 1,298	
	DW-AF-6018-S-36	Starter	37 <sup>3</sup> / <sub>8</sub> "	18"	60"	5 <sup>3</sup> / <sub>8</sub> "	4	5			\$ 1,929	
	DW-AF-6018-A-36	Adder	36 <sup>1</sup> / <sub>4</sub> "	18"	60"	5 <sup>3</sup> / <sub>8</sub> "	4	5			\$ 1,439	
	DW-AF-7218-S-36	Starter	37 <sup>3</sup> / <sub>8</sub> "	18"	72"	5 <sup>3</sup> / <sub>8</sub> "	5	6			\$ 2,060	
	DW-AF-7218-A-36	Adder	36 <sup>1</sup> / <sub>4</sub> "	18"	72"	5 <sup>3</sup> / <sub>8</sub> "	5	6			\$ 1,586	
 <p>Model Shown DW-AF-4818-A-36</p>		A-Frame Shelving, Double Face										
	DW-AF-4824-S-36	Starter	37 <sup>3</sup> / <sub>8</sub> "	24"	48"	5 <sup>3</sup> / <sub>8</sub> "	6	8			\$ 2,846	
	DW-AF-4824-A-36	Adder	36 <sup>1</sup> / <sub>4</sub> "	24"	48"	5 <sup>3</sup> / <sub>8</sub> "	6	8			\$ 2,045	
	DW-AF-6024-S-36	Starter	37 <sup>3</sup> / <sub>8</sub> "	24"	60"	5 <sup>3</sup> / <sub>8</sub> "	8	10			\$ 2,953	
	DW-AF-6024-A-36	Adder	36 <sup>1</sup> / <sub>4</sub> "	24"	60"	5 <sup>3</sup> / <sub>8</sub> "	8	10			\$ 2,177	
	DW-AF-7224-S-36	Starter	37 <sup>3</sup> / <sub>8</sub> "	24"	72"	5 <sup>3</sup> / <sub>8</sub> "	10	12			\$ 3,203	
	DW-AF-7224-A-36	Adder	36 <sup>1</sup> / <sub>4</sub> "	24"	72"	5 <sup>3</sup> / <sub>8</sub> "	10	12			\$ 2,425	
 <p>Model Shown DW-AF-4824-A-36</p>		A-Frame Shelving, Double Face, Slatwall End Panel										
	DW-AF-4824-S-36-SW	Starter	37 <sup>3</sup> / <sub>8</sub> "	24"	48"	5 <sup>3</sup> / <sub>8</sub> "	6	8			\$ 3,023	
	DW-AF-4824-A-36-SW	Adder	36 <sup>1</sup> / <sub>4</sub> "	24"	48"	5 <sup>3</sup> / <sub>8</sub> "	6	8			\$ 2,045	
	DW-AF-6024-S-36-SW	Starter	37 <sup>3</sup> / <sub>8</sub> "	24"	60"	5 <sup>3</sup> / <sub>8</sub> "	8	10			\$ 3,195	
	DW-AF-6024-A-36-SW	Adder	36 <sup>1</sup> / <sub>4</sub> "	24"	60"	5 <sup>3</sup> / <sub>8</sub> "	8	10			\$ 2,177	
	DW-AF-7224-S-36-SW	Starter	37 <sup>3</sup> / <sub>8</sub> "	24"	72"	5 <sup>3</sup> / <sub>8</sub> "	10	12			\$ 3,498	
	DW-AF-7224-A-36-SW	Adder	36 <sup>1</sup> / <sub>4</sub> "	24"	72"	5 <sup>3</sup> / <sub>8</sub> "	10	12			\$ 2,425	
 <p>Model Shown DW-AF-4824-A-36-SW</p>		A-Frame Shelving, Double Face, Slatwall End Panel										
	DW-AF-4824-S-36-SW	Starter	37 <sup>3</sup> / <sub>8</sub> "	24"	48"	5 <sup>3</sup> / <sub>8</sub> "	6	8			\$ 3,023	
	DW-AF-4824-A-36-SW	Adder	36 <sup>1</sup> / <sub>4</sub> "	24"	48"	5 <sup>3</sup> / <sub>8</sub> "	6	8			\$ 2,045	
	DW-AF-6024-S-36-SW	Starter	37 <sup>3</sup> / <sub>8</sub> "	24"	60"	5 <sup>3</sup> / <sub>8</sub> "	8	10			\$ 3,195	
	DW-AF-6024-A-36-SW	Adder	36 <sup>1</sup> / <sub>4</sub> "	24"	60"	5 <sup>3</sup> / <sub>8</sub> "	8	10			\$ 2,177	
	DW-AF-7224-S-36-SW	Starter	37 <sup>3</sup> / <sub>8</sub> "	24"	72"	5 <sup>3</sup> / <sub>8</sub> "	10	12			\$ 3,498	
	DW-AF-7224-A-36-SW	Adder	36 <sup>1</sup> / <sub>4</sub> "	24"	72"	5 <sup>3</sup> / <sub>8</sub> "	10	12			\$ 2,425	

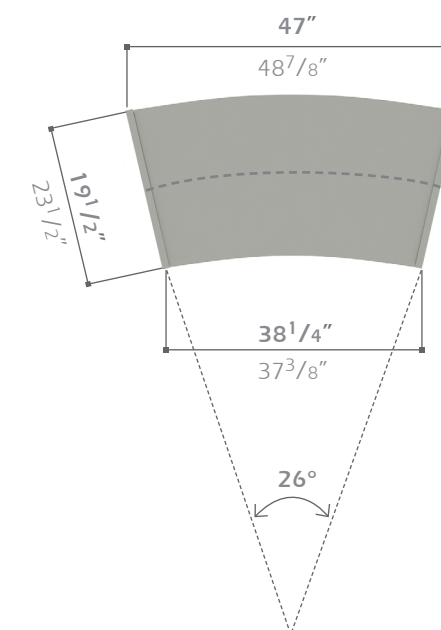
	MODEL NUMBER	PRODUCT	WIDTH	DEPTH	HEIGHT	SHELF DEPTH	# OF SHELVES	# OF OPENINGS	WEIGHT	VOLUME	LIST PRICE	
 Model Shown DW-CV-3624-S-36		26° Curved Shelving, Double Face										
	DW-CV-3620-S-36	Starter	47"	19 1/2"	36"		2	4	88.6 Lbs.	7 Cu Ft	\$ 3,075	
	DW-CV-3620-A-36	Adder	46"	19 1/2"	36"		2	4	73.6 Lbs.	6 Cu Ft	\$ 2,123	
	DW-CV-3624-S-36	Starter	48 7/8"	23 1/2"	36"		2	4	110 Lbs.	10 Cu Ft	\$ 3,143	
	DW-CV-3624-A-36	Adder	47 7/8"	23 1/2"	36"		2	4	95 Lbs.	9 Cu Ft	\$ 2,157	
 Model Shown DW-CV-4224-A-36		26° Curved Shelving, Double Face										
	DW-CV-4220-S-36	Starter	47"	19 1/2"	42"		4	6	94 Lbs.	7 Cu Ft	\$ 3,395	
	DW-CV-4220-A-36	Adder	46"	19 1/2"	42"		4	6	78 Lbs.	7 Cu Ft	\$ 2,440	
	DW-CV-4224-S-36	Starter	48 7/8"	23 1/2"	42"		4	6	115 Lbs.	10 Cu Ft	\$ 3,474	
	DW-CV-4224-A-36	Adder	47 7/8"	23 1/2"	42"		4	6	113 Lbs.	10 Cu Ft	\$ 2,486	
 Model Shown DW-CV-4824-S-36		26° Curved Shelving, Double Face										
	DW-CV-4820-S-36	Starter	47"	19 1/2"	48"		4	6	132 Lbs.	9 Cu Ft	\$ 3,520	
	DW-CV-4820-A-36	Adder	46"	19 1/2"	48"		4	6	109 Lbs.	8 Cu Ft	\$ 2,542	
	DW-CV-4824-S-36	Starter	48 7/8"	23 1/2"	48"		4	6	155 Lbs.	11 Cu Ft	\$ 3,609	
	DW-CV-4824-A-36	Adder	47 7/8"	23 1/2"	48"		4	6	127 Lbs.	10 Cu Ft	\$ 2,588	
 Model Shown DW-CV-6024-S-36		26° Curved Shelving, Double Face										
	DW-CV-6020-S-36	Starter	47"	19 1/2"	60"		6	8	176 Lbs.	11 Cu Ft	\$ 3,655	
	DW-CV-6020-A-36	Adder	46"	19 1/2"	60"		6	8	145 Lbs.	10 Cu Ft	\$ 2,680	
	DW-CV-6024-S-36	Starter	48 7/8"	23 1/2"	60"		6	8	200 Lbs.	12 Cu Ft	\$ 3,746	
	DW-CV-6024-A-36	Adder	47 7/8"	23 1/2"	60"		6	8	164 Lbs.	11 Cu Ft	\$ 2,661	

End, Mid, Top and Base Panels to be constructed from 1" thick 11-ply solid core, veneered 2 sides. Vertical, top and bottom edges banded with 1/4" external hardwood edging, edges to be eased.





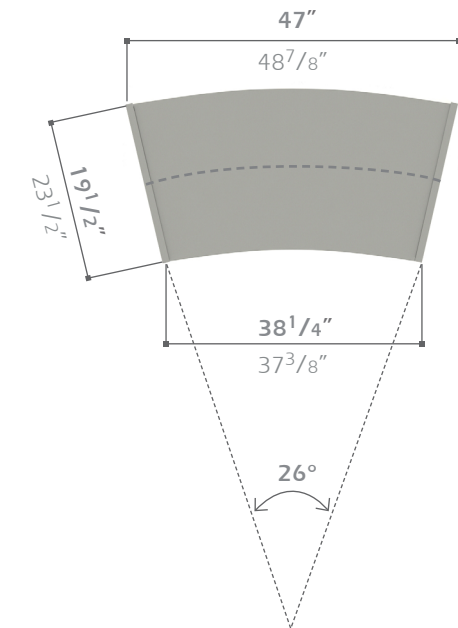

	MODEL NUMBER	PRODUCT	WIDTH	DEPTH	HEIGHT	SHELF DEPTH	# OF SHELVES	# OF OPENINGS	WEIGHT	VOLUME	LIST PRICE	DESCRIPTION
 <p>Model Shown DW-CV-3624-S-36-IPT</p>		26° Curved Shelving, Double Face										End, Mid, Top and Base Panels to be constructed from 1" thick 11-ply solid core, veneered 2 sides. Vertical, top and bottom edges banded with 1/4" external hardwood edging, edges to be eased.
	DW-CV-3620-S-36-IPT	Starter	47"	19 1/2"	36"		2	4	88.6 Lbs.	7 Cu Ft	\$ 3,290	
	DW-CV-3620-A-36-IPT	Adder	46"	19 1/2"	36"		2	4	73.6 Lbs.	6 Cu Ft	\$ 2,338	
	DW-CV-3624-S-36-IPT	Starter	48 7/8"	23 1/2"	36"		2	4	110 Lbs.	10 Cu Ft	\$ 3,358	
	DW-CV-3624-A-36-IPT	Adder	47 7/8"	23 1/2"	36"		2	4	95 Lbs.	9 Cu Ft	\$ 2,372	
 <p>Model Shown DW-CV-3624-A-36-IPT</p>		26° Curved Shelving, Double Face										
	DW-CV-4220-S-36-IPT	Starter	47"	19 1/2"	42"		4	6	94 Lbs.	7 Cu Ft	\$ 3,609	
	DW-CV-4220-A-36-IPT	Adder	46"	19 1/2"	42"		4	6	78 Lbs.	7 Cu Ft	\$ 2,655	
	DW-CV-4224-S-36-IPT	Starter	48 7/8"	23 1/2"	42"		4	6	115 Lbs.	10 Cu Ft	\$ 3,689	
	DW-CV-4224-A-36-IPT	Adder	47 7/8"	23 1/2"	42"		4	6	113 Lbs.	10 Cu Ft	\$ 2,701	
 <p>Model Shown DW-CV-4824-S-36-IPT</p>		26° Curved Shelving, Double Face										
	DW-CV-4820-S-36-IPT	Starter	47"	19 1/2"	48"		4	6	132 Lbs.	9 Cu Ft	\$ 3,735	
	DW-CV-4820-A-36-IPT	Adder	46"	19 1/2"	48"		4	6	109 Lbs.	8 Cu Ft	\$ 2,758	
	DW-CV-4824-S-36-IPT	Starter	48 7/8"	23 1/2"	48"		4	6	155 Lbs.	11 Cu Ft	\$ 3,824	
	DW-CV-4824-A-36-IPT	Adder	47 7/8"	23 1/2"	48"		4	6	127 Lbs.	10 Cu Ft	\$ 2,804	
 <p>Model Shown DW-CV-6024-S-36-IPT</p>		26° Curved Shelving, Double Face										
	DW-CV-6020-S-36-IPT	Starter	47"	19 1/2"	60"		6	8	176 Lbs.	11 Cu Ft	\$ 3,870	
	DW-CV-6020-A-36-IPT	Adder	46"	19 1/2"	60"		6	8	145 Lbs.	10 Cu Ft	\$ 2,895	
	DW-CV-6024-S-36-IPT	Starter	48 7/8"	23 1/2"	60"		6	8	200 Lbs.	12 Cu Ft	\$ 3,962	
	DW-CV-6024-A-36-IPT	Adder	47 7/8"	23 1/2"	60"		6	8	164 Lbs.	11 Cu Ft	\$ 2,876	







MODEL NUMBER	PRODUCT	WIDTH	DEPTH	HEIGHT	WEIGHT	VOLUME	LIST PRICE	DESCRIPTION
 <p>Model Shown S-BA7212E</p>	S-BA3010E	Bolt Assembly	1"	10 <sup>1</sup> / <sub>8</sub> "	30"		\$ 529	
	S-BA3610E	Single Face End Panels	1"	10 <sup>1</sup> / <sub>8</sub> "	36"	7 Lbs.	0.3 Cu Ft	\$ 552
	S-BA4210E		1"	10 <sup>1</sup> / <sub>8</sub> "	42"	8 Lbs.	0.3 Cu Ft	\$ 568
	S-BA4810E		1"	10 <sup>1</sup> / <sub>8</sub> "	48"	9 Lbs.	0.3 Cu Ft	\$ 583
	S-BA6010E		1"	10 <sup>1</sup> / <sub>8</sub> "	60"	12 Lbs.	0.4 Cu Ft	\$ 614
	S-BA7210E		1"	10 <sup>1</sup> / <sub>8</sub> "	72"	14 Lbs.	0.5 Cu Ft	\$ 637
	S-BA8210E		1"	10 <sup>1</sup> / <sub>8</sub> "	82"	16 Lbs.	0.6 Cu Ft	\$ 669
	S-BA9610E		1"	10 <sup>1</sup> / <sub>8</sub> "	96"	19 Lbs.	0.7 Cu Ft	\$ 700
	S-BA3012E	Bolt Assembly	1"	12 <sup>1</sup> / <sub>8</sub> "	30"			\$ 692
S-BA3612E	Single Face End Panels	1"	12 <sup>1</sup> / <sub>8</sub> "	36"	7 Lbs.	0.3 Cu Ft	\$ 731	
S-BA4212E		1"	12 <sup>1</sup> / <sub>8</sub> "	42"	8 Lbs.	0.3 Cu Ft	\$ 746	
S-BA4812E		1"	12 <sup>1</sup> / <sub>8</sub> "	48"	9 Lbs.	0.3 Cu Ft	\$ 622	
S-BA6012E		1"	12 <sup>1</sup> / <sub>8</sub> "	60"	12 Lbs.	0.4 Cu Ft	\$ 653	
S-BA7212E		1"	12 <sup>1</sup> / <sub>8</sub> "	72"	14 Lbs.	0.5 Cu Ft	\$ 684	
S-BA8212E		1"	12 <sup>1</sup> / <sub>8</sub> "	82"	16 Lbs.	0.6 Cu Ft	\$ 715	
S-BA9612E		1"	12 <sup>1</sup> / <sub>8</sub> "	96"	19 Lbs.	0.7 Cu Ft	\$ 746	
S-BA3014E	Bolt Assembly	1"	14 <sup>5</sup> / <sub>8</sub> "	30"			\$ 739	
S-BA3614E	Single Face End Panels	1"	14 <sup>5</sup> / <sub>8</sub> "	36"	7 Lbs.	0.3 Cu Ft	\$ 777	
S-BA4214E		1"	14 <sup>5</sup> / <sub>8</sub> "	42"	8 Lbs.	0.3 Cu Ft	\$ 793	
S-BA4814E		1"	14 <sup>5</sup> / <sub>8</sub> "	48"	9 Lbs.	0.3 Cu Ft	\$ 653	
S-BA6014E		1"	14 <sup>5</sup> / <sub>8</sub> "	60"	12 Lbs.	0.4 Cu Ft	\$ 684	
S-BA7214E		1"	14 <sup>5</sup> / <sub>8</sub> "	72"	14 Lbs.	0.5 Cu Ft	\$ 715	
S-BA8214E		1"	14 <sup>5</sup> / <sub>8</sub> "	82"	16 Lbs.	0.6 Cu Ft	\$ 746	
S-BA9614E		1"	14 <sup>5</sup> / <sub>8</sub> "	96"	19 Lbs.	0.7 Cu Ft	\$ 777	
S-BA3620E	Bolt Assembly	1"	19 <sup>1</sup> / <sub>2</sub> "	36"	14 Lbs.	0.6 Cu Ft	\$ 957	
S-BA4220E	Double Face End Panels	1"	19 <sup>1</sup> / <sub>2</sub> "	42"	15 Lbs.	0.6 Cu Ft	\$ 981	
S-BA4820E		1"	19 <sup>1</sup> / <sub>2</sub> "	48"	18 Lbs.	0.7 Cu Ft	\$ 1,011	
S-BA6020E		1"	19 <sup>1</sup> / <sub>2</sub> "	60"	24 Lbs.	0.8 Cu Ft	\$ 1,073	
S-BA7220E		1"	19 <sup>1</sup> / <sub>2</sub> "	72"	28 Lbs.	1 Cu Ft	\$ 1,127	
S-BA8220E		1"	19 <sup>1</sup> / <sub>2</sub> "	82"	32 Lbs.	1.2 Cu Ft	\$ 1,189	
S-BA9620E		1"	19 <sup>1</sup> / <sub>2</sub> "	96"	38 Lbs.	1.4 Cu Ft	\$ 1,229	
S-BA3624E	Bolt Assembly	1"	23 <sup>1</sup> / <sub>2</sub> "	36"	14 Lbs.	0.6 Cu Ft	\$ 981	
S-BA4224E	Double Face End Panels	1"	23 <sup>1</sup> / <sub>2</sub> "	42"	15 Lbs.	0.6 Cu Ft	\$ 1,011	
S-BA4824E		1"	23 <sup>1</sup> / <sub>2</sub> "	48"	18 Lbs.	0.7 Cu Ft	\$ 1,042	
S-BA6024E		1"	23 <sup>1</sup> / <sub>2</sub> "	60"	24 Lbs.	0.8 Cu Ft	\$ 1,095	
S-BA7224E		1"	23 <sup>1</sup> / <sub>2</sub> "	72"	28 Lbs.	1 Cu Ft	\$ 1,158	
S-BA8224E		1"	23 <sup>1</sup> / <sub>2</sub> "	82"	32 Lbs.	1.2 Cu Ft	\$ 1,220	
S-BA9624E		1"	23 <sup>1</sup> / <sub>2</sub> "	96"	38 Lbs.	1.4 Cu Ft	\$ 1,275	
S-BA3628E	Bolt Assembly	1"	28 <sup>1</sup> / <sub>2</sub> "	36"	14 Lbs.	0.6 Cu Ft	\$ 1,073	
S-BA4228E	Double Face End Panels	1"	28 <sup>1</sup> / <sub>2</sub> "	42"	15 Lbs.	0.6 Cu Ft	\$ 1,105	
S-BA4828E		1"	28 <sup>1</sup> / <sub>2</sub> "	48"	18 Lbs.	0.7 Cu Ft	\$ 1,158	
S-BA6028E		1"	28 <sup>1</sup> / <sub>2</sub> "	60"	24 Lbs.	0.8 Cu Ft	\$ 1,236	
S-BA7228E		1"	28 <sup>1</sup> / <sub>2</sub> "	72"	28 Lbs.	1 Cu Ft	\$ 1,336	
S-BA8228E		1"	28 <sup>1</sup> / <sub>2</sub> "	82"	32 Lbs.	1.2 Cu Ft	\$ 1,423	
S-BA9628E		1"	28 <sup>1</sup> / <sub>2</sub> "	96"	38 Lbs.	1.4 Cu Ft	\$ 1,687	

MODEL NUMBER	PRODUCT	WIDTH	DEPTH	HEIGHT	WEIGHT	VOLUME	LIST PRICE	DESCRIPTION	
 <p>Model Shown S-BA7212M</p>	S-BA3010M	Bolt Assembly	1"	10 <sup>1</sup> / <sub>8</sub> "	30"		\$ 552		
	S-BA3610M	Single Face Mid Panels	1"	10 <sup>1</sup> / <sub>8</sub> "	36"	7 Lbs.	0.3 Cu Ft	\$ 583	
	S-BA4210M		1"	10 <sup>1</sup> / <sub>8</sub> "	42"	8 Lbs.	0.3 Cu Ft	\$ 598	
	S-BA4810M		1"	10 <sup>1</sup> / <sub>8</sub> "	48"	9 Lbs.	0.3 Cu Ft	\$ 614	
	S-BA6010M		1"	10 <sup>1</sup> / <sub>8</sub> "	60"	12 Lbs.	0.4 Cu Ft	\$ 637	
	S-BA7210M		1"	10 <sup>1</sup> / <sub>8</sub> "	72"	14 Lbs.	0.5 Cu Ft	\$ 669	
	S-BA8210M		1"	10 <sup>1</sup> / <sub>8</sub> "	82"	16 Lbs.	0.6 Cu Ft	\$ 700	
	S-BA9610M		1"	10 <sup>1</sup> / <sub>8</sub> "	96"	19 Lbs.	0.7 Cu Ft	\$ 731	
	S-BA3012M	Bolt Assembly	1"	12 <sup>1</sup> / <sub>8</sub> "	30"			\$ 568	
	S-BA3612M	Single Face Mid Panels	1"	12 <sup>1</sup> / <sub>8</sub> "	36"	7 Lbs.	0.3 Cu Ft	\$ 598	
S-BA4212M		1"	12 <sup>1</sup> / <sub>8</sub> "	42"	8 Lbs.	0.3 Cu Ft	\$ 614		
S-BA4812M		1"	12 <sup>1</sup> / <sub>8</sub> "	48"	9 Lbs.	0.3 Cu Ft	\$ 622		
S-BA6012M		1"	12 <sup>1</sup> / <sub>8</sub> "	60"	12 Lbs.	0.4 Cu Ft	\$ 653		
S-BA7212M		1"	12 <sup>1</sup> / <sub>8</sub> "	72"	14 Lbs.	0.5 Cu Ft	\$ 684		
S-BA8212M		1"	12 <sup>1</sup> / <sub>8</sub> "	82"	16 Lbs.	0.6 Cu Ft	\$ 715		
S-BA9612M		1"	12 <sup>1</sup> / <sub>8</sub> "	96"	19 Lbs.	0.7 Cu Ft	\$ 746		
S-BA3014M	Bolt Assembly	1"	14 <sup>5</sup> / <sub>8</sub> "	30"			\$ 598		
S-BA3614M	Single Face Mid Panels	1"	14 <sup>5</sup> / <sub>8</sub> "	36"	7 Lbs.	0.3 Cu Ft	\$ 622		
S-BA4214M		1"	14 <sup>5</sup> / <sub>8</sub> "	42"	8 Lbs.	0.3 Cu Ft	\$ 676		
S-BA4814M		1"	14 <sup>5</sup> / <sub>8</sub> "	48"	9 Lbs.	0.3 Cu Ft	\$ 653		
S-BA6014M		1"	14 <sup>5</sup> / <sub>8</sub> "	60"	12 Lbs.	0.4 Cu Ft	\$ 684		
S-BA7214M		1"	14 <sup>5</sup> / <sub>8</sub> "	72"	14 Lbs.	0.5 Cu Ft	\$ 746		
S-BA8214M		1"	14 <sup>5</sup> / <sub>8</sub> "	82"	16 Lbs.	0.6 Cu Ft	\$ 777		
S-BA9614M		1"	14 <sup>5</sup> / <sub>8</sub> "	96"	19 Lbs.	0.7 Cu Ft	\$ 800		
S-BA3620M	Bolt Assembly	1"	19 <sup>1</sup> / <sub>2</sub> "	36"	14 Lbs.	0.6 Cu Ft	\$ 981		
S-BA4220M	Double Face Mid Panels	1"	19 <sup>1</sup> / <sub>2</sub> "	42"	15 Lbs.	0.6 Cu Ft	\$ 1,011		
S-BA4820M		1"	19 <sup>1</sup> / <sub>2</sub> "	48"	18 Lbs.	0.7 Cu Ft	\$ 1,042		
S-BA6020M		1"	19 <sup>1</sup> / <sub>2</sub> "	60"	24 Lbs.	0.8 Cu Ft	\$ 1,095		
S-BA7220M		1"	19 <sup>1</sup> / <sub>2</sub> "	72"	28 Lbs.	1 Cu Ft	\$ 1,158		
S-BA8220M		1"	19 <sup>1</sup> / <sub>2</sub> "	82"	32 Lbs.	1.2 Cu Ft	\$ 1,220		
S-BA9620M		1"	19 <sup>1</sup> / <sub>2</sub> "	96"	38 Lbs.	1.4 Cu Ft	\$ 1,275		
S-BA3624M	Bolt Assembly	1"	23 <sup>1</sup> / <sub>2</sub> "	36"	14 Lbs.	0.6 Cu Ft	\$ 1,011		
S-BA4224M	Double Face Mid Panels	1"	23 <sup>1</sup> / <sub>2</sub> "	42"	15 Lbs.	0.6 Cu Ft	\$ 1,042		
S-BA4824M		1"	23 <sup>1</sup> / <sub>2</sub> "	48"	18 Lbs.	0.7 Cu Ft	\$ 1,073		
S-BA6024M		1"	23 <sup>1</sup> / <sub>2</sub> "	60"	24 Lbs.	0.8 Cu Ft	\$ 1,127		
S-BA7224M		1"	23 <sup>1</sup> / <sub>2</sub> "	72"	28 Lbs.	1 Cu Ft	\$ 1,189		
S-BA8224M		1"	23 <sup>1</sup> / <sub>2</sub> "	82"	32 Lbs.	1.2 Cu Ft	\$ 1,244		
S-BA9624M		1"	23 <sup>1</sup> / <sub>2</sub> "	96"	38 Lbs.	1.4 Cu Ft	\$ 1,306		
S-BA3628M	Bolt Assembly	1"	28 <sup>1</sup> / <sub>2</sub> "	36"	14 Lbs.	0.6 Cu Ft	\$ 1,095		
S-BA4228M	Double Face Mid Panels	1"	28 <sup>1</sup> / <sub>2</sub> "	42"	15 Lbs.	0.6 Cu Ft	\$ 1,135		
S-BA4828M		1"	28 <sup>1</sup> / <sub>2</sub> "	48"	18 Lbs.	0.7 Cu Ft	\$ 1,189		
S-BA6028M		1"	28 <sup>1</sup> / <sub>2</sub> "	60"	24 Lbs.	0.8 Cu Ft	\$ 1,275		
S-BA7228M		1"	28 <sup>1</sup> / <sub>2</sub> "	72"	28 Lbs.	1 Cu Ft	\$ 1,369		
S-BA8228M		1"	28 <sup>1</sup> / <sub>2</sub> "	82"	32 Lbs.	1.2 Cu Ft	\$ 1,454		
S-BA9628M		1"	28 <sup>1</sup> / <sub>2</sub> "	96"	38 Lbs.	1.4 Cu Ft	\$ 1,547		





	MODEL NUMBER	PRODUCT	WIDTH	DEPTH	HEIGHT	WEIGHT	VOLUME	LIST PRICE	DESCRIPTION	
	S-BAT1024	Bolt Assembly Single Face Top Shelf	23 1/4"	9 3/4"	2 1/2"	7 Lbs.	0.3 Cu Ft	\$ 536		
	S-BAT1224		23 1/4"	11 3/4"	2 1/2"			\$ 552		
	S-BAT1424		23 1/4"	14 1/4"	2 1/2"			\$ 568		
	S-BAT1030		29 1/4"	9 3/4"	2 1/2"			\$ 536		
	S-BAT1230		29 1/4"	11 3/4"	2 1/2"			\$ 552		
	S-BAT1430		29 1/4"	14 1/4"	2 1/2"			\$ 568		
	S-BAT1036		35 1/4"	9 3/4"	2 1/2"	7 Lbs	0.8 Cu Ft	\$ 452		
	S-BAT1236		35 1/4"	11 3/4"	2 1/2"	9 Lbs	0.8 Cu Ft	\$ 466		
	S-BAT1436		35 1/4"	14 1/4"	2 1/2"	10 Lbs	0.8 Cu Ft	\$ 483		
	S-BAT2024	Bolt Assembly Double Face Top Shelf	23 1/4"	19 1/4"	2 1/2"			\$ 770		
	S-BAT2424		23 1/4"	23 1/4"	2 1/2"			\$ 800		
	S-BAT2824		23 1/4"	28 1/4"	2 1/2"			\$ 839		
	S-BAT2030		29 1/4"	19 1/4"	2 1/2"			\$ 770		
	S-BAT2430		29 1/4"	23 1/4"	2 1/2"			\$ 800		
	S-BAT2830		29 1/4"	28 1/4"	2 1/2"			\$ 839		
	S-BAT2036		35 1/4"	19 1/4"	2 1/2"	14 Lbs	1.5 Cu Ft	\$ 637		
	S-BAT2436		35 1/4"	23 1/4"	2 1/2"	16 Lbs	1.5 Cu Ft	\$ 669		
	S-BAT2836		35 1/4"	28 1/4"	2 1/2"	18 Lbs	1.5 Cu Ft	\$ 715		
		S-BAB1024	Bolt Assembly Single Face Bottom Shelf	23 1/4"	9 3/4"	2 1/2"			\$ 560	
		S-BAB1224		23 1/4"	11 3/4"	2 1/2"			\$ 576	
		S-BAB1424		23 1/4"	14 1/4"	2 1/2"			\$ 590	
S-BAB1030			29 1/4"	9 3/4"	2 1/2"			\$ 560		
S-BAB1230			29 1/4"	11 3/4"	2 1/2"			\$ 576		
S-BAB1430			29 1/4"	14 1/4"	2 1/2"			\$ 590		
S-BAB1036			35 1/4"	9 3/4"	2 1/2"	7 Lbs	0.8 Cu Ft	\$ 466		
S-BAB1236			35 1/4"	11 3/4"	2 1/2"	9 Lbs	0.8 Cu Ft	\$ 490		
S-BAB1436			35 1/4"	14 1/4"	2 1/2"	10 Lbs	0.8 Cu Ft	\$ 505		
	S-BAB2024	Bolt Assembly Double Face Bottom Shelf	23 1/4"	19 1/4"	2 1/2"			\$ 810		
	S-BAB2424		23 1/4"	23 1/4"	2 1/2"			\$ 839		
	S-BAB2824		23 1/4"	28 1/4"	2 1/2"			\$ 877		
	S-BAB2030		29 1/4"	19 1/4"	2 1/2"			\$ 810		
	S-BAB2430		29 1/4"	23 1/4"	2 1/2"			\$ 839		
	S-BAB2830		29 1/4"	28 1/4"	2 1/2"			\$ 910		
	S-BAB2036		35 1/4"	19 1/4"	2 1/2"	14 Lbs	1.5 Cu Ft	\$ 669		
	S-BAB2436		35 1/4"	23 1/4"	2 1/2"	16 Lbs	1.5 Cu Ft	\$ 700		
	S-BAB2836		35 1/4"	28 1/4"	2 1/2"	18 Lbs	1.5 Cu Ft	\$ 746		

MODEL NUMBER	PRODUCT	WIDTH	DEPTH	HEIGHT	WEIGHT	VOLUME	LIST PRICE	DESCRIPTION
	S-PB30S-24	Printed Backs - Single Face	24"	30"			\$ 78	
	S-PB30S-30		30"	30"			\$ 78	
	S-PB30S-36		36"	30"			\$ 86	
	S-PB36S-24		24"	36"	9 Lbs.	0.2 Cu Ft	\$ 78	
	S-PB36S-30		30"	36"			\$ 78	
	S-PB36S-36		36"	36"			\$ 86	
	S-PB42S-24		24"	42"	9 Lbs.	0.2 Cu Ft	\$ 78	
	S-PB42S-30		30"	42"			\$ 78	
	S-PB42S-36		36"	42"			\$ 86	
Model Shown S-PB72D-24	S-PB48S-24		24"	48"	12 Lbs.	0.3 Cu Ft	\$ 78	
	S-PB48S-30		30"	48"			\$ 78	
	S-PB48S-36		36"	48"			\$ 86	
	S-PB60S-24		24"	60"	15 Lbs.	0.3 Cu Ft	\$ 93	
	S-PB60S-30		30"	60"			\$ 110	
	S-PB60S-36		36"	60"			\$ 110	
	S-PB72S-24		24"	72"	18 Lbs.	0.4 Cu Ft	\$ 131	
	S-PB72S-30		30"	72"			\$ 131	
	S-PB72S-36		36"	72"			\$ 131	
	S-PB84S-24		24"	82"	21 Lbs.	0.4 Cu Ft	\$ 131	
	S-PB84S-30		30"	82"			\$ 131	
	S-PB84S-36		36"	82"			\$ 131	
	S-PB96S-24		24"	96"	24 Lbs.	0.5 Cu Ft	\$ 131	
	S-PB96S-30		30"	96"			\$ 131	
	S-PB96S-36		36"	96"			\$ 131	

MODEL NUMBER	PRODUCT	WIDTH	DEPTH	HEIGHT	WEIGHT	VOLUME	LIST PRICE	DESCRIPTION
	S-PB30D-24	Printed Backs - Double Face	24"	30"			\$ 93	
	S-PB30D-30		30"	30"			\$ 93	
	S-PB30D-36		36"	30"			\$ 93	
	S-PB36D-24		24"	36"	9 Lbs.	0.2 Cu Ft	\$ 93	
	S-PB36D-30		30"	36"			\$ 93	
	S-PB36D-36		36"	36"			\$ 93	
	S-PB42D-24		24"	42"			\$ 93	
	S-PB42D-30		30"	42"			\$ 93	
	S-PB42D-36		36"	42"	9 Lbs.	0.2 Cu Ft	\$ 93	
	S-PB48D-24		24"	48"			\$ 93	
	S-PB48D-30		30"	48"			\$ 93	
	S-PB48D-36		36"	48"	12 Lbs.	0.3 Cu Ft	\$ 93	
	S-PB60D-24		24"	60"			\$ 148	
	S-PB60D-30		30"	60"			\$ 148	
	S-PB60D-36		36"	60"	15 Lbs.	0.3 Cu Ft	\$ 148	
	S-PB72D-24		24"	72"			\$ 148	
	S-PB72D-30		30"	72"			\$ 148	
	S-PB72D-36		36"	72"	18 Lbs.	0.4 Cu Ft	\$ 148	
	S-PB84D-24		24"	82"			\$ 148	
	S-PB84D-30		30"	82"			\$ 148	
	S-PB84D-36		36"	82"	21 Lbs.	0.4 Cu Ft	\$ 148	
	S-PB96D-24		24"	96"			\$ 148	
	S-PB96D-30		30"	96"			\$ 148	
	S-PB96D-36		36"	96"	24 Lbs.	0.5 Cu Ft	\$ 148	

Model Shown  
S-PB72D-24

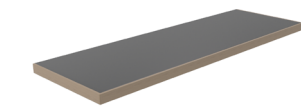
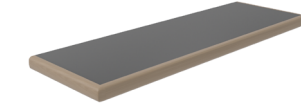

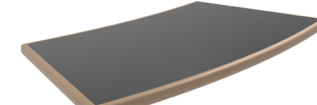
	MODEL NUMBER	PRODUCT	WIDTH	DEPTH	HEIGHT	WEIGHT	VOLUME	LIST PRICE	DESCRIPTION
 <p>Model Shown S-PLSS-3612</p>	S-PLSS-2410	Sloped Continuous Plastic	24"	9 <sup>3</sup> / <sub>4</sub> "	7"	45 Lbs.	0.6 Cu Ft	\$ 560	Sloped Top option is only available for Shelving units with a height of 36", 42", or 48"
	S-PLSS-2412	Laminate Top, Single Face	24"	11 <sup>3</sup> / <sub>4</sub> "	7"			\$ 576	
	S-PLSS-2414		24"	14 <sup>1</sup> / <sub>4</sub> "	7"			\$ 590	
	S-PLSS-3010		30"	9 <sup>3</sup> / <sub>4</sub> "	7"			\$ 560	
	S-PLSS-3012		30"	11 <sup>3</sup> / <sub>4</sub> "	7"			\$ 576	
	S-PLSS-3014		30"	14 <sup>1</sup> / <sub>4</sub> "	7"			\$ 590	
	S-PLSS-3610		36"	9 <sup>3</sup> / <sub>4</sub> "	7"			\$ 474	
	S-PLSS-3612		36"	11 <sup>3</sup> / <sub>4</sub> "	7"			\$ 490	
	S-PLSS-3614		36"	14 <sup>1</sup> / <sub>4</sub> "	7"			\$ 498	
 <p>Model Shown S-PLSD-3624</p>	S-PLSD-2420	Sloped Continuous Plastic	24"	19 <sup>1</sup> / <sub>4</sub> "	7"	75 Lbs.	17 Cu Ft	\$ 762	Sloped Top option is only available for Shelving units with a height of 36", 42", or 48"
	S-PLSD-2424	Laminate Top, Double Face	24"	23 <sup>1</sup> / <sub>4</sub> "	7"			\$ 785	
	S-PLSD-2428		24"	28 <sup>1</sup> / <sub>4</sub> "	7"			\$ 810	
	S-PLSD-3020		30"	19 <sup>1</sup> / <sub>4</sub> "	7"			\$ 762	
	S-PLSD-3024		30"	23 <sup>1</sup> / <sub>4</sub> "	7"			\$ 785	
	S-PLSD-3028		30"	28 <sup>1</sup> / <sub>4</sub> "	7"			\$ 810	
	S-PLSD-3620		36"	19 <sup>1</sup> / <sub>4</sub> "	7"			\$ 676	
	S-PLSD-3624		36"	23 <sup>1</sup> / <sub>4</sub> "	7"			\$ 700	
	S-PLSD-3628		36"	28 <sup>1</sup> / <sub>4</sub> "	7"			\$ 715	
 <p>Model Shown S-CT36S-B</p>	S-CT36S-B	Continuous Top, Square Edge (Beta) Single Face	36"	12"	1"	30 Lbs.	0.4 Cu Ft	\$ 256	Single faced tops shall receive edges on 2 short and 1 long edge. Double faced tops shall receive edges on 2 long and 2 short edges. Tops longer than 108" shall be joined together using tight joint fasteners. Suitable for shelving up to 60" high.
	S-CT36D-B	Double Face	36"	24"	1"	60 Lbs.	0.7 Cu Ft	\$ 381	
 <p>Model Shown S-CT36S-R</p>	S-CT36S-R	Continuous Top, Bullnose Edge (Ronda) Single Face	36"	12"	1"	30 Lbs.	0.4 Cu Ft	\$ 436	Prices are given per individual bay. Multiply the list price by the number of bay lengths required.
	S-CT36D-R	Double Face	36"	24"	1"	60 Lbs.	0.7 Cu Ft	\$ 498	
 <p>Model Shown S-CV36-20-B</p>	S-CV36-20-B	Continuous Curved Top (Beta) Double Face, 20" D	36"	20"	1"	60 Lbs.	0.7 Cu Ft	\$ 475	
	S-CV36-24-B	Double Face, 24" D	36"	24"	1"	60 Lbs.	0.7 Cu Ft	\$ 497	
 <p>Model Shown S-CV36-20-R</p>	S-CV36-20-R	Continuous Curved Top (Ronda) Double Face, 20" D	36"	20"	1"	60 Lbs.	0.7 Cu Ft	\$ 614	
	S-CV36-24-R	Double Face, 24" D	36"	24"	1"	60 Lbs.	0.7 Cu Ft	\$ 633	

MODEL NUMBER	PRODUCT	WIDTH	DEPTH	HEIGHT	WEIGHT	VOLUME	LIST PRICE	DESCRIPTION
	S-VB30S-24	Veneer Backs - Single Face	24"	30"			\$ 178	
	S-VB30S-30		30"	30"			\$ 178	
	S-VB30S-36		36"	30"			\$ 178	
	S-VB36S-24		24"	36"	9 Lbs.	0.2 Cu Ft	\$ 178	
	S-VB36S-30		30"	36"			\$ 178	
	S-VB36S-36		36"	36"			\$ 178	
	S-VB42S-24		24"	42"			\$ 178	
	S-VB42S-30		30"	42"			\$ 178	
	S-VB42S-36		36"	42"	9 Lbs.	0.2 Cu Ft	\$ 178	
	S-VB48S-24		24"	48"			\$ 178	
	S-VB48S-30		30"	48"			\$ 178	
	S-VB48S-36		36"	48"	12 Lbs.	0.3 Cu Ft	\$ 178	
	S-VB60S-24		24"	60"			\$ 273	
	S-VB60S-30		30"	60"			\$ 273	
	S-VB60S-36		36"	60"	15 Lbs.	0.3 Cu Ft	\$ 273	
	S-VB72S-24		24"	72"			\$ 273	
	S-VB72S-30		30"	72"			\$ 273	
	S-VB72S-36		36"	72"	18 Lbs.	0.4 Cu Ft	\$ 273	
	S-VB82S-24		24"	82"			\$ 273	
	S-VB82S-30		30"	82"			\$ 273	
	S-VB82S-36		36"	82"	21 Lbs.	0.4 Cu Ft	\$ 273	
	S-VB96S-24		24"	96"			\$ 273	
	S-VB96S-30		30"	96"			\$ 273	
	S-VB96S-36		36"	96"	24 Lbs.	0.5 Cu Ft	\$ 273	

Model Shown  
S-VB72D-24

MODEL NUMBER	PRODUCT	WIDTH	DEPTH	HEIGHT	WEIGHT	VOLUME	LIST PRICE	DESCRIPTION
	S-VB30D-24	Veneer Backs - Double Face	24"	30"			\$ 273	
	S-VB30D-30		30"	30"			\$ 273	
	S-VB30D-36		36"	30"			\$ 273	
	S-VB36D-24		24"	36"	9 Lbs.	0.2 Cu Ft	\$ 273	
	S-VB36D-30		30"	36"			\$ 273	
	S-VB36D-36		36"	36"			\$ 273	
	S-VB42D-24		24"	42"			\$ 273	
	S-VB42D-30		30"	42"			\$ 273	
	S-VB42D-36		36"	42"	9 Lbs.	0.2 Cu Ft	\$ 273	
	S-VB48D-24		24"	48"			\$ 273	
	S-VB48D-30		30"	48"			\$ 273	
	S-VB48D-36		36"	48"	12 Lbs.	0.3 Cu Ft	\$ 273	
	S-VB60D-24		24"	60"			\$ 397	
	S-VB60D-30		30"	60"			\$ 397	
	S-VB60D-36		36"	60"	15 Lbs.	0.3 Cu Ft	\$ 397	
	S-VB72D-24		24"	72"			\$ 397	
	S-VB72D-30		30"	72"			\$ 397	
	S-VB72D-36		36"	72"	18 Lbs.	0.4 Cu Ft	\$ 397	
	S-VB82D-24		24"	82"			\$ 397	
	S-VB82D-30		30"	82"			\$ 397	
	S-VB82D-36		36"	82"	21 Lbs.	0.4 Cu Ft	\$ 397	
	S-VB96D-24		24"	96"			\$ 397	
	S-VB96D-30		30"	96"			\$ 397	
	S-VB96D-36		36"	96"	24 Lbs.	0.5 Cu Ft	\$ 397	

Model Shown  
S-VB72D-24

MODEL NUMBER	PRODUCT	WIDTH	DEPTH	HEIGHT	WEIGHT	VOLUME	LIST PRICE	DESCRIPTION
S-FB-V-30-24 S-FB-V-30-30 S-FB-V-30-36	Finished Back Veneer Option	24"		30"			\$ 568	
		30"		30"			\$ 568	
		36"		30"			\$ 568	
S-FB-V-36-24 S-FB-V-36-30 S-FB-V-36-36		24"		36"	9 Lbs.	0.2 Cu Ft	\$ 568	
		30"		36"			\$ 568	
		36"		36"			\$ 568	
S-FB-V-42-24 S-FB-V-42-30 S-FB-V-42-36		24"		42"	9 Lbs.	0.2 Cu Ft	\$ 568	
		30"		42"			\$ 568	
		36"		42"			\$ 568	
S-FB-V-48-24 S-FB-V-48-30 S-FB-V-48-36		24"		48"	12 Lbs.	0.3 Cu Ft	\$ 568	
		30"		48"			\$ 568	
		36"		48"			\$ 568	
S-FB-V-60-24 S-FB-V-60-30 S-FB-V-60-36		24"		60"	15 Lbs.	0.3 Cu Ft	\$ 715	
		30"		60"			\$ 715	
		36"		60"			\$ 715	
S-FB-V-72-24 S-FB-V-72-30 S-FB-V-72-36		24"		72"	18 Lbs.	0.4 Cu Ft	\$ 715	
		30"		72"			\$ 715	
		36"		72"			\$ 715	
S-FB-V-82-24 S-FB-V-82-30 S-FB-V-82-36		24"		82"	21 Lbs.	0.4 Cu Ft	\$ 715	
		30"		82"			\$ 715	
		36"		82"			\$ 715	
S-FB-V-96-24 S-FB-V-96-30 S-FB-V-96-36		24"		96"	24 Lbs.	0.5 Cu Ft	\$ 715	
		30"		96"			\$ 715	
		36"		96"			\$ 715	



Model Shown  
S-FB-V-72-24



Model Shown  
S-FB-C-72-24





MODEL NUMBER	PRODUCT	WIDTH	DEPTH	HEIGHT	WEIGHT	VOLUME	LIST PRICE	DESCRIPTION
S-FB-C-30-24	Finished Back Cork Option	24"		30"			\$ 831	
S-FB-C-30-30		30"		30"			\$ 831	
S-FB-C-30-36		36"		30"			\$ 831	
S-FB-C-36-24		24"		36"	9 Lbs.	0.2 Cu Ft	\$ 831	
S-FB-C-36-30		30"		36"			\$ 831	
S-FB-C-36-36		36"		36"			\$ 831	
S-FB-C-42-24		24"		42"			\$ 831	
S-FB-C-42-30		30"		42"			\$ 831	
S-FB-C-42-36		36"		42"	9 Lbs.	0.2 Cu Ft	\$ 831	
S-FB-C-48-24		24"		48"			\$ 831	
S-FB-C-48-30		30"		48"			\$ 831	
S-FB-C-48-36		36"		48"	12 Lbs.	0.3 Cu Ft	\$ 831	
S-FB-C-60-24		24"		60"			\$ 1,182	
S-FB-C-60-30		30"		60"			\$ 1,182	
S-FB-C-60-36		36"		60"	15 Lbs.	0.3 Cu Ft	\$ 1,182	
S-FB-C-72-24		24"		72"			\$ 1,182	
S-FB-C-72-30		30"		72"			\$ 1,182	
S-FB-C-72-36		36"		72"	18 Lbs.	0.4 Cu Ft	\$ 1,182	
S-FB-C-82-24		24"		82"			\$ 1,182	
S-FB-C-82-30		30"		82"			\$ 1,182	
S-FB-C-82-36		36"		82"	21 Lbs.	0.4 Cu Ft	\$ 1,182	
S-FB-C-96-24		24"		96"			\$ 1,182	
S-FB-C-96-30		30"		96"			\$ 1,182	
S-FB-C-96-36		36"		96"	24 Lbs.	0.5 Cu Ft	\$ 1,182	









MODEL NUMBER	PRODUCT	WIDTH	DEPTH	HEIGHT	WEIGHT	VOLUME	LIST PRICE	DESCRIPTION
S-FB-S-30-24 S-FB-S-30-30 S-FB-S-30-36	Finished Back Slotwall Option	24"		30"			\$ 1,011	
		30"		30"			\$ 1,011	
		36"		30"			\$ 1,011	
S-FB-S-36-24 S-FB-S-36-30 S-FB-S-36-36		24"		36"	9 Lbs.	0.2 Cu Ft	\$ 1,011	
		30"		36"			\$ 1,011	
		36"		36"			\$ 1,011	
S-FB-S-42-24 S-FB-S-42-30 S-FB-S-42-36		24"		42"	9 Lbs.	0.2 Cu Ft	\$ 1,011	
		30"		42"			\$ 1,011	
		36"		42"			\$ 1,011	
S-FB-S-48-24 S-FB-S-48-30 S-FB-S-48-36		24"		48"	12 Lbs.	0.3 Cu Ft	\$ 1,011	
		30"		48"			\$ 1,011	
		36"		48"			\$ 1,011	
S-FB-S-60-24 S-FB-S-60-30 S-FB-S-60-36		24"		60"	15 Lbs.	0.3 Cu Ft	\$ 1,602	
		30"		60"			\$ 1,602	
		36"		60"			\$ 1,602	
S-FB-S-72-24 S-FB-S-72-30 S-FB-S-72-36		24"		72"	18 Lbs.	0.4 Cu Ft	\$ 1,602	
		30"		72"			\$ 1,602	
		36"		72"			\$ 1,602	
S-FB-S-82-24 S-FB-S-82-30 S-FB-S-82-36		24"		82"	21 Lbs.	0.4 Cu Ft	\$ 1,602	
		30"		82"			\$ 1,602	
		36"		82"			\$ 1,602	
S-FB-S-96-24 S-FB-S-96-30 S-FB-S-96-36		24"		96"	24 Lbs.	0.5 Cu Ft	\$ 1,602	
		30"		96"			\$ 1,602	
		36"		96"			\$ 1,602	



Model Shown  
S-FB-S-72-24





	MODEL NUMBER	PRODUCT	WIDTH	DEPTH	HEIGHT	WEIGHT	VOLUME	LIST PRICE	DESCRIPTION
	W-S10-24	24" Wide Standard Wood Shelf	23 1/4"	9 1/2"	3/4"			\$ 124	
	W-S12-24		23 1/4"	11 1/2"	3/4"			\$ 140	
	W-S14-24		23 1/4"	14"	3/4"			\$ 171	
Model Shown DW-S12-36	W-S10-30	30" Wide Standard Wood Shelf	29 1/4"	9 1/2"	3/4"			\$ 124	
	W-S12-30		29 1/4"	11 1/2"	3/4"			\$ 140	
	W-S14-30		29 1/4"	14"	3/4"			\$ 171	
	W-S10-36	36" Wide Standard Wood Shelf	35 1/4"	9 1/2"	3/4"	6 Lbs.	0.2 Cu Ft	\$ 117	
	W-S12-36		35 1/4"	11 1/2"	3/4"	7 Lbs.	0.2 Cu Ft	\$ 131	
	W-S14-36		35 1/4"	14"	3/4"	8 Lbs.	0.2 Cu Ft	\$ 163	
	W-V10-24	24" Wide Veneered Shelf	23 1/4"	9 1/2"	3/4"			\$ 148	
	W-V12-24		23 1/4"	11 1/2"	3/4"			\$ 178	
	W-V14-24		23 1/4"	14"	3/4"			\$ 210	
Model Shown DW-V12-36	W-V10-30	30" Wide Veneered Shelf	29 1/4"	9 1/2"	3/4"			\$ 148	
	W-V12-30		29 1/4"	11 1/2"	3/4"			\$ 178	
	W-V14-30		29 1/4"	14"	3/4"			\$ 210	
	W-V10-36	36" Wide Veneered Shelf	35 1/4"	9 1/2"	3/4"	6 Lbs.	0.2 Cu Ft	\$ 148	
	W-V12-36		35 1/4"	11 1/2"	3/4"	7 Lbs.	0.2 Cu Ft	\$ 171	
	W-V14-36		35 1/4"	14"	3/4"	8 Lbs.	0.2 Cu Ft	\$ 194	
	G10-24	24" Wide Glass Shelf	23 1/4"	9 1/2"	1/4"			\$ 163	
	G12-24		23 1/4"	11 1/2"	1/4"			\$ 163	
	G14-24		23 1/4"	14"	1/4"			\$ 163	
Model Shown DW-V12-36	G10-30	30" Wide Glass Shelf	29 1/4"	9 1/2"	1/4"			\$ 171	
	G12-30		29 1/4"	11 1/2"	1/4"			\$ 171	
	G14-30		29 1/4"	14"	1/4"			\$ 171	
	G10-36	36" Wide Glass Shelf	35 1/4"	9 1/2"	1/4"			\$ 178	
	G12-36		35 1/4"	11 1/2"	1/4"			\$ 178	
	G14-36		35 1/4"	14"	1/4"			\$ 178	
	W-M12-24	24" Wide Wood Magazine Shelf	23 1/8"	2"	12"			\$ 248	
	W-M14-24		23 1/8"	2"	14"			\$ 288	
	W-M12-30	30" Wide Wood Magazine Shelf	29 1/8"	2"	12"			\$ 248	
Model Shown DW-M12-36	W-M14-30		29 1/8"	2"	14"			\$ 288	
	W-M12-36	36" Wide Wood Magazine Shelf	35 1/8"	2"	12"	13 Lbs.	6 Cu Ft	\$ 241	
	W-M14-36		35 1/8"	2"	14"	14 Lbs.	6 Cu Ft	\$ 273	

	MODEL NUMBER	PRODUCT	WIDTH	DEPTH	HEIGHT	WEIGHT	VOLUME	LIST PRICE	DESCRIPTION
 <p>Model Shown W-C12-IN-36</p>	W-C10-IN-36	26° Curved Wood Inside Shelf	40 1/4"	9 1/2"	3/4"			\$ 195	
	W-C12-IN-36		40 1/4"	11 1/2"	3/4"			\$ 227	
 <p>Model Shown W-C12-OT-36</p>	W-C10-OT-36	26° Curved Wood Outside Shelf	44 3/4"	9 1/2"	3/4"			\$ 195	
	W-C12-OT-36		45 1/2"	11 1/2"	3/4"			\$ 227	
 <p>Model Shown DW-P12-36</p>	W-P12-24	Wood Picture Book Shelf	23 1/4"	11 1/4"	9 3/4"			\$ 281	
	W-P12-30		29 1/4"	11 1/4"	9 3/4"			\$ 281	
	W-P12-36		35 1/4"	11 1/4"	9 3/4"	15 Lbs.	2 Cu Ft	\$ 265	
 <p>Model Shown S-SWS08</p>	S-SWS08	Slot Wall Display Shelves	8"	3 1/2"	5 1/2"	1 Lbs.	0.1 Cu Ft	\$ 86	
	S-SWS16		16"	3 1/2"	5 1/2"	1.5 Lbs.	0.1 Cu Ft	\$ 152	
	S-SWS32		32"	3 1/2"	5 1/2"	2.5 Lbs.	0.1 Cu Ft	\$ 282	
 <p>Model Shown W-GSB</p>	W-GSB-1024	Wood Grooved Bottom Shelf Option	23 1/4"	9 1/2"	3/4"			\$ 39	
	W-GSB-1224		23 1/4"	11 1/2"	3/4"			\$ 39	
	W-GSB-1424		23 1/4"	14"	3/4"			\$ 39	
	W-GSB-1030	29 1/4"	9 1/2"	3/4"			\$ 39		
	W-GSB-1230	29 1/4"	11 1/2"	3/4"			\$ 39		
	W-GSB-1430	29 1/4"	14"	3/4"			\$ 39		
	W-GSB-1036	35 1/4"	9 1/2"	3/4"			\$ 39		
	W-GSB-1236	35 1/4"	11 1/2"	3/4"			\$ 39		
	W-GSB-1436	35 1/4"	14"	3/4"			\$ 39		

	MODEL NUMBER	PRODUCT	WIDTH	DEPTH	HEIGHT	WEIGHT	VOLUME	LIST PRICE	DESCRIPTION
	S-FPS	Top Filler Panel, Single Face				2 Lbs.	0.1 Cu Ft	\$ 202	
	S-FPD	Top Filler Panel, Double Face				4 Lbs.	0.1 Cu Ft	\$ 335	
	S-FPT	Top Filler Panel, Tristar				5 Lbs.	0.1 Cu Ft	\$ 452	
	S-FPF	Front Filler Panel				5 Lbs.	0.1 Cu Ft	\$ 483	

	MODEL NUMBER	PRODUCT	WIDTH	DEPTH	HEIGHT	WEIGHT	VOLUME	LIST PRICE	DESCRIPTION
	S-MS3624	Mobile Shelving Bottom Frame (Max 60" H Shelving)	36"	24"	4 <sup>3</sup> / <sub>4</sub> "			\$ 590	
	S-MSC3624	Mobile Shelving Curved Bottom Frame (Max 60" H Shelving)	36"	24"	4 <sup>3</sup> / <sub>4</sub> "			\$ 864	
	W-CDS W-CDL		4 <sup>1</sup> / <sub>2</sub> " 7 <sup>1</sup> / <sub>2</sub> "		5 <sup>1</sup> / <sub>2</sub> " 6 <sup>1</sup> / <sub>2</sub> "	0.5 Lbs. 0.5 Lbs.	0.1 Cu Ft 0.1 Cu Ft	\$ 39 \$ 47	
	PD-01					0.5 Lbs.	0.1 Cu Ft	\$ 24	



	MODEL NUMBER	PRODUCT	WIDTH	DEPTH	HEIGHT	WEIGHT	VOLUME	LIST PRICE	DESCRIPTION
 Model Shown M-BE6	M-BE6	Metal Book End	5"	5"	6"	0.8 Lbs.	0.1 Cu Ft	\$ 24	
	M-BE9		5"	5"	9"	1 Lbs.	0.1 Cu Ft	\$ 31	
	S-H35	Hanging Kick Bag Rod	35 1/4"	3/8"	3/8"	6 Lbs.	0.1 Cu Ft	\$ 241	
	S-140	Wall Mounted Newspaper Rack	35 1/4"	12"	30 1/2"	40 Lbs.	9 Cu Ft	\$ 949	
	G-NS	Newspaper Stick	34"	3/4"		0.5 Lbs.	0.1 Cu Ft	\$ 110	
	M-SP-24	24" Metal Media Spacer	23 1/4"	3 1/2"	4 1/2"			\$ 48	Metal media spacers are utilized to reduce shelf space depth in order to accompany various medias such as paperbacks or DVDs. Universally, the spacer can reduce the shelf depth by either 3 1/2" or 4 1/2" in dimension.
	M-SP-30	30" Metal Media Spacer	29 1/4"	3 1/2"	4 1/2"			\$ 48	
	M-SP-36	36" Metal Media Spacer	35 1/4"	3 1/2"	4 1/2"			\$ 44	

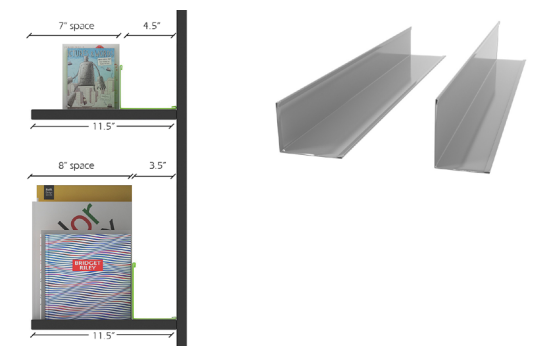

Palmieri Furniture Limited ("Palmieri") warrants that its products and collections are free from defects in materials and workmanship for the life of the product, except as set forth below. Palmieri Limited Lifetime Warranty is valid from the date of delivery.

**Exceptions to the Limited Lifetime Warranty: Seating: two (2) years**

Goods sold hereunder are covered by a Limited Lifetime Warranty, free against defects in material and workmanship provided the goods and services are subjected to normal use and service. The applicable warranty period commences from shipping date to Purchaser of any item of the goods, whichever occurs first, or any other warranty period otherwise stipulated in writing by Palmieri under this sale. For components not supplied by Palmieri, the original manufacturer's warranty shall apply to the extent assignable by Palmieri. The obligation under this warranty is limited to the repair or replacement, at Palmieri's option, of defective parts F.O.B. point of shipment provided that prompt notice of any defect is given by Purchaser to Palmieri in writing within the applicable warranty period and that upon the Purchaser's return of the defective parts to Palmieri or, if designated by Palmieri, to the location where the works are made, properly packed and with transportation charges prepaid by Purchaser, an inspection thereof shall reveal to Palmieri's satisfaction that Purchaser's claim is valid under the terms of this warranty. Purchaser shall assume all responsibility and expense for dismantling, removal, re-installation and freight in connection with the foregoing. The same obligations and conditions extend to replacement parts furnished by Palmieri hereunder.

Palmieri does not assume liability for installation, labour or consequential damages. Palmieri makes no warranty other than the one set forth herein. All other warranties, legal, expressed or implied, including but not limited to any expressed or implied warranty of merchantability, of fitness for the intended use thereof or against infringement are hereby expressly excluded. The applicable warranty ceases to be effective if the goods are altered or repaired other than by persons authorized or approved by Palmieri to perform such work. Repairs or replacement deliveries do not interrupt or prolong the term of the warranty. The warranty ceases to be effective if Purchaser fails to handle and use the goods sold hereunder in a safe and reasonable manner and in accordance with any written instructions from the manufacturers.

**Warranty Does Not Apply To Product Failure Or Loss Resulting From:**

Abuse, misuse or accident, alteration or modification of product by customer or third party, normal wear and tear, improper installation, handling or incorrect use. The substitution of part components or hardware not approved or authorized by Palmieri, acts of God, unauthorized repairs, improper storage, and environmental conditions such as irregular temperature control either inside or outside the environment.

**Warranty Provides Exclusive Remedies:**

If a product fails under ordinary use as a result of a defect in material or workmanship, Palmieri will: (A) repair, or (B) replace the furniture. The replacement or repair of the Furniture or Seating will be at the discretion of Palmieri. If the defect or workmanship cannot be remedied on site, repairs can be made at the factory. (C) If the product repair or replacement is not commercially practicable or cannot be remade in a timely manner Palmieri will refund the purchase price of the affected product. A product **"Defect"** means: an inadequacy in the materials or workmanship of the product that (A) existed at the time when you received the product from Palmieri or Palmieri authorized Reseller and (B) causes a failure of the product to perform under ordinary use in accordance with the materials and documentation accompanying the product. **"Ordinary Use"** means: use of the product (A) in accordance with all applicable local, state or federal laws, codes and regulations and (B) in accordance with manufacturer recommendations and or instructions in the materials and documentation accompanying the product or through shop drawings. A **"Palmieri Authorized Reseller"** means: any dealer that is legally permitted to conduct business in the jurisdiction where the product is sold and is duly authorized by Palmieri to sell the product.

Warranty work must be approved by authorized personnel of Palmieri Furniture Limited in Richmond Hill, Ontario, Canada.

**A copy of the original purchase order must accompany all claims.**

**Warranty Does Not Cover:**

Matching of colours, stains, textures, grains and any other variations in materials. Select and Custom Surfaces and materials are only warranted for their application on the specified product and are not covered by our warranty, except as warranted by the original supplier, for quality, colorfastness, shade variations or abrasion and textiles purchased for Palmieri product.

**This limited warranty is the sole remedy for product defect and no other express or implied warranty is provided. Warranty is not transferable and valid only for the original purchaser acquiring a product from Palmieri or a Palmieri authorized reseller for the purchaser's own use and not for resale, remarketing or distribution. Limited Lifetime Warranty (25 years)**

**GENERAL**

The following Terms and Conditions of Quote and Sale shall apply to any sale of goods and services by Palmieri Furniture Limited (hereinafter called "Palmieri"). Purchaser shall be deemed to have full knowledge of the terms and conditions herein and such terms and conditions shall be binding if either the goods and services referred to herein are delivered to and accepted by Purchaser, or if Purchaser does not within five (5) days from the date hereof deliver to Palmieri written objection to said terms and conditions or any part thereof.

In the event of any conflict or inconsistency between the terms and conditions of sale herein and the terms and conditions contained in Purchaser's order or in any other form issued by Purchaser, whether or not any such form has been acknowledged or accepted by Palmieri, Palmieri's terms and conditions herein shall prevail. No waiver, alteration or modification of these terms and conditions shall be binding upon Palmieri unless made in writing and signed by a duly authorized representative of Palmieri.

**1. QUOTATIONS / PRODUCT QUOTED**

Unless otherwise stated, **Palmieri's quotations shall be null and void unless accepted by Purchaser within thirty (30) days from the date of quotation.** Quotes may be subject to change before order placement, due to increased material costs and or other factors that could impact the final cost of production and our final understanding of the product required. If the items quoted do not reflect the intended product requirements of the customer, Palmieri will not be held responsible for increased costs for those product changes. We reserve the right to edit or re-quote any portion of a previously submitted quotation subject to our final understanding of the product required by the client.

**2. PALMIERI DRAWINGS**

Palmieri provides drawings for Custom & Standard product we produce to our clients upon request. We consider these drawings to be Private and Confidential and are provided for the sole purpose and use of our clients to understand the product we are providing. The use of these confidential materials is limited to the transaction between the parties and at no point are these confidential materials to be sent to any of our competitors or parties quoting for the same purpose.

**A minimum \$ 85.00 NET Engineering Administrative Fee will apply for Custom Product Drawings**

**(Note: The first set of Custom product drawings will be free of charge)**

**A minimum \$ 120.00 NET Engineering Administrative Fee will apply for all Standard Product Drawings**

### 3. TERMS OF PAYMENT

For authorized customers; Orders at a \$ 75,000.00 threshold will require a mandatory 25% deposit. Orders over and above \$ 100,000.00 requires a mandatory (25%) deposit at time of order, a mandatory (25%) deposit prior to product shipment and the balance to be paid within thirty (30) days of date of shipment. Payment not be made to Palmieri when due, Palmieri reserves the right to charge Purchaser with interest on such overdue payments. Interest of 2% per month (24% per annum) is charged on all overdue accounts, unless otherwise specified. The charging of such interest shall not be construed as obligating Palmieri to grant any extension of time in the terms of payment. All goods remain the property of Palmieri, until balance is paid in full to Palmieri.

### 4. TITLE

Title to the goods or any part thereof shall not pass from Palmieri to Purchaser until all payments due hereunder have been duly made, except as otherwise expressly stipulated herein. The goods shall be and remain personal or moveable property, notwithstanding their mode of attachment to realty or other property. If default is made in any of the payments herein, Purchaser agrees that Palmieri may retain all payments which have been made on account of the purchase price as liquidated damages, and Palmieri shall be free to enter the premises where the goods may be located and remove them as Palmieri's property, without prejudice to Palmieri's right to recover any further expenses or damages Palmieri may suffer by reason of such nonpayment.

### 5. TAXES

Prices do not include Goods & Services Tax, Provincial or Municipal sales, use, value-added or similar tax. All applicable taxes are extra. Our Harmonized Sales Tax (HST) registration number is R104055066.

### 6. THE AGREEMENT

An acceptance and official confirmation of Purchasers' order by signing Palmieri's Order Confirmation the Purchaser therefore is accepting terms and conditions as expressed herein Palmieri's Terms and Conditions of Quote and Sale by Palmieri and shall constitute the complete agreement, subject to the terms and conditions of sale herein set forth, and shall supersede all previous quotations, orders or agreements.

### 7. LEAD TIME / DELIVERY / DELAYS

Lead time is determined only when final material/finish selection and drawing approvals are received by Palmieri from the client. The accuracy of Palmieri's lead times, is created to the best of our ability with the information provided to us. Confirmed lead time is conveyed to the client by means of Order Confirmation. They do not preclude the client from checking the accuracy of your requirement and our Order Confirmation. Any noted discrepancies are to be reported immediately to Palmieri Customer Service Department for correction and re-issue of revised Order Confirmation. By signing and dating the Order Confirmation the client accepts the terms and conditions of quote and sale.

Lead time on our Order Confirmation do not account for delays that could potentially occur for special materials specified by the client that are outside of our standard finishes and materials program that are out of our control and will affect the lead time on the order. Palmieri will notify the client immediately when these delays occur and adjust the lead time accordingly.

Delivery schedules are approximate and are based on prevailing market conditions applicable respectively at

the time of Palmieri's quotation and Palmieri's acceptance of clients' order, if certain portions of an order are completed by the quoted lead time while other portions have experienced delays outside of our control. The client may choose to part ship the order at their discretion and expense. Otherwise the entire order will ship with the delayed portion at a later date. Palmieri may extend delivery schedules or may, at its option, cancel Purchaser's order in full or in part without liability other than to return any deposit or prepayment which is unearned by reason of the cancellation.

### 8. CHANGES AND CANCELLATION

Orders accepted by Palmieri are not subject to changes or cancellation by Purchaser without the written consent of Palmieri. In such cases where Palmieri authorizes changes or cancellation, Palmieri reserves the right to charge the Purchaser with reasonable costs based upon expenses already incurred and commitments made by Palmieri, including, without limitation, any labour done, material purchased and also including Supplier's usual overhead and reasonable profit and cancellation charges from Palmieri's suppliers. Palmieri will communicate to the Purchaser additional costs incurred by way of Revised Order Confirmation. Revised Order Confirmation will include applicable costs incurred and modification to lead times (if applicable). The Purchaser must provide Palmieri written confirmation of additional costs, before any changes can be processed on the order.

**A minimum charge of \$ 100.00 NET Change Order Request fee will apply**

**A minimum charge of \$ 150.00 NET Cancel Order Request fee will apply**

### 9. SHIPPING LOCATION / SHIPPING QUOTES / COST OF TRANSPORTATION

Unless otherwise stated, all prices are F.O.B. our factory in Richmond Hill, Ontario, Canada.

Customary methods of transportation shall be selected by Palmieri and such transportation will be at Purchaser's expense. Shipping quotations are made at time of furniture quotation and are outside the control of Palmieri. **Shipping quotes are valid for ten (10) business days from the time of quote.** We do our best to maintain shipping costs as quoted, however all shipping weights and cubic feet shown are approximate only, various construction materials and packaging methods may add to the weights given. All quoted prices, unless otherwise stated on the quotation, are based on the current exchange rates, tariffs, fuel surcharges and costs of manufacture and are subject to change by Palmieri with or without notice until Purchaser's acceptance. Palmieri does not assume responsibility or liability for shipping costs, product during transit, or variances from the shipping weights or cubic feet shown in our specification guides. Special methods of transportation will be used upon Purchaser's request and at Purchaser's additional expense, provided reasonable notice of Purchaser's transportation requirements are given by Purchaser to Palmieri prior to shipment. Palmieri will notify the client prior to shipping product if shipping costs as quoted change, at which point the client must approve the adjusted shipping costs.

### 10. RECEIVING PRODUCT / REPORTING DAMAGE / STORAGE OF PRODUCT

Upon receipt of Palmieri product, the receiver of the goods must immediately inspect the product to ensure it is free of shipping damage. If the product is deemed in good order, the receiver of the product must ensure

to sign off on the accompanying carriers Bill of lading in good condition. Except for obligations stated under "Warranty" herein, Palmieri's responsibility for the product ceases once the product has been received and signed off in good order and is the full responsibility of the receiver and subsequently the owner.

In the event shipping damage is discovered during receipt of shipment, it is the responsibility of the receiver to ensure all noted damage is recorded on the carrier's Bill of Lading prior to sign off. All noted shipping damage claims must be reported to Palmieri within **24 hours** of receipt of the product onsite, failure to do so will result in the claim being deemed null and void. All shipping damage claims are to be reported directly to Palmieri's Shipping Manager. Please call our toll free number at **1-800-413-4440 ext. 33** or submit the claim by Fax directly to **1-905-731-9878**. Palmieri will not accept any shipping damage claims submitted **after 24 hours** and it shall be conclusively presumed that the goods were delivered in good condition.

Storage of product, Palmieri will not be held responsible for any potential damages or shortages for product shipped and received by Purchaser and is subsequently placed into storage and not inspected within 24 hours of receipt.

## 11. INSTALLATION / SHORTAGES / BACK CHARGES

Unless otherwise expressly stipulated, the goods shall be installed by and at the risk and expense of Purchaser.

In the event that Palmieri is requested to supervise such installation, Palmieri's responsibility shall be limited to exercising that degree of skill customary in the trade in supervising installations of the same type. Purchaser shall remain responsible for all other aspects of the work including compliance with the local regulations. It is the responsibility of the Purchaser to ensure hardware and parts are received in good order. Packing slip and hardware list to be provided by Palmieri with every order at time of shipping. Purchaser has the responsibility to notify Palmieri immediately without delay of issues that arise; subsequently Palmieri will take action to provide prompt resolution.

Shortages must be reported to Palmieri within **24 hours** of receipt of the goods and failure to do so may be at the expense of the Purchaser.

If deemed missing hardware and parts short shipped from the factory, Palmieri will arrange to ship freight prepaid to destination. Palmieri will only be responsible for replacement costs of missing hardware and parts, any labour costs incurred will be the responsibility of the Purchaser and will not be approved by Palmieri.

Back Charges will only be approved if we deemed a defect in the material or workmanship is found during the installation period resulting in a return trip to the job-site to complete installation. It shall remain the sole discretion of Palmieri to approve (A) repair or (B) replace the furniture and any labour costs incurred by the Purchaser.

## 12. FORCE MAJEURE

Palmieri shall not be responsible or liable for any loss or damage incurred by Purchaser herein resulting from causes beyond the reasonable control of Palmieri including, but without limitation, abuse, misuse or accident, alteration or modification of product by customer or third party, normal wear and tear, improper installation, handling or incorrect use, unauthorized repairs, the substitution of part components or hardware not approved or authorized by Palmieri, improper storage, and environmental conditions such as irregular temperature control

either inside or outside the environment, acts of God, fire, flood, delays in transportation, or the failure of Palmieri's suppliers to meet their delivery promises. The acceptance of delivery of the goods by Purchaser shall constitute a waiver of all claims for loss or damage due to any delay whatsoever.

## 13. RETURNED GOODS

No goods may be returned to Palmieri for a credit or exchanged without Palmieri's prior written consent.

Palmieri reserves the right to accept all returns and subject to a handling/restocking charge or to decline all returns. Even after Palmieri has authorized the return of goods for credit, Palmieri reserves the right to adjust the amount of any credit given to Purchaser on return of the goods based on the conditions of the goods on arrival in Palmieri's warehouse. Credit for returned goods will be issued to Purchaser only where such goods are returned by Purchaser and not by any subsequent owner of the goods. Goods will be considered for return only if they are in their original condition and packaging. Palmieri Goods Return Authorization Form to be issued and **must** accompany all shipments returning back to the factory. **Return freight must be prepaid by Purchaser. A minimum 20% re-stocking fee will apply.**

# PALMIERI

create. communicate. collaborate.

---

Palmieri Furniture Ltd.

1230 Reid Street  
Richmond Hill  
Ontario Canada L4B 1C4

T: 905 731 9300  
F: 905 731 9878  
TF: 800 413 4440

E: [info@palmierifurniture.com](mailto:info@palmierifurniture.com)  
W: [www.palmierifurniture.com](http://www.palmierifurniture.com)