



THE COUNTIES

188



www.bridge-wcba.com

Vol. LI No. 3

Published by Westchester Contract Bridge Association

September 2009

SEE YOU THERE !

- ◆ September
- ♥ (North American 49er Pairs Month)
- ♣ 9 ACBL Instant Matchpoint Game Wednesday eve at clubs
- ◆ October
- ♥ 12-18 District 3 Regional Danbury, CT
- ♣ 25 District 3 NAP Finals Allendale, NJ (All Flights) Schenectady, NY (Flights B & C ONLY)
- ◆ November
- ♣ 6-7 Jane Hill Future Masters Sectional Methodist Church White Plains, NY
- ♣ 15 Unit Charity Swiss Teams Bridge Deck Scarsdale, NY
- ♥ 18-24 STAC Week Various Clubs
- ♣ 26- NABC
- ◆ Dec. 6 San Diego, CA
- ♥ 30 ACBL Charity Game Mon. eve at clubs

Jane Hill Future Masters Sectional

0-100 Master Points

November 6 & 7, 2009



Prizes!

FRIDAY
 9:30 am Stratified (0-20, 20-50, 50-100)
 1:00 pm Stratified (0-20, 20-50, 50-100)

SATURDAY
JANE HILL TROPHY
 11:00 am Stratified (0-20, 20-50, 50-100)
 Complimentary Lunch and Snacks



For questions or pairings contact:
Robert Wachtenheim (914) 472-3829
robwa@optonline.net

For results:
www.bridge-wcba.com

MEMORIAL UNITED METHODIST CHURCH
250 Bryant Ave., White Plains, NY 10605

Directions:

- A) Hutchinson River Parkway to Exit 25. North on North St, to Bryant Ave. Turn left. Church is ¼ mile on right.
- B) I-287 East to Exit 8E (Westchester Ave.) At end of exit turn right at traffic light onto North St. At second traffic light, turn right onto Bryant Ave.. Church is ¼ mile on right.

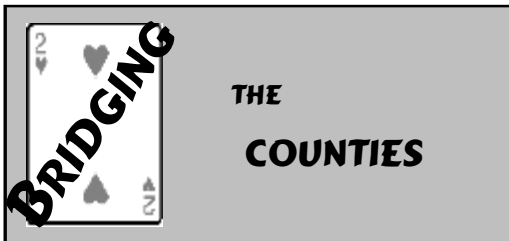

**THE
COUNTIES**

PRESIDENT'S MESSAGE

BRIDGING THE COUNTIES (ISSN 1059-3586) is published (quarterly) four times a year in March, June, September and December by the Westchester Contract Bridge Association, 2 Carriage Way, White Plains, NY 10605. Periodicals postage is paid at White Plains, NY. POSTMASTER: Send address changes to: *Bridging the Counties*, 2 Carriage Way, White Plains, NY 10605.

**WESTCHESTER CONTRACT
BRIDGE ASSOCIATION**
Robin Brown, *President*

Editor Jason Fuhrman
21 Alkamt Avenue, Scarsdale, NY 10583
E-Mail: jayshell@pipeline.com

www.bridge-wcba.com
www.bridge-district3.org
www.acbl.org

STAFF

Associate Editor.....Bob Goldwater
ProofreadingMichelle Fuhrman

Robin Brown.....Kassie Munoz
Marshall Frank.....Nancy Sahlein
Michelle Fuhrman.....Judy Soley
Joan Levy Gerard.....Joel Sommer

We are living in an age of technology. This technology has reached the bridge table where it has become both a blessing and a curse. Dealing machines are finding their way into bridge clubs and tournaments. With the help of dealing machines, when you sit down at the bridge table, the cards are already shuffled and dealt for you. Now you don't have to worry that you cannot participate in the ritual of shuffling and dealing because you just had your nails done, your hands are too arthritic, you cut your finger, or any of the other excuses you have come up with in the past. At least during the pairs games, the shuffling and dealing has been done for you.

I do confess that I, personally, miss the shuffling. I love the way the cards feel as I shuffle them. But there's always the team games and I'd give up the shuffling in a heartbeat in return for the hand records that come with the pre-dealt boards. What a terrific learning tool! I like to go home after the game and look over the hand records and figure out what went wrong or what we did right. I like to look at the different lines of play I thought about at the table to see what would have worked out best. And I like to

see where my bidding could improve. So much to be learned from one sheet of paper!

Not only do we no longer need to shuffle and deal, but with the new Bridgemate scoring machines, we don't have to fool around with those pesky pickup slips and travelers. These nifty little boxes have eliminated the "someone has written on my line" problem, the bad handwriting problem and the director accidentally entered the wrong score problem. Of course there is a downside – Bridgemate Etiquette. So, for those of you who aren't sure how to behave around these boxes here's a short lesson.

First, as with all the paperwork they have replaced, North-South are in charge. After punching in the board number, the contract, and the result, Bridgemate asks for East-West verification. North-South, this is when you hand your new toy over to the East-West pair. To keep us all honest, they, not you, must approve the score you entered. After approving the score, East-West must share the results with North-South. It isn't important who clicks through the results screen as long as a North-South player and an East-West player can both see the screens if
(continue on page 3)

**Editor's
Corner**



As you advance as a player, you start playing the game differently. You develop skills in counting and hand visualization that will greatly improve your play. You will also begin looking at your own cards differently.

Countless articles and books have been written about hand evaluation. New players first learn about the 4-3-2-1 point count system. Then they learn about distributional points - shortness and length in suits. Some even learn about quick tricks, although that is rarer in these days of more aggressive bidding.

Later, you find about the benefits of double fits and the drawbacks of misfits. You upgrade your hand when fits are found, and down grade when the hands don't fit well. The "Rule of 20" for opening bids can come into play.

Even later, you learn that what you were taught before was oversimplified and wrong. The inadequacies of the 4-3-2-1 HCP system are brought out - the undervaluation of aces and kings, the overvaluation of queens and jacks. People say why they believe that not every "Rule of 20" hand should be opened. You learn to count losers and winners

instead of just counting points. This approach of simplifying things for beginners, and then later un-learning the early teachings is not unique to bridge. When I was a competitive ballroom dancer, they did exactly the same thing. They taught you steps to get you started, and then later went back to the beginning and restarted teaching you the "right way" from scratch.

I get the concept, and understand why its done this way. But it can be frustrating for the student at times.

During a recent knockout match against a good team, there were several of these hand evaluation issues that came up. I was surprised on two particular hands at the mis-evaluation done at the other table. One was a hand with average HCP but few "losers", so for us it went 1♠-2♠-4♠, making. They stopped in 2♠ at the other table.

On the other hand, I opened the bidding at my table with 1♥, and was raised to 2♥ (constructive raise). I looked at my hand with its extra HCP, and considered what to do. I decided with a six-loser hand, there was no way 4♥ was making, as partner couldn't cover three losers. They bid 4♥ and went down.

Jason Fuhrman

This N' That From Your District Director

This has been an exciting late Spring and Summer for me and for District 3. I was the negotiator for the World Bridge Federation in its effort to bring the World Bridge Series to the United States. Starting with a \$100,000 donation from the ACBL Board of Directors, the United States Bridge Federation then pledged an additional \$200,000 to make it possible to hold this world event here in the US. A strong desire on the part of Joanne and Danny Sprung to host this event in Philadelphia came to fruition when the hotels, the convention center and bureau all cooperated and offered a great package to the World Bridge Federation. This spectacular tournament will be held October 1-16, 2010. The world events are open to all and in addition there will be a 14 day Regional at the same location. Great fun, great bridge for everyone!

The United States Team Trials were held in White Plains the beginning of June. Several of our

Westchester players participated and others volunteered to do vugraph and hospitality. The Saratoga Springs Regional followed on the heels of the Trials. It was back on our traditional date and it was surely successful, The table count exceeded 2006 when it was on these dates, was a bit larger than 2007, and the same as 2008. Most of the players loved the schedule which included 2 Senior events at 10am, loads of KOs, Compact KOs and a bracketed RR Swiss.

Immediately following Saratoga came our Holiday Regional in Fairfield, NJ over the July 4 weekend. A great location for our central Jersey members and less than an hour from Westchester. Attendance was great except for July 4. We just can't fight those family outings, barbeques and the beautiful sunny weather.

Fall foliage! Come and see the beautiful fall leaves at our Danbury, CT regional, October 12-18. Great room rates, games for everyone and

wonderful hospitality. Jerry Fleming, ACBL president will be attending this regional. He will be pleased to talk with any of you and answer questions about the ACBL. In addition, we are having a special game for youth 19 and under with less than 20 MPs on Thursday from 5pm – 7:45pm. The game is free and a light supper will be served. And of course trophies will be awarded to the winners.

I certainly hope that you all qualified to play in District 3's North American Pairs Finals which will be held at the Guardian Angel Church in Allendale, NJ on Sunday, October 25. Start off with a fabulous brunch followed by two sessions of bridge. Gold points for all the overall winners, and 1st – 3rd places earn the right to represent District 3 at the Spring NABC in Reno.

As always, if there are any issues you would like to discuss, e-mail me at: joanandron@att.net.

Joan Gerard, District Director

Advice for Snowbirds

Even if you will be gone for several months this winter, you can still remain a member of the WCBA and continue receiving *Bridging the Counties*.

When you contact the ACBL with your winter address, let them know that you wish to remain a member of Unit 188 (WCBA). Any issues of *Bridging the Counties* that are published while you are away will be mailed to your winter address. Upon your return to Westchester, just tell the ACBL that you are back home. Don't miss a single issue!

If you move away and notify the ACBL that you want to keep your WCBA membership, you will continue to receive *Bridging the Counties*. However, if you do not notify the ACBL that you want to keep your Unit 188 membership, it will automatically be transferred to the Unit of your new residence. You can always view and download a copy of *Bridging the Counties* from our website <http://www.bridge-wcba.com>.

President's Message (Cont.)

they want to. You don't have to look if you don't want to, but you should have the option to look. Let's see if we can all work together to make playing bridge in Westchester as pleasant as possible. Why do I feel like the Hat Lady? (Y'all play nice...)

Any while you're playing nice, let's be generous as well. We have a Charity Swiss game coming up on November 15th. This game will benefit two local charities, Hospice & Palliative Care of Westchester and the Anatol & Arthur Charitable Foundation as well the Westchester chapters of two national charities, Autism Speaks and the United Way. We are very excited that our local monies will go to support local causes. To raise money, in addition to the bridge game, there will be a silent auction. In order to make this event profitable, we need items for auction. If you would like to donate, please contact me.

Another way that you can be generous is to donate your time. The unit needs volunteers to work on our events. We run many tournaments every year, the Closed Westchester, the Unit Swiss, the Charity Swiss, the Jane Hill, the Master/Non-Master game, the Bob Katz Spring Sectional, the Peter Kalat Summer Sectional and the Double Knockout). A lot of work goes on behind the scenes to make these tournaments a success. We could use your help. Even if your time is limited, there is always something small you can do. Please consider volunteering to help with at least one of these events. In addition, we are putting out a new directory. You can volunteer to help with this. Volunteer to help and give back to the game that has given you so much!

- Robin Brown

2009 Westchester Double Knockout Bracket 1

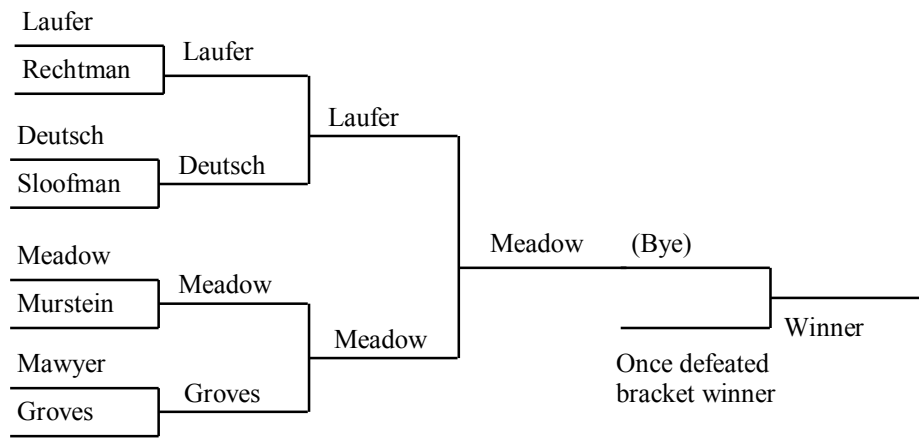

*The undefeated bracket leader will play the once defeated bracket leader to determine the overall bracket winner. The undefeated bracket leader needs to win once to become the winner. However, the once defeated bracket leader needs to win twice to become the winner.

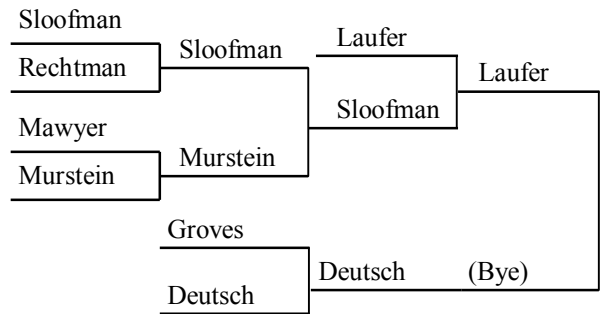

2009 Westchester Double Knockout Bracket 2

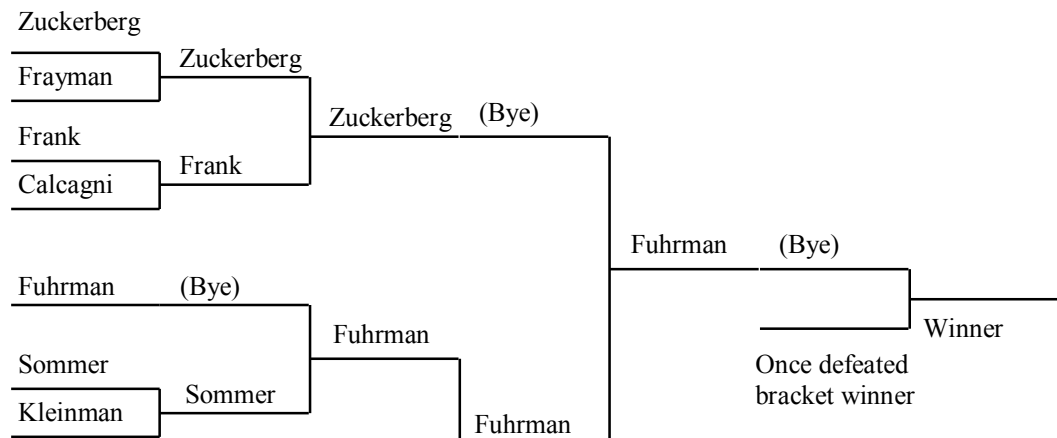

*The undefeated bracket leader will play the once defeated bracket leader to determine the overall bracket winner. The undefeated bracket leader needs to win once to become the winner. However, the once defeated bracket leader needs to win twice to become the winner.

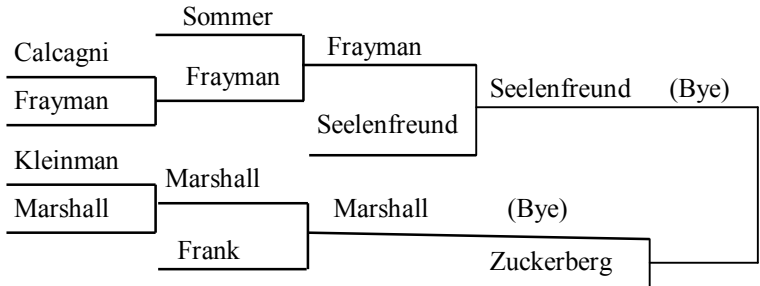

2009 Westchester Double Knockout Bracket 3

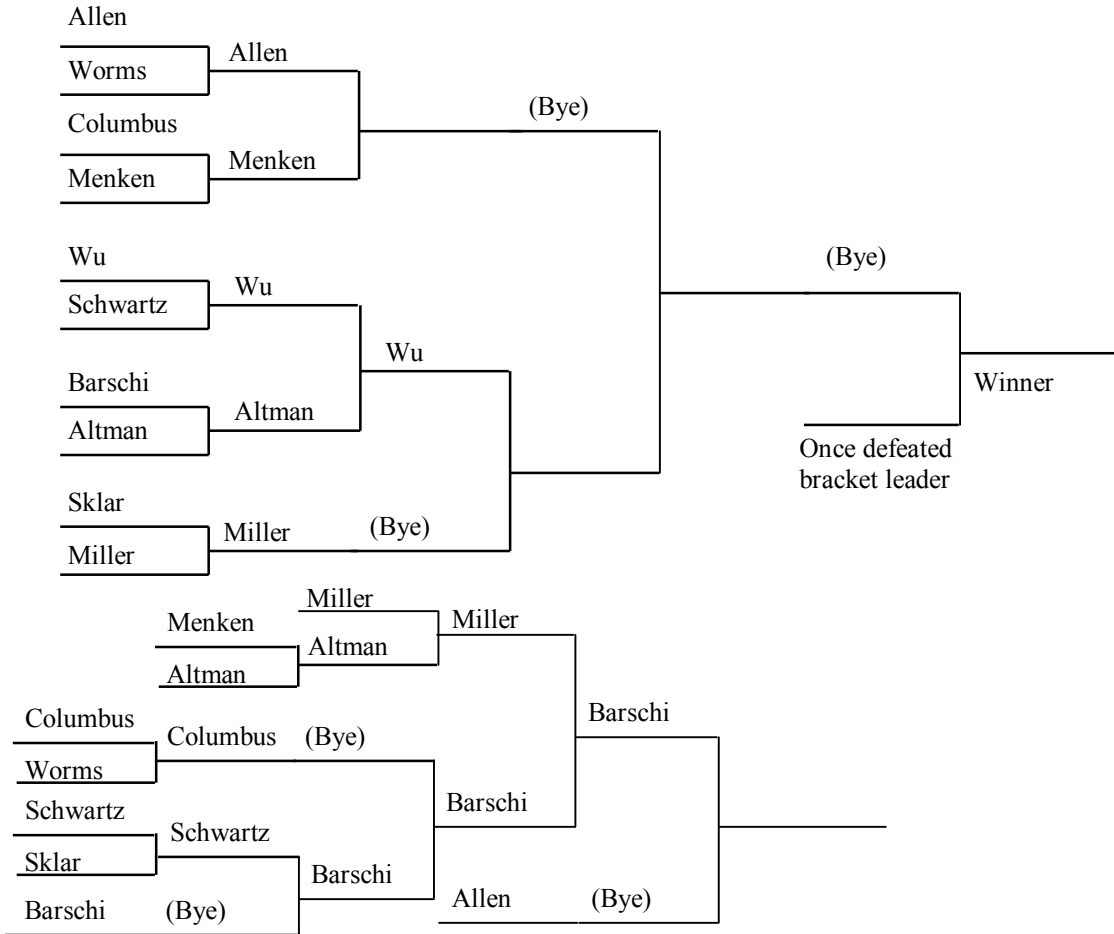

*The undefeated bracket leader will play the once defeated bracket leader to determine the overall bracket winner. The undefeated bracket leader needs to win once to become the winner. However, the once defeated bracket leader needs to win twice to become the winner.

NAP Finals Scheduled

Next on the schedule for the NAPs will be the District level finals. A two-session District final for all flights will be held on October 25 at the Guardian Angel Church in Allendale, NJ. There will also be an additional District final for Flights B and C only at the Studio of Bridge and Games in Schenectady, NY. You can see details and directions at: <http://www.bridge-district3.org/nap2009.htm>

The Club rounds, which occurred over the summer, allowed areas players to earn a qualification to play at the District final. Only players who have already earned their qualification this year and reside in District 3 can play in the District final.

The top three finishers in each flight at the District finals will be eligible to play in the National Finals, which will be at the 2010 Spring NABC in Reno, NV in March.

7th ANNUAL BRUNCH AND CHARITY SIWSS TEAMS SUNDAY, NOVEMBER 15, 2009

Come for the Brunch, the Silent Auction and the Bridge
Bridge Deck, 313 Central Avenue, Scarsdale

| | |
|---|--|
| <p>BRUNCH BRIDGE GAME</p> | <p>Begins at 11:30 AM. Game time is 12:30 for four 6-board matches. Sectionally rated black points. Teams can be 4-6 players. Entry fee of \$68 per team includes brunch and the game.</p> |
|---|--|

Charities this year are the Westchester Chapter of United Way; Westchester Chapter of Autism Speaks; Hospice & Palliative Care of Westchester; and Anatol & Arthur Charitable Foundation. Checks may be written to the charity of your choice. Last year's event raised over \$15,000 and we can do even better with your support!

For information about the event or to donate items to the Silent Auction, please contact Robin Brown by phone at 914-478-1336, or by e-mail to rkb155@yahoo.com.

June Overall STAC Winners

Monday Morning Open Pairs

A B C
 1 Richard DeMartino, Lawrence Lau
 1 1 Deborah Kessler, David Florence

Monday Afternoon Invitational

A B C
 1 Eda Newhouse, John Kaufman
 1 1 Warren Heilbron, George Karp

Monday Afternoon Open Pairs

A B C
 1 Gerald Cohen, Joan Meyer
 1 1 Rita Shearer, M. Thompson

Monday Afternoon NLM Pairs

A B C
 1 1 Dorothy Baer, Richard Strauss
 1 Barbara & Harold Bell

Monday Afternoon 299er Pairs

A B C
 1 1 Bob Blasé, Michael Lopukhin

Monday Evening Open Pairs

A B C
 1 1 Jay Sloofman, Robert Blau
 1 Carolyn & Phil Farin

Tuesday Morning Open Pairs

A B C
 1 1 Leslie Davies & Charles Selig
 1 A. Scuccimarra, T. Schwartz

Tuesday Afternoon Open Pairs

A B C
 1 1 Yvonne Fritz, William Evers
 1 Helma Price, Marie Riggins

Tuesday Afternoon NLM Pairs

A B C
 1 Barbara Cleveland, Elinor Haight
 1 Sheila Cohen, Judith Seslowe
 1 Susan Cutler, Adria Reinglass

Tuesday Afternoon 0-750 Pairs

A B C
 1 1 Sandra Ostrellich, Barry Ikler
 1 Mary Ann Suen, Sandra Rohner

Tuesday Evening Invitational Pairs

A B C
 1 1 Addie Hurst, Daniel Siesel
 1 Mel Perlman, Mary Creamer

Tuesday Evening Open Pairs

A B C
 1 Bill Maine, Dennis Kaye
 1 Iain Keddie, Gabor Drasny

Tuesday Evening Open Swiss

A B C
 1 M. Gambacorta, B. Arnold,
 Marcia & Robert Warner
 1/2 Alice Netter, Cyril Jalon,
 Nicholas Aslanow, Audrey Stamm
 1/2 Jan Wild, Alisan Harte,
 David Katzman, Gordon Kiernan
 1 Wendy Sklar, Bill Hessberg,
 Jeffrey & Zach Marshall

Wednesday Morning Open Pairs

A B C
 1 1 1 Susan Drucker, Ilana Nowick

Wednesday Afternoon Open Pairs

A B C
 1 Rhoda Levine, Lynne Weiss
 1 Betty Krakeur, Betty Salzer
 1 Rosemary Isele, Harold Bigelow

Wednesday Afternoon NLM Pairs

A B C
 1 1 Ellen Reller, Robert Rubinstein
 1 Susan O'Brien, Irving Rochelle

Wednesday Afternoon NLM Pairs

A B C
 1 1 Ellen Reller, Robert Rubinstein
 1 Susan O'Brien, Irving Rochelle

Wednesday Afternoon 0-500 Pairs

A B C
 1 1 Bob Blasé, Kala Fleigh

Wednesday Afternoon Invitational Pairs

1 Susie Marx, Patricia Cuning

Wednesday Evening Open Pairs

A B C
 1 1 John Vary, Jonathan Insel
 1 Diane & Robert Freer

Thursday Morning Open Pairs

A B C
 1 Yoko Ohnuma, Rhoda Levine
 1 Genevieve Porti, Phyllis Spatz
 1 Abbye Bosses, Margie Brooke

Thursday Afternoon Open Pairs

A B C
 1 Susanne Rudick, Norman Rubin
 1 Maureen Kennedy, Margery Martin
 1 Kenny Howe, Mary Sue Saltsman

Thursday Afternoon NLM Pairs

A B C
 1 Gloria Shulman, Gloria Parower
 1 Dorothy Baer, Denise Resnik
 1 Margaret Chase, William Diamant

Thursday Afternoon Limited Pairs

A B C
 1 Barbara McDonald, Nancy Streeter
 1 Martha Precheur, Sandra Ostrellich
 1 Barbara & John Flynn

Thursday Afternoon Invitational Pairs

A B C
 1 1 Florence Olsen, Eleanor Blanco
 1 Gary & Susan Loewenberg

Thursday Evening Small Pairs

A B
 1 Walter Smith, Satya Pabuwal
 1 Robert & Bernard Neuhart

Thursday Evening Open Pairs

A B
 1 1 Neal Rechtman, Peter Bittle

Friday Morning Open Pairs

A B C
 1 Cliff Nebel, Lawrence Brown
 1 Elise Luskin, Amy Frolick
 1 Toni Cobb, Lorraine Gelardi

Friday Afternoon Open Pairs

A B C
 1 Marge Meenagh, Lynn Baker
 1 Barbara LoPrete, Bernie Snyder
 1 Ed Davidson, Armond Schiff

Friday Afternoon NLM Pairs

A B C
 1 Bill & Chris Bennett
 1 Sheila Cohen, Judith Seslowe
 1 Minnie Katz, Stanley Weiner

Saturday Small Clubs Pairs

1 Charlene Sunderland, Martin Birnby

Saturday Afternoon Open Pairs

A B C
 1 Lucette & Eugene Flanagan
 1 Alan Green, Tim Baird
 1 Joanne Kuebler, Hollister Sturges

Sunday Afternoon Open Pairs

1 Margaret & William Peruzzi

Sunday Afternoon Swiss Teams

A B C
 1 Nancy Molesworth, Halina Jamner,
 Neil Littmann, Elliot Minsker
 1 Marian Rubin, Jeffrey Marshall,
 Patricia Wood, Lorraine Hinds
 1 Beverly Kostrinsky, Valerie Scher,
 Leia Berla, Sara Sheperd

WCBA 2009 Peter Kalat Summer Sectional Results

Friday Morning Open Pairs

| A | B | C | |
|---|---|-----|-----------------------------------|
| 1 | | | Lucette & Eugene Flanagan |
| 2 | | | Faye Marino, Mimi Bieber |
| 3 | | | Robert Heitzman Jr., Kelley Hwang |
| | 1 | | Dorothy Miller, Pauline Gutelle |
| | 2 | | Jerome Miller, Bud Rottman |
| | 3 | 1 | Alice & Elliott Weinstein |
| | | 2/3 | Sally Nathanson, Barbara Rosmarin |
| | | 2/3 | Robert Klopp, Charles Heckman |

Friday Morning 199er Pairs

| A | B | C | |
|---|---|---|---------------------------------|
| 1 | 1 | 1 | Florence Zinman, Michael Mahony |
| 2 | 2 | | Nancy Matthews, Linda Wyse |
| 3 | 3 | 2 | Donna Doyle, Carol Kesmodel |
| | | 3 | William Hayes, Walter Schroeder |

Friday Afternoon Open Pairs

| A | B | C | |
|---|---|---|-------------------------------|
| 1 | | | Leslie Paryzer, Phyllis Quinn |
| 2 | | | Joan Gerard, Dennis Newman |
| 3 | | | L. Christianson, S. Meyers |
| | 1 | | Jack & Rozi Alhale |
| | 2 | | Edythe Levitt, Bonnie Gregge |
| | 3 | | Richard Franklin, Peter Stein |
| | | 1 | Carol & John Loomis |
| | | 2 | Valerie Scher, Karen Sanders |
| | | 3 | Jill Fouad, Karin Olsen Nye |

Friday Afternoon 199er Pairs

| A | B | C | |
|---|---|---|----------------------------------|
| 1 | | | Robert Friedman, Harvey Skolnick |
| 2 | | | Harold Samuels, John Howard |
| 3 | 1 | 1 | Florence Zinman, Michael Mahony |
| | 2 | 2 | Donna Doyle, Carol Kesmodel |
| | 3 | | Margaret Lynch, Patricia Forhan |
| | | 3 | Alice Appel, Fleurette Cassara |

Friday Evening IMP Pairs

| A | B | C | |
|---|---|---|-------------------------------------|
| 1 | | | L. Christianson, S. Meyers |
| 2 | 1 | 1 | Laura Schisgall, Stanley Sterenberg |
| 3 | | | Kelley Hwang, Robert Heitzman Jr. |
| | 1 | | David Yates, Melissa Baker |
| | 2 | | Richard Rosenthal, Tim Baird |
| | 3 | 1 | Betty Heller, Christopher Wang |
| | | 2 | Alice & Elliot Weinstein |
| | | 3 | Adam Cohen, Derek Schnelein |

Saturday Morning B/C/D Pairs

| B | C | D | |
|---|---|---|----------------------------------|
| 1 | 1 | 1 | Andrew Cornett, Ellen Gottlieb |
| 2 | | | Steven & Donald Lockwood |
| 3 | 2 | 2 | Carol & John Loomis |
| | 3 | | William Wood Jr., Lorraine Hinds |
| | | 3 | Michael Mahony, Arthur Ziffer |

Saturday Morning 199er Pairs

| A | B | C | |
|---|---|---|----------------------------------|
| 1 | 1 | | Ann Barton, Barbara Leon |
| 2 | | | Josephine Corban, Donna Doyle |
| 3 | 2 | | Mitzi & Sidney Tilles |
| | 3 | 1 | Ellen Tilzer, Rebecca Margulies |
| | | 2 | Jeffrey & Deborah Marshall |
| | | 3 | Sherrill Werblood, Myra Goldberg |

Saturday 2 Session A/X Pairs

| A | X | |
|---|---|------------------------------------|
| 1 | | Bob Gwartzman, Ira Ewen |
| 2 | | Robert Heitzman Jr., Helen Raleigh |
| 3 | | Arch McKellar, Chuck Lamprey |
| | 1 | Michael McNamara, Marius Agica |
| | 2 | P. MacCuaig, A. Shollenberger |
| | 3 | Jack & Rozi Alhale |

Saturday Afternoon B/C/D Pairs

| B | C | D | |
|---|-----|---|---------------------------------|
| 1 | 1 | | Robert Krissoff, Harry Madoff |
| 2 | | | Barbara Metselaar, Ruth Gundell |
| 3 | | | Christopher Wang, Brad Calcagni |
| | 2 | 1 | Pauline & Frederic Raiff |
| | 3/4 | | Jacob & Elaine Rabinowitz |
| | 3/4 | | Sandra Aldrich, Betty Heller |
| | | 2 | Diane Storey, Marvin Lerman |
| | | 3 | Ellen Reller, Sara Kaminker |

Saturday Afternoon 199er Pairs

| A | B | C | |
|---|---|---|-------------------------------|
| 1 | 1 | 1 | Barry & Jay Kaplan |
| 2 | 2 | 2 | George Trost, William Sigward |
| 3 | | | Dotty Brust, Wanda Van Woert |
| | 3 | 3 | Edith & David Binhak |

Sunday A/X Swiss Teams

| A | X | |
|-----|-----|---|
| 1/2 | 1/2 | Dede Pochos, Robert Stayman, John Boyer, Ellyn Plato |
| 1/2 | 1/2 | Stephanie Russo, Maria Tsoukalas, Marius Agica, Daniel Wolkowitz |
| 3 | | Glenn Robbins, Bob Gwartzman, Sylwia & Michael McNamara |
| | 3 | Lorraine Cable, Peter Bonfanti, Shelly Dunietz, Bill Begert |

Sunday B Round Robin Teams Bracket 1

| | |
|---|--|
| 1 | Ruth Fennessy, Joanne Marks, Judith Chaice, Marjorie Murstein, Susan Duval |
| 2 | Robert Klopp, Brenda Harvey, George Holland, Carl Palmer |
| 3 | Martin Barschi, Florin Neamtu, Susan Katz, Charlotte Piuck |

Sunday B Round Robin Teams Bracket 2

| | |
|---|---|
| 1 | Susan Denenholz, Matt Rewinski, Sandi & Terry Sullivan |
| 2 | Pat Brasher, Barbara Moore, Marcia & Sandy Clark |
| 3 | Susan & Gary Kellman, Alain & Paulette Bollag |



2010 Membership Directory Advertising

The 2010 WCBA membership Directory will be published in December 2009 and distributed to more than 1,600 members in Westchester and Putnam Counties. There will be advertisements by area businesses. If any one is interested in having their business listed, please contact Marshall Frank at 914-238-9379 or mefrank@optonline.net. Ad rates run from \$450 for the inside front and back covers to \$75 for one-eighth of an inside page. The Membership Directory will be constantly referred to by Unit members for the next 5 years.



TRAVELING SCORES



Please send Traveling
Scores To:

Judy Soley
30 Griffen Avenue
Scarsdale, NY 10583
- OR -
judy@soley.com

Palm Beach Gardens Regional

Wednesday Open Pairs
Carlos Munoz 3rd OA

Thursday Open Pairs
Carlos Munoz 1st/2nd OA

Saratoga Regional

Thursday Stratified Swiss
Carlos & Kassie Munoz,
Natalie & Dan Hertz 2nd OA

Compact KO Bracket 1
Natalie & Dan Hertz 2nd OA

Eastern States Regional

Open Pairs
Natalie & Dan Hertz 3rd OA

Fairfield Regional

Wednesday Stratified Swiss
Carlos & Kassie Munoz,
Natalie & Dan Hertz 2nd OA

Saturday A/X Pairs
Carlos Munoz & Tom Simon 2nd OA



Roy Hill Master / Non-Master Game

The 33rd annual Roy Hill Master / Non-Master game will be held at the Bridge Deck in the evening of Sunday, December 6.

For this special game, players with fewer than 50 masterpoints are randomly paired with Life Masters. The newly formed partnerships briefly discuss conventions (which are usually determined by what the non-master normally plays), and then compete against each other in a regular matchpoint pairs game. This is a very social event, as well as giving the non-masters a good learning experience.

Pre-registration is required for both the life masters and non-masters. People in both groups who are interested in playing may contact the chairman, by either mailing the form below to Rich Laufer, 65 Catterson Terrace, Hartsdale, New York 10530, or calling him at (914) 949-5853.

The WCBA's 33rd Annual Roy Hill Master / Non-Master Game

Bridge Deck
313 Central Avenue
Scarsdale, NY

Sunday, December 6, 2009

7:00 P.M.

Pre-registration a must! Deadline: November 30, 2009 Entry: \$12.00

Please reserve a place for me at the Roy Hill Master / Non-Master Game on December 6

Name:

Address:

Telephone:

New Life Master

Toni Schwartz



JOURNEY TO LIFE MASTER

About 4 1/2 years ago, a friend suggested that I contact the Bridge Deck for bridge lessons. Little did I realize at the time that this would be the beginning of a journey playing a game which was much more complicated than the “social” bridge I remembered from many years ago. In the class, I learned conventions such as Stayman and Jacoby transfers. After completing three or four classes, I figured I was an “Advanced Beginner” and could progress to the new duplicate game. This was a great deal of fun, but I soon realized that I was nowhere near the level of most of the players. I was starting to have a hint of the complexities of this game and hired a teacher to continue my studies. After

several years of playing with Warren Rosner, I was picking up new conventions such as: Jacoby 2 NT, the Unusual 2NT, take out doubles, negative doubles and the 2 Over 1 system. All of these I learned through my teacher, my partners and opponents at the bridge table. However, I again had a hint of how little I knew when I began to see the complexities of defense and the play of the hand.

I started to go to tournaments and began to understand the excitement of the various kinds of events and how hard it is to get red and gold points. I began to do a lot of reading and attending more courses. I also added more conventions and was extremely excited when my gold card arrived proclaiming me a Life Master. I am realizing that my journey playing bridge is just beginning.

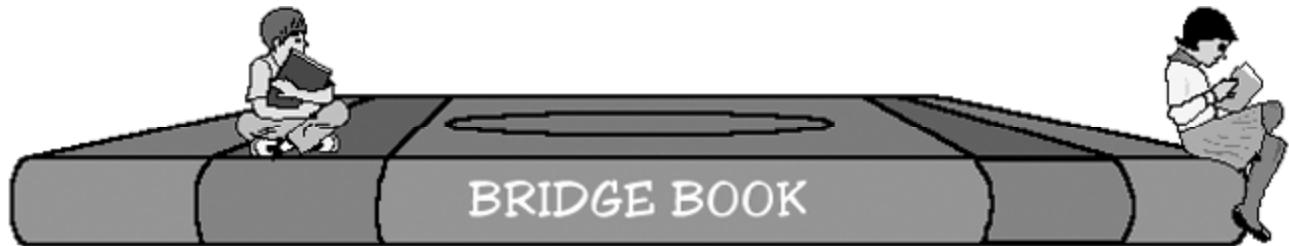

8TH ANNUAL CELEBRATION OF LIFE PEGGY HIRSCHBERG BRIDGE TOURNAMENT

Thursday, October 22nd, 2009
11:30 AM



Lunch and Duplicate Bridge
Beach Point Club ~ Mamaroneck, NY



100% of ticket sales benefit Gilda's Club Westchester
Tickets \$125

Reservations are limited
Please RSVP to Gilda's Club Westchester @ 914.644.8844 x107

Rank Changes

Junior Master (5-20)

Susan Blatt
Carolyn Campe
Stephen Deutsch
Shelly Feiner
Evelyn Frankel
Barbara Howard
Joyce Kaplan
Ellyn Kaye
Mary Ann Kelly
Irwin Labadorf
Ann Levi
Susan Levy
Zach Marshall
Patrick Miller
Susan O'Brien
Patricia O'Connell
Abraham Ofer
Ida Pittman Cardona
Joshua Podell
Frederick Putney
Mary Lynn Putney
Rica Spector
Hanna Strong
Nina Talgo
Doris F Tulcin

Club Master (20-50)

Helen Barasch
James Brucks
Barbara Cirillo
Yvette Cole
Saraine Corn
Ilene Dolans
Eileen Fitzgerald
Wanda Lockwood
Judith Luskin
Helaine Miller
Stanley Ostow
Deborah Richter
Catrina Schmicker
Lynda Sloan
Susan Smithline
Carol Sturtz
Lynn Weinstein

Sectional Master (50-100)

Anne Aldridge
Elinor Baller
Ann Margaret Baum
Irene Bisgier
Anna Caruso
Martin Elgarten
Susan Fisher
Barbara Goldberg

Sectional Master (continued)

Patricia Goldstein
Valarie Goldstein
Ray Haas
Dorothy McCarthy
Phyllis Ossen
Denise Resnik
Todd Schiffer
Richard Tunick
Beatrice Zaslow

Regional Master (100-200)

Paulette Bollag
Norman Gleicher
Patricia Kovacs
Arlene Levy
Raymond Myers
Linda Reavis
Sue Shane
Phyllis Widder

NABC Master (200-LM)

Ellen Reller
Robert A Strasburg

Life Master

Fran Altman
Mort Amstel
Gail Cannold
Leonard Frisks
Yasmine Guenancia
Barbara Heller
Robert Krissoff
Toni Schwartz

Bronze LM (500-1,000)

Gail Cannold
Fran Columbus
Joan Di Palma
Sondra Eichel
Karen Feldman
Yasmine Guenancia
Robert Krissoff
Suzanne Shea

Silver LM (1,000-2,500)

L. Patrick Calahan

Gold LM (2,500-5,000)

Linda Heineman
Yoko Ohnuma
Mira Parikh

Welcome!

New Members

Hope Barkley
Bard Bunaes
Samuel Burton
Judith Camps
Martha Certilman
Lee Corbin
Ralph Dimpel
Vincent Du Vigneaud Jr.
Fred Gervat
Carlotta Gramas
Idan Greenstein
John Grosz
Ash Gupta
Aviva Hurvitz
Jason Kapelus
Jeannie Kligman
Matan Kutno
Rebecca Levy
Marny Lundy
Steven Marcus
Janet Matthews
Romy Pein
Susan Roland
Barbara Santangelo
Jan Savage
Gabriele Shey-Goldstein
Amanda Stern
Arielle Stern
James Tilzer
Lauren Weisfeld
Jane Weiss



| Club directory | Regular Weekly Game Schedule | | | | | | |
|---|--|--|---|---|---|--|-------------------------------------|
| | Mon | Tues | Wed | Thurs | Fri | Sat | Sun |
| The Bridge Deck 313 Central Avenue Scarsdale 949-5853 thebridgedeck.com | 9:30 AM R. Brown Stratified Open 1:00 PM F. Hava Stratified Open R. Laufer Stratified 0-200 7:30 PM E. O'Neill Stratified Open Stratified 0-200 | 9:30 AM M. Frank Stratified 1:00 PM R. Friedman Stratified 1:30 PM S. McNamara Supervised Play | 9:30AM M. Frank Stratified 1:00 PM D. Huber Stratified R. Laufer 0-200 Stratified 1:30 PM N. Sahlein Supervised Play 6:30 PM F. Hava Stratified NLM | 9:30AM B. Hoffman Stratified 1:00 PM Stratified D. Huber 1:00 PM R. Laufer 0-200 Stratified 7:30 PM N. Sahlein Supervised Play 7:30 PM B. Hoffman IMP Pairs | 9:30 AM Stratified R. Brown 1:00 PM B. Hoffman Stratified 1:00 PM R. Laufer 0-200 Stratified | 1:00 PM R. Friedman Stratified | 1:00 PM S. Abelson Stratified |
| The Hartes' Club Armenian Church 1131 North St White Plains 285-1230 hartesclub.com | 9:30 AM Stratified C. Lubesnik 1:00 PM Stratified Open / 0-NLM C. Lubesnik 6:30 PM Stratified C. Lubesnik | 9:30 AM Stratified R. Castellone 1:00 PM Stratified Open / 0-NLM C. Lubesnik 1:00 PM Supervised Play J. Hand 6:30 PM Stratified C. Lubesnik | 9:30 AM Stratified R. Castellone 1:00 PM Stratified Open / 0-NLM R. Castellone | 9:30 AM Stratified S. Abelson 1:00 PM Stratified Open / 0-NLM C. Lubesnik 1:00 PM Supervised Play G. Greenberg S. Becker | 9:30 AM Stratified Y. Shoykhet | 1:00 PM Stratified Open / 0-NLM Y. Shoykhet | |
| Down Two Doubled Heritage Hills Somers 241-0937 | | 7:20 PM Invitational I. Nargi | | 12:30 PM Invitational I. Nargi | | | |
| Larchmont Temple Bridge Club 75 Larchmont Av Larchmont 261-3974 www.cuebid.com/ clubs/Larchmont | | | 7:30 PM B. Calcagni Stratified | | | | |
| Community Bridge Club Lutheran Church Corner of Rte. 172 & Main Street Mount Kisco 241-0937 | 10:30 AM I. Nargi | | | | | | |

Changes & Closings

Larchmont Temple - unless special events require an adjustment, every month the first game of the month is a charity game (triple points), the third game of the month is a charity game with a prize of a free game to the winner (handicapped), and the last game of the month is done with IMP scoring.

Larchmont Temple and Hartes' Club - closed November 25 for Thanksgiving.

Hartes' Club - closed September 28 for Yom Kippur.

Hartes' Club - September 5 is the last Saturday game.

Special Games

| September | | | |
|-----------|---------------|-------------------------|-----------|
| 2 | Larchmont | Charity Game | 7:30 PM |
| 9 | Hartes' Club | Instant Matchpoint Game | 6:30 PM |
| 9 | Bridge Deck | Instant Matchpoint Game | 7:30 PM |
| 9 | Larchmont | Instant Matchpoint Game | 7:30 PM |
| 13 | Bridge Deck | Swiss Teams | 1:00 PM |
| 16 | Larchmont | Handicap Charity Game | 7:30 PM |
| 21 | Hartes' Club | 8 Is Enough Swiss | 6:30 PM |
| 23 | Larchmont | IMP Pairs | 7:30 PM |
| 30 | Larchmont | Inter-Club Championship | 7:30 PM |
| October | | | |
| 5-11 | Bridge Deck | Club Appreciation | All games |
| 7 | Larchmont | Charity Game | 7:30 PM |
| 11 | Bridge Deck | Club Appreciation Swiss | 1:00 PM |
| 14 | Larchmont | Club Championship | 7:30 PM |
| 21 | Larchmont | Handicap Charity Game | 7:30 PM |
| 26-30 | Hartes' Club | Club Appreciation Week | All games |
| 27 | Hartes' Club | Club Appreciation Swiss | 6:30 PM |
| 28 | Larchmont | IMP Pairs | 7:30 PM |
| November | | | |
| 4 | Larchmont | Charity Game | 7:30 PM |
| 11 | Larchmont | Handicap Charity Game | 7:30 PM |
| 18-24 | Various Clubs | STAC Week | All games |
| 22 | Bridge Deck | STAC Swiss | 1:00 PM |
| 24 | Hartes' Club | STAC Swiss | 6:30 PM |
| 30 | Hartes' Club | ACBL-Wide Charity | 6:30 PM |
| 30 | Bridge Deck | ACBL-Wide Charity | 7:30 PM |



Coming Events

BRIDGING THE COUNTIES
2 Carriage Way
White Plains, NY 10605

PERIODICALS POSTAGE
Paid at White Plains, NY

December

6 Master / Non-Master
Bridge Deck

January

8 Closed Westchester
Bridge Deck
9 Closed Westchester
Riverview
10 Golden Apple Swiss
Bridge Deck
12-18 District 3 Regional
Rye Town Hilton

February

6 Internat'l Fund Game
Various Clubs
22 ACBL-Wide
Senior Pairs Game
Various Clubs



Copy Closing
for next issue:

October 20, 2009

DEADLINE



Next Board Meeting
October 24, 2009, 10:00 AM

**District 3 Autumn Leaf Regional
Danbury CT — Oct. 12-18, 2009**

The Danbury Plaza Hotel and Conference Center
18 Old Ridgebury Road • Danbury CT 06810 • 203-794-0600
\$90 Single/double plus applicable taxes.

Reservation Deadline — September 29, 2009 Bridge rate rooms may sell out before deadline.
Room Problems — Check with Joan Gerard 914-948-0841 joanandron@att.net

*Welcome to our
ACBL President -
Jerry Fleming*

Funt Youth Bridge Funt
(19 and under) 0-20 MPs
Thursday 5:00 -7:45 p.m.
No fees, trophies, refreshments
For more information:
Jerry Goodman 201-346-5390

Friday, Oct. 16
Side Game Series III (1st) 9 am
*Bracketed Compact KO Tms 9 am & 1 pm
Stratified Senior Pts 10 am & 3 pm
Stratified Open Pts 1 & 7 pm
One Session Swiss Tms (Red) 1 pm
Side Game Series III (2nd & 3rd) 1 / 7 pm
*Bracketed KO Tms III 7 pm
Continues Sat. 9 am, 1 & 7 pm

Saturday, Oct. 17
*Bracketed Compact KO Tms 9 am & 1 pm
Stratified Senior Pts 10 am & 3 pm
Stratified Open Pts 1 & 7 pm
One Session Swiss Tms (Red) 1 pm
Side Game Series III (4th & 5th) 1 / 7 pm

Sunday, Oct. 18
Open Bracketed Round Robin Tms 10:30 am
Top bracket played as Swiss —
open to all teams. Playthrough
Side Game Series III (6th) 10:30 am

*District 3 thanks District 25 (New England)
for the loan of Connecticut
to hold our Regional.*

**District 3 Autumn Leaf Regional
Danbury CT — Oct. 12-18, 2009**

The Danbury Plaza Hotel and Conference Center
18 Old Ridgebury Road • Danbury CT 06810 • 203-794-0600
\$90 Single/double plus applicable taxes.

Reservation Deadline — September 29, 2009 Bridge rate rooms may sell out before deadline.
Room Problems — Check with Joan Gerard 914-948-0841 joanandron@att.net

Free Workshop — Friday — 10:30 am-Noon
For anyone interested in developing Youth bridge.
Given by Patty Tucker ACBL Youth Coordinator.

Monday, Oct. 12
*Bracketed KO Tms I 7 pm
Continues Tues. 9 am, 1 & 7 pm
Side Game Series I (1st) 7 pm

Tuesday, Oct. 13
Side Game Series I (2nd) 9 am
Stratified Senior Pts 10 am & 3 pm
Stratified Open Swiss Tms (VPs) 1 & 7 pm
Side Game Series I (3rd & 4th) 1 / 7 pm

Wednesday, Oct. 14
Side Game Series II (1st) 9 am
*Bracketed Compact KO Tms 9 am & 1 pm
Stratified Senior Swiss Tms (VPs) 10 am & 3 pm
Stratified Open Pts 1 & 7 pm
Side Game Series II (2nd & 3rd) 1 / 7 pm
One Session Swiss Tms (Red) 1 pm
*Bracketed KO Tms II 7 pm
Continues Thurs. 9 am, 1 & 7 pm

Thursday, Oct. 15
Side Game Series II (4th) 9 am
Stratified Senior Pts 10 am & 3 pm
Stratified Open Swiss Tms (VPs) 1 & 7 pm
Side Game Series II (5th & 6th) 1 / 7 pm

For Tournament Info
Jerry Goodman
201-346-5390
redouble@webtv.net

Pairings
Lynn Baker
lynn@lynnandjerry.com

Stratified Games
A (2000+) B (750-2000)
C (0-750)

Compact KO Teams - 12 bc, matches 4-person teams only
All KO Teams are random draw within brackets
*Mid-Chart allowed in top bracket

Newspiccate
(0-200 MPs)
Games will be stratified if possible.
All events are one session Tuesday thru Saturday 10 am and 3 pm
Play both sessions any day Tues. thru Sat. and get a free snack, soda and mini-lesson between sessions.
Swiss Teams (single session) on Sun. at 10:30 am

For information
Cheryl Porter-Garofalo
201-641-8055
magic7nt@earthlink.net



"Bridge at its Best"
www.bridge-district3.org

Directions to Hotel — From the East: Rte 84 to Exit 2A. Follow Old Ridgebury Rd. around curve and up hill. Hotel will be visible on left. From the West: Rte 84 to Exit 2. Make left and then right following signs to US 202 and US 6. Make another right onto Old Ridgebury Rd. From the South: Rte 684 to Exit 9E and follow Rte 84 as above.