



THE COUNTIES

188



www.bridge-wcba.com

Vol. LII No. 3

Published by Westchester Contract Bridge Association

September 2010

SEE YOU THERE !

- ♣ ♦ ♥ ♠ ♣ ♦ ♥ ♠ ♣ ♦ ♥ ♠ ♣ ♦ ♣
- ♦
- ♥
- ♠ **September**
- ♣ (North American 49er Pairs Month)
- ♦ 16 ACBL Instant
- ♥ Matchpoint Game
- ♠ Thursday eve at clubs
- ♣
- ♦
- ♥ **October**
- ♠ 1-16 World Bridge Series Championship Philadelphia, PA
- ♣ 23 District 3 NAP Finals Allendale, NJ (All Flights) Schenectady, NY (Flights B & C ONLY)
- ♦ 25-31 District 3 Regional Danbury, CT
- ♥
- ♠
- ♣
- ♦ **November**
- ♥ 5-6 Jane Hill Future Masters Sectional Methodist Church White Plains, NY
- ♠ 17-23 STAC Week Various Clubs
- ♥ 25- NABC
- ♠ Dec. 5 Orlando, FL
- ♣ 29 ACBL Charity Game Mon. eve at clubs
- ♦
- ♥
- ♠
- ♣ ♦ ♥ ♠ ♣ ♦ ♥ ♠ ♣ ♦ ♥ ♠ ♣ ♦ ♣

Jane Hill Future Masters Sectional
0-200 Master Points
November 5 & 6, 2010
SILVER POINTS

<p>FRIDAY 9:30 am Stratified (0-49, 50-99, 100-200) 1:30 pm Stratified (0-49, 50-99, 100-200)</p>
<p>SATURDAY JANE HILL TROPHY 11:00 am Stratified (0-49, 50-99, 100-200)</p>
<p>Complimentary Lunch and Snacks both days</p>

For questions or pairings contact:
 Robert Wachtenheim (914) 472-3829
robwa@optonline.net

Card Fee:
\$12 per player
Per session

For results:
www.bridge-wcba.com

Card Fee:
\$13 per player
Per session
 (Non-ACBL members)

MEMORIAL UNITED METHODIST CHURCH
250 Bryant Ave., White Plains, NY 10605

Directions:

- A) Hutchinson River Parkway to Exit 25. North on North St, to Bryant Ave. Turn left. Church is ¼ mile on right.
- B) I-287 East to Exit 8E (Westchester Ave.) At end of exit turn right at traffic light onto North St. At second traffic light, turn right onto Bryant Ave. Church is ¼ mile on right.

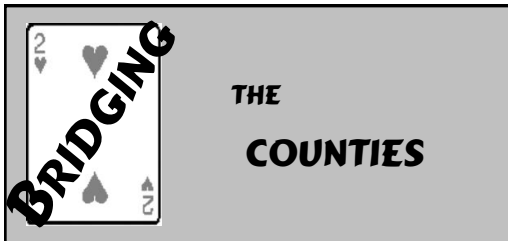

THE
COUNTIES

PRESIDENT'S MESSAGE

BRIDGING THE COUNTIES (ISSN 1059-3586) is published (quarterly) four times a year in March, June, September and December by the Westchester Contract Bridge Association, 190 East Post Road, White Plains, NY 10601. \$1 of yearly membership fees shall be applied to yearly subscription for the publication. Periodicals postage is paid at White Plains, NY. POSTMASTER: Send address changes to: *Bridging the Counties*, 190 East Post Road, White Plains, NY 10601.

**WESTCHESTER CONTRACT
BRIDGE ASSOCIATION**
Robin Brown, *President*

Editor Jason Fuhrman
21 Alkamont Avenue, Scarsdale, NY 10583
E-Mail: jayshell@pipeline.com

www.bridge-wcba.com
www.bridge-district3.org
www.acbl.org

STAFF

Robin Brown Kassie Munoz
Marshall Frank Nancy Sahtein
Michelle Fuhrman Judy Soley
Joan Levy Gerard Joel Sommer

Well, we're back to square one looking for a new place to have our sectional tournament. Those of you who came to our sectional in Mount Vernon know what I mean when I call it the Murphy's Law sectional. Everything that could have gone wrong - did. What you saw at the tournament and what we saw when we booked the site were two different venues. And what we were promised and what we got were two different things. But by the sheer numbers of you that came to play, I know that you are all looking for an alternative to the County Center. If anyone knows a good place to hold our sectional, please let me know. I am open to all suggestions.

I am writing this at the summer NABC in New Orleans. It is so nice to see so many players from Unit 188 have made the trip down here. I am happy to report that Sylwia and Mike McNamara just won the Bruce Life Master Pairs. This is a three-day event in which Sylwia and Mike had a rocky start, but after day two were leading the event; a lead which they never gave up. Who said husbands and wives can't play together?

We have a lot of wonderful events coming up that are much closer to home. The Jane Hill tournament is being held on November 5th and 6th. This tournament is restricted to new players. It is a wonderful chance for beginners to play in a tournament with out having to play against any of the top players. Check out the flyer on page 1 of this issue of *Bridging the Counties*.

Also coming up on the schedule is the Master/Non-Master game. In this game, beginners are paired with Life Masters. I strongly encourage all the Life Masters in our unit to volunteer to play in this game. It is a great way to give back to the game that has given you so much. And beginners, you should really take advantage of this opportunity to play with a better partner.

In addition to these two Unit events there are many tournaments sponsored by District 3 and other neighboring districts. So, if I don't see you at the clubs, I look forward to seeing you all at a tournament.

- Robin Brown

Editor's
Corner



This is my next-to-last issue as Editor of *Bridging the Counties*. The WCBA is still looking for my replacement. If you are interested in the job, please contact me as soon as possible.

Those who play against me regularly know that I favor a highly scientific bidding system that is very aggressive. Some people characterize it as crazy, but to each their own preferences. But I only play with this system with two regular partners, and one casual partner who I have not played with in years.

Recently, I have been playing more bridge with partners outside of this circle. While we still play many conventions, the detail is nowhere near what I have on my regular card. This of course greatly influences the bidding.

As circumstances come up in the bidding that are not covered by the less-extensive treatments, it leads to the thought of the meanings behind various bids. What does this bid mean in "standard" bridge? How can I do this differently, if I can't do it the way I'm used to? KISS - Keep It Simple Stupid - so my partner and I don't have a misunderstanding.

In a recent club game, this situation came up. In third seat, I'm sitting with 18 HCP, and lots of distribution (5=1=2=5). To my pleasant surprise, my partner opens the bidding 1♦. The auction progresses, but I get caught in a bind. We found our 5-3 spade fit a few rounds into the auction (barring an unusual hand, partner could not raise me to 2♠ immediately lacking a fourth spade), but in the absence of detailed agreements, since were not committed by a game forcing auction, what bids are forcing, and what will get passed?

I considered what would be done in a bridge game that completely lacked science, harking back to rubber bridge. KISS - 6♠. Partner tanked, thinking about converting it to 6NT at matchpoints, but made the decision to trust me since I bid so unusually. Making 6.

Every other pair except one, caught in the same bind I was, languished in 4♠ making 6. The other pair wound up in 6NT down 2.

This isn't a system victory like I normally trumpet. It's basic bridge, knowing what bids mean, knowing whether they're forcing, and trusting your partner when something unusual comes up.

Jason Fuhrman

This N' That From Your District Director

It was even hotter in New Orleans at the summer NABC than it was in Westchester County. However, since our sport is played inside in air conditioned rooms all was okay. Attendance was lower than estimated probably due to some people's fears about the food as a result of the oil spill. It must be said, however, that the local volunteers tried very hard and the hospitality was wonderful.

It was a sad day in June when Aileen Osofsky, chairman of the ACBL's Goodwill Committee, passed away. Many of you knew Aileen as she had been chairman of this committee for 25 years. Her loving smile and dedication to try and spread friendliness at every table that she went to was recognized by all. Aileen was inducted into the Hall of fame last summer receiving the Blackwood Award for service to the ACBL. Aileen was a good friend of mine and I was proud when the Board of Directors renamed the Goodwill Committee the Aileen Osofsky ACBL Goodwill Committee.

A very special bridge event will be held in Philadelphia October 1-16. The

World Series of Bridge, a World Bridge Federation event, will be held at the Marriott Downtown. This is the first time a world championship has been in the US since it was held in Albuquerque in 1994. (It was in Montreal in the early 2000s.) Anyone can enter any event – a great opportunity to play against players from all over the world. The schedule includes Mixed Pairs, Women's Pairs, Senior Pairs, Open Pairs, Mixed Teams, Open Teams and Women's Teams. Entry fees are a bit higher than at the NABC's but they include Opening Ceremonies and Closing Ceremonies with wine and hors d'oeuvres, and a beautiful attaché case as a registration gift. And if that's not enough, you can opt to play in a regional right next door at the Convention Center. A great schedule of KOs, Golden Opportunity Pairs, and Stratified Open Pairs. There are special bridge rates at the Marriott Downtown and a few other nearby hotels. Don't miss the opportunity to play in a World Championship practically in your own backyard. For more information go to: www.usbf.org.

Almost right after the World Bridge Series on Saturday, October 23rd is the District Finals of the NAPs. This is a two session event held at the Guardian Angel Church in Allendale. There will be 3 separate flights. Brunch will be served. Check the article in this issue of Bridging the Counties for all the details.

And finally to round out the year is District 3's Fall Foliage Regional in Danbury, CT starting on Oct 25th and concluding on Halloween. In addition to our usual wonderful schedule there will be a Golden Opportunity Pairs. You will have the opportunity to attend a Seminar on Appeals and also on the Recorder given by District 3's chairmen – Jon Green and Eli Schneider. Learn how important it is to record issues that happen at the table rather than just gossiping about them and get some insight into what appeals Committees must think about when there is a appeal.

Make your plans now to play lots of bridge this fall. I'll be there to say hi!

- Joan Gerard, District Director

Advice for Snowbirds

Even if you will be gone for several months this winter, you can still remain a member of the WCBA and continue receiving *Bridging the Counties*.

When you contact the ACBL with your winter address, let them know that you wish to remain a member of Unit 188 (WCBA). Any issues of *Bridging the Counties* that are published while you are away will be mailed to your winter address. Upon your return to Westchester, just tell the ACBL that you are back home. Don't miss a single issue!

If you move away and notify the ACBL that you want to keep your WCBA membership, you will continue to receive *Bridging the Counties*. However, if you do not notify the ACBL that you want to keep your Unit 188 membership, it will automatically be transferred to the Unit of your new residence. You can always view and download a copy of *Bridging the Counties* from our website <http://www.bridge-wcba.com>.

McNamaras Win Bruce LM Pairs

(Excerpted from the ACBL's Daily Bulletin at the New Orleans NABC)

Michael and Sylwia McNamara, who met at the bridge table and were married in Las Vegas six years ago, took the lead on the second day of the Bruce 0-5000 Life Master Pairs and held on to win.



The winners are both professional bridge teachers in the New York City area. They met at a tournament in Woodbridge NJ. They live in White Plains NY.

Defying the conventional view that husbands and wives should not play bridge together, the McNamaras function

well, playing a strong 1♣ system.

"We try not to talk about the boards during the game," said Michael.

2010 Westchester Double Knockout Bracket 1

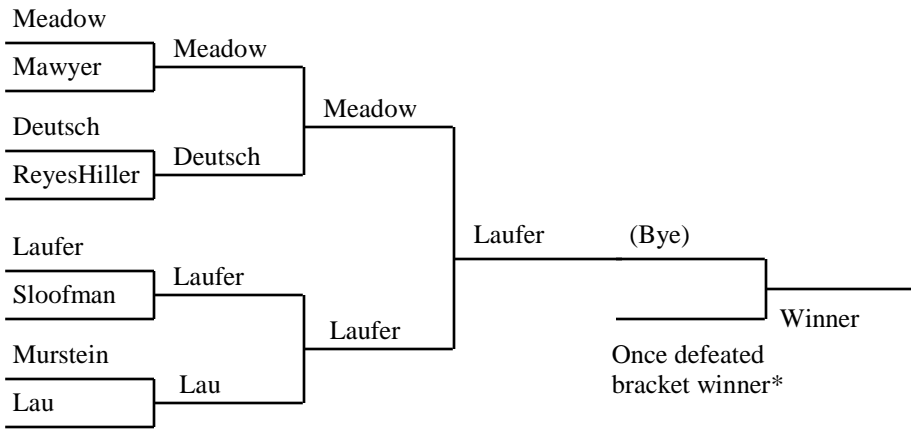

*The undefeated bracket leader will play the once defeated bracket winner to determine the overall bracket winner. The undefeated bracket leader needs to win once to become the winner. However, the once defeated bracket winner needs to win twice to become the winner.

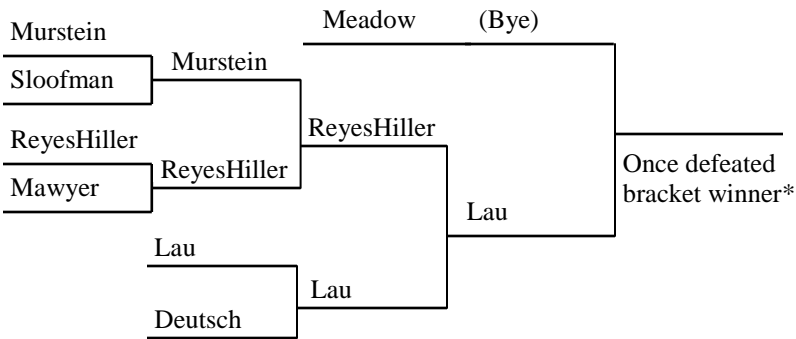

2010 Westchester Double Knockout Bracket 2

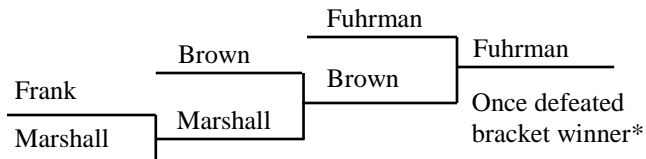
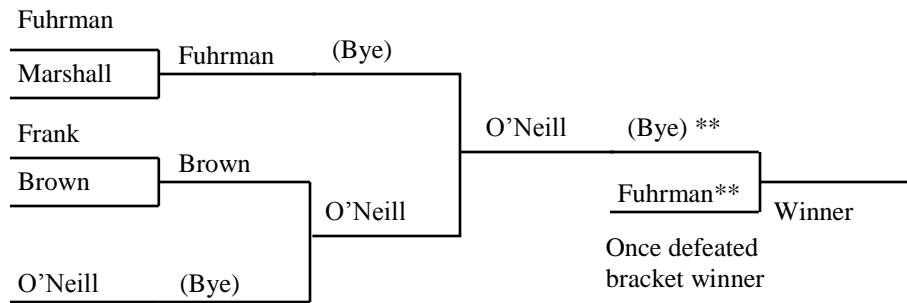

*The undefeated bracket leader will play the once defeated bracket winner to determine the overall bracket winner. The undefeated bracket leader needs to win once to become the winner. However, the once defeated bracket winner needs to win twice to become the winner.

**Fuhrman has defeated the O'Neill team once, and so the teams will play again in September to determine the winner.

2010 Westchester Double Knockout Bracket 3

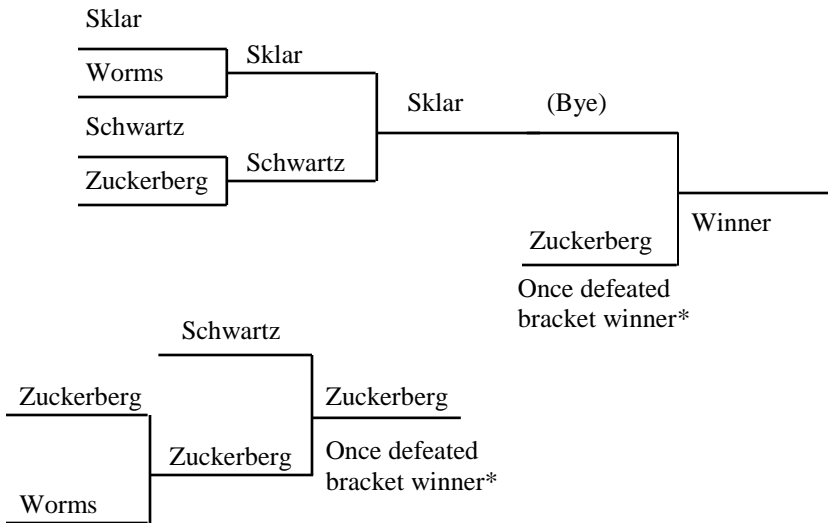

*The undefeated bracket leader will play the once defeated bracket winner to determine the overall bracket winner. The undefeated bracket leader needs to win once to become the winner. However, the once defeated bracket winner needs to win twice to become the winner.

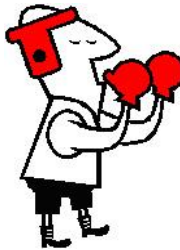

NAP Finals Scheduled

New Life Master - Leslie Davies

Next on the schedule for the NAPs will be the District level finals. A two-session District final for all flights will be held on October 23 at the Guardian Angel Church in Allendale, NJ. There will also be an additional District final for Flights B and C only at the Studio of Bridge and Games in Schenectady, NY. You can see details and directions at: <http://www.bridge-district3.org/nap/2010/nap2010.htm>

A tribute poem from her sister Donna Epstein

The Club rounds, which occurred over the summer, allowed areas players to earn a qualification to play at the District final. Only players who have already earned their qualification this year and reside in District 3 can play in the District final.

As Olympic athletes gathered in Vancouver to struggle for the gold,
 We have the legend of our own local hero just waiting to be told.
 Just as those super athletes had a goal they did desire,
 So to our Leslie Davies when from teaching she retired.
 Leslie sweated and strained for each point-be it gold, black, silver or red,
 She'd play 24/7, maybe even in bed.
 No tsunami, earthquake, hurricane, or any other natural disaster,
 Could deter her quest to become a Life Master.
 She'd play with the weirdos or with the elite,
 She'd partner with anyone with a heartbeat.
 Despite highs and lows in her scores she kept her motivation,
 And in her Connecticut tourney got those last gold points and was
 full of jubilation.
 To become a Life Master she found "the key,"
 And fulfilled her own special destiny.
 So let's raise our glasses to Leslie and toast
 To our ecstatic Life Master and gracious host.

The top three finishers in each flight at the District finals will be eligible to play in the National Finals, which will be at the 2011 Spring NABC in Louisville, KY in March.

June Overall STAC Winners

Monday Morning Open Pairs

A B C
 1 Richard DeMartino, Lawrence Lau
 1 George & Phyllis Lippman
 1 Sandra & James Bandler

Monday Afternoon Invitational

A B C
 1 P. Mendes & E. Yamaguchi
 1 Berta Wetzel, Maureen Foulke
 1 Leah Kantor, Joan Oppenheim

Monday Afternoon Open Pairs

A B C
 1 Rhoda Levine, Irene Silver
 1 Jack Leslie, Lukas Fekete
 1 Marcia White, Joyce Goldin

Monday Afternoon NLM Pairs

A B C
 1 Ann Barton, Barbara Leon
 1/2 Fleurette Cassara, Charles Hoffer
 1/2 Lily Knobler, Liz Melamid
 1 Sara Bellesheim, Susan Pfeister

Monday Afternoon 299er Pairs

A B C
 1 1 Dan & Louise Byers

Monday Evening Open Pairs

A B C
 1 R. Neuhart, M. Magdon-Ismail
 1 Laura & Ed Midgley
 1 John Grosz, Alan Margolin

Tuesday Morning Open Pairs

A B C
 1 Dennis Kaye, Irene Kellogg
 1 Sandra Beach, Stewart Winn
 1 Leia Berla, Jackie Stone

Tuesday Afternoon Open Pairs

A B C
 1 Daniel Raz, Bernard Schneider
 1 1 Karen Hershberg, Barbara Ross

Tuesday Afternoon NLM Pairs

A B C
 1 Arlene Levy, Judi Sternberg
 1/2 Carol Pocost, Nancy Sherman
 1/2 Verna Leviton, Joyce Kaplan
 1 Robin Fuchs, Debbie Alexander

Tuesday Evening Invitational Pairs

A B C
 1 1 Yasmine Guenancia, David Almer
 1 Mel Perlman, Bonnie Cohen

Tuesday Evening Open Swiss

A B C
 1 L. Christianson, D. Yates,
 Lester Gottlieb, Melissa Baker
 1 Joanne Marks, Alan Green,
 Jeffrey & Zach Marshall
 1 Barry Paley, Jerry Kaplan,
 Bonnie Berner, Cynthia Williams

Wednesday Morning Open Pairs

A B C
 1 David Benjamin, Doris Greenwald
 1 1 Paula & Richard Lerer

Wednesday Afternoon Open Pairs

A B C
 1 Donald Lockwood, Jill Marshall
 1 Marjorie Vogel, Richard Tunick
 1 Jennie Lazaro, Evelyn Markowitz

Wednesday Afternoon NLM Pairs

A B C
 1 Arnie Moskowitz, Michael Gorlon
 1 Clifford & Sally Tamis
 1 Dan Fromm, Mike Rosenberg

Wednesday Evening Open Pairs

A B C
 1 1 Michael & Ulla Sattinger
 1 Richard Slavin, Joseph Brachfeld

Wednesday Evening NLM Pairs

A B C
 1 John & Susan Grosz
 1 Denise & Paul Resnik

Thursday Morning Open Pairs

A B C
 1 Rhoda Levine, Peter MacCuaig
 1 Lynne Weiss, Donna Malitzis
 1 Alvin Edersheim, Fali Rubinstein

Thursday Afternoon Open Pairs

A B C
 1 Allan Botchman, Steve Kleinman
 1 Babette & Lon Bandler
 1 Brenda Bleustein, Penny Weill

Thursday Afternoon NLM Pairs

A B C
 1 1 Margaret Lynch, Patricia Forhan
 1 Natalie Kubrick, Suzanne Ochoa

Thursday Afternoon Invitational Pairs

A B C
 1 1 Harvey & Marie Sugar
 1 Ned Isaacson, Barbara Levy

Thursday Evening Open Pairs

A B C
 1 Stephen Sahlein, Rick Rosenthal
 1 Tim Baird, Alan Green

Friday Morning Open Pairs

A B C
 1 Faye Marino, Richard Laufer
 1 1 G. Mackenzie, M. Rosenthal

Friday Afternoon Open Pairs

A B C
 1 Lois August, Marilyn Faulk
 1 Phyllis Honig, Carole Leinwand
 1 John Loeber, Mark Hartley

Friday Afternoon NLM Pairs

A B C
 1 Jill Weinstein, Wendy Sklar
 1 Joan Lieblich, Marilyn Markowitz
 1 Tema Kaufman, Doris Minsker

Saturday Afternoon Open Pairs

A B C
 1 1 Donald & Steven Lockwood
 1 Valerie & Preston Scher

Sunday Afternoon Swiss (Bridge Deck)

A B C
 1 Fred Hawa, Richard Laufer,
 Mimi Bieber, Faye Marino
 1 1 Marilyn Wishnie, Barbara Worms,
 Sarah Hecht, Susan Deutsch

Sunday Afternoon Swiss (MHV)

A B
 1 John Gropp, Dennis Kaye,
 Bill Maine, Julian Laderman
 1 Bob Blasé, Dick Collins,
 Sandra Beach, Jean Townsend



WCBA 2010 Peter Kalat Summer Sectional Results

Friday Morning Open Pairs

A	B	C	
1	1		Kenneth Hirshon, Art Seelenfreund
2			Michael & Sylwia McNamara
3			Irene Silver, Gina Tamres
	2		Vivian Wu, Victor Mazmanian
3	1		Raymond Myers, Dennis Glazer
	2		John Condon Jr., Edith Halpern
	3		Leigh Levitt, Joan Giardina

Friday Morning 199er Pairs

A	B	C	
1	1	1	Todd Schiffer, Richard Strauss
2			Fali Rubinstein, Barbara Goldberg
3	2	2	Adish & Asha Jain
	3	3	Anne Miller, Fern Bindelglass

Friday Afternoon Open Pairs

A	B	C	
1	1		Marjorie Vogel, Richard Tunick
2			Laura Brill, Rick Goldstein
3	2		Antoinette Buonafede, Paul Roberts
	3		Robin Brown, Carol Laufer
		1	Raymond Myers, Dennis Glazer
		2	John Condon Jr., Edith Halpern
		3	Madeline Nagel, Roberta Strasberg

Friday Afternoon 199er Pairs

A	B	C	
1	1		Ronald & Patricia Bailer
2			Elyse Stein, Patricia Mangan
3			Barbara Blake, Renee Fisher
	2	1	Raymond & Susan Pfeister
	3		Sunny Rothenberg, Wendy Hirsch
		2	Rita Gladstone, Marcia Altabet

Friday Evening IMP Pairs

A	B	C	
1			Tania Reyes Hiller, George Groves
2			Michael & Sylwia McNamara
3	1		Steven Huhman, Robin Brown
	2		Sheldon Werner, Jill Marshall
	3		Benjamin & Susan Eisenberg
		1	Ronald & Patricia Bailer
		2	Alvin Edersheim, Evan Spencer
		3	Sharon Ainspan, Gail Wallach

Saturday Morning B/C/D Pairs

B	C	D	
1	1		Laura Schisgall, Stanley Sterenberg
2			Sam Borenstein, Doree Sobel
3	2	1	Norman Gleicher, Raymond Myers
	3	2	Helen Nathan, Ian Weinstock
		3	Malcolm Austin, Ronald Kallman

Saturday Morning 199er Pairs

A	B	C	
1	1		Adam Cohen, Derek Schuelein
2			Burt & Karin Meyers
3	2		Susan Schulz, Robert Reese
	3		Susan & John Grosz

Saturday 2 Session A/X Pairs

A	X	
1		Steve Becker, Larry Bausher
2	1	Marshall Lewis, Stephanie Russo
3		Kate & Jeff Aker
	2	Steven Huhman, L. Patrick Calahan
	3	Martin & Beverly Weiss

Saturday Afternoon B/C/D Pairs

B	C	D	
1/2			Robin & Roger Brown
1/2			Bobby Staymen, Barbara Feldman
3			Edward & Karen Zuckerberg
	1	1	Burt & Karin Meyers
	2		Martin Deneroff, Valerie Vaughan
	3		Jeffrey & Theo Allen
		2	Ronald Kallman, Malcolm Austin
		3	Ellen Waldman, Jill Howard

Saturday Afternoon 199er Pairs

A	B	C	
1	1		Ronald & Richard Bailer
2			Sharon Ainspan, Suresh Nayak
3	2		Dorothea Sullivan, John Jaquish
	3		Adam Cohen, Derek Schuelein
		1	Alan & Randi Margolin
		2	Frank & Barbara Cuiffo
		3	Susan & Raymond Pfeister

Sunday A/X Swiss Teams

A	X	
1/2		Alene Friedman, Jane Dillenberg, Jerry Goldberg, Leslie Paryzer
1/2		Helen Raleigh, Robert Heitzman Jr., Glenn Robbins, Michael Rosen
3		Sandra & Marvin Talish, Doris Staubi, Chuck Lamprey
	1/2	Lee Olinger, Blair Seidler, M. O'Connor, J. Sundstrom
	1/2	Farley Mawyer, Jill Marshall, Donald & Steven Lockwood

Sunday B Round Robin Teams Bracket 1

1	Jess Jurkovic, Bill Begert, Chaिम Kozlovsky, Randi Adelman
2	Robin & Roger Brown Alvin Edersheim, Elizabeth Haas
3	Roberta Strasburg, Carol Braten, Judith Back, Madeline Nagel

Sunday B Round Robin Teams Bracket 2

1	Christopher & Lynn Chapin, Ruth Harris, Richard Wan
2	Robert Zipf, Joan Carter, Betty Cutting, Mary Oztemel
3	Leia Berla, Jackie Stone, Jane Loughlin, Leah Mendelsohn

Sunday B Round Robin Teams Bracket 3

1	Harold & Renee Kelvin, Evan Spencer, Toni Buonafede
2	Waheed Din, Ejaz Qureshi,, Alex Dezieck, Joshua Parks
3	John Condon Jr., Michelle Florence, Phyllis Magner, Edith Halpern

Sunday B Round Robin Teams Bracket 4

1	George Trost, William Sigward, William Bovers, Peter Lovisa
2	Jake Neuthaler, Daniel Fromm, Susan & Raymond Pfeister
3	Paul Roberts, Karin Meyers,

Bridge to Success

This column, for beginning to intermediate players will discuss the effect of the bidding on the play of the hand. The contract is 2♠:

South	North
♠KJ732	♠A65
♥A8	♥10764
♦86	♦Q2
♣QJ106	♣K943

In isolation, the normal play is to

cash the ace and then finesse the jack.

But the auction at the table was:

West	North	East	South
1♦	Pass	Pass	1♠
2♦	2♠	All pass	

North cashed the ♦A and ♦K, and continue with the ♦J, East following, ruffed by you. You cash the ♠A and nothing interesting happens. Do you finesse?

No. East is marked as a very weak hand. With the ♥KQJ, West probably continues with a heart. So give East some heart honors, and he can't hold the ♠Q. Play low to the king, dropping the ♠Q. Even if the ♠Q doesn't drop, it costs nothing to try, as the finesse can't be right. Paying attention to the bidding can tell you how to play a hand.

- Toni Schwartz

TRAVELING SCORES



Please send Traveling
Scores To:

Judy Soley
30 Griffen Avenue
Scarsdale, NY 10583
- OR -
judy@soley.com

New Orleans NABC

Bruce 0-5000 LM Pairs

Michael & Sylwia McNamara 1st OA

Woodbridge Sectional

Sunday A/X Swiss

Melissa Baker & Jason Fuhrman 1st OX

Unit 188's Robert Stayman and John Boyer Win Mini-Spingold I

(Excerpted from the ACBL's Daily Bulletin at the New Orleans NABC)

Morrie Kleinplatz led his squad to a 137-93 win over Jim Russell's team in the final of the Mini-Spingold I 0-5000 Knockout Teams. Kleinplatz of Windsor ON played with Mark Leonard of Ypsilanti MI, Robert Stayman of New Rochelle NY and John Boyer of Hastings-on-Hudson NY.

After an even first quarter in the final, the Kleinplatz squad began to build a small lead. At halftime, they were 13 IMPs ahead of their opponents and by the three quarter mark, their lead had increased to 37. It was the first national-level victory for Stayman, a full-time bridge instructor, and Boyer, a high school math and physics teacher.

Roy Hill Master / Non-Master Game

The 34th annual Roy Hill Master / Non-Master game will be held at the Bridge Deck in the evening of Sunday, December 12.

For this special game, players with fewer than 50 masterpoints are randomly paired with Life Masters. The newly formed partnerships briefly discuss conventions (which are usually determined by what the non-master normally plays), and then compete against each other in a regular matchpoint pairs game. This is a very social event, as well as giving the non-masters a good learning experience.

Pre-registration is required for both the life masters and non-masters. People in both groups who are interested in playing may contact the chairman, by either mailing the form below to Rich Laufer, 65 Caterson Terrace, Hartsdale, New York 10530, or calling him at (914) 949-5853.

The WCBA's 34th Annual Roy Hill Master / Non-Master Game

Bridge Deck
313 Central Avenue
Scarsdale, NY

Sunday, December 12, 2010

7:00 P.M.

Pre-registration a must! Deadline: November 30, 2010 Entry: \$12.00

Please reserve a place for me at the Roy Hill Master / Non-Master Game on December 12

Name:

Address:

Telephone:

WCBA 2010 Medallion Leaders as of 8/10/10

0-5 MPs

1. Renee Kaplan	29
2. Verna Leviton	21
3. Alvan Lewis	17

5-20 MPs

1. Alvin Edersheim	32
2. Renee Kelvin	23
3. Joanne Frank	21

20-50 MPs

1. Alan Margolin	59
2. Randi Margolin	55
3. Ann Van Dyke	42

50-100 MPs

1. John Grosz	97
2. Ellen Tilzer	83
3. Joyce Kaplan	72

100-200 MPs

1. Wendy Sklar	143
2. Fali Rubinstein	102
3. Jill Weinstein	100

200-300 MPs

1. Anna Rosanelli	116
2. Judy Gruenberger	94
3. Raymond Myers	92

300-500 MPs

1. Arthur Aitkens	98
2. Valerie Scher	97
3. James Maffucci	94

500-1,000 MPs

1. Vivian Wu	237
2. Daniel Wolkowitz	174
3. Edwin Kellerman	139

1,000-2,500 MPs

1. Jill Marshall	393
2. Linda Otness	348
3. Melissa Baker	249

2,500-5,000 MPs

1. Michael McNamara	515
2. Tania Reyes Hiller	493
3. Heidi Klein	388

5,000-7,500 MPs

1. Rhoda Levine	314
2. Dan Hertz	312
3. Natalie Hertz	284

7,500-10,000 MPs

1. Warren Rosner	154
2. Gerald Sosler	126
3. Ron Gerard	33

10,000+ MPs

1. Rick Goldstein	315
2. Laura Brill	296
3. Kay Schulle	270

WCBA 2010 Ace of Clubs Leaders as of 8/10/10

0-5 MPs

1. Renee Kaplan	27
2. Verna Leviton	17
3. Alvan Lewis	15

5-20 MPs

1. Joanne Frank	19
2. Wilma Kaye	18
3. Joan Rubinstein	17

20-50 MPs

1. Alan Margolin	41
2. Randi Margolin	40
3. Ann Van Dyke	38

50-100 MPs

1. John Grosz	83
2. Ellen Tilzer	71
3. Joyce Kaplan	60

100-200 MPs

1. Wendy Sklar	81
2. Fali Rubinstein	77
3. Casey Stern	73

200-300 MPs

1. Anna Rosanelli	100
2. Judy Gruenberger	75
3. Ellen Reller	64

300-500 MPs

1. Valerie Scher	68
2. Toni Schwartz	65
3. Merle Lewis	64

500-1,000 MPs

1. Vivian Wu	152
2. Edwin Kellerman	111
3. Stephen Blau	103

1,000-2,500 MPs

1. Jill Marshall	189
2. Amy Frolick	156
3. Joanne Marks	151

2,500-5,000 MPs

1. Heidi Klein	280
2. Tania Reyes Hiller	244
3. Richard Laufer	154

5,000-7,500 MPs

1. Rhoda Levine	240
2. Nancy Molesworth	166
3. Dan Hertz	142

7,500-10,000 MPs

1. Warren Rosner	134
2. Gerald Sosler	114

10,000+ MPs

1. Kay Schulle	232
2. Rick Goldstein	161
3. Laura Brill	153

Rank Changes

Junior Master (5-20)

Sara Bellasheim
Steven Bosses
Margaret Chase
Joseph DiBenedetto
Anne Dedrick
Judy Edison
Linda Grabel
William Grabel
Virginia Grainger
Betty Golub
Mary Jalkut
Barbara G Kalik
Jill Kaplin
Diana Kent
Jeannie Kligman
Shirley Levy
Alvan Lewis
Susan Pfeister
Constantine Ralli
Susan Rowland
Ann Sacher
Nina Taselaar
Margaret Van Tassell
Xin Wei Zhang

Club Master (20-50)

Madi Alter
Susan Blatt
Janet Braun
Carolyn Campe
Margaret Chase
Howard Cohen
Ruth Elsner
Shelly Feiner
Gail Felsenstein
Eileen Finehirsh
Joanne Frank
Susan Freund
Barbara Howard
Renee Kaplan
Wilma Kaye
Renee Kelvin
Alfred Knight
Lillian Lazarus
Ann Levi
Verna Leviton
Steven Marcus
Alice Olson
Michael Olson
Carole Resnick
Janet Robinson
Sunny Rothenberg
Joan Rubinstein
Lorraiane M Sabert
Kenneth Schiffer
Marie Sugar
Jane Swirsky

Sectional Master (50-100)

Khalid AlDoori
Regina Ansbro
Dorothy Baldwin
Barbara Blake
Phyllis Canter
Susan Cutler
Douglas Dill
Marsha Goldfinger
Barbara Gross
John Grosz

Sectional Master (continued)

William Herman
Guy Hochgesang
Joyce Hochgesang
Joyce Kaplan
Natalie Kubrick
Judith Lapolla
Daniel Link
Alan Margolin
Lee Marrano
Ida Pittman Cardona
Susan Shmerler
Susan Smithline
Carl Stix
Connie Thiel
Ann Van Dyke
Kathy Wynne

Regional Master (100-200)

Susan Alin
Eileen Annis
Neil Beck
Lorraine Belliveau
Marilyn Donahue
Valerie Goldstein
Bill Hessberg
Harold Kelvin
Donald Levin
Rebecca Margulies
Deborah Marshall
Jeffrey Marshall
Audrey Michaels
Burt Meyers
Denise Resnik
Fale Rubinstein
Elaine Silberman
Evan Spencer
Casey Stern
Judy Sternberg
Ellen Tilzer
Anne Walker
Helene Winston
Marilyn Wishnie

NABC Master (200-LM)

David Almer
Elaine Glover
Judy Gruenberger
Sara Kaminker
Valerie Scher
Wendy Sklar

Life Master

Arthur Aitkens
James Maffucci

Bronze LM (500-1,000)

Barbara Heller
Diana S Holtzman
Joan Giardina
Adam Lally
Toni Schwartz

Silver LM (1,000-2,500)

Phyllis Brown
Barbara Kantor
Lawrence Novick
Bobby Stayman

Welcome!

New Members

Ruth Baruse
Joyce Cornick
Ann Garland
Rita Gladstone
Ann Goldberg
Joseph Kilbourn Jr.
Ellen Kramer
Doreen Kushel
Katherine Martucci
Gail Messina
Michael Miller
Carol Moesel
Nusha Moscovitz
Meta Parker
Laurie Pasqua
Raymond Pfeister
Jane Sherman
Jacob Sklar
Elinor Urstadt
Evelyn Wells
Carl Young
Christine Zufelt



Gold LM (2,500-5,000)

Fred Hawa
Doris G Staubi

Diamond LM (5,000-7,500)

Tania Reyes Hiller

Emerald LM (7,500-10,000)

Natalie Hertz

Club directory	Regular Weekly Game Schedule						
	Mon	Tues	Wed	Thurs	Fri	Sat	Sun
The Bridge Deck 313 Central Avenue Scarsdale 949-5853 thebridgedeck.com	9:30 AM R. Brown Stratified Open 1:00 PM F. Hava Stratified Open R. Laufer Stratified 0-200 7:00 PM E. O'Neill Stratified Open	9:30 AM M. Frank Stratified 1:00 PM R. Friedman Stratified 1:30 PM S. McNamara Supervised Play	9:30AM M. Frank Stratified 1:00 PM E. O'Neill Stratified R. Laufer 0-200 Stratified 1:30 PM R. Brown Supervised Play 6:30 PM F. Hava Stratified NLM	9:30AM B. Hoffman Stratified 1:00 PM F. Hava Stratified R. Laufer 0-200 Stratified 7:30 PM F. Hava Supervised Play 7:30 PM B. Hoffman IMP Pairs	9:30 AM Stratified D. Huber 1:00 PM B. Hoffman Stratified 1:00 PM R. Laufer 0-200 Stratified	1:00 PM R. Friedman Stratified	1:00 PM E. O'Neill Stratified
The Hartes' Club Armenian Church 1131 North St White Plains 285-1230 hartesclub.com	9:30 AM Stratified C. Lubesnik 1:00 PM Stratified Open / 0-NLM C. Lubesnik 6:30 PM Stratified C. Lubesnik	9:30 AM Stratified R. Castellone 1:00 PM Stratified Open / 0-NLM C. Lubesnik 1:00 PM Supervised Play J. Hand 6:30 PM Stratified C. Lubesnik	9:30 AM Stratified R. Castellone 1:00 PM Stratified Open / 0-NLM R. Castellone	9:30 AM Stratified S. Abelson 1:00 PM Stratified Open / 0-NLM C. Lubesnik 1:00 PM Supervised Play G. Greenberg S. Becker	9:30 AM Stratified Y. Shoykhet 1:00 PM Stratified Open / 0-NLM Y. Shoykhet	1:00 PM Stratified C. Lubesnik	
Heritage Hills Bridge Club Heritage Hills Somers 276-1433		7:20 PM Invitational R. Castellone		12:30 PM Invitational R. Castellone			
Larchmont Temple Bridge Club 75 Larchmont Av Larchmont 261-3974 www.cuebid.com/ clubs/Larchmont			7:15 PM B. Calcagni Stratified				
Community Bridge Club Lutheran Church Corner of Rte. 172 & Main Street Mount Kisco 241-0937	10:30 AM I. Nargi						



Changes & Closings

Down Two Double has changed its name to Heritage Hills Bridge Club and it is now managed by Don Jacobson. A new phone number is on the schedule. The games held there are invitational and are directed by Rich Castellone.

Larchmont Temple - all games now start at 7:15 PM.

Larchmont Temple - the monthly handicap game now offers a kitty.

Larchmont Temple will be closed November 24 for Thanksgiving.

Special Games

September

1	Larchmont	International Fund Game	7:15 PM
1-7	Bridge Deck	International Fund Game	All games
5	Bridge Deck	International Fund Swiss	1:00 PM
15	Larchmont	Handicap Prize	7:15 PM
16	Bridge Deck	Instant Matchpoint Game	7:30 PM
28	Hartes' Club	8 Is Enough Swiss	6:30 PM
29	Larchmont	IMP Pairs	7:15 PM

October

4-9	Hartes' Club	Triple Points	AM games
4-10	Bridge Deck	Club Appreciation	All games
6	Larchmont	Charity Game	7:15 PM
10	Bridge Deck	Club Appreciation Swiss	1:00 PM
11-16	Hartes' Club	Triple Points	PM games
18-23	Hartes' Club	Club Appreciation	All games
19	Hartes' Club	Club Appreciation Swiss	6:30 PM
20	Larchmont	Handicap Prize	7:15 PM
25-26	Hartes' Club	Triple Points	Eve. games
27	Larchmont	IMP Pairs	7:15 PM

November

1-6	Hartes' Club	Triple Points	AM games
3	Larchmont	Charity Game	7:15 PM
8-13	Hartes' Club	Triple Points	PM games
10	Larchmont	Handicap Prize	7:15 PM
15-16	Hartes' Club	Triple Points	Eve. games
17-23	Various Clubs	STAC Week	All games
21	Bridge Deck	STAC Swiss	1:00 PM
23	Hartes' Club	STAC Swiss	6:30 PM
29	Hartes' Club	ACBL-Wide Charity	6:30 PM
29	Bridge Deck	ACBL-Wide Charity	7:00 PM



Coming Events

BRIDGING THE COUNTIES
190 East Post Road
White Plains, NY 10601

PERIODICALS POSTAGE
Paid at White Plains, NY

- ◆ ♣ ◆ ♥ ♠ ♣ ◆ ♥ ♠ ♣ ◆ ♥ ♠ ♣ ◆ ♣
- ◆
- ♥
- ♠
- ♣ **December**
- ◆
- ♥ 12 Master / Non-Master Bridge Deck
- ♠
- ♣ **January**
- ◆
- ♥ 7 Closed Westchester Bridge Deck
- ♠ 8 Closed Westchester Riverview
- ♣ 9 Golden Apple Swiss Bridge Deck
- ◆ 11-17 District 3 Regional Rye Town Hilton
- ♠
- ◆
- ♥ **February**
- ♠ 5 Internat'l Fund Game Various Clubs
- ◆ 21 ACBL-Wide Senior Pairs Game Various Clubs
- ♥
- ♠
- ♣
- ◆
- ♥
- ♠
- ♣
- ◆
- ♥
- ♠
- ♣
- ◆

 Copy Closing for next issue:
October 20, 2010
DEADLINE



Next Board Meeting
October 9, 2010, 10:00 AM

Welcome to our ACBL President - Rich DeMartino

Funt! Youth Bridge Funt
(19 and under) 0-20 MPs
Sunday 10:30 am - 1:15 pm
Trophies, refreshments, no fees
For more information:
Betty Cox 973-895-3506
bcx10@optonline.net

District 3 Autumn Leaf Regional Danbury CT — Oct. 25-31, 2010

The Danbury Plaza Hotel and Conference Center
18 Old Ridgebury Road • Danbury CT 06810 • 203-794-0600
\$94 Single/double plus applicable taxes.

Reservation Deadline — October 11, 2010 *Bridge rate rooms may sell out before deadline.*
Room Problems — Check with Joan Gerard 914-948-0841 joanandron@att.net
Tourn. Info: Jerry Goodman 201-346-5390 redouble@webtv.net
Pairings: Lynn Baker, lynn@lynnandjerry.com

Monday, Oct. 25
*Bracketed KO Tms I 7 pm
Continues Tues. 9 am, 1 & 7 pm
Side Game Series I (1st) 7 pm

Tuesday, Oct. 26
Side Game Series I (2nd) 9 am
Stratified Senior Pts 10 am & 3 pm
Bracketed Round Robin Tms 1 & 7 pm
Top bracket played as Swiss - open to all teams.
Side Game Series I (3rd & 4th) 1 / 7 pm

Wednesday, Oct. 27
Side Game Series II (1st) 9 am
*Bracketed Compact KO Tms 9 am & 1 pm
Stratified Senior Swiss Tms (VPs) 10 am & 3 pm
Stratified Open Pts 1 & 7 pm
Side Game Series II (2nd & 3rd) 1 / 7 pm
One Session Swiss Tms (Red) 1 pm
*Bracketed KO Tms II 7 pm
Continues Thurs. 9 am, 1 & 7 pm

Thursday, Oct. 28
Side Game Series II (4th) 9 am
Stratified Senior Pts 10 am & 3 pm
Stratified Open Swiss Tms (VPs) 1 & 7 pm
Side Game Series II (5th & 6th) 1 / 7 pm

Friday, Oct. 29
Side Game Series III (1st) 9 am
*Bracketed Compact KO Tms 9 am & 1 pm
New Golden Opportunity Pts
750/300/100 MPs 10 am & 3 pm
Stratified Senior Pts 10 am & 3 pm
Stratified Open Pts (2500+, 0-2500) 1 & 7 pm
One Session Swiss Tms (Red) 1 pm
Side Game Series III (2nd & 3rd) 1 / 7 pm
*Bracketed KO Tms III 7 pm
Continues Sat. 9 am, 1 & 7 pm

Saturday, Oct. 30
*Bracketed Compact KO Tms 9 am & 1 pm
Stratified Senior Pts 10 am & 3 pm
Stratified Open Pts 1 & 7 pm
One Session Swiss Tms (Red) 1 pm
Side Game Series III (4th & 5th) 1 / 7 pm

Sunday, Oct. 31
Open Bracketed Round Robin Tms 10:30 am
Top bracket played as Swiss - open to all teams. Playthrough
Side Game Series III (6th) 10:30 am
Thanks to Dist. 25 (New England) for the loan of Connecticut to hold our Regional.

Free Workshop
Monday 2:30-5 pm
How Appeals Committees and Recorder Systems function. Given by Jon Green, Appeals Chairman and Eli Schneider, Recorder, District 3

Golden Opportunity Pairs
(strat. two session event)
750/300/100 MPs
Friday 10 am & 3 pm
GOLD POINTS for Overalls and section tops in top strat

Stratified Games
A (2500+) B (1000-2500) C (0-1000)
*Mid-Chart may be allowed in top bracket

Newspiccate (Red)
(0-200 MPs)
One-session Pair Games Tues., Wed., Thurs. & Sat. 10 am and 3 pm
Play both sessions and get a free snack, soda and a mini-lesson between sessions.
SUNDAY NEW! 2-session Swiss Teams 10:30 am & TBA (one sess. entries sold for 10:30 game). Play two-sessions Sun. and receive chit for snack bar

Contact
Cheryl Porter-Garofalo 201-641-8055
grb1@optonline.net