

User Manual

AH5512 Primary

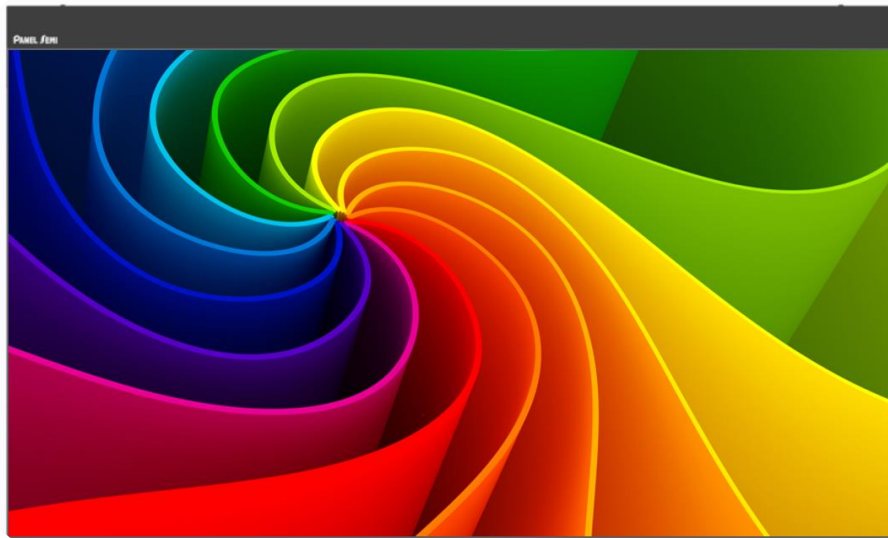

****Friendly Reminder****

- Thank you for choosing our product. Please read the instruction manual carefully before installation and remember to keep it for future reference.
- This product must be installed by a professional who has assessed the feasibility of safety aspects such as the environment, electrical connections, and structure.
- Do not disassemble or replace original factory components. In case of malfunctions, please contact our after-sales service department.

CONTENTS

CONTENTS	2
1. SAFETY INFORMATION	3
1.1 NOTES ON INSTALLATION AND USE	3
1.2 DISCLAIMER	4
2. UNBOXING AND ACCESSORIES	5
2.1 UNPACKING THE CARDBOARD PACKAGING AND PROTECTIVE CARDBOARD	5
2.2 ACCESSORY DESCRIPTION	7
2.3 INSTALLATION GUIDELINES	8
3. PRODUCT STRUCTURE EXPLANATION	10
3.1 PRODUCT APPEARANCE DRAWING	10
3.2 PRODUCT BUTTONS AND PORT DESCRIPTIONS	11
3.3 PRODUCT DIMENSIONS AND WEIGHT	12
4. APPLICATION NOTES	13
4.1 ASSEMBLY COMPONENTS	13
4.2 PRIMARY 55-INCH SINGLE SCREEN	14
4.3 HORIZONTAL SPLICING (2X1)	15
4.4 VERTICAL SPLICING (1X2)	22
4.5 LARGE SCREEN SPLICING (2X2)	26
4.6 VERTICAL SPLICING (1X3)	31
4.7 HORIZONTAL SPLICING (3X1)	32
4.8 INNER RIGHT-ANGLE SPLICING (2X1)	33
4.9 OUTER RIGHT-ANGLE SPLICING (2X1)	34
5. OPTICAL USER INTERFACE (UI) OPERATION INSTRUCTIONS	35
5.1 PURPOSE	35
5.2 OPERATION PROCEDURE	35
5.3 CABLE CONNECTION METHOD	36
5.3.1 HORIZONTAL SPLICING	36
5.3.2 VERTICAL SPLICING	37
5.3.3 LARGE SCREEN SPLICING	38
5.4 UI PROGRAM SUPPORTS STITCHING	39
5.5 INSTALLATION PROGRAM & OPERATING INSTRUCTIONS	39

1. Safety Information

In order to ensure the safety of the product, this manual contains important information on how to use the product. Before using this product, please read the safety precautions carefully.

1.1 Notes on Installation and Use

[1] When moving the flexible display, make sure to carry it with two people and both hands simultaneously to avoid collisions, drops, or damage.

[2] Do not apply pressure or lateral force to the flexible display to prevent screen damage.

[3] Avoid hitting the product with sharp or metallic objects.

[4] Avoid placing the screen in close proximity to heating equipment or direct sunlight, and refrain from exposing it to rain or submerging it in water. Additionally, do not fold, bend, or curl the screen beyond its designated bending limit radius to ensure optimal safety and functionality.

[5] Ensure that the screen's ventilation openings are not obstructed by items such as newspapers, tablecloths, or curtains.

[6] Do not place a direct flame source, such as a lit candle, above the screen.

[7] Only use properly grounded plugs and wall sockets, as poor grounding may result in electric shock or damage to the flexible screen.

[8] Avoid overloading wall sockets, extension cords, or adapters, as this may lead to fires or electric shock.

[9] In the event of lightning or thunderstorms, unplug the power cord to prevent the risk of electric shock.

[10] Avoid inserting any metal objects into the openings of the screen, as this may result in electric shock.

[11] Do not insert your hands or foreign objects into the interior of the device.

[12] Do not attempt to disassemble the product yourself, as there is a risk of electric shock. Leave internal inspections and adjustments to professional service personnel.

[13] When inserting the power cord, make sure it is securely connected. When unplugging the power cord from the wall socket, always grasp the plug to pull it out and avoid pulling the cord. Do not touch the power cord with wet hands.

[14] If the screen is not functioning properly, especially if it emits abnormal sounds or odors, immediately unplug the power cord and contact customer service.

[15] Prevent screen damage during installation by avoiding collisions with personal movements. Refrain from dropping or impacting the screen, and in case of damage, disconnect the power cord and promptly reach out to customer service for assistance.

[16] To clean the screen, first unplug the power cord and then use a dry, soft cloth to wipe the product. Do not use any chemical products such as wax, benzene, alcohol, diluents, pesticides, air fresheners, lubricants, or cleaners. These chemicals may damage the screen's appearance or remove printed content on the product.

[17] The Alternating Current (AC) output is only intended for use with displays of the same specifications.

[18] When sending the product for repair, please follow the shipping packaging instructions.

[19] This product is designed for indoor use. Please note that when using outdoors or semi-outdoors, the screen may be damaged due to external pressure such as wind or rain.

1.2 Disclaimer

Any damage resulting from defects or flaws in the product due to non-compliance with the instruction manual or arbitrary changes to the usage process will be the responsibility of the user.

2. Unboxing and Accessories

2.1 Unpacking the Cardboard Packaging and Protective Cardboard

Step 1. Open the outer box lid.

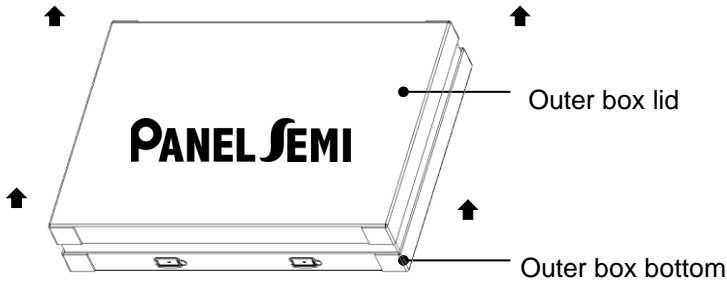

Step 4. Remove the EPE foam Packaging

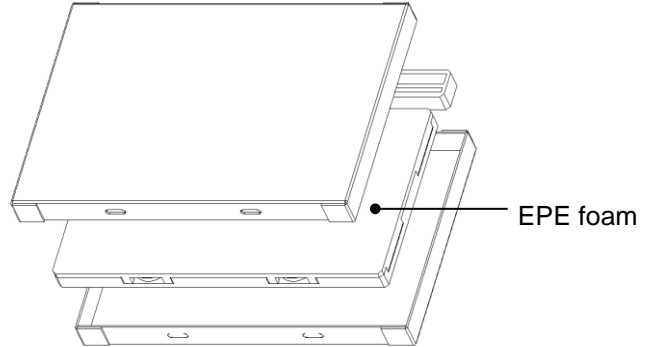

Step 2. Remove the inner box.

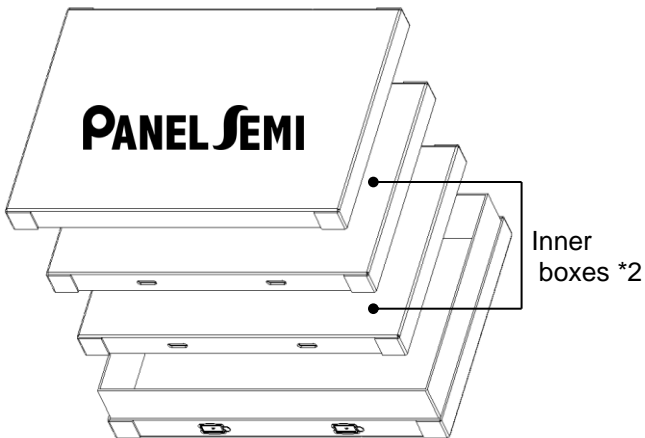

Step 5. Open the EPE foam lid.

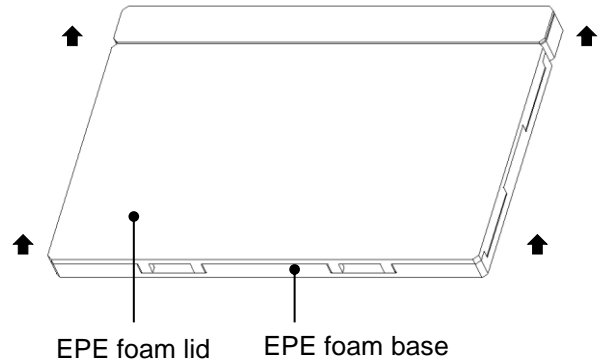

Step 3. Open the inner box lid.

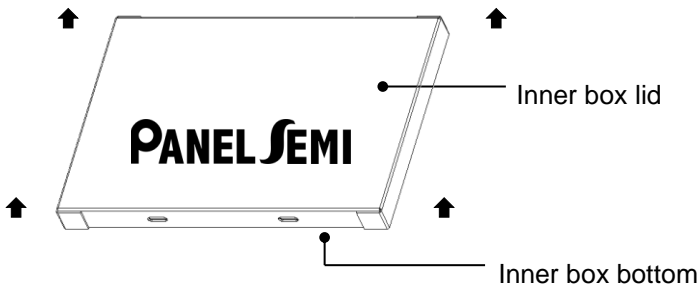

Step 6. Remove the product and the protective cardboard.
(Do not remove the protective cardboard.)

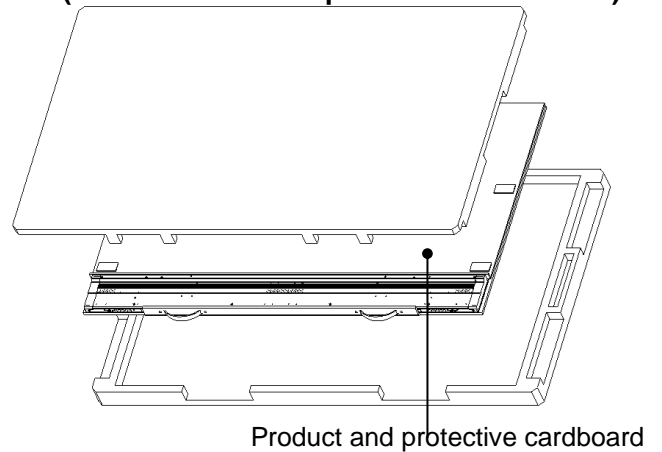

Step 7. Remove the Velcro pads *6 sets from the protective cardboard.

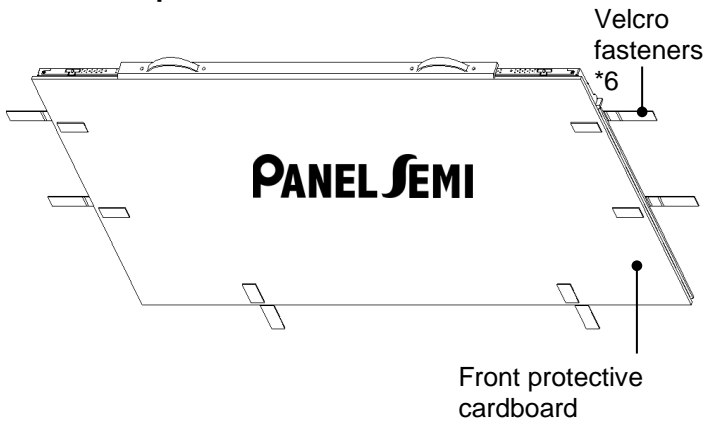

Step 10. Remove the front protective cardboard.

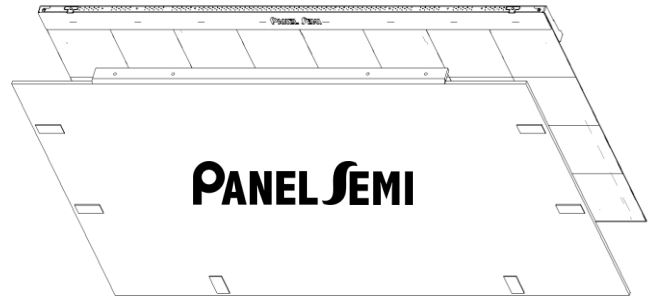

Step 8. Remove the rear protective cardboard.

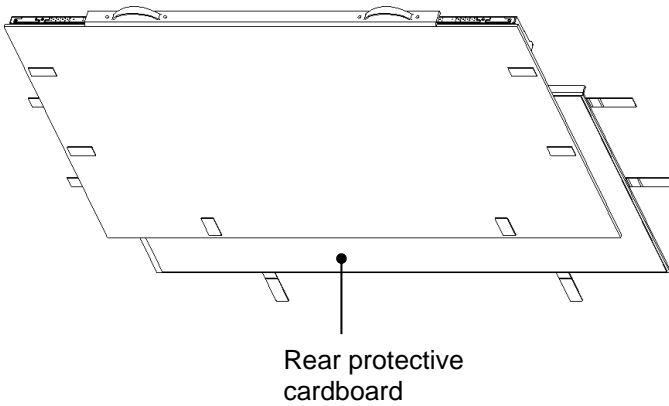

Step 11. Take out the product.

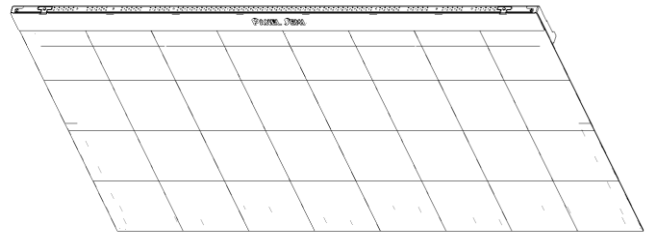

Step 9. Loosen the screws *4 and remove the handles *2.

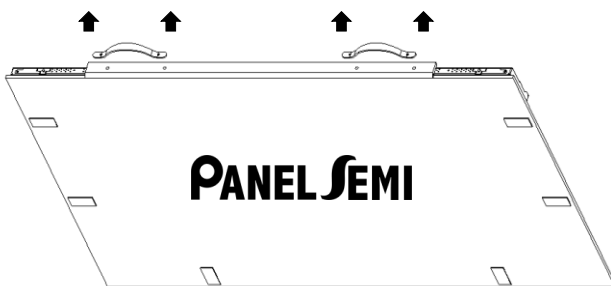

Step 12. Assemble the lanyard.

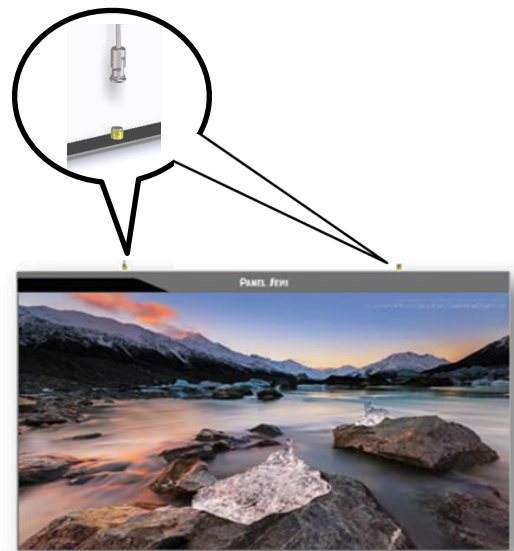

2.2 Accessory Description

[1] Suspension ropes *2



[2] Adapter 19Vdc*1 & Power cord*1

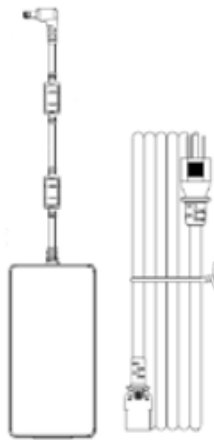

2.3 Installation Guidelines



Assembly component:
Suspension ropes *2

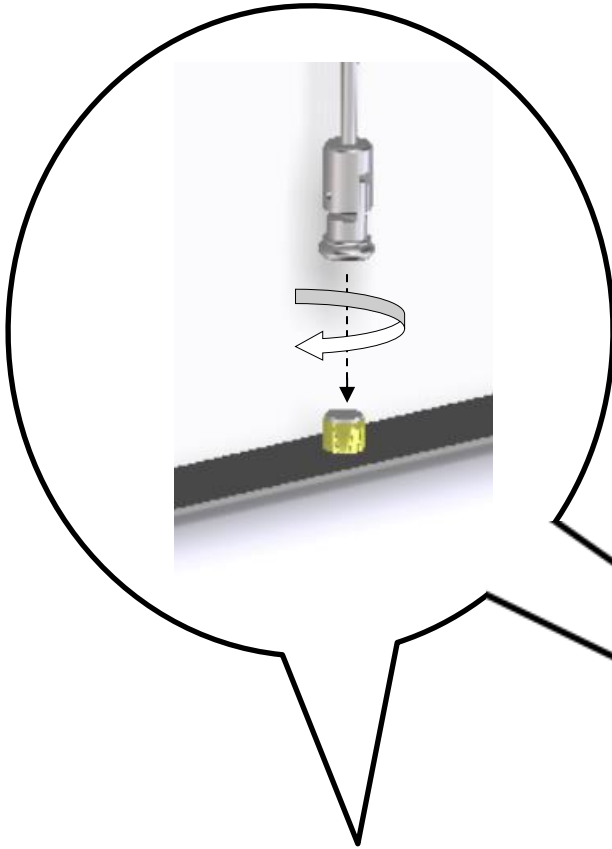

[1] Insert the front end of the suspension rope into the brass nut in a clockwise direction to secure it. Complete the other side in the same manner.



During installation, ensure that the suspension rope and brass nut are in a tightened state.



[2] Completed Drawing

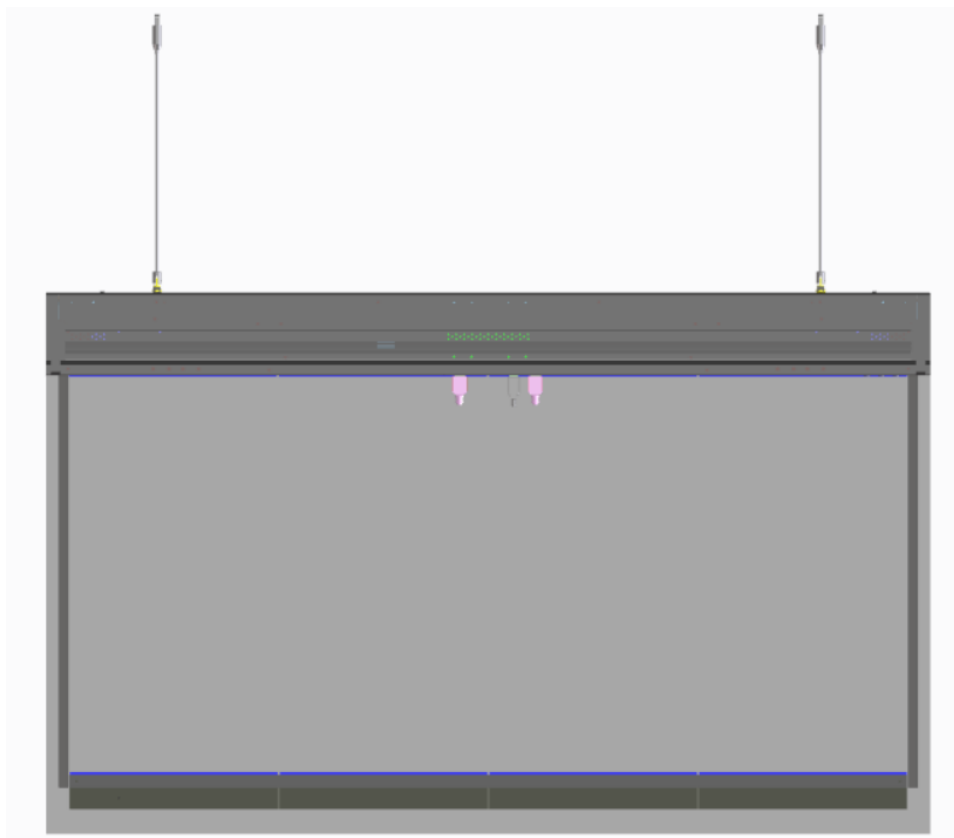

3. Product Structure Explanation

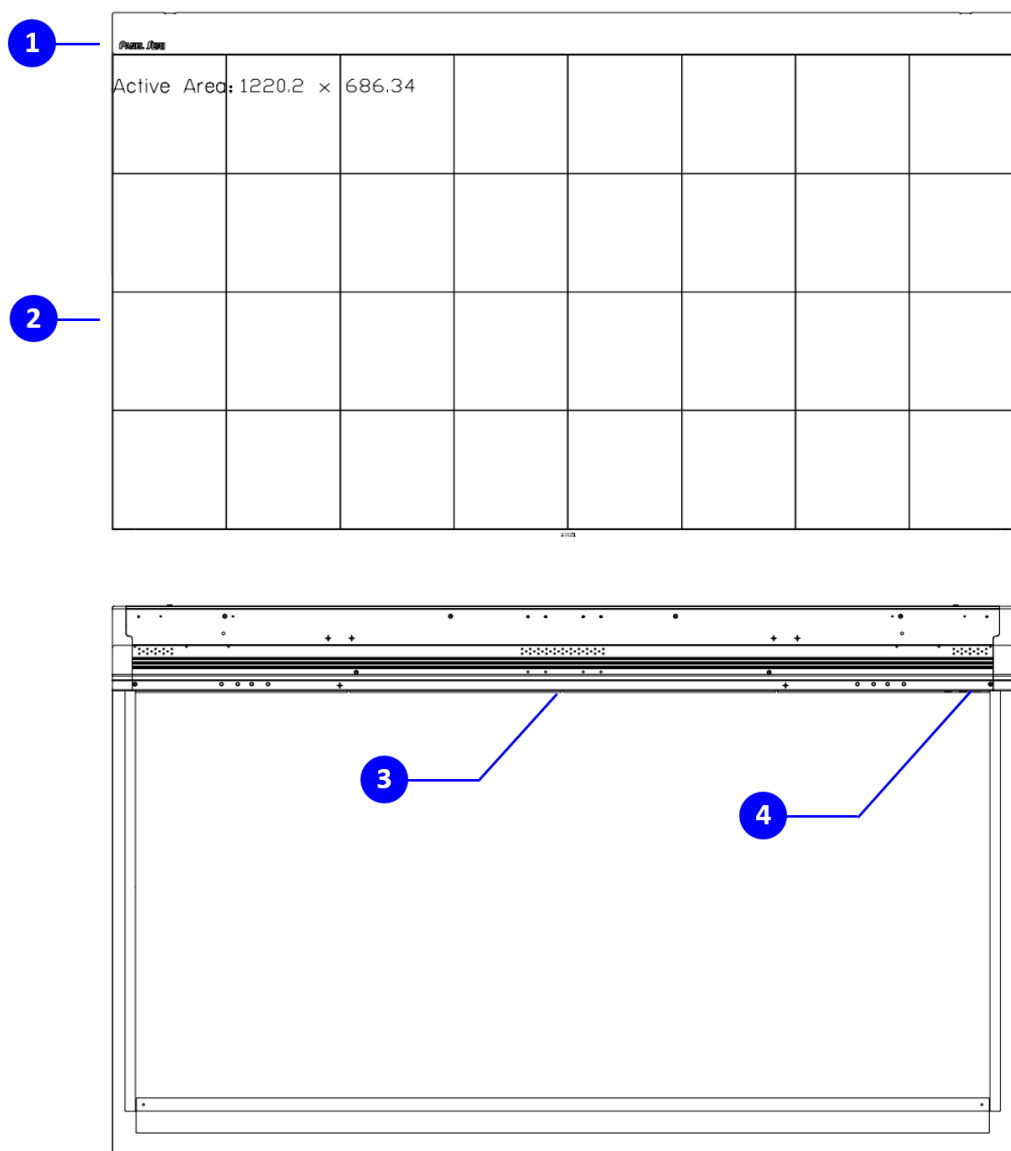

3.1 Product Appearance Drawing

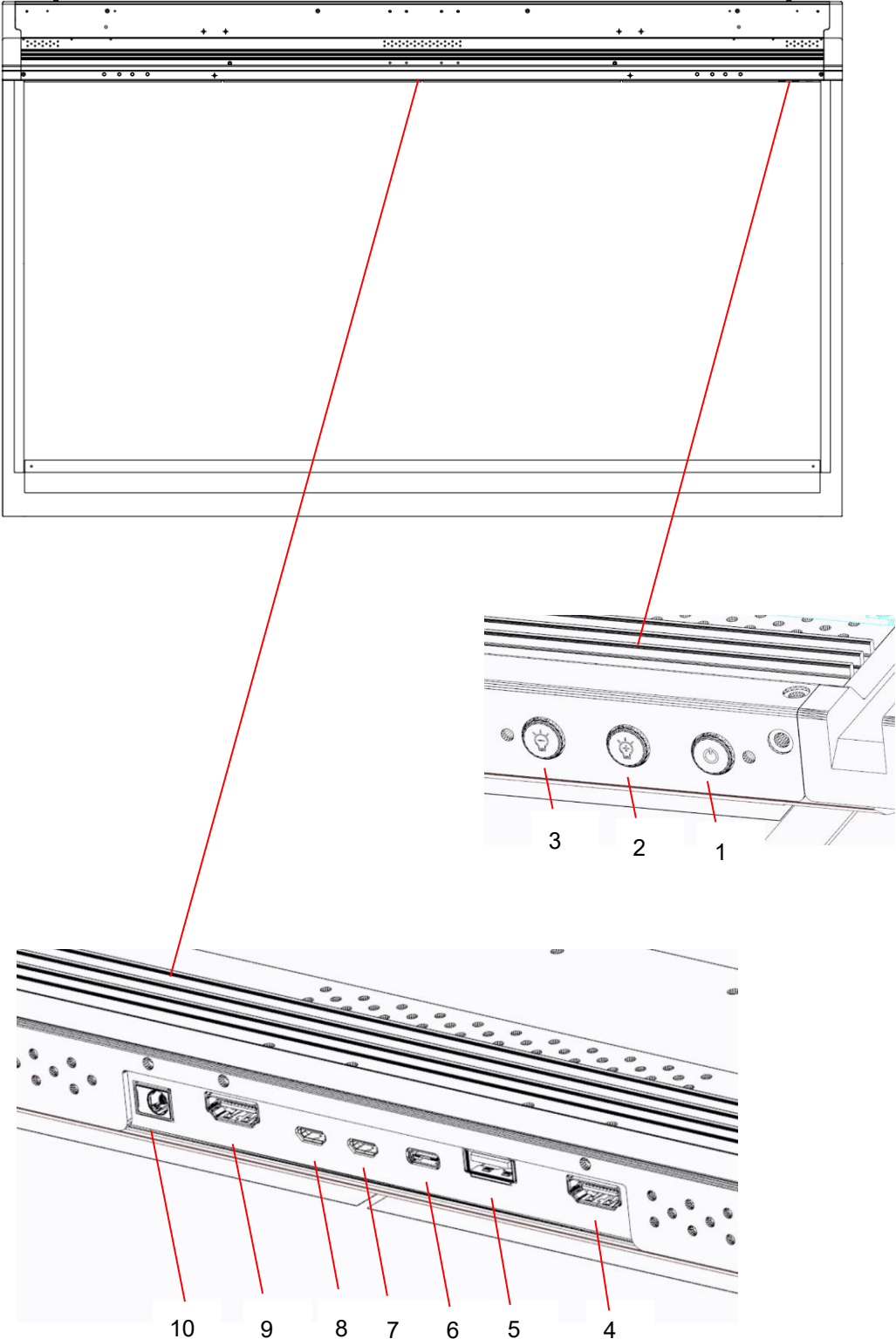

- 1 System bar
- 2 mini LED display screen
- 3 DC Power/signal input jack
- 4 Key pad

3.2 Product Buttons and Port Descriptions



No.	Key	Descriptions
1		DC Power on / off (Red)
2		Brightness adjustment +
3		Brightness adjustment -
4	HDMI	HDMI1.4 Type A Connector (HDMI IN)
5	USB	USB2.0 Type A Connector (PC UI Brightness adjustment)
6	USB	USB2.0 Type C Connector (Output Voltage 5V/2A DC only)
7	USB	Micro USB Connector (RS485 Signal)
8	USB	Micro USB Connector (RS485 Signal)
9	HDMI	HDMI1.4 Type A Connector (HDMI OUT)
10	DC Jack	DC input 19V

3.3 Product Dimensions and Weight

Dimension	Specs
Width	1221.2±5mm
Height	749.8±5mm
Depth	29.5±3mm
Weight	5.2±0.5kg (w/o adaptor) 6±0.5kg (w/ adaptor)

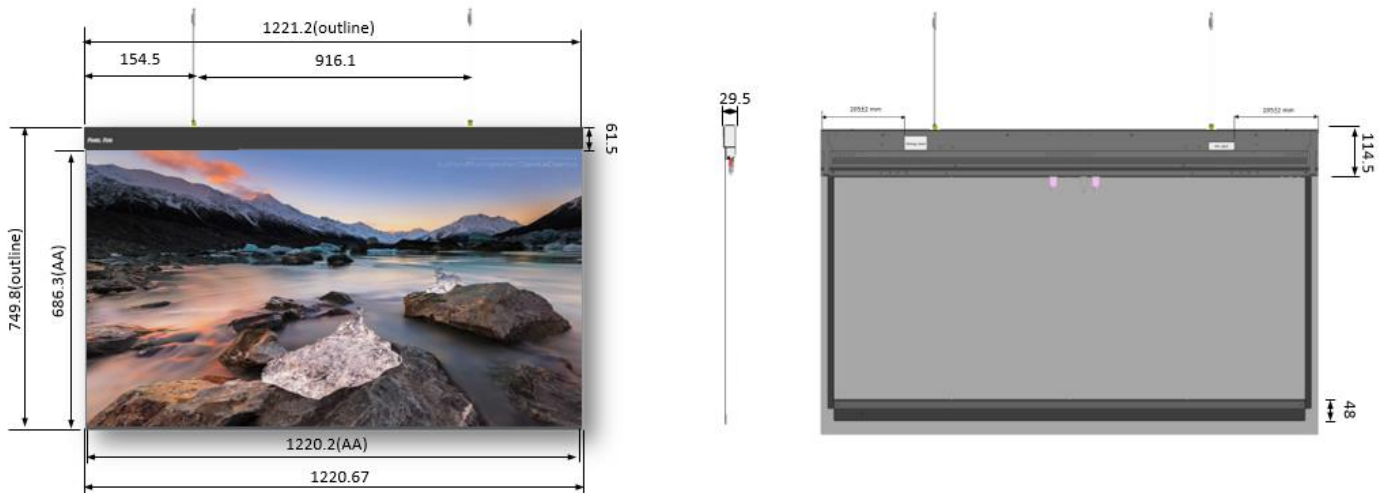

4. Application notes

4.1 Assembly Components

























Package Contents

<p>Single Primary accessories</p> <ul style="list-style-type: none"> steel lanyard (x2) steel lanyard screw M4*L12 (x2) Adapter (x1) Brass nuts (x2) 	<p>Primary Vertical tiling (1x2)</p> <ul style="list-style-type: none"> steel lanyard (x2) steel lanyard screw M4*L12 (x2) Brass nuts (x2) Thumb Screw M4*L10 (x2) Vertical tiling bracket screw M4*L10(x8) Vertical tiling bracket (x2) System bar Box (x1)
<p>Primary Horizontal tiling (2x1)</p> <ul style="list-style-type: none"> steel lanyard (x4) steel lanyard screw M4*L12 (x4) Brass nuts (x4) Thumb Screw M4*L10 (x2) Horizontal tiling bracket (x1) Horizontal tiling bracket screw M3*L4 (x2) Back cover bracket screw M2.5*L4 (x8) L back cover bracket (x1) R back cover bracket (x1) magnetic sealing plate(x1) Flat tiling base down(x1) Adapter (x2) 	<p>Primary 2*2 Flat tiling (2x2)</p> <ul style="list-style-type: none"> steel lanyard (x4) steel lanyard screw M4*L12 (x4) Brass nuts (x4) Thumb Screw M4*L10 (x6) Horizontal Tiling bracket (x2) System bar Box (x3) magnetic sealing plate(x2) Vertical tiling bracket (x4) Adapter (x4) L back cover bracket (x2) R back cover bracket (x2) Back cover bracket screw M2.5*L4 (x16) Vertical tiling bracket screw M4*L10 (x16) Horizontal tiling bracket screw M4*L10 (x2) Horizontal tiling bracket Screw M3*L4 (x4) Flat tiling base down(x1)

Package Contents

<p>Primary Vertical tiling (1x3)</p> <ul style="list-style-type: none"> steel lanyard (x4) steel lanyard screw M4*L12 (x4) Brass nuts (x4) Thumb Screw M4*L10 (x4) Vertical tiling bracket screw M4*L10 (x16) Vertical tiling bracket (x4) System bar Box (x4) Adapter (x3) 	<p>Primary Horizontal tiling (3x1)</p> <ul style="list-style-type: none"> steel lanyard (x6) steel lanyard screw M4*L12 (x6) Brass nuts (x6) Thumb Screw M4*L10 (x4) Horizontal Tiling bracket (x2) magnetic sealing plate(x2) Adapter (x3) L back cover bracket (x2) R back cover bracket (x2) M2.5*L4 Back cover bracket screw (x16) Horizontal Tiling bracket Screw M3*L4 (x4) Flat tiling base down(x2)
--	--

Package Contents

Primary Inner tiling (2x1)		Primary Outer tiling (2x1)	
 steel lanyard (x4)	 L back cover bracket (x1)	 steel lanyard (x4)	 L back cover bracket (x1)
 steel lanyard screw M4*L12 (x4)	 R back cover bracket (x1)	 steel lanyard screw M4*L12 (x4)	 R back cover bracket (x1)
 Brass nuts (x4)	 Back cover bracket screw M2.5*L4 (x8)	 Brass nuts (x4)	 Back cover bracket screw M2.5*L4 (x8)
 Thumb Screw M4*L10 (x2)	 Inner Tiling bracket Screw M3*L4 (x2)	 Thumb Screw M4*L10 (x2)	 Outer Tiling cover up (x1)
 Inner Tiling bracket (x1)	 Inner tiling base up (x1)	 Outer Tiling bracket (x1)	 Outer tiling base down (x1)
 Inner tiling base down (x1)	 Adapter (x2)	 Outer tiling base up (x1)	 Adapter (x2)

4.2 PRIMARY 55-inch Single Screen

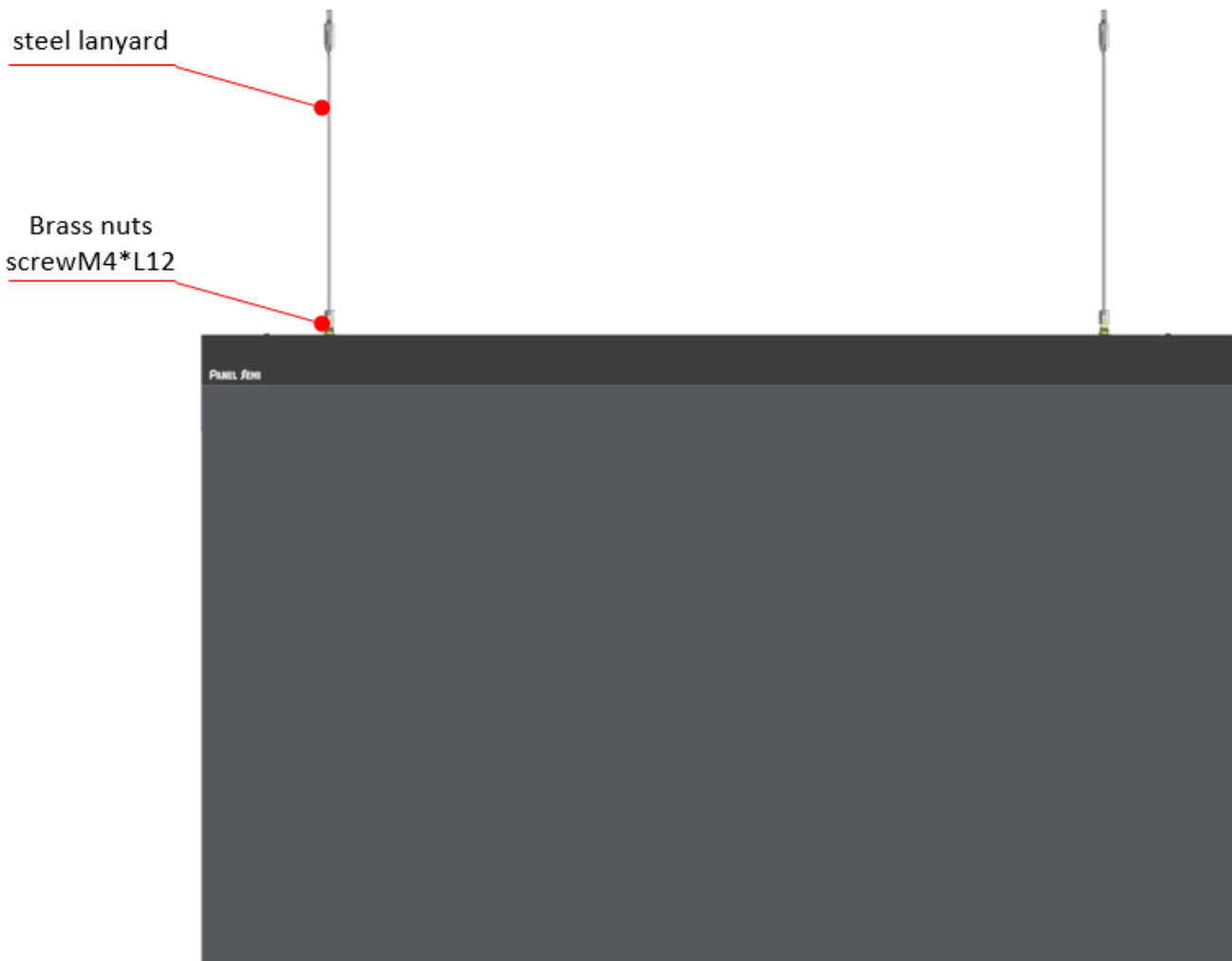

4.3 Horizontal Splicing (2X1)

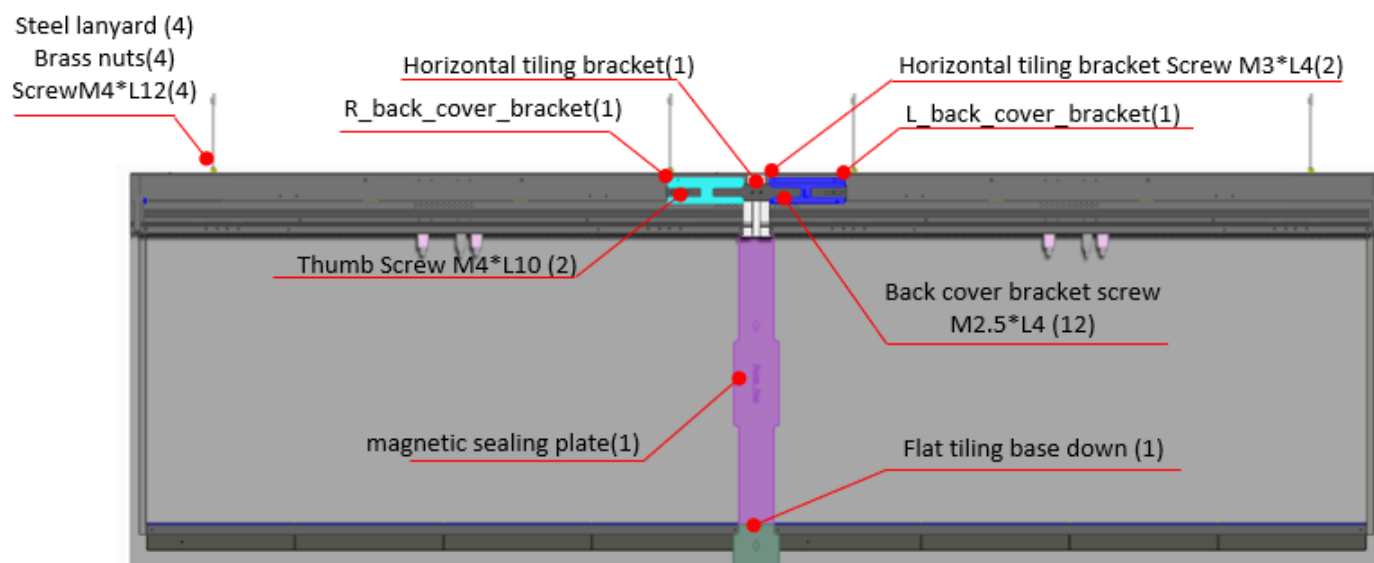
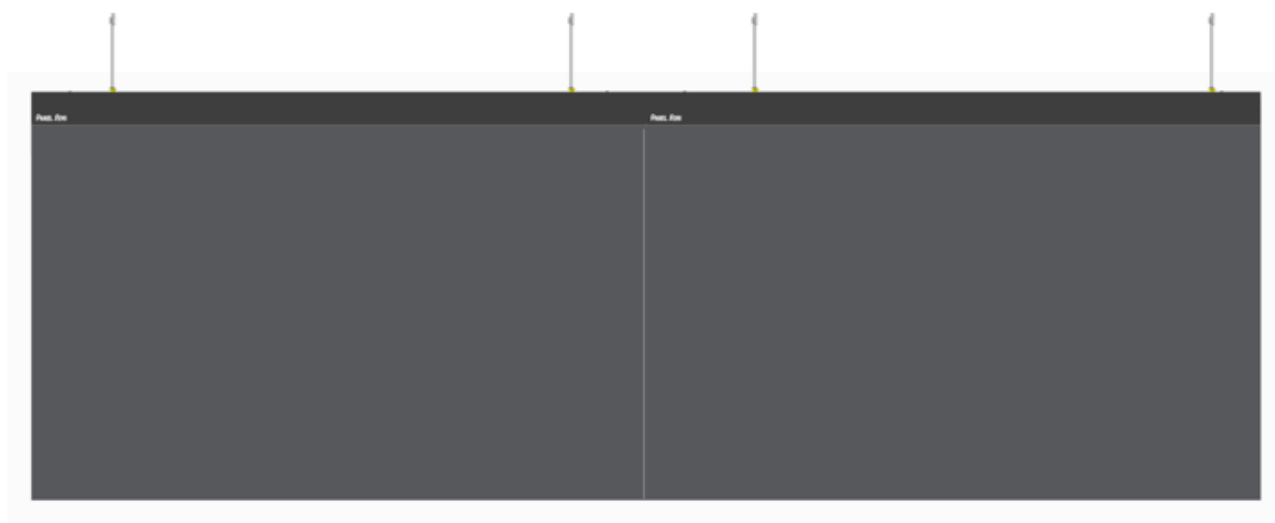

1. Install steel lanyard(1st)

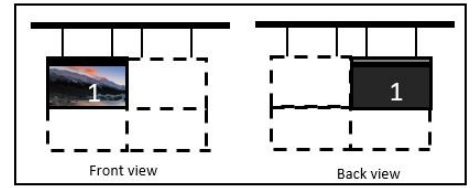

a. Install brass nuts

Tools needed



(x1)

Parts needed

Screw M4*L12 (x2) Brass nuts (x2)
(Screw torque is recommended 8kgf)

1 Use the M4 screws in the accessory kit fix the brass nuts in the hole above the system bar

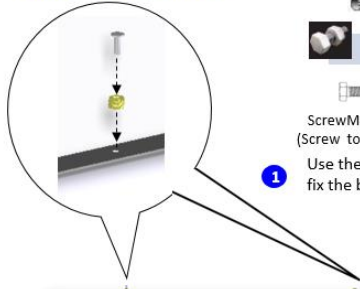

1st
Front view

b. Install steel lanyard

Parts needed

Steel lanyard (x2)

1 make sure that the lanyard and the Brass nuts are locked tightly during installation

2 Turn the front end of the Steel lanyard clockwise into brass nuts to fix it. same finish on the other side

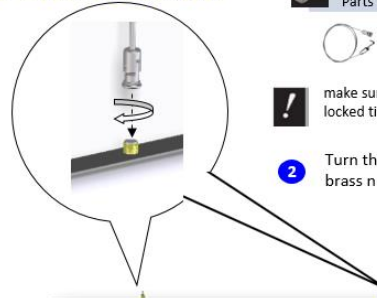

1st
Front view

Horizontal tiling

2. Install splicing accessories (splicing slide rails)

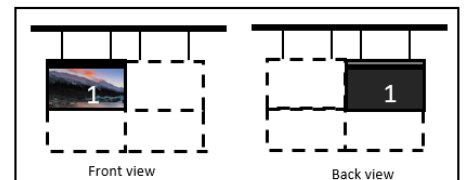

Tools needed



(x1)

Parts needed

M2.5*L4 Back cover bracket screw (x4)
(Screw torque is recommended 3kgf)

L back cover bracket

Use M2.5*L4 screws to lock (a total of four places)
(Screw torque is recommended 3kgf)

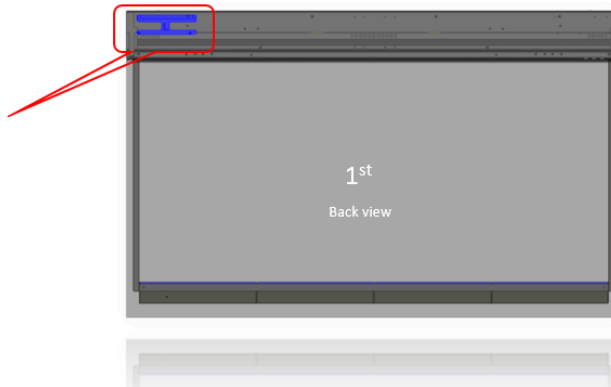
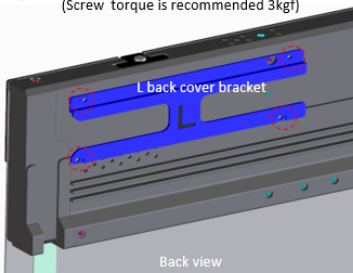

1st
Back view

Horizontal tiling

3. Install the first set

a. Hanging 1st set

- 1 Confirm the installation position of the screen, measure steel lanyard spacing and horizontal spacing and set length (Reserved installation location)
- 2 Install fixed rings on the ceiling

! It is recommended to keep a distance of 1 meter from the side of the power cord of the screen for future maintenance.

b. Adjust screen level

- 1 You can use a spirit level to make adjustments, then use this screen as a datum for stitching

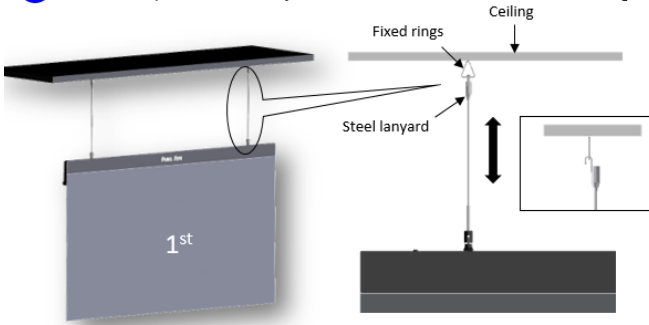

- !** When there are two or more installations, it is necessary to confirm whether the space is sufficient in advance.
- !** Please check whether the hanging ring has enough load-bearing.
Ex: Single screen: a single hanging ring needs to bear 10kg↑; the connection wall needs to bear 20kg
- !** Please make sure the hanging bracket is level. Can be confirmed with a spirit level

Horizontal tiling

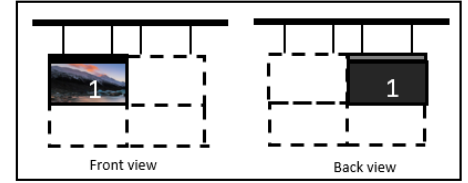

4. Remove the side cover

Tools needed



a. Check the orientation of adjacent edges

- 1 Confirm the sorting position of splicing, and select the adjacent position (as shown in the figure below)
- 2 Use tools to remove the side cover screws M3*L4 (total 4 places)

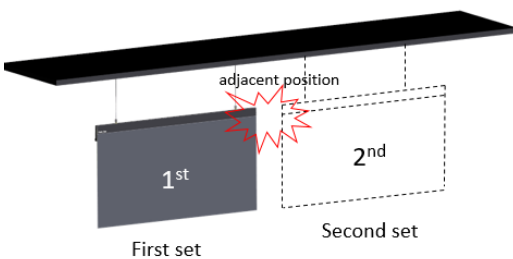

- !** Be careful when using tools and don't touch the screen
- !** The removed screws need to be kept carefully (side cover screw specification: M3*L4)

b. Remove the side cover from the adjacent side

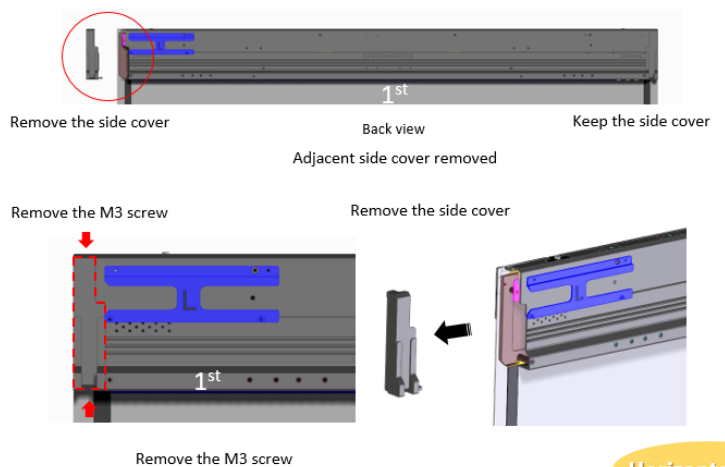

Horizontal tiling

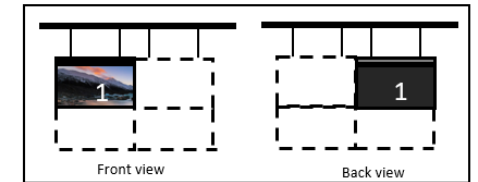

5. Install Tiling accessories - tiling bracket



Parts needed



M4*L10 Thumb screw (x1)



Horizontal tiling bracket(x1)

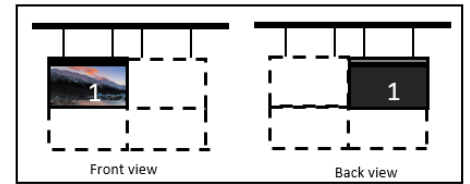

1 Align the Tiling bracket with the rail on the back of the System bar

Use M4 Thumb Screw to lock (a total of one places)

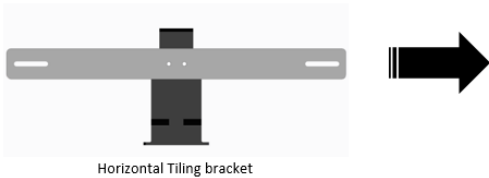

Horizontal Tiling bracket

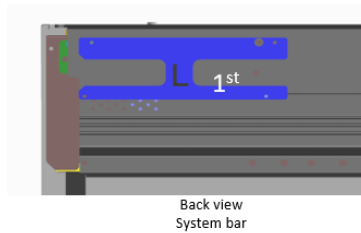

Back view
System bar

2 Push it horizontally to the bottom so that the tiling bracket is flush with the side end

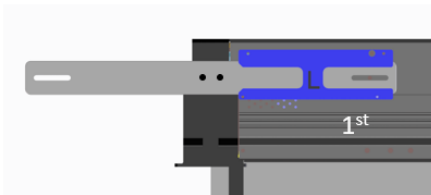

3 Use M4*L10 Thumb Screw to lock (a total of one places)

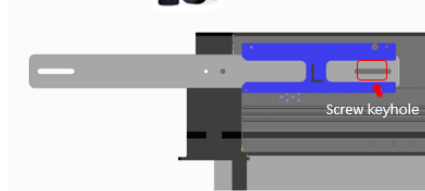

Screw keyhole

Horizontal tiling

6. Install steel lanyard(2nd)

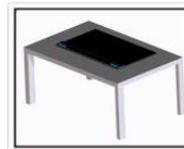

CAUTION

Please put the set on the table and make sure the table is flat and free of foreign objects before operation



a. Install brass nuts



Tools needed



(x1)



Parts needed

Screw M4*L12 (x2) Brass nuts (x2)
(Screw torque is recommended 8kgf)

1 Use the M4 screws in the accessory kit fix the brass nuts in the hole above the system bar

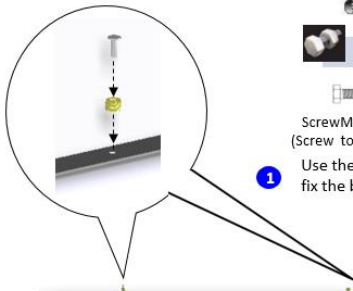

2nd
Front view

b. Install steel lanyard



Parts needed



Steel lanyard (x2)



Make sure that the lanyard and the Brass nuts are locked tightly during installation

2

Turn the front end of the Steel lanyard clockwise into brass nuts to fix it. same finish on the other side

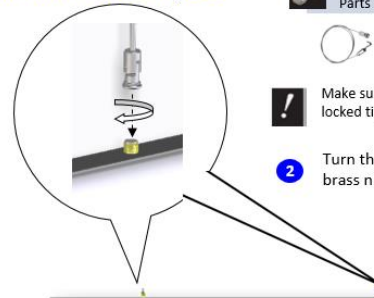

2nd
Front view

Horizontal tiling

7. Install splicing accessories (splicing slide rails)



Tools needed



Parts needed

- M2.5*L4 Back cover bracket screw (x4) (Screw torque is recommended 3kgf)
- R back cover bracket(x1)

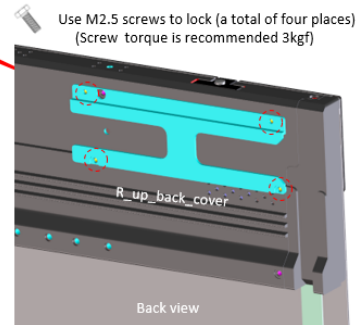
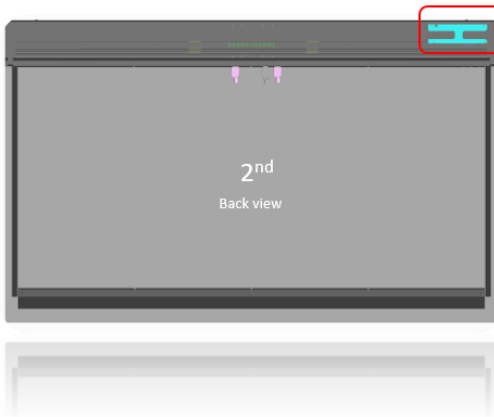

Horizontal tiling

8. Remove the side cover



Tools needed



a. Check the orientation of adjacent edges

- Confirm the sorting position of splicing, and select the adjacent position (as shown in the figure below)
- Use tools to remove the side cover screws M3*L4 (total 4 places)

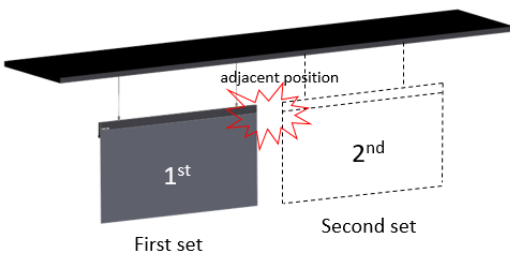

- Be careful when using tools and don't touch the screen
- The removed screws need to be kept carefully (side cover screw specification: M3*L4)

b. Remove the side cover from the adjacent side

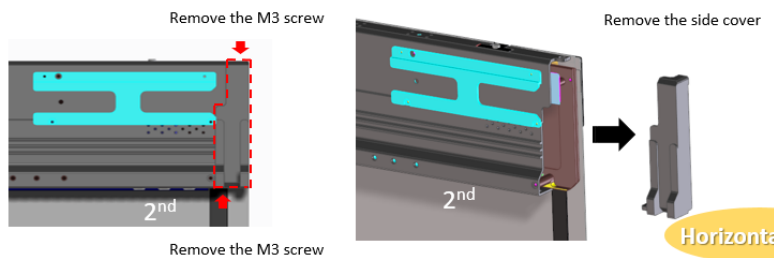
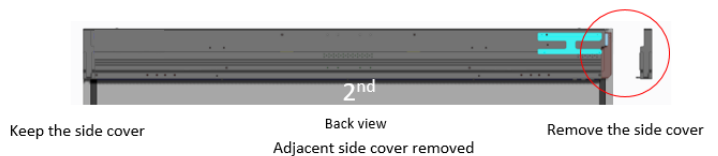

Horizontal tiling

9. Install 2nd set

- 1 Hang set 2nd next to set 1st
- 2 Move the steel lanyard so that set 2nd is closer to set 1st
- 3 Align the tiling brackets with the slide rails
- 4 Push the second set to the end so that the two are aligned

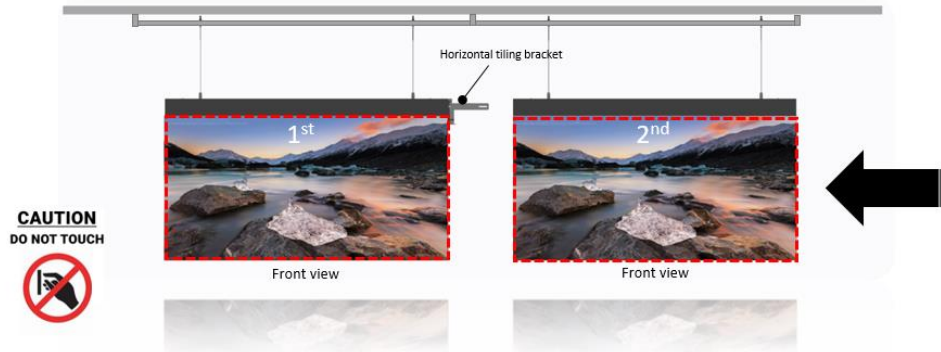

- ! Do not bend the screen when hanging it, otherwise it may cause set damage
- ! Please check whether the hanging ring has enough load-bearing.
Ex: Single screen: a single hanging ring needs to bear 10kg↑; the connection wall needs to bear 40kg ↑

Horizontal tiling

10. Adjust horizontal position



Steel lanyard length adjustment method

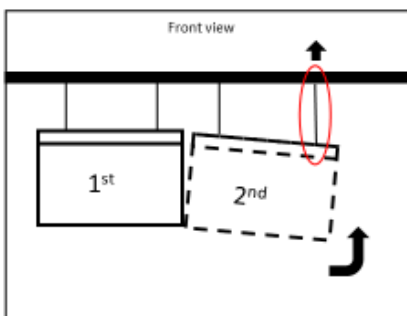

There is a gap at the top of the screen
→ Need to adjust the outer steel lanyard

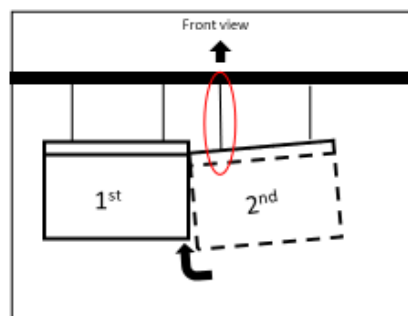

There is a gap at the bottom of the screen
→ Need to adjust the inner steel lanyard

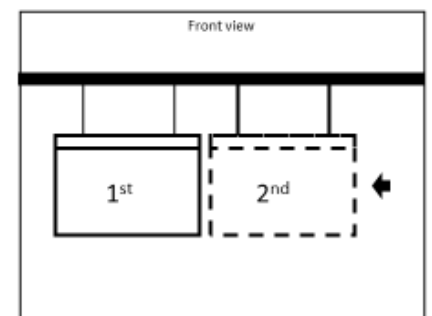

Even screen gap
→ Pan to the fixed screen

Horizontal tiling

11. Fixed Tiling bracket



Tools needed



(x1)



Parts needed

M3*L4 Screw (x2)
(Screw torque is recommended 5kgf)



M4*L10 Thumb Screw (x1)

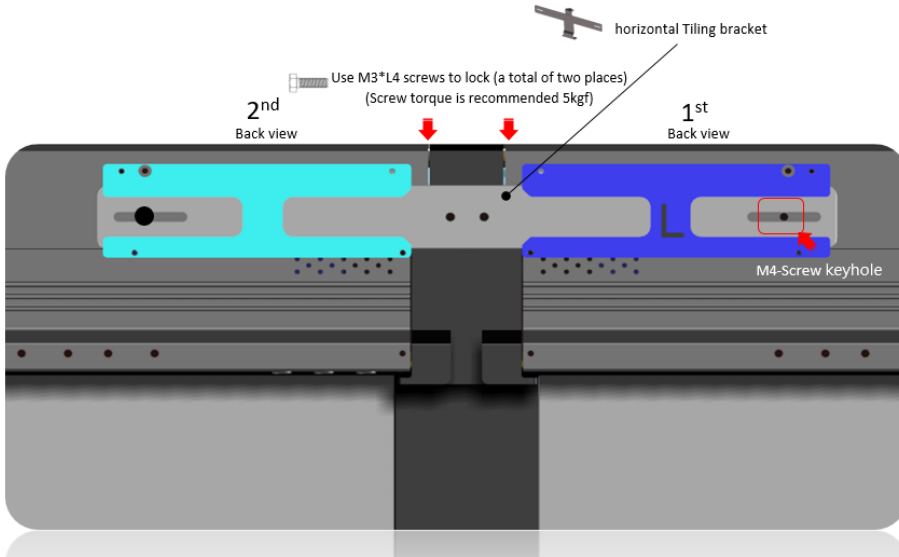
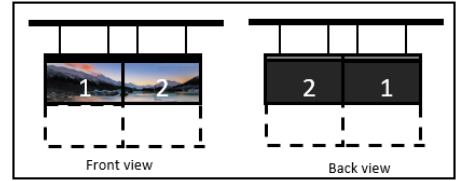

Use M4 Thumb Screw to lock (a total of one places)

M4*L10 Thumb Screw (x1)

Horizontal tiling

12. Install the magnetic sealing plate

- Put the notch of magnetic sealing plate into the 1st screen metal A & 2nd screen metal A.
- Let metals A stuck into notch of magnetic sealing plate.



Parts needed

magnetic sealing plate(x1)

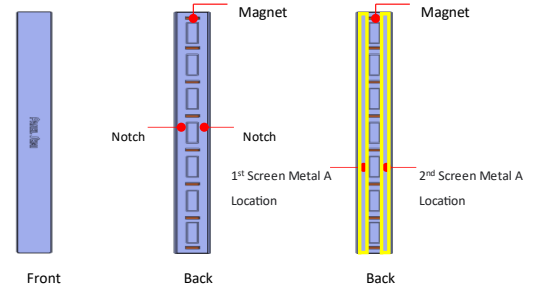
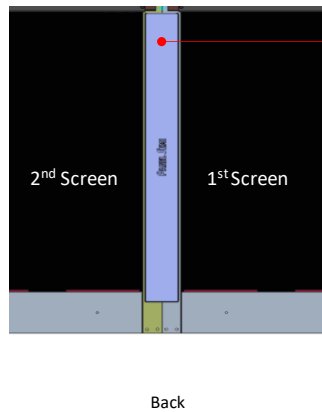
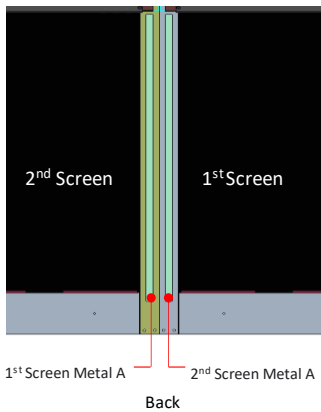

Horizontal tiling

4.4 Vertical Splicing (1X2)

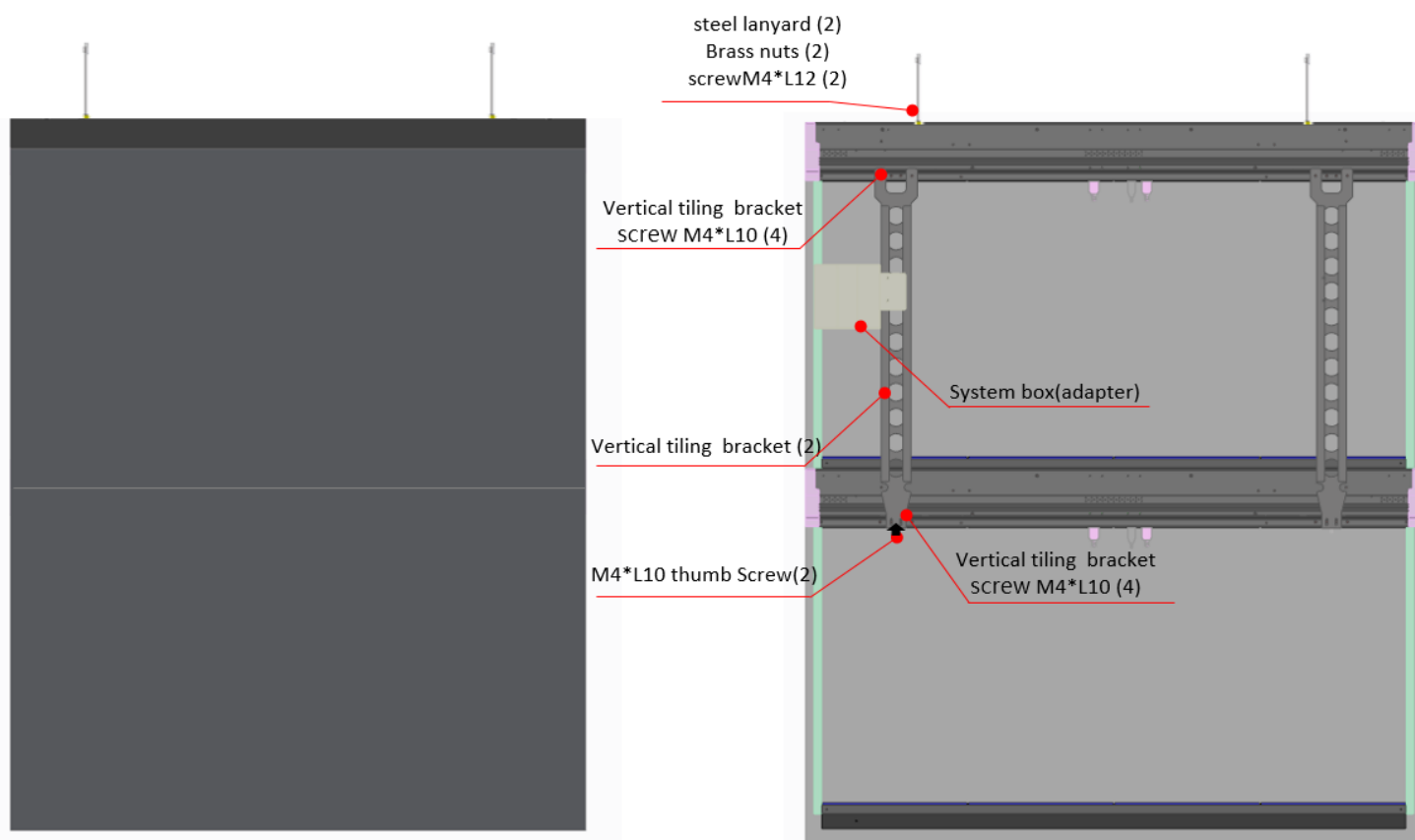

1. Install vertical tiling accessories (1st & 2nd)

Tools needed



Parts needed

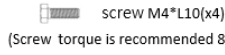

(Screw torque is recommended 8kgf)

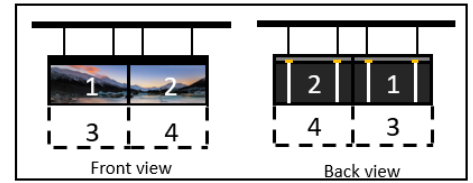

- 1 Install the bracket on the back of the 1st and 2nd sets, use M4*L10 screws to fix them(4 places in total)

※ Pay attention to the installation direction of the bracket, the notch faces upwards, With the tip pointing down, the L-shape extends forward

! Pay attention to the surrounding environment and personnel when installing Bracket, do not knock on personnel and screens

- Use M4*L10 screws to lock (a total of four places) (Screw torque is recommended 8kgf)

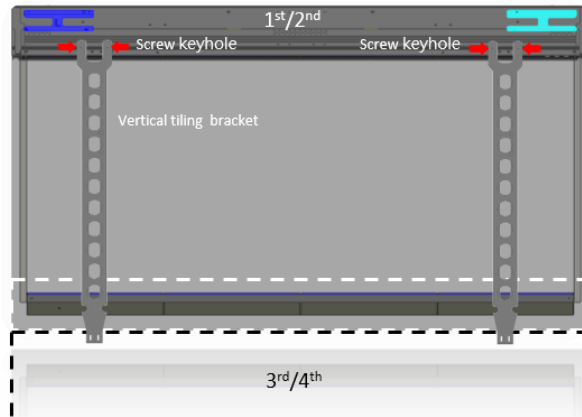

Vertical tiling

2. Remove the bezel(3rd)

Tools needed



- 1 Find the bezel fixing buckle above 3rd
- 2 Take out the Pin in the direction of the arrow (two places in total)
- 3 Take out the bushing the direction of the arrow (two places in total)

※ A flat tool or tweezers can be used to assist

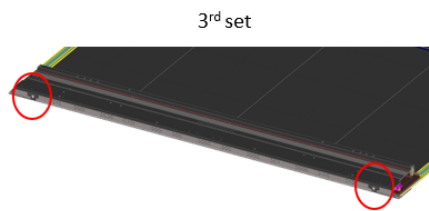
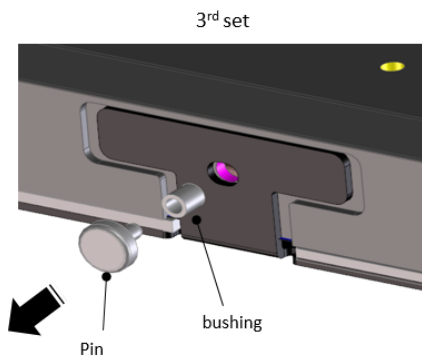

Vertical tiling

3. Install splicing accessories (splicing slide rails)

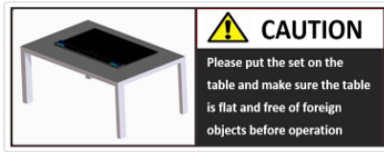

Tools needed



Parts needed

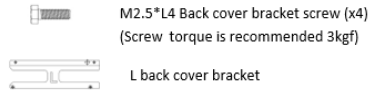

Use M2.5*L4 screws to lock (a total of four places)
(Screw torque is recommended 3kgf)

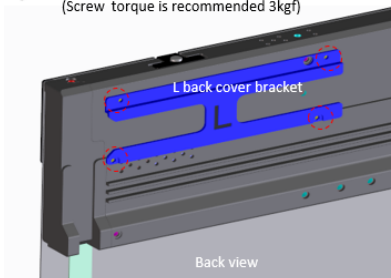

Vertical tiling

4. Install 3rd set

Tools needed



Parts needed

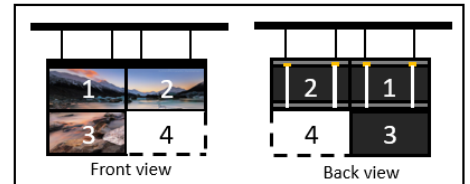
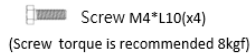

1 Open the screen of the 1st set and install the 3rd set on the Bracket

2 Use M4*L10 screws to pre-fix the Bracket (4 places in total)

※ Need to adjust, do not lock

! Please be careful when installing the screen, do not fold the screen

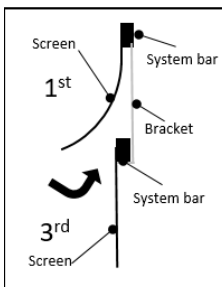

Side view

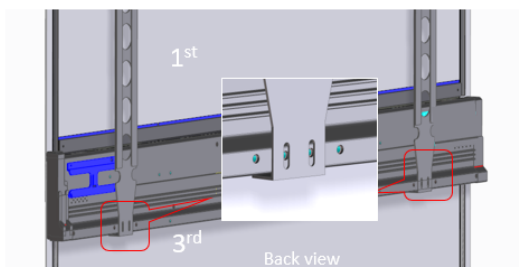

! When installing, be careful not to cause collisions here

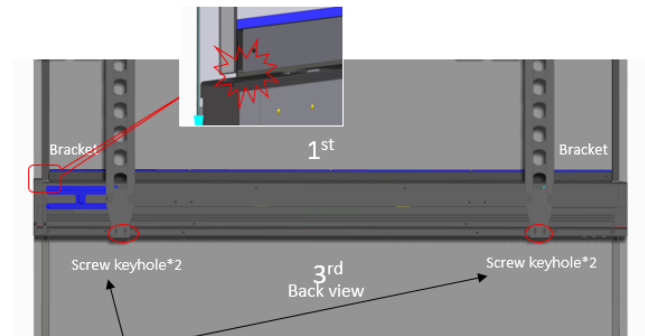

Use M4*L10 screws to lock (a total of four places)
(Screw torque is recommended 8kgf)

Vertical tiling

5. Adjust vertical position

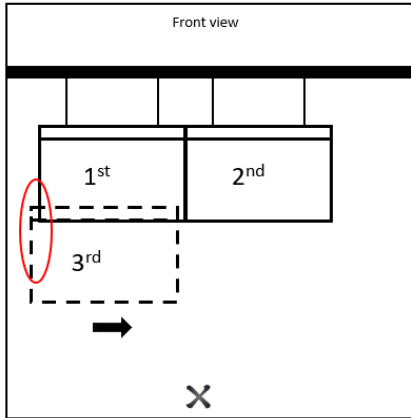

Bottom screen edge extends beyond top screen
 → Move the bottom screen to the middle

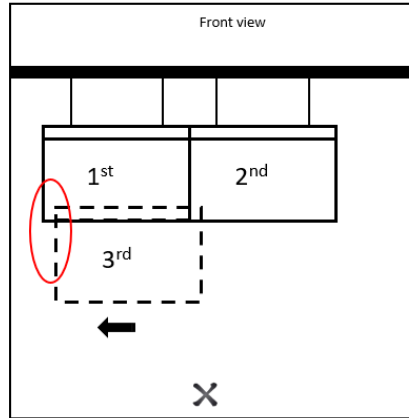

Top screen edge extends beyond bottom screen
 → Move bottom screen to outside

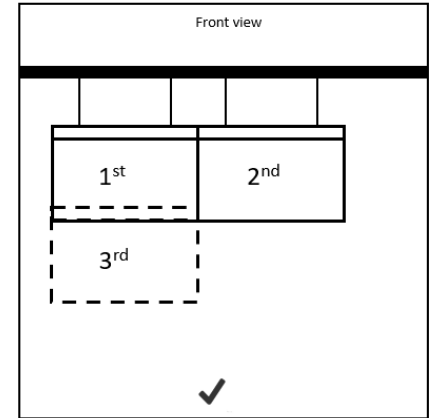

After adjustment, the edges of the upper and lower screens are aligned

Vertical tiling

6. Adjust horizontal position

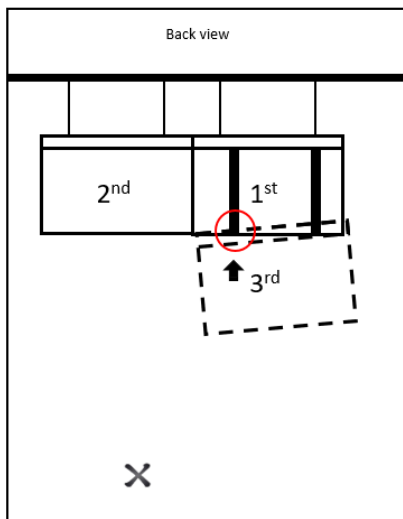

There is a gap between the lower screen and the upper screen
 → Thumb screws on the bracket need to be adjusted

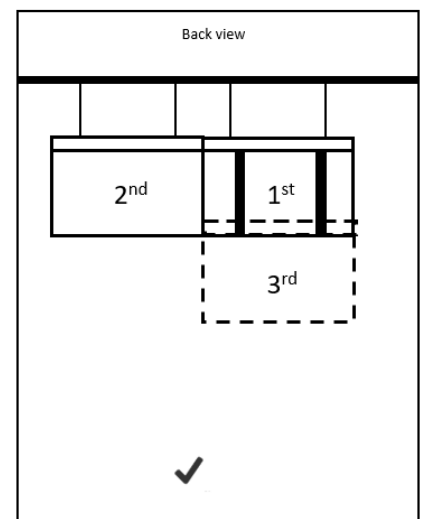
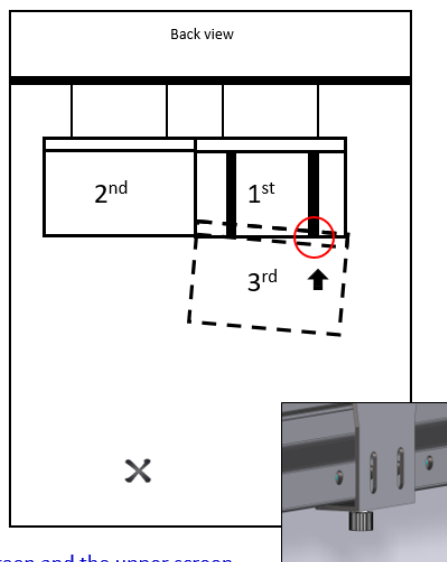

After adjustment, the edges of the upper and lower screens are aligned

Vertical tiling

4.5 Large Screen Splicing (2X2)

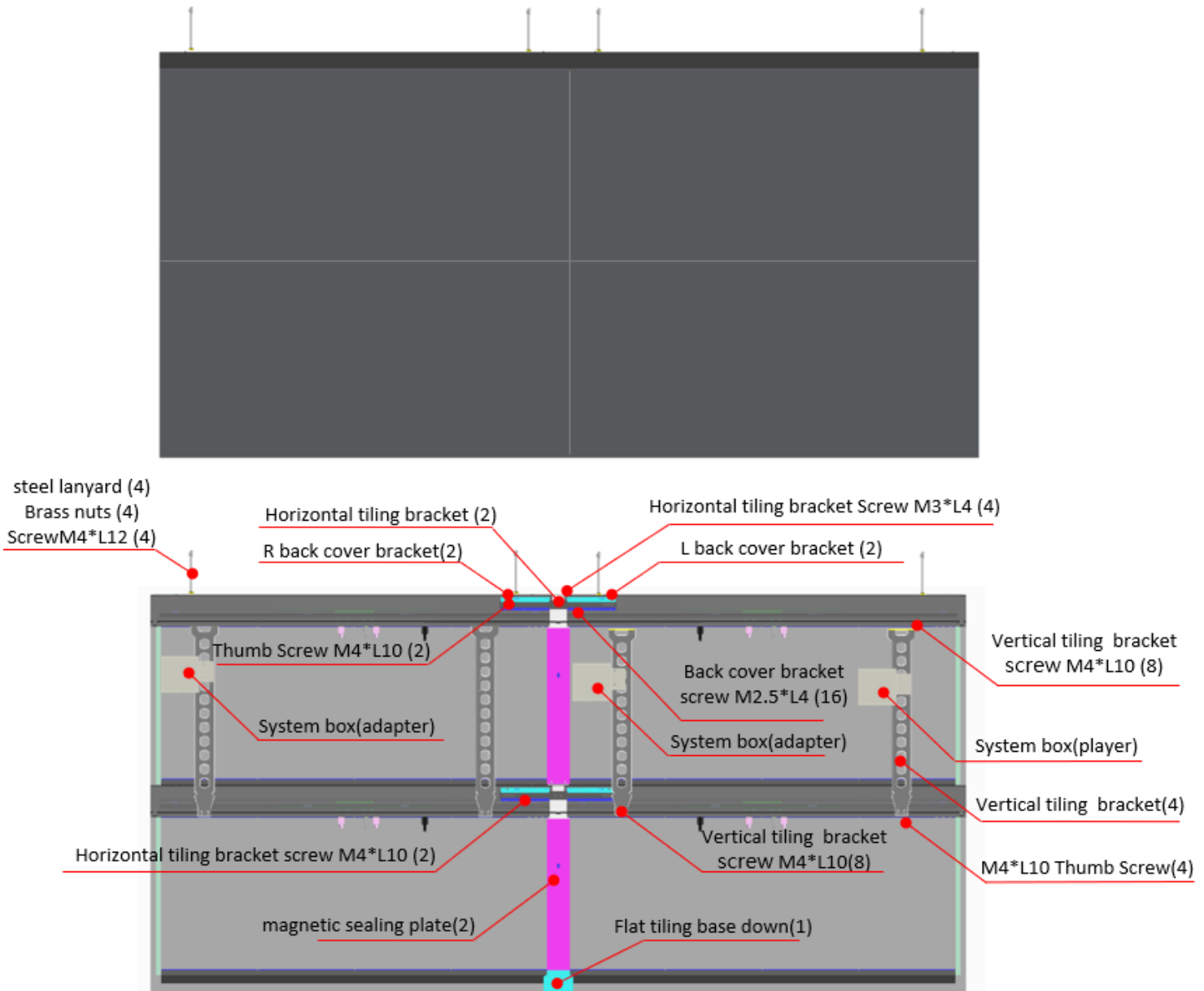

7. Install Tiling accessories - Tiling bracket

Tools needed



(x1)

Parts needed

M4*L10 Horizontal tiling bracket screw (x1)
(Screw torque is recommended 8kgf)

Horizontal Tiling bracket(x1)



- Align the Tiling bracket with the rail on the back of the System bar

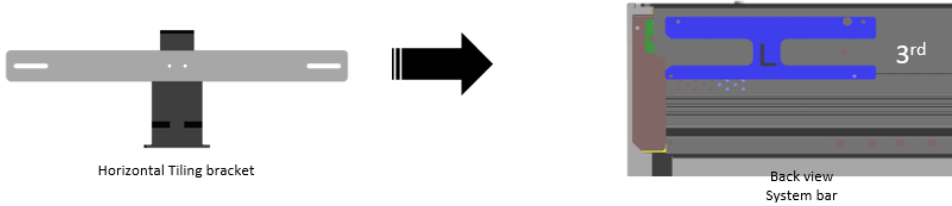

- Push it horizontally to the bottom so that the Tiling bracket is flush with the side end



- Use M4*L10 Horizontal tiling bracket screw to lock (a total of one places)



Vertical tiling

8. Remove the bezel(4th)

Tools needed

Tweezers (x1)

- Find the bezel fixing buckle above 4th
- Take out the Pin in the direction of the arrow (two places in total)
- Take out the bushing the direction of the arrow (two places in total)

※ A flat tool or tweezers can be used to assist

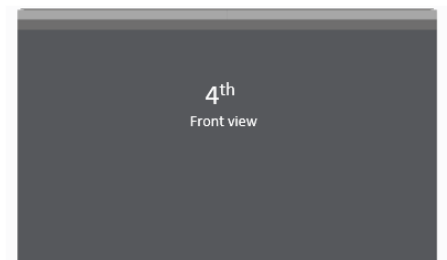
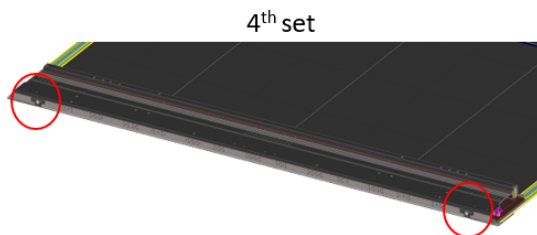
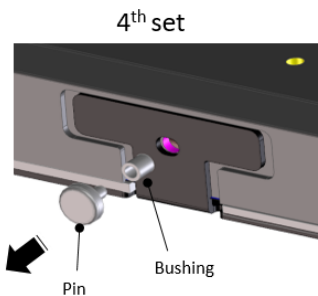
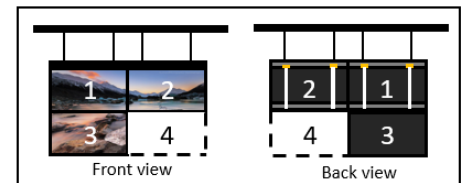
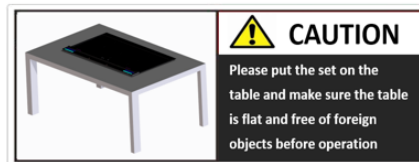

Vertical tiling

9. Install splicing accessories (splicing slide rails)

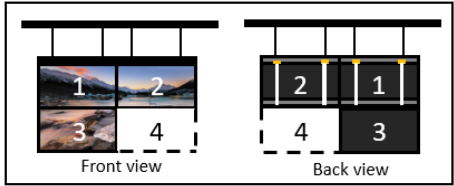

Tools needed



Parts needed

- M2.5*L4 Back cover bracket screw (x4)
(Screw torque is recommended 3kgf)
- R back cover bracket

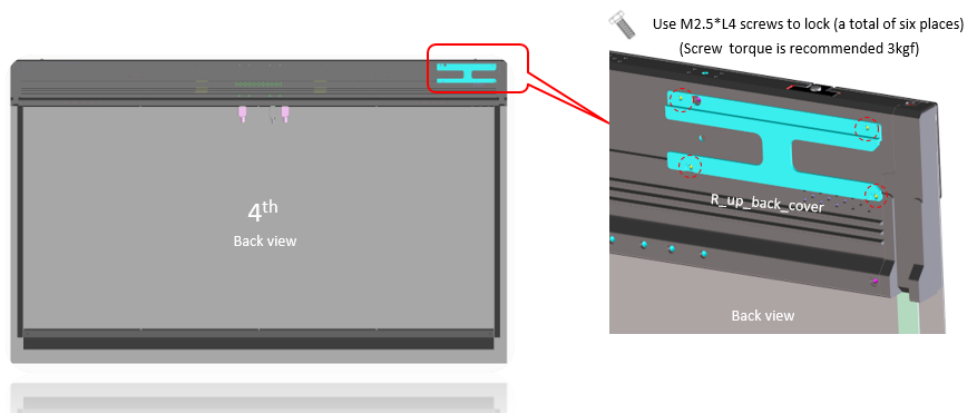

Vertical tiling

10. Install 4th set

Tools needed



Parts needed

- Screw M4*L10(x4)
(Screw torque is recommended 8kgf)



- 1 Open the screen of the 2nd set and install the 4th set on the Bracket
 - 2 Use M4*L10 screws to pre-fix the Bracket (4 places in total)
- ※ Need to adjust, do not lock
- ! Please be careful when installing the screen, do not fold the screen

! When installing, be careful not to cause collisions here

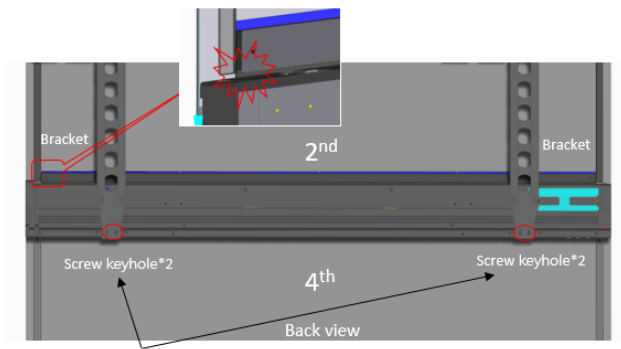
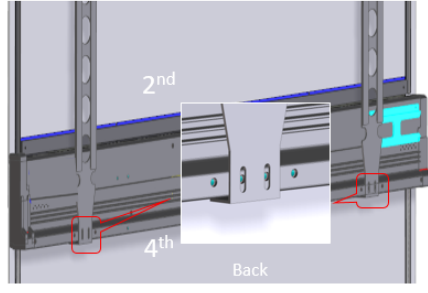
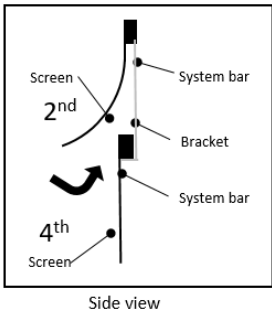

Use M4*L10 screws to lock (a total of four places)

Vertical tiling

11. Adjust vertical position

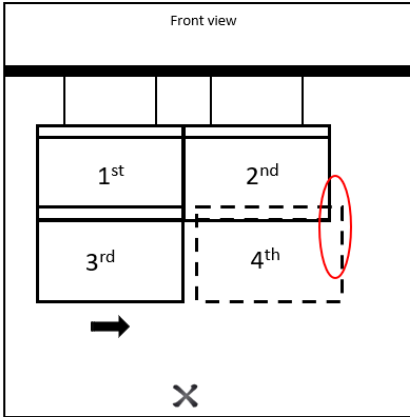

Bottom screen edge extends beyond top screen
→ Move the bottom screen to the middle

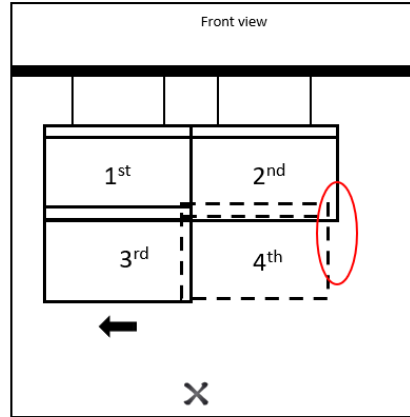

Top screen edge extends beyond bottom screen
→ Move bottom screen to outside

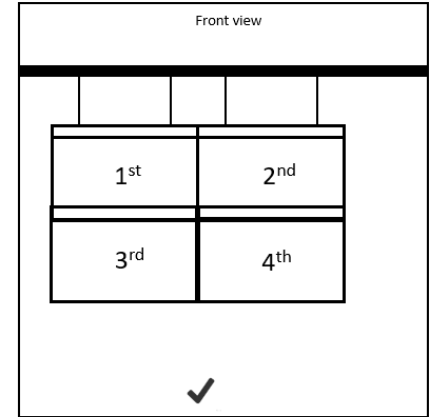

After adjustment, the edges of the upper and lower screens are aligned

Vertical tiling

12. Adjust horizontal

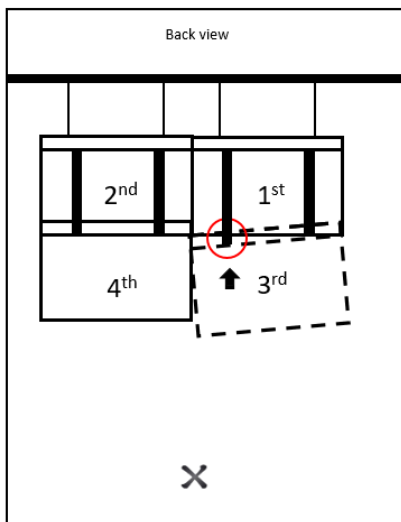

There is a gap between the lower screen and the upper screen
→ Thumb screws on the bracket need to be adjusted

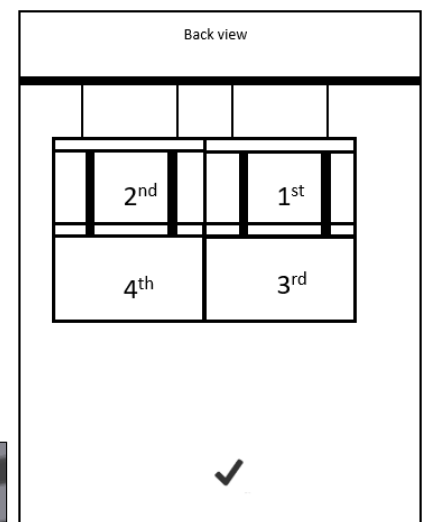
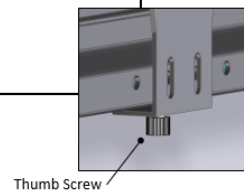
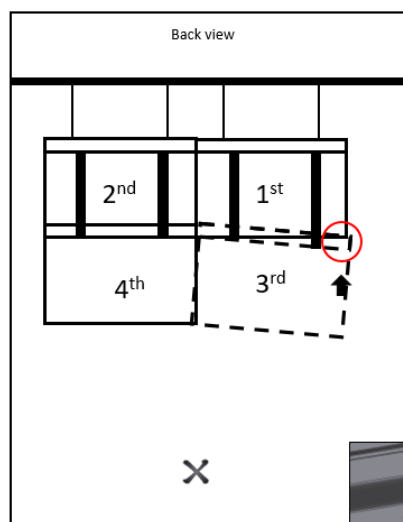

After adjustment, the edges of the upper and lower screens are aligned

Vertical tiling

13. Fixed Tiling bracket



Tools needed



(x1)



Parts needed

M3*L4 Screw (x2)

(Screw torque is recommended 5kgf)

M4*L10 Horizontal tiling bracket screw (x1)

(Screw torque is recommended 8kgf)

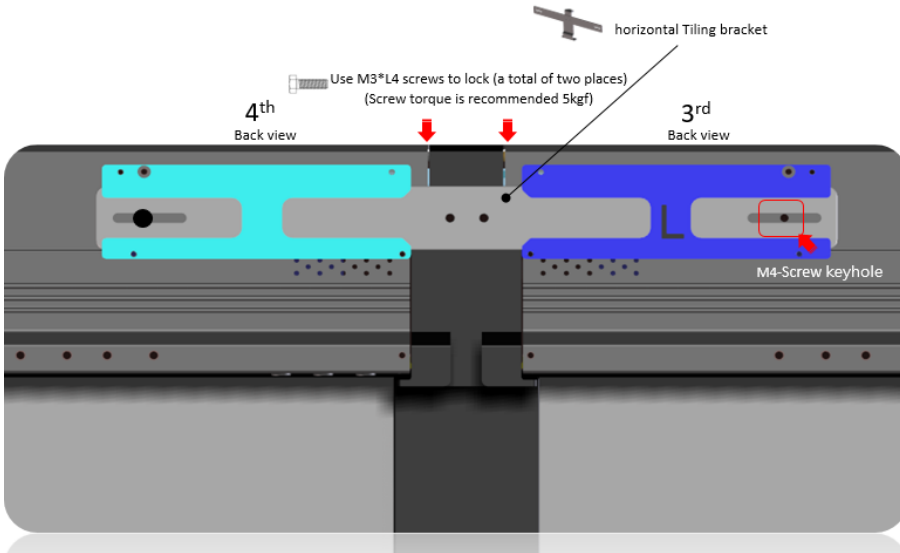
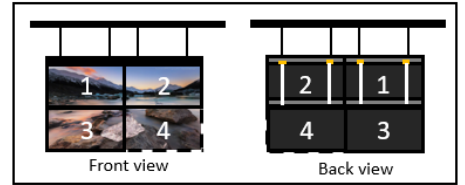

Use M4 Horizontal tiling bracket screw to lock (a total of one places)

M4*L10 Thumb Screw (x1)

Horizontal tiling

14. Install the magnetic sealing plate

- Put the notch of magnetic sealing plate into the 3rd screen metal A & 4th screen metal A.
- Let metals A stuck into notch of magnetic sealing plate.



Parts needed

magnetic sealing plate(x1)

Flat tiling base down(x1)

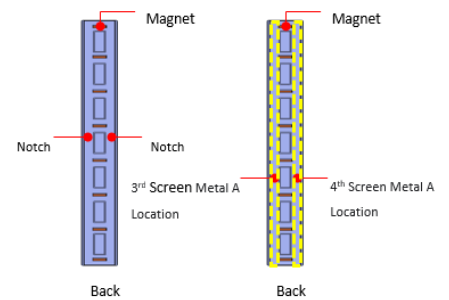
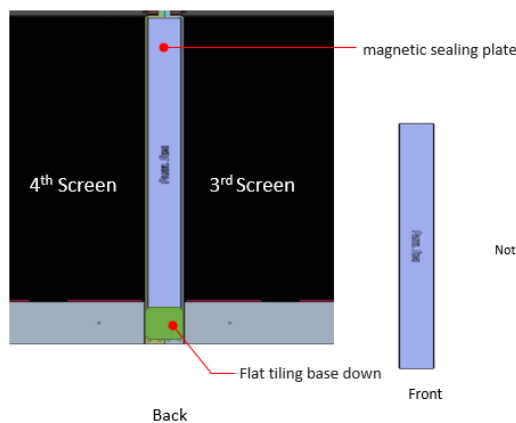
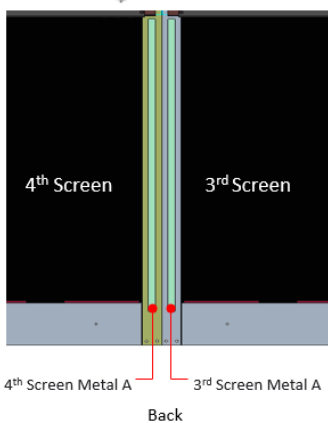

Vertical tiling

4.6 Vertical Splicing (1X3)

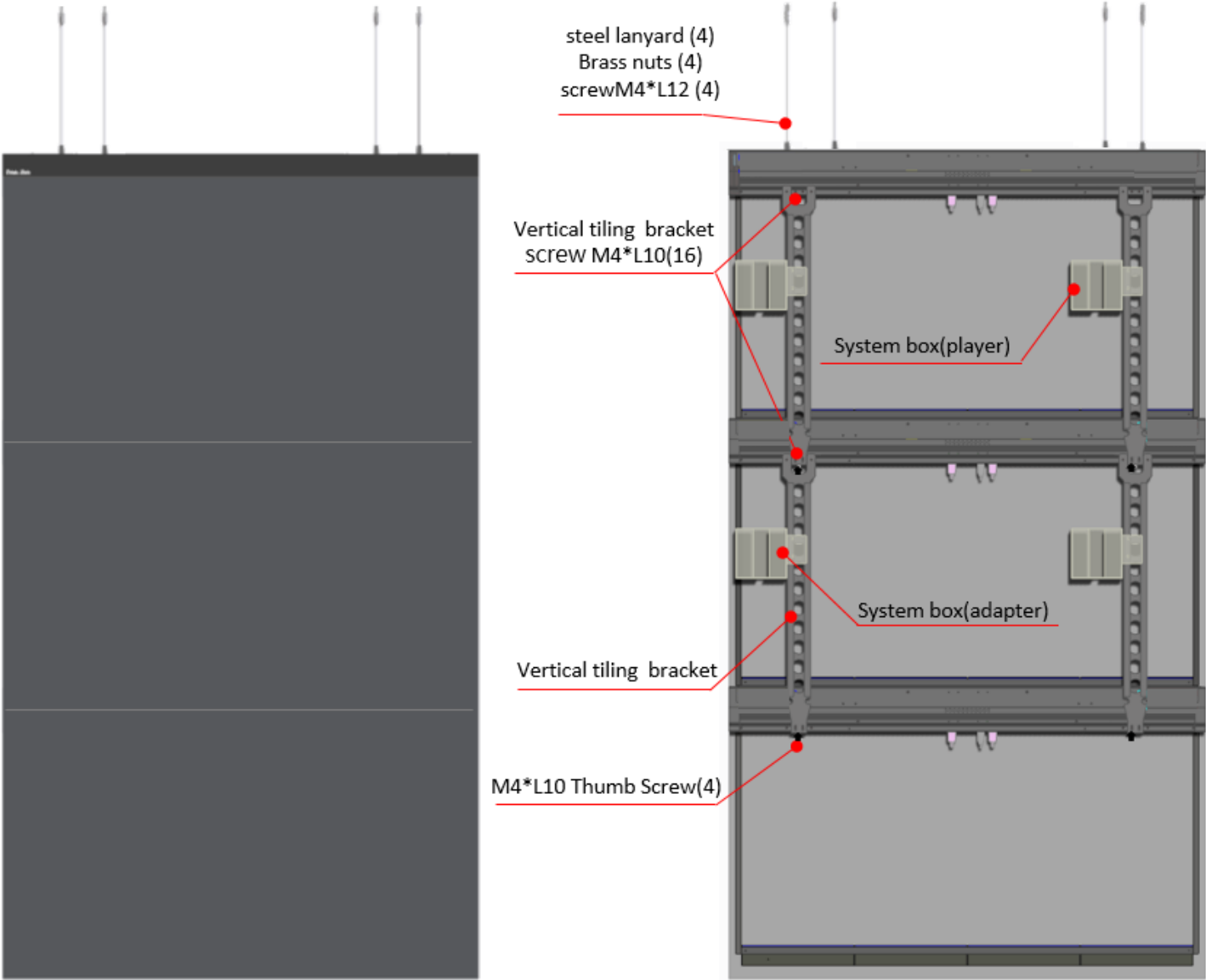

4.7 Horizontal Splicing (3X1)

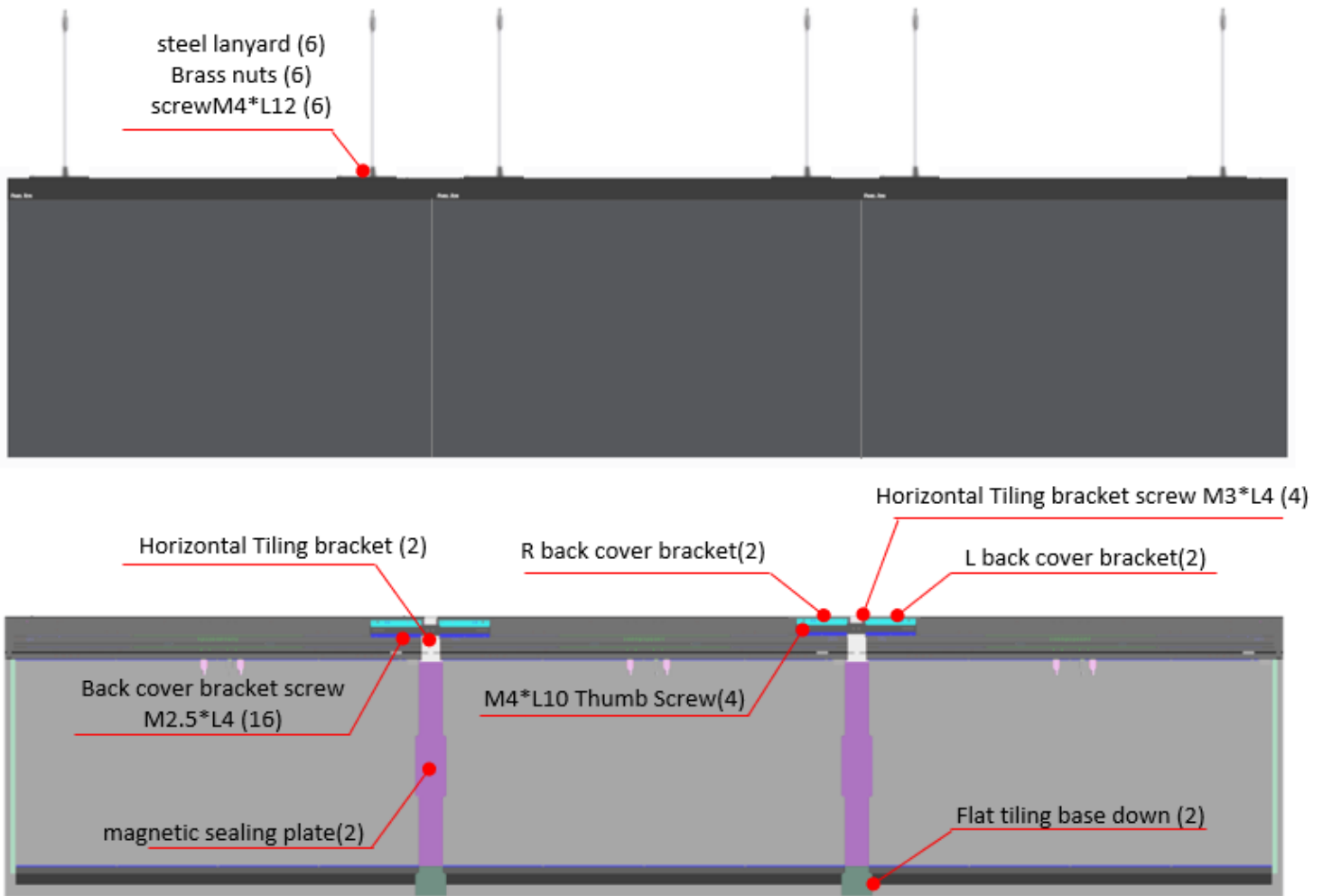

4.8 Inner Right-Angle Splicing (2X1)

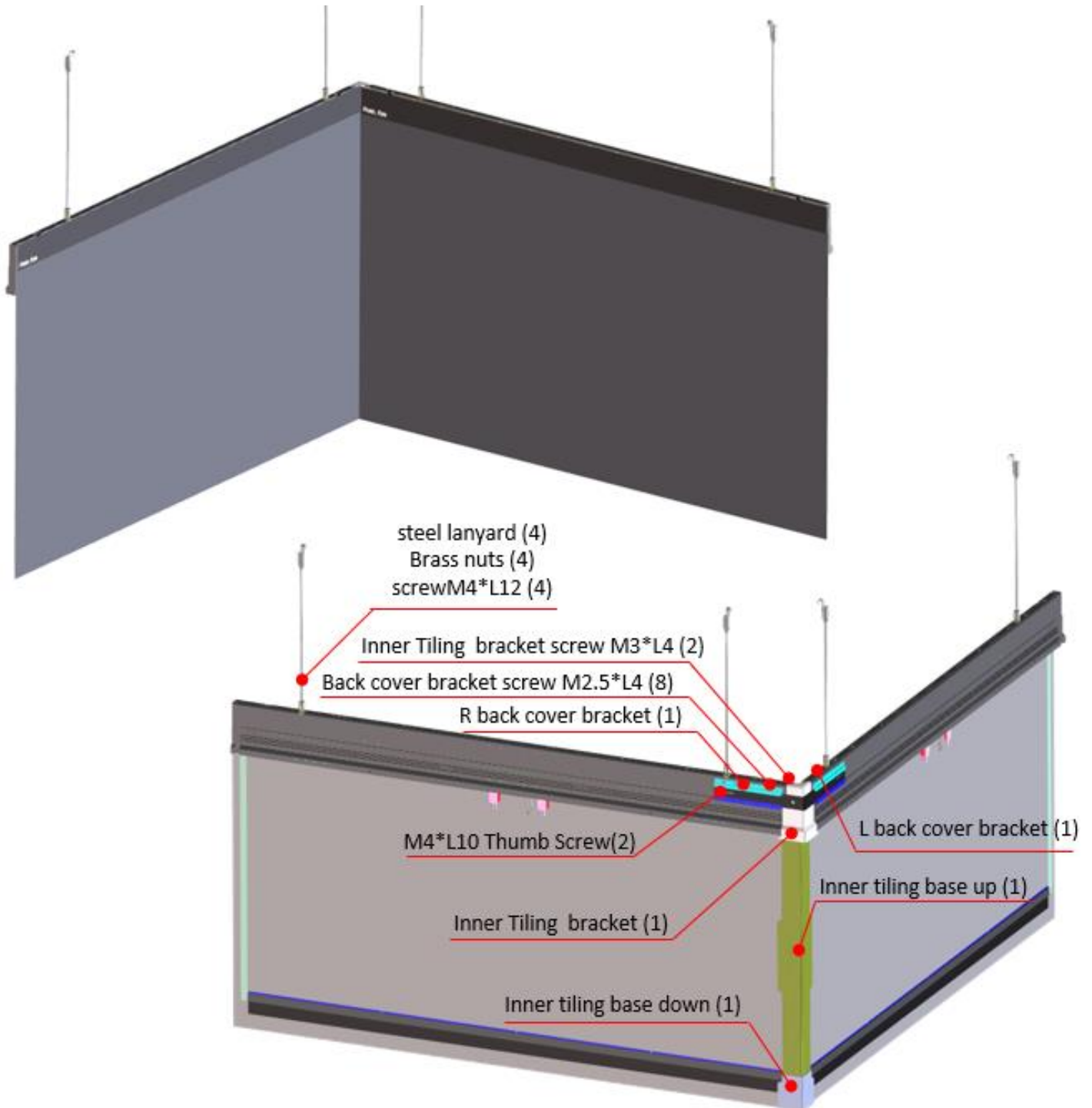

4.9 Outer Right-Angle Splicing (2X1)

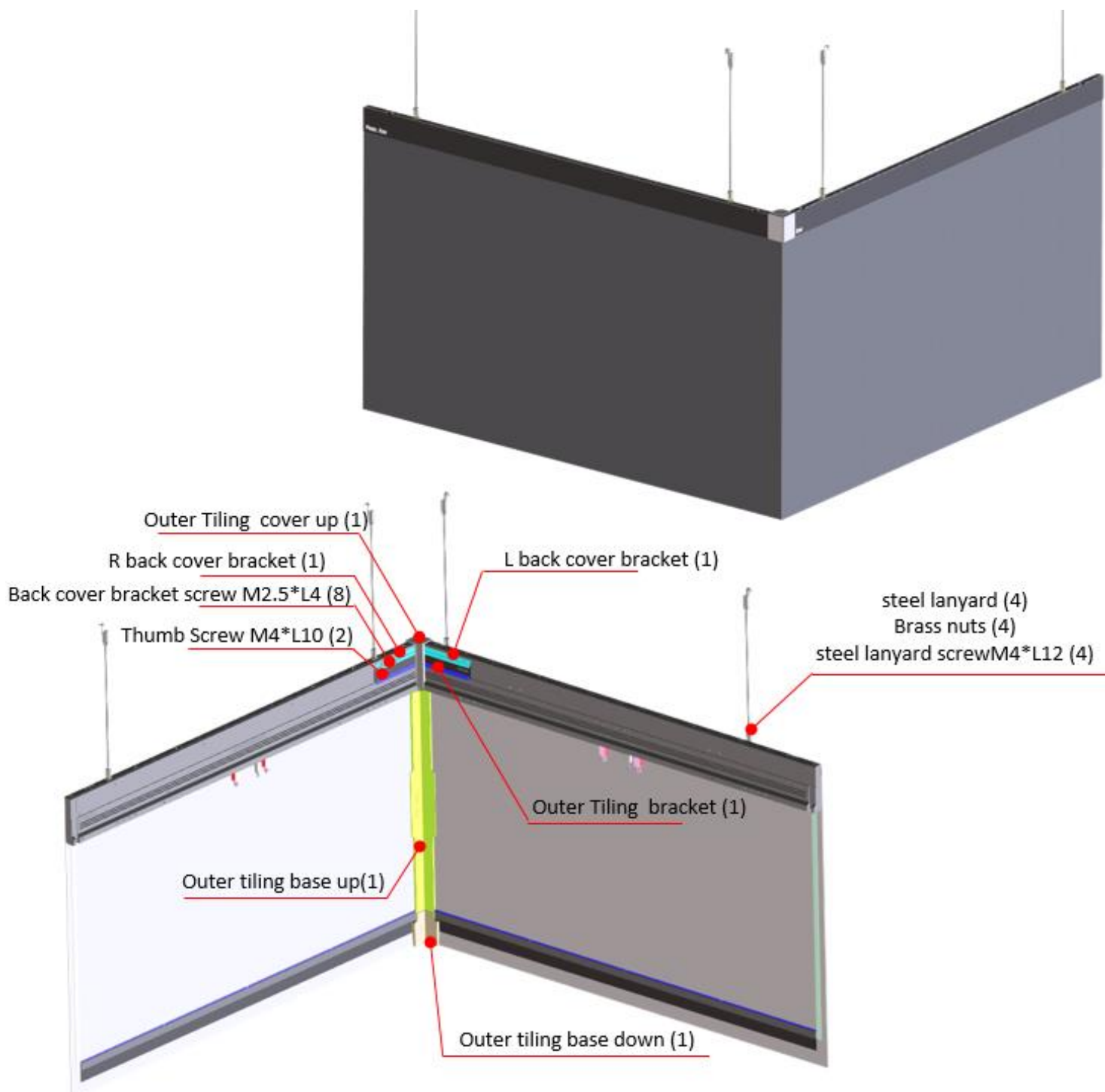

5. Optical User Interface (UI) Operation Instructions

5.1 Purpose

After merging screens into one large display, use the UI interface to adjust the overall brightness, color temperature, color gamut, Gamma, and other parameters of the large screen to achieve consistent overall display quality.

5.2 Operation Procedure

Use HDMI, Micro USB, USB Type-A, or similar cables to connect the screens. Use the software to perform the following steps:

1. Merge screens into one large display.
2. Adjust the color uniformity between screens.
3. Adjust the overall optical characteristics of the large screen.
 - Main adjustments include:
 - Brightness adjustment
 - Gamma adjustment
 - Color temperature adjustment
 - Color gamut adjustment

***Important:** To enter the Optical UI adjustment mode, you must connect the computer and the UI program to screen "ID 1" using USB Type-A / HDMI.

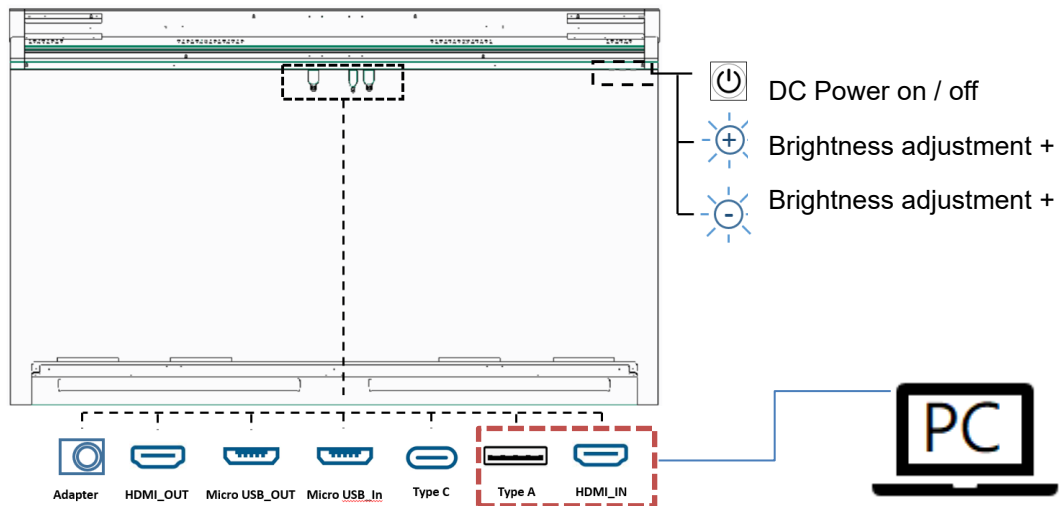

Picture: Connection port information on the back of the screen

Additional Information:

- a) This section applies to both Primary single-screen optical adjustments and multi-screen optical adjustments.
- b) For multi-screen adjustments, it is necessary to first connect the screens using HDMI and Micro USB.

5.3 Cable Connection Method

5.3.1 Horizontal Splicing

Large Screen Sketch

Columns 2

Rows 1

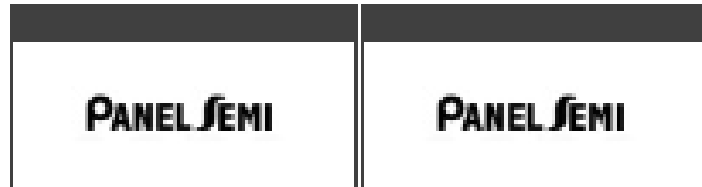

2 single screen combinations

Large screen resolution 1920 x 540

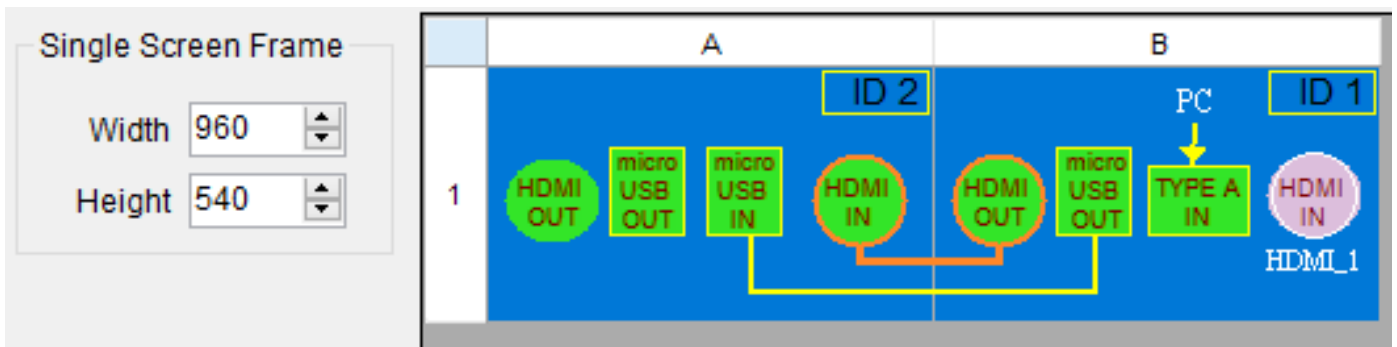

5.3.2 Vertical Splicing

Large Screen Sketch

Columns

Rows

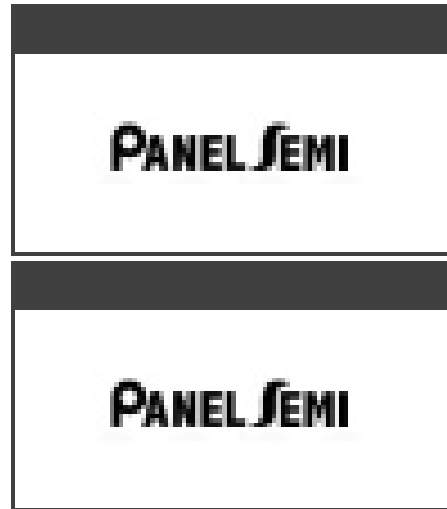

2 single screen combinations

Large screen resolution 960 x 1080

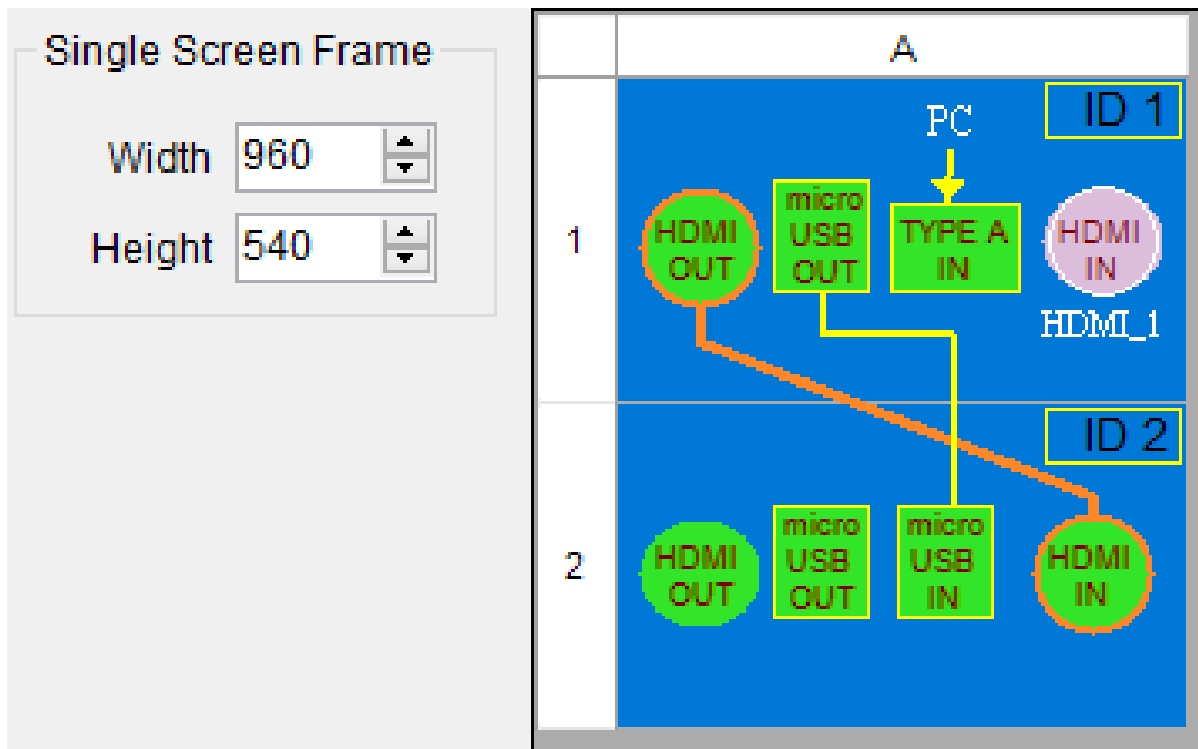

5.3.3 Large Screen Splicing

Large Screen Sketch

Columns

Rows

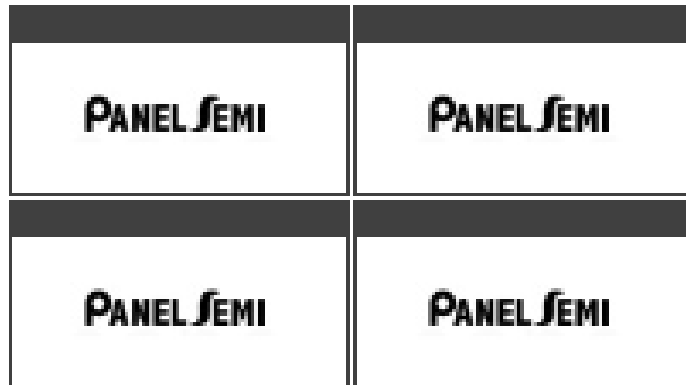

4 single screen combinations

Large screen resolution 1920 x 1080

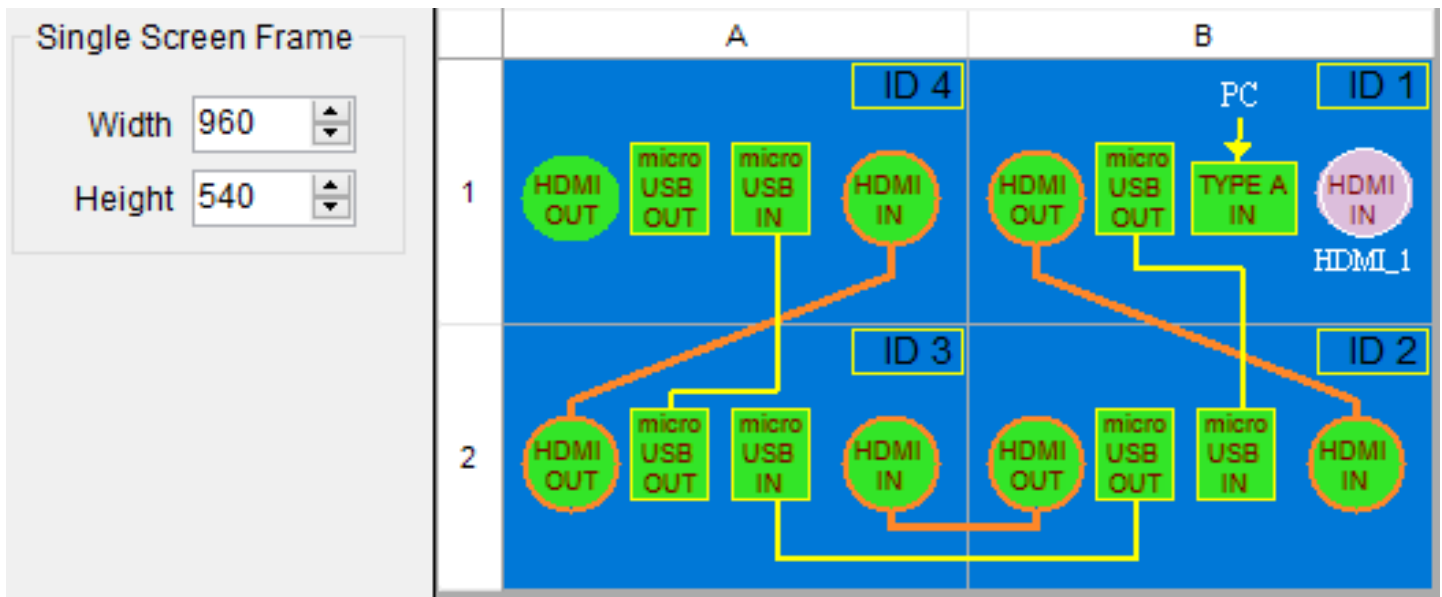

5.4 UI program supports stitching

a) One computer can connect up to four screens using HDMI daisy-chain mode. (The current software version only supports a maximum of four screens.)

b) If you need to connect more than four screens, you must use an additional multi-display video splicing player. The connection method can be referenced in the following diagram:

(Permission needs to be requested from the provider)

Splicing method	HDMI	Resolution
1x2	1	960*1080
1x3	1	960*1620
1x4	1	960*2160
2x1	1	1920*540
2x2	1	1920*1080
3x1	1	2880*540
4x1	1	3840*540

5.5 Installation Program & Operating Instructions

Double-click the program (AIO.exe) and complete the installation.



1. When the program is opened, the screen is as follows



2. Please select the language first (built-in English/Traditional Chinese/Simplified Chinese/Japanese).

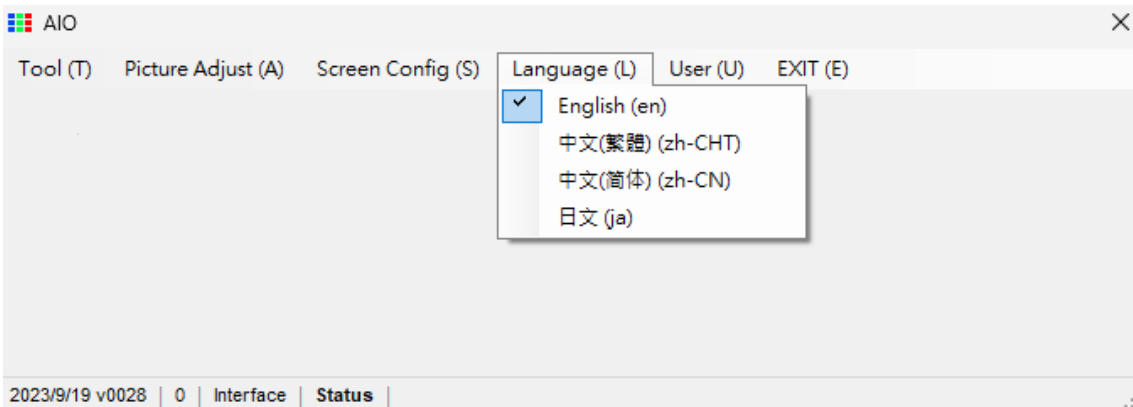

3. Select Screen Config(S)



4. Check the box according to the spliced screen type (Basic Setting 1x1).

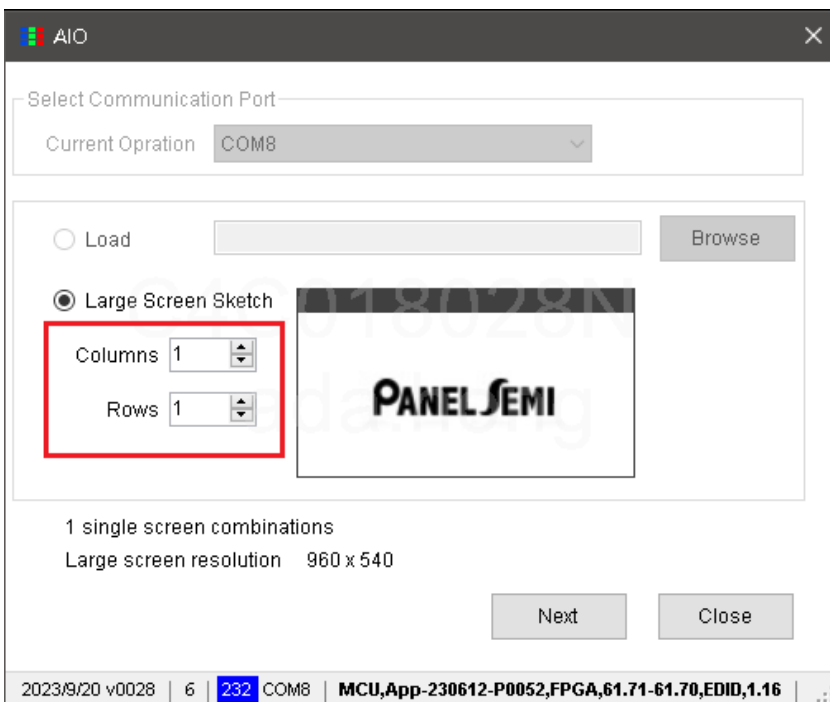

5. <Example Illustration>: Splicing Method 2x2

Step 1

Following the wiring method in 5.3, pay attention to confirming the connection of the USB Type-A between the screen and the computer. You can determine the success of the connection by checking the communication port. A successful connection will display in bold text, while a failed connection will appear in light gray text (as indicated by the red box in the image below).

After confirming the above, press "Next."

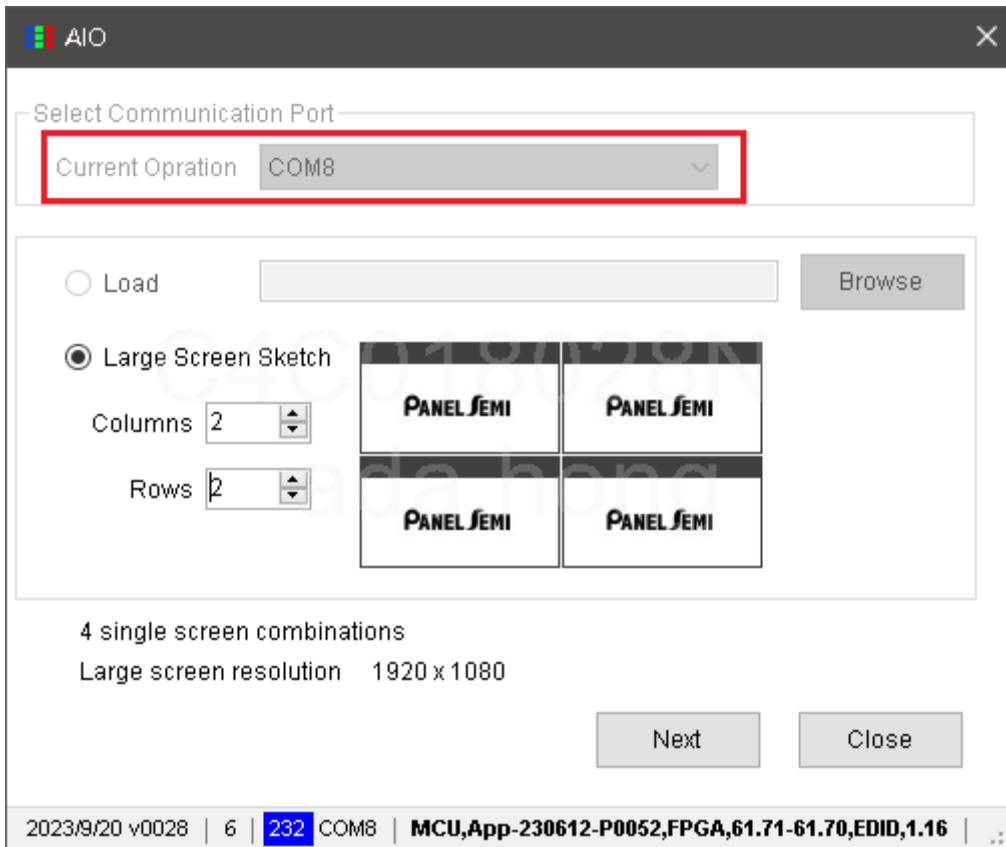

Step 2

The software will display a <Splicing Diagram on the Software Interface> based on the number of screens set by the user. This allows the user to double-check if the cables for each screen are correctly connected.

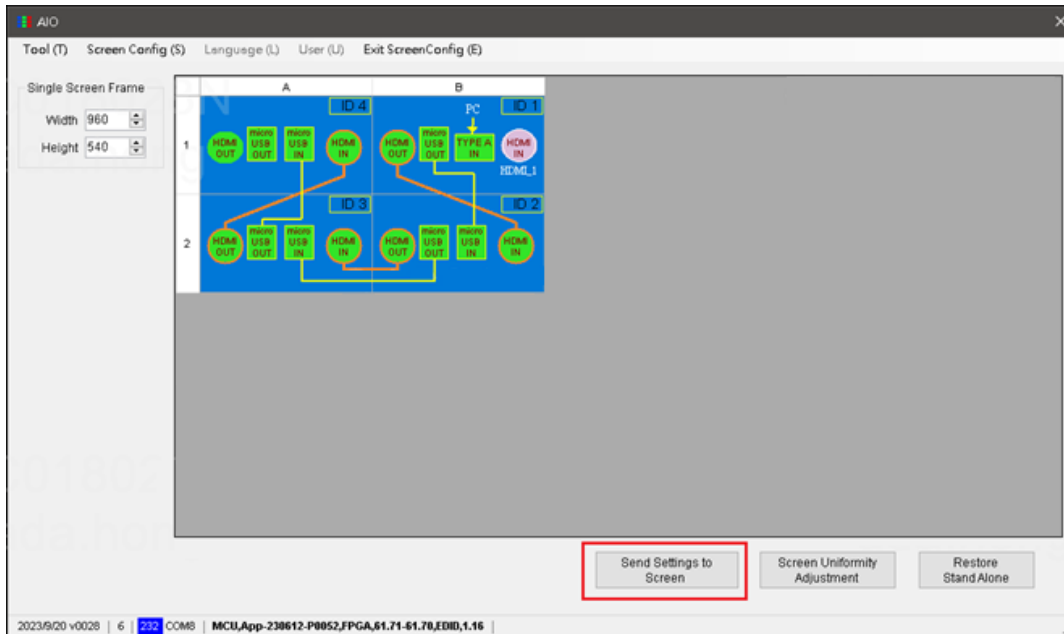

Note: The screen connected to the PC via Type-A and HDMI is referred to as the first screen, and a successful connection will display it as "ID01." Depending on the order of HDMI and Micro USB connections for the spliced screens, the encoding will display as "ID02/ID03/.../IDxN..."

Step 3

After confirming, press "Send Large Screen Settings." At this point, the screens will merge to create one large screen display.

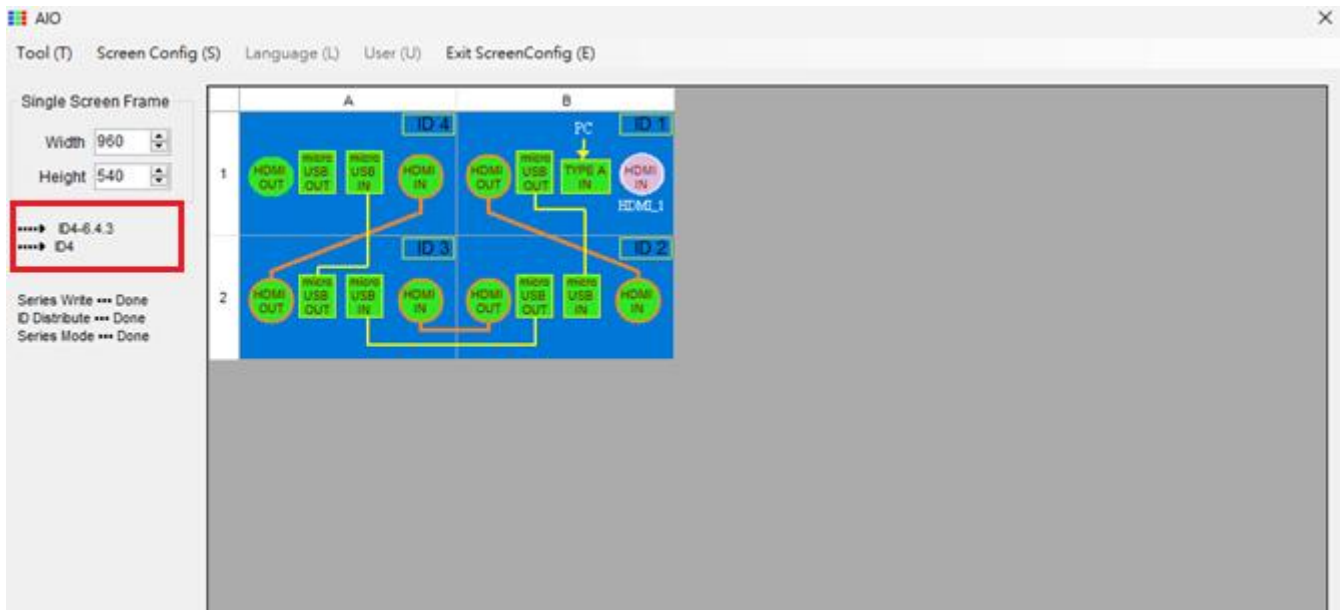

Step 4

If the splicing process fails, please double-check whether HDMI / Micro USB connections are correct, and then follow the above procedure again.

Once the spliced screen images have merged successfully, if there are no issues, you can directly press "Large Screen Uniformity Adjustment."



Step 5

Upon entering the Large Screen Uniformity Optical Adjustment interface, please press "OK" to begin the adjustment.

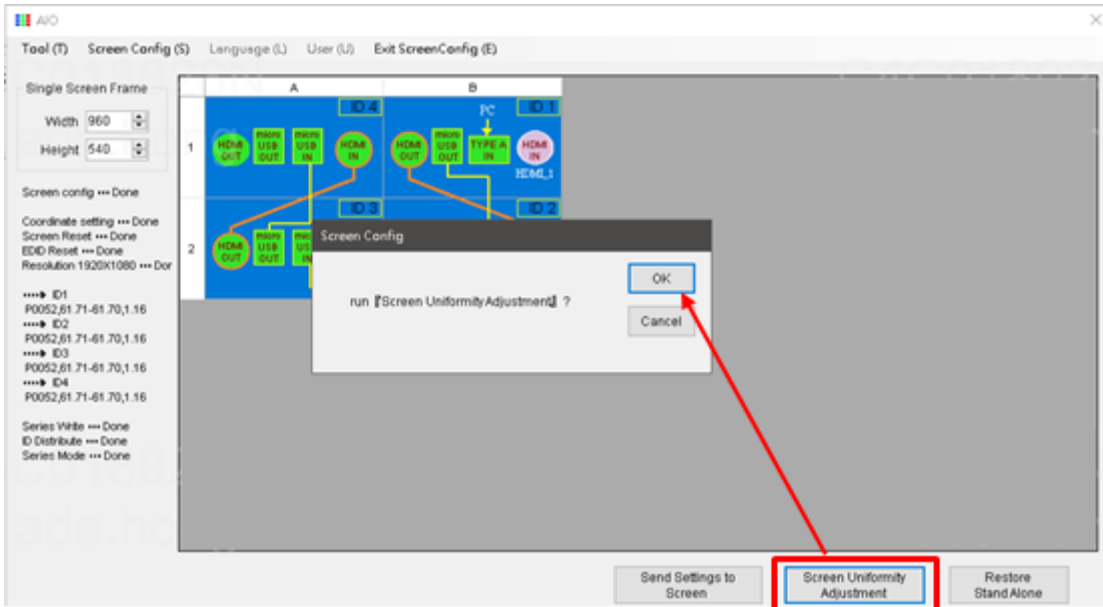

Front view of 2x2 splicing screen

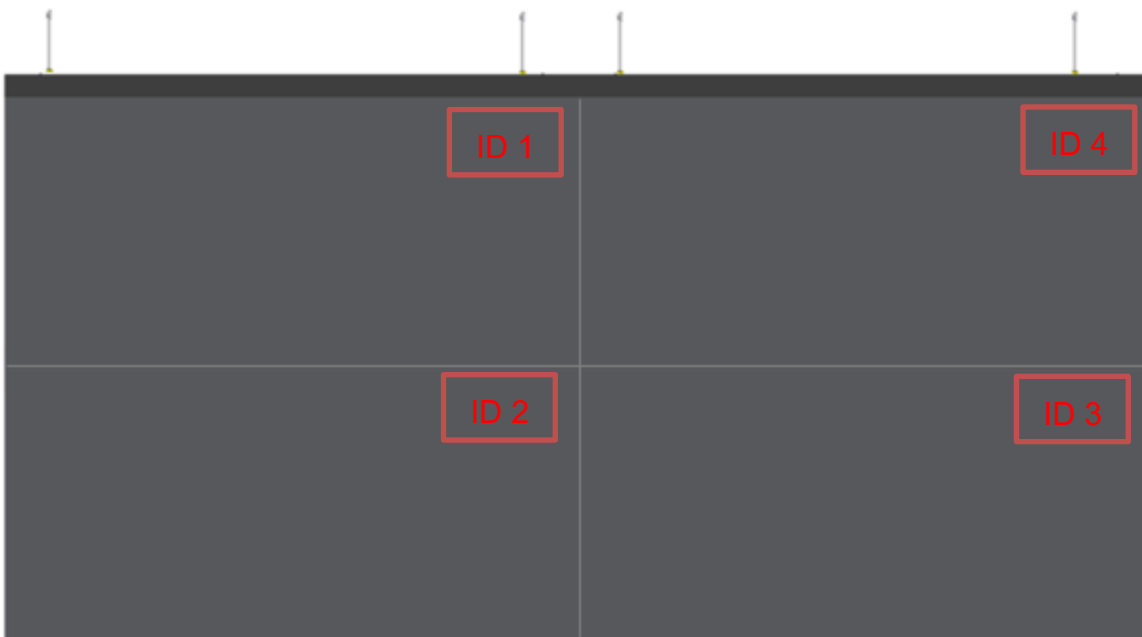

Note 1.

Currently, the software can only adjust one screen at a time. Therefore, you need to select one screen as the reference. It is recommended to use ID 1 as the reference screen.

Note 2.

Recommended order for optical adjustment of screens:

1. Use ID 1 as the reference.
2. Align ID 2 with ID 1.
3. Align ID 4 with ID 1.

4. Align ID 3 with either ID 4 or ID 2.

6. Large Screen Uniformity Operation Sequence Explanation:

Step 1

You must select the screen number you want to adjust. After confirming, press "Start." This will initiate color comparison and difference adjustment for the selected screen with the screen you want to align with.

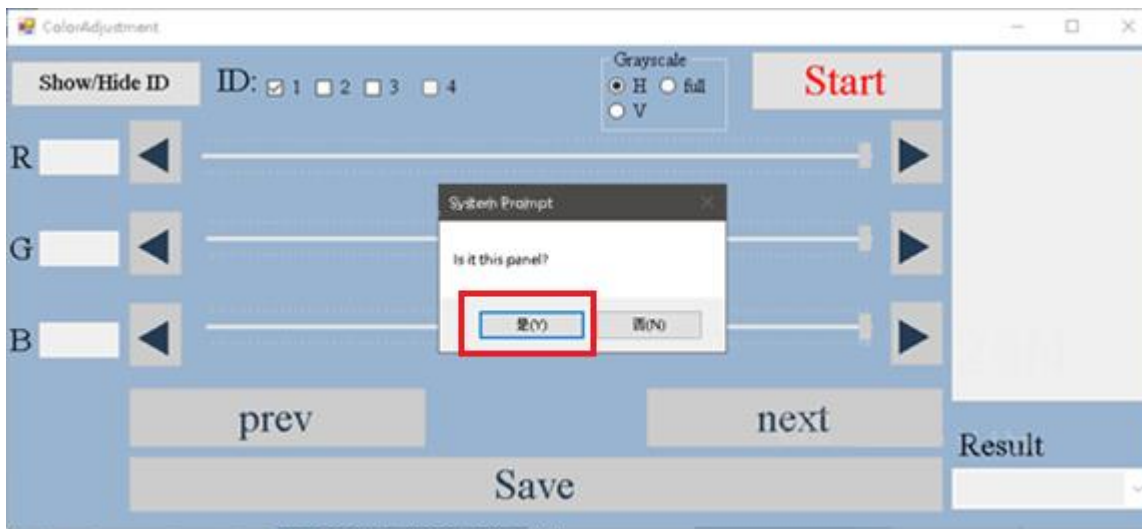
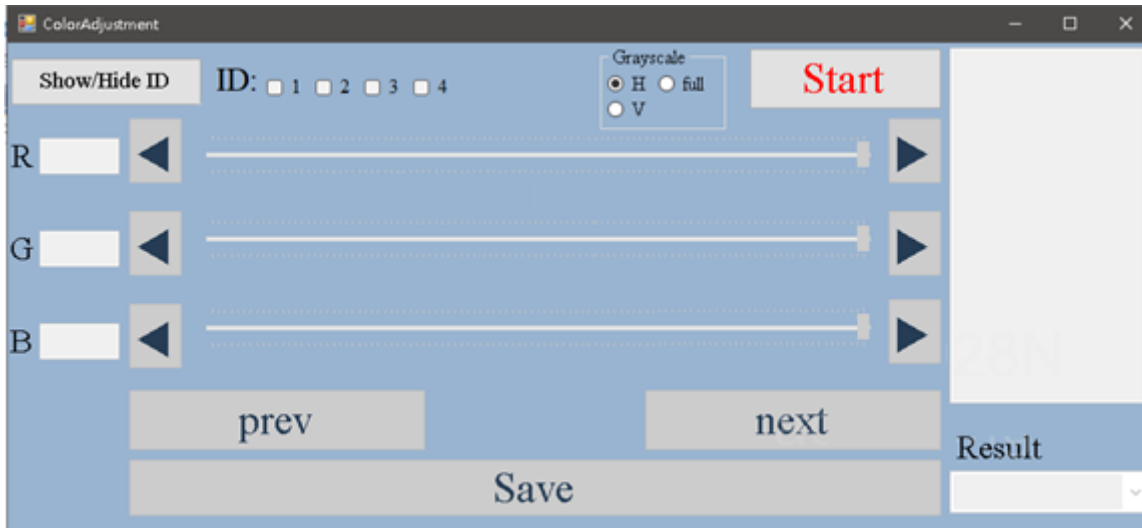

Step 2

In step 1020, adjust the Red, Green, Blue, and White levels. Once the adjustment is complete, press "Next."

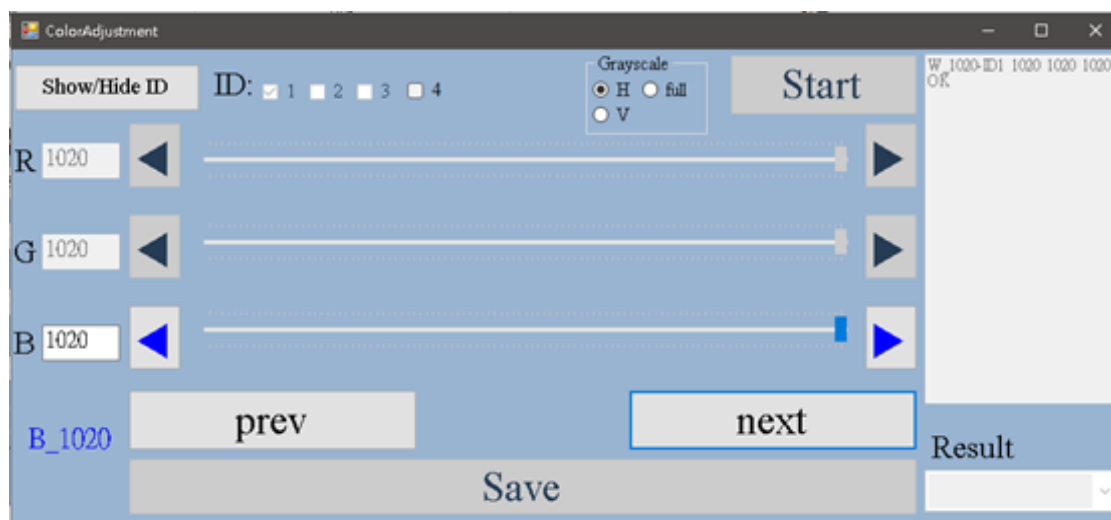
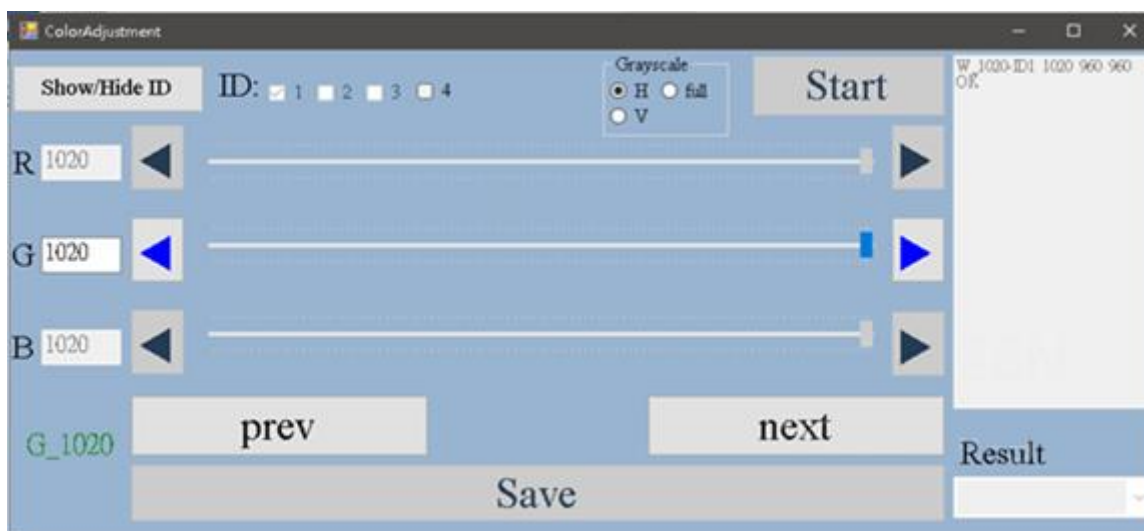
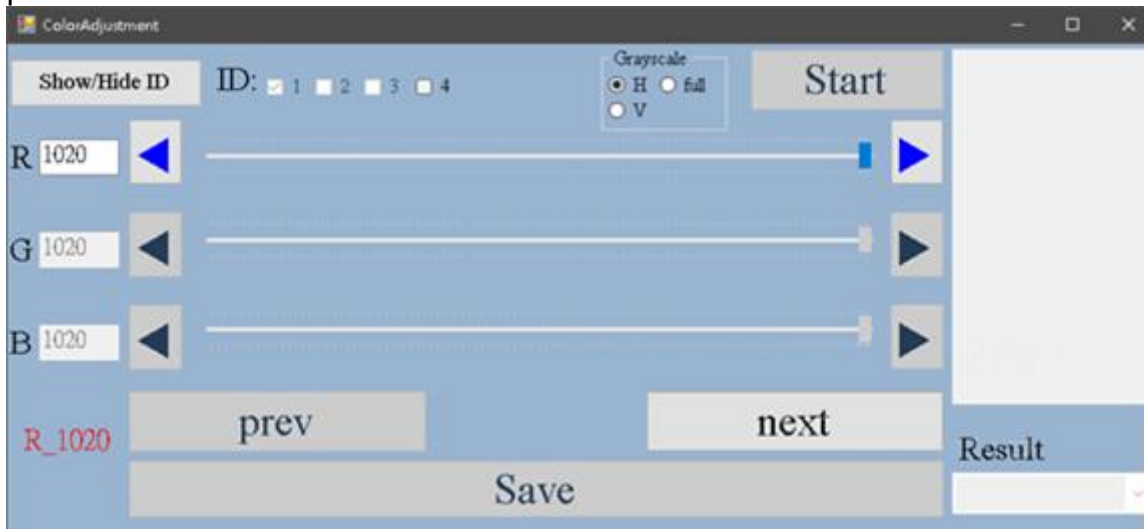

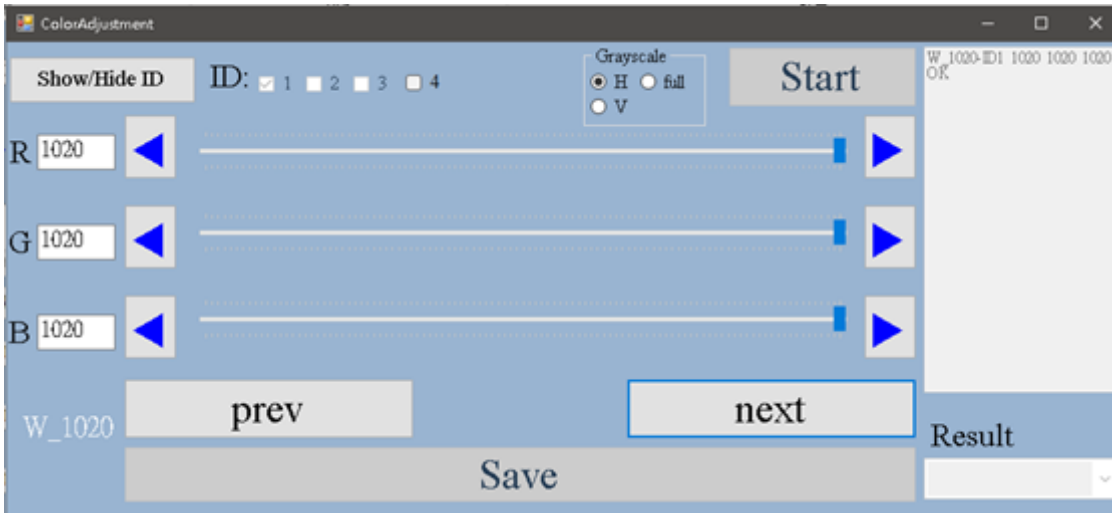

Step 3

In step 512, adjust the Red, Green, Blue, and White levels. Once the adjustment is complete, press "Next."

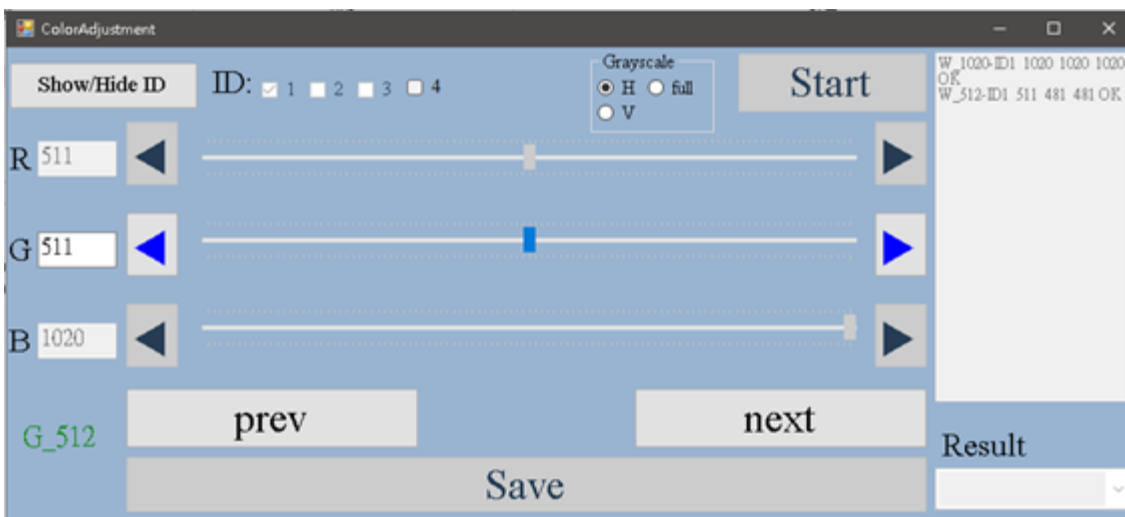
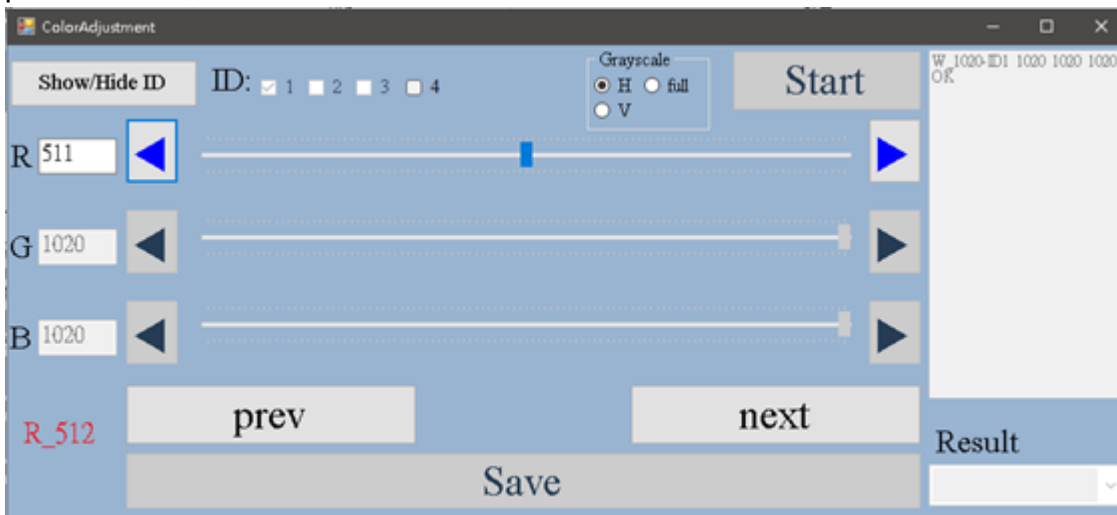

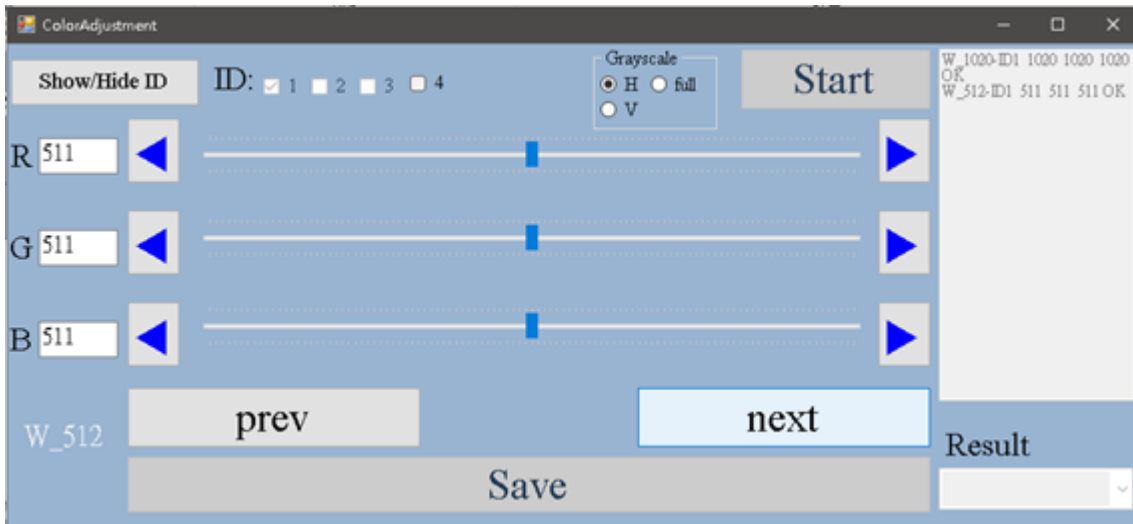
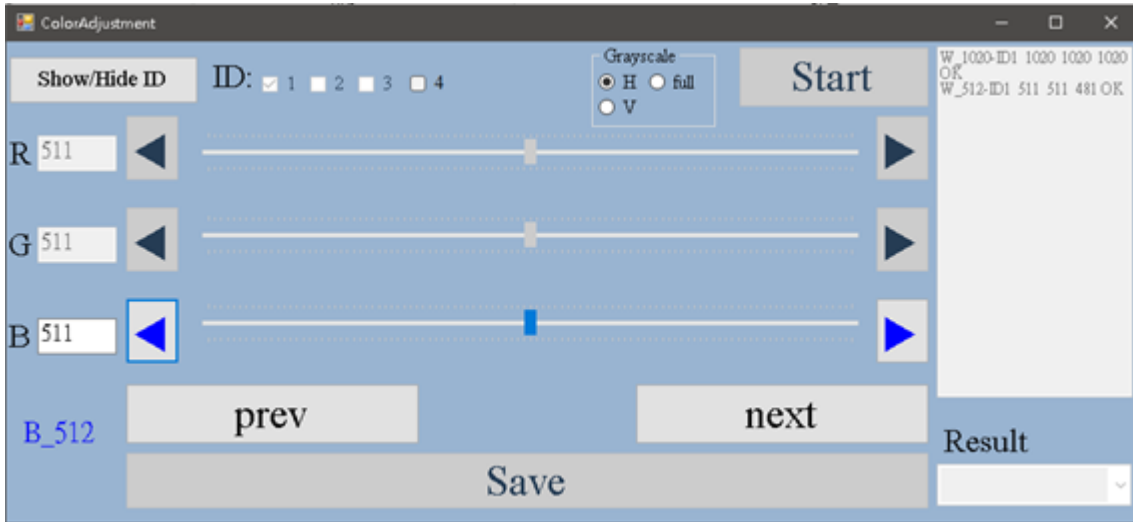

Step4

In step 256, adjust the Red, Green, Blue, and White levels. Once the adjustment is complete, press "Next."

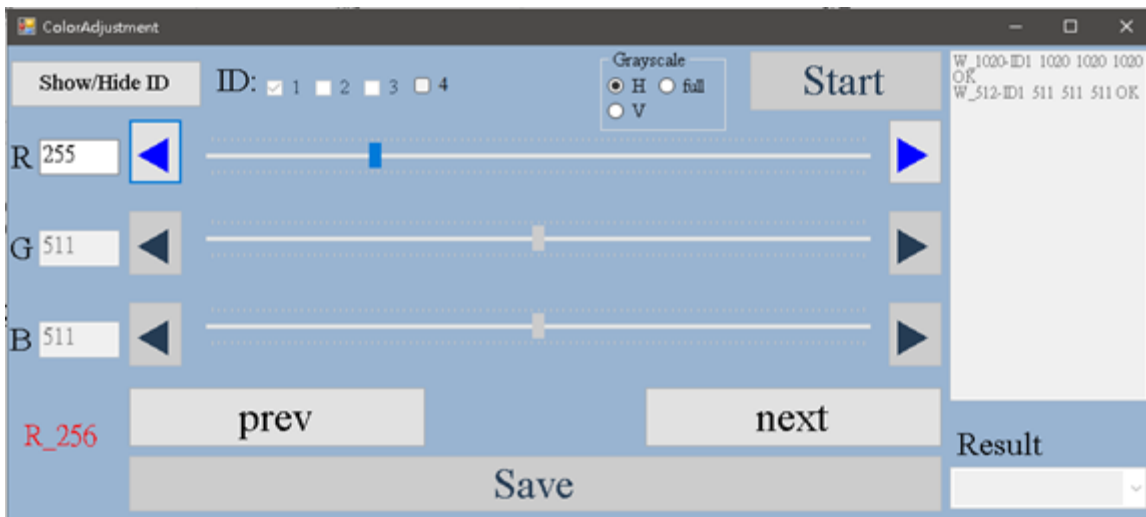

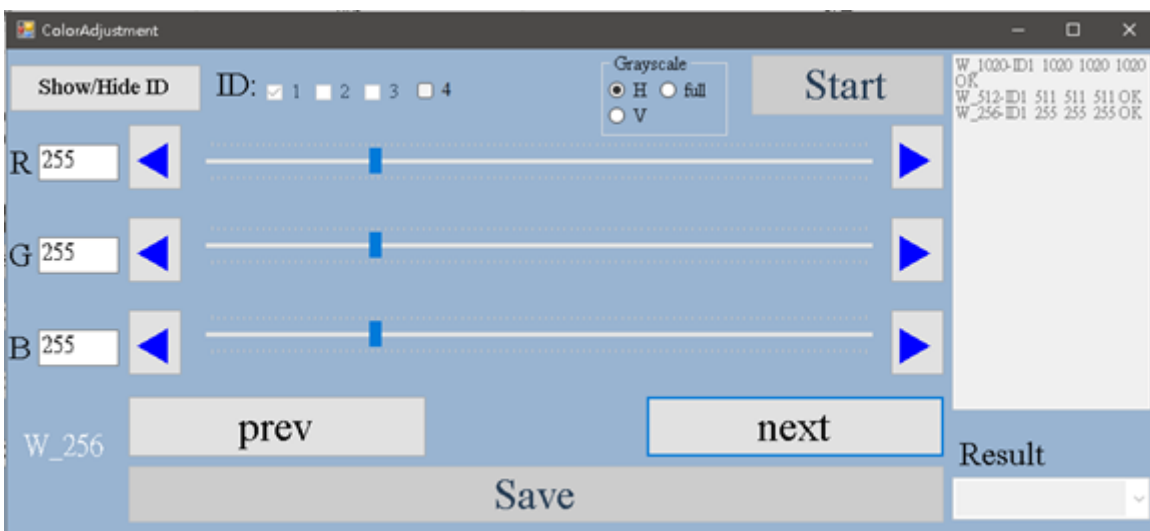
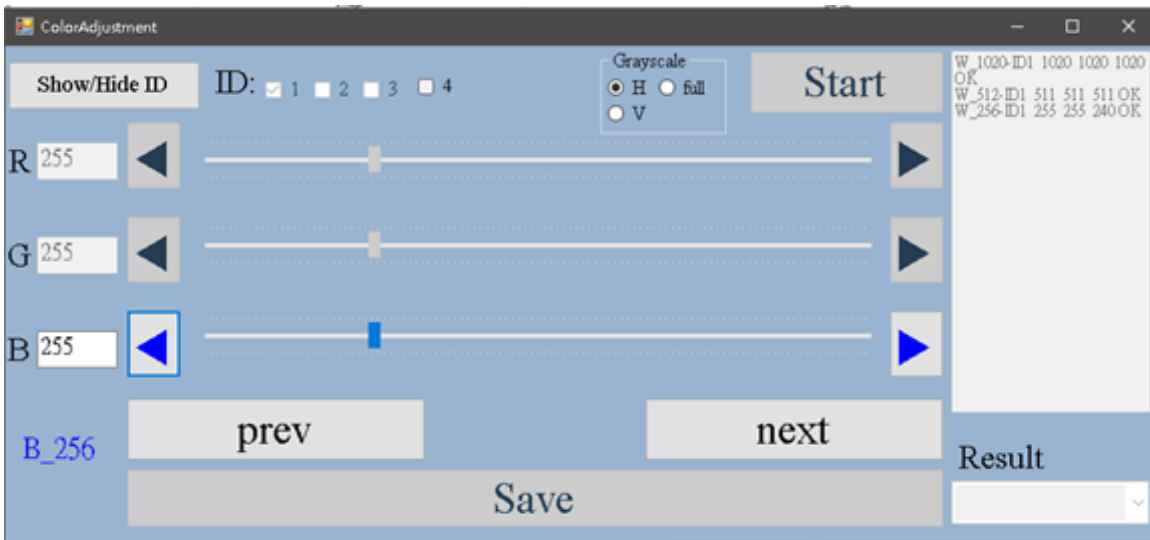
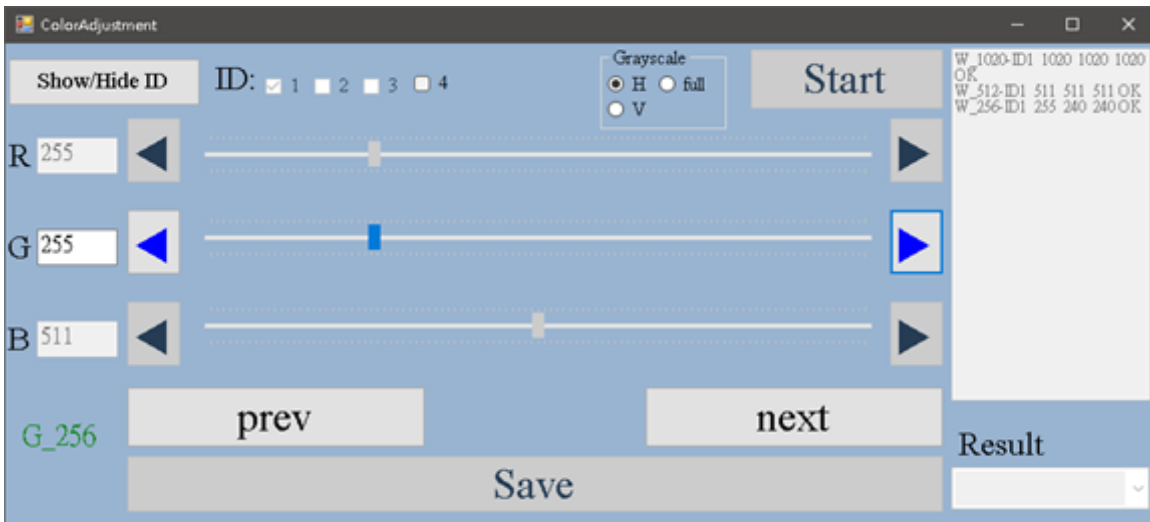

Step 5

In step 128, adjust the Red, Green, Blue, and White levels. Once the adjustment is complete, press "Next."

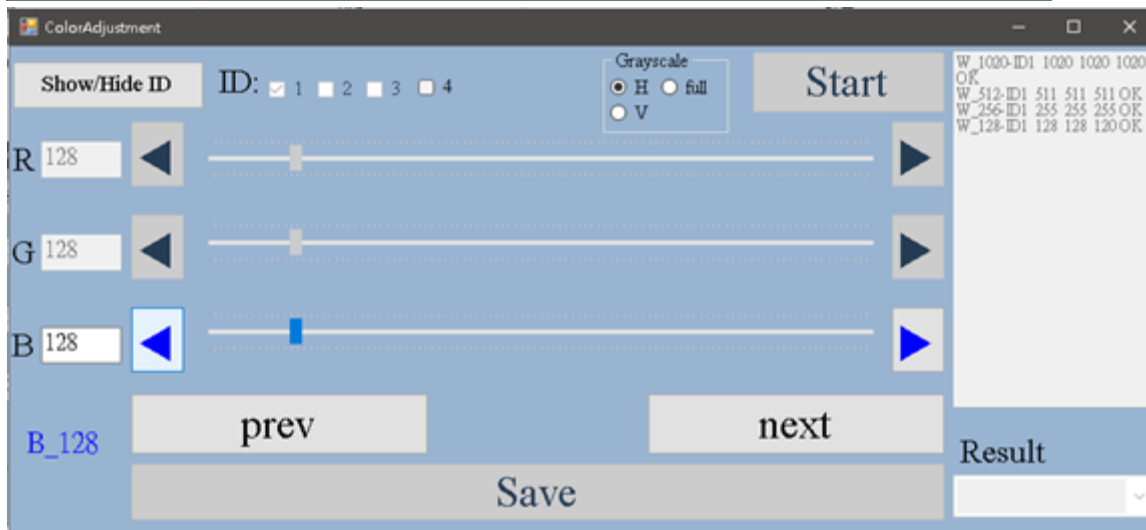
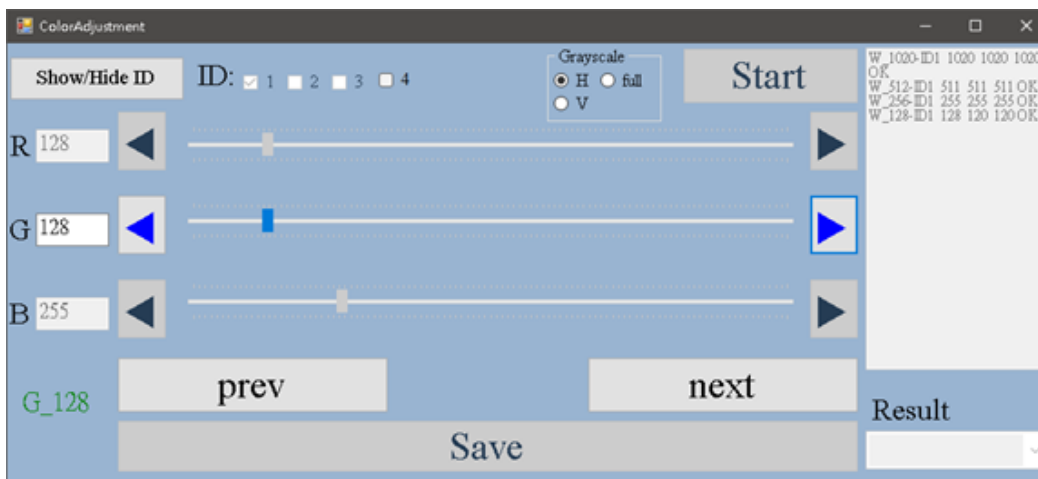
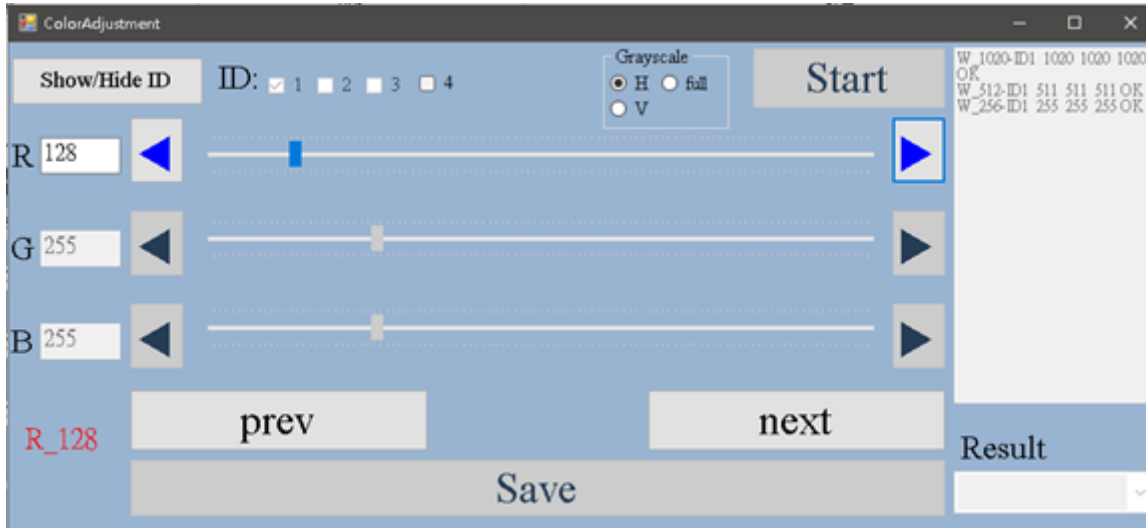

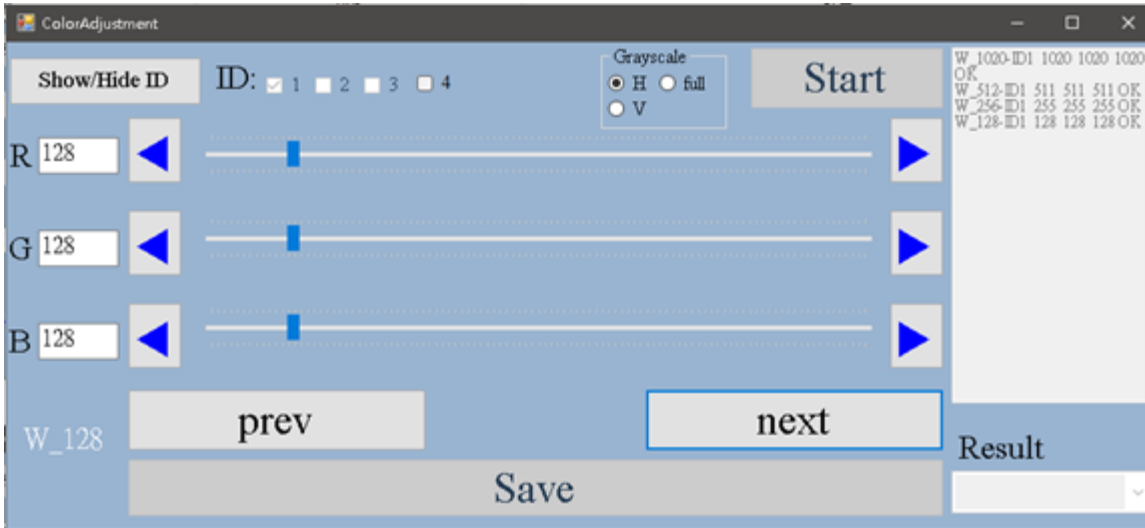

If during the adjustment process, you do not achieve the desired results, you can press "Previous" to return to the previous step's instructions.

Step 6

Save settings.

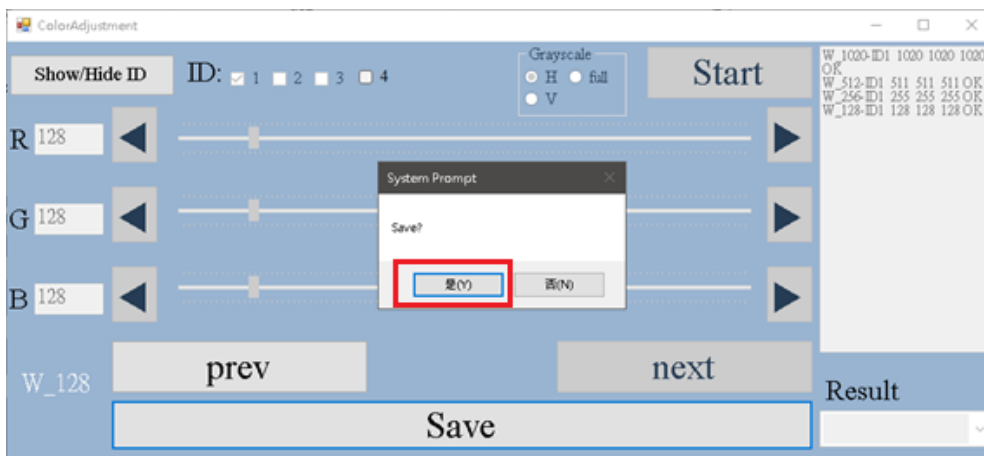

After the adjustment is completed, you can also confirm the actual results of the 1020/512/256/128 step with "level adjustments" in the results column.

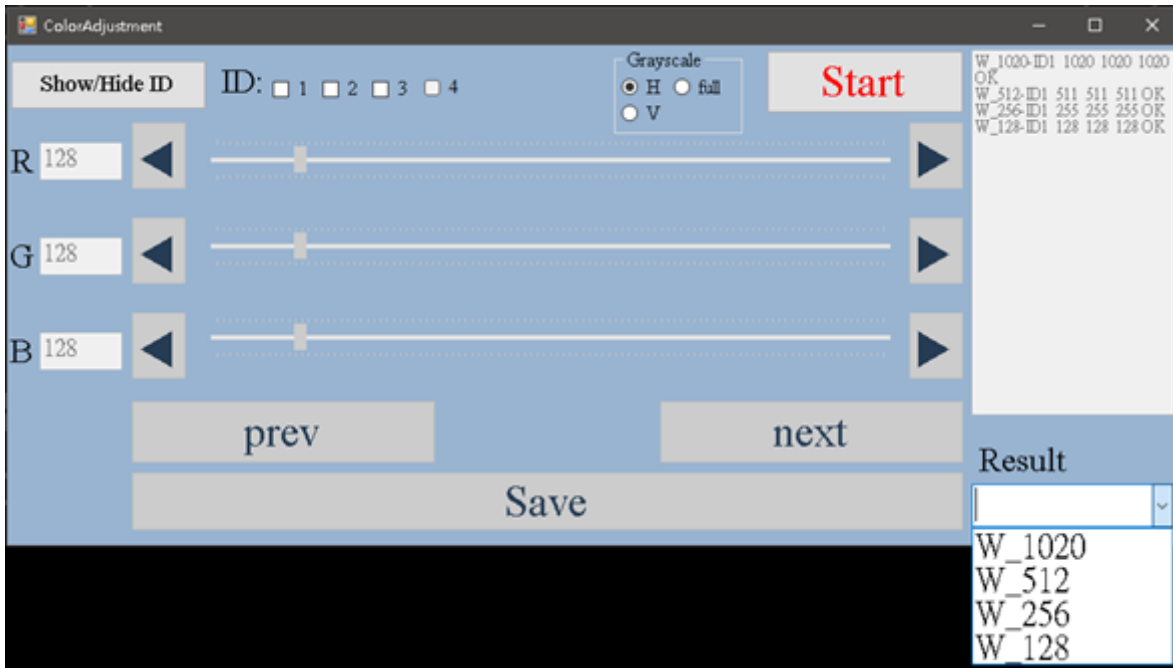

When the adjustment is completed and confirmed, there is no problem!!! You can press [SAVE]. (Uniformity adjustment is completed).

Close this interface directly and return to the AIO program homepage.

Start to adjust the overall brightness, color temperature, chromaticity, gamma, etc. of the splicing screen.

7. Image Adjustment Operation Sequence Explanation:

Step 1

Select "Image Adjustment."



Step 2

Brightness Adjustment: You can directly adjust the brightness by dragging the slider to achieve the desired brightness level.

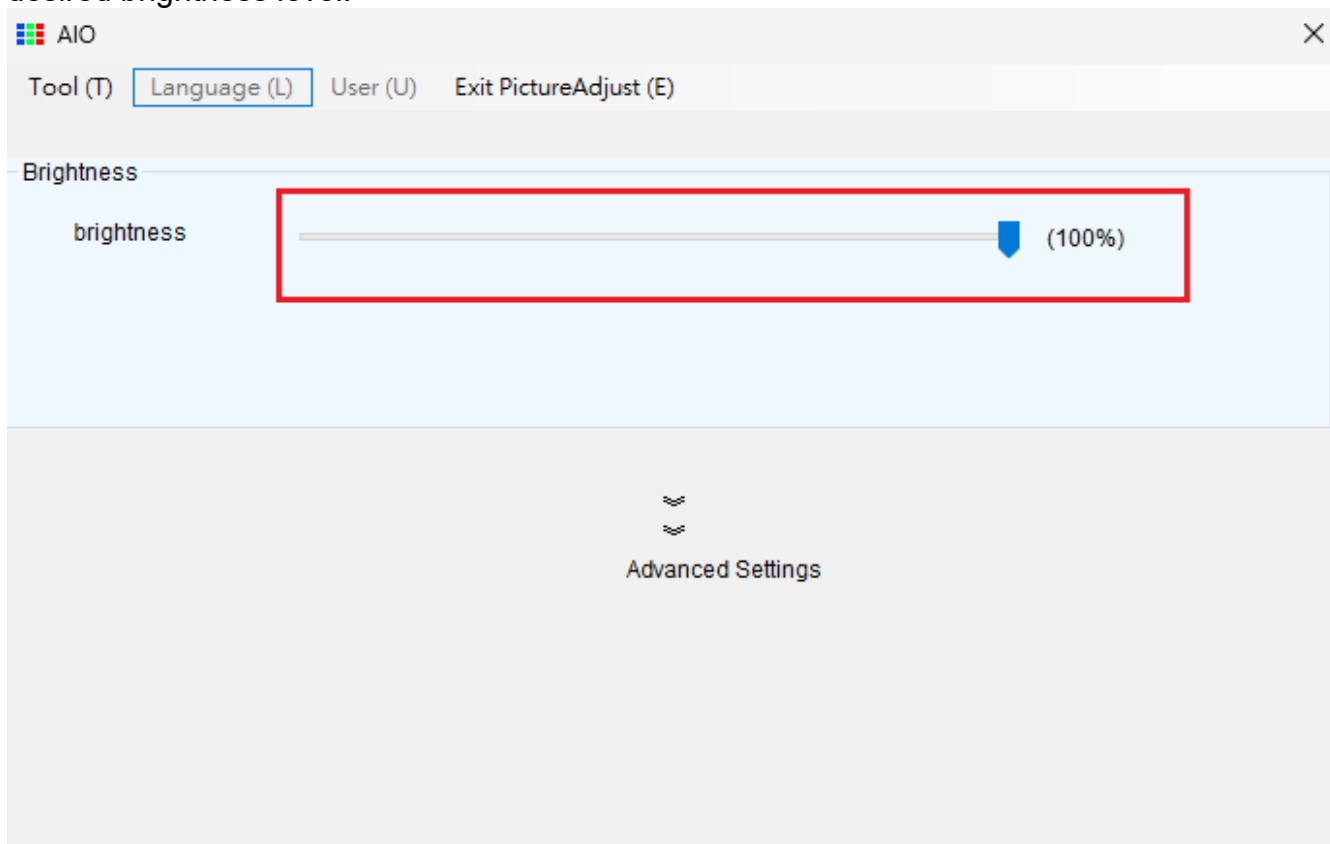

Step 3

After confirming the brightness, press "Advanced Settings" to access the Gamma Adjustment / Color Temperature Adjustment / Color Gamut Adjustment interface.

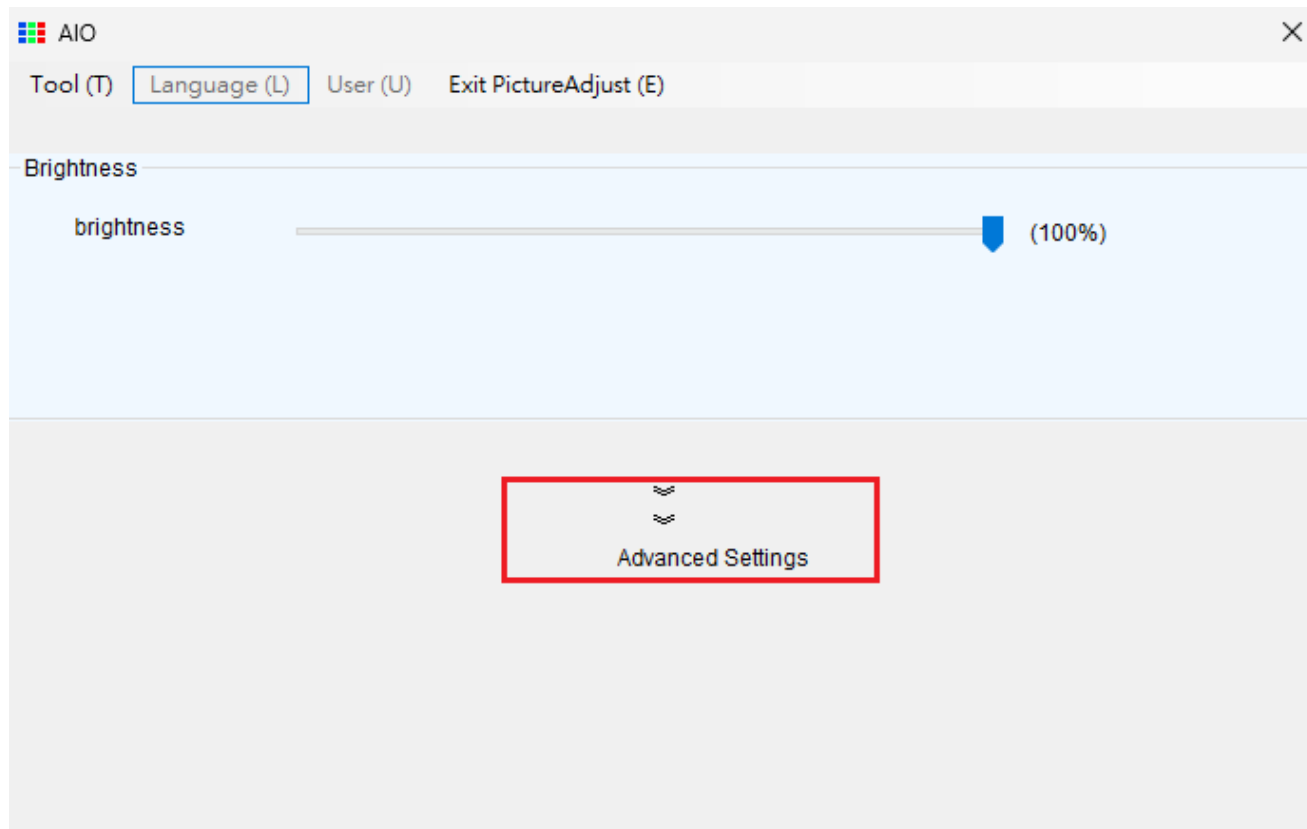

Step 4

<Gamma Adjustment> You can directly adjust the Gamma value by dragging the slider to achieve the desired Gamma level.

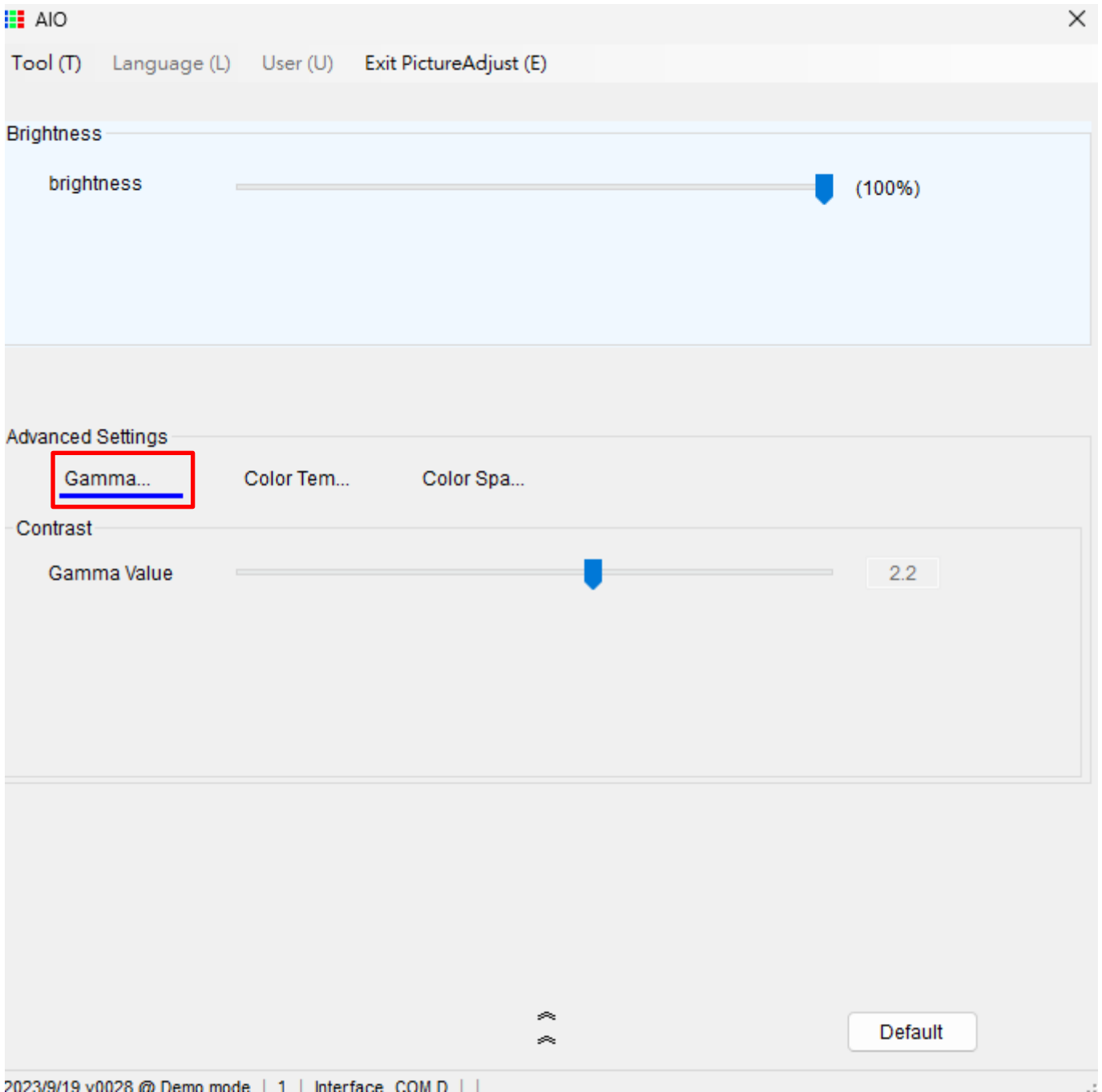

Step 5

<Color Temperature Adjustment> You can directly adjust the color temperature by dragging the slider to achieve the desired color temperature.

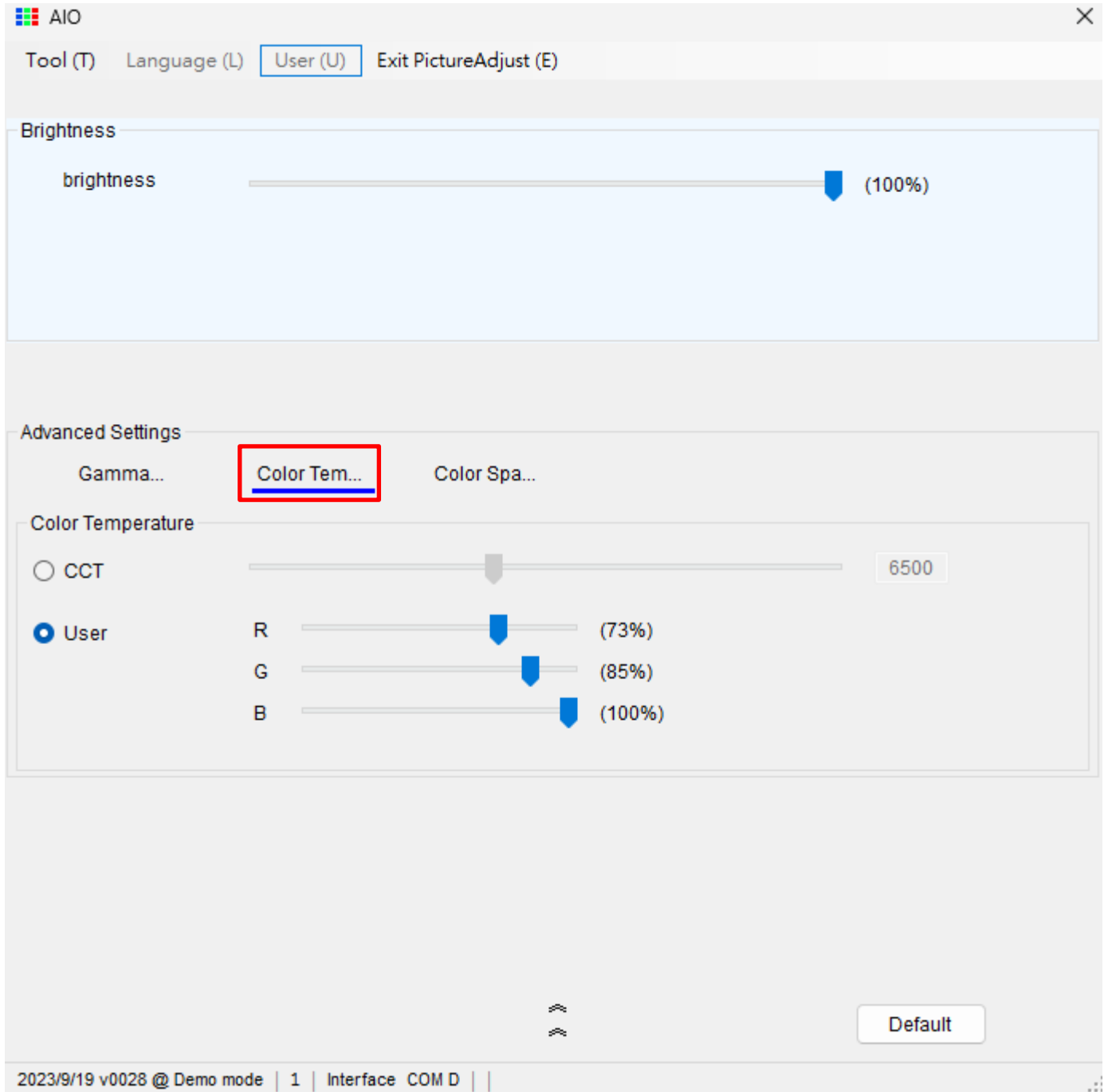

Step 6

You can adjust the color gamut to achieve the desired color range. Provide more specific instructions or information about the color gamut adjustment you'd like to perform.

Advanced Settings

Gamma... Color Tem... **Color Spa...**

Gamut

	(PID)	(PID)
R	0.6850 · 0.3146	0.6850 · 0.3146
G	0.1944 · 0.7481	0.1944 · 0.7481
B	0.1240 · 0.0723	0.1240 · 0.0723
W	0.2634 · 0.2925	0.2634 · 0.2925

PAL
NTSC
User
Default

Default

2023/9/19 v0028 @ Demo mode | 1 | Interface COM D |

After completing the optical adjustments, the adjusted optical characteristics will be displayed. At this point, you have completed all the optical settings, and you can safely close the AIO program.