

**SOKKIA**

# **iM-50 series**

**intelligence Measurement Station**

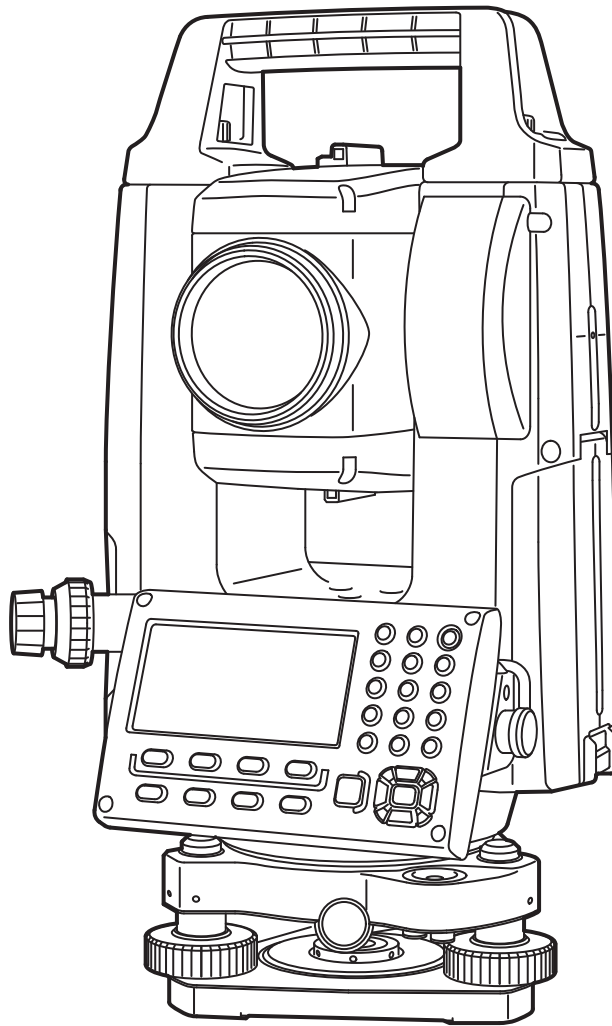

Class 3R Laser Product

**OPERATOR'S MANUAL**

1025821-02-A

# HOW TO READ THIS MANUAL

Thank you for selecting the iM-50 series.

- Please read this Operator's manual carefully, before using this product.
- iM has a function to output data to a connected host computer. Command operations from a host computer can also be performed. For details, refer to "Communication manual" and ask your local dealer.
- The specifications and general appearance of the instrument are subject to change without prior notice and without obligation by TOPCON CORPORATION and may differ from those appearing in this manual.
- The content of this manual is subject to change without notice.
- Some of the diagrams shown in this manual may be simplified for easier understanding.
- Always keep this manual in a convenient location and read it when necessary.
- This manual is protected by copyright and all rights are reserved by TOPCON CORPORATION.
- Except as permitted by Copyright law, this manual may not be copied, and no part of this manual may be reproduced in any form or by any means.
- This manual may not be modified, adapted or otherwise used for the production of derivative works.

## Symbols

---

The following conventions are used in this manual.



: Indicates precautions and important items which should be read before operations.



: Indicates the chapter title to refer to for additional information.



: Indicates supplementary explanation.



: Indicates an explanation for a particular term or operation.



[MEAS] etc. : Indicates Operation icons on the display and window dialog buttons.

{ESC} etc. : Indicates keys on the operation panel.

<Screen title> etc.: Indicates screen titles.

## Notes regarding manual style

---

- Except where stated, "iM" means iM-50 series in this manual.
  - Except where stated, instrument with display on both sides is used for illustration.
  - Screens appearing in this manual are based on the setting "Dist. reso: 1 mm". When "Dist. reso: 0.1 mm" is selected, the number of decimal places for distance and atmospheric condition input values will be increased by one.  
 "33. CHANGING THE SETTINGS"
  - Location of Operation icons in screens used in procedures is based on the factory setting. It is possible to change the allocation of Operation icons.  
 "33. CHANGING THE SETTINGS"
  - Learn basic operations in "4. PRODUCT OUTLINE" and "5. BASIC OPERATION" before you read each measurement procedure. For selecting options and inputting figures, see "5.1 Basic Key Operation".
  - Measurement procedures are based on continuous measurement. Some information about procedures when other measurement options are selected can be found in "Note" (.
- KODAK is a registered trademark of Eastman Kodak Company.
  - *Bluetooth*<sup>®</sup> is a registered trademark of Bluetooth SIG, Inc.
  - All other company and product names featured in this manual are trademarks or registered trademarks of each respective organization.



**JSIMA** This is the mark of the Japan Surveying Instruments Manufacturers Association.

# CONTENTS

1. PRECAUTIONS FOR SAFE OPERATION .....	1
2. PRECAUTIONS .....	4
3. LASER SAFETY INFORMATION .....	7
4. PRODUCT OUTLINE .....	9
4.1 Parts of the Instrument .....	9
4.2 Mode Structure .....	12
4.3 Bluetooth Wireless Technology .....	13
5. BASIC OPERATION .....	15
5.1 Basic Key Operation .....	15
5.2 Display Functions .....	18
5.3 Starkey Mode .....	20
6. USING THE BATTERY .....	21
6.1 Battery Charging .....	21
6.2 Installing/Removing the Battery .....	22
7. SETTING UP THE INSTRUMENT .....	23
7.1 Centering .....	23
7.2 Levelling .....	24
8. POWER ON/OFF .....	26
9. CONNECTING TO EXTERNAL DEVICES .....	28
9.1 Wireless Communication using Bluetooth Technology .....	28
9.2 Communication between the iM and Companion Device .....	30
9.3 Connection via RS232C Cable .....	31
10. TARGET SIGHTING AND MEASUREMENT .....	33
10.1 Manually Sighting the Target .....	33
11. ANGLE MEASUREMENT .....	34
11.1 Measuring the Horizontal Angle between Two Points (Horizontal Angle 0°) .....	34
11.2 Setting the Horizontal Angle to a Required Value (Horizontal Angle Hold) .....	35
11.3 Horizontal Angle Repetition .....	36
11.4 Angle Measurement and Outputting the Data .....	37
12. DISTANCE MEASUREMENT .....	38
12.1 Returned Signal Checking .....	38
12.2 Distance and Angle Measurement .....	39
12.3 Recalling the Measured Data .....	40
12.4 Distance Measurement and Outputting the Data .....	40
12.5 Coordinate Measurement and Outputting the Data .....	41
12.6 REM Measurement .....	42
13. SETTING INSTRUMENT STATION .....	44
13.1 Entering Instrument Station Data and Azimuth Angle .....	44
13.2 Setting Instrument Station Coordinate with resection measurement .....	49
14. COORDINATE MEASUREMENT .....	58
15. SETTING-OUT MEASUREMENT .....	60
15.1 Coordinates Setting-out Measurement .....	60
15.2 Distance Setting-out Measurement .....	62
15.3 REM Setting-out Measurement .....	64
16. SETTING-OUT LINE .....	65
16.1 Defining Baseline .....	65
16.2 Setting-out Line Point .....	68
16.3 Setting-out Line Line .....	70
17. SETTING-OUT ARC .....	72
17.1 Defining an Arc .....	72
17.2 Setting-out Arc .....	77

18. POINT PROJECTION .....	79
18.1 Defining Baseline .....	79
18.2 Point Projection .....	79
19. TOPOGRAPHY OBSERVATION .....	81
19.1 Observation Setting .....	82
19.2 Observation .....	83
20. OFFSET MEASUREMENT .....	86
20.1 Single-distance Offset Measurement .....	86
20.2 Angle Offset Measurement .....	87
20.3 Two-distance Offset Measurement .....	88
20.4 Plane Offset Measurement .....	90
20.5 Column Offset Measurement .....	92
21. MISSING LINE MEASUREMENT .....	94
21.1 Measuring the Distance between 2 or more Points .....	94
21.2 Changing the Starting Point .....	97
22. SURFACE AREA CALCULATION .....	99
23. INTERSECTIONS .....	102
23.1 Intersections (Type A) .....	102
23.2 Intersections (Type B) .....	110
24. TRAVERSE ADJUSTMENT .....	113
25. ROUTE SURVEYING .....	118
25.1 Instrument Station Settings .....	118
25.2 Straight Line Calculation .....	119
25.3 Circular Curve Calculation .....	121
25.4 Spiral Curve .....	122
25.5 Parabola .....	127
25.6 3 Point Calculation .....	130
25.7 Intersection Angle/Azimuth Angle Calculation .....	132
25.8 Route Calculation .....	134
26. CROSS SECTION SURVEY .....	145
27. Point to Line MEASUREMENT .....	149
28. RECORDING DATA - TOPO MENU - .....	152
28.1 Recording Instrument Station Data .....	152
28.2 Recording Backsight Point .....	154
28.3 Recording Angle Measurement Data .....	155
28.4 Recording Distance Measurement Data .....	156
28.5 Recording Coordinate Data .....	157
28.6 Recording Distance and Coordinate Data .....	158
28.7 Reviewing JOB Data .....	159
28.8 Recording Notes .....	159
28.9 Deleting Recorded JOB Data .....	161
29. SELECTING/DELETING A JOB .....	162
29.1 Selecting a JOB .....	162
29.2 Deleting a JOB .....	163
30. REGISTERING/DELETING DATA .....	165
30.1 Registering/Deleting Known Point Data .....	165
30.2 Registering/Deleting Codes .....	168
30.3 Reviewing Known Point Data .....	168
30.4 Reviewing Codes .....	170
31. OUTPUTTING JOB DATA .....	171
31.1 Outputting JOB Data to Host Computer .....	171
32. USING USB FLASH DRIVE .....	173



---



32.1	Inserting the USB flash drive .....	173
32.2	Selecting T type/S type .....	174
32.3	Storing JOB Data to USB flash drive .....	175
32.4	Loading Data in USB flash drive to the iM .....	177
32.5	Displaying and Editing Files .....	178
32.6	Formatting the Selected External Memory Media .....	179
33.	CHANGING THE SETTINGS .....	180
33.1	Observation Conditions - Angle/Tilt .....	180
33.2	Observation Conditions - Dist .....	181
33.3	Observation Conditions - Reflector (Target) .....	183
33.4	Observation Conditions - Atmosphere .....	184
33.5	Observation Conditions - Other .....	185
33.6	Instrument Conditions - Power .....	186
33.7	Instrument Conditions - Unit .....	187
33.8	Instrument Conditions - Instrument .....	187
33.9	Instrument Conditions - Password .....	188
33.10	Instrument Conditions - Date and Time .....	189
33.11	Allocating Key Functions .....	190
33.12	Restoring Default Settings .....	193
34.	WARNING AND ERROR MESSAGES .....	194
35.	CHECKS AND ADJUSTMENTS .....	198
35.1	Circular Level .....	198
35.2	Tilt Sensor .....	198
35.3	Reticle .....	201
35.4	Collimation .....	201
35.5	Optical Plummet .....	202
35.6	Additive Distance Constant .....	204
35.7	Laser Plummet .....	205
36.	POWER SUPPLY SYSTEM .....	207
37.	TARGET SYSTEM .....	208
38.	ACCESSORIES .....	210
39.	SPECIFICATIONS .....	212
40.	EXPLANATIONS .....	217
40.1	Manually Indexing the Vertical Circle by Face 1/2 Measurement .....	217
40.2	Correction for Refraction and Earth Curvature .....	218
41.	REGULATIONS .....	219



# 1. PRECAUTIONS FOR SAFE OPERATION

For the safe use of the product and prevention of injury to operators and other persons as well as prevention of property damage, items which should be observed are indicated by an exclamation point within a triangle used with WARNING and CAUTION statements in this operator's manual.













The definitions of the indications are listed below. Be sure you understand them before reading the manual's main text.

## Definition of Indication

	<b>WARNING</b>	Ignoring this indication and making an operation error could possibly result in death or serious injury to the operator.
	<b>CAUTION</b>	Ignoring this indication and making an operation error could possibly result in personal injury or property damage.

-  This symbol indicates items for which caution (hazard warnings inclusive) is urged. Specific details are printed in or near the symbol.
-  This symbol indicates items which are prohibited. Specific details are printed in or near the symbol.
-  This symbol indicates items which must always be performed. Specific details are printed in or near the symbol.

## General

-  **Warning**
  -  Do not use the unit in areas exposed to high amounts of dust or ash, in areas where there is inadequate ventilation, or near combustible materials. An explosion could occur.
  -  Do not perform disassembly or rebuilding. Fire, electric shock, burns, or hazardous radiation exposure could result.
  -  Never look at the sun through the telescope. Loss of eyesight could result.
  -  Do not look at reflected sunlight from a prism or other reflecting object through the telescope. Loss of eyesight could result.
  -  Direct viewing of the sun during sun observation will cause loss of eyesight. Use solar filter (option) for sun observation.
  -  When securing the instrument in the carrying case make sure to set all the locks. Failure to do so could result in the instrument falling out while being carried, causing injury.
-  **Caution**
  -  Do not use the carrying case as a footstool. The case is slippery and unstable so a person could slip and fall off it.
  -  Do not place the instrument in a damaged case or in a case with a damaged belt. The case or instrument could be dropped and cause injury.
  -  Do not wield or throw the plumb bob. A person could be injured if struck.
  -  Secure handle to main unit. Failure to properly secure the handle could result in the unit falling off while being carried, causing injury.
  -  Tighten the adjustment tribrach clamp securely. Failure to properly secure the clamp could result in the tribrach falling off while being carried, causing injury.

---

**Power Supply**

---

**Warning**

Do not disassemble or rebuild the battery or the battery charger, nor expose to heavy shocks or vibration. Sparking, fire, electric shock or burns could result.



Do not short circuit. Heat or ignition could result.



Do not place articles such as clothing on the battery charger while charging batteries. Sparks could be induced, leading to fire.



Do not use voltage other than the specified power supply voltage. Fire or electrical shock could result.



Do not use batteries other than those designated. An explosion could occur, or abnormal heat generated, leading to fire.



Do not use damaged power cords, plugs or loose outlets. Fire or electric shock could result.



Do not use power cords other than those designated. Fire could result.



Use only the specified battery charger to recharge batteries. Other chargers may be of different voltage rating or polarity, causing sparking which could lead to fire or burns.



Do not use the battery or charger for any other equipment or purpose. Fire or burns caused by ignition could result.



Do not heat or throw batteries or chargers into fire. An explosion could occur, resulting in injury.



To prevent shorting of the battery in storage, apply insulating tape or equivalent to the terminals. Otherwise shorting could occur resulting in fire or burns.



Do not use the battery or the battery charger if its terminals are wet. Resultant poor contact or shorting could lead to fire or burns.



Do not connect or disconnect power supply plugs with wet hands. Electric shock could result.

**Caution**

Do not touch liquid leaking from batteries. Harmful chemicals could cause burns or blisters.

---

**Tripod**

---

**Caution**

When mounting the instrument to the tripod, tighten the centering screw securely. Failure to tighten the screw properly could result in the instrument falling off the tripod, causing injury.



Tighten securely the leg fixing screws of the tripod on which the instrument is mounted. Failure to tighten the screws could result in the tripod collapsing, causing injury.



Do not carry the tripod with the tripod shoes pointed at other persons. A person could be injured if struck by the tripod shoes.



Keep hands and feet away from the tripod shoes when fixing the tripod in the ground. A hand or foot stab wound could result.



Tighten the leg fixing screws securely before carrying the tripod. Failure to tighten the screws could lead to the tripod legs extending, causing injury.

**Bluetooth wireless technology**

---



**Warning**



Do not use within the vicinity of hospitals. Malfunction of medical equipment could result.



Use the instrument at a distance of at least 22 cm from anyone with a cardiac pacemaker. Otherwise, the pacemaker may be adversely affected by the electromagnetic waves produced and cease to operate as normal.



Do not use onboard aircraft. The aircraft instrumentation may malfunction as a result.



Do not use within the vicinity of automatic doors, fire alarms and other devices with automatic controls as the electromagnetic waves produced may adversely affect operation resulting in an accident.

## 2. PRECAUTIONS

### Charging Battery

---

- Be sure to charge the battery within the charging temperature range.  
Charging temperature range : 0 to 40°C
- Use only the specified battery or the battery charger. Failures caused by using other batteries or battery chargers are out of warranty including the main unit.

### Warranty policy for Battery

---

- Battery is an expendable item. The decline in retained capacity depending on the repeated charging/discharging cycle is out of warranty.

### Bluetooth Wireless Technology

---

- *Bluetooth* function may not be built in depending on telecommunications regulations of the country or the area where the instrument is purchased. Contact your local dealer for the details.

### Telescope

---

- Aiming the telescope at the sun will cause internal damage to the instrument. Use the solar filter when observing the sun.  
☞ "38. ACCESSORIES"

### Tribrach Clamp and Handle

---

- When the instrument is shipped, the tribrach clamp is held firmly in place with a locking screw to prevent the instrument from shifting on the tribrach. Before using the instrument the first time, loosen this screw with a precision screwdriver. And before transporting it, tighten the locking screw to fasten the tribrach clamp in place so that it will not shift on the tribrach.
- The handle of the instrument can be removed. When operating the instrument with the handle attached, always make sure that the handle is securely fixed to the instrument body with the handle locks.

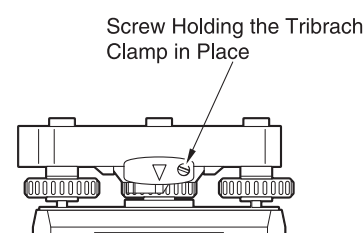

### Precautions concerning water and dust resistance

---

The instrument conforms to IP66 specifications for waterproofing and dust resistance when battery cover, connector cap and the external interface hatch are closed.

- Be sure to correctly attach the connector caps to protect the instrument from moisture and dust particles when the connector is not in use. The specification grade for water proofing and dust resistance is not guaranteed when using USB connector.
- Make sure that moisture or dust particles do not come in contact with the terminal or connectors. Operating the instrument with moisture or dust on the terminal or connectors may cause damage to the instrument.
- Make sure that the inside of the carrying case and the instrument are dry before closing the case. If moisture is trapped inside the case, it may cause the instrument to rust.
- If there is a crack or deformation in the rubber packing for the battery cover or external interface hatch, stop using and replace the packing.
- To retain the waterproof property, it is recommended that you replace the rubber packing once every two years. To replace the packing, contact your local dealer.

### The Lithium Battery

---

- The lithium battery is used to maintain the Calendar & Clock function. It can back up data for approximately 5 years of normal use and storage (Temperature = 20°, humidity = about 50%), but its lifetime may be shorter depending on circumstances.

### Vertical and horizontal clamps

---

- Always fully release the vertical/horizontal clamps when rotating the instrument or telescope. Rotating with clamp(s) partially applied may adversely affect accuracy.

### Tribrach

---

- Always use the tribrach provided. During a traverse observation, it is recommended to use the same type of tribrach for the target as well for accurate observations.

### Backing up data

---

- Data should be backed up (transferred to an external device etc.) on a regular basis to prevent data loss.

### Other precautions

---

- Close the external interface hatch and battery cover before starting measurement. Otherwise, ambient light entering the USB port may adversely affect measurement results.
- If the iM is moved from a warm place to an extremely cold place, internal parts may contract and make the keys difficult to operate. This is caused by cold air trapped inside the hermetically sealed casing. If the keys do not depress, open the battery cover to resume normal functionality. To prevent the keys from becoming stiff, remove the connector caps before moving the iM to a cold place.
- Never place the instrument directly on the ground. Sand or dust may cause damage to the screw holes or the centering screw on the base plate.
- Do not aim the telescope directly at the sun. Also, attach the lens cap to the telescope when not in use. Use the Solar filter to avoid causing internal damage to the instrument when observing the sun.  
☞ "38. ACCESSORIES"
- Do not perform vertical rotation of the telescope when using the lens hood, diagonal eyepiece, or solar filter. Such accessories may strike the instrument causing damage.
- Protect the instrument from heavy shocks or vibration.
- Never carry the instrument on the tripod to another site.
- Turn the power off before removing the battery.
- When placing the iM in its case, first remove its battery and place it in the case in accordance with the layout plan.
- Make sure that the instrument and the protective lining of the carrying case are dry before closing the case. The case is hermetically sealed and if moisture is trapped inside, the instrument could rust.
- Consult your local dealer before using the instrument under special conditions such as long periods of continuous use or high levels of humidity. In general, special conditions are treated as being outside the scope of the product warranty.

### Maintenance

---

- Wipe off moisture completely if the instrument gets wet during survey work.
- Always clean the instrument before returning it to the case. The lens requires special care. First, dust it off with the lens brush to remove tiny particles. Then, after providing a little condensation by breathing on the lens, wipe it with the silicon cloth.
- If the display is dirty, carefully wipe it with a soft, dry cloth. To clean other parts of the instrument or the carrying case, lightly moisten a soft cloth in a mild detergent solution. Wring out excess water until the cloth is slightly damp, then carefully wipe the surface of the unit. Do not use any alkaline cleaning solutions, alcohol, or any other organic solvents on the instrument or display.
- Store the instrument in a dry room where the temperature remains fairly constant.
- Check the tripod for loose fit and loose screws.
- If any trouble is found on the rotatable portion, screws or optical parts (e.g. lens), contact your local dealer.
- When the instrument is not used for a long time, check it at least once every 3 months.  
☞ "35. CHECKS AND ADJUSTMENTS"
- When removing the instrument from the carrying case, never pull it out by force. The empty carrying case should be closed to protect it from moisture.
- Check the instrument for proper adjustment periodically to maintain the instrument accuracy.

### **Exporting this product (Relating EAR)**

---

- This product is equipped with the parts/units, and contains software/technology, which are subject to the EAR (Export Administration Regulations). Depending on countries you wish to export or bring the product to, a US export license may be required. In such a case, it is your responsibility to obtain the license. The countries requiring the license as of May 2013 are shown below. Please consult the Export Administration Regulations as they are subject to change.

North Korea

Iran

Syria

Sudan

Cuba

URL for the EAR of the US: <http://www.bis.doc.gov/policiesandregulations/ear/index.htm>

### **Exporting this product (Relating telecommunications regulations)**

---

- Wireless communication module is incorporated in the instrument. Use of this technology must be compliant with telecommunications regulations of the country where the instrument is being used. Even exporting the wireless communication module may require conformity with the regulations. Contact your local dealer in advance.

### **Exceptions from responsibility**

---

- The manufacturer, or its representatives, assumes no responsibility for any damage, or loss of profits (change of data, loss of data, loss of profits, an interruption of business etc.) caused by use of the product or an unusable product.
- The manufacturer, or its representatives, assumes no responsibility for any damage, or loss of profits caused by usage different to that explained in this manual.
- The manufacturer, or its representatives, assumes no responsibility for consequential damage, or loss of profits due to heavy rain, strong wind, high-temperature and humidity, or storing or use of the product under unusual conditions.
- Product failures caused by rebuilding are out of warranty.
- Cautions and warnings included in this manual do not cover all the possible events.

# 3. LASER SAFETY INFORMATION

The instrument is classified as the following class of Laser Product according to IEC Standard Publication 60825-1 Ed.3.0: 2014 and United States Government Code of Federal Regulation FDA CDRH 21CFR Part 1040.10 and 1040.11 (Complies with FDA performance standards for laser products except for deviations pursuant to Laser Notice No.50, dated June 24, 2007.)

Device		Laser class
EDM device in objective lens	Light beam used for measurement (When target (reflector) is set to N-prism.)	Class 3R
	Light beam used for measurement (When target (reflector) is set to prism or reflective sheet.)	Class 1
	Laser-pointer	Class 3R
Laser plummet*1		Class2

\*1: Laser plummet is available as a factory option depending on the country or the area where the instrument is purchased.

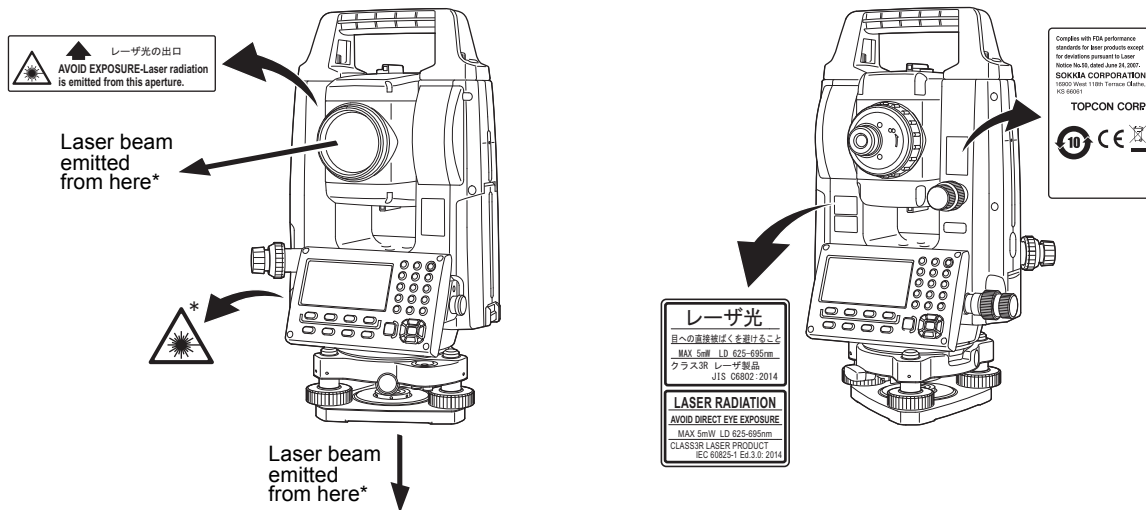

- EDM device is classified as Class 3R Laser Product when reflectorless measurement is selected. When target (reflector) is set to prism or reflective sheet, the output is equivalent to the safer class 1.

## Warning

- Use of controls or adjustments or performance of procedures other than those specified herein may result in hazardous radiation exposure.
- Follow the safety instructions on the labels attached to the instrument as well as in this manual to ensure safe use of this laser product.
- Never intentionally point the laser beam at another person. The laser beam is injurious to the eyes and skin. If an eye injury is caused by exposure to the laser beam, seek immediate medical attention from a licensed ophthalmologist.
- Do not look directly into the laser beam source. Doing so could cause permanent eye damage.
- Do not stare at the laser beam. Doing so could cause permanent eye damage.
- Never look at the laser beam through a telescope, binoculars or other optical instruments. Doing so could cause permanent eye damage.
- Sight targets so that the laser beam does not stray from them.



**⚠ Caution**

- Perform checks at start of work and periodic checks and adjustments with the laser beam emitted under normal conditions.
- When the instrument is not being used, turn OFF the power and replace the lens cap.
- When disposing of the instrument, destroy the battery connector so that the laser beam cannot be emitted.
- Operate the instrument with due caution to avoid injuries that may be caused by the laser beam unintentionally striking a person in the eye. Avoid setting the instrument at heights at which the path of the laser beam may strike pedestrians or drivers at head height.
- Never point the laser beam at mirrors, windows or surfaces that are highly reflective. The reflected laser beam could cause serious injury.
- Only those who have been received training as per the following items shall use this product.
  - Read this manual for usage procedures for this product.
  - Hazardous protection procedures (read this chapter).
  - Requisite protective gear (read this chapter).
  - Accident reporting procedures (stipulate procedures beforehand for transporting the injured and contacting physicians in case there are laser induced injuries).
- Persons working within the range of the laser beam are advised to wear eye protection which corresponds to the laser wavelength of the instrument being used. (OD2)
- Areas in which the laser is used should be posted with a standard laser warning sign.
- When using the laser-pointer function, be sure to turn OFF the output laser after distance measurement is completed. Even if distance measurement is canceled, the laser-pointer function is still operating and the laser beam continues to be emitted.

# 4. PRODUCT OUTLINE

## 4.1 Parts of the Instrument

### Parts and functions of the instrument

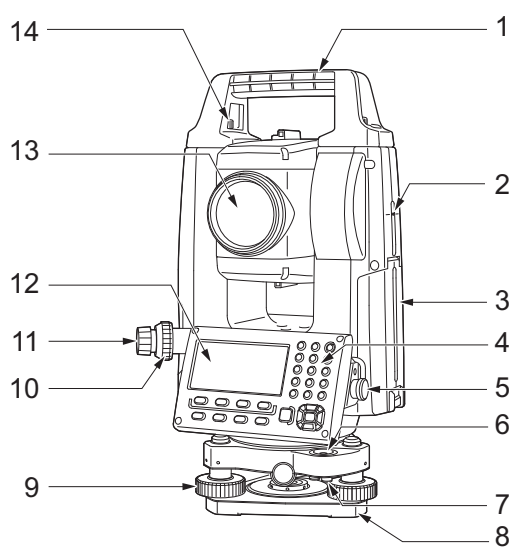

- 1 Handle
- 2 Instrument height mark
- 3 Battery cover
- 4 Operation panel
- 5 Serial connector
- 6 Circular level
- 7 Circular level adjusting screws
- 8 Base plate
- 9 Levelling foot screw
- 10 Optical plummet focussing ring
- 11 Optical plummet eyepiece  
(10,11: Not included in instruments with laser plummet)

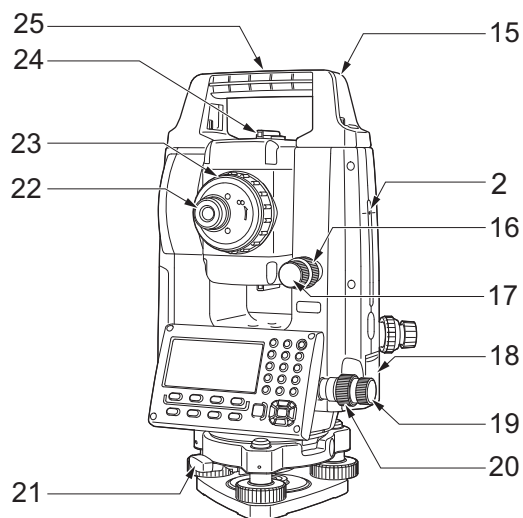

- 12 Display unit
- 13 Objective lens (Includes Laser-pointer function)
- 14 Handle locking screw
- 15 Tubular compass slot
- 16 Vertical clamp
- 17 Vertical fine motion screw
- 18 External interface hatch (USB port/Reset button)
- 19 Horizontal fine motion screw
- 20 Horizontal clamp
- 21 Tribrach clamp
- 22 Telescope eyepiece screw
- 23 Telescope focussing ring
- 24 Sighting collimator  
(Gun sight on iM-55 in Face 2 position)
- 25 Instrument center mark



### Instrument height mark

The height of the instrument is as follows:

- 192.5 mm (from tribrach mounting surface to this mark)
- 236 mm (from tribrach plate to this mark)

"Instrument height" is input when setting instrument station data and is the height from the surveying point (where the instrument is mounted) to this mark.



### Laser-pointer function

A target can be sighted with a red laser beam in dark locations without the use of the telescope.



### Sighting collimator

Use sighting collimator to aim the iM in the direction of the measurement point. Turn the instrument until the triangle in the sighting collimator is aligned with the target.

A gun sight is mounted on Face 2 position of the iM-55. Align the telescope to the direction of the target in such a way that the gun sight is positioned with the target as shown below. Note that you see the target at a distance from the gun sight.

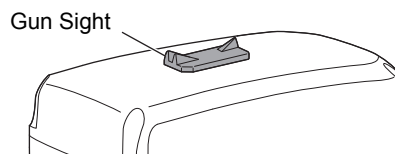

**Horizontal direction:** a position where you can see both the target and back sight at the center of the front sight's slit.

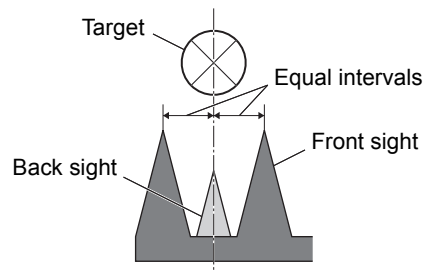

**Vertical direction:** a position where you can see the tops of the front sight and back sight at the same height of the target's center.

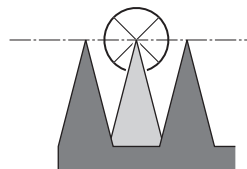

## Detaching/attaching the Handle

The carrying handle can be removed from the instrument when the prism is located at the zenith etc.

1. To remove it, loosen the handle rocking screws.
2. To attach the handle, position the handle as shown, tighten the 2 handle rocking screws securely.

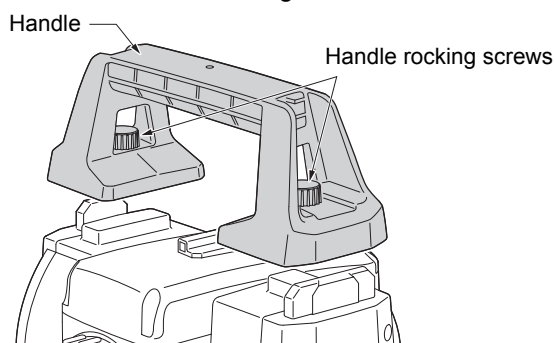

### Detaching the instrument from the tribrach

---

1. Turn the tribrach clamp counterclockwise to loosen.
2. Lift the instrument to detach.

### Attaching the instrument to the tribrach

---

1. Align (1) and (2) and lower the instrument onto the tribrach.
2. Turn the tribrach clamp clockwise to tighten.

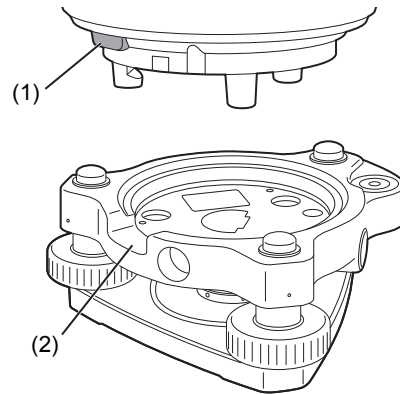

## 4.2 Mode Structure

The diagram below describes the different modes of the instrument and key operations for navigating between them.

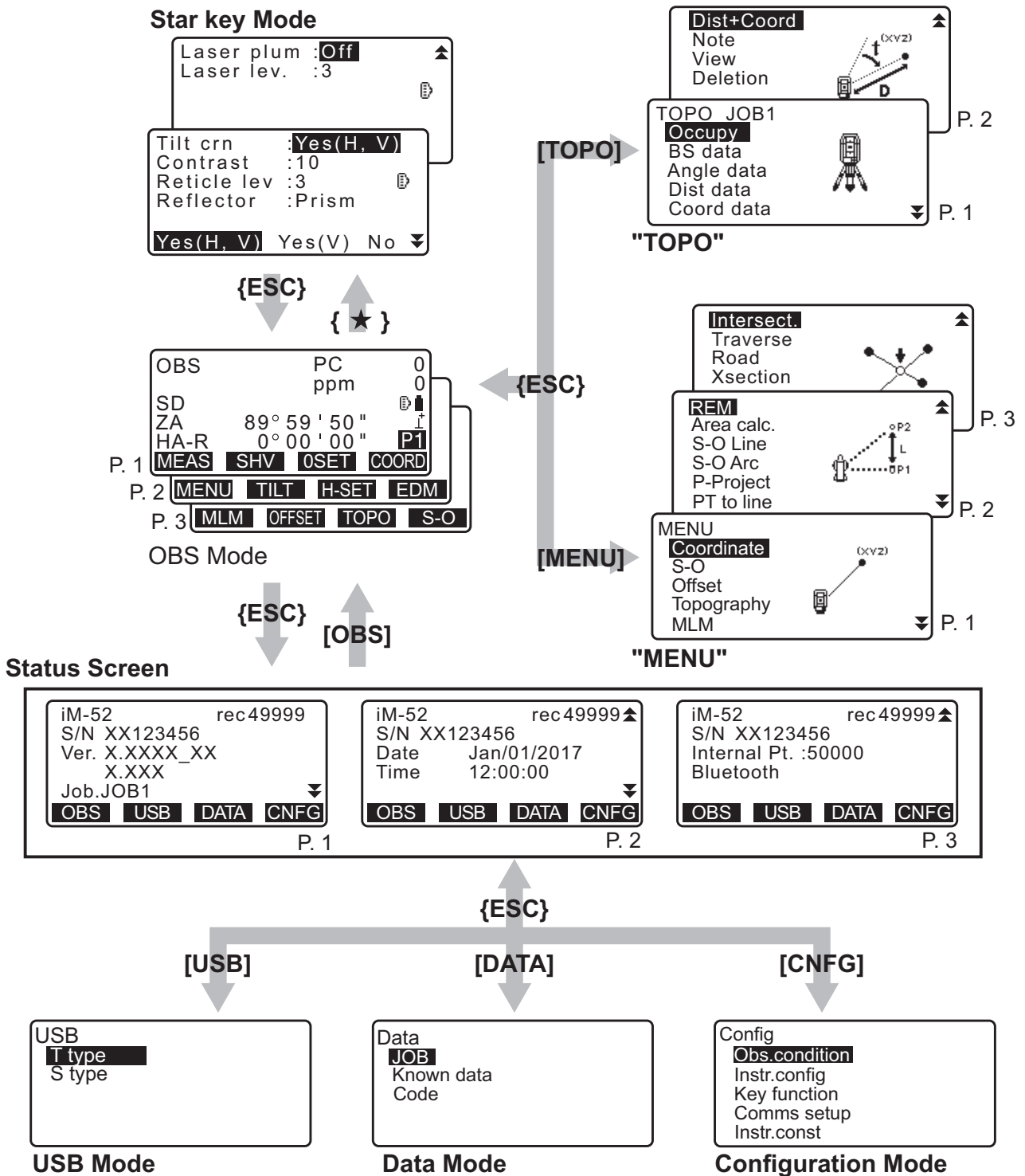

### 4.3 Bluetooth Wireless Technology



- *Bluetooth* LAN function may not be built in depending on telecommunications regulations of the country or the area where the instrument is purchased. Contact your local dealer for the details.
- Use of this technology must be authorized according to telecommunications regulations of the country where the instrument is being used. Contact your local dealer in advance.
-  "41. REGULATIONS"
- TOPCON CORPORATION is not liable for the content of any transmission nor any content related thereto. When communicating important data, run tests beforehand to ascertain that communication is operating normally.
- Do not divulge the content of any transmission to any third party.

#### Radio interference when using *Bluetooth* technology

*Bluetooth* communication with the iM uses the 2.4GHz frequency band. This is the same band used by the devices described below.

- Industrial, scientific, and medical (ISM) equipment such as microwaves and pacemakers.
- portable premises radio equipment (license required) used in factory production lines etc.
- portable specified low-power radio equipment (license-exempt)
- IEEE802.11b/IEEE802.11g/IEEE802.11n standard wireless LAN devices
- The above devices use the same frequency band as *Bluetooth* communications. As a result, using the iM within proximity to the above devices may result in interference causing communication failure or reduction of transmission speed.

Although a radio station license is not required for this instrument, bear in mind the following points when using *Bluetooth* technology for communication.

- **Regarding portable premises radio equipment and portable specified low-power radio equipment:**
  - Before starting transmission, check that operation will not take place within the vicinity of portable premises radio equipment or specified low-power radio equipment.
  - In the case that the instrument causes radio interference with portable premises radio equipment, terminate the connection immediately and take measures to prevent further interference (e.g. connect using an interface cable).
  - In the case that the instrument causes radio interference with portable specified low-power radio equipment, contact your local dealer.
- **When using *Bluetooth* function in proximity to IEEE802.11b/IEEE802.11g/IEEE802.11n standard wireless LAN devices, turn off all wireless LAN devices not being used.**
  - Interference may result, causing transmission speed to slow or even disrupting the connection completely. Turn off all devices not being used.
- **Do not use the iM in proximity to microwaves.**
  - Microwave ovens can cause significant interference resulting in communication failure. Perform communication at a distance of 3 m or more from microwave ovens.

**● Refrain from using the iM in proximity to televisions and radios.**

- Televisions and radios use a different frequency band to *Bluetooth* communications. However, even if the iM is used within proximity to the above equipment with no adverse effects with regard to *Bluetooth* communication, moving a *Bluetooth* compatible device (including the iM) closer to said equipment may result in electronic noise in sound or images, adversely affecting the performance of televisions and radios.

**Precautions regarding transmission**

---

**● For best results**

- The usable range becomes shorter when obstacles block the line of sight, or devices such as PDAs or computers are used. Wood, glass and plastic will not impede communication but the usable range becomes shorter. Moreover, wood, glass and plastic containing metal frames, plates, foil and other heat shielding elements as well as coatings containing metallic powders may adversely affect *Bluetooth* communication and concrete, reinforced concrete, and metal will render it impossible.
- Use a vinyl or plastic cover to protect the instrument from rain and moisture. Metallic materials should not be used.
- The direction of the *Bluetooth* antenna can have adverse effects upon usable range.

**● Reduced range due to atmospheric conditions**

- The radio waves used by the iM may be absorbed or scattered by rain, fog, and moisture from the human body with the limit of usable range becoming lower as a result. Similarly, usable range may also shorten when performing communication in wooded areas. Moreover, as wireless devices lose signal strength when close to the ground, perform communication at as high a position as possible.



- TOPCON CORPORATION cannot guarantee full compatibility with all *Bluetooth* products on the market.

# 5. BASIC OPERATION

Learn basic key operations here before you read each measurement procedure.

## 5.1 Basic Key Operation

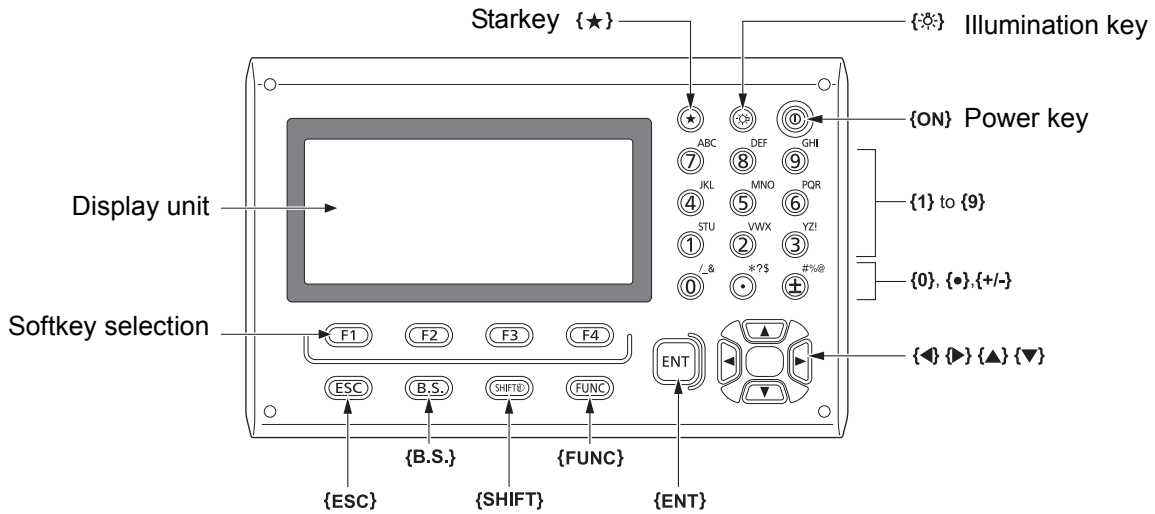

- **Power ON/OFF**

☞ "8. POWER ON/OFF"

- **Lighting up the reticle/keys**

{☀}	Switches the reticle illumination and key light On/Off
-----	--

- **Switching to Starkey mode**

{★}	Switches to Starkey mode/previous screen
-----	--

☞ "5.3 Starkey Mode"

- **Switching target type**

Target type can be switched only on the screen where the target symbol (ex. 🎯) is displayed.

{SHIFT} 🎯	Switches between target types (Prism/Sheet/N-Prism (reflectorless))
-----------	---

☞ Target symbol displayed: "5.2 Display Functions", Switching between target types in the Starkey mode: "5.3 Starkey Mode", Switching the target type in Config mode: "33.2 Observation Conditions - Dist"

- **Switching the Laser-pointer light ON/OFF**

{☀} (Press and hold until a beep sounds)	Turns ON/OFF the laser-pointer
--	--------------------------------

☞ "Switching {☀} function: "33.7 Instrument Conditions - Instrument"

**Note**

- After turning ON the laser-pointer, the laser beam is emitted for 5 minutes, and then automatically switches OFF. But in the Status screen and when target symbol (ex. 🎯) is not displayed in the OBS mode, the laser beam is not automatically turned off.



### ● Softkey operation

Softkeys are displayed on the bottom line of the screen.

{F1} to {F4}	Select the function matching the softkeys
{FUNC}	Toggle between OBS mode screen pages (when more than 4 softkeys are allocated)

### ● Inputting letters/figures

{SHIFT} ⊗	Switch between numeric and alphabetic characters.
{0} to {9}	During numeric input, input number of the key. During alphabetic input, input the characters displayed above the key in the order they are listed.
{.}/{±}	Input a decimal point/plus or minus sign during numeric input. During alphabetic input, input the characters displayed above the key in the order they are listed.
{◀/▶}	Move the cursor left/right
{B.S.}	Deletes a character on the left.
{ESC}	Cancels the input data
{ENT}	Selects/accepts input word/value

Example: Entering "JOB M" in the JOB name field

1. Press **{SHIFT}** to enter the alphabet input mode  
Alphabet input mode is indicated by an "A" on the right of the screen.
2. Press **{4}**.  
"J" is displayed.
3. Press **{5}** three times.  
"O" is displayed.
4. Press **{7}** twice.  
"B" is displayed.
5. Press **▶** twice.  
Input a blank space.
6. Press **{5}** once.  
"M" is displayed. Press **{ENT}** to complete inputting.

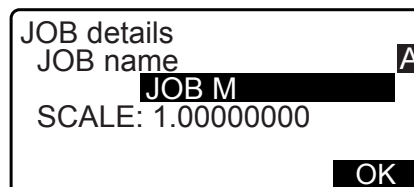

### ● Selecting options

{▲}/{▼}	Move the cursor up/down
{◀}/{▶}	Move the cursor/selection item left/right or select other option
{ENT}	Accepts the option

Example: Select a reflector type

1. Press **[EDM]** in page 2 of OBS mode.
2. Move to "Reflector" using {▲}/{▼}.
3. Display the option you want to select using {▶}/{◀}.  
Switches between "Prism", "Sheet" and "N-prism."

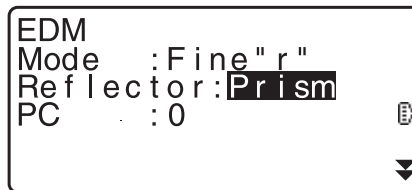

4. Press {ENT} or {▼} to move to the next option.  
The selection is set and you can set the next item.

### ● Switching modes

[ ★ ]	From OBS mode (Observation Mode) to Starkey Mode
[CNFG]	From Status mode to Config Mode (Configuration Mode)
[OBS]	From Status mode to OBS mode (Observation Mode)
[USB]	From Status mode to USB Mode
[DATA]	From Status mode to Data Mode
{ESC}	Return to the Status mode from each Mode

☞ "4.2 Mode Structure"

### ● Others

{ESC}	Returns to previous screen
-------	----------------------------

## 5.2 Display Functions

### Status screen

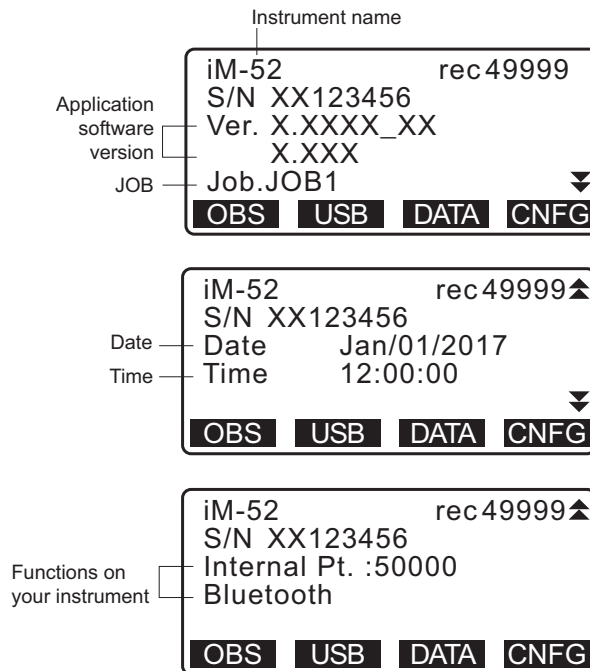

### OBS mode screen

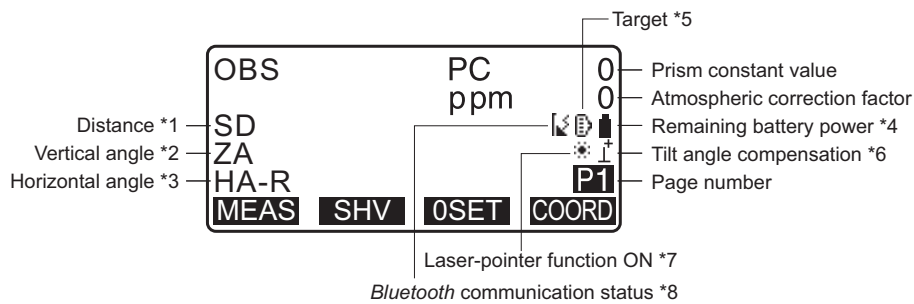

### Measuring screen

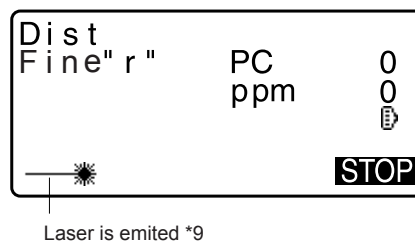

### Top menu

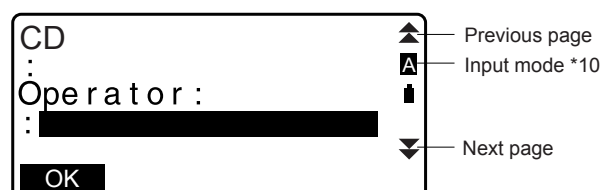

## (1) Distance

SD: Slope distance

HD: Horizontal distance

VD: Height difference

☞ Switching distance display status: "33.1 Observation Conditions - Angle/Tilt"

## (2) Vertical angle

ZA: Zenith angle (Z=0)

VA: Vertical angle (H=0/H=±90)

To switch vertical angle/slope in %, press **[ZA/%]**

☞ Switching vertical angle display status: "33.1 Observation Conditions - Angle/Tilt"

## (3) Horizontal angle

Press **[R/L]** to switch the display status.





HA-R: Horizontal angle right

HA-L: Horizontal angle left

## (1) (2) (3)

To switch usual "SD, ZA, HA-R" display to "SD, HD, VD", press **[SHV]**.

## (4) Remaining battery power (Temperature=25°C, EDM on)

Using BDC46C	Battery level
	level 3 Full power
	level 2 Plenty of power remains.
	level 1 Half or less power remains.
	level 0 Little power remains. Charge the battery.
 (This symbol is displayed every 3 seconds)	No power remains. Stop the measurement and charge the battery.

☞ "6.1 Battery Charging"

## (5) Target display

Press **{SHIFT}** to switch the selected target. This key function can be used only on the screens on which the target symbol is displayed. :prism :reflective sheet :reflectorless

## (6) Tilt angle compensation

When this symbol is displayed, the vertical and horizontal angles are automatically compensated for small tilt errors using 2-axis tilt sensor.

☞ Tilt compensation setting: "33.1 Observation Conditions - Angle/Tilt"

## (7) Laser-pointer display

☞ Selecting Laser-pointer: "33.7 Instrument Conditions - Instrument", Switching Laser-pointer ON/OFF:  
"5.1 Basic Key Operation"

☼ :Laser-pointer is selected and ON

(8) *Bluetooth* communication status

 :Connection established

 (flashing): Connecting

 (flashing): Waiting

 (flashing): Disconnecting

 : *Bluetooth* device is OFF

(9) Appears when laser beam is emitted for distance measurement

(10) Input mode

**A**: Inputting capital letters and figures.

**a**: Inputting small letters and figures.

**1**: Inputting numbers.

### 5.3 Starkey Mode

Pressing the Starkey {★} displays the Starkey menu.

In the Starkey mode, you can change the setting commonly used for measuring.

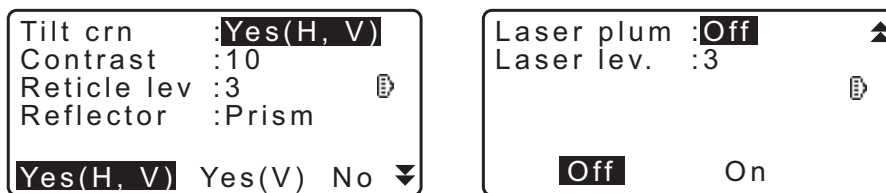

The following operations and settings can be made in the Starkey mode

1. Turning ON/OFF tilt angle correction
2. Adjusting the display unit's contrast (Steps 0~15)
3. Adjusting reticle illumination level (Steps 0~5)
4. Switching the target type
5. Turning ON/OFF laser plummet (for the instrument with the laser centering function)

\* The Starkey mode can be called only from the OBS mode.

# 6. USING THE BATTERY

## 6.1 Battery Charging

Be sure to charge the battery fully before using it for the first time or after not using it for long periods.



- The charger will become rather hot during use. This is normal.
- Do not use batteries other than those designated.
- The charger is for indoor use only. Do not use outdoors.
- Batteries cannot be charged, even when the charging lamp is flashing, when the temperature is outside the charging temperature range.
- Do not charge the battery just after charging is completed. Battery performance may decline.
- Remove batteries from the charger before putting into storage.
- When not in use, disconnect the power cable plug from the wall outlet.
- Store the battery in a dry room where the temperature is within the following ranges. For long-term storage, the battery should be charged at least once every six months.

Storage period	Temperature range
1 week or less	-20 to 50°C
1 week to 1 month	-20 to 45°C
1 month to 6 months	-20 to 40°C
6 months to 1 year	-20 to 35°C

- Batteries generate power using a chemical reaction and as a result have a limited lifetime. Even when in storage and not used for long periods, battery capacity deteriorates with the passage of time. This may result in the operating time of the battery shortening despite having been charged correctly. In this event, a new battery is required.

### PROCEDURE

1. Connect the power cable to the charger and plug the charger into the wall outlet.
2. Mount the battery in the charger by matching the grooves on the battery with the guides on the charger.

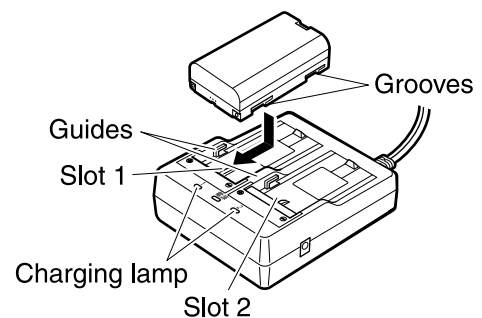

3. When charging starts, the lamp starts blinking.
4. The lamp lights when charging is finished.
5. Remove the battery and unplug the charger.

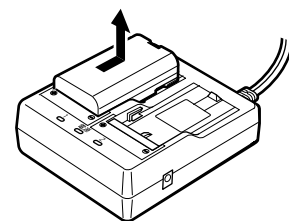



- Slots 1 and 2:  
The charger starts charging the battery mounted first. If you place two batteries in the charger, the battery in slot 1 is charged first, and then the battery in slot 2. (☞ step 2)
- Charging lamp:  
The charging lamp is off when the charger is outside the charging temperature range or when the battery is mounted incorrectly. If the lamp is still off after the charger falls within its charging temperature range and the battery is mounted again, contact your local dealer. (☞ steps 2 and 3)
- Charging time per battery (at 25°C) :  
BDC46C : about 2.5 hours  
BDC70 (optional accessory) : about 5.5 hours

(Charging can take longer than the times stated above when temperatures are either especially high or low).

## 6.2 Installing/Removing the Battery

Mount the charged battery.

☞ Type of power source: "36. POWER SUPPLY SYSTEM"



- Use the provided battery BDC46C/BDC70 (optional accessory) for this instrument.
- Before removing the battery, turn OFF the power to the instrument.
- Do not open the battery cover while the power is on.
- When installing/removing the battery, make sure that moisture or dust particles do not come in contact with the inside of the instrument.
- Waterproofing property for this instrument is not secured unless the battery cover and external interface hatch are closed, and the connector caps are correctly attached. Do not use it with these open or loose, under the condition where water or other liquid spills over the instrument. The specification grade for water proofing and dust resistance is not guaranteed when using USB connector.
- Remove batteries from the surveying instrument or charger before putting into storage.

### PROCEDURE Mounting the battery

1. Slide the catch on the battery cover to open.

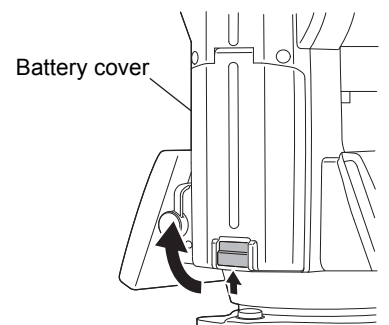

2. Checking the terminal side on the battery, insert the battery as shown.



- Do not insert the battery inclined. Doing so may damage the instrument or battery terminals.

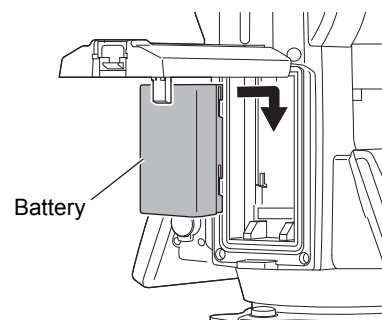

3. Close the battery cover. A click is heard when the cover is secure.

# 7. SETTING UP THE INSTRUMENT



- Mount the battery in the instrument before performing this operation because the instrument will tilt slightly if the battery is mounted after levelling.

## 7.1 Centering

### PROCEDURE Centering with the optical plummet eyepiece

1. Make sure the legs are spaced at equal intervals and the head is approximately level.  
Set the tripod so that the head is positioned over the survey point.  
Make sure the tripod shoes are firmly fixed in the ground.

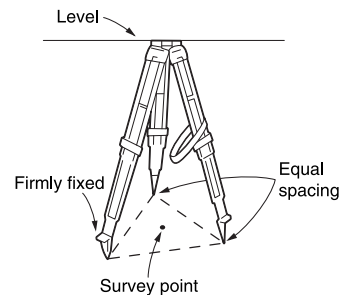

2. Place the instrument on the tripod head.  
Supporting it with one hand, tighten the centering screw on the bottom of the unit to make sure it is secured to the tripod.

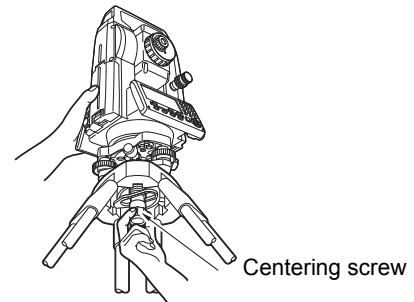

3. Looking through the optical plummet eyepiece, turn the optical plummet eyepiece to focus on the reticle.  
Turn the optical plummet focussing ring to focus on the survey point.

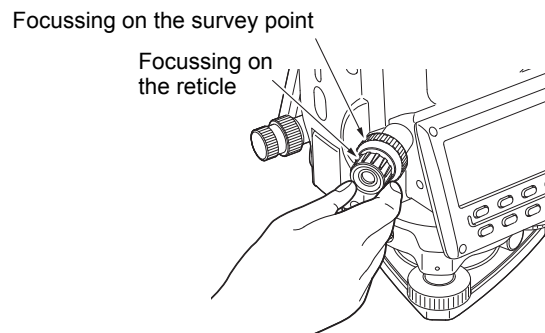

4. Adjust the levelling foot screws to center the survey point in the optical plummet reticle.

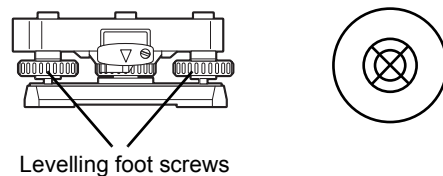



5. Continue to the levelling procedure.  
➔ "7.2 Levelling"



**PROCEDURE Centering with the laser plummet eyepiece\*1**

\*1: Laser plummet is available as a factory option depending on the country or the area where the instrument is purchased.

1. Set up the tripod and affix the instrument on the tripod head.  
 "7.1 Centering"



2. Power ON the instrument.  
 "8. POWER ON/OFF"

The electric circular level is displayed on the <Tilt>.

3. Press [**L-ON**].

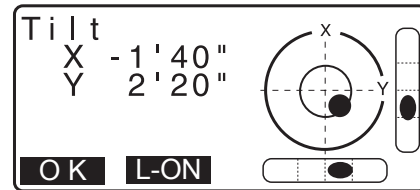
The laser plummet beam will be emitted from the bottom of the instrument.



• Use {/} {} in the second page to adjust the brightness of the laser.

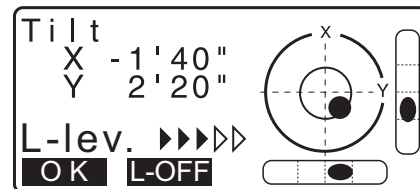

4. Using levelling foot screws, adjust the position of the instrument on the tripod until the laser beam is aligned with the center of the survey point.

5. Press [**L-OFF**] to turn the laser plummet off.  
 Alternatively, press {ESC} to return to the previous screen.  
 The laser plummet will switch off automatically.

**Note**

• Visibility of the laser spot may be affected when operating in direct sunlight. In this event, provide shade for the survey point.

**7.2 Levelling****PROCEDURE**

1. Perform the centering procedure.  
 "7.1 Centering"

- Roughly center the bubble in the circular level by either shortening the tripod leg closest to the offcenter direction of the bubble or by lengthening the tripod leg farthest from the offcenter direction of the bubble. Adjust one more tripod leg to center the bubble.

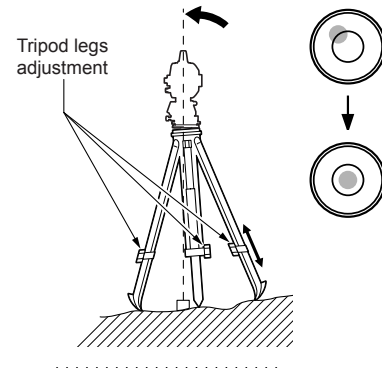

- Power ON the instrument.

"8. POWER ON/OFF"

The electric circular level is displayed on the <Tilt>.

"●" indicates the bubble in circular level. The range of the inside circle is  $\pm 4'$  and the range of the outside circle is  $\pm 6'$ . Tilt angle values X and Y are also displayed on the screen.

- "●" is not displayed when the tilt of the instrument exceeds the detection range of the tilt sensor. Level the instrument while checking the air bubbles in the circular level until "●" is displayed on the screen.

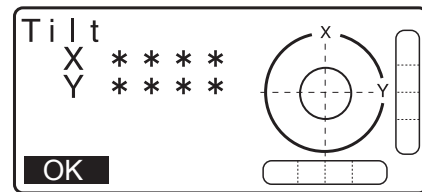

Note

- When executing the measurement program, if measurement starts with the instrument tilted, the circular level is displayed on the screen.

- Using levelling foot screws, center "●" in the circular level. First, turn the instrument until the telescope is parallel to a line between levelling foot screws A and B. Next, set the tilt angle to  $0^\circ$  using foot screws A and B for the X direction and levelling screw C for the Y direction.

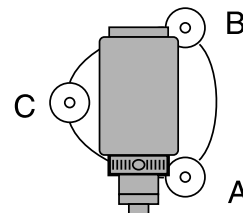

- When the bubble is in the center, proceed to step 5.

- Loosen the centering screw slightly.

Looking through the optical plummet eyepiece, slide the instrument over the tripod head until the survey point is exactly centered in the reticle.

Retighten the centering screw securely.

If the instrument is levelled using laser plummet, emit the laser plummet beam and check it again.

"7.2 Levelling PROCEDURE Centering with the laser plummet eyepiece\*1"

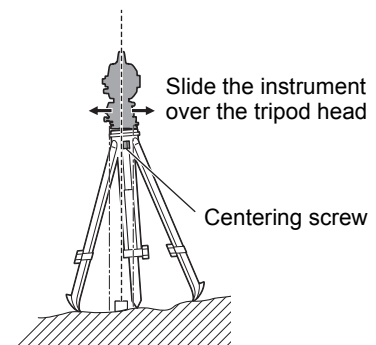

- Check again to make sure the bubble in the electric circular level is centered.

If not, repeat the procedure starting from step 4.

- Press {ESC} to return to Observation mode.

# 8. POWER ON/OFF



- When the power cannot be switched ON or the power is soon turned OFF even though the battery is mounted, there may be almost no battery power remaining. Replace it with a fully charged battery.  
 ⓘ "34. WARNING AND ERROR MESSAGES"

## PROCEDURE Power ON

- Press and hold (about 1 sec) the power key on the operation panel.  
 When the power is switched on, a self-check is run to make sure the instrument is operating normally.

- When password is set, the display appears as at right. Input password and press **{ENT}**.

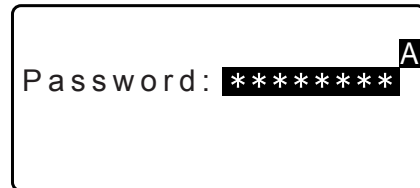

Then, the electric circular level is displayed in the screen. After leveling the instrument, press **[OK]** to enter into the OBS mode.

ⓘ "7.2 Levelling"

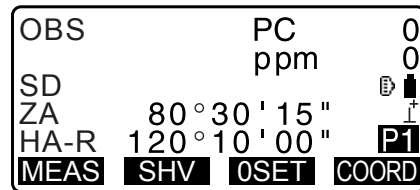
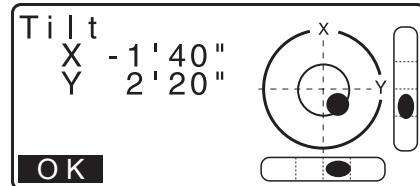

### Note

- When "V manual" is set to "Yes", the display appears as at right after leveling the instrument and press **[OK]**.  
 ⓘ Manually indexing the vertical circle by Face 1/2 measurements: "40. EXPLANATIONS"
- If "Out of range" or the Tilt screen is displayed, level the instrument again.
- "Tilt crn" in "Obs. condition" should be set to "No" if the display is unsteady due to vibration or strong wind.  
 ⓘ "33.1 Observation Conditions - Angle/Tilt"
- When "Resume" in "Instr. config" is set to "On", the screen previous to power off is displayed (except when missing line measurement was being performed).  
 ⓘ "33.1 Observation Conditions - Angle/Tilt"

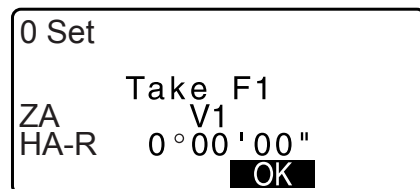

### Resume function

The Resume function redisplay the screen appearing before the instrument was powered OFF when the instrument is powered back ON. All parameter settings are also saved. Even if remaining battery power is completely depleted, this function will remain active for 1 minute, after which it is canceled. Replace a depleted battery as soon as possible.

## PROCEDURE Power OFF

1. Press and hold (about 1 sec) the power key on the operation panel.



- When there is almost no battery power remaining, the battery icon in the Status icon will start to blink. In this event, stop measurement, switch off the power and charge the battery or replace with a fully charged battery.
- To save power, power to the instrument is automatically cut off if it is not operated for a fixed period of time. This time period can be set in "Power off" in <Instr.config.>.  
 "33.1 Observation Conditions - Angle/Tilt"
- In some cases, it may take longer until Power OFF.
- Do not remove the battery until the display turns off. Doing so will cause data stored in the iM to be lost.



### Reset button

If you are experiencing problems with the software, depress the reset button to reboot the program forcibly. Use a provided hexagonal wrench (1.3 mm/1.5 mm) or a tapered rod like a pin to depress down the reset button.



- Pressing down the Reset button may result in file and folder data being lost.
- Avoid using any sharp implement like a needle. Malfunction of the instrument could result.

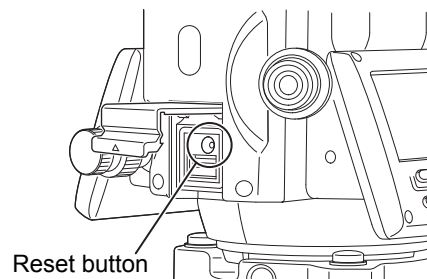

# 9. CONNECTING TO EXTERNAL DEVICES

The instrument supports *Bluetooth* wireless technology and RS232C for communication with data collectors etc. Inputting/outputting data is possible by inserting a USB flash drive. Read this manual in conjunction with the operator's manual for the relevant external device.



- When doing *Bluetooth* communication, read "4.3 Bluetooth Wireless Technology".

## 9.1 Wireless Communication using *Bluetooth* Technology

The *Bluetooth* module incorporated in the instrument can be used for communication with *Bluetooth* devices such as data collectors.



### **Bluetooth connection mode**

Communication between a pair of *Bluetooth* devices requires one device to be set as the "Master" and the other as the "Slave". iM is always "Slave" and the paired data collector will be the "Master" when performing measurements and recording the data between them.



- When restoring set items to initial settings, reconfigure the *Bluetooth* communication settings.

### PROCEDURE Setting for *Bluetooth* communication

1. Select "Comms setup" in Config mode.

```
Config
Obs.condition
Instr.config
Key function
Comms setup
Instr.const
```

2. Select "Comms mode" in <Communication Setup>.

```
Comms setup
Comms mode
Comms type
RS232C
Bluetooth
```

3. Set "Comms mode" to "Bluetooth".

```
Comms mode
: Bluetooth
```

4. Select "Comms type" in <Communication Setup>.

```
Comms setup
Comms mode
Comms type
RS232C
Bluetooth
```

5. Select "S-Type".



- "T-Type" is for an instrument using GTS commands.



6. Perform communication settings for S-type.

**Items set and options (\*: Factory setting)**

(1) Check sum : Yes/No\*



- Changing communication settings during *Bluetooth* communication will cancel the connection.
- No changes for the factory setting are necessary as long as connecting to a recommended program on the data collector. If connection can not be established, check the communication settings of iM and the data collector.

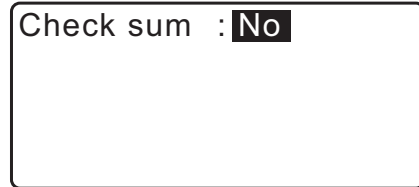

7. Select "*Bluetooth*" in <Communication Setup>.

Register the Bluetooth address (BD\_ADDR) displayed here in the paired device set as "Master".

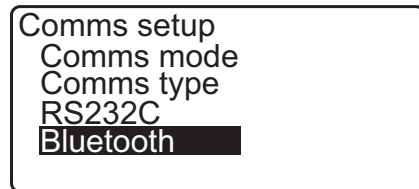

8. Press {ENT} to finish settings. Move on to the *Bluetooth* communication.

"9.2 Communication between the iM and Companion Device"



**Bluetooth device address**

This is a number unique to one particular *Bluetooth* device used to identify devices during communication. This number consists of 12 characters (numbers 0 to 9 and letters from A to F).

Some devices may be referred to by their *Bluetooth* device address.



- The followings are communication formats compatible with the iM.

T type	GTS (Obs / Coord), SSS (Obs / Coord)
S type	SDR33, SDR2X

Depending on the communication format used, select T type/S type.

- When selecting "T-type" in step 3, the following items are displayed.

(1) CR, LF  
Yes/No\*

(2) ACK mode   
Standard\*/Omitted

(3) ACK/NAK   
Yes/No\*

**CR, LF**

Select the option Off or On for carriage return (CR) and line feed when collecting measurement data with a computer.

**ACK mode**

When communicating to an external device, the protocol for handshaking can omit the **[ACK]** coming from the external device, so data is not sent again.

**ACK/NAK**

ACK/NAK is the setting regarding to the communication using GTS format.

## 9.2 Communication between the iM and Companion Device



- *Bluetooth* communication causes instrument battery power to be depleted at a rate higher than that for normal operation.
- Check that the companion device (data collector, computer, or cellular phone etc.) is turned on and the relevant *Bluetooth* settings are complete.
- All communication settings will be changed to factory settings when a cold boot is performed. Comms setup will need to be performed again.

"9.1 Wireless Communication using Bluetooth Technology"



When "Mode" is set to "*Bluetooth*" in "Comms setup" in Config mode [ ]/[ ] is displayed in OBS mode.

- Softkeys (in OBS mode)

Softkey	Operation
[  ]	Enter waiting status
[  ]	Cancel the connection/exit waiting status

- Audio tones

(While connecting/disconnecting)

Start waiting: short beep

Connection successfully established: long beep

### PROCEDURE

1. Complete the necessary settings for *Bluetooth* communication.

"9.1 Wireless Communication using Bluetooth Technology PROCEDURE Setting for Bluetooth communication"

2. Check that the iM is in waiting status (*Bluetooth* symbol is [flashing]) and start communication by the data collector.
  - ☞ Manual of the program mounted on the data collector
  - ☞ The *Bluetooth* icon: "5.2 Display Functions"

- When the iM is not in waiting status ([x]), press [  ] in the fourth page of OBS mode screen.

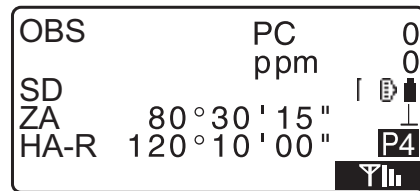

When a connection is established, *Bluetooth* symbol becomes (.

**Note**

- If the Bluetooth device for communication requires your passkey, enter "1111."

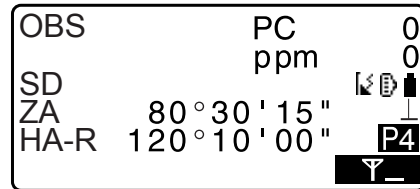

3. Terminate the connection by the data collector.

### 9.3 Connection via RS232C Cable

RS232C communication is possible, connecting instrument and a data collector with the cable.

#### PROCEDURE Basic cable settings

1. Power OFF the instrument and connect the instrument and a data collector with a interface cable.
  - ☞ Cables: "38. ACCESSORIES"



- Insert the interface cable to the serial/external power source connector tightly and then turn it.

2. Select "Comms setup" in Config mode.

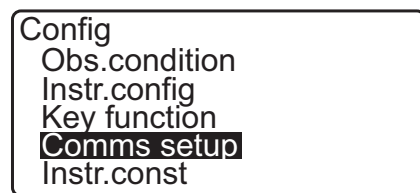

3. Select "Comms mode" in <Communication Setup>.

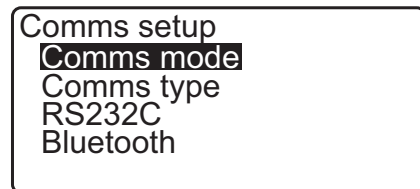

4. Set "Comms mode" to "RS232C".

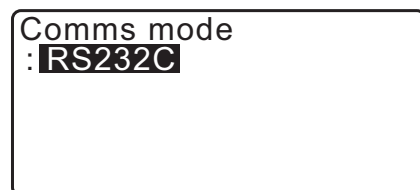



5. Select "RS232C" in <Communication Setup>.

```
Comms setup
Comms mode
Comms type
RS232C
Bluetooth
```

6. Perform communication setting for RS232C.

**Items set and options (\*: Factory setting)**

- (1) Baud rate : 1200/2400/4800/9600\*/19200/  
38400bps
- (2) Data bits : 7/8\* bits
- (3) Parity : Not set\*/Odd/Even
- (4) Stop bit : 1\*/2 bits

```
Baud rate 9600bps
Data bits : 8bit
Parity : None
Stop bit : 1bit
```

7. Press **{ENT}** to finish settings.

# 10.TARGET SIGHTING AND MEASUREMENT

## 10.1 Manually Sighting the Target



- When sighting the target, strong light shining directly into the objective lens may cause the instrument to malfunction. Protect the objective lens from direct light by attaching the lens hood.  
Observe to the same point of the reticle when the telescope face is changed.

### PROCEDURE

---

1. Focus on the reticle  
Look through the telescope eyepiece at a bright and featureless background.  
Turn the eyepiece screw clockwise, then counterclockwise little by little until just before the reticle image becomes focussed.  
Using these procedures, frequent reticle refocussing is not necessary since your eye is focussed at infinity.
2. Sight the target  
Loosen the vertical and horizontal clamps, then use the sighting collimator to bring the target into the field of view.  
Tighten both clamps.
3. Focus on the target  
Turn the telescope focussing ring to focus on the target.  
Turn the vertical and horizontal fine motion screws to align the target with the reticle.  
The last adjustment of each fine motion screw should be in the clockwise direction.
4. Readjust the focus until there is no parallax  
Readjust the focus with the focussing ring until there is no parallax between the target image and the reticle.

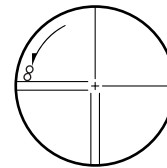

### Eliminating parallax

This is the relative displacement of the target image with respect to the reticle when the observer's head is moved slightly before the eyepiece.

Parallax will introduce reading errors and must be removed before observations are taken. Parallax can be removed by refocussing the reticle.

# 11. ANGLE MEASUREMENT

This section explains the procedures for basic angle measurement in Observation mode.

## 11.1 Measuring the Horizontal Angle between Two Points (Horizontal Angle 0°)

Use the "0SET" function to measure the included angle between two points. The horizontal angle can be set to 0 at any direction.

### PROCEDURE

1. Sight the first target as at right.  
☞ "10. TARGET SIGHTING AND MEASUREMENT"

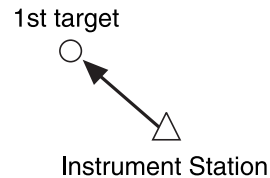

2. In the first page of the OBS mode screen, press **[0SET]**.  
**[0SET]** will flash, so press **[0SET]** again.  
The horizontal angle at the first target becomes 0°.

OBS	PC	0
	ppm	0
SD		☞
ZA	89° 59' 50"	↑
HA-R	0° 00' 00"	P1
MEAS	SHV	0SET
		COORD

3. Sight the second target.

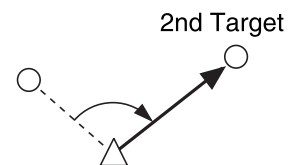

The displayed horizontal angle (HA-R) is the included angle between two points.

OBS	PC	0
	ppm	0
SD		☞
ZA	89° 59' 50"	↑
HA-R	117° 32' 20"	P1
MEAS	SHV	0SET
		COORD

## 11.2 Setting the Horizontal Angle to a Required Value (Horizontal Angle Hold)

You can reset the horizontal angle to a required value and use this value to find the horizontal angle of a new target.

### PROCEDURE Entering the horizontal angle

1. Sight the first target.
2. Press **[H-SET]** on the second page of the OBS mode and select "Angle."
3. Enter the angle you wish to set, then press **[OK]**.  
The value that is input as the horizontal angle is displayed.
  - Press **[REC]** to set and record the horizontal angle.  
☞ "28.2 Recording Backsight Point"

```
Set H angle
Angle
Coord
```

```
Set H angle
Take BS
ZA      89° 59' 50"
HA-R    347° 23' 46"
HA-R    125.3220
REC      OK
```

```
OBS      PC      0
          ppm     0
SD
ZA      89° 59' 50"
HA-R    125° 32' 20"
MENU    TILT    H-SET  EDM
```

4. Sight the second target.  
The horizontal angle from the second target to the value set as the horizontal angle is displayed.

#### Note

- Pressing **[HOLD]** performs the same function as above.
- Press **[HOLD]** to set the displayed horizontal angle. Then, set the angle that is in hold status to the direction you require.  
☞ Allocating **[HOLD]**: "33.11 Allocating Key Functions"

### PROCEDURE Entering the coordinate

1. Press **[H-SET]** on the second page of the OBS mode and select "Coord."

```
Set H angle
Angle
Coord
```

- Set the known point coordinate. Enter the coordinate for the first point, and press **[OK]**.

Press **[YES]** to set the horizontal angle.

- Press **[REC]** to set and record the horizontal angle.  
 "28.2 Recording Backsight Point"

SET H angle/BS	
NBS:	100.000
EBS:	100.000
ZBS:	<Null>
<b>LOAD</b>	<b>OK</b>

Set H angle	
Take BS	
ZA	89° 59 ' 50 "
HA-R	125° 32 ' 20 "
Azmth	45° 00 ' 00 "
<b>REC</b>	<b>NO</b> <b>YES</b>

- Sight the second target.  
The horizontal angle from the set coordinate is displayed.

### 11.3 Horizontal Angle Repetition

To find the horizontal angle with greater precision, perform repetition measurement.

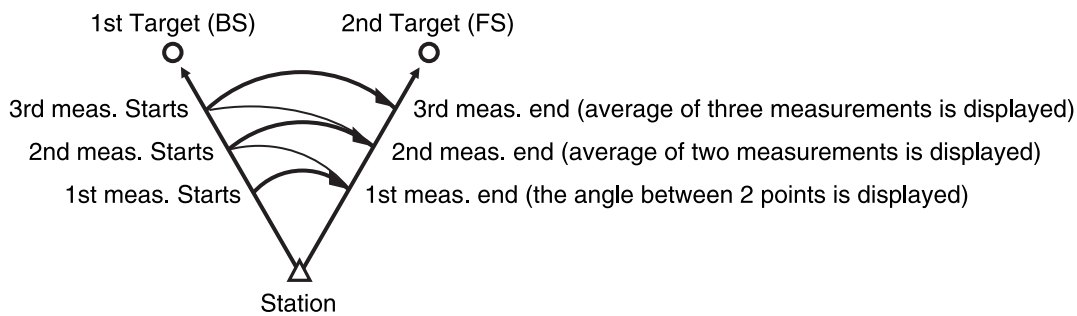

- The maximum number of angle measurements that can be made is 10.

#### PROCEDURE

- Allocate **[REP]** to the Meas mode screen, then press **[REP]**.  
<Repetition> is displayed.  
 Allocating **[REP]**: "33.12 Allocating Key Functions"

- Sighting the first target, press **[OK]**.

Repetition	
HARp	0° 00 ' 00 "
Reps.	0
Ave.	0° 00 ' 00 "
Take BS	
<b>CLEAR</b>	<b>OK</b>

- Sighting the second target, press **[OK]**.
- Sighting the first target a second time, press **[OK]**.

5. Sighting the second target a second time, press **[OK]**.  
The added value of the horizontal angle is displayed on the second line "HARp" and the average value of the horizontal angle is displayed on the fourth line "Ave."

Repetition	
HARp	110°16'20"
Reps.	2
Ave.	50°38'10"
Take	BS
<b>CLEAR</b>	<b>OK</b>

- Return to the previous measurement of the first target and redo it: **[CREAR]**. (Effective when the display shows "Take BS")

6. When continuing the repetition measurement, repeat steps 4 to 5.
7. When the repetition measurement is completed, press **{ESC}**.

## 11.4 Angle Measurement and Outputting the Data

The following explains angle measurement and the features used to output measurement data to a computer or peripheral equipment.

- ☞ *Bluetooth* communication: "9. CONNECTING TO EXTERNAL DEVICES"  
Communication cables: "38. ACCESSORIES"  
Output format and command operations: "Communication manual"

### PROCEDURE

1. Connect iM and host computer.
2. Allocate the **[HVOUT-T]** or **[HVOUT-S]** softkey to the OBS mode screen.  
☞ "33.11 Allocating Key Functions"



- Pressing the softkey outputs data in the following format.  
**[HVOUT-T]** : GTS format  
**[HVOUT-S]** : SET format

3. Sight the target point.
4. Press **[HVOUT-T]** or **[HVOUT-S]**.  
Output measurement data to peripheral equipment.

# 12.DISTANCE MEASUREMENT

Perform the following settings as preparation for distance measurement.

- Distance measurement mode
- Target type
- Prism constant correction value
- Atmospheric correction factor
- EDM ALC

 "33.1 Observation Conditions - Angle/Tilt"/"33.2 Observation Conditions - Dist"

## **Caution**

- When using the Laser-pointer function, be sure to turn OFF the output laser after distance measurement is completed. Even if distance measurement is canceled, the Laser-pointer function is still operating and the laser beam continues to be emitted. (After turning ON the Laser-pointer, the laser beam is emitted for 5 minutes, and then automatically switches OFF. But in the Status screen and when target symbol (ex. ) is not displayed in the OBS mode, the laser beam is not automatically turned off.)



- Make sure that the target setting on the instrument matches the type of target used. iM automatically adjusts the intensity of the laser beam and switches the distance measurement display range to match the type of target used. If the target does not correspond to the target settings, accurate measurement results cannot be obtained.
- Accurate measurement results cannot be obtained if the objective lens is dirty. Dust it off with the lens brush first, to remove minute particles. Then, after providing a little condensation by breathing on the lens, wipe it off with the silicon cloth.
- During reflectorless measurement, if an object obstructs the light beam used for measurement or an object is positioned with a high reflective factor (metal or white surface) behind the target, accurate measurement results may not be received.
- Scintillation may affect the accuracy of distance measurement results. Should this occur, repeat measurement several times and use the averaged value of the obtained results.

## 12.1 Returned Signal Checking

Check to make sure that sufficient reflected light is returned by the reflective prism sighted by the telescope. Checking the returned signal is particularly useful when performing long distance measurements.

## **Caution**

- The laser beam is emitted during returned signal checking.



- When the light intensity is sufficient even though the center of the reflective prism and the reticle are slightly misaligned (short distance etc.), "\*" will be displayed in some cases, but in fact, accurate measurement is impossible. Therefore make sure that the target center is sighted correctly.

## PROCEDURE

---

1. Allocate the **[S-LEV]** softkey to the OBS mode screen.  
 "33.11 Allocating Key Functions"
2. Accurately sight the target.

- Press **[S-LEV]**.  
<Aiming> is displayed.  
The intensity of the light of the returned signal is displayed by a gauge.

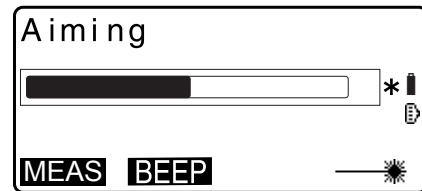

- The more ████████ displayed, the greater the quantity of reflected light.
- If "\*" is displayed, only enough light for the measurement is returned.
- When "\*" is not displayed, accurately resight the target.
- Press **[BEEP]** to make a buzzer sound when measurement is possible. Press **[OFF]** to shut off the buzzer.
- Press **[MEAS]** to start distance measurement.

- Press **{ESC}** to finish signal checking and return to OBS mode.

**Note**

- When ████████ is displayed persistently, contact your local dealer.
- If no key operations are performed for two minutes, the display automatically returns to the OBS mode screen.

## 12.2 Distance and Angle Measurement

An angle can be measured at the same time as the distance.

### PROCEDURE

- Sight the target.
- In the first page of OBS mode, press **[MEAS]** to start distance measurement.

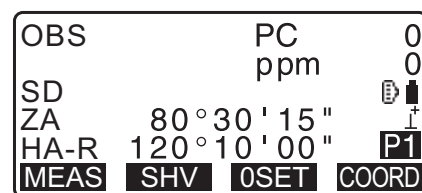

When measurement starts, EDM information (distance mode, prism constant correction value, atmospheric correction factor) is represented by a flashing light.

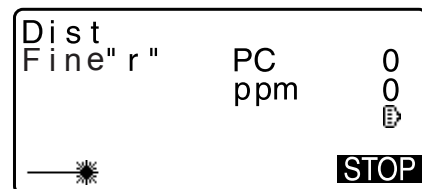

A short beep sounds, and the measured distance data (SD), vertical angle (ZA), and horizontal angle (HA-R) are displayed.

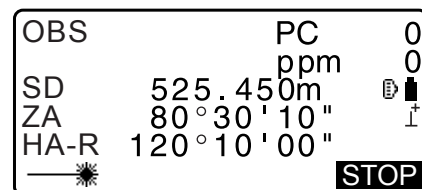

- Press **[STOP]** to quit distance measurement.



- Each time **[SHV]** is pressed, SD (Slope distance), HD (Horizontal distance) and VD (Height difference) are displayed alternately.

OBS	PC	0
	ppm	0
SD	525.450m	
HD	518.248m	
VD	86.699m	<b>P1</b>
<b>MEAS</b>	<b>SHV</b>	<b>OSET</b>
		<b>COORD</b>

#### Note

- Audio tones differ depending on the target type; prism or others.
- If the single measurement mode is selected, measurement automatically stops after a single measurement.
- During fine average measurement, the distance data is displayed as S-1, S-2, ... to S-9. When the designated number of measurements has been completed, the average value of the distance is displayed in the [S-A] line.
- The distance and angle that are most recently measured remain stored in the memory until the power is off and can be displayed at any time.  
 "12.3 Recalling the Measured Data"

### 12.3 Recalling the Measured Data

The distance and angle that are most recently measured remain stored in the memory until the power is off and can be displayed at any time.

The distance measurement value, vertical angle, horizontal angle, and the coordinates can be displayed. Distance measurement values converted into the horizontal distance, elevation difference, and the slope distance can also be displayed.

#### PROCEDURE

1. Allocate the **[CALL]** softkey to the OBS mode screen.  
 "33.11 Allocating Key Functions"
2. Press **[CALL]**.  
 The stored data that is most recently measured is displayed.
  - If you have pressed **[SHV]** beforehand, the distance values are converted into the horizontal distance, elevation difference, and the slope distance and recalled.

SD	525.450m
HD	518.248m
VD	86.699m
N	-128.045
E	-226.237
Z	30.223

3. Press **{ESC}** to return to OBS mode.

### 12.4 Distance Measurement and Outputting the Data

The following explains distance measurement and the features used to output measurement data to a computer or peripheral equipment.

- Setting procedures: "9. CONNECTING TO EXTERNAL DEVICES"  
 Communication cables: "38. ACCESSORIES"  
 Output format and command operations: "Communication manual"

#### PROCEDURE

1. Connect iM and host computer.

- Allocate the **[HVDOUT-T]** or **[HVDOUT-S]** softkey to the OBS mode screen.

 "33.11 Allocating Key Functions"



- Pressing the softkey outputs data in the following format.

**[HVDOUT-T]**: GTS format

**[HVDOUT-S]**: SET format

- Sight the target point.
- Press **[HVDOUT-T]** or **[HVDOUT-S]** to measure the distance and output the data to peripheral equipment.
- Press **[STOP]** to stop outputting data and return to OBS mode.

## 12.5 Coordinate Measurement and Outputting the Data

The following explains coordinate measurement and the features used to output measurement data to a computer or peripheral equipment.

-  Setting procedures: "9. CONNECTING TO EXTERNAL DEVICES"  
 Communication cables: "38. ACCESSORIES"  
 Output format and command operations: "Communication manual"

### PROCEDURE

- Connect iM and host computer.
- Allocate the **[NEZOUT-T]** or **[NEZOUT-S]** softkey to the OBS mode screen.

 "33.11 Allocating Key Functions"



- Pressing the softkey outputs data in the following format.

**[NEZOUT-T]**: GTS format

**[NEZOUT-S]**: SET format

- Sight the target point.
- Press **[NEZOUT-T]** or **[NEZOUT-S]** to measure the distance and output the data to peripheral equipment.



- When the Distance Measurement mode is set to "Tracking" in the EDM Settings, the measured data cannot be output by pressing **[NEZOUT-T]**.
- Press **[STOP]** to stop outputting data and return to OBS mode.

## 12.6 REM Measurement

An REM measurement is a function used to measure the height to a point where a target cannot be directly installed such as power lines, overhead cables and bridges, etc.

The height of the target is calculated using the following formula.

$$H_t = h_1 + h_2$$

$$h_2 = S \sin \theta_{z1} \times \cot \theta_{z2} - S \cos \theta_{z1}$$

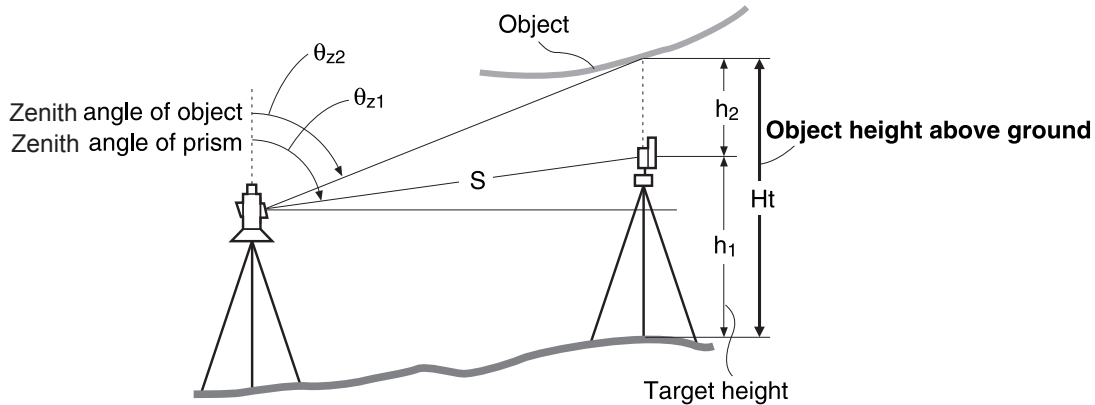

- The items displayed as <Null> in the coordinate data are excluded from the calculation (Null is different from 0).

### PROCEDURE

1. Set the target directly under or directly over the object and measure the target height with a tape measure etc.

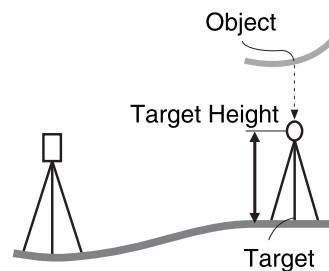

2. After inputting the target height, accurately sight the target.

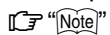

Press **[MEAS]** in page 1 of OBS mode to carry out measurement.

The measured distance data (SD), vertical angle (ZA), and horizontal angle (HA-R) are displayed.

Press **[STOP]** to stop the measurement.

3. In the second page of OBS mode screen, press **[MENU]**, then select "REM".

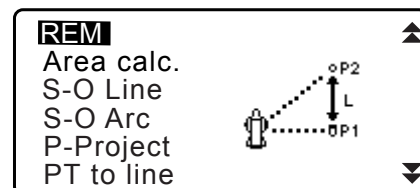

4. Enter into the REM menu. Select "REM."

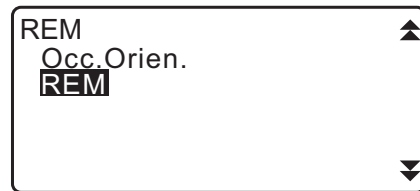

5. Sight the target.

Pressing **[REM]** starts REM measurement.  
The height from the ground to the object is displayed in "Ht."

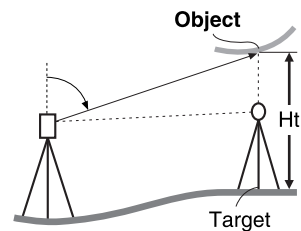
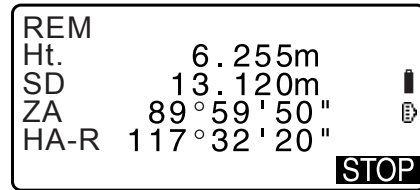

6. Press **[STOP]** to terminate the measurement operation.

- To re-observe the target, sight the target, then press **[MEAS]**.

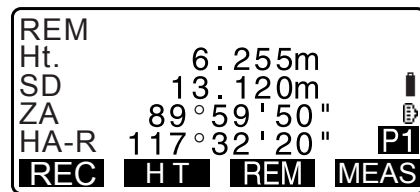

- Press **[HT]** to enter an instrument height (HI) and a target height (HR).

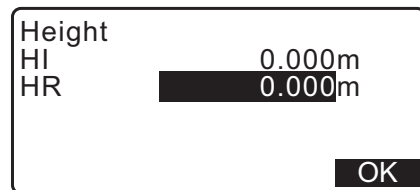

- When **[REC]** is pressed, REM data is saved.  
☞ "28. RECORDING DATA - TOPO MENU -"

- Press **[HT/Z]** on the second page of the REM measurement to display the Z coordinate for the height from the ground to the target. Pressing **[HT/Z]** again returns to the height display.

7. Press **{ESC}** to finish measurement and return to the OBS mode screen.

Note

- It is also possible to perform REM measurement by pressing **[REM]** when allocated to the OBS mode screen.  
☞ "33.11 Allocating Key Functions"
- Inputting instrument and target height: Press **[HT]** to set instrument and target height. It can be set also in "Occ. Orientation" of coordinate measurement.  
☞ "13.1 Entering Instrument Station Data and Azimuth Angle"

# 13.SETTING INSTRUMENT STATION

It is possible to set from the instrument station data to the backsight angle in a series of procedures.

## Setting Instrument Station Data

- Key input
  - ☞ "13.1 Entering Instrument Station Data and Azimuth Angle" Step 3
- Reading the registered coordinate
  - ☞ "13.1 Entering Instrument Station Data and Azimuth Angle" PROCEDURE Reading in Registered Coordinate Data
- Calculating data by resection measurement
  - ☞ "13.2 Setting Instrument Station Coordinate with resection measurement"

## Setting backsight angle

- Inputting the backsight angle
  - ☞ "13.1 Entering Instrument Station Data and Azimuth Angle" Step 3
- Calculating from the backsight coordinate
  - ☞ "13.1 Entering Instrument Station Data and Azimuth Angle" Step 3
- Calculating the direction angle by assuming the known point (first point) at the time of resection measurement as the backsight point.
  - ☞ "13.2 Setting Instrument Station Coordinate with resection measurement" Step 9



- When performing measurement in which the reduced data is output, be sure to record the instrument station data before the measurement. If a correct instrument station data is not recorded, it may cause output of an unintended measurement result.
  - ☞ Reduced data : "31.1 Outputting JOB Data to Host Computer"

## 13.1 Entering Instrument Station Data and Azimuth Angle

Before coordinate measurement, enter instrument station coordinates, the instrument height, target height, and azimuth angle.

### PROCEDURE

---

1. First measure the target height and instrument height with a tape measure, etc.
2. Select the calculation program from the Observation menu.  
(The explanation below is an example of when "coordinate measurement" is selected.)

## 3. Select "Occ.orien."

Input the following data items.

- (1) Instrument station coordinates (Occupied point coordinates)
- (2) Point name (PT)
- (3) Instrument height (HI)
- (4) Code (CD)
- (5) Operator
- (6) Date
- (7) Time
- (8) Weather
- (9) Wind
- (10) Temperature
- (11) Air pressure
- (12) Humidity
- (13) Atmospheric correction factor

Coord.
<b>Occ. Orient</b>
Observation
EDM

N0:	0.000
E0:	0.000
Z0:	<Null>
PT	AUTO100000
HI	1.200m
<b>LOAD</b>	<b>BS AZ</b>
<b>BS NEZ</b>	<b>RESEC</b>

- When you wish to read in the registered coordinate data, press **[LOAD]**.

☞ "PROCEDURE Reading in Registered Coordinate Data"

- Press **[RESEC]** to measure instrument station coordinates by resection measurement.

☞ "13.2 Setting Instrument Station Coordinate with resection measurement"

4. Press **[BS AZ]** in the screen of step 3 to proceed to azimuth angle input.

- Press **[BS NEZ]** to calculate azimuth angle from backsight coordinates.

☞ "13.1.1 Setting Azimuth Angle from Backsight Coordinates"

5. Input azimuth angle and press **[OK]** to set the input values. <Coord> is displayed again.

- Press **[REC]** to record the following data.  
Instrument station data, RED (Reduced) data, backsight station data, and angle measurement data

Backsight	
Take BS	
ZA	40° 23 ' 13 "
HA-R	40° 42 ' 15 "
HA-R	
<b>REC</b>	<b>OK</b>

Press **[OK]** to set the input values and return to <Coord>.

**Note**

- Maximum point name size: 14 (alphanumeric)
- Input range of instrument height: -9999.999 to 9999.999 (m)
- Maximum code/operator size: 16 (alphanumeric)
- Weather selection: Fine, Cloudy, Light rain, Rain, Snow
- Wind selection: Calm, Gentle, Light, Strong, Very strong
- Temperature range: -35 to 60 (°C) (in 1°C step)/-31 to 140 (°F) (in 1°F step)
- Air pressure range: 500 to 1400 (hPa) (in 1 hPa step)/375 to 1050 (mmHg) (in 1mmHg step)/14.8 to 41.3 (inch Hg) (in 1 inchHg step)
- Atmospheric correction factor range (ppm): -499 to 499

- Humidity range (%): 0 to 100
- The "Humid. (Humidity)" is displayed only when the "Humid.inp" is set to "Yes".  
☞ "33.4 Observation Conditions - Atmosphere"
- Above-described input ranges are the ranges when 1 mm is selected in "Dist.reso". When 0.1 mm is selected, values can be input to the first decimal place.

### PROCEDURE Reading in Registered Coordinate Data

Known point data, coordinate data and instrument station data in the current JOB and Coordinate Search JOB can be read in.

Confirm that the correct JOB containing the coordinates you want to read in is already selected in Coordinate Search JOB in Data Mode.

☞ "29.1 Selecting a JOB", "30.1 Registering/Deleting Known Point Data"

1. Press **[LOAD]** when setting Instrument Station.

The list of registered coordinates is displayed.

PT :Known point data saved in the current JOB or in the Coordinate Search JOB.

Crd./ Occ :Coordinate data saved in the current JOB or in the Coordinate Search JOB.

```

PT 11111111
PT 1
Crd. 2
Occ 12345679
Occ 1234
[↑↓...P] [FIRST] [LAST] [SRCH]

```

2. Align the cursor with the required point name and press **{ENT}**.

The point name that was read and its coordinates are displayed.

```

NO: 0.000
EO: 0.000
ZO: <Null>
PT AUTO100000
HI 1.200m
[LOAD] [BS AZ] [BS NEZ] [RESEC]

```

- **[↑↓...P]** = Use **{▲}**/**{▼}** to move from page to page.
- **[↑↓...P]** = Use **{▲}**/**{▼}** to select individual point.
- Press **[FIRST]** to move to the first point name on the first page.
- Press **[LAST]** to move to the last point name on the last page.
- Press **[SRCH]** to move to the "Coordinate Data Search Screen."

☞ "13.1.1 Setting Azimuth Angle from Backsight Coordinates"

- You can edit the coordinate data that was read in. Editing does not affect the original coordinate data. After editing, the point name is no longer displayed.

#### Note

- The point name that was read in is displayed until the current JOB is changed.
- When **[SRCH]** is pressed, iM searches data in the current JOB first, then in the Coordinate Search JOB.
- If more than two points with the same point name exist in the current JOB, iM finds the newer data only.

### PROCEDURE Coordinate Data Search (Complete match)

1. Press **[Search]** on the registered coordinate data list screen.

2. Enter search criteria.  
Enter following items.
  - (1) Coordinate point name
  - (2) Search condition (complete match)
  - (3) Search direction

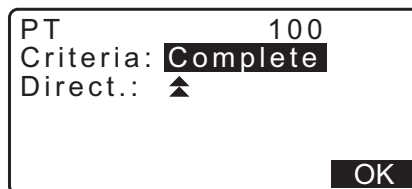

3. Press **[OK]** to display the details of searched data.

**Searching the coordinate point name**

Data is saved according to the time it was recorded. When there is more than one coordinate point name matching the search, "the point nearest to the currently selected data" is selected. See the Note below for search method options.



- Options for the setting items are as follows. (\* is the setting when the power is turned to ON.)
  - \* Search method: ▼ (searches backward from the current point name) \*/
  - ▲ (searches forward from the current point name)

**PROCEDURE Coordinate Data Search (Partial match)**

1. Press **[Search]** in the registered coordinate data list screen.  
All coordinate data that includes characters and numbers entered in step 2 is displayed.

2. Enter search criteria.  
Enter the following items.
  - (1) Partial coordinate point name
  - (2) Search condition (partial match)

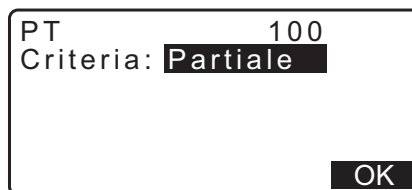

3. Press **[OK]** to display data that matches the search information.
4. Select the data and press **{ENT}** to display the details.

**13.1.1 Setting Azimuth Angle from Backsight Coordinates**

Set the azimuth angle of the backsight station by calculating by the coordinates.

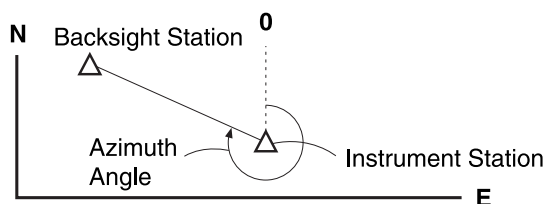

**PROCEDURE**

1. Enter the instrument station data.  
☞ "13.1 Entering Instrument Station Data and Azimuth Angle"



2. Press **[BS NEZ]** after entering the instrument station data to enter a backsight point coordinate.

- When you wish to read in the registered coordinate data, press **[LOAD]**.

☞ "13.1 Entering Instrument Station Data and Azimuth Angle" PROCEDURE Reading in Registered Coordinate Data"

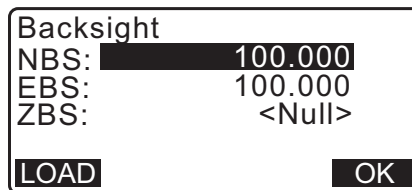

3. Input the backsight station coordinates and press **[OK]**.

4. The backsight angle is displayed in "Azimuth". Press **[YES]**, set an azimuth angle and return to <Coord>.

- Pressing **[NO]** returns to the step 2 screen.

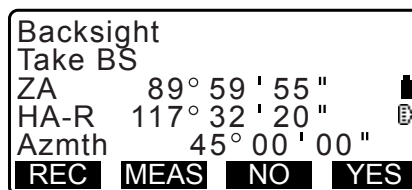

- Pressing **[MEAS]** after collimating the backsight point initiates measurement. When measuring is completed, the backsight distance check screen is displayed. The difference between the calculated value and the measured height distance value is displayed.

After confirming, press **[OK]**.

- Press **[HT]** to set instrument and target height.
- Press **[REC]** to store check data in the current JOB

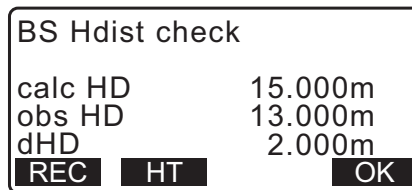

- Press **[REC]** to record the following data.  
 Instrument station data, backsight station data, known point data, and angle measurement data (distance measurement data when **[MEAS]** is pressed)

- When storing the azimuth angle in the current JOB, press **[REC]**.

☞ "28.2 Recording Backsight Point",

## 13.2 Setting Instrument Station Coordinate with resection measurement

Resection is used to determine the coordinates of an instrument station by performing multiple measurements of points whose coordinate values are known. Registered coordinate data can be recalled and set as known point data. Residual of each point can be checked, if necessary.

Entry	Output
Coordinates of known point	: (Xi, Yi, Zi)
Observed horizontal angle	: Hi
Observed vertical angle	: Vi
Observed distance	: Di
	Station point coordinates : (X0,Y0, Z0)

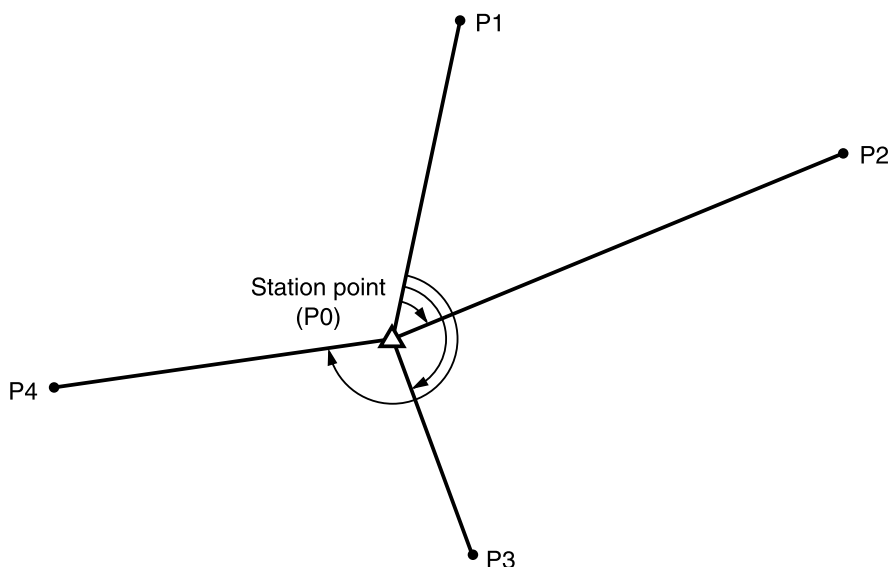

- All the N, E, Z or only Z data of an instrument station is calculated by measuring the known points.
- Coordinate resection measurement overwrites the N, E and Z data of the instrument station, but height resection does not overwrite N and E. Always perform resection measurement in the sequence described in "13.2.2 Coordinate Resection Measurement" and "13.2.4 Height Resection Measurement".
- Input known coordinate data and calculated instrument station data can be recorded in the current JOB.  
 "29. SELECTING/DELETING A JOB"

### 13.2.1 Observation setting

Perform observation setting prior to resection measurement.

1. Select "Occ. Orien."

Coord.
<b>Occ.Orien.</b>
Observation
EDM

2. Press **[RESEC]**.

N0:	<b>0.000</b>
E0:	0.000
Z0:	<Null>
PT	PNT-001
HI	1.200m
<b>LOAD</b>	<b>BS AZ</b>
<b>BS NEZ</b>	<b>RESEC</b>

3. Select "Setting".

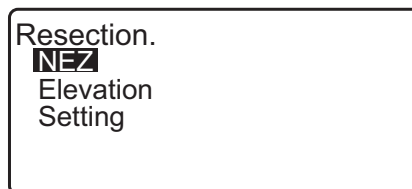

4. Set for resection measurement.

Set the following items:

(1) RL observation (F1/F2 Obs):

Observe every point in Face 1 and 2 in resection.

" 13.2.3 RL observation in resection measurement"

Set "F1/F2 Obs" to "Yes" when performing RL observation.

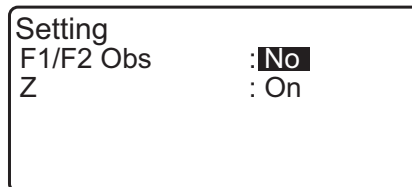

(2) Display  $\sigma Z$  (Z)

Set "Z" to "On" to display standard deviation  $\sigma Z$  in the instrument station coordinate calculation screen and result (standard deviation) screen of coordinate resection.

• Press [ **$\sigma$ NEZ**] to display standard deviation which describes the measurement accuracy. Press [**NEZ**] to return to the instrument station coordinate screen.

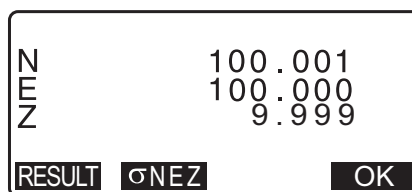

•  $\sigma Z$  can be displayed by pressing in the result screen in which is displayed.

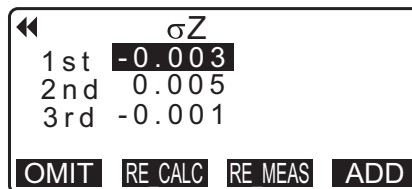

Note

Choices of the setting are as follows (\*is the default setting):

- RL observation: Yes / No \*
- Display  $\sigma Z$ : On\* / Off

**13.2.2 Coordinate Resection Measurement**

Observe existing points with known coordinate data to calculate the coordinate value for the instrument station.

- Between 2 and 10 known points can be measured by distance measurement, and between 3 and 10 known points by angle measurement.

**PROCEDURE**

1. Select "Occ.orien." from the coordinate measurement menu.



2. Press [RESEC].

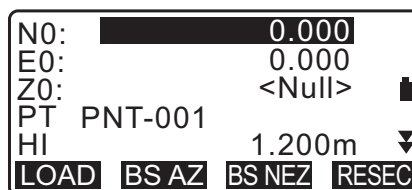

3. Select "NEZ".

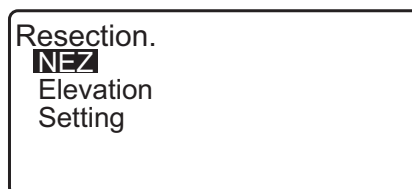

4. Sight the first known point and press [MEAS] to begin measurement.  
 The measurement results are displayed on the screen.

- When [BS AZ] has been selected, the distance cannot be displayed.

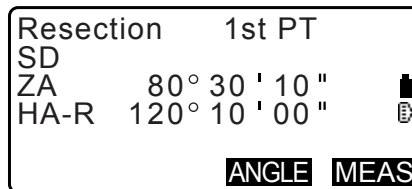

5. Press [YES] to use the measurement results of the first known point.

- You can also input target height here.

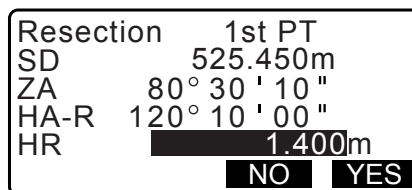

6. Input coordinates for the first known point and press [NEXT] to move to the second point.

- When [LOAD] is pressed, registered coordinates can be recalled and used.

☞ "13.1 Entering Instrument Station Data and Azimuth Angle PROCEDURE Reading in Registered Coordinate Data"

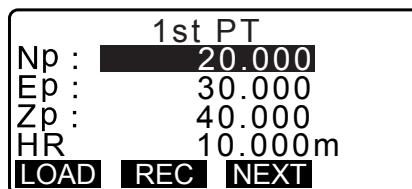

- Press {ESC} to return to the previous known point.

7. Repeat procedures 4 to 6 in the same way from the second point.  
When the minimum quantity of observation data required for the calculation is present, [CALC] is displayed.

8. Press [CALC] to automatically start calculations after observations of all known points are completed.  
Instrument station coordinate and standard deviation, which describes the measurement accuracy, are displayed.

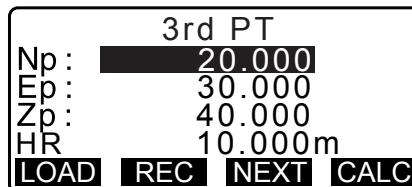

9. Press [RESULT] to check the result.

- Pressing {ESC} returns to the previous screen.
- Press [ADD] when there is a known point that has not been measured or when a new known point is added.

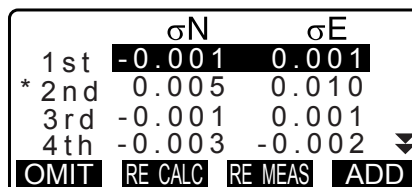
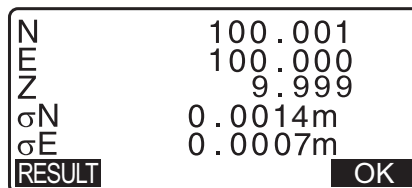

10. If there are problems with the results of a point, align the cursor with that point and press [OMIT]. "\*" is displayed on the left of the point. Repeat for all results that include problems.

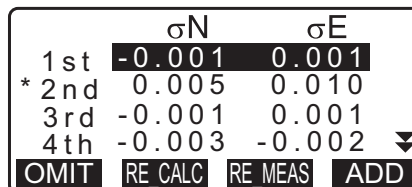

11. Press [RE\_CALC] to perform calculation again without the point designated in step 10. The result is displayed.  
If there are no problems with the result, go to step 12.  
If problems with the result occur again, perform the resection measurement from step 4.

- Press [RE\_MEAS] to measure the point designated in step 10.  
If no points are designated in step 10, all the points or only the final point can be observed again.

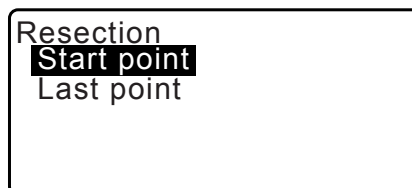

12. Press [OK] in the screen of step 9 to finish resection measurement. The instrument station coordinate is set.  
Press [YES] when you want to set the azimuth angle of the first known point as the backsight point (except for omitted points). It returns to the instrument station setting screen.

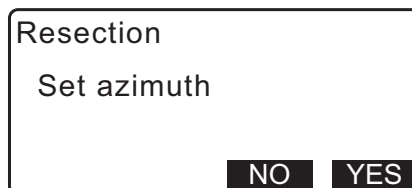

Pressing **[OK]** sets the direction angle and instrument station data, and then returns to <Coord.>.

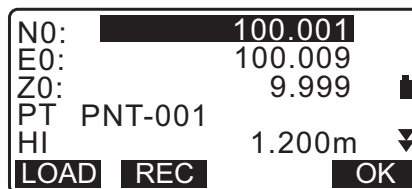

- Pressing **[REC]** displays the backsight point recording screen. Press **[OK]** to the following data. Instrument station data, backsight station data, known point data, and angle measurement data (distance measurement data when **[MEAS]** is pressed)

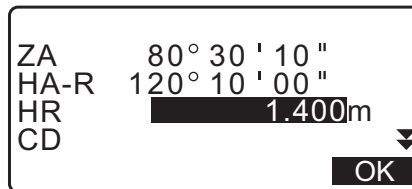

Pressing **[NO]** returns to the instrument station setting screen without setting the direction angle. From here, set the backsight point again.

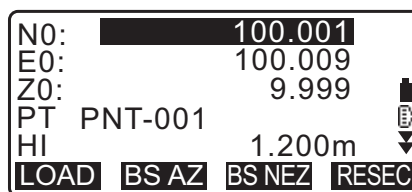

- Even if "inch" is selected in Config mode, standard deviation is displayed in "feet" or "US feet" depending on the feet unit selected.

### 13.2.3 RL observation in resection measurement

1. Set "F1/F2 Obs" to "Yes" in observation setting.  
 " 13.2.1 Observation setting"

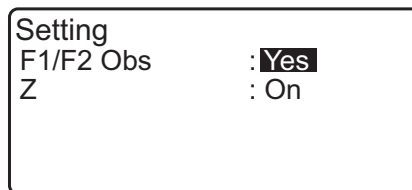

2. Press **[RESEC]**.

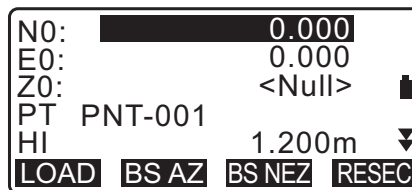

3. Select "NEZ".

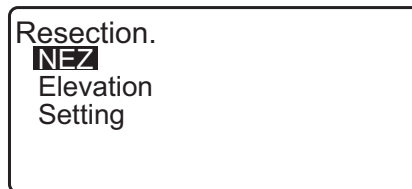

4. Measure the first known point in Face 1. "R" is displayed in the screen title. Press **[MEAS]** to start measuring. The measurement results are displayed on the screen.

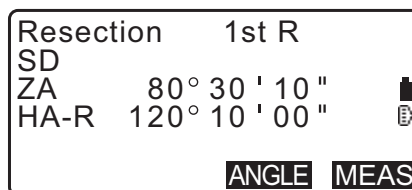

5. Press **[Yes]** to use the measurement results of the first known point in Face 1.

- You can input target height here.

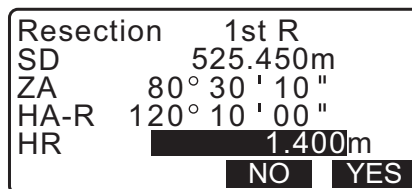

6. Measure the first known point in Face 2.

"L" is displayed in the screen title.

Press **[MEAS]** to start measuring. The measurement results are displayed on the screen.

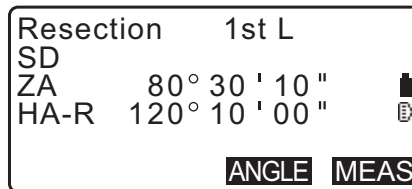

7. Press **[Yes]** to use the measurement results of the first known point in Face 2.

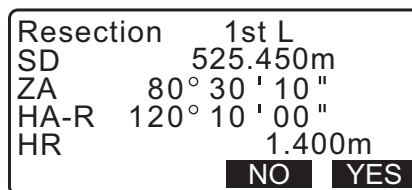

8. Input coordinates for the first known point and press **[NEXT]** to move to the second point.

- When **[LOAD]** is pressed, registered coordinates can be recalled and used.

 "13.1 Entering Instrument Station Data and Azimuth Angle PROCEDURE Reading in Registered Coordinate Data"

- Press **{ESC}** to return to the previous known point.

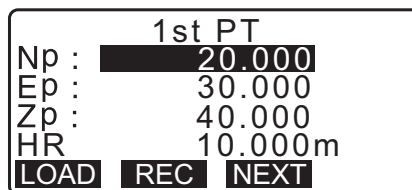

9. Repeat steps 4 to 8 in the same way from the second point.

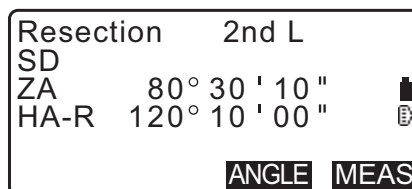

When the minimum quantity of observation data required for the calculation is present, **[CALC]** is displayed.

Perform the following procedure referring " 13.2.2 Coordinate Resection Measurement" steps 8 to 12.

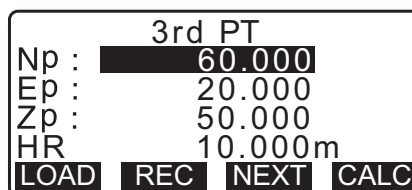

**Note**

- Order of RL observation in resection measurement is as follows:

- (1) 1st point (R1 → L1 → coordinates input)
- (2) 2nd point (L2 → R2 → coordinates input)
- (3) 1st point (R3 → L3 → coordinates input)

When re-observe the 1st point, the order is as follows:

- (1) 1st point (R1 → L1 → press **{ESC}** to cancel the result)
- (2) 1st point (L1 → R1 → coordinates input)

### 13.2.4 Height Resection Measurement

Only Z (height) of an instrument station is determined by the measurement.

- Known points must be measured by distance measurement only.
- Between 1 and 10 known points can be measured.

#### PROCEDURE

1. Select "Occ.orien." from the coordinate measurement menu.

2. Press **[RESEC]** in the "Occ.orien."

3. Select "Elevation".

- The tilt screen is displayed if the instrument is out of level. Level the instrument.  
 "7.2 Levelling"

```
Resection.
NEZ
Elevation
Setting
```

4. Sight the first known point and press **[MEAS]** to begin measurement. Press **[STOP]**.  
The measurement results are displayed on the screen.

```
Resection 1st PT
SD
ZA      80° 42' 15"
HA-R    140° 49' 15"
MEAS
```

5. Press **[YES]** to use the measurement results of the first known point.

6. Input the known point. After setting the elevation for the first known point, press **[NEXT]** to move to the second point.

```
1st PT
Zp:      11.891
HR       0.100m
LOAD REC NEXT CALC
```

7. If measuring two or more known points, repeat procedures 4 to 6 in the same way from the second point.

- Press **{ESC}** to return to the previous known point.

8. Press **[CALC]** to automatically start calculations after observations of all known points are completed. Instrument station elevation and standard deviation, which describes the measurement accuracy, are displayed.

9. Press **[RESULT]** to check the result.

If there are no problems in the result, press **{ESC}** and go to step 10.

```
Z      10.000
σ Z    0.0022m
RESULT OK
```



10. If there are problems with the results of a point, align the cursor with that point and press **[OMIT]**. “\*” is displayed on the left of the point.

σZ	
1st	-0.003
2nd	-0.003
3rd	0.000
4th	0.002
<b>OMIT</b>	<b>RE_CALC</b> <b>RE_MEAS</b> <b>ADD</b>

11. Press **[RE\_CALC]** to perform calculation again without the point designated in step 10. The result is displayed. If there are no problems with the result, go to step 12. If problems with the result occur again, perform the resection measurement from step 4.

12. Press **[OK]** to finish resection measurement. Only Z (elevation) of the instrument station coordinate is set. N and E values are not overwritten.

**Resection calculation process**

The NE coordinates are found using angle and distance observation equations, and the instrument station coordinates are found using the method of least squares. The Z coordinate is found by treating the average value as the instrument station coordinates.

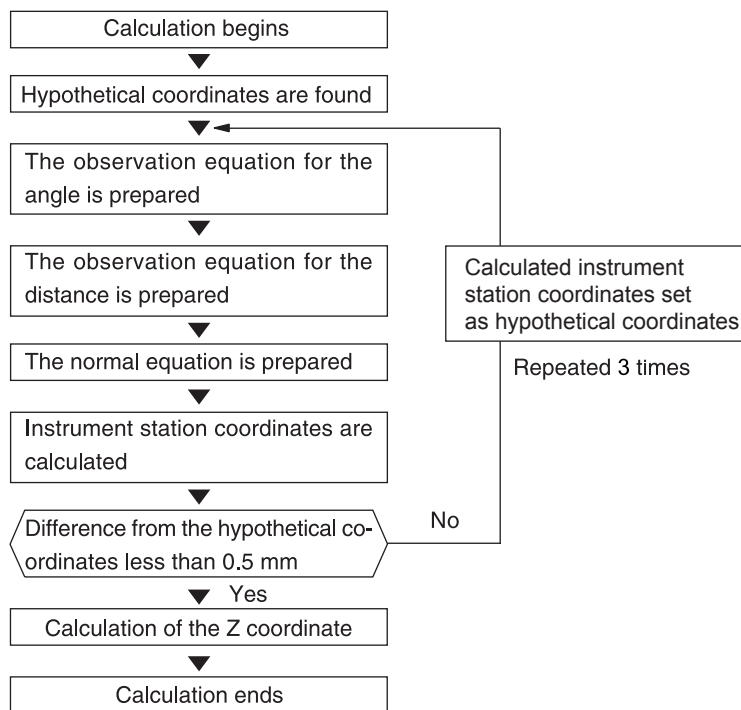

 **Precaution when performing resection**



- Instrument station may not be calculated when the included angles between the known points and the station point are too narrow. Especially when the instrument station and the known points are far away, it is difficult to know that the included angles between the known points are narrow.

When performing resection by angle measurement only and an unknown point (instrument station) and three or more known points are arranged on the edge of a single circle, the coordinates of the unknown point may not be calculated.

An arrangement such as that shown below is desirable.

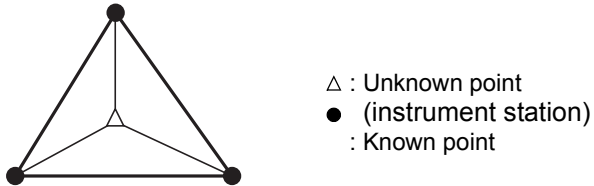

It is sometimes impossible to perform a correct calculation in a case such as the one below.

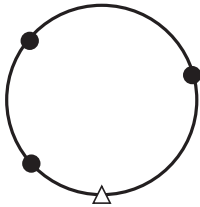

When they are on the edge of a single circle, take one of the following measures.

- (1) Move the instrument station as close as possible to the center of the triangle.

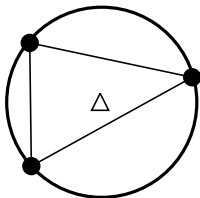

- (2) Observe one more known point which is not on the circle

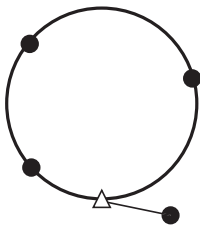

- (3) Perform a distance measurement on at least one of the three points.

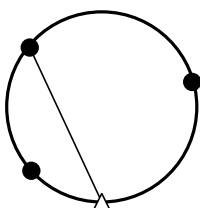

# 14.COORDINATE MEASUREMENT

By performing coordinate measurements it is possible to find the 3-dimensional coordinates of the target based on station point coordinates, instrument height, target height, and azimuth angles of the backsight station which are entered in advance.

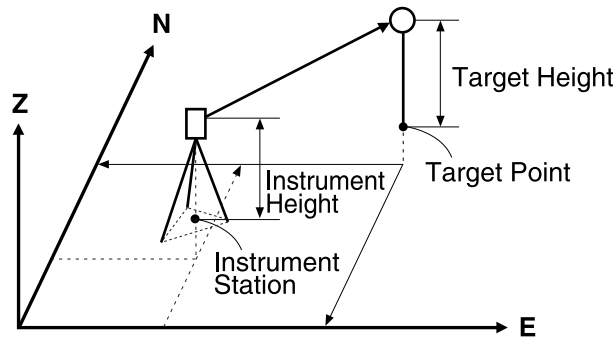

- EDM setting can be done in coordinate measurement menu.  
 Setting items: "33.3 Observation Conditions - Reflector (Target)"

## PROCEDURE 3-D Coordinate Measurement

The coordinate values of the target can be found by measuring the target based on the settings of the instrument station and backsight station.

The coordinate values of the target are calculated using the following formulae.

$$N1 \text{ Coordinate} = N0 + S \times \sin Z \times \cos Az$$

$$E1 \text{ Coordinate} = E0 + S \times \sin Z \times \sin Az$$

$$Z1 \text{ Coordinate} = Z0 + S \times \cos Z + ih - th$$

N0: Station point N coordinate

S: Slope distance

ih: Instrument height

E0: Station point E coordinate

Z: Zenith angle

th: Target height

Z0: Station point Z coordinate

Az: Direction angle



- Z (zenith angle) is calculated as  $360^\circ - Z$  when the telescope is in the Face 1 position.

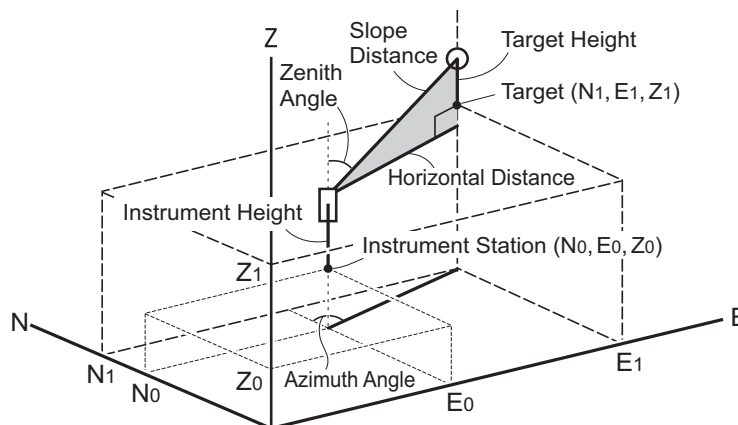

- If not measured or the space is left blank "Null" will be displayed.  
 If station point Z coordinate is set to "Null" the observation result for the Z coordinate is automatically set to "Null".

## PROCEDURE

1. Sight the target at the target point.

2. In the third page of OBS mode screen, press **[MENU]**, then select "Coordinate".

3. Select "Occ.orien." to set the instrument station data and azimuth angle of the backsight point.



4. In <Coord>, select "Observation". Pressing **[MEAS]** will start measurement, and the coordinate value of the target will be displayed. Press **[STOP]** to quit measurement.

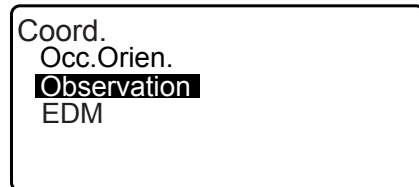

- The tilt screen is displayed if the instrument is out of level. Level the instrument.  
 "7.2 Levelling"

- Enter a target height, point name and code as needed.
- **[REC]**: records measurement results
- **[AUTO]**: starts measurement and automatically records results after **[STOP]** has been pressed.  
 Recording method: "28. RECORDING DATA - TOPO MENU -"

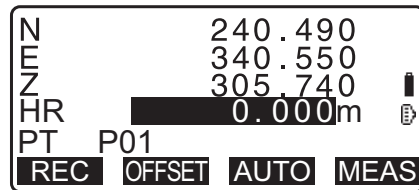

5. Sight the next target and press **[MEAS]** or **[AUTO]** to begin measurement. Continue until all targets have been measured.

- When coordinate measurement is completed, press **{ESC}** to return to <Coord>.

# 15.SETTING-OUT MEASUREMENT

Setting-out measurement is used to set out the required point.

The difference between the previously input data to the instrument (the setting-out data) and the measured value can be displayed by measuring the horizontal angle, distance or coordinates of the sighted point.

The horizontal angle difference and distance difference are calculated and displayed using the following formulae.

## Horizontal angle difference

dHA = Horizontal angle of setting-out data - measured horizontal angle

## Distance difference

Distance            Displayed item

Sdist: S-O S =    measured slope distance - slope distance of setting-out data

Hdist: S-O H =    measured horizontal distance - horizontal distance of setting-out data

Vdist: S-O V =    measured height difference - height difference of setting-out data

- Setting out data can be input in various modes: coordinates, horizontal distance, slope distance, height difference and REM measurement.
- In slope distance, horizontal distance, height difference, and coordinate mode, registered coordinates can be recalled and used as setting-out coordinates. In slope distance, horizontal distance and height difference, S/H/V distances are calculated from the read in setting-out coordinate, instrument station data, instrument height, and target height.
- EDM settings can be set in the Setting-out measurement menu.
- If not measured or the space is left blank "Null" will be displayed.  
If distance or angle of setting-out data is set to "Null" the Distance difference is automatically set to "Null"



- If the S-O data is set in the display other than <S-O Coord>, when the display is returned to <S-O Coord>, the data that has been input will be deleted.

## 15.1 Coordinates Setting-out Measurement

After setting the coordinates for the point to be set out, the iM calculates the setting-out horizontal angle and horizontal distance. By selecting the horizontal angle and then the horizontal distance setting-out functions, the required coordinate location can be set out.

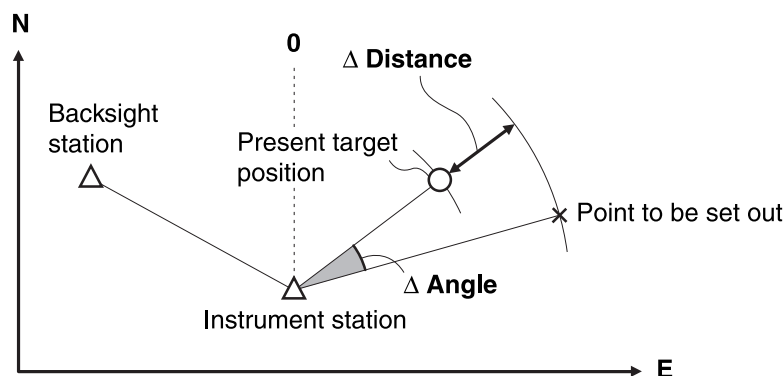

- To find the Z coordinate, attach the target to a pole etc. with the same target height.

## PROCEDURE

1. Press **[S-O]** on the third page of the OBS mode screen to display <S-O>.

- Select "Occ.orien." to set the instrument station data and azimuth angle of the backsight point.  
 [F] "13.1 Entering Instrument Station Data and Azimuth Angle PROCEDURE Reading in Registered Coordinate Data"

- Select "S-O data". <S-O Coord> is displayed.



- Enter the coordinates of the setting-out point.

- When **[LOAD]** is pressed, registered coordinates can be recalled and used as setting-out coordinates.

[F] "13.1 Entering Instrument Station Data and Azimuth Angle PROCEDURE Reading in Registered Coordinate Data"

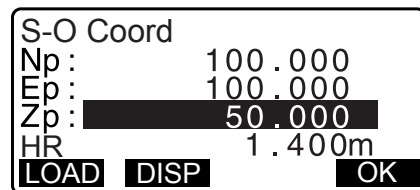

- Pressing **[DISP]** switches between the distance input modes.

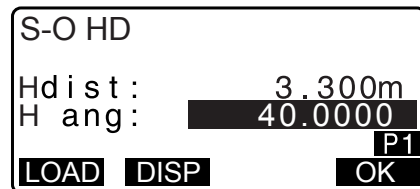

- Press **[OK]** to set the setting-out data.

- The tilt screen is displayed if the instrument is out of level. Level the instrument.

[F] "7.2 Levelling"

- The difference in the distance and angle calculated with the set instrument station and the target point is displayed. Rotate the top of the instrument until "dHA" is 0° and place the target on the sight line.

- Press **[MEAS]** to begin setting-out measurement. The target and the distance of the point to be set out is displayed (S-OΔ HD).

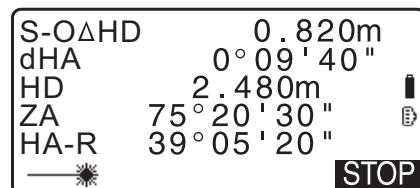
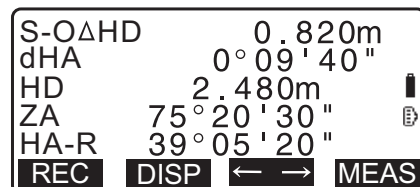

- Move the prism forward and backward until the setting-out distance is 0 m. If S-O $\Delta$ HD is "+", move the prism toward yourself, if it is "-", move the prism away from yourself.

- By pressing [ $\leftarrow$   $\rightarrow$ ], an arrow pointing to the left or right displays which direction the target should be moved.

- $\leftarrow$  : Move the prism to left.
- $\rightarrow$  : Move the prism to right.
- $\downarrow$  : Move the prism forward.
- $\uparrow$  : Move the prism away.
- $\blacktriangleup$  : Move the prism upward.
- $\blacktriangledown$  : Move the prism downward.

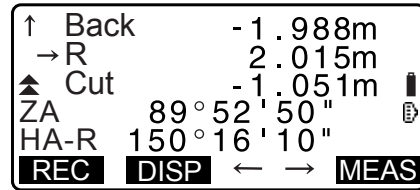

When the target is within measurement range, all four arrows are displayed.

- Press {ESC} to return to step 4.

- When [LOAD] was used in step 4, the list of registered coordinates is restored. Continue setting-out measurement.
- [REC]: records measurement results

Recording method: "28. RECORDING DATA - TOPO MENU -"

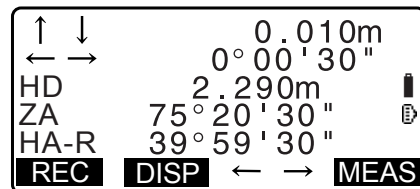

## 15.2 Distance Setting-out Measurement

The point to be found based on the horizontal angle from the reference direction and the distance from the instrument station.

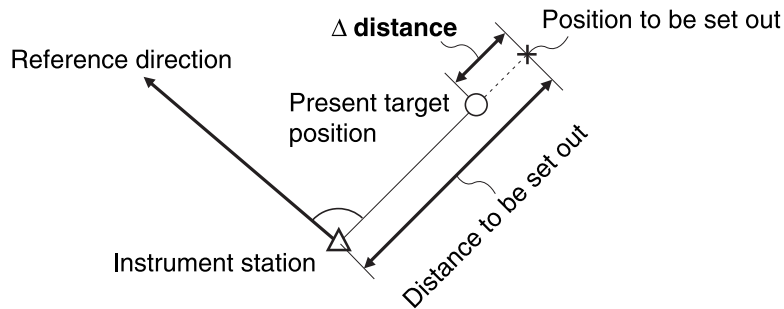

### PROCEDURE

- Press [S-O] in the third page of the OBS mode screen to display <S-O>.
- Select "Occ.orien." to set the instrument station data and azimuth angle of the backsight point.
  - "13.1 Entering Instrument Station Data and Azimuth Angle PROCEDURE Reading in Registered Coordinate Data"

3. Select "S-O data."

4. Press **[DISP]** to change the distance input mode to <S-O H>.

- Each time **[DISP]** is pressed: S-O Coord (coordinates), S-O HD (horizontal distance), S-O SD (slope distance), S-O VD (height difference), S-O Ht. (REM measurement).

☞ 15.1 Coordinates Setting-out Measurement, 15.3 REM Setting-out Measurement

- When **[LOAD]** is pressed, registered coordinates can be recalled and used. Distance and angle are calculated using the coordinate value.

☞ "13.1 Entering Instrument Station Data and Azimuth Angle PROCEDURE Reading in Registered Coordinate Data"

5. Set the following items.

- (1) Sdist/Hdist/Vdist: distance from the instrument station to the position to be set out.
- (2) H ang: included angle between the direction of the reference and the point to be set out.

- Pressing **[COORD]** in the second page allows you to enter the coordinates of the point to be set out.

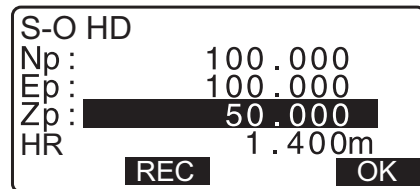
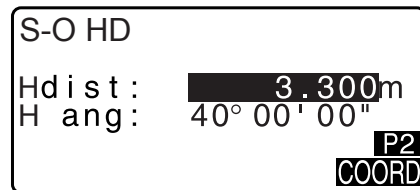
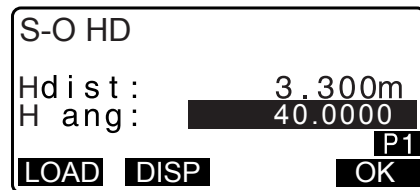
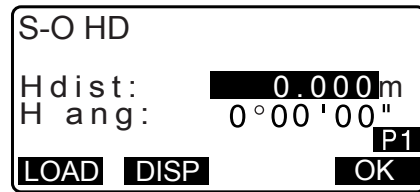

6. Press **[OK]** to set the input values.

- The tilt screen is displayed if the instrument is out of level. Level the instrument.

☞ "7.2 Levelling"

7. Rotate the top of the instrument until "dHA" is 0° and place the target on the sight line.

8. Press **[MEAS]** to start distance measurement. The target and the distance of the point to be set out is displayed (S-OΔHD).

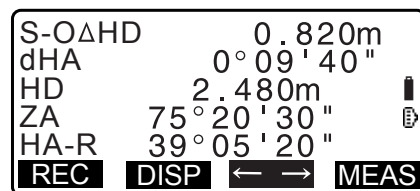

9. Move the prism to find the point to be set out.



10. Press **{ESC}** to return to <S-O>.

- When **[LOAD]** was used in step 4, the list of registered coordinates is restored. Continue setting-out measurement.
- **[REC]**: records measurement results  
 ↳ Recording method: "28. RECORDING DATA - TOPO MENU -"

### 15.3 REM Setting-out Measurement

To find a point where a target cannot be directly installed, perform REM setting-out measurement.

↳ "12.6 REM Measurement"

#### PROCEDURE

1. Install a target directly below or directly above the point to be found, then use a measuring tape etc. to measure the target height (height from the survey point to the target).
2. Press **[S-O]** in the OBS mode screen to display <S-O>.
3. Enter the instrument station data.  
 ↳ "13.1 Entering Instrument Station Data and Azimuth Angle "
4. Select "S-O data" and press **[DISP]** until <S-O Ht.> is displayed.
5. Input height from the survey point to the position to be set out in "SO dist".

S-O Ht.	
Height:	3.300m
HR	1.000m
<b>[DISP]</b>	<b>[OK]</b>

6. After inputting the data, press **[OK]**.

- The tilt screen is displayed if the instrument is out of level.  
Level the instrument.  
↳ "7.2 Levelling"

7. Press **[REM]** to begin REM setting-out measurement.  
Move the telescope to find the point to be set out.  
↳ "15.2 Distance Setting-out Measurement" steps 9 to 10

- ▲: Move the telescope near the zenith.
- ▼: Move the telescope near the nadir.

▼ Cutl	1.051m
SD	1.051m
ZA	89° 52' 55"
HA-R	150° 16' 10"
<b>[MEAS]</b>	<b>[DISP]</b> ← → <b>[REM]</b>

8. When measurement is complete, press **[STOP]**. Pressing **[ESC]** returns to the screen in step 5.

# 16.SETTING-OUT LINE

Setting-out line is used for setting out a required point at a designated distance from the baseline and for finding the distance from the baseline to a measured point.

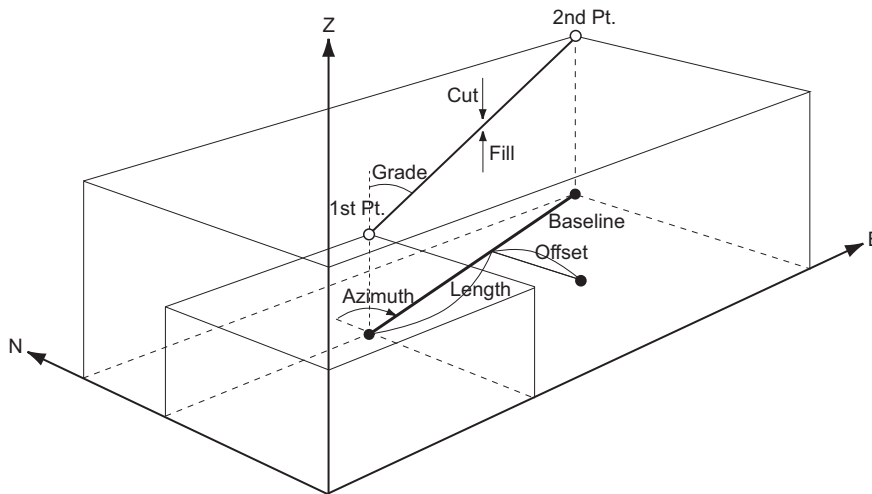

## 16.1 Defining Baseline

To perform setting-out line measurement, first, define the baseline. The baseline can be defined by inputting the coordinates of, or by observing the two points. The scale factor value is the difference between the input coordinates and the observed coordinates.

$$\text{Scale (X, Y)} = \frac{\text{Hdist' (horizontal distance calculated from the measured value)}}{\text{Hdist (horizontal distance calculated from the input coordinates)}}$$

- When not observing first or second points, scale factor is set to "1".
- Defined baseline can be used in both setting-out line measurement and point projection.

### PROCEDURE Defining by inputting coordinates

1. In the second page of OBS mode screen, press **[MENU]**, then select "S-O line".

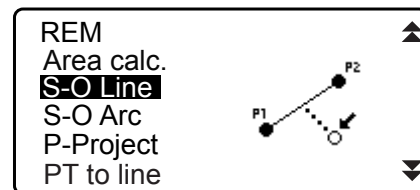

2. Enter the instrument station data.  
 "13.1 Entering Instrument Station Data and Azimuth Angle"

3. Select "Define baseline" in <Set-out line>.

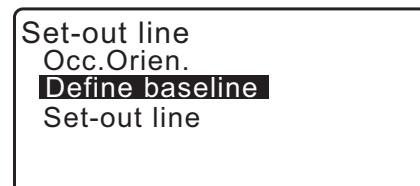

4. Enter the first point data and press **[OK]**.

- When **[LOAD]** is pressed, registered coordinates can be recalled and used.

"13.1 Entering Instrument Station Data and Azimuth Angle PROCEDURE Reading in Registered Coordinate Data"

Define 1st PT	
Np:	113.464
Ep:	91.088
Zp:	12.122
<b>LOAD REC MEAS OK</b>	

5. Enter the second point data.

Define 2nd PT	
Np:	112.706
Ep:	104.069
Zp:	11.775
<b>LOAD REC MEAS OK</b>	

6. Press **{FUNC}**.

**[OBS]** is displayed.

- When not observing the first point and the second point, go to step 11.

Define 2nd PT	
Np:	112.706
Ep:	104.069
Zp:	11.775
<b>LOAD REC MEAS OK</b>	
<b>P2</b>	
<b>OBS</b>	

7. Press **[OBS]** on the screen of step 6 to move to observation of the first point.

8. Sight the first point and press **[MEAS]**.

The measurement results are displayed on the screen.

- Press **[STOP]** to stop the measurement.
  - You can input target height here.
  - The tilt screen is displayed if the instrument is out of level. Level the instrument.
- "7.2 Levelling"

Measure 1st PT	
Np:	113.464
Ep:	91.088
Zp:	12.122
<b>MEAS</b>	

9. Press **[YES]** to use the measurement results of the first point.

- Press **[NO]** to observe the first point again.

Measure 1st PT	
SD	525.450m
ZA	80°30'15"
HA-R	120°10'00"
HR	1.400m
<b>NO YES</b>	

10. Sight the second point and press **[MEAS]**.

11. Press **[YES]** to use the measurement results of the second point.

The distance between the two measured points, the distance calculated from inputting the coordinates of two points and the scale factors are displayed.

Azimuth 93°20'31"	
Hcalc	13.003m
Hmeas	17.294m
ScaleX	1.000091
ScaleY	1.000091
<b>Sy=1 Sy=Sx OK</b>	

Grade %-2.669	
<b>1:** % OK</b>	

12. Press **[OK]** on the screen of step 11 to define the baseline.  
<Set-out line> is displayed. Move to setting-line measurement.

☞ "16.2 Setting-out Line Point"/"16.3 Setting-out Line Line"

- Press **[Sy=1]** to set scale factor y to "1".
- Press **[1 : \*\*]** to change the grade display mode to "1 : \*\* = elevation : horizontal distance".

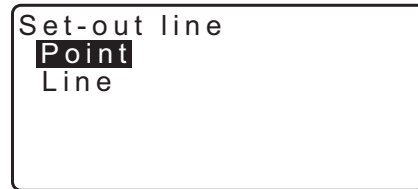

Note

- It is also possible to perform setting-out line measurement by pressing **[S-O LINE]** when allocated to the OBS mode screen.
- ☞ Allocating **[S-O LINE]**: "33.11 Allocating Key Functions".

### PROCEDURE Defining by observation

1. In the second page of OBS mode screen, press **[MENU]**, then select "S-O line".
2. Enter the instrument station data.  
☞ "13.1 Entering Instrument Station Data and Azimuth Angle"
3. Select "Define baseline" in <Set-out line>.
4. Sight the first point and press **[MEAS]**.

- Press **[STOP]** to stop the measurement.
- The tilt screen is displayed if the instrument is out of level. Level the instrument.  
☞ "7.2 Levelling"

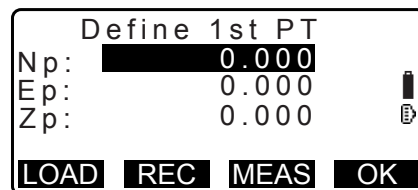

5. Press **[OK]** to use the measurement results of the first point.

- Press **[MEAS]** to observe the first point again.
- Press **[HT]** to input instrument and target height.

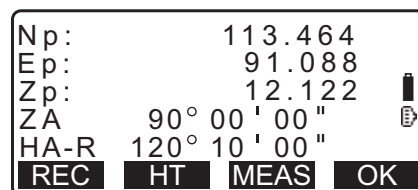

6. Sight the second point and press **[MEAS]**.

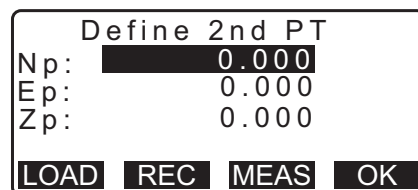

7. Press **[OK]** to use the measurement results of the second point.

- Press **[MEAS]** to observe the second point again.
- Press **[HT]** to input instrument and target height.

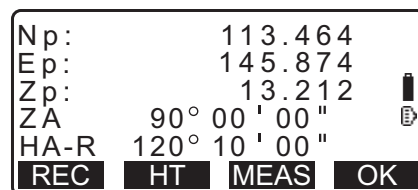

- Scale factor settings can be set in the screen shown at right.

Azimuth	93° 20' 31"
Hcalc	13.003m
Hmeas	17.294m
ScaleX	1.000091
ScaleY	1.000091
Sy=1	Sy=Sx
OK	

Grade	% -2.669
▲	
1:**	%
OK	

8. Press **[OK]** on the third screen of step 7 to define the baseline. <Set-out line> is displayed. Move to setting-line measurement.

☞ "16.2 Setting-out Line Point"/"16.3 Setting-out Line Line"

- Press **[Sy=1]** to set scale factor y to "1".
- Press **[1 : \*\*]** to change the grade display mode to "1 : \*\* = elevation : horizontal distance".

Set-out line
<b>Point</b>
Line

#### Note

- It is also possible to perform setting-out line measurement by pressing **[S-O LINE]** when allocated to the OBS mode screen.
- ☞ Allocating **[S-O LINE]**: "33.11 Allocating Key Functions".

## 16.2 Setting-out Line Point

Setting-out line point measurement can be used to find the required point coordinate by inputting the length and offset based on the baseline.

- Before performing setting-out line point, the baseline must be defined.

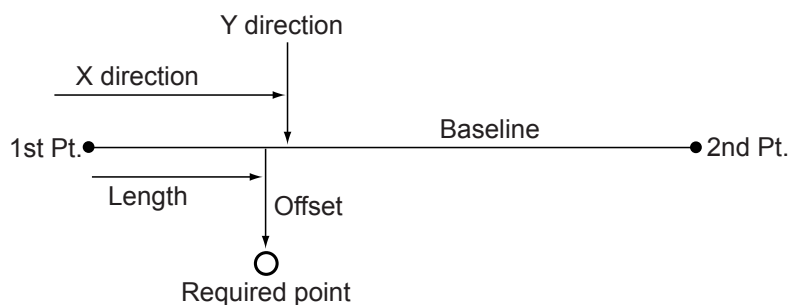

### PROCEDURE

1. Select "Point" in <Set-out line>

Set-out line
<b>Point</b>
Line

2. Set the following items.

- (1) Incr: Increment by which line length and offset can be decreased/increased using the arrow softkeys.
- (2) Line: Distance along the baseline from the first point to the position at which a line extending from the required point intersects the baseline at right angles (X direction).
- (3) Offset: Distance from the required point to the position at which a line extending from the required point intersects the baseline at right angles (Y direction).
- **[↓]/[↑]**: Press to decrease/increase the value by the amount set in "Incr".

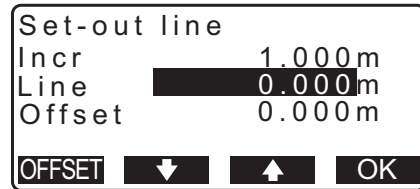

3. Press **[OK]** on the screen of step 2. The coordinate value of the required point is calculated and displayed.

- **[REC]**: records the coordinate value as a known point data.  
 [F] Recording method: "30.1 Registering/Deleting Known Point Data"
- Press **[S-O]** to move to setting-out measurement of the required point.  
 [F] "15. SETTING-OUT MEASUREMENT"

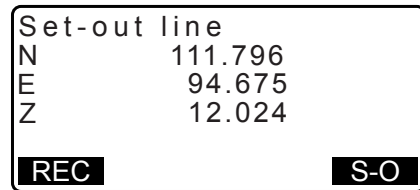

4. Press **{ESC}**. Continue the measurement (repeat steps from 2).

**PROCEDURE Offsetting the baseline**

The baseline can be offset in three dimensions using four methods: lengthwise offset, lateral offset, height offset, and rotation angle offset.

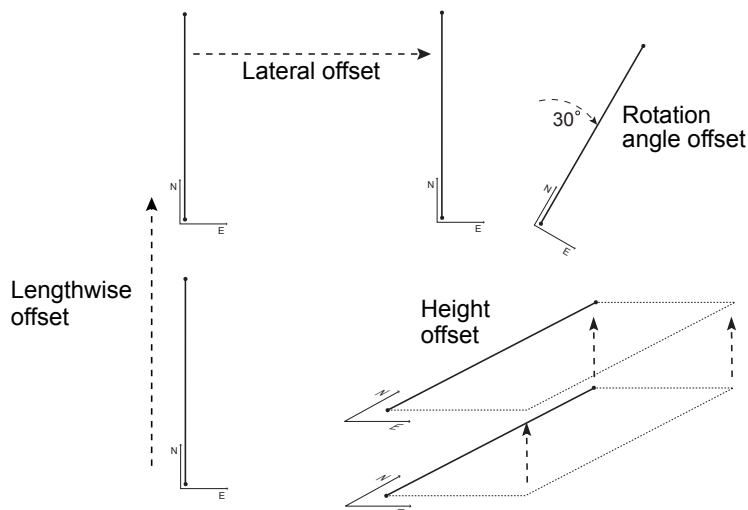

1. Select "Point" in <Set-out line>

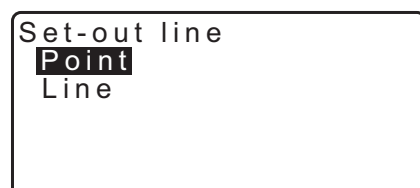

2. Press **[OFFSET]** to display <Baseline offset>.

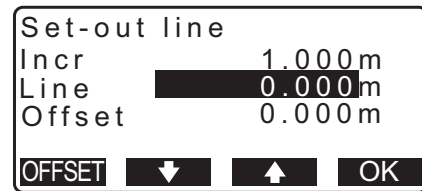

3. Set the following items.

(1) Incr: Increment by which offsets can be decreased/ increased using the arrow softkeys.

(2) Length: Lengthwise offset

(3) Lateral: Lateral offset

(4) Height: Elevation offset

(5) Rt.ang: Rotation angle offset

• **[↓]/[↑]**: Press to decrease/increase the value by the amount set in "Incr".

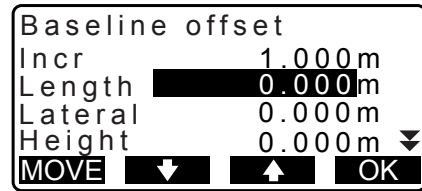

4. Press **[OK]** to return to the screen in step 2.

• **[MOVE]**: Permanently moves the baseline coordinates by the amount set in <Baseline offset>.

5. Press **[OK]** on the screen of step 2. The coordinate value of the required point is calculated, taking into account the movement of the baseline, and displayed.

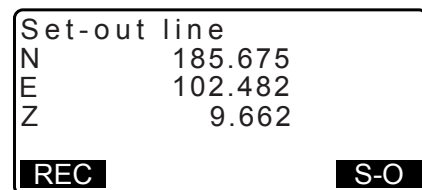

### 16.3 Setting-out Line Line

Setting-out line line measurement tells how far horizontally the measured point is from the baseline and how far vertically the measured point is from the connected line. The baseline can be offset in a horizontal direction if necessary.

• Before performing setting-out line line, the baseline must be defined.

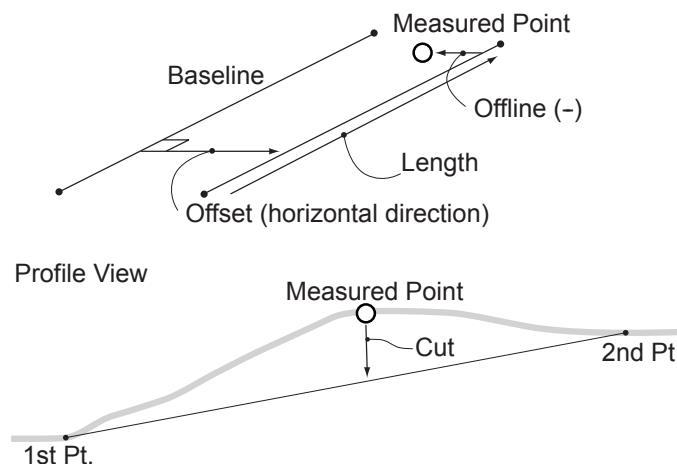

## PROCEDURE

1. Select "Line" in <Set-out line>.

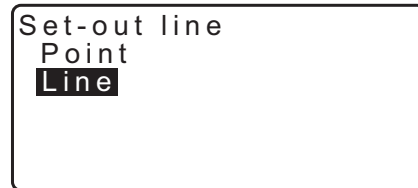

2. Enter the offset value.

- Offset: How much to move the baseline.  
A positive value indicates right side and a negative value indicates left side.
- When not setting offset value, go to step 3.

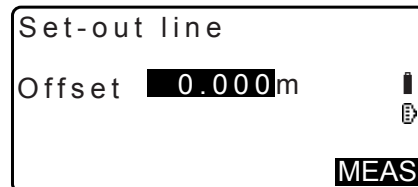

3. Sight the target and press **[MEAS]** on the screen of step 2. The measurement results are displayed on the screen. Press **[STOP]** to stop the measurement.

- The tilt screen is displayed if the instrument is out of level.  
Level the instrument.  
 "7.2 Levelling"

4. Press **[YES]** to use the measurement results. Displays the difference between the measured point and the baseline.

- Offline: A positive value indicates the point is on the right of the baseline and a negative value indicates it is on the left.
- "Cut" indicates that the point is below the baseline.
- "Fill" indicates that the point is above the baseline.
- Length: Distance along the baseline from the first point to the measured point.
- Press **[NO]** to observe the target again.

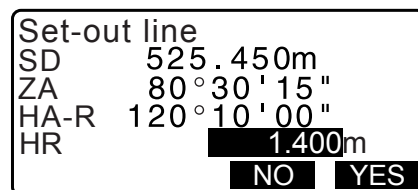

5. Sight the next target and press **[MEAS]** to continue the measurement.

- Press **[REC]**: records measurement results.  
 Recording method: "28. RECORDING DATA - TOPO MENU -"

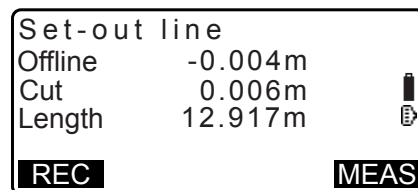



# 17.SETTING-OUT ARC

This mode allows the operator to define an arc from various arc parameters, such as From Pt. coordinates, and set out this arc as well as points (offsets) along it.

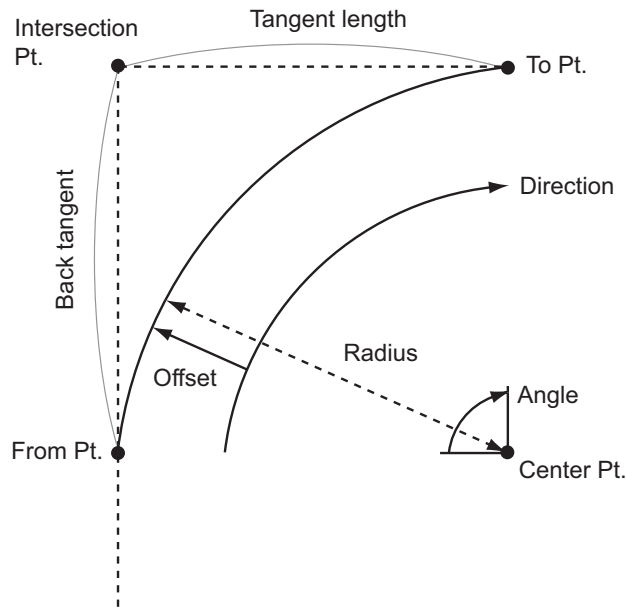

## 17.1 Defining an Arc

An arc can be defined by inputting arc parameters such as arc radius, angle, coordinates for the From point, Center point, To point etc. An arc can also be defined by observation of the From point, Center point, To point etc.

### PROCEDURE Defining by inputting coordinates

1. In the second page of the OBS mode screen, press **[MENU]**, then select "S-O arc".

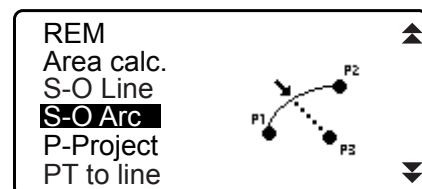

2. Enter the instrument station data.  
 ☞ "13.1 Entering Instrument Station Data and Azimuth Angle"

3. Select "Define arc" in <Set-out arc>.

- When **[LOAD]** is pressed, registered coordinates can be recalled and used.

- ☞ "13.1 Entering Instrument Station Data and Azimuth Angle PROCEDURE Reading in Registered Coordinate Data"

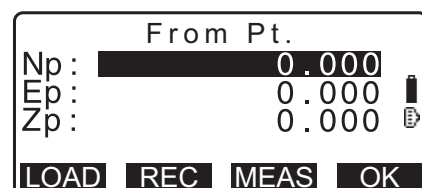
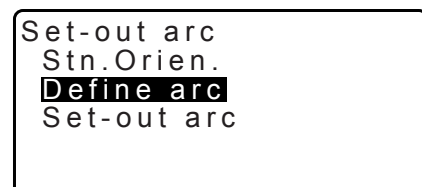

4. Enter the arc From point data and press **[OK]**.
5. Press **▶/◀** to select coordinates then press **[OK]**.

To : Enter arc To point.  
 To/Center : Enter arc To point and Center point.  
 To/Intersect : Enter arc To point and Intersect point  
 (intersection of the tangents).  
 Center : Enter arc Center point.  
 Intersect : Enter arc Intersect point.  
 Center/Intersect: Enter arc Center point and Intersect point  
 (intersection of the tangents).

6. Enter the coordinates specified in step 5.
7. Press **[OK]** to proceed to arc parameter input.

• When entering multiple coordinates, **[NEXT]** is displayed instead of **[OK]**. Press **[NEXT]** to input data for the next point.

8. Enter other arc parameters.
- (1) Direction (whether the arc turns right/left from the From point)
  - (2) Radius (radius of the arc)
  - (3) Angle (subtended angle)
  - (4) Arc (distance along the arc)
  - (5) Chord (straight line distance between the From and To points)
  - (6) Tan In (tangent length)
  - (7) Bk tan (back tangent length)



• Parameters that can be entered may be restricted depending on the coordinates specified in step 5.  
 ☞ "17.2 Specifying coordinates and curve parameters"

9. Enter curve parameters then press **{ENT}**. Other parameters will be calculated.
- **[TO]**: Calculated coordinates for To point can be recorded.
  - **[CENTER]**: Calculated coordinates for Center point can be recorded.
  - **[INTSCT]**: Calculated coordinates for Intersect point can be recorded.

10. Press **[OK]** on the screen of step 9 to define the arc. <Set-out arc> is displayed. Move to setting-out arc measurement.  
 ☞ "17.2 Setting-out Arc" step 2



- It is also possible to perform setting-out arc measurement by pressing **[S-O ARC]** when allocated to the OBS mode screen.
  - Allocating **[S-O ARC]**: "33.11 Allocating Key Functions"

### PROCEDURE Defining by observation

- In the second page of OBS mode screen, press **[MENU]**, then select "Set-out arc".
- Enter the instrument station data.
  - "13.1 Entering Instrument Station Data and Azimuth Angle"
- Select "Define arc" in <Set-out arc>.
- Sight the From point and press **[MEAS]**.

- Press **[STOP]** to stop the measurement.

From Pt.	
Np:	0.000
Ep:	0.000
Zp:	0.000
<b>LOAD REC MEAS OK</b>	

- The tilt screen is displayed if the instrument is out of level. Level the instrument.
  - "7.2 Levelling"

- Press **[OK]** to use the measurement results of the From point.

- Press **[MEAS]** to observe the first point again.
- Press **[HT]** to input instrument and target height.

Np:	113.464
Ep:	91.088
Zp:	12.122
ZA	90° 00' 00"
HA-R	120° 10' 00"
<b>REC HT MEAS OK</b>	

- Press **[▶]/[◀]** to select coordinates then press **[OK]**.

Select Pt.	
To	
<b>OK</b>	

- Sight the To/Center/Intersect point and press **[MEAS]**.

To Pt.	
Np:	0.000
Ep:	0.000
Zp:	0.000
<b>LOAD REC MEAS OK</b>	

- Press **[OK]** to use the measurement results of the To/Center/Intersect point.

- Press **[MEAS]** to observe the second point again.
- Press **[HT]** to input instrument and target height.
- When entering multiple points, **[NEXT]** is displayed instead of **[OK]**. Press **[NEXT]** to observe the next point.

Np:	113.464
Ep:	91.088
Zp:	12.122
ZA	90° 00' 00"
HA-R	120° 10' 00"
<b>REC HT MEAS OK</b>	

## 9. Enter other arc parameters.

- (1) Direction (whether the arc turns right/left from the From point)
- (2) Radius (radius of the arc)
- (3) Angle (subtended angle)
- (4) Arc (distance along the arc)
- (5) Chord (straight line distance between the From and To points)
- (6) Tan In (tangent length)
- (7) Bk tan (back tangent angle)



- Parameters that can be entered may be restricted depending on the coordinates specified in step 5.

"Specifying coordinates and curve parameters"

Direction:	Left
Radius:	<Null>
Angle :	<Null>
Arc :	<Null>
Chord :	141.421m
<b>OK</b>	

Tan In:	<Null>
Bk tan:	<Null>
<b>OK</b>	

10. Enter curve parameters then press **{ENT}**. Other parameters will be calculated.

- **[TO]**: Observation data for To point can be recorded.

Direction:	Right
Radius :	100.000m
Angle :	90°00'00"
Arc :	157.080m
Chord :	141.421m
<b>CENTER</b> <b>INTSCT</b> <b>OK</b>	

**[CENTER]**: Observation data for Center point can be recorded.

**[INTSCT]**: Observation data for Intersect point can be recorded.

11. Press **[OK]** on the screen of step 10 to define the arc. <Set-out arc> is displayed. Move to setting-out arc measurement.

"17.2 Setting-out Arc" step 2



- It is also possible to perform setting-out arc measurement by pressing **[S-O ARC]** when allocated to the OBS mode screen.

Allocating **[S-O ARC]**: "33.11 Allocating Key Functions"

### Specifying points and curve parameters

Parameters that can be entered may be restricted depending on the points specified in step 5/6. Parameters that can be entered are marked with a circle ( ○ ). Those that cannot are marked with a cross ( × ).

Parameters Set coord	Radius	Angle	Arc	Chord	Tan In	Bk tan	Direction
To pt Center pt	×	×	×	×	×	×	○
To pt Intersect pt	×	×	×	×	×	×	○
Center pt Intersect pt	×	×	×	×	×	×	○
To pt	○	○	○	×	○	○	○
Center pt	×	○	○	○	○	×	○
Intersect pt	○	○	×	○	×	×	○

### Precaution when performing setting-out arc

In the following cases parameters cannot be calculated:

$$\text{when Radius} < \frac{\text{Chord}}{2}$$

When Arc < Chord

When Tan In × 2 < Chord

When the included angle between the back tangent and the azimuth angle between the From Pt. and To Pt is 0°, or exceeds 180°.

## 17.2 Setting-out Arc

Setting-out arc measurement can be used to find the coordinates of required points along the arc by inputting the arc (or chord) length and offset based on the arc.

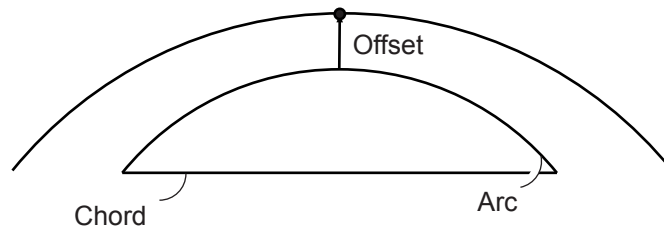

- Before performing setting-out arc, the arc must be defined.

### PROCEDURE

1. Select "Set-out arc" in <Set-out arc>.

```

Set-out arc
Stn.Orien.
Define arc
Set-out arc
  
```

2. Set the following items.

- (1) Incr: Increment by which values can be decreased/increased using the arrow softkeys.
- (2) Arc: Distance along the defined arc from the From point to the required point.
- (2)'Chord: Distance along the chord of the defined arc from the From point to the required point.
- (3) Offset: Distance from the required point to the position on a curve parallel to the original defined arc. A positive value indicates an offset arc to the right, and a negative value indicates an arc to the left.

- Press **[CHORD]** to switch to Chord input.
- **[↓]/[↑]**: Press to decrease/increase the value by the amount set in "Incr".

```

Set-out arc
Incr : 1.000m
Arc : 20.000m
Offset : 5.000m
P1
CHORD [↓] [↑] OK
  
```

3. Press **[OK]** on the screen of step 2. The coordinate value of the required point is calculated and displayed.

- **[REC]**: records the coordinate value as a known point data.
  - ☞ Recording method: "30.1 Registering/Deleting Known Point Data"
- Press **[S-O]** to move to setting-out measurement of the required point.
  - ☞ "15. SETTING-OUT MEASUREMENT"

```

Set-out arc
Incr : 1.000m
Chord : 0.000m
Offset : 0.000m
P1
ARC [↓] [↑] OK
  
```

```

Set-out arc
N 118.874
E 106.894
Z 12.546
REC S-O
  
```

4. Press **{ESC}**. Continue the measurement (repeat steps from 2).

## PROCEDURE Offsetting the arcline

The arcline can be offset in three dimensions using four methods: lateral offset, rotation angle offset, lengthwise offset, and height offset.

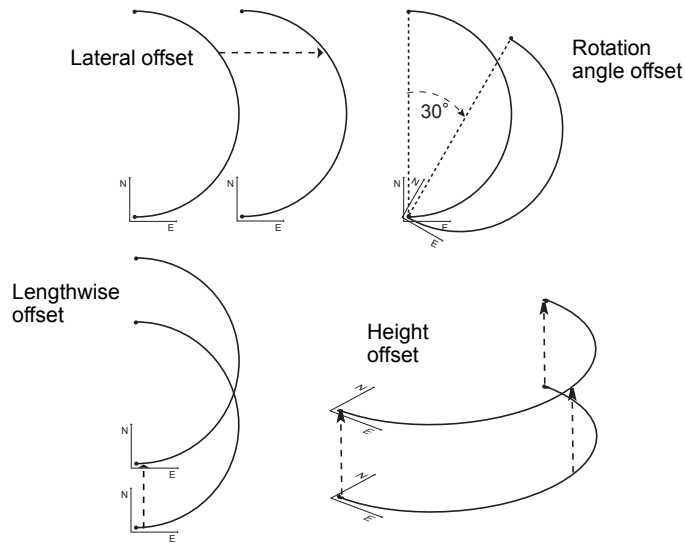

1. Select "Set-out arc" in <Set-out arc>.
2. Press **{FUNC}**, and then press **[OFFSET]** to display <Arcline offset>.

```

Set-out arc
Incr  : 1.000m
Arc    : 20.000m
Offset: 5.000m
                                P2
                                [OFFSET]
  
```

3. Set the following items.
  - (1) Incr: Increment by which offsets can be decreased/increased using the arrow softkeys.
  - (2) Length: Lengthwise offset
  - (3) Lateral: Lateral offset
  - (4) Height: Elevation offset
  - (5) Rt.ang: Rotation angle offset
  - **[↓]/[↑]**: Press to decrease/increase the value by the amount set in "Incr".

```

Arcline offset
Incr      1.000m
Length   0.000m
Lateral   0.000m
Height   0.000m
[MOVE] [↓] [↑] [OK]
  
```

```

Rt.ang 0.0000 [↑]
[MOVE] [OK]
  
```

4. Press **[OK]** to return to the screen in step 2.
  - **[MOVE]**: Permanently moves the baseline coordinates by the amount set in <Arcline offset>.

5. Press **[OK]** on the screen of step 2. The coordinate value of the required point is calculated, taking into account the movement of the arcline, and displayed.

```

Set-out arc
N      118.874
E      106.894
Z      12.546
[REC] [S-O]
  
```

# 18.POINT PROJECTION

Point projection is used for projecting a point onto the baseline. The point to project can be either measured or input. Displays the distances from the first point and point to project to the position at which a line extending from point to project intersects the baseline at right angles.

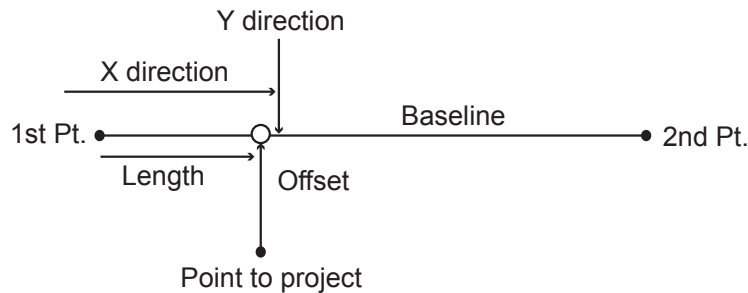

## 18.1 Defining Baseline

- Defined baseline can be used in both setting-out line measurement and point projection.

### PROCEDURE

1. In the second page of OBS mode screen, press **[MENU]**, then select "P-Project".

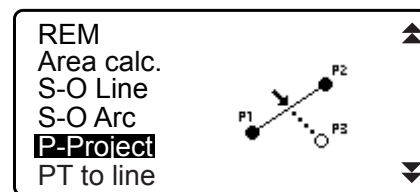

2. Enter the instrument station data then define the baseline.  
☞ "16.1 Defining Baseline" step 2 to 12

3. Press **[OK]** to define the baseline. <Point projection> is displayed. Move to point projection measurement.

☞ "18.2 Point Projection"

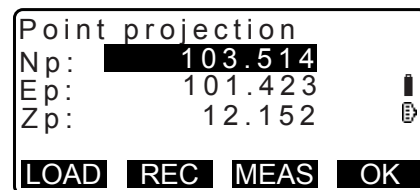

- It is also possible to perform point projection measurement by pressing **[P-PROJ]** when allocated to the OBS mode screen.

☞ Allocating the function key: "33.11 Allocating Key Functions"

## 18.2 Point Projection

Before performing point projection, the baseline must be defined.

### PROCEDURE

1. Define the baseline.

☞ "18.1 Defining Baseline"



2. Select "Point Projection" in <Point Projection>.

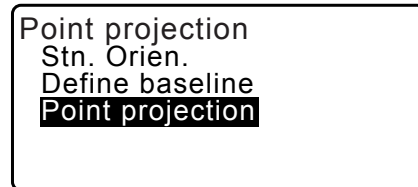

3. Enter the point coordinate.

- Press **[MEAS]** to observe the point to project.
- The tilt screen is displayed if the instrument is out of level. Level the instrument.

☞ "7.2 Levelling"

- Press **[REC]** to record the data as a known point.
- ☞ Recording method: "30.1 Registering/Deleting Known Point Data"

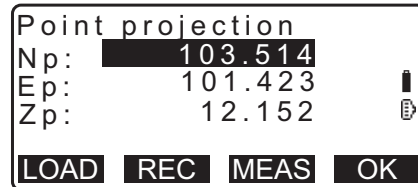

4. Press **[OK]** on the screen of step 3.

The following items are calculated and displayed.

- Length: Distance along the baseline from the first point to the projected point (X direction).

- Offset: Distance from point to project to the position at which a line extending from point of project intersects the baseline at right angles. (Y direction).
- d.Elev: Elevation between the baseline and the projected point.

- Press **[XYZ]** to switch the screen display to coordinate values.
- Press **[OFFSET]** to switch the screen display to distance values.
- Press **[REC]**: records the coordinate value as a known point data.
- ☞ Recording method: "30.1 Registering/Deleting Known Point Data"

- Press **[S-O]** to move to setting-out measurement of the projected point.

☞ "15. SETTING-OUT MEASUREMENT"

5. Press **{ESC}**. Continue the measurement (repeat steps from 3).

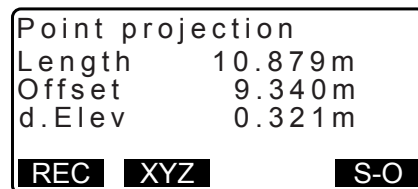

# 19. TOPOGRAPHY OBSERVATION

In topography observation, the instrument observes each target point once, clockwise from the backsight direction and record the observed data. It is also possible to conduct topography RL observation which observes the target point once from each of the "Right" and the "Left" of the scope.

## Topography observation

Order of observation

- (1) R1
- (2) R2
- (3) R3

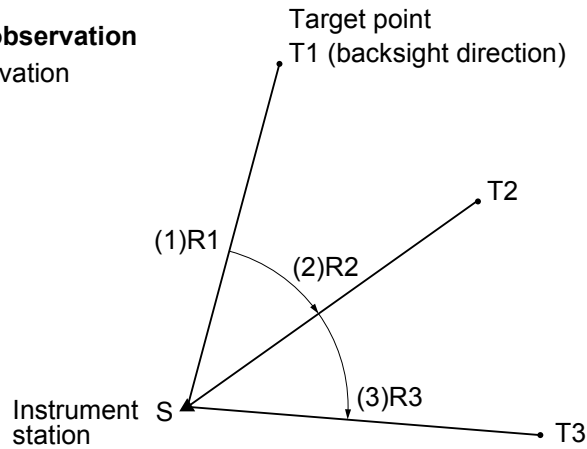

## Topography RL observation

Order of observation

- (1) R1
- (2) L1
- (3) R2
- (4) L2
- (5) R3
- (6) L3

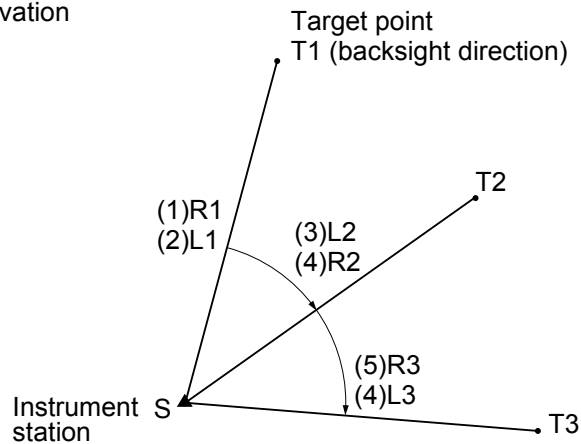

The flow of topography observation is as follows:

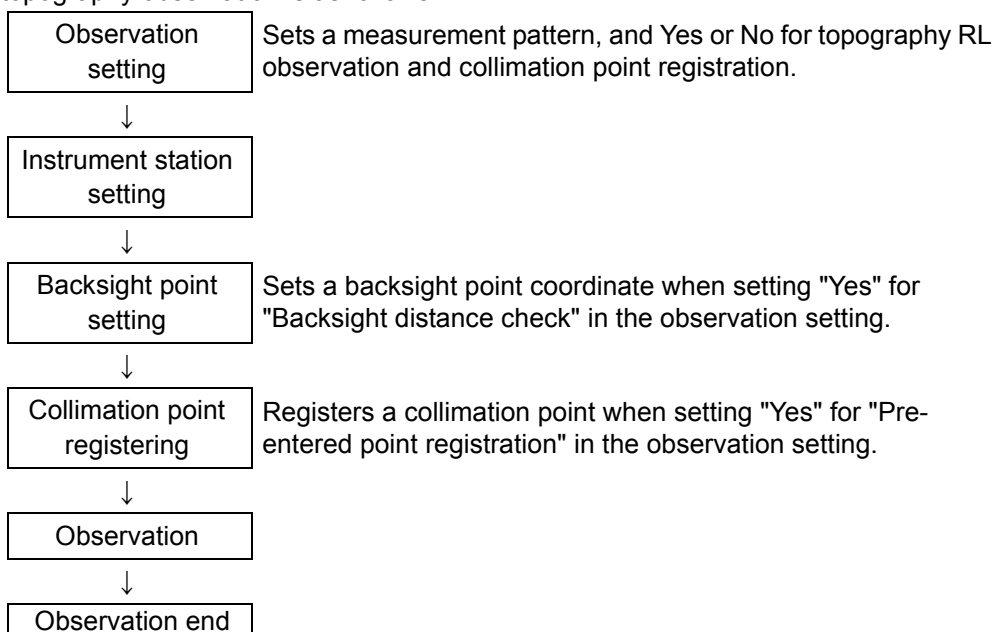

## 19.1 Observation Setting

Perform observation setting prior to topography observation.

- Up to 40 collimation points can be registered.
- It is possible to register up to 8 combination patterns for the number of distance sets, the number of distance readings, Yes or No for RL observation, pre-entered point registration, backsight distance measurement and backsight distance check.

### PROCEDURE

1. Enter the topography observation menu screen.  
On the second page of the OBS mode, press **[Menu]**, then select "Topography".

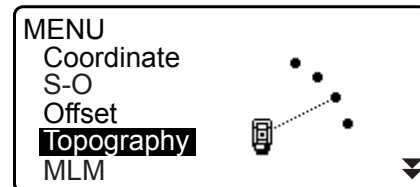

2. Set for topography observation.  
Set the following items:
  - (1) Number of distance sets (No. of SETs)
  - (2) Number of distance readings (No. of Obs)
  - (3) RL observation (F1/F2 Obs)
  - (4) Pre-entered point registration (PreenterPt)
  - (5) Backsight distance measurement (BS Obs-Dist)
  - (6) Backsight distance check (BS DistCheck)

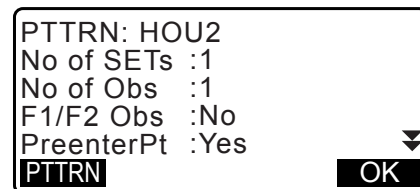

- Press **[PTTRN]** to register the combination of settings as a pattern or to read the registered patterns.
- Position the cursor and press **[REC]** to register the currently-set pattern.

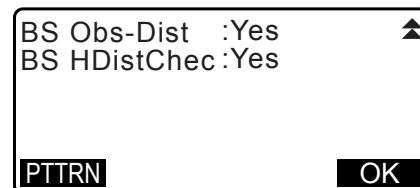

3. Press **[OK]** to confirm the setting.

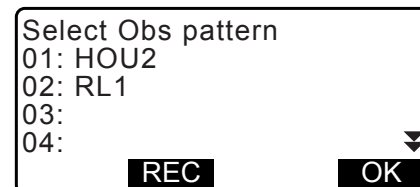

4. Enter the instrument station data.  
Press **[OK]** to confirm the entered data.  
☞ "28.1 Recording Instrument Station Data"

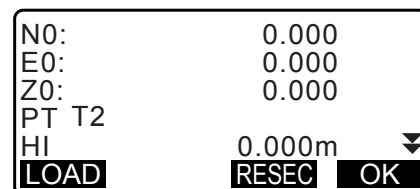

- Press **[RESEC]** allows you to set only the instrument station by resection measurement.  
☞ "13.2 Setting Instrument Station Coordinate with resection measurement"

5. Enter backsight point coordinates.  
Enter the coordinates for the backsight point and press **[OK]**.  
If "No" is set for (5) Backsight distance measurement (BS Obs-Dist) or (6) Backsight distance check (BS DistCheck) in the observation setting, this screen is not displayed.

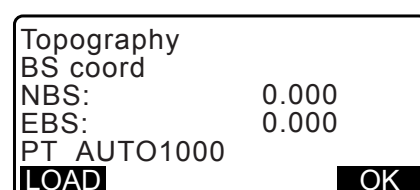

## 6. Register collimation point.

Set the name for the collimation point in advance. Press **[ADD]**, enter the point name and press **[OK]** to register. After registering the point to be measured, press **[OK]** to move to measurement.

 "19.2 Observation"

```

PreenterPt
01: T-1
02: T-3
03:
04:
ADD DEL EDIT OK
  
```

If "No" is set for (4) Pre-entered point registration (PreenterPt) in the observation setting, this screen is not displayed.

```

PreenterPt
PT T-4
  
```

- Pressing **[DEL]** deletes the selected point.
- Pressing **[EDIT]** enables to change the name of the selected point.

 Note

- Pressing **[TOPO II]** in the OBS mode also enables the same procedure.
  -  **[TOPO II]** allocation: "33.11 Allocating Key Functions"
- Number of characters, range and choices of the setting are as follows (\*is the default setting):
  - Number of distance sets: 1 \* /2
  - Number of distance readings: 1 \* (Fixed)
  - RL observation: Yes / No \*
  - Pre-entered point registration: Yes / No \*
  - Backsight distance measurement (BS Obs-Dist): Yes (the distance is to be measured in the backsight direction) / No (only the angle is measured in the backsight direction) \*
  - Backsight distance check (BS DistCheck): Yes (Compares the backsight point coordinate and the measured value for the backsight point) / No \*
  - If "No" is set for "RL observation", "number of distance sets" is fixed at "1".
  - If "Yes" is set for "RL observation", a choice for the "number of distance sets" is 1\* / 2.
  - "BS DistCheck" is set only when "Yes" is set for "BS Obs-Dist".

## 19.2 Observation

Begin topography observation according to the setting specified in "19.1 Observation Setting".

### PROCEDURE Topography Observation

1. Perform observation setting following steps 1 to 6 in the "19.1 Observation Setting".

2. Measure the first direction.

Collimate the first target. Press **[ANGLE]** or **[MEAS]** to start measuring. In "D=", the setting value for the Number of distance readings (No. of Obs) is displayed.

- Target height, point name and code can be entered before the measurement.
- If "No" is set for (5) Backsight distance measurement (BS Obs-Dist), **[MEAS]** is not displayed on the Topography screen.
- If "Yes" is set for (6) Backsight distance check (BS DistCheck), the variance for horizontal distance between the calculated value and the measured value is displayed after the measurement of the first point has been completed.
- Pressing **{ESC}** cancels the topography observation after checking is completed.

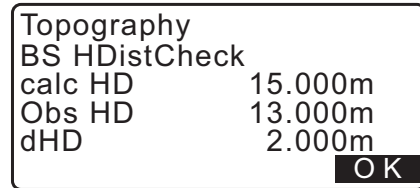
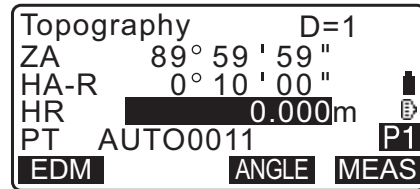

3. Record measured data.

If a target height and code have not been set, enter the data here.

Press **[OK]** to save the data. The screen for step 2 is displayed to measure the next point.

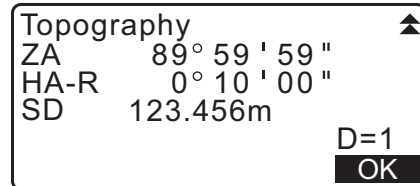
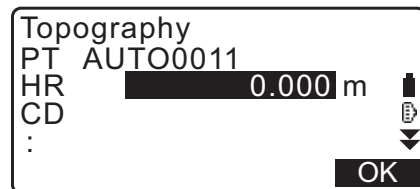

During the measurement for the second point and thereafter, if: (1) Number of distance sets (No. of SETs) is set to "1"; (2) Number of distance readings (No. of Obs) is set to "1"; and (3) RL observation (F1/F2 Obs) is set to "No"; **[OFFSET]** is displayed. Pressing **[OFFSET]** enables offset measurement of the target point.

**[F1]** "20. OFFSET MEASUREMENT"

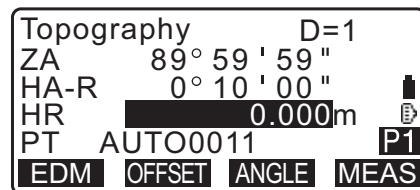

4. End topography observation measurement.

After completing the observation, pressing **{ESC}** displays the completion confirmation message. Press **[YES]** to record the topography observation.

- When the collimation point is registered, this message does not appear.

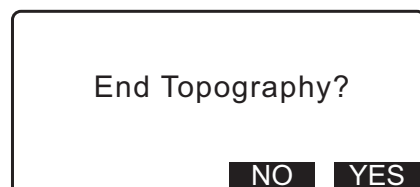

**PROCEDURE Topography RL Observation**

1. Perform observation setting following procedures 1~6 in the "19.1 Observation Setting".  
Set "YES" for "RL observation" in the observation setting.

2. Measure the target point in the R direction.  
 "R" appears next to the "Topography observation (Topography)"  
 ☞ "PROCEDURE Topography Observation" step 2

```

Topography R D=2
ZA      89° 59' 59"
HA-R    0° 10' 00"
HR      ██████████ 0.000m
PT      AUTO0011 P1
EDM     ANGLE MEAS
  
```

3. Record the measured data.  
 ☞ "PROCEDURE Topography Observation" step 3

4. Measure the target point in the L direction.  
 "L" appears next to the "Topography observation (Topography)." Record the measured data after the observation is completed.  
 ☞ Steps 2 to 3

```

Topography L D=2
ZA      270° 00' 00"
HA-R    180° 10' 00"
HR      ██████████ 0.000m
PT      AUTO0011 P1
EDM     ANGLE MEAS
  
```

5. End the topography observation.  
 ☞ "PROCEDURE Topography Observation" step 4

**Note**

- In the screen displaying **[MEAS]**, pressing **{ENT}** in the same manner as pressing **[MEAS]**.
- When "No" is set for "Pre-entered point registration (PreenterPt)", the point name must be entered in the screen recording measured data.
- In the screen recording measured data, items displayed vary according to the observation setting.

# 20.OFFSET MEASUREMENT

Offset measurements are performed in order to find a point where a target cannot be installed directly or to find the distance and angle to a point which cannot be sighted.

- It is possible to find the distance and angle to a point you wish to measure (target point) by installing the target at a location (offset point) a little distance from the target point and measuring the distance and angle from the survey point to the offset point.
- The target point can be found in the five ways explained below.

## 20.1 Single-distance Offset Measurement

Finding it by entering the horizontal distance from the target point to the offset point.

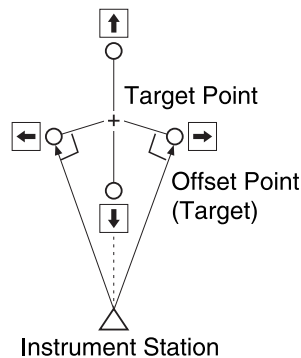

- When the offset point is positioned to the left or right of the target point, make sure the angle formed by lines connecting the offset point to the target point and to the instrument station is almost 90°.
- When the offset point is positioned in front of or behind the target point, install the offset point on a line linking the instrument station with the target point.

### PROCEDURE

1. Set the offset point close to the target point and measure the distance between them, then set up a prism on the offset point.
2. Enter the instrument station data.  
☞ "13.1 Entering Instrument Station Data and Azimuth Angle"

3. Press **[OFFSET]** in page three of OBS mode to display <Offset>.

4. Select "Offset/Dis".

- The tilt screen is displayed if the instrument is out of level. Level the instrument.

☞ "7.2 Levelling"

5. Sight the offset point and press **[MEAS]** in the first page of the OBS mode screen to begin measurement. The measurement results are displayed. Press **[STOP]** to stop the measurement.

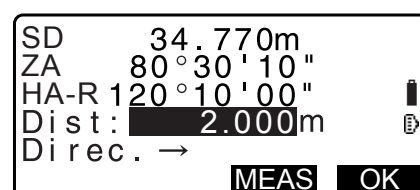

6. Input the following items.  
 (1) Horizontal distance from the target point to the offset point.  
 (2) Direction of the offset point.

- Direction of offset point
  - ← : On the left of the target point.
  - : On the right of the target point.
  - ↓ : Closer than the target point.
  - ↑ : Beyond the target point.
- Press **[MEAS]** to re-observe the offset point.

7. Press **[OK]** on the screen of step 5 to calculate and display the distance and angle of the target point.

Offset Dist	
SD	34.980m
ZA	85°50'30"
HA-R	125°30'20"
<b>REC</b>	<b>XYZ</b> <b>NO</b> <b>YES</b>

8. Press **[YES]** to return to <Offset>.

- Press **[XYZ]** to switch the screen display from distance values to coordinate values. Press **[HVD]** to return to distance values.
- Press **[NO]** to return to the previous distance and angle.
- To record the calculation result, press **[REC]**.  
 ☞ "28. RECORDING DATA - TOPO MENU -"

## 20.2 Angle Offset Measurement

Sighting the direction of the target point to find it from the included angle.

Install offset points for the target point on the right and left sides of and as close as possible to the target point and measure the distance to the offset points and the horizontal angle of the target point.

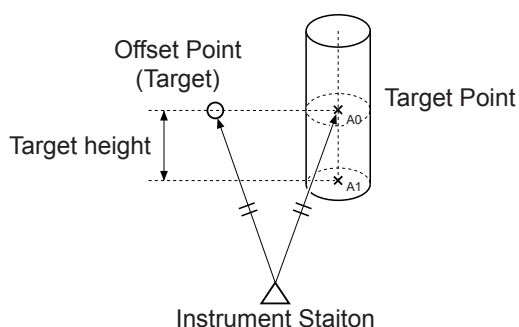

- During collimation of the measured point A0, the vertical angle can be fixed at the prism position or set to be moved according to the upward/downward movement of the telescope.
- If the vertical angle is set to be moved according to the movement of the telescope, slope distance (SD), vertical direction (VD), Z coordinate (Z) vary depending on the collimation height.



## PROCEDURE

1. Set the offset points close to the target point (making sure the distance from the instrument station to the target point and the height of the offset points and the target point are the same), then use the offset points as the target.

2. Enter the instrument station data.

 "13.1 Entering Instrument Station Data and Azimuth Angle"

- When directly calculating A1, the ground-level coordinate of the measured position A0:

Set the instrument and collimation heights.

- When calculating the coordinate of the measured position A0:

Set the instrument height only. (Leave the collimation height at 0.)

3. Press **[OFFSET]** in page three of OBS mode to display <Offset>.

4. Select "OffsetAng." in <Offset>.

- The tilt screen is displayed if the instrument is out of level. Level the instrument.

 "7.2 Levelling"



5. Sight the offset point and press **[MEAS]** in the first page of the OBS mode screen to begin measurement.

The measurement results are displayed. Press **[STOP]** to stop the measurement.

6. Accurately sight the direction of the target point and press **[OK]**.

The distance and angle of the target point are displayed.

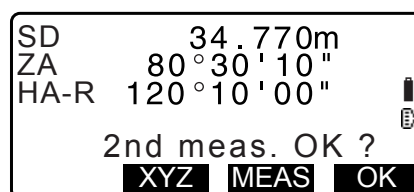

7. After finishing measurement, press **[YES]** to return to <Offset>.

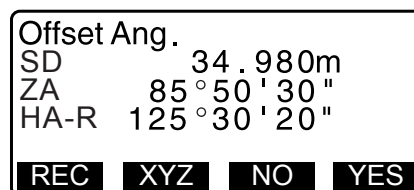

### 20.3 Two-distance Offset Measurement

By measuring the distances between the target point and the two offset points.

Install two offset points (1st target and 2nd target) on a straight line from the target point, observe the 1st target and 2nd target, then enter the distance between the 2nd target and the target point to find the target point.

- It is possible to make this measurement easily using the optional equipment: the 2-point target (2RT500-K). When using this 2-point target, be sure to set prism constant to 0.  
 "7.2 Levelling"

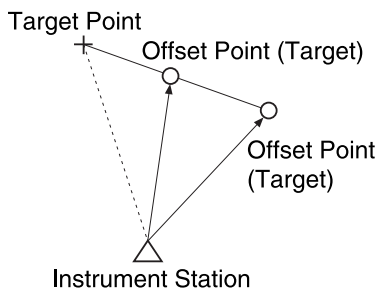

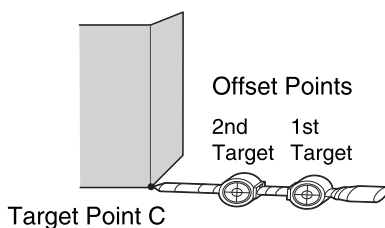

How to use 2-point target (2RT500-K)



- Install the 2-point target with its tip at the target point.
- Face the targets toward the instrument.
- Measure the distance from the target point to the 2nd target.
- Set the reflector type to "sheet".

**PROCEDURE**

- Install two offset points (1st target, 2nd target) on a straight line from the target point and use the offset points as the target.
- Press **[OFFSET]** in page three of OBS mode to display <Offset>.
- Enter the instrument station data.  
 "13.1 Entering Instrument Station Data and Azimuth Angle"
- Select "Offset/2D" in <Offset>.

- The tilt screen is displayed if the instrument is out of level. Level the instrument.  
 "7.2 Levelling"

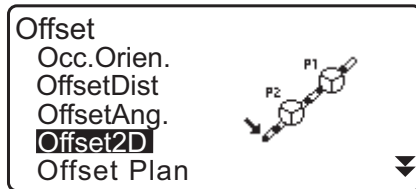

- Sight the 1st target and press **[MEAS]**. Observation begins and the measurement results are displayed. Press **[YES]**. The "2nd Target Observation Screen" is displayed.

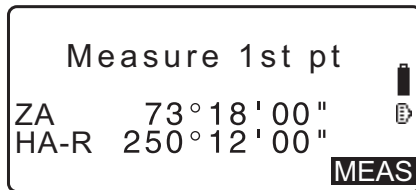

6. Sight the 2nd target and press **[MEAS]**.  
The measurement results are displayed. Press **[YES]**.

N	10.480
E	20.693
Z	15.277
Confirm?	<b>NO</b> <b>YES</b>

7. Enter the distance from the 2nd target to the target point and press **[ENT]**. The coordinates of the target point are displayed.

B-C:	<b>1.2000</b> m
------	-----------------

Offset 2D	
N	10.480
E	20.693
Z	15.277
<b>REC</b>	<b>HVD</b> <b>NO</b> <b>YES</b>

8. Press **[YES]**. <Offset> is restored.

- When **[HVD]** is pressed, display mode is switched from coordinates to SD, ZA, HA-R.

## 20.4 Plane Offset Measurement

Find distance and coordinate of a edge of a plane where direct measuring can not be done.  
Measure three random prism points to define the plane then sight the target point (P0) to calculate distance and coordinate of the cross point between telescope axis and of the defined plane.

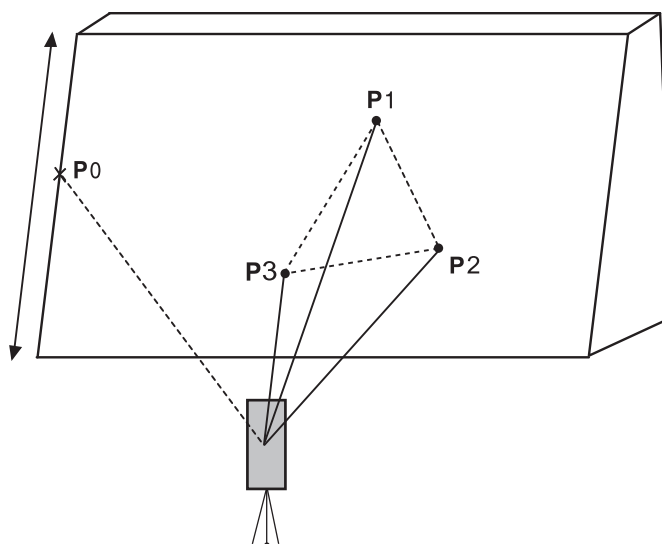

- Target height of P1 to P3 is set to 0 automatically.

### PROCEDURE

1. Enter the instrument station data.  
☞ "13.1 Entering Instrument Station Data and Azimuth Angle"

2. Press **[OFFSET]** in page three of OBS mode to display <Offset>.

3. Select "Offset Plan" in <Offset>.

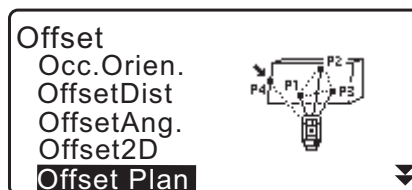

4. Sight the first point (P1) on the plane and press **[MEAS]** to begin measurement.

The measurement results are displayed. Press **[YES]**.

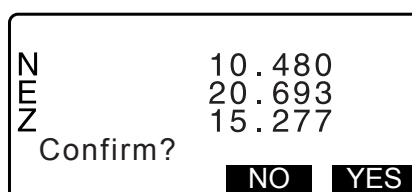
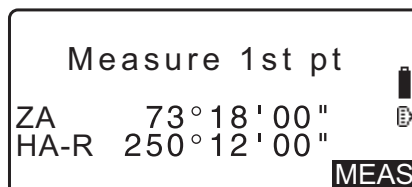

5. Sight the second point (P2) and the third point (P3) on the plane and press **[MEAS]**.

The measurement results are displayed. Press **[YES]** to define the plane.

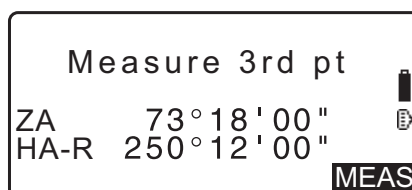

6. Accurately sight the direction of the target point.

The distance and angle of the target point are displayed.

- When **[HVD]** is pressed, display mode is switched from coordinates to SD, ZA, HA-R.

- To record the calculation result, press **[REC]**.

☞ "28. RECORDING DATA - TOPO MENU -"

Sight the next target point.

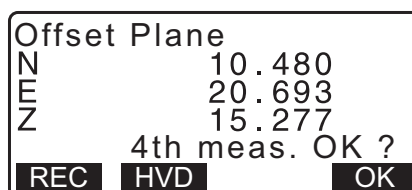

7. After finishing measurement, press **[OK]** in the screen of step 6 to return to <Offset>.

## 20.5 Column Offset Measurement

Find distance and coordinates of the center of the column.

If circumscription point (P1) and two circumscription points (P2, P3) of a column can be measured directly, the distance to the center of the column (P0), coordinates and azimuth angle are calculated and displayed.

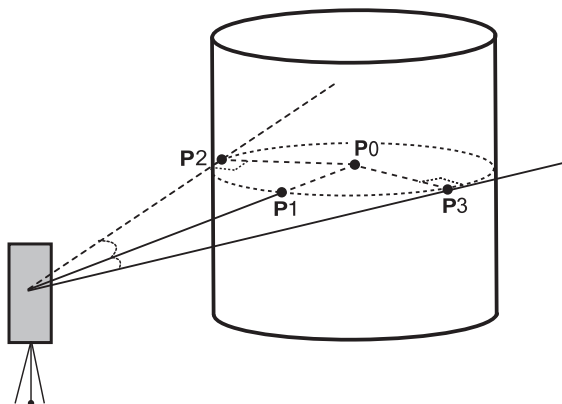

- The azimuth angle of the center of the column is 1/2 of total azimuth angle of circumscription points (P2) and (P3).

### PROCEDURE

- Enter the instrument station data.  
 ↳ "13.1 Entering Instrument Station Data and Azimuth Angle"
- Press **[OFFSET]** in page three of OBS mode to display <Offset>.
- Select "Offset Clum" in <Offset>.
- Sight the circumscription point (P1) and press **[MEAS]** to begin measurement.  
 The measurement results are displayed. Press **[YES]**.
  - When **[HVD]** is pressed, display mode is switched from coordinates to SD, ZA, HA-R.
- Sight the left circumscription point (P2) and press **[OK]**.

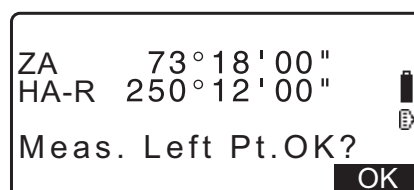
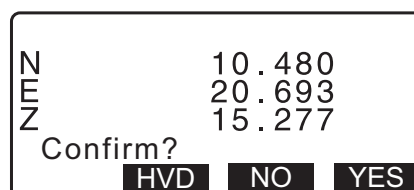
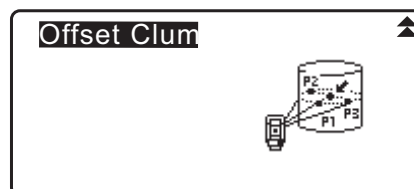

6. Sight the right circumscription point (P3) and press **[OK]**.

ZA	73°18'00"	🔋 📄
HA-R	250°12'00"	
Meas. Right Pt. OK?		
<b>OK</b>		

7. The coordinates of the target point (the center of the column P0) are displayed. Press **[REC]** to record the calculation result.

Press **[OK]** in the recording screen to return to <Offset>.

- Press **[YES]** to return to <Offset> without recording the calculation result.

- Press **[NO]** to return to step 3.

Offset Clum			
N	10.480		
E	20.693		
Z	15.277		
<b>REC</b>	<b>HVD</b>	<b>NO</b>	<b>YES</b>

# 21.MISSING LINE MEASUREMENT

Missing line measurement is used to measure the slope distance, horizontal distance, and horizontal angle to a target from the target which is the reference (starting point) without moving the instrument.

- It is possible to change the last measured point to the next starting position.
- Measurement result can be displayed as the gradient between two points.

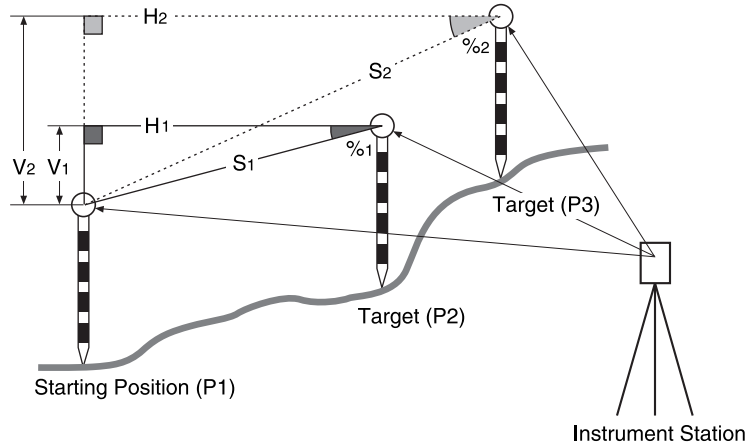

## 21.1 Measuring the Distance between 2 or more Points

The distance between two or more points can either be measured by observing the targets in question or calculating from input coordinates. A combination of these two methods (e.g. observing the 1st target and inputting 2nd target coordinates) is also possible.

### PROCEDURE Measuring using observation

1. In the third page of OBS mode screen, press **[MLM]**, then select "MLM".

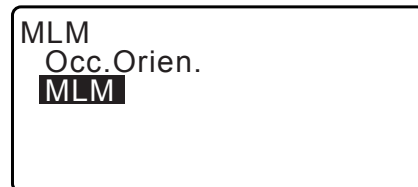

2. Sight the 1st target and press **[MEAS]**.

- If the distance measurement data remains, the last measured distance data is set as the starting point, and the screen in step 3 is displayed.

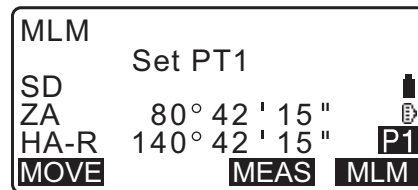

- The tilt screen is displayed if the instrument is out of level. Level the instrument.  
 "7.2 Levelling"

3. Sight the second target and press **[MLM]** to begin observation.

- **[REC]**: records 1st target measurement results.

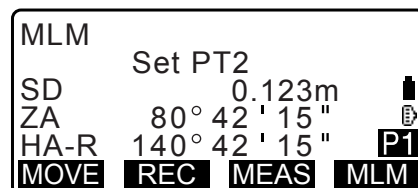

The following values are displayed:

SD: Slope distance of the starting position and 2nd target.

HD: Horizontal distance of the starting position and 2nd position.

VD: Height difference of the starting position and 2nd target.

- Target height of the starting position and 2nd target can be input.

Press **[Tgt.h]** on the second page.

Input the target heights and press **[OK]**.

- Press **[COORD]** to input coordinates.

"PROCEDURE Calculating from input coordinates"

- Pressing **[REC]** displays the screen shown in right.

Pressing **[OK]** records the measured results for the second point.

Press **[OK]** to record missing line measurement results and return to the results screen.

Press **{ESC}** to continue measurement without saving 2nd target or missing line measurement results.



- Missing line measurement results cannot be recorded when point names for 1st and/or 2nd target are null. Always input point names for both targets.

4. Sight the next target and press **[MLM]** to begin observation. Slope distance, horizontal distance and height difference between multiple points and the starting position can be measured this way.

- When **[S/%]** is pressed, the distance between two points (S) is displayed as the gradient between two points.

- Press **[MEAS]** to re-observe the starting position. Sight the starting position and press **[MEAS]**.

MLM		
SD	20.757m	
HD	27.345m	
VD	1.012m	P1
<b>MOVE</b>	<b>REC</b>	<b>MEAS</b> <b>MLM</b>

MLM		
SD	20.757m	
HD	27.345m	
VD	1.012m	P2
<b>COORD</b>	<b>S/%</b>	<b>Tgt.h</b>

Target height		
PT 1	<input type="text" value="1.500m"/>	
PT 2	<input type="text" value="1.500m"/>	
		<b>OK</b>

N	10.000	
E	20.000	
Z	30.000	
HR	<input type="text" value="1.500m"/>	
PT	1010	
		<b>OK</b>

HD	27.345m	
VD	1.012m	A
PT1		2
PT2		3
CD	<input type="text" value="1010"/>	
<b>ADD</b>	<b>LIST</b>	<b>SRCH</b> <b>OK</b>

MLM		
SD	20.757m	
HD	27.345m	
VD	1.012m	P1
<b>MOVE</b>	<b>REC</b>	<b>MEAS</b> <b>MLM</b>



- When **[MOVE]** is pressed, the last target measured becomes the new starting position to perform missing line measurement of the next target.

☞ "21.2 Changing the Starting Point"

5. Press **{ESC}** to end missing line measurement.

### PROCEDURE Calculating from input coordinates

1. In the third page of OBS mode screen, press **[MLM]**, then select "MLM".

2. Press **[COORD]** on the second page.

3. Input coordinates for the 1st target and press **[OK]**.
  - When you wish to read in and set coordinate data from memory, press **[LOAD]**.

☞ "13.1 Entering Instrument Station Data and Azimuth Angle PROCEDURE Reading in Registered Coordinate Data"

4. Select "PT2" and press **{ENT}** to proceed to 2nd target input.

5. Input coordinates for the 2nd target and press **[OK]**.  
The following values are displayed:  
SD: Slope distance of the starting position and 2nd target.  
HD: Horizontal distance of the starting position and 2nd position.  
VD: Height difference of the starting position and 2nd target.

- Target height of the starting position and 2nd target can be input.

Press **[Tgt.h]** on the second page.

Input the target heights and press **[OK]**.

- Press **[COORD]** to re-input coordinates for the first or 2nd targets.
- Pressing **[REC]** displays the result recording screen for missing line measurement. Pressing **[OK]** records the measured results.

- When **[S/%]** is pressed, the distance between two points (S) is displayed as the gradient between two points.
- Press **[MEAS]** to observe the starting position.  
 [F] "PROCEDURE Measuring using observation"
- When **[MOVE]** is pressed, the last target measured becomes the new starting position to perform missing line measurement of the next target.  
 [F] "21.2 Changing the Starting Point"

6. Press **{ESC}** to end missing line measurement



- Missing line measurement results cannot be recorded when point names for 1st and/or 2nd target are null. Always input point names for both targets.

## 21.2 Changing the Starting Point

It is possible to change the last measured point to the next starting position.

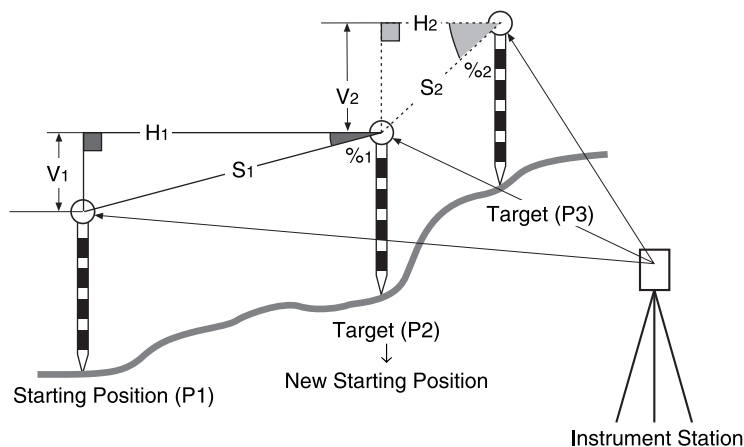

### PROCEDURE

1. Observe the starting position and target.  
 [F] "21.1 Measuring the Distance between 2 or more Points"
2. After measuring the targets, press **[MOVE]**.  
 Press **[YES]**.
  - Press **[NO]** to cancel measurement.

MLM		
SD	20.757m	
HD	27.345m	
VD	1.012m	<b>P1</b>
<b>MOVE</b>	<b>REC</b>	<b>MEAS</b> <b>MLM</b>

MLM		
Move 1st meas ?		
SD	34.980m	
ZA	85°50'30"	
HA-R	125°30'20"	
		<b>NO</b> <b>YES</b>

3. The last target measured is changed to the new starting position.  
Perform missing line measurement.  
☞ "21.1 Measuring the Distance between 2 or more Points".

# 22.SURFACE AREA CALCULATION

You can calculate the area of land (slope area and horizontal area) enclosed by three or more known points on a line by inputting the coordinates of the points.

**Input**

Coordinates : P1 (N1, E1, Z1)  
 ...  
 P5 (N5, E5, Z5)

**Output**

Surface area: S (slope area and horizontal area)

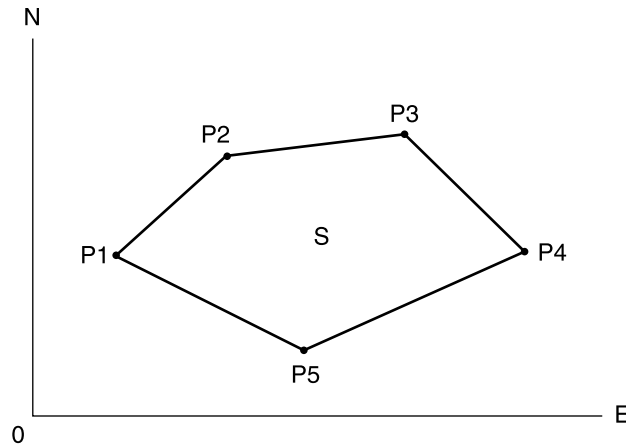

- Number of specified coordinate points: 3 or more, 50 or less
- Surface area is calculated by observing the points on a line enclosing an area in order or reading in the previously registered coordinates in order.



- If two or less points are used to measure an area, an error will occur.
- Be sure to observe (or recall) points on an enclosed area in a clockwise or counterclockwise direction. For example, the area specified by entering (or recalling) point names 1, 2, 3, 4, 5 or 5, 4, 3, 2, 1 implies the same shape. However, if points are not entered in numerical order, the surface area will not be calculated correctly.



**Slope area**

The first three points specified (measured/read-in) are used to create the surface of the slope area. Subsequent points are projected vertically onto this surface and the slope area calculated.

**PROCEDURE Surface area calculation by observing points**

1. In the second OBS mode screen, press **[MENU]**, then select "Area calc."

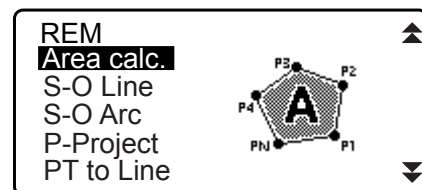

2. Enter the instrument station data.  
 [F] "13.1 Entering Instrument Station Data and Azimuth Angle"

3. Select "Area calculation" in <Area calculation>.

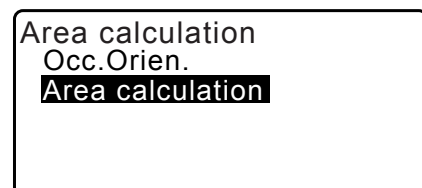

4. Sight the first point on the line enclosing the area, and press **[OBS]**.

- The tilt screen is displayed if the instrument is out of level. Level the instrument.  
 "7.2 Levelling"

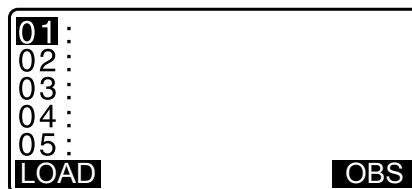

5. Press **[MEAS]** to begin observation. The measured values are displayed.

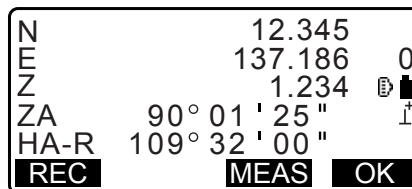

6. Press **[OK]** to enter the value of the first point in "01".  
 • Press **[REC]** in the second screen of step 5 to record code, target height, and point name. The point name recorded here will be displayed in "01".

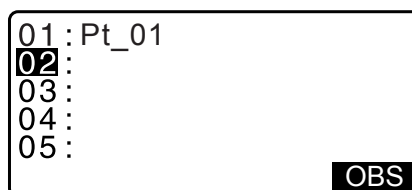

7. Repeat steps 4 to 6 until all points have been measured. Points on an enclosed area are observed in a clockwise or counterclockwise direction. For example, the area specified by entering point names 1, 2, 3, 4, 5 or 5, 4, 3, 2, 1 implies the same shape. After all known points necessary to calculate the surface area have been observed, **[CALC]** is displayed.

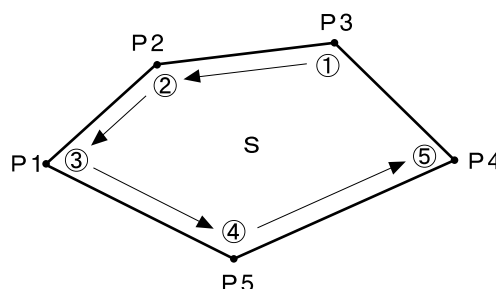

8. Press **[CALC]** to display the calculated area.  
 PT : number of set points  
 SArea : slope area  
 HArea : horizontal area

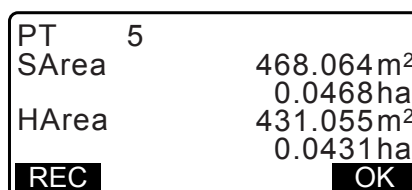
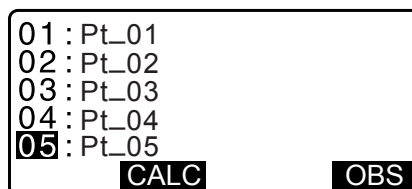

9. Press **[REC]** in the screen of step 8 to record results and return to <Menu>. Press **[OK]** to return to <Menu> without recording results.

**PROCEDURE Surface area calculation by reading in the points' coordinates**

1. In the second OBS mode screen, press **[MENU]**, then select "Area calc."
2. Enter the instrument station data.
3. Select "Area calculation" in <Area calculation>.

4. Press **[LOAD]** to display the list of coordinate data.  
 PT :Known point data saved in the current JOB or in the Coordinate Search JOB.  
 Crd./ Occ :Coordinate data saved in the current JOB or in the Coordinate Search JOB.

```

01 : Pt_01
02 :
03 :
04 :
05 :
LOAD OBS

```

5. Select the first point in the list and press **{ENT}**.  
 The coordinates of the first point is set as "Pt.001".

```

Pt. Pt.001
Pt. Pt.002
Pt. Pt.004
Pt. Pt.101
Pt. Pt.102
↑↓·P FIRST LAST SRCH

```

6. Repeat steps 4 to 5 until all points have been read in.  
 Points on an enclosed area are read in a clockwise or counterclockwise direction.  
 After all known points necessary to calculate the surface area have been observed, **[CALC]** is displayed.

```

01 : Pt.004
02 :
03 :
04 :
05 :
LOAD

```

7. Press **[CALC]** to display the calculated area.

```

PT 3
SArea 468.064m²
      0.0468ha
HArea 431.055m²
      0.0431ha
REC OK

```

8. Press **[REC]** in the screen of Step 7 to record results and return to <Menu>.  
 Press **[OK]** to return to <Menu> without recording results.

**Note**

- It is also possible to perform area calculation by pressing **[AREA]** when allocated to the OBS mode screen.  
 ☞ Allocating **[AREA]**: "33.11 Allocating Key Functions"

# 23.INTERSECTIONS

The following two types of intersection calculation are available.

Select a suitable intersection type in advance.

Selecting an intersection type: "33.5 Observation Conditions - Other"

## Type A

Selectable calculation methods are as follows.

- |  |   |  |                             |
|--|---|--|-----------------------------|
|  | • 1 pt, Azimuth<br>"23.1.1 1 pt, Azimuth"               |  | • Extend<br>"23.1.5 Extend" |
|  | • 2 pt, Angle<br>"23.1.2 2 pt, Angle"                   |  | • Divide<br>"23.1.6 Divide" |
|  | • 4-Point Intersection<br>"23.1.3 4-Point Intersection" |  | • Pitch<br>"23.1.7 Pitch"   |
|  | • 2 Circles<br>"23.1.4 2 Circles"                       |  |                             |

## Type B

It is possible to find an intersection point between 2 reference points by specifying the length or azimuth angle of either point.

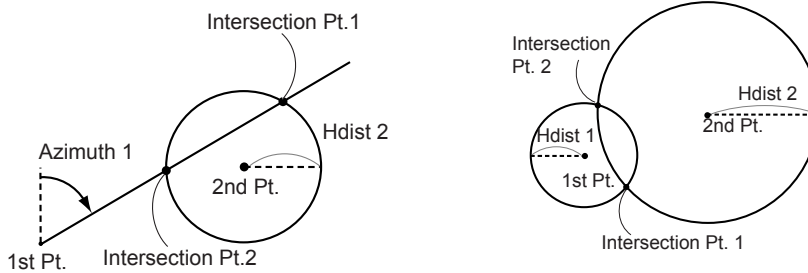

## 23.1 Intersections (Type A)

This function allows the calculation of a variety of intersection solutions: 1 pt, Azimuth; 2 pt, Angle; 4-point intersection; 2 Circles; Extend; Divide; Pitch.

- Set instrument station and backsight as necessary.  
 Setting instrument station/back sight: "13.1 Entering Instrument Station Data and Azimuth Angle"
- EDM setting can be done in the intersections survey menu.  
 Setting items: "33.2 Observation Conditions - Dist"
- Pressing **{FUNC}** in any screen (except input screens) displays the selected intersections type in graphic diagram.



- This diagram is for reference only and does not reflect input values.

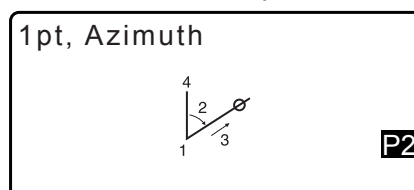

- Intersections survey screens contain the **[REC]** and **[S-O]** softkeys.

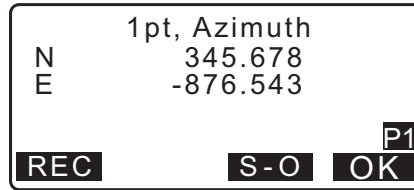

- Press **[REC]** to record measurement results as a known point in the JOB.

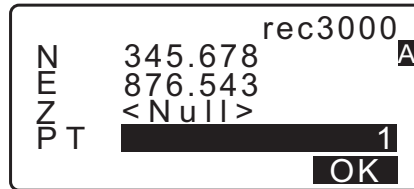

- Press **[S-O]** to perform setting out using the calculated intersections data.  
 ☞ "15. SETTING-OUT MEASUREMENT"

### 23.1.1 1 pt, Azimuth

This function determines the coordinates of a point using the azimuth angle and distance from a specified point.

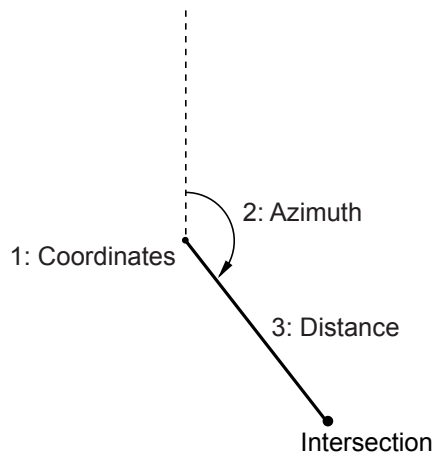

1. In the second page of OBS screen, press **[MENU]**, then select "Intersect."

2. Select "1pt. Azimu".

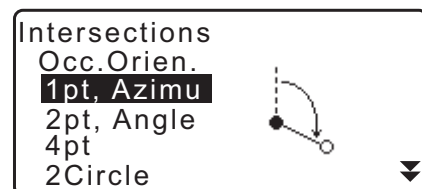

3. Input coordinates of known point and press **[OK]**.

- When **[LOAD]** is pressed, registered coordinates can be recalled and used.

☞ "13.1 Entering Instrument Station Data and Azimuth Angle"

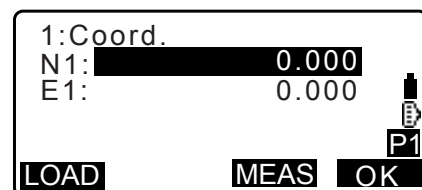

- Press **[MEAS]** to begin measurement.



- Input azimuth angle and distance from known point, then press **[OK]**. Coordinates for the target point are displayed.

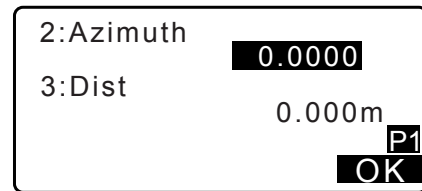

- Press **[OK]** to return to the screen in step 3 and continue measurement as necessary.

- To quit measurement, press **{ESC}** in the screen of step 3.

**Note**

- Azimuth angle input range: 0°00'00" to 359°59'59"
- Distance input range: 0.000 to 999999.999 (m)

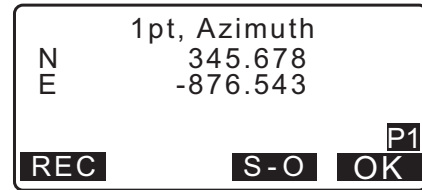

**23.1.2 2 pt, Angle**

This function requires an instrument station and backsight. The included horizontal angle from the backsight and the distance from the instrument are used to determine the coordinates of a target point.

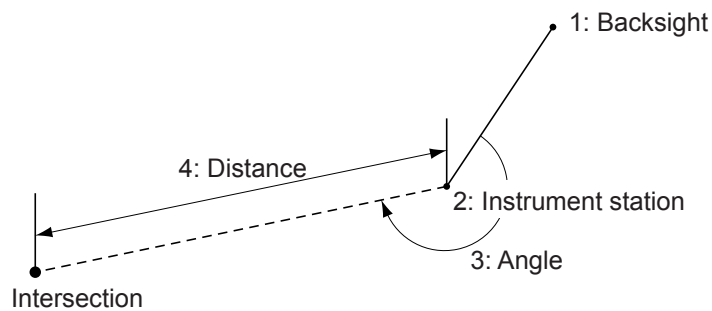

- In the second page of OBS screen, press **[MENU]**, then select "Intersect."

- Select "2pt, Angle".

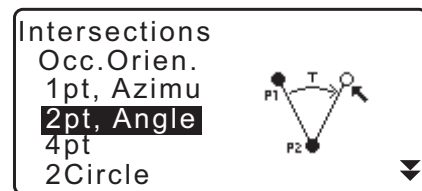

- Input the backsight station coordinates and press **[OK]**.

- When **[LOAD]** is pressed, registered coordinates can be recalled and used.

☞ "13.1 Entering Instrument Station Data and Azimuth Angle"

- Press **[MEAS]** to begin measurement.

- Input the instrument station coordinates and press **[OK]**.

☞ step 3

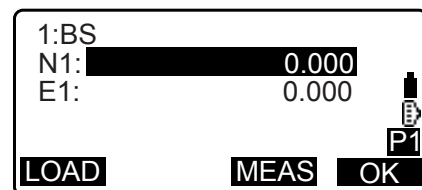

5. Input horizontal angle and distance from instrument station, then press **[OK]**. Coordinates for the target point are displayed.

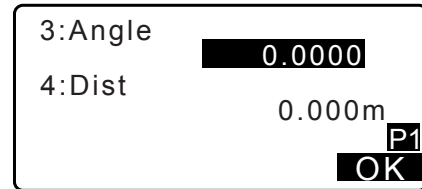

6. Press **[OK]** to return to the screen in step 3 and continue measurement as necessary.

• To quit measurement, press **{ESC}** in the screen of step 3.

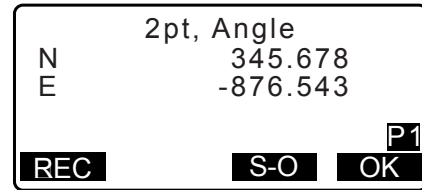

**Note**

- Azimuth angle input range: 0°00'00" to 359°59'59"
- Distance input range: 0.001 to 999999.999 (m)

**23.1.3 4-Point Intersection**

This function calculates the intersection of 2 straight lines created by specifying 4 points.

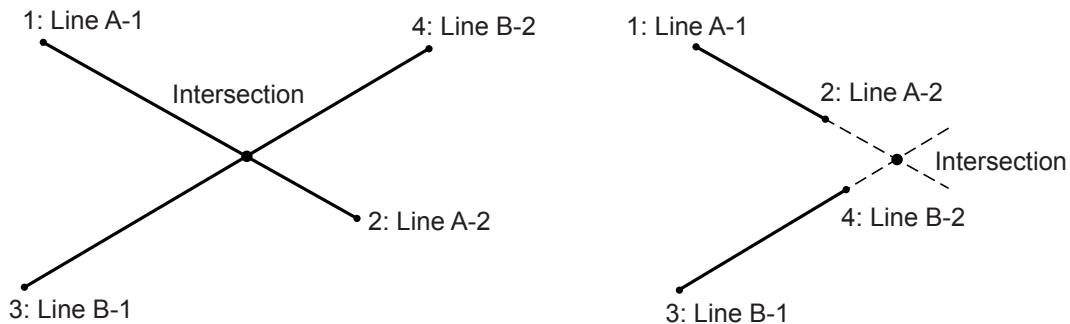

• The 2 straight lines are created by specifying points "Line A-1" and "Line A-2", and "Line B-1" and "Line B-2". Created lines A and B must be set so as to converge. Calculation is not possible when lines A and B are parallel.

1. In the second page of OBS screen, press **[MENU]**, then select "Intersect."
2. Select "4pt".

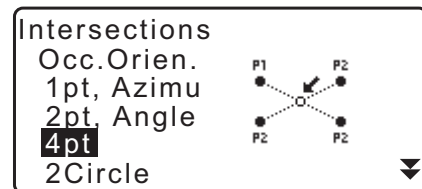

3. Input coordinates for the first point "Line A-1" and press **[OK]**.

• When **[LOAD]** is pressed, registered coordinates can be recalled and used.

☞ "13.1 Entering Instrument Station Data and Azimuth Angle"

• Press **[MEAS]** to begin measurement.

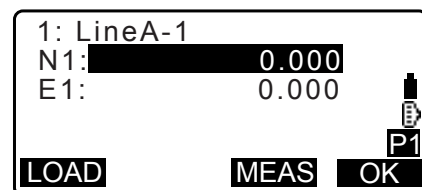

- Input coordinates for the second, third, and fourth points ("Line A-2", "Line B-1", and "Line B-2").

☞ step 3

- Press **[OK]** to return to the screen in step 3 and continue measurement as necessary.

- To quit measurement, press **{ESC}** in the screen of step 3.

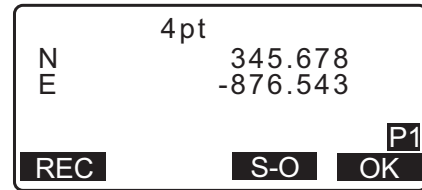

### 23.1.4 2 Circles

This function calculates the intersection of the circumferences of 2 circles created by specifying the diameters from 2 points.

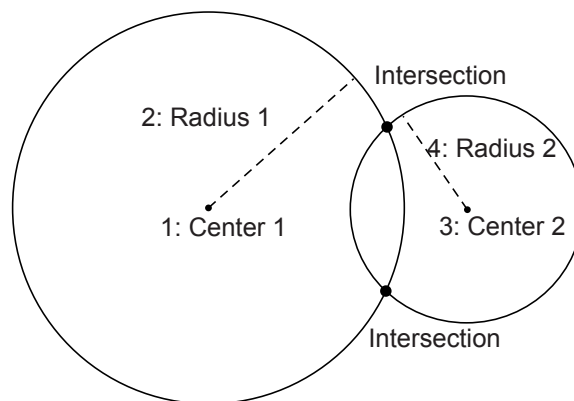

- The 2 circles are created by specifying center points "Center1" and "Center2", and diameters, and radii "Radius1" and "Radius2". Created circles must be set so as to converge. Calculation is not possible when circles do not converge.

- In the second page of OBS screen, press **[MENU]**, then select "Intersect."
- Select "2Circles".

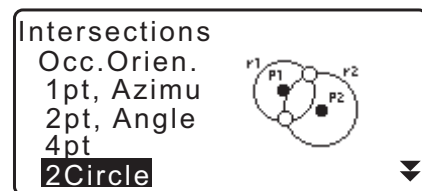

- Input coordinates for the first center point "Center1" and press **[OK]**.

- When **[LOAD]** is pressed, registered coordinates can be recalled and used.

☞ "13.1 Entering Instrument Station Data and Azimuth Angle"

- Press **[MEAS]** to begin measurement.

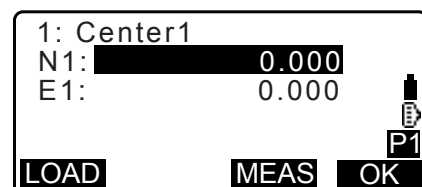

4. Input radius for the first circle "R1" and press **[OK]**.

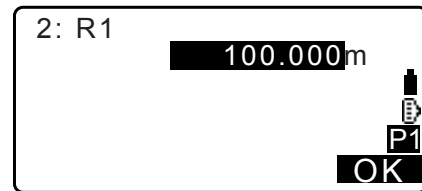

5. Input coordinates for the second center point and radius for the second circle ("Center2" and "R2").

☞ steps 3 to 4

6. 2 converging circles can produce 2 intersections. To switch between result screens, press **▶/◀**.

Press **[OK]** to return to the screen in step 3 and continue measurement as necessary.

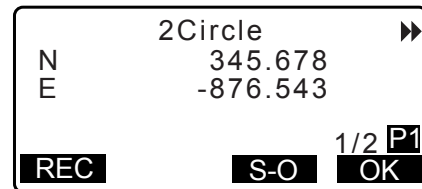

• To quit measurement, press **{ESC}** in the screen of step 3.

**Note**

• Radius input range: 0.000 to 999999.999 (m)

**23.1.5 Extend**

This function calculates the coordinates of a point extending along a defined straight line but beyond the defined end point.

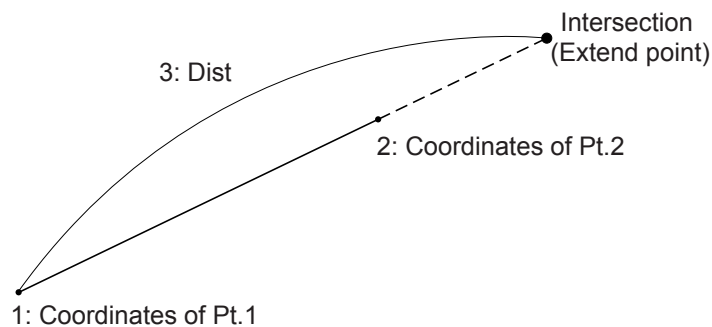

1. In the second page of OBS screen, press **[MENU]**, then select "Intersect."

2. Select "Extend".





3. Input coordinates for the first point and press **[OK]**.

• When **[LOAD]** is pressed, registered coordinates can be recalled and used.

☞ "13.1 Entering Instrument Station Data and Azimuth Angle"

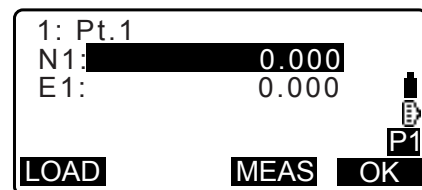
• Press **[MEAS]** to begin measurement.



4. Input coordinates for the second point.  
 step 3
5. Input distance from the first point to the target point and press **[OK]**.

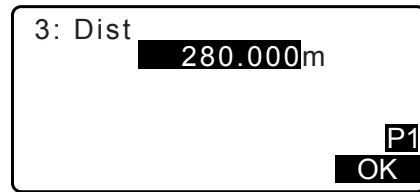

6. Press **[OK]** to return to the screen in step 3 and continue measurement as necessary.
7. To quit measurement, press **{ESC}** in the screen of step 3.

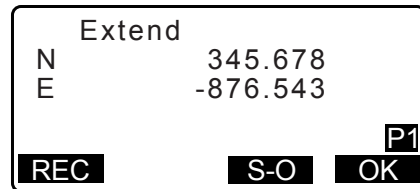

 **Note**

- Distance input range: -999999.999 to 999999.999 (m)

### 23.1.6 Divide

This function divides a straight line created by specifying two points into a user-specified number of segments and calculates coordinates for each point dividing said segments.

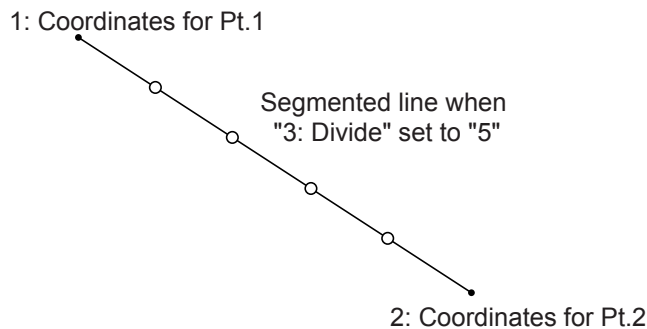

1. In the second page of OBS screen, press **[MENU]**, then select "Intersect."
2. Select "Divide".

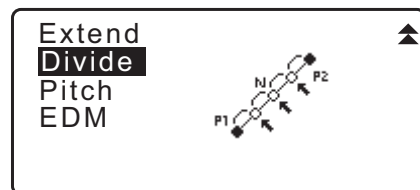

3. Input coordinates for the first point and press **[OK]**.
  - When **[LOAD]** is pressed, registered coordinates can be recalled and used.  
 "13.1 Entering Instrument Station Data and Azimuth Angle"
  - Press **[MEAS]** to begin measurement.

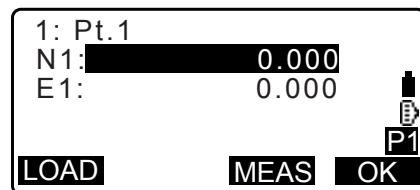

4. Input coordinates for the second point  
 step 3

5. Input the number of segments you wish to divide the distance into and press **[OK]**.



6. Coordinates for each dividing point are displayed on consecutive screens. To switch between result screens, press **[▶]/[◀]**. Press **[OK]** to return to the screen in step 3 and continue measurement as necessary.

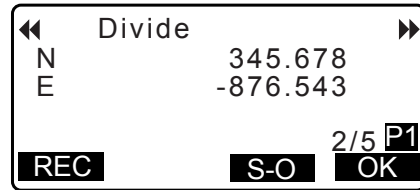

7. To quit measurement, press **{ESC}** in the screen of step 3.

**Note**

- Segments input range: 2 to 100

**23.1.7 Pitch**

This function calculates coordinates for points spaced at a user-designated pitch along a straight line created by specifying two points.

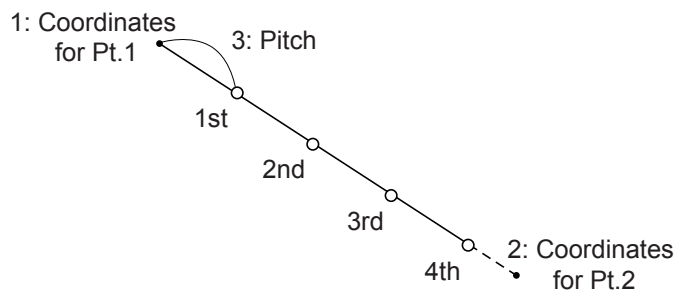

1. In the second page of OBS screen, press **[MENU]**, then select "Intersect."
2. Select "Pitch".

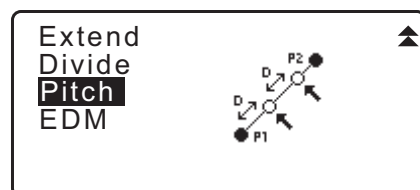

3. Input coordinates for the first point and press **[OK]**.

- When **[LOAD]** is pressed, registered coordinates can be recalled and used.

**[F]** "13.1 Entering Instrument Station Data and Azimuth Angle"

- Press **[MEAS]** to begin measurement.

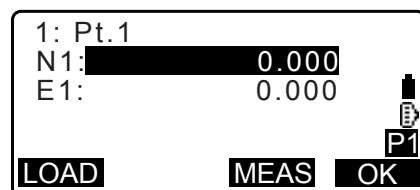

4. Input coordinates for the second point.  
**[F]** step 3

5. Input pitch and press **[OK]**.

3: Pitch	<input type="text" value="30.000"/> m
	P1 OK

6. Coordinates for each calculated point are displayed on consecutive screens. To switch between result screens, press **▶**/**◀**. Press **[OK]** to return to the screen in step 3 and continue measurement as necessary.

◀	Pitch	▶
N	345.678	
E	-876.543	
REC	S-O	2/5 P1 OK

• To quit measurement, press **{ESC}** in the screen of step 3.



• Pitch input range: 0.001 to 999999.999 (m)

## 23.2 Intersections (Type B)

It is possible to find an intersection point between 2 reference points by specifying the length or azimuth angle of either point.

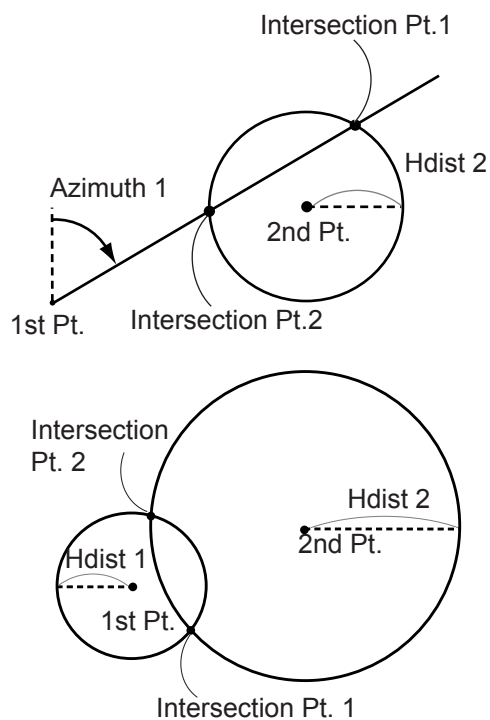

## PROCEDURE

1. In the second page of the OBS mode screen, press **[MENU]**, then select "Intersect."

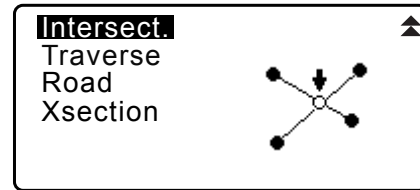

2. Enter the 1st point data and press **[NEXT]**.

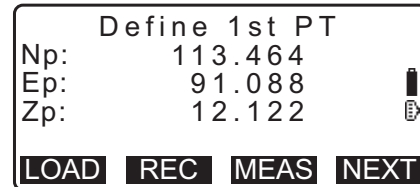

- When **[LOAD]** is pressed, registered coordinates can be recalled and used.

"13.1 Entering Instrument Station Data and Azimuth Angle PROCEDURE Reading in Registered Coordinate Data"

- **[REC]**: records the coordinate value as a known point data.



- Press **[MEAS]** to observe the selected point.
- The tilt screen is displayed if the instrument is out of level. Level the instrument.

"7.2 Levelling"

3. Enter the 2nd point data and press **[OK]**.

- Press **[MEAS]** to observe the selected point.

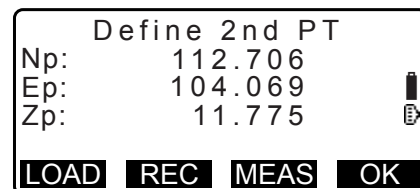

4. Enter azimuth angle (or horizontal distance) of the 1st point and 2nd point.



- Both the azimuth angle and horizontal distance of the 1st (or 2nd) point cannot be input.

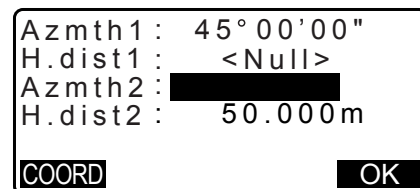

- When the cursor is on "Azmth1" or "Azmth2", **[COORD]** is displayed. Press **[COORD]** to set the azimuth angle for each point by inputting coordinates.

- Press **[MEAS]** to observe the selected point.

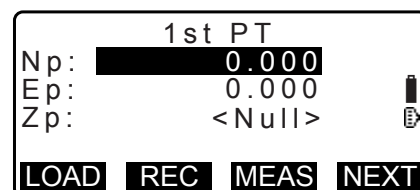



5. Press **[OK]**. The coordinate value of the intersection point is calculated and displayed.

```
Azmth1 : 45° 00' 00"
H.dist1 : <Null>
Azmth2 : <Null>
H.dist2 : 50.000m
OK
```

```
Intersection1
N          176.458
E          176.458
Z          <Null>
OTHER REC S-O
```

- When there are 2 intersections, **[OTHER]** is displayed.

☞ "2 Intersections"

- Press **[S-O]** to move to setting-out measurement of the required point.

☞ "15. SETTING-OUT MEASUREMENT"

6. Press **{ESC}**. Continue the measurement (repeat steps from 2).

#### Note

- It is also possible to perform intersection measurement by pressing **[INTSCT]** when allocated to the OBS mode screen.

☞ Allocating **[INTSCT]**: "33.11 Allocating Key Functions"

#### 2 Intersections

2 intersections are defined according to 1<sup>st</sup> Pt. and 2<sup>nd</sup> Pt. as shown below

Intersections created from Azmth 1 and H.dist 2 (or H.dist 1 and Azmth 2):

An azimuth angle has already been set for a point. The furthest point from this point is set as Intersection Pt. 1, and the closest point set as Intersection Pt. 2.

- Intersections created from H.dist 1 and H.dist 2:

Intersection to the right of the straight line between 1<sup>st</sup> point and 2<sup>nd</sup> point set as Intersection Pt. 1 and the point to the left set as Intersection Pt. 2.

#### Precaution when performing intersection measurement

In the following cases the coordinates of intersection points cannot be calculated.

When Azimuth 1 = Azimuth 2.

When Azimuth 1 – Azimuth 2 =  $\pm 180^\circ$ .

When H.dist 1 = 0, or H.dist 2 = 0.

When the coordinates for 1<sup>st</sup> Pt. and 2<sup>nd</sup> Pt are the same.

# 24. TRAVERSE ADJUSTMENT

Measurement of a traverse begins with observation of the backsight station and foresight station. The instrument station is then moved to the foresight station and the previous instrument station becomes the backsight station. Observation is performed again at the new position. This process is repeated for the length of the route.

This adjustment function is used to calculate the coordinates of such a sequence of consecutively-observed points (traverse points and points observed from traverse points (see P3-1 to P3-3 below)). When calculation is complete, the iM displays the precision of the traverse and, when necessary, traverse adjustment can be performed.

☞ For types of traverse that can be calculated with the iM, see "☐ Types of traverse"

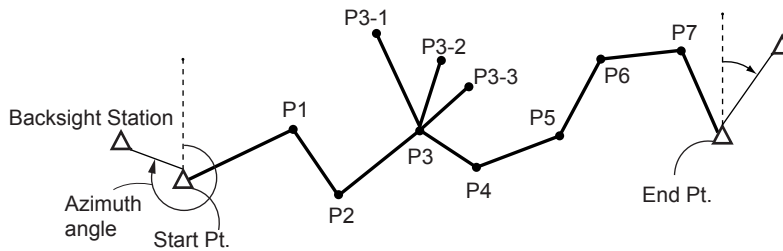

## PROCEDURE

1. Before starting traverse calculation, observe the sequence of traverse points and record the results.

☞ "28.4 Recording Distance Measurement Data"/  
"28.6 Recording Distance and Coordinate Data"

2. In the second page of the OBS mode screen, press **[MENU]**, then select "Traverse".

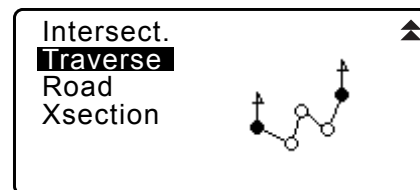

3. Enter the start point name and press **{ENT}**.

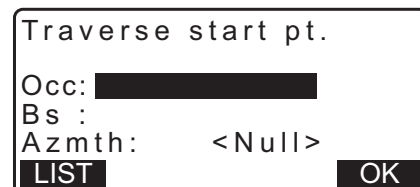

- When **[LIST]** is pressed, a list of instrument stations saved in the current JOB is displayed. A point from this list can be recalled and used.

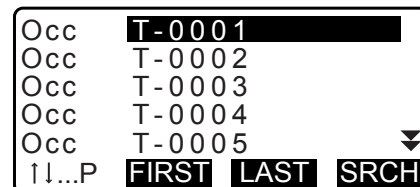

☞ For using softkeys in this screen, see "13.1 Entering Instrument Station Data and Azimuth Angle PROCEDURE Reading in Registered Coordinate Data"

- Enter values manually when there are no coordinates saved for the specified instrument station.  
Press **[OK]** to proceed to step 4.

```

Occ:
N      ██████████ 0.000
E      ██████████ 0.000
Z      ██████████ <Null>
PT T-0001
LOAD REC OK
    
```

4. Enter the point name of the backsight station for the start point and press **{ENT}**.

```

Traverse start pt.
Occ:T-0001
Bs : BS ██████████
Azmh: ██████████ <Null>
LIST OK
    
```

When there are saved coordinates for the backsight station, the calculated azimuth angle is displayed.

- Enter values manually when there are no coordinates saved for the specified start point backsight station.  
Press **[OK]** to display the calculated azimuth angle.

```

Traverse start pt.
Occ:T-0001
Bs : T-000Z
Azmh: ██████████ 357°27'46"
OK
    
```

- To enter azimuth angle without entering backsight station coordinates, press **{▼}** to move the cursor down to "Azmh" then enter an angle value.

5. When **[OK]** is pressed in the screen in step 4, the iM will search for a traverse route. The points from step 1 will be displayed in the order in which they were observed.

```

001:T-0001
Searching
    
```

- This search can be stopped by pressing **{ESC}**. If **{ESC}** is pressed, a route can be computed using only the points found prior to the search being stopped.

```

Exit Searching
confirm?
NO YES
    
```

- When a traverse point with recorded known point coordinates is found, or there are multiple foresight stations for a point, the automatic route search will stop. Press **[LIST]** and select which foresight station to use as the next point.  "Automatic route search"

6. Press **[OK]** to confirm the traverse route.

```

006:T-0006
007:T-0007
008:T-0001
009: ██████████
LIST OK
    
```

7. Enter the point name of the backsight station for the end point and press **{ENT}**.

The calculated azimuth angle is displayed.

```

Traverse end pt.
Occ:T-0001
Fs :T-0002
Azmth: 335°27'46"
LIST OK
    
```

Enter the azimuth angle when there are no recorded coordinates for the end point backsight station.

8. When **[OK]** is pressed in the screen in step 7, the iM will display the precision of the traverse.

```

Traverse precision
d.Ang : 0°00'20"
d.Dist: 0.013
Precision: 42714
OPTION ADJUST
    
```

```

Traverse precision ▲
d.North: 0.013
d.East : 0.000
d.Elev : -0.002
OPTION ADJUST
    
```

- d.Ang: Angular closure error
- d.Dist: Horizontal closure distance
- Precision: Precision of the traverse as a ratio of the total horizontal distance traversed to the closure distance
- d.North: Closure distance in Northing coordinates
- d.East: Closure distance in Easting coordinates
- d.Elev: Closure distance in elevation

- Press **[OPTION]** to change the method by which the traverse adjustments are distributed.

(\*:Factory setting)

- Method (coordinate adjustment): Compass\*, Transit
- Angular: Weighted\*, Linear, None
- Elev (Elevation): Weighted\*, Linear, None
- ☞ For all options, see "[F1] Adjustment methods"

```

Adjustment options
Method : Compass
Angular : Weighted
Elev : Weighted
    
```

9. Angular adjustment will be performed first. Press **[ADJUST]** to start adjustment using the method selected in "(2) Angular" in step 8.

- When "None" is selected in "(2) Angular" in step 8, only coordinate and elevation adjustment will be performed.

```

After angle adjust
d.Ang : 0°00'00"
d.Dist: 0.006
precision: 89788
OPTION ADJUST
    
```

10. After confirming the results, press **[ADJUST]** again to start coordinate and elevation adjustment using the methods selected in "(1) Method" and "(3) Elev" respectively. All adjusted instrument data will be saved in the currently selected JOB and traverse adjustment will be finished.

```

Traverse adjustment
Recording... 7
    
```

**Note**

- It is also possible to perform traverse adjustment by pressing **[TRAV]** when allocated to the OBS mode screen.

☞ Allocating [TRAV]: "33.11 Allocating Key Functions"

- Traverse adjustment results of traverse points, points observed from traverse points and traverse adjustment data will be saved in the currently selected JOB as Notes data. Data including the distributed closure error will also be saved in the currently selected JOB as ordinary coordinate data.

Traverse line record (3):

1. point names of start and end points
2. backsight station name and azimuth to said backsight station
3. foresight station name and azimuth to said foresight

Adjustment setting record (1): The selected method for distributing closure error.

Closure error record (2x2):

1. precision and closure error for angle/distance
2. coordinate closure error

Coordinate adjustment record

(No. of included points between start and end points): Coordinates



### Types of traverse

iM can calculate closed-loop and closed traverses. In both cases, the azimuth for the start point (and for the end point in the case of a closed traverse) must be set.

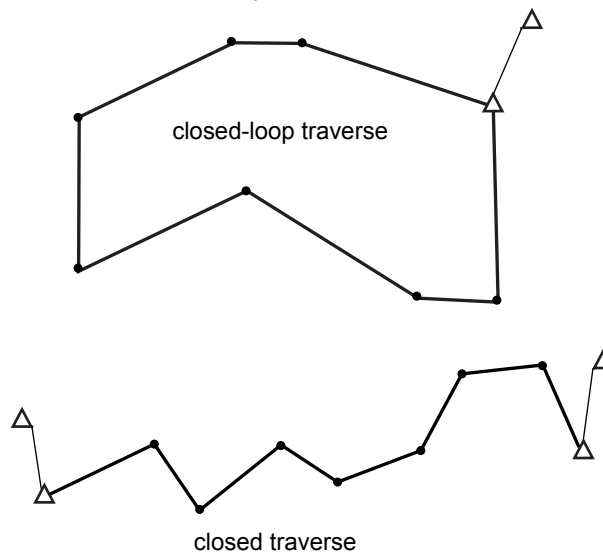

### Automatic route search

This function searches for consecutively-observed traverse points already stored on the iM and presents them as potential traverse routes.

This function is activated when the following conditions are met. When a point has been observed more than once, the most recent data will be used for the search.

- At least one backsight station and one foresight station are observed from an instrument station.
- The foresight station becomes the instrument station for the subsequent measurement.
- The instrument station becomes the backsight station for the subsequent measurement.

If one of the following conditions is met, the automatic route search will terminate. The same search can be resumed by specifying the name of the next point in the route.

- There is more than one potential foresight station for an instrument station. (Route search terminates as a juncture appears in the route.)
- The foresight station for the previous measurement was the Start pt. (Route search terminates as this measurement is judged to have closed a closed-loop traverse.)
- The most recently measured point has the same point name as a recorded known point. (Route search terminates as this point is judged to be the End pt.)

The automatic route search function cannot be used in the following case.

- The final measurement is to a traverse point on the traverse route other than the Start pt.



### Adjustment methods

Adjustment is applied to results for traverse points and points observed from traverse points. Adjustment methods and distribution options selected in step 8 are described below.

#### Method

**Compass:** The Compass method distributes the coordinate error in proportion to the length of the traverse lines.

$$\text{Northing adjustment} = \frac{L}{TL} \times \text{closure north}$$

$$\text{Easting adjustment} = \frac{L}{TL} \times \text{closure east}$$

Where: L = length of the traverse line to the point  
TL = sum of the traverse line lengths

**Transit:** The Transit method distributes the coordinate error in proportion to the northing and easting ordinates of each traverse line.

$$\text{Northing adjustment} = \frac{|\Delta N|}{\Sigma |\Delta N|} \times \text{closure north}$$

$$\text{Easting adjustment} = \frac{|\Delta E|}{\Sigma |\Delta E|} \times \text{closure east}$$

Where:  $\Delta N$  = change in northing for the traverse line  
 $\Delta E$  = change in easting for the traverse line  
 $\Sigma |\Delta N|$  = sum of the absolute value of all the changes in northings of all the traverse lines  
 $\Sigma |\Delta E|$  = sum of the absolute value of all the changes in eastings of all the traverse lines

#### Angular adjustment

**Weighted:** Any angular closure is distributed among the angles of the traverse route based on the sum of the inverses of the forward and back traverse line lengths at each angle. The backsight and foresight lines are considered to have infinite lengths for the purposes of this weighting computation.

$$\angle \text{adjustment} = \frac{\left( \frac{1}{\text{todist}} + \frac{1}{\text{fromdist}} \right)}{\Sigma \left( \frac{1}{\text{todist}} + \frac{1}{\text{fromdist}} \right)} \times \angle \text{closure}$$

**Linear:** Any angular closure is distributed evenly among the angles of the traverse route.

**None:** No angular adjustment performed.

#### Elev adjustment

**Weighted:** Any closure in the elevations is distributed in proportion to the length of the traverse line leading to the point (like the Compass method for coordinate adjustment).

**Linear:** Any closure in the elevations is distributed evenly in each leg of the traverse route.

**None:** No elevation adjustment performed.

# 25.ROUTE SURVEYING

This mode allows a variety of route surveying options widely used in civil engineering measurement. Each menu allows the operator to initiate a string of successive configuration/calculation/record/setting-out operations.

- The orientation of the instrument station and backsight station can be set as necessary.  
☞ For backsight station settings, see "13.1 Entering Instrument Station Data and Azimuth Angle".
- EDM settings can be set in the Route Surveying menu.  
☞ "33.2 Observation Conditions - Dist"
- The point names and codes set when measurement results were recorded can only be used in the Route Surveying menu.



- The Z-axis coordinate value in all Route Surveying work is always "Null" ("Null" is not the same as "0").

## Symbols and terms used in Route Surveying

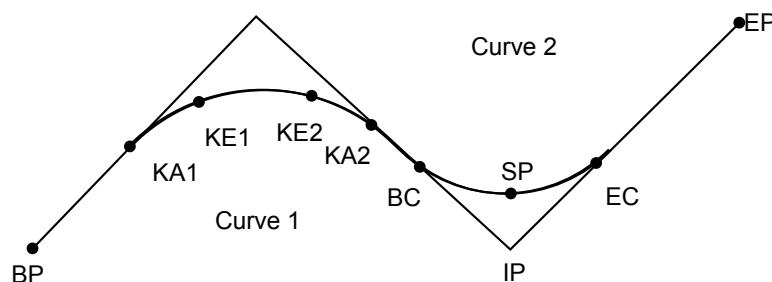

BP Point: route origin

KA Point: clothoid curve origin

BC Point: circular curve origin

IP Point: point of intersection

Offset: reference point follow-up distance

EP Point: route end-point

KE Point: clothoid end-point

EC Point: circular curve end-point

SP Point: circular curve midpoint

Follow-up distance: target point follow-up distance

## 25.1 Instrument Station Settings

The instrument station to be used as the reference point is recorded, as necessary, prior to starting surveying.

☞ For instrument station settings, see "13.1 Entering Instrument Station Data and Azimuth Angle"

## 25.2 Straight Line Calculation

The coordinates of the center peg and width pegs for a straight line can be found from the coordinates of the reference point and IP point.

It is then possible to proceed with the setting-out of the center peg and width pegs.

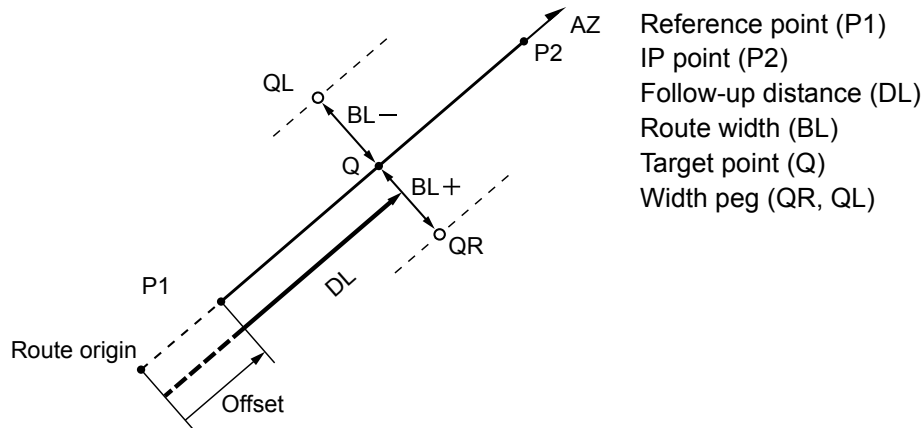

### PROCEDURE

- In the second page of the OBS mode screen, press **[MENU]**, then select "Road".
- Select "Line" to enter the Straight Line menu.

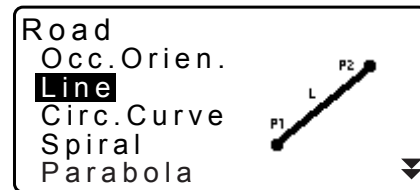

- Input the coordinates of the reference point, then press **[OK]**.

- Press **[LOAD]** to read in the already registered coordinate data and set as the coordinates of the reference point.

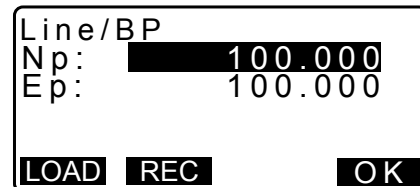

☞ "13.1 Entering Instrument Station Data and Azimuth Angle PROCEDURE Reading in Registered Coordinate Data"

- The reference point coordinates can be stored as the coordinates for a known point in the current job by pressing **[REC]**.

☞ "30.1 Registering/Deleting Known Point Data"



4. Input the coordinates of the IP point, then press **[OK]**.

- The azimuth angle to the IP point can be set by pressing **[AZMTH]** on the second page. Press **[COORD]** to return to coordinate input.

Line/IP	
Np:	200.000
Ep:	200.000
<b>P2</b>	
<b>AZMTH</b>	

Line/IP	
Azmth	45.0005
<b>COORD</b>	
<b>OK</b>	

5. Input the reference point follow-up distance in "St. ofs".  
Input the target point follow-up distance in "Sta..ing".

Line/CL peg	
St. ofs	0.000m
Sta..ing	25.000m
<b>OK</b>	

6. Press **[OK]** in the screen shown in step 5 to calculate the center peg coordinates. The coordinates and azimuth angle are then displayed on the screen.

Line/CL peg	
N	117.678
E	117.678
Azmth	45°00' 00"
<b>WIDTH</b> <b>REC</b> <b>S-O</b> <b>CENTER</b>	

7. Press **{ESC}** twice to finish Straight Line calculation and return to <Road>.

- Press **[WIDTH]** to move to the width peg setting screen. The coordinates of the width peg can be found by inputting the route width and pressing **[OK]**.

Line/WidthPeg	
Sta..ing	25.000m
CL ofs	5.000m
<b>OK</b>	

Line/WidthPeg	
N	114.142
E	121.213
<b>WIDTH</b> <b>REC</b> <b>S-O</b> <b>CENTER</b>	

- The center peg can be stored as a known point in the current job by pressing **[REC]**.

 "30.1 Registering/Deleting Known Point Data"

- The center peg can be set-out by pressing **[S-O]**.

 "15. SETTING-OUT MEASUREMENT"

- Press **[CENTER]** to return to the center peg setting screen.

#### Note

- When the azimuth angle is set after the coordinates have been input in step 4, if the coordinates are deleted the azimuth angle is given priority.
- Offset/Follow-up distance input range: 0.000 to 99999.999 (m)
- Route width input range: -999.999 to 999.999 (m)

### 25.3 Circular Curve Calculation

The coordinates of the center peg and width pegs on a circular curve can be found from the coordinates of the BC point and IP point.

It is then possible to proceed with the setting-out of the center peg and width pegs.

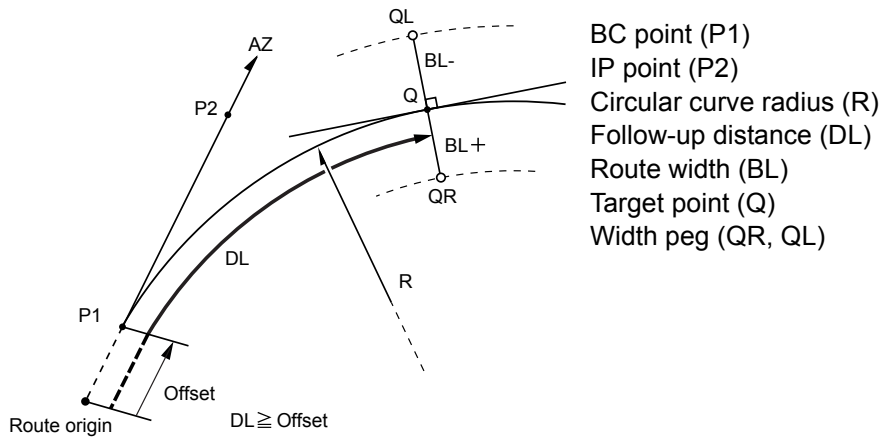

- BC point (P1)
- IP point (P2)
- Circular curve radius (R)
- Follow-up distance (DL)
- Route width (BL)
- Target point (Q)
- Width peg (QR, QL)

#### PROCEDURE

1. In the second page of the OBS mode screen, press **[MENU]**, then select "Road".
2. Select "Circ.Curve" to enter the Circular Curve menu.
3. Input the coordinates of the BC point (reference point), then press **[OK]**.
4. Input the coordinates of the IP point, then press **[OK]**.
  - The azimuth angle to the IP point can be set by pressing **[AZMTH]** on the second page. Press **[COORD]** to return to coordinate input.
5. Enter the curve direction, curve radius, offset, and follow-up distance.

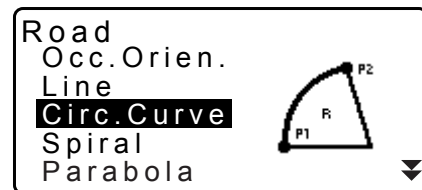

6. Press **[OK]** in the screen shown in step 5 to calculate the center peg coordinates. The coordinates and azimuth angle are then displayed in this screen.

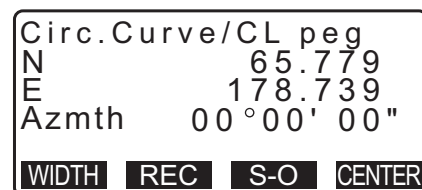
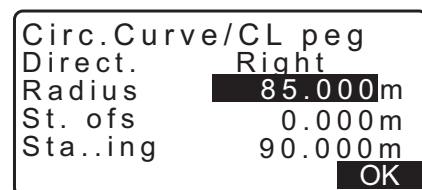

7. Press **{ESC}** twice to finish Circular Curve calculation and return to <Road>.

- Press **[WIDTH]** to move to the width peg setting screen.

☞ "25.2 Straight Line Calculation"

- The center peg can be set-out by pressing **[S-O]**

☞ "15. SETTING-OUT MEASUREMENT"

Note

- Curve direction: right/left
- Radius input range: 0.000 to 9999.999 (m)

## 25.4 Spiral Curve

The coordinates of the center peg and width pegs on a spiral (clothoid curve) can be found from the coordinates of the reference point and curve properties.

It is then possible to proceed with the setting-out of the center peg and width pegs

- Select a calculation menu depending on the section of the spiral to be calculated.
- Clothoid curve is calculated by the following formula.

$$A^2 = RL$$

Calculation using KA Point as reference: "KA→KE Calculation 1"

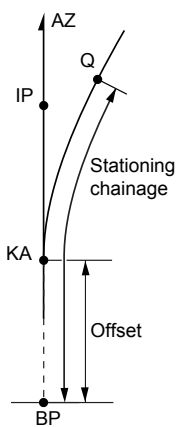

- KA point (P1)
- IP point (P2)
- Clothoid parameter A
- Follow-up distance (DL)
- Route width (BL)

Calculation using arbitrary point between KA1 and KE1 as reference:

"KA→KE Calculation 2"

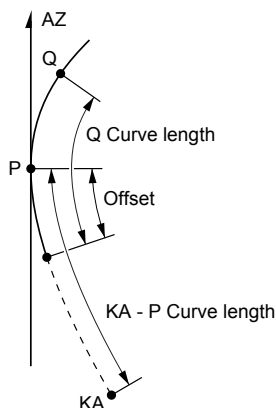

- Reference point (P1)
- Point on line tangential to P1 (P2)
- Clothoid parameter A
- KA to P1 curve length (L)
- P1 to target point (QR, QL)
- Curve length (DL1, DL2)
- Route width (BL)

Calculation using KE2 as reference: "KE→KA Calculation"

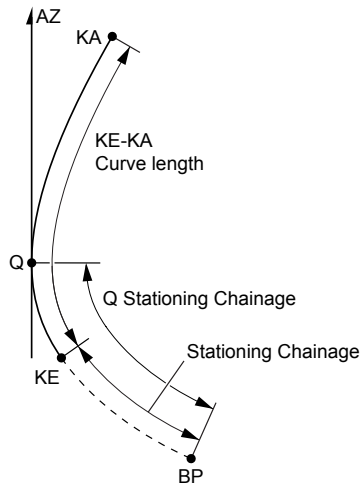

- KE point (P1)
- KE tangential angle (AZ)
- Clothoid parameter A
- KE to KA curve length (L)
- KE follow-up distance (DL1)
- Target point follow-up distance (DL2)
- Route width (BL)



- If the following conditions are not met, coordinate calculation cannot be performed.
  - "KA→KE Calculation 1":  $0 \leq \text{curve length} \leq 2A$
  - "KA→KE Calculation 2":  $0 \leq \text{KA - reference point curve length} \leq 3A$   
 $0 \leq \text{KA - target point curve length} \leq 2A$
  - "KE→KA Calculation":  $0 \leq \text{KA - KE curve length} \leq 3A$   
 $0 \leq \text{KA - target point curve length} \leq 2A$

**PROCEDURE Calculation using KA Point as reference**

1. In the second page of the OBS mode screen, press **[MENU]**, then select "Road".
2. Select "Spiral" to enter the spiral menu then select "KA-KE 1".

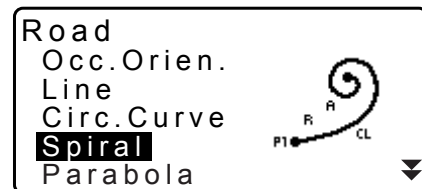

3. Input the coordinates of the KA point (reference point). Press **[OK]** to set the input values.
4. Input the coordinates of the IP point, then press **[OK]**.

- The azimuth angle to the IP point can be set by pressing **[AZNTH]** on the second page. Press **[COORD]** to return to coordinate input.

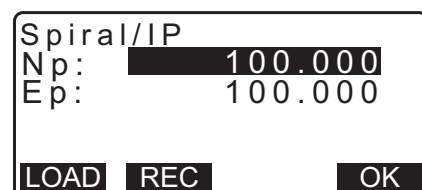

5. Enter the curve direction, parameter A, offset, and follow-up distance.

```
Spiral/CL peg
Direct.      Right
Para A      80.000m
St. ofs     0.000m
Sta.ing     25.000m
OK
```

6. Press **[OK]** in the screen shown in step 5 to calculate the center peg coordinates. The coordinates and azimuth are then displayed in this screen.

```
Spiral/CL peg
N           120.859
E           113.755
Azimuth    00°00'00"
WIDTH REC S-O CENTER
```

7. Press **{ESC}** three times to finish spiral calculation and return to <Road>.

- Press **[WIDTH]** to move to the width peg setting screen.

☞ "25.2 Straight Line Calculation"

- The center peg can be set-out by pressing **[S-O]**

☞ "15. SETTING-OUT MEASUREMENT"

#### Note

- Curve direction: right/left
- Parameter A input range: 0.000 to 9999.999 (m)
- Station offset /Stationing chainage input range:0.000 to 99999.999 (m)

### PROCEDURE Calculation using arbitrary point between KA1 and KE1 as reference

1. In the second page of the OBS mode screen, press **[MENU]**, then select "Road".
2. Select "Spiral" to enter the spiral menu then select "KA-KE 2".

```
Spiral
KA-KE 1
KA-KE 2
KE-KA
```

3. Input the coordinates of the P point (reference point). Press **[OK]** to set the input values.

```
Spiral/Ref.PT P
Np: 100.000
Ep: 100.000
LOAD REC OK
```

4. Input the coordinates of the arbitrary point on the line tangential to the P point, then press **[OK]**.

- The azimuth angle to the P point can be set by pressing **[AZMTH]** on the second page. Press **[COORD]** to return to coordinate input.

5. Enter the curve direction, parameter A, KA-P curve length (length of curve from KA to P point), offset, and P-target curve length (length of curve from P point to target point).

Spiral/CL peg	
Direct.	Right
Para A	80.000m
KA-P length	50.000m
<b>OK</b>	

St. ofs	0.000m	▲
P-SetOutPTlength	25.000m	
<b>OK</b>		

6. Press **[OK]** in the screen shown in step 5 to calculate the center peg coordinates. The coordinates are then displayed in this screen.

Spiral/CL peg	
N	119.371
E	115.706
Azmth	58°59'18"
<b>WIDTH REC S-O CENTER</b>	

7. Press **{ESC}** three times to finish spiral calculation and return to <Road>.

**Note**

- KA-P curve length/ P-target point curve length input range: 0.000 to 99999.999 (m)

### PROCEDURE Calculation using KE2 Point as reference

1. In the second page of the OBS mode screen, press **[MENU]**, then select "Road".
2. Select "Spiral" to enter the spiral menu then select "KE-KA".

Spiral	
KA-KE 1	
KA-KE 2	
<b>KE-KA</b>	

3. Input the coordinates of the KE point (reference point). Press **[OK]** to set the input values.

Spiral/KE	
Np:	167.731
Ep:	225.457
<b>LOAD REC OK</b>	

4. Input the azimuth angle of the arbitrary point on the line tangential to the KE point, then press **[OK]**.

- Pressing **[COORD]** sets the coordinate toward the tangential direction. Pressing **[AZMTH]** on the second page returns to the screen for inputting the azimuth angle.

5. Enter the curve direction, parameter A (clothoid parameter), KE-KA curve length (length of curve from KE to KA), KE follow-up distance, and target point follow-up distance.

```
Spiral/CL peg
Direct.      Right
Para A      50.000m
KA-KE length
            41.667m
            OK
```

```
KE Sta.ing  153.718m
SetOutpt. sta
            160.000m
            OK
```

6. Press **[OK]** in the screen shown in step 5 to calculate the center peg coordinates. The coordinates are then displayed in this screen.

```
Spiral/CL peg
N           164.837
E           231.004
Azmth     125°32'48"
WIDTH REC S-O CENTER
```

7. Press **{ESC}** three times to finish spiral calculation and return to <Road>.

**Note**

- KE-KA curve length (length of curve from KE to KA)/KE follow-up distance/target point follow-up distance input range: 0.000 to 99999.999 (m))

## 25.5 Parabola

The coordinates of the center peg and width pegs on a parabola can be found from the coordinates of the reference point and curve properties.

It is then possible to proceed with the setting-out of the center peg and width pegs

- Select a calculation menu depending on the section of the parabola to be calculated.
- Parabola is calculated by the following formula.

$$y = \frac{x^3}{6RX}$$



### Abbreviations used in parabola calculation

BTC: Beginning of transition curve

BCC: Beginning of circular curve

ETC: End of transition curve

ECC: End of circular curve

Calculation using BTC Point as reference:

"BTC→BCC Calculation 1"

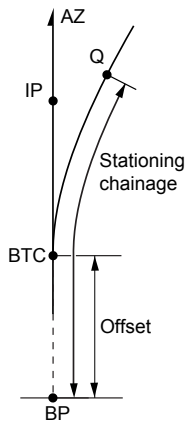

Calculation using BCC as reference: "ECC→ETC Calculation"

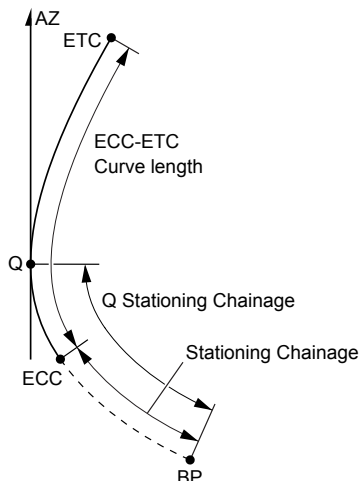



**PROCEDURE Calculation using BTC Point as reference**

1. In the second page of the OBS mode screen, press **[MENU]**, then select "Road".
2. Select "Parabola" to enter the Parabola menu then select "BTC→BCC Calc."

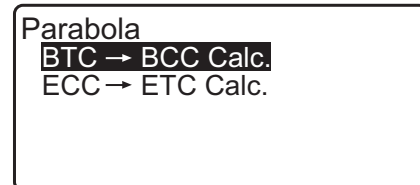
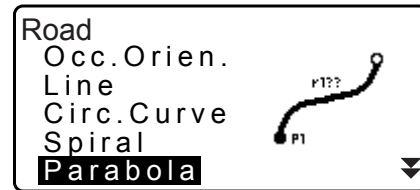

3. Input the coordinates of the BTC point (reference point). Press **[OK]** to set the input values.



4. Input the coordinates of the IP point, then press **[OK]**.

- The azimuth angle to the IP point can be set by pressing **[AZMTH]** on the second page. Press **[COORD]** to return to coordinate input.

5. Enter the curve direction, parameter X, radius, offset, and stationing chainage.

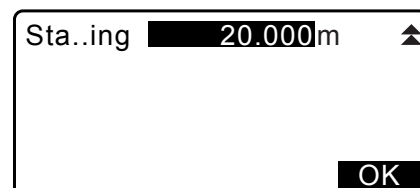
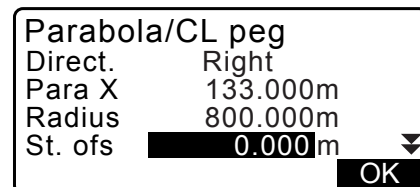

6. Press **[OK]** in the screen shown in step 5 to calculate the center peg coordinates. The coordinates are then displayed in this screen.

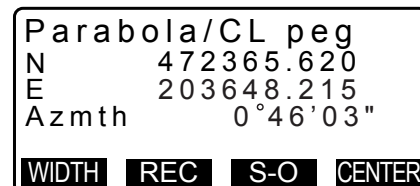

7. Press **{ESC}** three times to finish Parabola calculation and return to <Road>.

- Press **[WIDTH]** to move to the width peg setting screen.

☞ "25.2 Straight Line Calculation"

- The center peg can be set-out by pressing **[CENTER]**.

☞ "15. SETTING-OUT MEASUREMENT"

Note

- Curve direction: right/left
- Parameter X/Radius input range: 0.000 to 9999.999 (m)
- Station offset/Stationing chainage input range: 0.000 to 99999.999 (m)

### PROCEDURE Calculation using ECC Point as reference

1. In the second page of the OBS mode screen, press **[MENU]**, then select "Road".

2. Select "Parabola" to enter the Parabola menu then select "ECC→ETC Calc."

Parabola  
 BTC → BCC Calc.  
**ECC → ETC Calc.**

3. Input the coordinates of the ECC point (reference point). Press **[OK]** to set the input values.

Parabola/ECC PT  
 Np : **475073.398**  
 Ep : 203897.770  
**LOAD REC OK**

4. Input the azimuth angle of the arbitrary point on the line tangential to the KE point, then press **[OK]**.

- Pressing **[COORD]** sets the coordinate toward the tangential direction. Pressing **[AZMTH]** on the second page returns to the screen for inputting the azimuth angle.

Parabola/2nd tan pt  
 Azmth **20.000**  
**COORD OK**

5. Enter the curve direction, parameter X, ECC-ETC curve length, ECC stationing chainage and Q stationing chainage (Set out pt sta).

Parabola/CL peg  
 Direction. Right  
 Para X 133.000m  
 ECC-ETC Length  
**140.000m** ▼  
**OK**

ECC Sta..ing ▲  
 0.000 m  
 Set out pt sta  
**20.000m**  
**OK**

- Press **[OK]** in the screen shown in step 5 to calculate the center peg coordinates. The coordinates are then displayed in this screen.

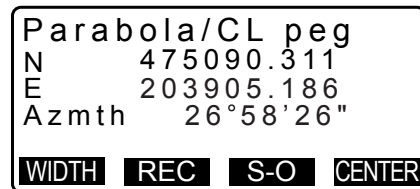

- Press **{ESC}** three times to finish Parabola calculation and return to <Road>.

**Note**

- ECC-ETC curve length/ECC stationing chainage/Q stationing chainage (Set out pt sta) input range: 0.000 to 99999.999 (m)

### 25.6 3 Point Calculation

The coordinates of a cardinal point, an arbitrary centerline peg, and width pegs can be found from the coordinates of 3 IP points and curve properties.

It is then possible to proceed with the setting-out of the cardinal point, arbitrary center peg, and width pegs

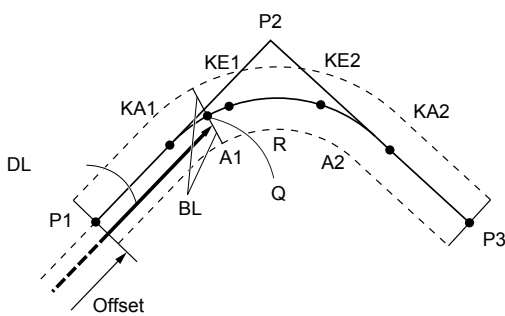

**Parameters input:**

- BP point (P1)
- IP point (P2)
- EP point (P3)
- Intersection angle
- Direction of curve
- BP-IP length
- IP-EP length
- Clothoid parameter A1
- Clothoid parameter A2
- Curve radius (R)
- Route width (BL)
- Route width (BL)
- Stationing to CL peg (DL)

- When parameter A1, parameter A2 and radius R have all been input a clothoid is created and the KA1, KE1, KE2 and KA2 points can be found.
- When parameter A1 and parameter A2 have been input and radius R is "Null", a clothoid without a transition curve is created and the KA1, KE1, and KA2 points can be found.
- When parameter A1 and parameter A2 are both "Null" and only radius R has been input, a circular curve is created and the BC point and EC point can be found.

**PROCEDURE**

- In the second page of the OBS mode screen, press **[MENU]**, then select "Road".
- Select "3PT Curve" to enter the 3 point calculation menu.

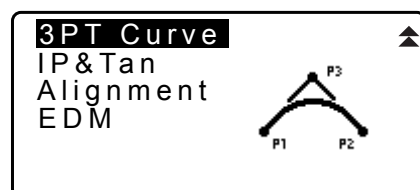

3. Input the coordinates of the BP point (reference point).  
Press **[OK]** to set the input values.

```

3PT Curve/BP
Np: 100.000
Ep: 100.000
LOAD REC OK
    
```

4. Input the coordinates of the IP point, then press **[OK]**.

5. Input the coordinates of the EP point, then press **[OK]**.

```

3PT Curve/IP
Np: 100.000
Ep: 300.000
LOAD REC OK
    
```

6. The IA ang (intersection angle), direction (of curve), BP-IP (BP-IP length), and IP-EP (IP-EP length) are calculated from the coordinates of the three input points. The results are then displayed on the screen. Check the data, then press **[OK]**.

- Press **{ESC}** to return to the previous screen to make alterations to this data.

```

3PT Curve
IA 90°00'00"
Direct. Right
BP-IP 141.421m
IP-EP 141.421m
OK
    
```

7. Input curve properties: parameter A1, parameter A2, curve radius, and St. ofs (BP Point offset).

```

3PT Curve
Para A1 50.000m
Para A2 50.000m
Radius 60.000m
St. ofs 0.000m
OK
    
```

8. Press **[OK]** in the screen shown in step 7 to calculate the coordinates and follow-up distance of the KA1 point, KE1 point, KE2 point, KA2 point. The results are then displayed on the screens shown here. Press **▶/◀** to switch between <3PT Curve/KA1>/<3PT Curve/KE1>/<3PT Curve/KE2>/<3PT Curve/KA2>.

```

3PT Curve/KA1 ▶
N 142.052
E 142.052
Sta..ing 59.471m
WIDTH REC S-O CENTER
    
```

⋮

```

◀ 3PT Curve/KA2
N 142.052
E 257.948
Sta..ing 195.386m
WIDTH REC S-O CENTER
    
```

9. In the screens for the KA1 point, KE1 point, KE2 point, and KA point that have been found, press **[CENTER]** to move to centerline peg settings.  
 Input Sta..ing (stationing to the CL peg) and press **[OK]** to calculate the coordinates of the arbitrary centerline peg. The results are then displayed on the screen.

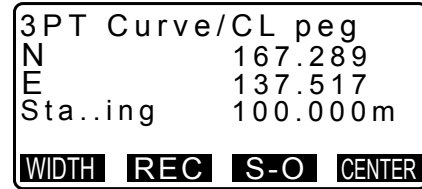
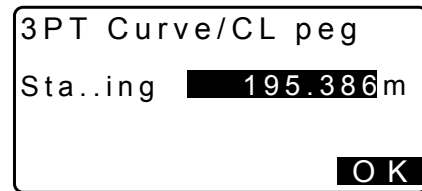

10. Press **{ESC}** repeatedly to finish 3 Point calculation and return to <Road>.

- Press **[WIDTH]** to move to the width peg setting screen.  
 [F] "25.2 Straight Line Calculation"
- The centerline peg can be set-out by pressing **[S-O]**.  
 [F] "15. SETTING-OUT MEASUREMENT"

**Note**

- In the case of a clothoid with no transition curve, the KA1 Point, KE1 Point, and KA2 Point can be found in step 8.
- In the case of a circular curve, the BCC Point and ECC Point can be found in step 8.

**25.7 Intersection Angle/Azimuth Angle Calculation**

The coordinates of a cardinal point, an arbitrary centerline peg, and width pegs can be found from an intersection angle, curve properties, and either the coordinates of 1 IP point of intersection or the azimuth angle from the BP Point to the IP point.

It is then possible to proceed with the setting-out of the cardinal point, centerline peg, and width pegs

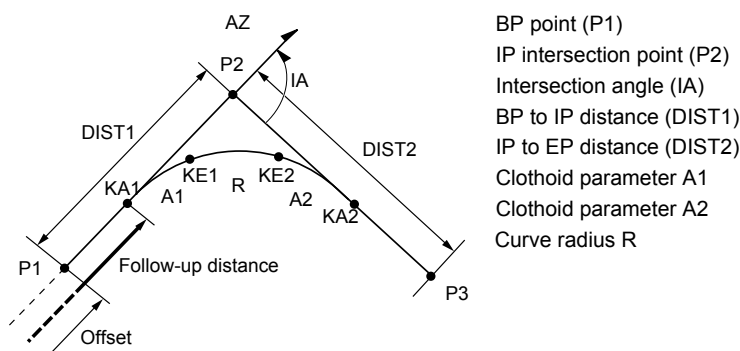

**PROCEDURE**

1. In the second page of the OBS mode screen, press **[MENU]**, then select "Road".

2. Select "IP&Tan" to enter the intersection angle/azimuth angle calculation menu.

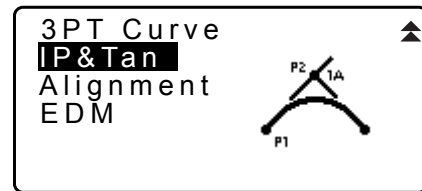

3. Input the coordinates of the BP point (reference point). Press **[OK]** to set the input values.

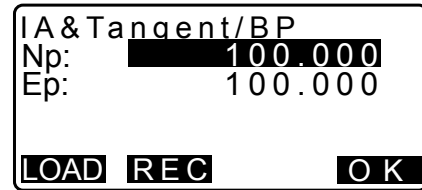

4. Input the coordinates of the IP point, then press **[OK]**.

• The azimuth angle can be set by pressing **[AZMTH]** on the second page.

5. Input curve properties: direction (of curve), IA (intersection angle), BP-IP (distance between BP Point and IP Point), IP-EP (distance between IP Point and EP Point), Para A1 (parameter A1), Para A2 (parameter A2), radius (of curve), and St. ofs (BP Point offset).

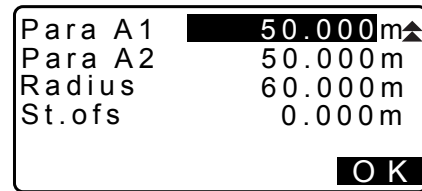
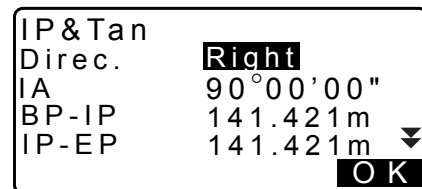

6. Press **[OK]** in the screen shown in step 5 to calculate the coordinates and follow-up distance of the KA1 point, KE1 point, KE2 point, and KA2 point. The results are then displayed on the screens shown here. Press **[RIGHT]**/**[LEFT]** to switch between <IA&Tangent/KA1>/<IA&Tangent/KE1>/<IA&Tangent/KE2>/<IA&Tangent/KA2>.

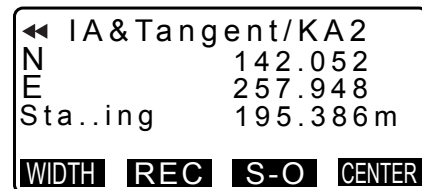
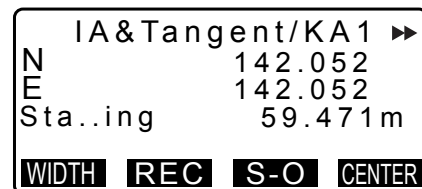

7. In the screens for the KA1 point, KE1 point, KE2 point, and KE2 point that have been found, press **[CENTER]** to move to centerline peg settings.  
Input Sta..ing (stationing to CL peg) and press **[OK]** to calculate the coordinates of the arbitrary centerline peg. The results are then displayed in this screen.

IA&Tangent/CL peg	
Sta..ing	195.386m
<b>OK</b>	

IA&Tangent/CL peg	
N	167.289
E	173.517
Sta..ing	100.000m
<b>WIDTH</b>	<b>REC</b>
<b>S-O</b>	<b>CENTER</b>

8. Press **{ESC}** repeatedly to finish calculation and return to <Road>.

- Press **[WIDTH]** to move to the width peg setting screen.

☞ "25.2 Straight Line Calculation"

- The centerline peg can be set-out by pressing **[S-O]**.

☞ "15. SETTING-OUT MEASUREMENT"

#### Note

- In the case of a clothoid with no transition curve, the KA1 Point, KE1 Point, and KA2 Point can be found in step 6.
- In the case of a circular curve, the BC Point and EC Point can be found in step 6.
- Intersection angle input range:  $0^\circ < IA < 180^\circ$

## 25.8 Route Calculation

Route Calculation is used to find the center pegs and width pegs of a route which contains a series of curves. It is then possible to proceed with setting-out. (The illustration below is an example of a clothoid calculation)

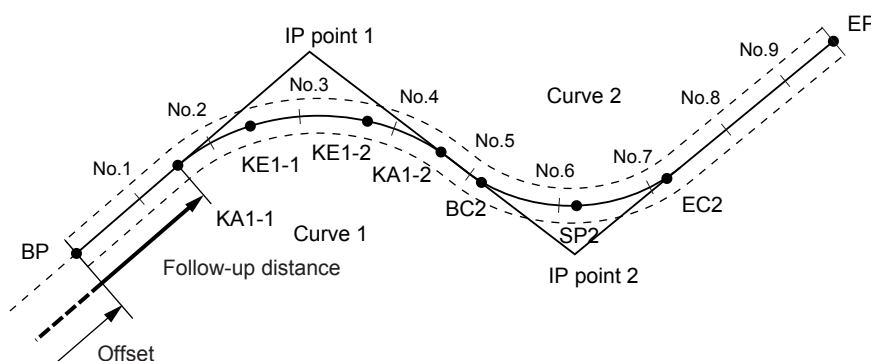

- Route Calculation includes the following:  
Curve properties input, curve properties display, automatic calculation of cardinal points, arbitrary point calculation, and inverse width peg calculation.
- In the Route Calculation menu it is possible to set one route per JOB, each route containing a maximum of 16 curves.
- Up to 600 points, including all center pegs and width pegs, can be calculated using automatic calculation of cardinal points.
- Route data is retained even when the power has been cut off. However, the route data will be cleared if the JOB is deleted or memory data is initialized.

 Deleting a JOB: "29.2 Deleting a JOB"

Memory initialization: ""33.12 Restoring Default Settings" PROCEDURE Restoring set items to initial settings and turning power on"



- Curve data is not set when curve properties (parameter A1, parameter A2, radius R) are all set to "Null".
- The rounding up of error values in curve calculation may create discrepancies (mm) in coordinates of peg No.

### 25.8.1 Inputting IPs (Intersection Points)

#### PROCEDURE

1. Enter the Route Calculation menu.  
Press **[MENU]** on the third page of the OBS mode to enter the Route Calculation menu.

2. Enter the Alignment Calculation menu.  
Select "Alignment".

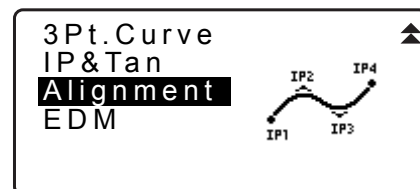

3. Enter the Curve Element Setting menu.  
Select "Define elements".

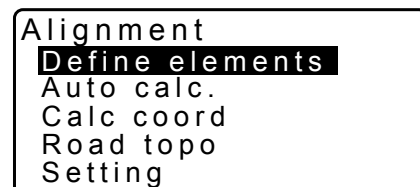

4. Enter the IP Inputting menu.  
Select "Input IP".

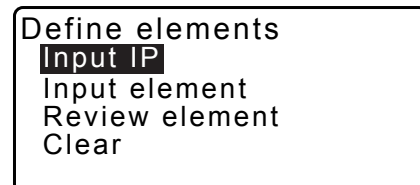

5. Set the base point (BP).  
Input the coordinate for the BP, and press **[NEXT]**.

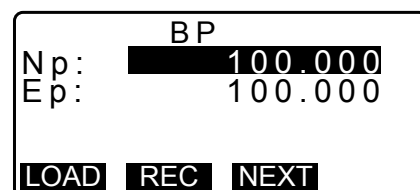

6. Set the IP 1.  
Input the coordinate for the IP 1, and press **[NEXT]**.

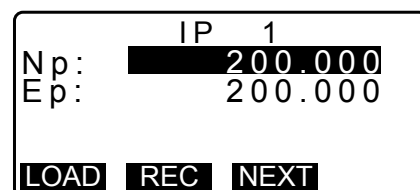

7. Set the following IPs.  
Input the following IPs in the same manner as step 6. To define the input IP as the end point (EP), press **[EP]**.

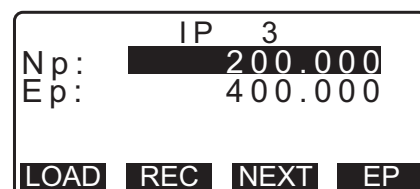



8. Check the EP.  
Check the coordinate for the EP, and press **[OK]**.

	EP	
Np:		200.000
Ep:		400.000
<Curve number:2>		
		<b>OK</b>

9. Quit inputting the IPs.  
Press **[OK]** in the screen shown in step 8.  
The screen returns to <Curve Element Setting>.

### 25.8.2 Inputting Curve Elements

- Automatic setting of the BP (step 3): You can set the BP for the next curve as the IP or the EP for the previous curve (KA-2 or the EC point) in advance.
- If multiple curves overlap when the next curve is calculated based on the input curve elements (when **[OK]** is pressed), the screen below is displayed.

Element 2-Element3
1mm
Curve overlap
Continue?
<b>YES</b> <b>NO</b>

- If the element starting point is located before the BP, the distance between those two points is displayed with minus (-).

BP-Element1
-10mm
Curve overlap
Continue?
<b>YES</b> <b>NO</b>

- If the element ending point exceeds the EP, the distance between those two points is displayed with plus (+).

Element n-ED
10mm
Curve overlap
Continue?
<b>YES</b> <b>NO</b>

Pressing **[YES]** continues the calculation, ignoring the overlap of the curves.  
Pressing **[NO]** stops the calculation and return to the Input Element screen.

1. Input the IPs.  
☞ 25.8.1 Inputting IPs (Intersection Points)

2. Enter the Input Element screen.  
Select "Input element".

Define elements
Input IP
<b>Input element</b>
Review element
Clear

## 3. Input the elements for the curve 1.

Input the parameter A1, parameter A2, radius R, and offset (additional distance for the BP: if the BP is located before the route starting point, minus (-) is accompanied) and press **[OK]**.

Element1	
Para A1	50.000m
Para A2	50.000m
Radius	60.000m
St. ofs	0.000m
	<b>IP</b> <b>OK</b>

- To set a dogleg, parameter A1 and A2 should be "Null" and radius should be 0.
- When **[IP]** is pressed, the intersection angle, turning direction, the lengths of the curves between BP-IP1 and IP1-IP2 are calculated from the BP, the IPs and the curve elements, and the results are displayed. After checking the results, press **[OK]**.

Element1	
IA	90° 00' 00"
Direct.	: Right
BP-IP1:	141.421m
IP1-IP2:	141.421m
	<b>OK</b>

## 4. Input the elements for the next curve.

Input the parameter A1, parameter A2 and radius R for the next curve.

- The offset is calculated automatically when "Next BP" described in 25.8.8 Setting parameters is set to "EC/KA2". The offset is not displayed when "Next BP" is set to "IP".
- When **[IP]** is pressed, the intersection angle, turning direction, the lengths of the curves between IP1-IP2 and IP2-IP3 are calculated from the BP, the IPs and the curve elements, and the results are displayed. After checking the results, press **[OK]**.

Element2	
Para A1	<Null>
Para A2	<Null>
Radius	50.000m
St. ofs	195.386m
	<b>IP</b> <b>OK</b>

## 5. Continue inputting the elements for the following curves.

Input the elements for the following curves in the same manner as shown in steps 3 and 4.

## 6. Quit inputting the curve elements.



When input of the elements for all curves is completed, press **[OK]**. The screen will return to <Curve Element Setting>.

### 25.8.3 Displaying curve properties

It is possible to check the curve properties set in "25.8.2 Inputting Curve Elements". To make alterations, follow the procedure described in "25.8.2 Inputting Curve Elements".

- The curve property data will be displayed in ascending order of curve number.

#### PROCEDURE

1. Input the IPs.  
 "25.8.1 Inputting IPs (Intersection Points)"
2. Input the elements for the curve.  
 25.8.2 Inputting Curve Elements

3. Align the cursor with "Review elements" and press **{ENT}**.  
Use **{▶}**/**{◀}** to move through property screens in the following order: BP Point -> IP Point -> EP Point -> curve properties -> BP Point of the next curve.

```
Define elements
Input IP
Input element
Review elements
Clear
```

```
Element1/BP ▶▶
Np:      100.000
Ep:      100.000
OK
```

⋮

```
◀◀ Element1 ▶▶
Para A1   50.000m
Para A2   50.000m
Radius    60.000m
St.ofs    0.000m
OK
```

4. Press **[OK]** to return to <Define elements>.

#### 25.8.4 Clearing Data

The route data set with the procedures in 25.8.1 Inputting IPs (Intersection Points) and 25.8.2 Inputting Curve Elements can be cleared.

#### PROCEDURE

- Enter the Route Calculation menu.  
Press **[MENU]** on the third page of the OBS mode to enter the Route Calculation menu.
- Enter the Alignment Calculation menu.  
Select "Alignment".
- Enter the Curve Element Setting menu.  
Select "Define elements".
- Enter the Clearing menu.  
Select "Clear".
- Clear the route data.  
Press **[YES]** to clear all the route data.

```
Define elements
Input IP
Input element
Review elements
Clear
```

- Pressing **[NO]** returns to the <Curve Element Setting> screen.

```
Clear Alldeletions
Confirm ?
NO YES
```

### 25.8.5 Automatic calculation of cardinal points

Perform automatic calculation of cardinal points based on the curve properties set in "25.8.2 Inputting Curve Elements". Center pegs (peg No.) and width pegs set up at intervals can be calculated at once.

- Up to 600 points, including all center pegs and width pegs, can be calculated using automatic calculation of cardinal points.
- The cardinal point calculated depends on the type of curve involved.
  - Clothoid: KA-1 Point, KE-1 Point, KE-2 Point, KA-2 Point
  - Clothoid with no transition curve: KA-1 Point, KE Point, KA-2 Point
  - Circular curve: BC Point, SP Point, EC Point
- The width pegs can be set up on both sides of the route and the left and right route widths calculated separately.
- A point name is automatically assigned to peg No. that can be calculated. The first part of the point name can be preset.
- The coordinates of calculated pegs are automatically stored in the current JOB. When a particular point name already exists in the current job the available option is possible to select whether or not to overwrite. It is possible to preset which procedure is used in this situation.

### PROCEDURE

1. In the second page of the OBS mode screen, press **[MENU]**, then select "Road".
2. Select "Alignment" to enter the Route Calculation menu.
3. Select "Auto calc." to enter the automatic calculation of cardinal points menu.

Alignment
Define elements
<b>Auto calc.</b>
Calc coord
Road topo
Setting

4. Set Sta incr (stationing increment), middle P, CL ofs1 (centerline offset 1), CL ofs2 (centerline offset 2), Existing (procedure used when the same point name already exists in the current JOB), and Autoname (automatically assigned suffix for point name).

Alignment
Sta incr <b>100.000</b> m
midpitch 90.000m
CL ofs1 5.000m
CL ofs2 -5.000m ▾
<b>OK</b>

ExistingPt <b>Add</b> ▲
Autoname No.
<b>OK</b>

5. Press **[OK]** in the screen shown in step 4 to calculate the coordinates of the cardinal point, width pegs and peg No. The coordinates are then displayed on the screens shown here. Use **[▶]/[◀]** to switch between screens. (Screens right are examples of a clothoid curve calculation).

Results		▶▶
N	100.000	
E	100.000	
PT	BP *	
<b>S-O</b>		<b>OK</b>

◀◀	Results	▶▶
N	96.465	
E	103.536	
PT	BPR *	
<b>S-O</b>		<b>OK</b>

◀◀	Results	▶▶
N	107.071	
E	107.071	
PT	No. 1	
<b>S-O</b>		<b>OK</b>

- When "Existing pt" in step 4 has been set to "Skip" a point with a point name which already exists in the current JOB will not be automatically stored. These points are marked with "\*". At this stage of the process it is possible to store such a point under a new point name.

◀◀	Results	▶▶
N	200.000	
E	400.000	
PT	EP *	
<b>REC</b>		<b>S-O</b>
<b>OK</b>		

6. The screen at right is displayed when the amount of set pegs exceeds 600 points. Press **[YES]** to continue using the initial 600 points. Press **[NO]** to return to the screen of step 4.

Memory over	
Continue?	
<b>YES</b>	
<b>NO</b>	

7. Press **[OK]** to return to <Alignment>.

- The center peg can be set-out by pressing **[S-O]**.  
 "15. SETTING-OUT MEASUREMENT"

#### Note

- Peg No. pitch input range: 0.000 to 9999.999 (100.000\*) (m)
  - Middle pitch input range: 0.000 to 9999.999 (0.000\*) (m)
  - Route width input range: -999.999 to 999.999 (Null\*) (m)
  - Duplicate point name procedure: Add (record as separate point with same point name)\*/Skip (no overwrite)
  - Maximum point name length: 8 characters ("peg No."\*)
- Cardinal point settings are retained even when the power has been cut off. However, the settings have been cleared if "RAM cleared" is displayed.



#### Rules regarding the assigning of point names to automatically calculated pegs.

- Clothoid curve cardinal point: the curve number is added at the end e.g. the KA1 Point of curve number 1 is written "KA1-1", and the KA1 Point of curve number 2 is written "KA2-1".
- Circular curve cardinal point: the curve number is added at the end e.g. the BC Point of curve number 1 is written "BC1", and the BC Point of curve number 2 is written "BC2".
- Width peg: "R" or "L" is added at the end of the center peg point name. "R" is added for positive (+) route widths (the route width from the center peg to the RIGHT width peg) and "L" is added for negative (-)

route widths (route width from the center peg to the LEFT width peg). When both route widths are input as positive (+) "R" and "R2" are used. When both route widths are input as negative (-) "L" and "L2" are used.

- A blank space at the beginning and end of a point name will be ignored.
- If the length of the point name being input exceeds 16 characters, 1 character at the beginning will be deleted for each new character input at the end of the point name.

### 25.8.6 Arbitrary point calculation

The coordinates of arbitrary points on every calculated curve can be found using arbitrary point calculation.

#### PROCEDURE

1. In the second page of the OBS mode screen, press **[MENU]**, then select "Road".
2. Select "Alignment" to enter the Route Calculation menu.
3. Select "Calc coord" to enter the arbitrary point calculation menu.

Alignment
Define elements
Auto calc.
<b>Calc coord</b>
Road topo
Setting

4. Input the arbitrary point follow-up distance.

Alignment/CL peg
Sta..ing <b>123.456</b> m
<b>POINT</b> <b>OK</b>

5. Press **[OK]** in the screen shown in step 4 to display the coordinates and point name of the arbitrary point.
  - The center point can be stored as a known point in the current job by pressing **[REC]**.

Alignment/CL peg
N 167.289
E 173.517
Sta..ing 100.000m
No. 12+3.456
<b>WIDTH</b> <b>REC</b> <b>S-O</b> <b>CENTER</b>

6. Press **{ESC}** to return to <Alignment>.
  - Press **[OFF]** to move to the width peg setting screen.
    - ☞ "25.2 Straight Line Calculation"
  - The center peg can be set-out by pressing **[CENTER]**.
    - ☞ "15. SETTING-OUT MEASUREMENT"



#### Rules regarding the automatic assigning of point names to arbitrary points

- Arbitrary point: The distance to the arbitrary point is given in terms of the closest peg No. from the front of the curve. The distance from the peg No. is added at the end.
- If the length of the point name being input exceeds 16 characters, 1 character at the beginning will be deleted for each new character input at the end of the point name.

### 25.8.7 Inverse width peg

The route widths and coordinates for center pegs on every calculated curve can be found by using inverse width peg calculation.

- There are two methods for specifying arbitrary width peg coordinates: key entry and observation.

#### PROCEDURE Using key entry to specify arbitrary width pegs

1. In the second page of the OBS mode screen, press **[MENU]**, then select "Road".
2. Select "Alignment" to enter the route calculation menu.
3. Select "Road topo" to enter the road topo menu.

```
Alignment
Define elements
Auto calc.
Calc coord
Road topo
Setting
```

4. Input the arbitrary width peg coordinates.

```
Alignment/Road topo
Np: 0.000
Ep: 0.000
LOAD MEAS OK
```

5. Press **[OK]** in the screen shown in step 4 to display the coordinates and point name of the center peg.

```
Road topo/CL peg
N 173.318
E 196.031
Sta..ing 123.456m
No. 12+3.456
REC S-O OK
```

6. Press **[OK]** in the screen shown in step 5 to display the route width and point name of the width peg.

```
Road topo/WidthPeg
N 173.318
E 196.031
CL ofs 5.000m
No. 12+3.456R
REC S-O OK
```

7. The next width peg can then be set by pressing **[OK]**.

- The center peg can be set-out by pressing **[S-O]**.

☞ "15. SETTING-OUT MEASUREMENT"

#### PROCEDURE Using observation to specify arbitrary width pegs

1. Enter the road topo menu in the same manner as shown above.
  - ☞ "PROCEDURE Using key entry to specify arbitrary width pegs" steps 1 to 3

2. Sight the width peg and press **[MEAS]** to start measurement. The coordinates and measurement distance of the width peg, vertical angle and horizontal angle are displayed.  
Press **[STOP]** to stop the measurement.

Alignment/Road topo	
Np:	0.000
Ep:	0.000
<b>LOAD</b> <b>MEAS</b> <b>OK</b>	

N	168.329
E	199.361
SD	3.780m
ZA	78°43'26"
HA-R	21°47'16"
<b>STOP</b>	

3. The coordinates and point name shown in this screen are used to display the results for the center peg.

Alignment/Road topo	
Np:	168.329
Ep:	199.361
Confirm?	
<b>NO</b> <b>YES</b>	

4. Press **[YES]** in the screen shown in step 3 to display the route width and point name of the width peg.

Road topo/CL peg	
N	173.318
E	196.031
Sta..ing	123.456m
No.2	
<b>REC</b> <b>S-O</b> <b>OK</b>	

5. The next width peg can then be set by pressing **[OK]**.

#### Note

- The rules regarding the assigning of point names to width pegs and center pegs are the same as those for when calculating width pegs in automatic calculation of cardinal points.  
 "25.8.5 Automatic calculation of cardinal points"  Rules regarding the assigning of point names to automatically calculated pegs"
- The rules regarding the assigning of point names to center pegs are the same as those for when calculating arbitrary points.  
 "25.8.6 Arbitrary point calculation"  Rules regarding the automatic assigning of point names to arbitrary points"

### 25.8.8 Setting parameters

When configuring curve properties in 25.8.2 Inputting Curve Elements, it is possible to preset which curve (clothoid or parabola) to calculate and which point to use as the BP Point of the next curve: the IP Point of the previous curve or the end-point (KA-2 or EC Point) of the previous curve.



#### PROCEDURE

- In the second page of the OBS mode screen, press **[MENU]**, then select "Road".
- Select "Alignment" to enter the Route Calculation menu.



3. Select "Setting" to enter the Setting Parameters menu.

```
Alignment
Define elements
Auto calc.
Calc coord
Road topo
Setting
```

4. Use / to select the automatic setting method for the BP Point of the next curve and curve type.

```
Alignment/Setting
Next BP : IP
Curve : Clothoid
```

• When curve properties are already input, curve type cannot be changed. First clear all route data.

 "25.8.2 Inputting Curve Elements"

```
Alignment/Setting
Next BP : IP
Curve : Clothoid
Existing curve
```

 Note

The automatic setting method can be selected from the following:

(\*: Factory setting)

- BP Point of the next curve: "IP" (IP Point of the previous curve)\*/"EC/KA2" (end-point of the previous curve (KA-2 or EC Point)).
- Curve: Clothoid\* / Parabola

# 26.CROSS SECTION SURVEY

The purpose of this function is to measure and set out points along a cross-section of a road or linear feature already surveyed using the route surveying function. Cross-sections can be surveyed in a variety of directions depending on your requirements.

☞ For terminology: "25. ROUTE SURVEYING"

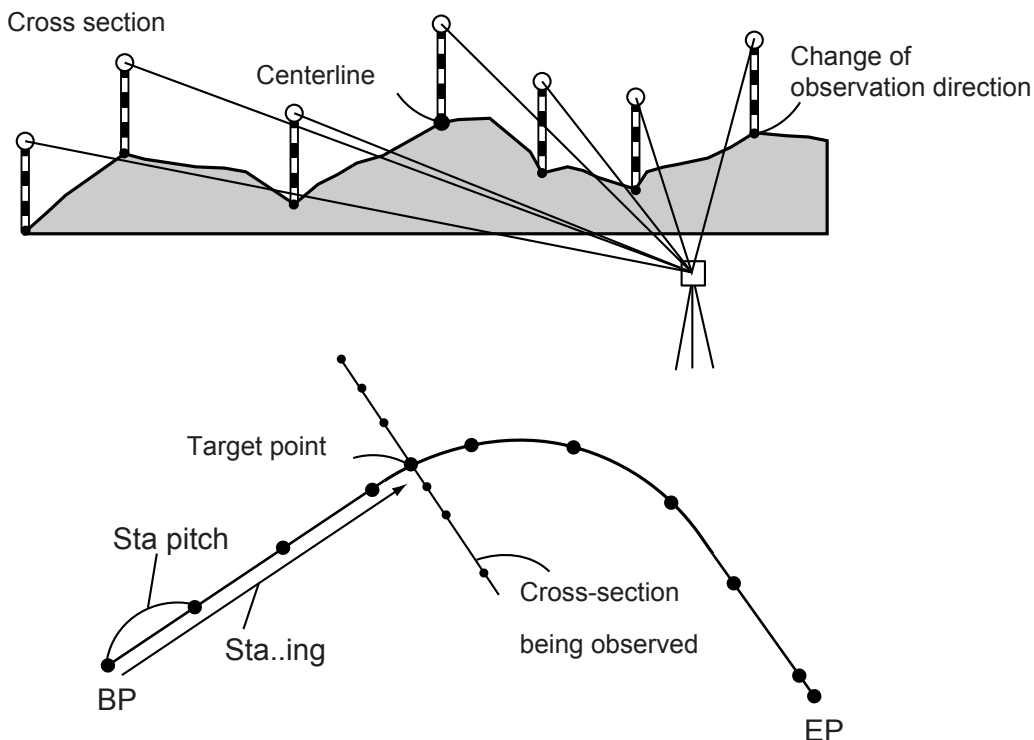

- EDM setting can be done in the cross section survey menu.  
☞ Setting items: "33.2 Observation Conditions - Dist"

## PROCEDURE

1. In the second page of OBS mode screen, press **[MENU]**, then select "Xsection Survey".
2. Select "Occ.orien" in <Xsection Survey> and enter instrument station data  
☞ "13.1 Entering Instrument Station Data and Azimuth Angle"
3. Select "Xsection Survey" in <Xsection Survey>

```
Xsection Survey
Occ.Orien.
Xsection Survey
EDM
```

```
Xsection Survey
Occ.Orien.
Xsection Survey
EDM
```

4. Input road name for cross section survey, station pitch, station increment, stationing chainage and select direction. Then press **[OK]**.

Xsection Survey  
 Road name: **Road3** **A**  
 Sta pitch: 100.000m **OK**

- Press **[STA-]/[STA+]** to decrease/increase the pitch set in "Sta incr" from/to "Stationing chainage". Stationing chainage is displayed as "xx+xx.xx".

Sta incr: 10.000m **▲**  
 Sta.ing: **55.200**m  
 Direc.: Left→Right  
**STA-** **STA+** **OK**

- In the event that stationing chainage was the same as the prior observation, cross-section survey is judged to have finished and a confirmation message window is displayed. Press **[YES]** to proceed to step 5. Press **[NO]** to set station pitch, station chainage, and direction again.

Same Sta...ing  
**NO** **YES**

5. Sight the last point on the cross-section and press **[MEAS]**.  
 ☞ "☐" Direction"

N  
 E  
 Z  
 ZA 89°59'50"  
 HA-R 125°32'20" **P1**  
**HT** **MEAS** **OK**

- Press **[HT]** to set instrument and target height.

- Press **[OFFSET]** on the second page to perform offset measurement for the last point.
- When observing the center point first, the center point needs to be set.  
 ☞ Step 8

6. Press **[REC]**. Enter target height, point name and code, then press **[OK]**.

N 103.514  
 E 101.423  
 Z 12.152  
 ZA 89°59'50"  
 HA-R 125°32'20" **P1**  
**REC** **HT** **MEAS** **OK**

N 344.284 **A**  
 E 125.891  
 Z 15.564  
 HR **2.000**m  
 PT P01 **OK**

7. Repeat steps 5 to 6 for all points on the cross-section in the set observation direction until the centerline is reached.

8. Observe the center point. Then press **[OK]**.

N 150.514  
 E 220.423  
 Z 80.150  
 ZA 89°59'50"  
 HAR 125°32'20" **P1**  
**REC** **HT** **MEAS** **OK**

Enter center point name. Then press **[OK]**.

```

3+3.200
Center:
  No.3+3.200
Finished section:
                               No
LOAD                               OK

```

- When the center point is set as the instrument station, press **[LOAD]** to read in already registered coordinate data and set as the coordinates of the instrument station.

 "13.1 Entering Instrument Station Data and Azimuth Angle PROCEDURE Reading in Registered Coordinate Data

9. Repeat steps 5 to 6 for all points on the cross-section occurring after the centerline.

10. After observing the last changing point, check that "Finished section" is set to "Yes", then press **[OK]**.

```

3+3.200
Center:
  No.3+3.200
Finished section:
                               Yes
LOAD                               OK

```

- Observation can be cancelled by pressing **{ESC}**. In this event, a confirmation message window is displayed. Press **[YES]** to discard measurement data observed up to that point and exit observation. Press **[NO]** to continue observation.

```

          Stop observing
Delete RPOS data?
                NO  YES

```

11. Proceed to observation of the next cross-section.

#### Note

- Road name: up to 16 characters
- Sta incr: -999999.999 to 999999.999 (m)
- Sta.ing: -99999.99999 to 99999.99999 (m)
- Sta pitch: 0.000 to 999999.999 (m)
- Direction: Left->Right/Right->Left/Left/Right

#### Direction

Cross-sections can be measured in the following directions depending on the setting selected in "Direction".

When "Left" or "Left -> Right" selected

Pattern 1: From left-most point to right-most point.

Pattern 2: Center point observed first. Then the point immediately to the left of the center point. Remaining points can then be observed in any order.

Pattern 3: Method using 2 prisms. Center point observed first followed by the point immediately to the left. Subsequent observations can be in whatever order is the most efficient for operation with 2 prisms. In the illustration below the points closest to the center point are observed first, followed by the outermost points (left first, then right).

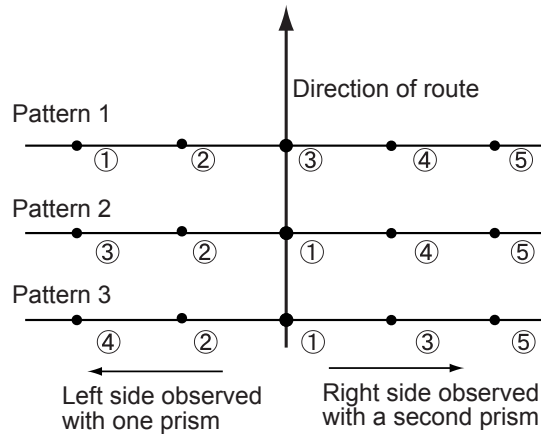

When "Right" or "Left -> Right" selected

Pattern 1: From right-most point to left-most point.

Pattern 2: Center point observed first. Then the point immediately to the right of the center point.

Remaining points can then be observed in any order.

Pattern 3: Method using 2 prisms. Center point observed first followed by the point immediately to the right. Subsequent observations can be in whatever order is the most efficient for operation with 2 prisms.

When "Left -> Right" or "Right -> Left" selected, observation of a subsequent cross-section can be switched automatically to the opposite direction upon completion of the previous cross-section observation. This method minimizes the walking distance to the next starting point when measuring multiple cross-sections.

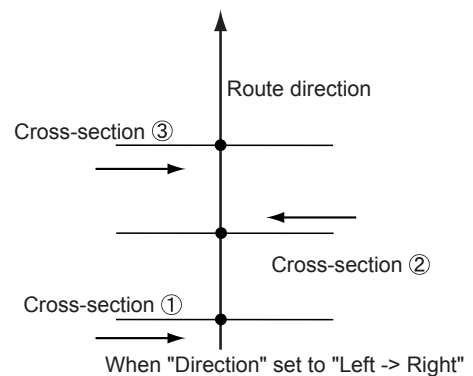

**Cross survey data review**

Cross-section data recorded in a JOB is displayed as shown at right. "Offset" represents the distance calculated from the center point coordinates and measurement point coordinates.

☞ Displaying JOB data: "28.8 Reviewing JOB Data"

Sta..ing	3+3.200
Offset	-12.820 m
HR	2.000 m
PT	XSECT03
<span style="border: 1px solid black; padding: 2px;">NEXT</span> <span style="border: 1px solid black; padding: 2px;">PREV</span>	

N	-320.500	▲
E	100.200	
Z	6.200	
CD		
:		
<span style="border: 1px solid black; padding: 2px;">NEXT</span> <span style="border: 1px solid black; padding: 2px;">PREV</span>		

# 27.POINT TO LINE MEASUREMENT

Point to line allows an operator to define the coordinates of the target point when a line connecting the base point A (0, 0, 0) and the point B is set as the X axis. The instrument's station coordinates and angle for an unknown point C is set by observing the point A and the point B.

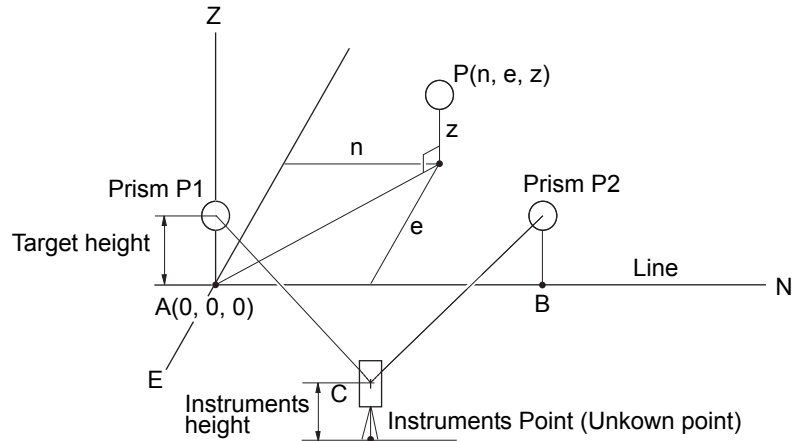

## PROCEDURE Setting Baseline

1. Press **[Menu]** on the second page of the OBS mode and select "Pt to line".

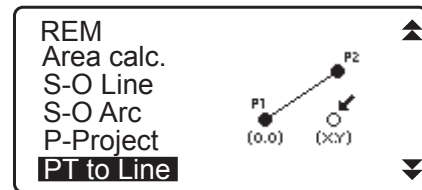

2. Select "Define baseline".

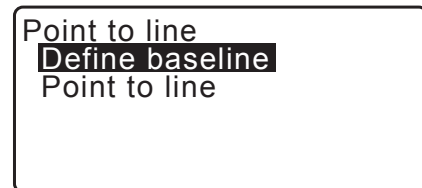

3. Enter an instrument height and press **[OK]**.

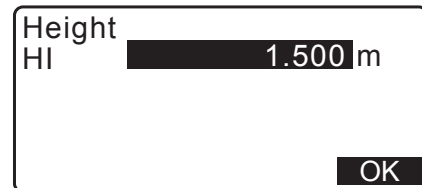

4. Collimate the first target point and press **[MEAS]**.

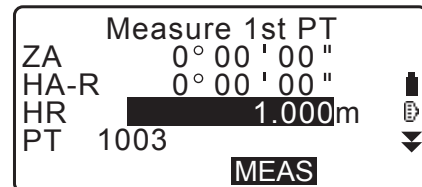

After confirming the measured result, press **[OK]**.

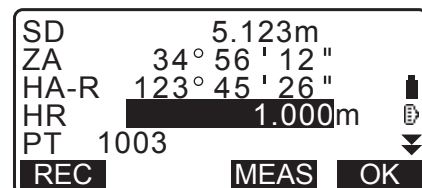

5. Measure the second target point in the same manner as the first one.

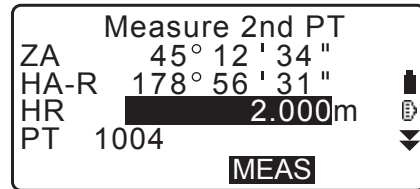

Confirm the measured result and press **[OK]**.

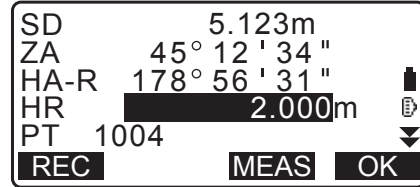

6. Confirm the measured result of the baseline defined from the line between the first target point and the second one.

Pressing **[OK]** sets the instrument's point coordinates and angle.

Continue with the measurement of Point to Line.

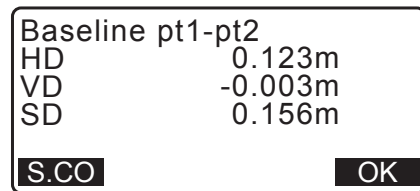

- Pressing **[S.CO]** displays the instrument point coordinates defined from the measurement results of the first target point and the second one. Pressing **[OK]** conducts measurement of Point to Line.

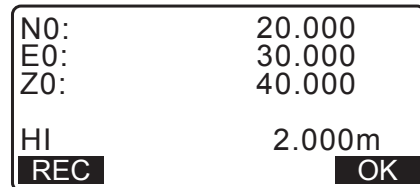

- Pressing **[REC]** records the coordinates for the instrument point as known point data in the current JOB. The instrument's station coordinates and height cannot be changed at this time.

**PROCEDURE Point to Line Measurement**

1. Press "Point to line" on the second page of the OBS mode.
2. Select "Point to line".

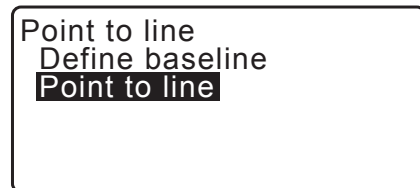

3. Collimate the target point and press **[MEAS]**. The measured result is displayed.

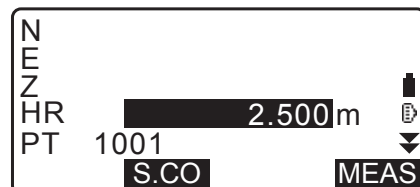

- Pressing **[REC]** records the coordinates of the target point as measured data in the current JOB.
- Pressing **[S.CO]** displays the coordinates of the instrument station.

N	20.000	
E	30.000	
Z	40.000	
HR	2.500m	☰
PT	1001	▼
<b>REC</b>	<b>S.CO</b>	<b>MEAS</b>

4. Collimate the next target point and press **[MEAS]** to begin measurement. It is possible to measure several points consecutively.
5. Pressing **{ESC}** returns to the <Point to Line> screen.



## 28.RECORDING DATA - TOPO MENU -

In Record menu, you can store the measurement data (distance, angle, coordinates), station point data, backsight station data, and note in the current JOB.

☞ "29. SELECTING/DELETING A JOB"

- A total of 50,000 data can be stored inside the instrument. Recording instrument station data and backsight station data is an exception.

Note

- If the same point name is input, the following screen is displayed.

N	5.544
E	-0.739
Z	0.245
PT	PNT-001
	Overwrite ?
<b>ADD</b>	<b>NO</b> <b>YES</b>

Press **[ADD]** to record the point as another record with the same name.

Press **[NO]** to input a new name.

Press **[YES]** to overwrite the present point.

### 28.1 Recording Instrument Station Data

Instrument station data can be stored in the current JOB.

- The items that can be recorded are the instrument station coordinates, point name, instrument height, codes, operator, date, time, weather, wind, temperature, air pressure, humidity and atmospheric correction factor.
- If instrument station data is not stored for the current JOB, the previously stored instrument data settings will be used.



#### PROCEDURE

1. Press **[TOPO]** in the third page of OBS mode to display <TOPO>.

- Current JOB name is displayed.

2. Select "Occupy".

TOPO JOB1
<b>Occupy</b>
BS data
Angle data
Dist data
Coord data



## 3. Set the following data items.

- (1) Instrument station coordinates
- (2) Point name
- (3) Instrument height
- (4) Code
- (5) Operator
- (6) Date (Display only)
- (7) Time (Display only)
- (8) Weather
- (9) Wind
- (10) Temperature
- (11) Air pressure
- (12) Humidity
- (13) Atmospheric correction factor

- Select **[LOAD]** to recall and use the registered coordinates.

"13.1 Entering Instrument Station Data and Azimuth Angle PROCEDURE Reading in Registered Coordinate Data".

- When inputting code, **[ADD]**, **[LIST]** and **[SRCH]** are displayed.

Press **[ADD]** to save input codes in memory.

Press **[LIST]** to display saved codes in reverse chronological order.

Press **[SRCH]** to search for a saved code.

For reviewing and saving codes in Data mode, see "30.3 Registering/Deleting Codes" and "30.4 Reviewing Codes"

- To set the atmospheric correction factor to 0 ppm, press **[0ppm]**. The temperature and air pressure are set to the default setting.

NO :	56.789
E0 :	-1234567.789
Z0 :	1.234
PT :	Pt.004
HI :	1.234m
<b>LOAD</b> <b>OK</b>	

CD	
:	pole
Operator :	
:	
<b>ADD</b> <b>LIST</b> <b>SRCH</b> <b>OK</b>	

Date :	Jan/01/2017
Time :	17:02:33
Weather :	Fine
Wind :	Calm
<b>OK</b>	

Temp. :	12°C
Press. :	1013hPa
ppm :	-3
<b>0ppm</b> <b>OK</b>	

4. Check the input data, then press **[OK]**.5. Press **{ESC}** to restore <TOPO>.

## Note

- Maximum point name size: 14 (alphanumeric)
- Input range of instrument height: -9999.999 to 9999.999 (m)
- Maximum code/operator size: 16 (alphanumeric)
- Weather selection: Fine, Cloudy, Light rain, Rain, Snow
- Wind selection: Calm, Gentle, Light, Strong, Very strong
- Temperature range: -35 to 60 (°C) (in 1°C step)/-31 to 140 (°F) (in 1°F step)
- Air pressure range: 500 to 1400 (hPa) (in 1hPa step)/375 to 1050 (mmHg) (in 1mmHg step)/14.8 to 41.3 (inchHg) (in 0.1inchHg step)
- Humidity range: 0 to 100 (%)
- Atmospheric correction factor range (ppm): -499 to 499
- The "Humid." is displayed only when the "Humid.inp" is set to "Yes".
- Above-described input ranges are the ranges when 1 mm is selected in "Dist.reso". When 0.1 mm is selected, values can be input to the first decimal place.
- "33.4 Observation Conditions - Atmosphere"

## 28.2 Recording Backsight Point

Backsight station data can be stored in the current JOB. Azimuth angle setting method can be selected from “inputting azimuth angle” or “calculating coordinates”.

### PROCEDURE Inputting azimuth angle

1. Press **[TOPO]** in the third page of OBS mode to display <TOPO>.
2. Select “BS data”.

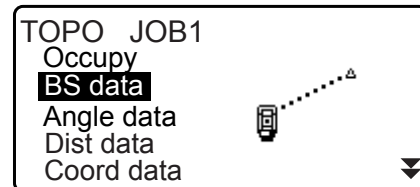

3. Select “Angle”.  
 Angle measurement values are displayed in real time.

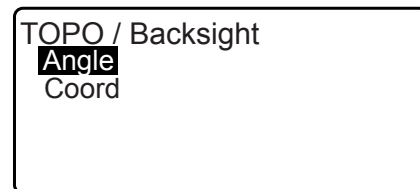

4. Input Azimuth angle.

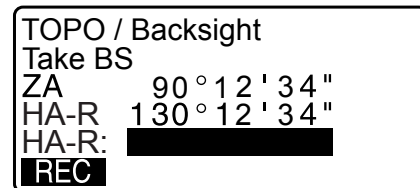

5. Sight the backsight and press **[REC]** in the screen of step 4, and set the following items.

- (1) Target height
- (2) Point name
- (3) Code

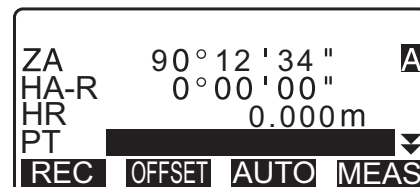

6. Press **[OK]** to record backsight station data. RED  
 (Reduced) data and angle measurement data are recorded at the same time. <TOPO> is restored.



### PROCEDURE Calculating azimuth angle by coordinates

1. Press **[TOPO]** in the third page of OBS mode to display <TOPO>.
2. Select “BS data”.
3. Select “Coord”.



4. Input the backsight station coordinates.

- When you wish to read in and set coordinate data from memory, press **[LOAD]**.

☞ "13.1 Entering Instrument Station Data and Azimuth Angle" PROCEDURE Reading in Registered Coordinate Data"

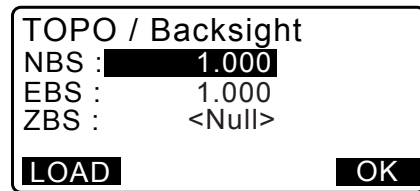

5. Press **[OK]** in the screen of step 4.

Angle measurement values are displayed in real time. Calculated Azimuth angle is also displayed.

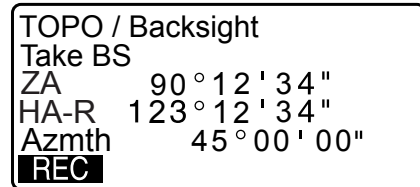

6. Sight the backsight and press **[REC]** in the screen of step 4, and set the following items.

- (1) Target height
- (2) Point name
- (3) Code

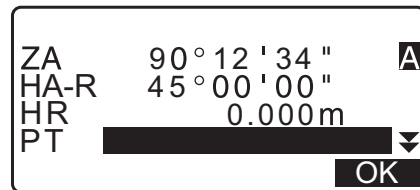

7. Press **[OK]** to record backsight station data. Known point data and angle measurement data are recorded at the same time. <TOPO> is restored.



### 28.3 Recording Angle Measurement Data

Angle measurement data can be stored in the current JOB.

#### PROCEDURE

1. Press **[TOPO]** in the third page of OBS mode to display <TOPO>.
2. Select "Angle data" and sight the point to be recorded. Angle measurement values are displayed in real time.

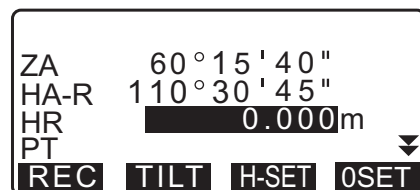
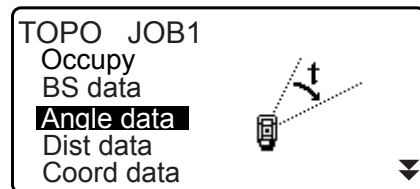

3. Set the following items.
  - (1) Target height
  - (2) Point name
  - (3) Code

ZA	60°15'40"	A
HA-R	110°30'45"	
HR	1.234m	
PT	1010	
REC TILT H-SET OSET		

CD		A
:		
ADD LIST SRCH OK		

4. Check the input data, then press **[REC]**.
5. Press {ESC} to quit measurement and restore <TOPO>.

## 28.4 Recording Distance Measurement Data

Distance measurement data can be stored in the current JOB.

### PROCEDURE

1. Press **[MEAS]** in the first page of OBS mode to perform distance measurement.  
 ☞ "12.2 Distance and Angle Measurement"
2. Press **[TOPO]** in the third page of OBS mode. <TOPO> is displayed.  
 Select "Dist data" to display the measurement results.

TOPO JOB1		
Occupy		
BS data		
Angle data		
<b>Dist data</b>		
Coord data		

3. Set the following items.
  - (1) Target height
  - (2) Point name
  - (3) Code

SD	123.456m	
ZA	80°30'15"	
HA-R	120°10'00"	
HR	1.234m	
PT		P1
REC OFFSET AUTO MEAS		

CD		A
:		
REC TILT H-SET OSET		

4. Check the input data, then press **[REC]**.

5. To continue measurement, sight the next point, press **[MEAS]**, then perform steps 3 and 4 above.

SD	123.456m
ZA	80°30'15"
HA-R	120°10'00"
HR	1.234m
PT	P1
OFFSET AUTO MEAS	

- Press **[AUTO]** to perform distance measurement and automatically record the results. **[AUTO]** is convenient for recording measurement data when target height, code and point name are not set.

- Press **[OFFSET]** to offset measurement in TOPO Mode.

SD	123.456m
ZA	80°30'15"
HA-R	120°10'00"
Recorded	

6. Press **{ESC}** to quit measurement and restore <TOPO>.



## 28.5 Recording Coordinate Data

Coordinate data can be stored in the current JOB

### PROCEDURE

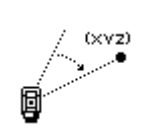
1. Perform coordinates measurement in the OBS mode screen.  
☞ "14. COORDINATE MEASUREMENT"
2. Press **[TOPO]** in the third page of OBS mode to display <TOPO>.  
Select "Coord data" to display the measurement results.

TOPO JOB1	
Occupy	
BS data	
Angle data	
Dist data	
<b>Coord data</b>	

N	344.284	
E	125.891	
Z	15.564	
HR	2.000m	
PT		
REC OFFSET AUTO MEAS		

3. Set the following items.
  - (1) Target height
  - (2) Point name
  - (3) Code
4. Check the input data, then press **[REC]**.
5. To continue measurement, sight the next point, press **[MEAS]**, then perform steps 3 and 4 above.
  - Pressing **[AUTO]** will start measurement, and automatically record the measured results. It is convenient to record measured data without setting the collimation height, code and point name.
  - Press **[OFFSET]** to start offset measurement.

6. Press **{ESC}** to quit measurement and restore <TOPO>.

## 28.6 Recording Distance and Coordinate Data

Distance measurement data and coordinate data can be stored in the current JOB at the same time.

- Both distance measurement data and coordinate data are recorded as the same point name.
- Distance measurement data is recorded first, then coordinate data is recorded.

### PROCEDURE

1. Press **[TOPO]** in the third page of OBS mode to display <TOPO>.  
Select "Dist + Coord" to display the measurement results.

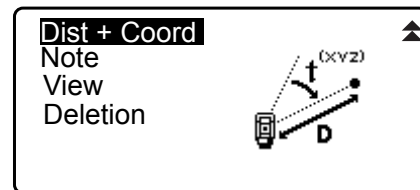

2. Sight the point and press **[MEAS]** to begin the measurement.  
The measurement results are displayed.

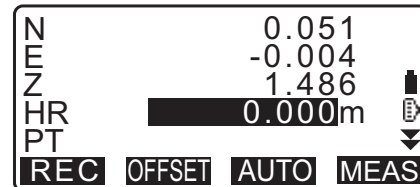

3. Set the following items.  
(1) Target height  
(2) Point name  
(3) Code

4. Check the input data, then press **[REC]**.

5. Press **{ESC}** to quit measurement and restore <TOPO>.

## 28.7 Recording Notes

This procedure prepares notes data and records it in the current JOB.

### PROCEDURE

1. Press **[TOPO]** in the third page of OBS mode to display <TOPO>.  
Select "Note".

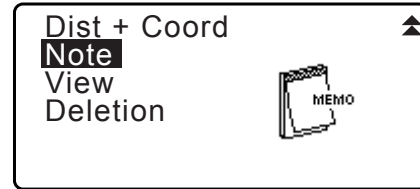

2. Enter the note data.

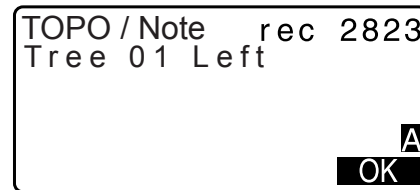

3. After inputting the note data, press **[OK]** to return to <TOPO>.



- Maximum note length: 60 characters (alphanumeric)

## 28.8 Reviewing JOB Data

It is possible to display the data within the current JOB that is selected.

- It is possible to search for data within the JOB to be displayed by point name. But the note data cannot be searched.
- Known point data that are entered from an external instrument are not reviewed.

### PROCEDURE Reviewing JOB data

1. Press **[TOPO]** in the third page of OBS mode to display <TOPO>.  
Select "View" to display the list of recorded points.

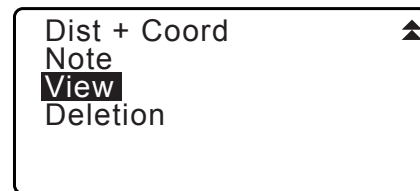



2. Select the point name to be displayed in detail and press **[ENT]**.

Details of the data are displayed. This screen contains distance measurement data.

SD	123.456 m
ZA	20°31'21"
HA-R	117°32'21"
HR	123.456 m
PT	1010
<b>NEXT</b> <b>PREV</b> <b>EDIT</b> <b>RED</b>	

- To display previous data item, press **[PREV]**.
- To display next data, press **[NEXT]**.
- Press **[EDIT]** to edit code/target height/point name of the selected point name. Items that can be edited depend on the type of data selected.  
Press **[OK]** to confirm changes and return to the previous screen.

- **[↑↓...P]** = Use **{▲}**/**{▼}** to move from page to page.
- **[↑↓...P]** = Use **{▲}**/**{▼}** to select individual point.
- Press **[FIRST]** to display first data.
- Press **[LAST]** to display last data.
- Press **[SRCH]** to search for point name. Input the point name after "PT".  
The search may take time if many data are registered.
- Press **[RED]** to display the reduced data screen shown at right.  
Press **[OBS]** to return to the previous screen.

HD	1234.456 m
VD	-321.123 m
Azmth	12°34'56"
HR	123.45 m
PT	1010
<b>NEXT</b> <b>PREV</b> <b>EDIT</b> <b>OBS</b>	

3. Press **{ESC}** to conclude detailed display and restore the list of points.  
Press **{ESC}** again to restore <TOPO>.

**Note**

- If more than two points with the same point name exist in the current JOB, iM finds the newer data only.

## 28.9 Deleting Recorded JOB Data

It is possible to delete data from the currently selected JOB.



- Deleting each data does not free the memory. When a JOB is deleted, the occupied memory is freed.  
 "29.2 Deleting a JOB"

### PROCEDURE Deleting Recorded JOB data

1. Press **[TOPO]** in the third page of OBS mode to display <TOPO>.  
 Select "Deletion" to display the list of recorded points.

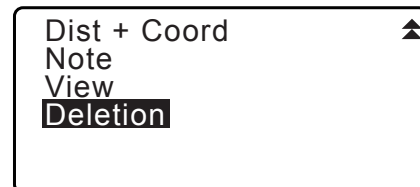

2. Select the data item to be displayed in detail and press **[ENT]**.  
 Details of the data are displayed.

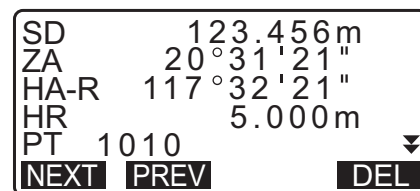

- To display previous data item, press **[PREV]**.
- To display next data, press **[NEXT]**.
- **[↑↓...P]** = Use **{▲}**/**{▼}** to move from page to page.
- **[↑↓...P]** = Use **{▲}**/**{▼}** to select individual point.
- Press **[FIRST]** to display first data.
- Press **[LAST]** to display last data.
- Press **[SRCH]** to search for point name. Input the point name after "PT".  
 The search may take time if many data are registered.

3. Press **[DEL]**. The selected measurement data will be deleted.

4. Press **{ESC}** to restore <TOPO>.



- Check data items before deleting to avoid losing important data.
- Deleting an important data item, such as instrument station coordinates, can prevent successful completion of software operations that require such data after outputting to an external device.

# 29.SELECTING/DELETING A JOB

## 29.1 Selecting a JOB

Select the current JOB and Coordinate Search JOB.

- A total of 99 JOBS have been prepared, and JOB1 was selected when your iM was shipped from the factory.
- The names of the JOBS have been preset as JOB1 to JOB99; you can change them to any names you wish.
- Scale factor can be set for each JOB. Only scale factor of the current JOB can be edited.



### Current JOB

Measurement results, instrument station data, known points data, notes and coordinate data are recorded in the current JOB.

☞ Registering known point data: "30.1 Registering/Deleting Known Point Data".



### Coordinate Search JOB

The registered coordinate data in the JOB selected here can be read into coordinate measurement, resection measurement, setting-out measurement, etc.



### Scale correction

iM calculates horizontal distance and coordinates of a point using measured slope distance. If scale factor has been set, scale correction is carried out during calculation.

Corrected horizontal distance (s) = Horizontal distance (S) × Scale factor (S.F.)

- When scale factor is set to "1.00000000", the horizontal distance is not corrected.

☞ Horizontal distance: "33.1 Observation Conditions - Angle/Tilt" ● Observation Condition ☞ Horizontal distance (H Dist)

## PROCEDURE JOB selection and scale factor setting

1. Select "JOB" in Data Mode.

```
Data
JOB
Known data
Code
```

2. Select "JOB selection".  
<JOB selection> is displayed.

```
JOB
JOB selection
JOB details
JOB deletion
Comms output
Comms setup
```

```
JOB selection
: JOB1
Coord search JOB
: JOB1

LIST
```

3. Press [LIST].

- JOB can also be selected by pressing  $\leftarrow\rightarrow$ .
- The numbers to the right represent the number of data items in each JOB.
- "\*" means that the JOB has not been output to an external device yet.

```
JOB selection
JOB01          46
*JOB02        254
JOB03          0
JOB04          0
JOB05          0
```

4. Align the cursor with the desired JOB as the current JOB and press **{ENT}**.  
The JOB is determined.
5. Press **{ENT}**.  
<JOB selection> is restored.
6. Align the cursor with "Coord search JOB" and press **[LIST]**.  
<Coord search JOB> is displayed.
7. Align the cursor with the desired JOB as the coordinate search JOB and press **{ENT}**.  
The JOB is determined and <JOB> is restored.

**Note**

- The list of JOB names is contained on up to 2 pages.

### PROCEDURE Inputting a JOB name

1. Select "JOB" in Data mode.
2. Select in advance the JOB whose name to be changed.  
☞ "PROCEDURE JOB selection and scale factor setting"
3. Select "JOB details" in <JOB>. After inputting the detailed information for the JOB, press **[OK]**.  
<JOB> is restored.
  - Enter the scale factor for the current JOB.

```

JOB
JOB selection
JOB details
JOB deletion
Comms output
Comms setup
  
```

```

JOB details
JOB name          A
JOB03
SCALE:1.00000000
OK
  
```

**Note**

- Maximum length of JOB name: 12 (alphanumeric)
- Scale factor input range: 0.50000000 to 2.00000000 (\*1.00000000)
- "A": Factory setting

## 29.2 Deleting a JOB

It is possible to clear the data within a designated JOB. After the data has been cleared, the JOB name returns to the name allocated when the iM was shipped.

**Note**

- A JOB that has not been output to an auxiliary device (displayed with \*) cannot be deleted.

### PROCEDURE

1. Select "JOB" in Data Mode.

2. Select "JOB deletion".  
<JOB deletion> is displayed.

- The numbers to the right represent the number of data items in each JOB.

```
JOB
JOB selection
JOB details
JOB deletion
Comms output
Comms setup
```

```
JOB deletion
JOB01                46
*JOB02                254
JOB03                0
JOB04                0
JOB05                0
```

3. Align the cursor with the desired JOB and press **{ENT}**.
4. Press **[YES]**. The data within the JOB selected is deleted and <JOB deletion> is restored.

```
JOB03
deletion
Confirm ?
NO YES
```

# 30.REGISTERING/DELETING DATA

## 30.1 Registering/Deleting Known Point Data

It is possible to register or delete coordinate data of the known points in the current JOB.  
The coordinate data that has been registered can be output during setting for use as instrument station, backsight station, known point, and setting-out point coordinate data.

- It is possible to register 50,000 items of coordinate data, including the data inside the JOBS.
- There are two registration methods: key entry and entry from an external instrument.
  - ☞ Communication cables: "38. ACCESSORIES"
  - Output format and command operations: "Communication manual"
- When entering known point data from an external device, iM does not check the repeated point name.
- Communication setup can be performed in the known data as well. Select "Comms Setup" in <Known data>.



- When "inch" is selected as the distance unit, the value must be input in "feet" or "US feet".
- Deleting each data does not free the memory. When a JOB is deleted, the occupied memory is freed.
  - ☞ "29.2 Deleting a JOB"

### PROCEDURE Using the key entry method to register known point coordinate data

1. Select "Known data" in Data Mode.

- Current JOB name is displayed.

```
Data
JOB
Known data
Code
```

2. Select "Key in coord" and input known point coordinates and point name.

```
Known data
Job:JOB1
Key in coord
Comms input
Deletion
View
```

```
rec 3991
N 567.950
E -200.820
Z 305.740
PT 5
```

3. After setting the data, press {ENT}.  
The coordinate data is recorded in the current JOB and screen in step 2 is restored.

```
rec 3990
N 567.950
E -200.820
Z 305.740
PT 5
Recorded
```

4. Continue to enter other known point coordinate data.

5. After the registration of all the coordinate data has been completed, press {ESC} to restore <Known data>.

**PROCEDURE Entering known point coordinate data from an external instrument**

1. Connect iM and host computer.
2. Select "Known data" in Data Mode.
3. Select "Comms input" to display <Comms input>.

```
Known data
Job.JOB1
Key in coord
Comms input
Deletion
View
```

Select the input format and press **[ENT]**.



- Select either "T type" or "S type" according to the communication format used.

"33.1 Observation Conditions - Angle/Tilt"  
Communication Setup

```
Comms input
T type
S type
```

When "T type" is selected

```
Comms input
GTS(Coord)
SSS(Coord)
```

Coordinate data starts to be entered from an external instrument and the number of received items is displayed on the screen. When data reception is completed, <Known data> is displayed.

- Press **{ESC}** to stop data reception in progress.

```
Comms input
Format      GTS(Coord)
Receiving   12
```

4. Receive the coordinate data for the next known point. Then, receive the coordinate data for other known points.
5. Finish inputting the known points. After all registration is complete, press **[ESC]**. It returns to <Known Point>.



- Selectable input formats
  - T type: GTS (Coord)/SSS (Coord)
  - S type: SDR33

**PROCEDURE Deleting designated coordinate data**

1. Select "Known data" in Data Mode.

2. Select "Deletion" to display the list of known point data.

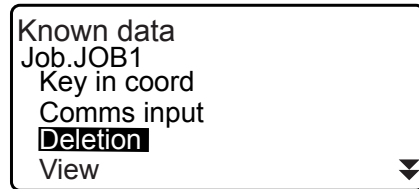

3. Select the point name to be deleted and press {ENT}.

- [↑↓...P] = Use {▲}/{▼} to move from page to page.
- [↑↓...P] = Use {▲}/{▼} to select individual point.
- Press [FIRST] to display top of point name list.
- Press [LAST] to display end of point name list.
- [SRCH]

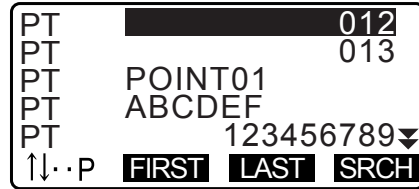

☞ "13.1 Entering Instrument Station Data and Azimuth Angle PROCEDURE Coordinate Data Search (Complete match) / PROCEDURE Coordinate Data Search (Partial match)"

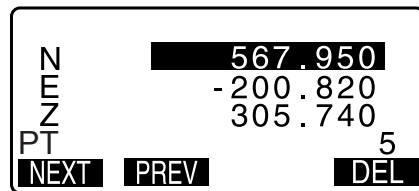

4. Press [DEL] to delete the selected point name.

- Press [PREV] to display previous data.
- Press [NEXT] to display next data.

5. Press {ESC} to quit the point name list and return to <Known data>.

**PROCEDURE Clearing all coordinate data at once (initialization)**

1. Select "Known data" in Data Mode.

2. Select "Clear" and press {ENT}.

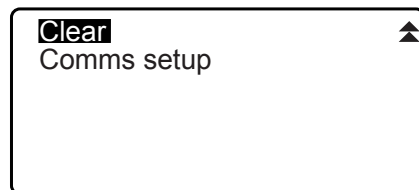

3. Press [YES].  
<Known data> is restored.

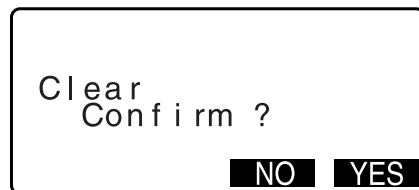



## 30.2 Reviewing Known Point Data

It is possible to display all the coordinate data within the current JOB.

### PROCEDURE

1. Select "Known data" in Data Mode.

- Current JOB name is displayed.

2. Select "View".

The point name list is displayed.

```
Known data
Job.JOB1
Key in coord
Comms input
Deletion
View
```

3. Select the point name to be displayed and press {ENT}.

The coordinates of the selected point name are displayed.

```
PT 012
PT 013
PT POINT01
PT ABCDEF
PT 123456789
↑↓·P FIRST LAST SRCH
```

```
N 567.950
E -200.820
Z 305.740
PT 5
NEXT PREV DEL
```

4. Press {ESC} to restore the point name list.

Press {ESC} again to restore <Known data>.

## 30.3 Registering/Deleting Codes

It is possible to save codes in memory. You can also read in codes registered in memory when recording instrument station data or observation data.

### PROCEDURE Inputting Codes

1. Select "Code" in Data Mode.

```
Data
JOB
Known data
Code
```

2. Select "Key in code".  
Enter the code and press **{ENT}**. The code is registered and <Code> is restored.



- Maximum code size: 16 (alphanumeric)
- Maximum number of codes registered: 60

```
Code
Key in code
Comms input
Comms output
Deletion
Code view
```

```
Code
: Pole
```

### PROCEDURE Entering code from an external instrument



- Only the codes for communication formats compatible with "T type" can be input.
- When registering the code, it is necessary to select "T type" in the communication setting.  
☞ "33.1 Observation Conditions - Angle/Tilt" Communication Setup

1. Connect the iM and a host computer in advance.
2. Select "Code" in the Data mode.

```
Data
JOB
Known data
Code
```

3. Select "Comms input" and press **[ENT]**.  
Code communication starts and the number of transmitted data is displayed. When transfer is completed, the screen returns to <Code>.
  - Pressing **{ESC}** stops data transfer.

```
Code
Key in code
Comms input
Comms output
Deletion
Code view
```

```
Code
Format CODE
Receiving 15
```

### PROCEDURE Deleting codes

1. Select "Code" in Data Mode.
2. Select "Deletion". The registered code list is displayed.

```
Code
Key in coord
Comms input
Comms output
Deletion
Code view
```

3. Align the cursor with the code to be deleted and press **[DEL]**.  
The designated code is deleted.

```

Pole
A001
TREE01LEFT
POINT01
POINT02
↑↓·P  FIRST  LAST  DEL

```

4. Press **{ESC}** to restore <Code>.

**Note**

- If you select “Clear list” in step 2 and then press **[YES]**, all registered codes are deleted.

## 30.4 Reviewing Codes

### PROCEDURE

1. Select “Code” in Data Mode.
2. Select “Code view”.  
The registered code list is displayed.
3. Press **{ESC}** to restore <Code>.

```

Code
Key in coord
Comms input
Comms output
Deletion
Code view

```

```

Pole
A001
Point 001
TREE01LEFT
POINT01
↑↓·P  FIRST  LAST

```

# 31.OUTPUTTING JOB DATA

It is possible to output JOB data to a host computer.

☞ Communication cables: "38. ACCESSORIES"

Output format and command operations: "Communication manual"

- Measurement results, instrument station data, known point data, notes, and coordinate data in the JOB is output.
- Known point data entered from an external instrument is not output.
- Communication setup can be performed in the JOB menu as well. Select "Comms Setup" in <JOB>.



- When "inch" is selected as the distance unit, data is output in "feet" or "US feet" depending on the feet unit selected.

## 31.1 Outputting JOB Data to Host Computer

### PROCEDURE

1. Connect iM and host computer.
2. Select "JOB" in Data Mode.

```
Data
JOB
Known data
Code
```

3. Select "Comms output" to display the JOB list.

```
JOB
JOB selection
JOB details
JOB deletion
Comms output
Comms setup
```

4. Select "T type" or "S type".  
Press [ENT] after selection.

```
Comms output
T type
S type
```

#### Note

- Select either "T type" or "S type" according to the communication format used.

☞ "33.1 Observation Conditions - Angle/Tilt"  
Communication Setup

5. Select the JOB to be output and press [ENT].  
"Out" appears to the right of the JOB selected. You can select as many JOBS as you want.

```
* JOB01      Out
JOB02      254
JOB03      Out
JOB04        0
JOB05        0
                OK
```

- "\*" means the JOB has not been output to an external device yet.

6. Press [OK].

7. Select the output format and press **{ENT}**.

When T type is selected

```
Comms output
GTS(Obs)
GTS(Coord)
SSS(Obs)
SSS(Coord)
```

When S type is selected

```
Comms output
SDR33
SDR2X
```

When "GTS (Obs)" or "SSS (Obs)" is selected, select the output format of distance data.

- Selecting "Obs data" outputs the slope distance. Selecting "Reduced data" outputs the horizontal distance data converted from the slope distance. (When the SSS format is selected, the height difference is also output.)

```
Comms output
Obs data
Reduced data
```



- When the instrument station data is not recorded during the measurement, selecting "Reduced data" may cause output of an unintended measurement result.
8. Press **{ENT}** to start outputting data in the current JOB.  
After output is completed, the screen returns to the list of JOBS, where you can output data in other JOBS.
- Press **{ESC}** to stop data output in progress.

## PROCEDURE Code output to a host computer



- Only the codes for communication formats compatible with "T type" can be output.
- When outputting the code, it is necessary to select "T type" in the communication setting.  
☞ "33.1 Observation Conditions - Angle/Tilt" Communication Setup

1. Connect the iM and a host computer in advance.
2. Select "Code" in the Data mode.

```
Data
JOB
Known data
Code
```

3. Select "Comms output" and press **{ENT}**. Code output begins. After code output is completed, the screen returns to the Code menu.

```
Code
Key in code
Comms input
Comms output
Dletion
Code view
```

## 32.USING USB FLASH DRIVE

It is possible to read in/output data from/to a USB flash drive.

- When using a USB flash drive, data is stored in the root folder. You cannot read/write data from/to subfolders.
- When using the iM, an MS-DOS-compatible text file can be input/output.



- When "S type" is selected, only files with an extension of "SDR" can be input/output. The iM cannot display files with an extension other than "SDR" stored in a USB flash drive. Also, an output code data file can be displayed only when "T type" is selected. (The same will apply to a case for saving a code while "S type" is selected.)
- You can neither save a file under the same name as a read-only file, nor change/delete the name of a read-only file. (However, this varies depending on the model or software you are using.)
- For "Communication Manual" that describes details on the communication formats used for inputting/outputting data to/from a USB flash drive, please consult with your local dealer.
- When using the iM, you can use a USB flash drive with the capacity of up to 32GB.

### 32.1 Inserting the USB flash drive



- Do not remove the USB flash drive during data read/write. Doing so will cause data stored in the USB flash drive or the iM to be lost.
- Do not remove the battery or turn OFF the power during data read/write. Doing so will cause data stored in the USB flash drive or the iM to be lost.
- Waterproofing property for this instrument is not secured unless the battery cover and external interface hatch are closed, and the connector caps are correctly attached. Do not use it with these open or loose, under the condition where water or other liquid spills over the instrument.  
The specification grade for water proofing and dust resistance is not guaranteed when using USB connector.

#### PROCEDURE Inserting USB Flash Drive

1. Open the external interface hatch.

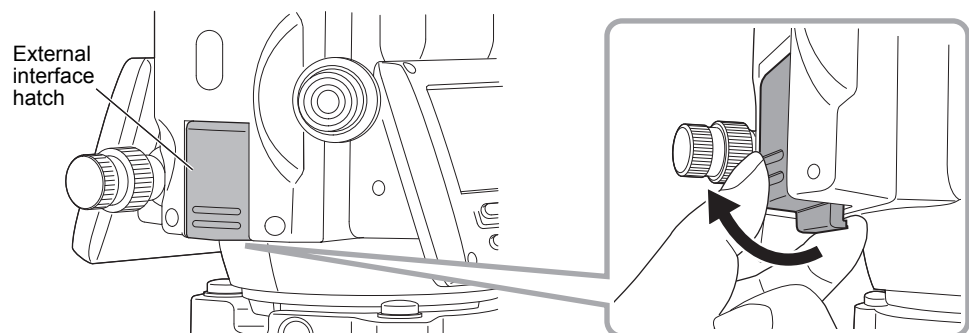

2. Insert the USB flash drive in the USB port.

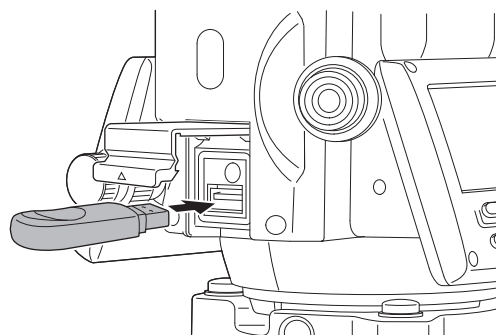



- When using a USB memory with 4 metal terminals on the surface, insert it with the terminal facing backwards to avoid damaging the USB port.

### PROCEDURE Removing USB Flash Drive

1. Remove the USB flash drive from the USB port.
2. Close the external interface hatch until a click is heard.



- It is recommended that you remove the USB flash drive after you finish inputting/outputting data and then return to the USB mode Menu.

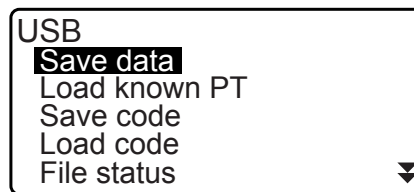

USB mode menu

If you remove the USB flash drive before returning to the above menus, the following display may be displayed when you insert it to your PC. Select "Scan and fix" to avoid this screen is displayed again.

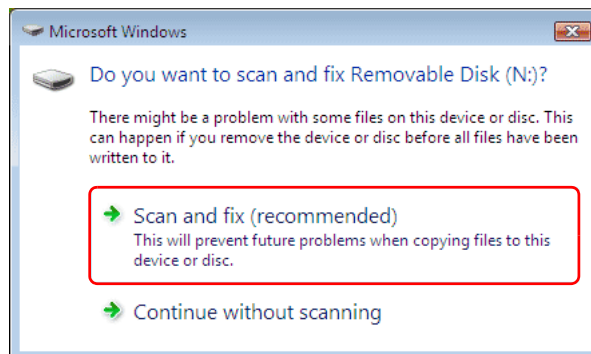

- Removing the USB flash drive before returning to the above menus itself will never damage the measurement data in the memory.

## 32.2 Selecting T type/S type

1. Press **[USB]** on the status screen.
2. Select "T type" or "S type".  
Press **[ENT]** after selection.



- Select either "T type" or "S type" according to the communication format used.

☞ "9. CONNECTING TO EXTERNAL DEVICES"



### 32.3 Storing JOB Data to USB flash drive

The measurement data (distance, angle, coordinate), known point data input on the iM, station point data and note stored in a JOB of the iM can be saved to the USB flash drive. Also, if multiple JOBS are selected, they can be saved to one file.

- When selecting S type, the data is saved as a file with an extension corresponding to the output communication format.
- When selecting T type, a file extension is automatically set corresponding to the output communication format, but it can be deleted or changed to any other extension.

#### PROCEDURE Data saving

1. Select "Save data" in USB mode.

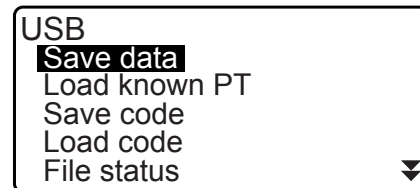

2. In the list of JOBS, select the JOB to be recorded and press **{ENT}**. "Out" is displayed to the right of the selected JOB. Multiple JOBS can be selected.

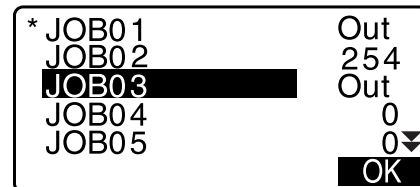

3. After selecting the JOB(s), press **[OK]**.

4. Select output format.  
 (When T type is selected)

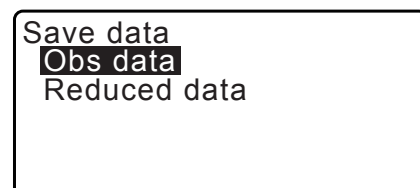
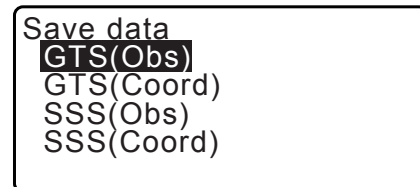

5. Enter the file name. Press **{ENT}** to set the data.

- File extension name can be entered when T type is selected. After entering file name, press **{ENT}/{▼}** to move the cursor to the extension name.

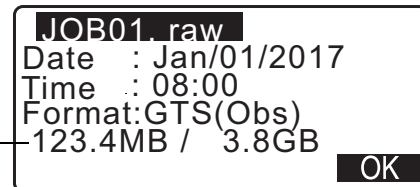

Remaining memory / Total memory size



6. Select output format.  
(When S type is selected)  
Align the cursor with "Format" to select the output format.
- Selecting "Yes" for "Send RED data" on the second page outputs the horizontal distance data converted from the slope distance.

```

JOB01. SDR
Date   : Jan/01/2017
Time   : 08:00
Format: SDR33
123.4MB / 3.8GB
OK
  
```

```

Send RED data : Yes
OK
  
```

7. Press **[OK]** to save the JOB to the external memory media.  
After saving a JOB, the screen returns to the JOB list.

If **{ESC}** is pressed while data is being recorded, data recording is canceled.

**Note**

- Maximum size of file name: 8 characters (alphanumeric) excluding the file extension.
- Characters used to make File name: Alphabet (capital letters only), special characters (-)
- Output format  
T type: GTS (Obs), GTS (Coord), SSS (Obs), SSS (Coord)  
S type: SDR33, SDR2x
- Maximum size of extension name: 3 characters (only when T type is selected)
- When a file is overwritten, the overwritten file is deleted.

## PROCEDURE Code saving

**Note**

- When saving the code, it is necessary to select "T type" in the communication setting. ☞ "33.1 Observation Conditions - Angle/Tilt" Communication Setup

1. Select "Save code" on the first page of the USB mode.

```

USB
Save data
Load known PT
Save code
Load code
File status
  
```

2. Specify a file name and press **{ENT}**.  
☞ Entering extension name: " PROCEDURE Data saving step5"

```

COD01. TXT
Date   : Jan/01/2017
Time   : 08:00
Format: CODE
123.4MB / 3.8GB
OK
  
```

Remaining memory / Total memory size

3. Pressing **[OK]** starts saving the code. When saving is completed, the screen returns to the list of JOBS.

Pressing **{ESC}** stops saving.

## 32.4 Loading Data in USB flash drive to the iM

The known point data or code previously saved in a USB flash drive can be loaded to the current JOB.

- Only coordinate records having a file format compatible with the iM can be loaded to the iM.  
 Output format and command operations: "Communication manual"

### PROCEDURE Reading Known Point Data

1. Select "Load known Pt." in Data mode.
2. Check the displayed current JOB name, then press **[OK]**
3. Select the input format.  
(When T type is selected)
4. In the list of files, select the file to be read in and press **{ENT}**.
5. Press **[YES]** to read in the file on the iM. <Media> is restored.  
  
To cancel reading, press **{ESC}**.

```

USB
Save data
Load known PT
Save code
Load code
File status
  
```

```

Load known PT
Job.JOB1
OK
  
```

```

Load known PT
GTS(Coord)
SSS(Coord)
OK
  
```

```

ABCDE XYZ
FGHI PNT
JKLMNOPQ TXT
ZZZ SDR
  
```

```

ABCDE XYZ
5354byte
Jan/01/2017 17:02
Format :GTS(Coord)
Confirm ?
NO YES
  
```

### PROCEDURE Loading code

1. Select "Load code" on the first page of the USB mode.

```

USB
Save data
Load known PT
Save code
Load code
File status
  
```

2. Select a file having code data you wish to load and press {ENT}.

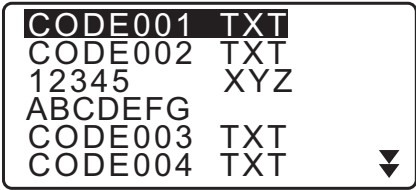

3. Pressing [YES] starts loading the file. When loading is completed, the screen returns to <USB>.

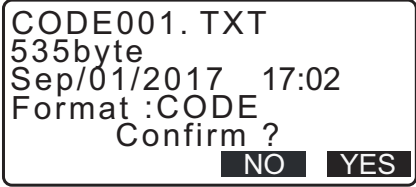

**32.5 Displaying and Editing Files**

By selecting "File status", file information can be displayed, file names can be edited and files can be deleted.

- When deleting all files together, format the external memory media.  
 [F] "32.6 Formatting the Selected External Memory Media"

**PROCEDURE Displaying File Information**

1. Select "File status" in USB mode.

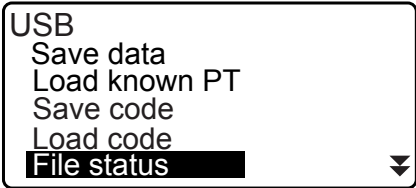

2. In the list of the files stored in the external memory media, select a file to be displayed and press {ENT}. Details of the file are displayed.

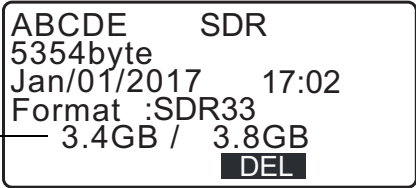

Remaining memory / Total memory size

3. Press {ESC} to return to the file list.

**PROCEDURE Deleting a File**

1. Follow steps 1 to 2 in "PROCEDURE Displaying File Information" until the screen shown at right is displayed.

```

ABCDE   SDR
5354byte
Jan/01/2017   17:02
Format :SDR33
3.4GB / 3.8GB
      DEL

```

2. Press **[DEL]**. Press **[YES]**. The file is deleted and the screen returns to the file list.

**32.6 Formatting the Selected External Memory Media**

By selecting "Quick format", the USB flash drive can be formatted.



- All data in the USB flash drive including hidden files is deleted.
- To initialize using a PC, select "FAT" or "FAT 32" in "File System".

**PROCEDURE**

1. Select "Quick format" in USB mode.

```

Quick format  ▲

```

2. Press **[YES]** to format. When formatting is completed, <Media> is restored.

```

Format USB
Confirm ?
      NO  YES

```

# 33.CHANGING THE SETTINGS

This section explains the contents of parameter settings, how to change settings and how to perform initialization. Each item can be changed to meet your measurement requirements.

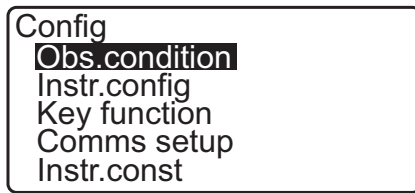

The following items in Configuration mode are explained in other chapters.

- Communication settings "9. CONNECTING TO EXTERNAL DEVICES"
- Instrument configurations "35.2 Tilt Sensor", "35.3 Collimation"

## 33.1 Observation Conditions - Angle/Tilt

Select "Obs.condition" in Config mode and select "Angle/Tilt".

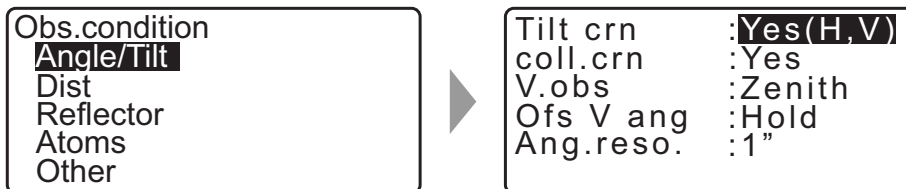

### Items set and options (\*: Factory setting)

- Tilt crn (Tilt angle compensation) : Yes(H,V)\*, Yes(V), No
- coll. crn (Collimation correction) : Yes\*, No
- V.obs (Vertical angle display method) : Zenith\*, Horiz, Horiz 90° (Horizontal ±90°)
- Ofs V ang : Hold\*, Free
- Ang.reso.(Angle resolution) : 1", 5"\*

### Automatic tilt angle compensation mechanism

The vertical and horizontal angles are automatically compensated for small tilt errors using the 2-axis tilt sensor.

- Read the automatically compensated angles when the display has stabilized.
- The horizontal angle error (vertical axis error) fluctuates according to the vertical axis, so when the instrument is not completely leveled, changing the vertical angle by rotating the telescope will cause the displayed horizontal angle value to change.  
Compensated horizontal angle =  
Measured horizontal angle + Tilt in horizontal axis direction /tan (Vertical angle)
- When the telescope is directed close to the zenith or nadir angle, tilt compensation is not applied to the horizontal angle.

### Collimation correction

The iM has a collimation correction function that automatically corrects horizontal angle errors caused by horizontal axis and leveling axis errors. Normally set this item to "Yes".

**V obs. (vertical angle display method)**

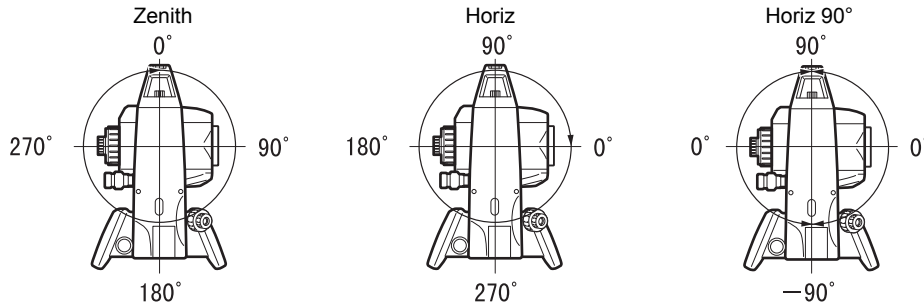

**Ofs V ang**

Select whether the vertical angle is fixed in the angle offset measurement.

**33.2 Observation Conditions - Dist**

Select "Obs.condition" in Config mode and select "Dist".

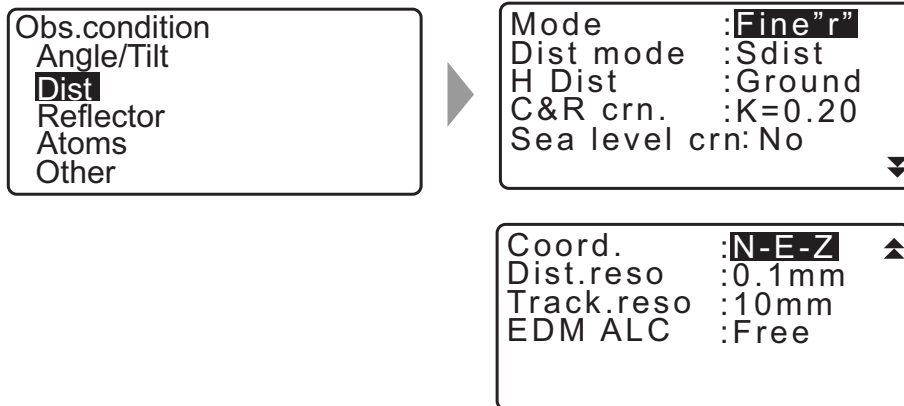

**Items set and options (\*: Factory setting)**

- Mode (Distance measurement Mode) : Fine "r"\*, Fine AVG (Setting: 1 to 9 times), Fine "s", Rapid "r", Rapid "s", Tracking, Road
- Dist mode : Sdist\*, Hdist, Vdist
- H Dist (Horizontal distance display method) : Ground\*, Grid
- C&R crn. (Earth curvature and refraction correction):  
No, K=0.142, K=0.20\*
- Sea level crn (Sea level correction) : Yes, No\*
- Coord. : N-E-Z\*, E-N-Z
- Dist.reso (Distance resolution) : 0.1 mm, 1 mm\*
- Track.reso : 1 mm, 10 mm\*
- EDM ALC : Hold, Free\*

• Input the number of the times for "Fine AVG" distance measurement mode using {F1} (↑) or {F2} (↓).

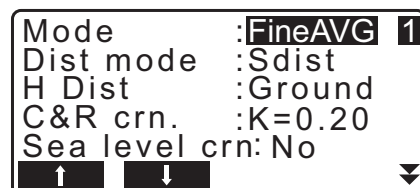

- "Road" in "Mode (Distance measurement Mode)" is displayed only when "N-Prism" is selected in <Reflector>.

 "33.3 Observation Conditions - Reflector (Target)"



### Road

"Road" is the specialized distance mode to measure road surface etc. by sighting obliquely and to obtain rough measurement values. "Road" can be selected only when "Reflector" is set to "N-Prism". Even if "Road" is selected, "Distance mode" changes to "Tracking" automatically when "Reflector" is set to other than "N-Prism".



### Horizontal distance (H Dist)

The iM calculates the horizontal distance using the slope distance.

There are the following 2 ways to display the horizontal distance data.

Ground:

The distance that reflects neither the Sea level correction factor nor the Scale factor.

Grid:

The distance in the plane rectangular coordinates system that reflects the Sea level correction and Scale factors (or the distance in the plane rectangular coordinates system that reflects the Scale factor only, when "No" is set for "Sea level crn".)

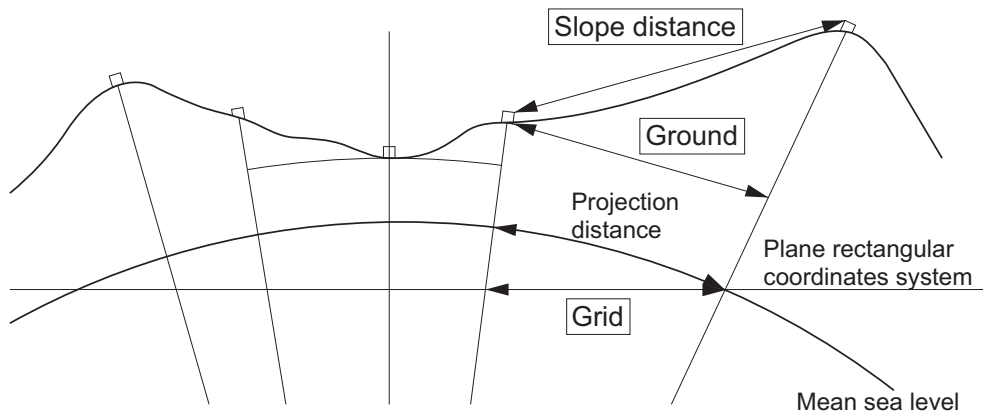

- The horizontal distance data recorded in this instrument is the ground distance only, and the displayed value changes according to the settings for the horizontal distance. When reviewing the observation data in the TOPO menu, set "Horizontal distance" and "Scale factor" so that the intended value is displayed.
- If horizontal distance is requested when selecting "T type" or by the GTS command, uncorrected "ground distance" is output, regardless of the Sea level correction or Scale factor setting.



### Sea level correction

The iM calculates horizontal distance using slope distance values. As this horizontal distance does not take height above sea level into consideration, performing spherical correction is recommended when measuring at high altitudes. Spherical distance is calculated as follows.

$$(HDg) = \frac{R}{(R + H)} \times HD$$

Where:

R = radius of the spheroid (6371000.000 m)

H = averaged elevation of the instrument point and target point

HDg = Spherical distance

HD = horizontal distance

- \*1 The averaged elevation is automatically calculated from the instrument point elevation and the collimation point elevation.

### **Dist.reso. (Distance resolution)**

Select distance resolution of fine measurement. Distance resolution of rapid and tracking measurement will shift with this setting.

### **Tracking reso. (Tracking resolution)**

Select distance resolution of tracking measurement and road measurement (N-prism only). Set this setting depending on the measurement purpose like measuring a moving target.

### **EDM ALC**

Set the light receiving status of the EDM. While carrying out continuous measurement, set this item according to the measurement conditions.

- When EDM ALC is set to "Free" the instrument's ALC will be automatically adjusted if an error occurs as a result of the amount of light received. Set to "Free" when the target is moved during measurement or different targets are used.
- When "Hold" is set, the amount of light received will not be adjusted until initial adjustment has been performed and continuous measurement completed.
- Try setting to "Hold" when the light beam used for measurement is stable but is frequently obstructed by obstacles such as people, cars, or tree branches etc. preventing measurement from being performed.

#### **Note**

- When the distance measurement mode is set to "Tracking" (target is moving during distance measurement), the distance will be measured in "Free" status regardless of the EDM ALC setting.

## 33.3 Observation Conditions - Reflector (Target)

Select "Obs.condition" in Config mode and select "Reflector".

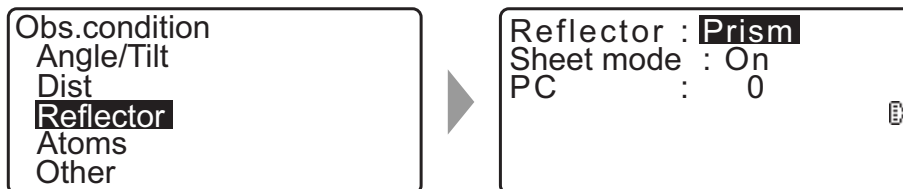

### **Items set and options (\*: Factory setting)**

Reflector : Prism\*, Sheet, N-prism (reflectorless)  
 Sheet mode : On\*, Off  
 PC (Prism constant correction value) : -99 to 99 mm ("Prism" is selected: 0\*, "Sheet" is selected: 0\*)

#### **Note**

- Above-described input ranges are the ranges when 1 mm is selected in "Dist.reso". When 0.1 mm is selected, values can be input to the first decimal place.

### **Sheet mode (Selecting target)**

Target can be changed by selecting an option in "Reflector" in the Obs. condition, or by pressing **{SHIFT}** in the screen where the target symbol is displayed. The selection items can be preset to "Prism/Sheet/N-prism (reflectorless)" or "Prism/N-prism (reflectorless)".

### **Prism constant correction**

Reflective prisms each have their prism constant.

Set the prism constant correction value of the reflective prism you are using. The prism constant correction value is a value that the prism constant is inverted to positive or negative. (E.g. if the prism constant is 40 mm, the correction value turns to -40 mm.)

When selecting "N-prism (Reflectorless)" in "Reflector", prism constant correction value is set to "0" automatically.





- Press **[EDM]** in Observation mode to display <EDM> and to perform target and atmospheric condition settings.

```
EDM
Mode   : Fine "r"
Reflector: Prism
PC     : 0
```

```
EDM
Temp.  : 15 °C
Pres.  : 1013hPa
ppm    : 0
0ppm
```

### 33.4 Observation Conditions - Atmosphere

Select "Obs.condition" in Config mode and select "Atmos".

```
Obs.condition
Angle/Tilt
Dist
Reflector
Atmos
Other
```

```
Temp.  : 15 °C
Pres.  : 1013hPa
Humid.inp:No(50%)
ppm    : 0.0
0ppm
```

- **[0ppm]**: Atmospheric correction factor returns to 0 and temperature and air pressure are set to the default values.
- Atmospheric correction factor is calculated and set using the entered values of the temperature and air pressure. Atmospheric correction factor can also be entered directly.

#### Items set and options (\*: Factory setting)

Temp. (Temperature)	: -35 to 60°C (15*)
Air pressure	: 500 to 1400hPa (1013*)/375 to 1050mmHg (760*)
Humid.imp (Humidity input)	: No (50%), Yes
Humid. (Humidity)	: 0 to 100% (50*)
ppm (Atmospheric correction factor)	: -499 to 499 (0*)



- The "Humid." is displayed only when the "Humid.inp" is set to "Yes".
- Above-described input ranges are the ranges when 1 mm is selected in "Dist.reso". When 0.1 mm is selected, values can be input to the first decimal place.

```
Temp.  : 15.0 °C
Pres.  : 1013.3hPa
Humid.inp:Yes
Humid.  : 45.0%
ppm    : 0.0
0ppm
```



#### Atmospheric correction factor

The velocity of the light beam used for measurement varies according atmospheric conditions such as temperature and air pressure. Set the atmospheric correction factor when you wish to take this influence into account when measuring.

- The instrument is designed so that the correction factor is 0 ppm at an air pressure of 1013.25 hPa, a temperature of 15°C, and a humidity of 50%.
- By inputting the temperature, air pressure values and humidity, the atmospheric correction value is calculated using the following formula and set into the memory.

$$\text{Atmospheric Correction Factor (ppm)} = 282.324 - \frac{0.294280 \times p}{1 + 0.003661 \times t} + \frac{0.04126 \times e}{1 + 0.003661 \times t}$$

t: Air temperature (°C)  
 p: Pressure (hPa)  
 e: Water vapor pressure (hPa)  
 h: Relative humidity (%)  
 E : Saturated water vapor pressure

- e (water vapor pressure) can be calculated using the following formula

$$e = h \times \frac{E}{100} \frac{(7.5 \times t)}{(t + 237.3)}$$

$$E = 6.11 \times 10^{(t + 237.3)}$$

- The instrument measures the distance with a beam of light, but the velocity of this light varies according to the index of refraction of light in the atmosphere. This index of refraction varies according to the temperature and pressure. Near normal temperature and pressure conditions:

With constant pressure, a temperature change of 1°C: an index change of 1 ppm.

With constant temperature, a pressure change of 3.6 hPa: an index change of 1 ppm.

To perform high accuracy measurements, it is necessary to find the atmospheric correction factor from even more accurate temperature and pressure measurements and perform an atmospheric correction. It is recommended that extremely precise instruments be used to monitor the air temperature and pressure.

- Enter the average temperature, air pressure and humidity along the measurement beam route in "Temperature", "Pressure" and "Humidity".

Flat terrain: Use the temperature, pressure and humidity at the midpoint of the line.

Mountainous terrain: Use the temperature, pressure and humidity at the intermediate point (C).

If it is not possible to measure the temperature, pressure and humidity at the midpoint, take such measurements at the instrument station (A) and the target station (B), then calculate the average value.

Average air temperature :  $(t_1 + t_2)/2$   
 Average air pressure :  $(p_1 + p_2)/2$   
 Average humidity :  $(h_1 + h_2)/2$

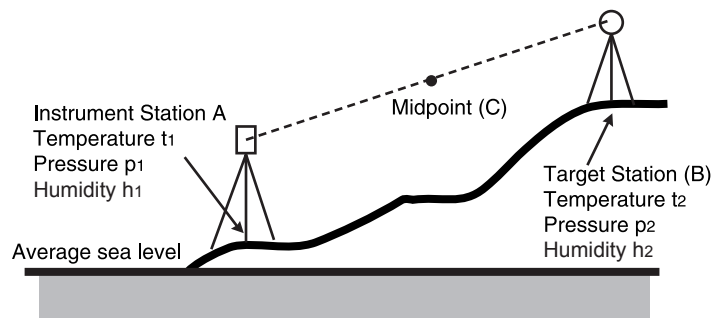

- If the weather correction is not required, set the ppm value to 0.

### 33.5 Observation Conditions - Other

Select "Obs.condition" in Config mode and select "Other".

Obs.condition Angle/Tilt Dist Reflector Atoms <b>Other</b>	➔	Input order : <b>PT</b> ➔ <b>CODE</b> Stn.ID Incr. : 100 Intersection : Type B
---	---	--

**Items set and options (\*: Factory setting)**

Input order : PT ➡ CODE\*/CODE ➡ PT  
 Stn.ID Incr. (station ID increment) : 0 to 99999 (100\*)  
 Intersection : Type A/Type B\*

**Input order**

The input order of point name and code in recording screens can be selected.

**Intersection**

Select a suitable intersection type in advance.

☞ "23. INTERSECTIONS"

### 33.6 Instrument Conditions - Power

Select "Inst. Config" in Config mode and select "Power supply".

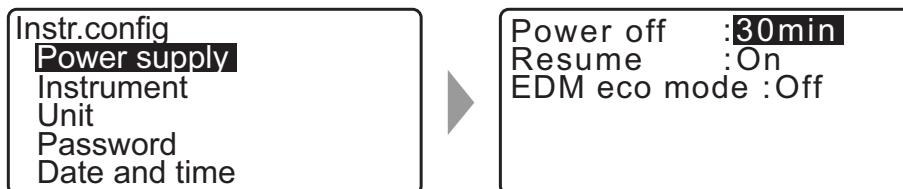
**Items set and options (\*: Factory setting)**

Power off : 5 min, 10 min, 15 min, 30 min\*, No  
 Resume : On\*, Off  
 EDM eco mode : On, Off\*

**Power-saving automatic cut-off**

To save power, power to the iM is automatically cut off if it is not operated for the selected time.

**Resume function**

When the Resume function is set to "On" and the power is switched off and then on again, the screen appearing before the instrument was switched off, or a prior screen is redisplayed.



- When the Resume function is set to "Off", values input before the power is switched off will disappear.

**EDM eco mode**

Working duration will be longer by controlling and saving power to the EDM device.



- Time required to start distance measurement will be longer than usual when "EDM eco mode" is set to "ON".

### 33.7 Instrument Conditions - Instrument

Select "Inst. Config" in Config mode and select "Instrument".

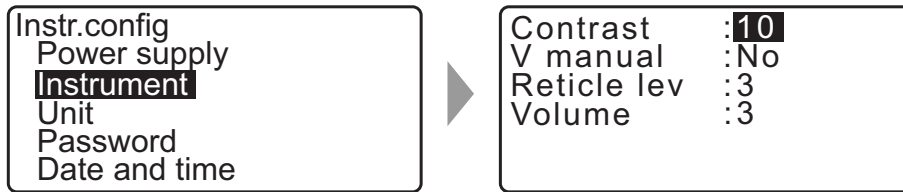

#### Items set and options (\*: Factory setting)

Contrast	: 0 to 15 level (10*)
V manual	: Yes, No*
Reticle lev	: 0 to 5 level (3*)
Volume	: 0 to 5 (3*, Buzzer is OFF when "0" is selected)

Setting "V manual" to "Yes": "40.1 Manually Indexing the Vertical Circle by Face 1/2 Measurement"

### 33.8 Instrument Conditions - Unit

Select "Inst. Config" in Config mode and select "Unit".

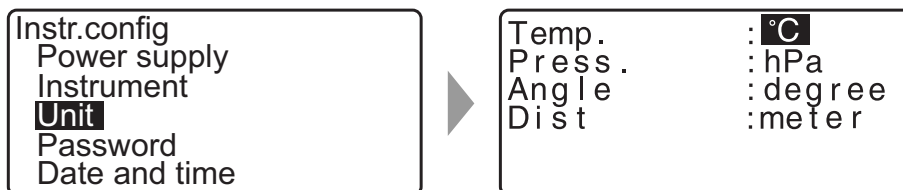

#### Items set and options (\*: Factory setting)

Temp. (Temperature)	: °C*, °F
Press	: hPa*, mmHg, inchHg
Angle	: degree*, gon, mil
Dist	: meter*, feet, inch

Feet (only displayed when "feet" or "inch" selected above):

Int. feet*	(1 m = 3.280839895)
US feet	(1 m = 3.280833333)

#### Inch (Fraction of an inch)

"Fraction of an inch" is the unit used in the United States and expressed like the following example.

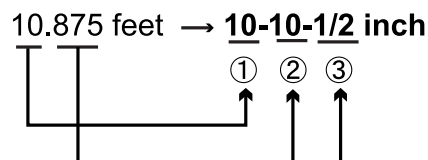

- ① 10.000 feet
- ② 0.875 feet x 12=10.5 inch
- ③ 0.5 inch=1/2 inch



- Even if “inch” is selected in this setting, all the data including the result of area calculation are output in “feet” and all the distance values must be input in “feet”. In addition, when the “inch” display exceeds the range, it is displayed in “feet”.



### International feet and US survey feet

The iM can display feet values in International feet and US survey feet units.

International feet, the standard feet units, are referred to simply as “feet” elsewhere in this manual.

US survey feet are units used in surveys by the U.S. Coast and Geodetic Survey and are referred to as “US feet” in this manual.

When “feet” or “inch” is selected in “Dist”, the “Feet” item will appear on the screen as below. When “meter” is selected, this item will not be displayed.

Temp.	: °C
Press.	: hPa
Angle	: degree
Dist	: feet
Feet	: Int. feet

Results displayed in feet will differ according to the unit selected in this item.

## 33.9 Instrument Conditions - Password

When a password has been set, the password screen will appear when the instrument is powered ON.

Setting a password allows you to protect important information such as measurement data.

No password is set when the instrument is shipped. When setting a password for the first time, leave the "Old password" box blank.

Select "Inst. Config" in <Configuration> and select "Password".

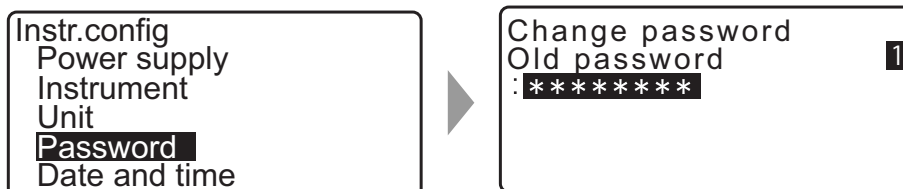

### PROCEDURE Changing password

1. Select "Change Password" in Config mode.
2. Input old password and press {ENT}.

The screenshot shows the "Change password" screen. The "Old password" field is filled with asterisks. A small box with the number "1" is in the top right corner.

3. Input new password twice and press **{ENT}**. The password is changed and <Config> is restored.

- If no password was input as new password and **{ENT}** was pressed, no password is set.

```
Change password
New password
:*****
New password again
:*****
```

- Password can be from 3 up to 8 characters in length. Input characters will be displayed as asterisks.
- To deactivate the password function, perform the new password setting procedure but enter a "space" in the "New password" box.

### 33.10 Instrument Conditions - Date and Time

Select "Inst. Config" in Config mode and select "Date & Time".

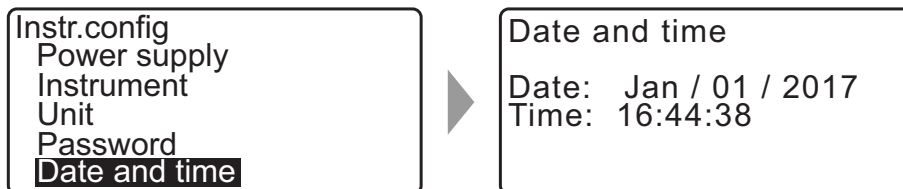

#### Items set

Date: Entry example: July 20, 2017 → 07202017 (MMDDYYYY)

Time: Entry example: 2:35:17 p.m. → 143517 (HHMMSS)



#### Date and Time

The instrument includes a clock/calendar function.

### 33.11 Allocating Key Functions

It is possible to allocate the softkeys in OBS mode to suit the measurement conditions. It is possible to operate the iM efficiently because unique softkey allocations can be preset to suit various applications and the ways that different operators handle the instrument.

- The current softkey allocations are retained until they are revised again, even when the power is cut off.
- It is possible to register two sets of key function allocations: user setting 1 and user setting 2.
- It is possible to recall the softkey arrays registered for User 1 and User 2 as necessary.



- When softkey allocations are recorded and registered, the previously recorded key settings are cleared. When a softkey array is recalled, the key array is changed to the key array that has been recalled, clearing the previous key array. Be sure to remember this.

The following are the softkey allocations when the iM was shipped.

Page 1 [MEAS] [SHV] [0SET] [COORD]

Page 2 [MENU] [TILT] [H-SET] [EDM]

Page 3 [MLM] [OFFSET] [TOPO] [S-O]

The following functions can be allocated to the softkeys.

[MEAS]	: Distance measurement
[SHV]	: Switch between angle display and distance display
[0SET]	: Set horizontal angle to 0
[COORD]	: Coordinates measurement
[REP]	: Repetition measurement
[MLM]	: Missing line measurement
[S-O]	: Setting-out measurement
[OFFSET]	: Offset measurement
[TOPO]	: To TOPO menu
[EDM]	: Setting EDM
[H-SET]	: Set required horizontal angle
[TILT]	: Display tilt angle
[MENU]	: To Menu mode (Coordinates measurement, setting-out measurement, offset measurement, repetition measurement, missing line measurement, REM measurement, resection measurement, surface area measurement, set-out line, set-out arc, point projection, intersections, traverse)
[REM]	: REM measurement
[RESEC]	: Resection measurement (The instrument station coordinate can be recorded on the measurement result screen.)
[R/L]	: Select horizontal angle right/left
[ZA / %]	: Switch between zenith angle/slope in %
[HOLD]	: Hold horizontal angle/release horizontal angle
[CALL]	: Display final measurement data
[S-LEV]	: Return signal
[AREA]	: Surface area measurement
[F/M]	: Switch between meters/feet
[HT]	: Set the instrument station height and target height
[S-O LINE]	: Setting-out line measurement
[S-O ARC]	: Setting-out arc measurement
[P-PROJ]	: Point projection measurement
[PTL]	: PT to Line
[INTSCT]	: Intersections measurement

<b>[TRAV]</b>	: Traverse adjustment
<b>[ROAD]</b>	: Route surveying
<b>[X SECT]</b>	: Cross section survey
<b>[TOPOII]</b>	: Topography observation
<b>[L-PLUM]</b>	: Brightness configuration for laser plummet
<b>[HVDOUT-T] / [HVDOUT-S]</b>	: Output distance/angle measurement results to an external instrument
<b>[HVOUT-T] / [HVOUT-S]</b>	: Output angle measurement results to an external instrument
<b>[NEZOUT-T] / [NEZOUT-S]</b>	: Output the coordinate results to an external instrument
<b>[---]</b>	: No functions set

### Softkey Allocation Examples

It is possible to allocate the same key to each page (example 1). The same function can be allocated to more than one key on the same page (example 2). And it is also possible to allocate a function to only one key (example 3).

Allocation example 1:

P1 **[MEAS] [SHV] [H-SET] [EDM]**  
P2 **[MEAS] [SHV] [H-SET] [EDM]**

Allocation example 2:

P1 **[MEAS] [MEAS] [SHV] [SHV]**

Allocation example 3:

P1 **[MEAS] [SHV] [---] [---]**

### PROCEDURE Allocating functions

- Select "Key function" in Config Mode.  
Select "Define." Currently allocated softkeys are displayed in <Key function>.
- Align the cursor with the softkeys whose allocation you want to change using **▶**/**◀**.  
The cursor of the selected softkey flashes.

```

Config
Obs.condition
Instr.config
Key function
Comms setup
Instr.const

```

```

Key function
Define
Registration
Recall

```

```

Key function
DIST SHV 0SET COORD
MENU TILT H-SET EDM
MLM OFFSET TOPO S-O
OK

```



- Change the softkey function using **{▲}**/**{▼}**.  
Set the softkey function and its location by pressing **{▶}**/**{◀}**.  
The set softkey stops flashing and the cursor flashes on the next softkey.

Key function			
DIST	SHV	MLM	COORD
MENU	TILT	H-SET	EDM
MLM	OFFSET	TOPO	S-O
			OK

- Repeat steps 2 to 3 only as many times as necessary.
- Press **[OK]** to record the allocations and restore <Key function>.  
The functions with their new allocations are displayed in OBS mode.

### PROCEDURE Registering an allocation

- Allocate functions to the softkeys.  
 "PROCEDURE Allocating functions"
- Select "Key function" in Config mode.
- Select "Registration."  
Select either "User'1" or "User'2" as the softkey array to be registered.
- Press **{ENT}**. The softkey array is registered as user 1 or user 2 and <Key function> is restored.

Key function
User's 1
User's 2
Registered to 1

### PROCEDURE Recalling an allocation

- Select "Key function" in Config Mode.
- Select "Recall." Select the key array for either User 1, User 2, or Default (setting when the iM was shipped), and press **{ENT}**.  
<Key function> is restored. This displays the functions in the recalled array in OBS mode.

Key function
User's 1
User's 2
Default

## 33.12 Restoring Default Settings

The following explains the two methods of restoring default settings:

Restoring set items to initial settings and turning power on. Initializing the data and turning power on.

- Restore the following items to the initial settings when the iM was shipped.  
EDM setting, Config mode settings (including softkey arrays)  
☞ About initial settings when the iM was shipped: "33.1 Observation Conditions - Angle/Tilt",  
"33.11 Allocating Key Functions"
- Initialize the data. The following data is initialized.  
Data within all jobs  
Known point data within memory  
Code data within memory

### PROCEDURE Restoring set items to initial settings and turning power on

---

1. Turn the power off.
2. While pressing **{F4}** and **{B.S.}**, press the power key.
3. The iM is turned on, "Default set" appears on the screen and all items are restored to their initial settings.

### PROCEDURE Initializing the data and turning the power on

---

1. Turn the power off.
2. While pressing **{F1}**, **{F3}** and **{B.S.}**, press the power key.
3. The iM is turned on, "Clearing memory..." appears on the screen and all items are restored to their initial settings.

# 34.WARNING AND ERROR MESSAGES

The following is a list of the error messages displayed by the instrument and the meaning of each message. If the same error message is repeated or if any message not shown below appears, the instrument has malfunctioned. Contact your local dealer.

## **BadCondition**

The air is shimmering a lot, etc., measuring conditions are poor.

The center of the target cannot be sighted.  
Resight the target.

Unsuitable distance measurement conditions when reflectorless measurement is set. When reflectorless measurement is set, distance cannot be measured because the laser beam is striking at least two surfaces at the same time.

Choose a single surface target for distance measurement.

## **Bad file name**

File name is not entered when saving data on USB flash drive.

## **Calculation error**

Coordinates identical to the known point coordinates observed during resection exist. Set another known point so that the known point coordinates do not coincide.

An error occurred during calculation.

## **Checksum error**

A sending/repetition error has occurred between the iM and external equipment.  
Send/receive the data again.

## **Clock error**

Clock error occurs when the voltage of the lithium battery decreases or the battery itself is depleted. For details on replacing lithium batteries contact your local dealer.

## **Communication error**

A reception error has occurred in coordinate data from an external instrument.  
Check the settings of parameters concerning communication conditions.

## **Flash write error!**

It is impossible to read in data.  
Contact your local dealer.

## **Incorrect Password**

Input password does not match set password. Input correct password.

## **Insert USB**

USB flash drive is not inserted.

## **Invalid baseline**

During setting-out line measurement or point projection measurement, baseline has not been defined correctly.

## **Memory is full**

There is no more room to enter data.  
Record the data again after deleting unnecessary data from the JOB or coordinate data from the memory.

**Need 1st obs**

During missing line measurement, the observation of the starting position was not completed normally.  
Sight the starting position accurately and press **[OBS]** to perform the measurement again.

**Need 2nd obs**

During missing line measurement, the observation of the target was not completed normally.  
Sight the target accurately and press **[MLM]** to perform the measurement again.

**Need offset pt.**

Observation of the offset point during offset measurement was not completed normally.  
Sight the offset point accurately and press **[OBS]** to perform the measurement again.

**Need prism obs**

During REM measurement, the observation of the target was not completed normally.  
Sight the target accurately and press **[OBS]** to perform measurement again.

**New password Diff.**

Passwords input when setting a new password do not match.  
Input the same password twice.

**No data**

When searching for or reading in coordinate data or searching for code data, the search stopped either because the item in question does not exist or the data volume is large.

**No file**

There is no file for loading known point data or displaying data on the currently selected USB flash drive.

**No solution**

The calculation of the instrument station coordinates during resection does not converge.  
Assess the results and if necessary, perform the observation again.  
Intersect point could not be calculated. Either necessary data items were not input or the Intersect point does not exist.

**North/East is null, Read error**

The Northing or Easting field of the given coordinate is null.  
Input the coordinate.

**Out of range**

The tilt of the instrument exceeds the tilt angle compensation range during measurement.  
Level the instrument again.  
 "7.2 Levelling"

A direction which does not cross with the base plane during plane offset measurement.

**Out of value**

During gradient % display, the display range (less than  $\pm 1000\%$ ) has been exceeded.  
During REM measurement, either the vertical angle has exceeded horizontal  $\pm 89^\circ$  or the measured distance is greater than 9999.999 m.  
Install the instrument station far from the target.

The instrument station coordinates calculated during resection are too high.  
Perform the observation again.

During setting-out line measurement, scale factor has been less than 0.100000 or exceeded 9.999999.

During area calculation, results exceeded the display range.

**Pt already on route**

Traverse tried to close on a traverse point other than the Start pt. during automatic route search. Press any key to return to the last point found in automatic route search. Either select the next traverse point to continue the current search or specify the Start pt. to close a closed-loop traverse.

Please use the Starkey in OBS mode  
Can be used only in the Observation mode.

**Pt1-Pt2 too near**

When setting the baseline with "Point to Line", two reference points are too close.  
Leave the space of 1 m or longer between the two reference points.

**Read-only file**

Read-only file on the USB flash drive cannot be changed and file contents cannot be edited or deleted.

**Same coordinates**

The same values are input in Pt.1 and Pt.2 in setting-out line measurement. iM cannot define the baseline.

**SDR format err**

The file read in is not SDR format. Check the file.

**Send first**

JOB data output (transmission to the host computer) is not completed before JOB is cleared.  
Either transmit the JOB to be cleared to the host computer.

**Signal off**

Measuring conditions are poor, and there is not any reflective light for measuring distances.  
Resight the target. When using reflective prisms, effectiveness will be improved by increasing the number of prisms used.

**Station coord is Null**

Cannot calculate. Station point coordinate is set to "Null".  
Input the coordinate.

**Temp Range OUT**

iM is outside useable temperature range and accurate measurement cannot be performed. Repeat measurement within the appropriate temperature range. If the iM is used under direct sunlight, use an umbrella to protect it against the heat of the sun.

**Time out (during measurement)**

Measuring conditions are poor, and due to the insufficient amount of reflective light, measuring could not be carried out within the time specified.  
Resight the target. When using reflective prisms, effectiveness will be improved by increasing the number of prisms used.

**Too short**

Input password has fewer than 3 characters. Password must have 3 or more characters and 8 or fewer characters.

**USB error**

An error has occurred in loading or saving data to USB flash drive.

**USB full !**

There is no more room to enter data on USB flash drive.

**USB not found**

USB flash drive was removed during USB mode operation.

\*\*\*\*\*

The calculated result is too large to be displayed on the screen in its totality.

# 35.CHECKS AND ADJUSTMENTS

A iM is a precision instrument that requires fine adjustments. It must be inspected and adjusted before use so that it always performs accurate measurements.

- Always perform checking and adjustment in the proper sequence beginning from "35.1 Circular Level" to "35.7 Laser Plummet \*1".
- In addition, the instrument should be inspected with special care after it has been stored a long time, transported, or when it may have been damaged by a strong shock.
- Make sure the instrument is securely set up and stable before performing checks and adjustments.

## 35.1 Circular Level

### PROCEDURE Checking and adjusting

1. Level while checking the display.

☞ "7.2 Levelling"



- If the tilt sensor is misaligned, the circular level is not adjusted correctly.

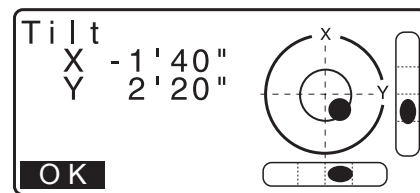

2. Check the position of the bubble of the circular level.  
If the bubble is not off-center, no adjustment is necessary.  
If the bubble is off-center, perform the following adjustment.

3. First confirm the off-center direction.  
Use the hexagonal wrench (2.5 mm) to loosen the circular level adjustment screw on the side opposite to the direction the bubble is displaced to move the bubble to the center.

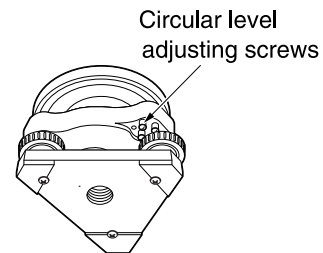

4. Adjust the adjusting screws until the tightening tension of the three screws is the same to align the bubble in the middle of the circle.



- Be careful that the tightening tension is identical for all the adjusting screws.
- Also, do not over-tighten the adjusting screws as this may damage the circular level.

## 35.2 Tilt Sensor

If the tilt angle shown on the display shifts from tilt angle 0° (zero point), the instrument is not correctly levelled. This will adversely affect angle measurement.

Perform the following procedure to cancel the tilt zero point error.

### PROCEDURE Checking

1. Carefully level the instrument. If necessary, repeat the procedures to check and adjust the bubble levels.

2. Set the horizontal angle to 0°.  
Press **[OSET]** twice in the first page of the OBS mode screen to set the horizontal angle to 0°.
3. Select "Instr. const" in the Config. mode screen to display the current correction constant in the X (sighting) direction and Y (horizontal axis) direction.

```
Config
Obs.condition
Instr.config
Key function
Comms setup
Instr.const
```

```
Instr.const
Tilt: X -10 Y 7
Collimation
```

Select "Tilt X Y" and press **{ENT}** to display the tilt angle in the X (sighting) direction and Y (horizontal axis) direction.

```
Tilt offset
X -0°01'23"
Y 0°00'04"
HA-R 00°00'00"
Take F1
OK
```

4. Wait a few seconds for the display to stabilize, then read the automatically compensated angles X1 and Y1.
5. Loosen the horizontal clamp and turn the instrument 180° while referring to the displayed horizontal angle, then retighten the clamp.
6. Wait a few seconds for the display to stabilize, then read the automatically compensated angles X2 and Y2.

```
Tilt offset
X -0°00'03"
Y 0°00'04"
HA-R 180°00'00"
Take F2
OK
```

7. In this state, calculate the following offset values (tilt zero point error).

$$X_{\text{offset}} = (X1+X2)/2$$

$$Y_{\text{offset}} = (Y1+Y2)/2$$

If one of the offset values ( $X_{\text{offset}}$ ,  $Y_{\text{offset}}$ ) exceeds  $\pm 20''$ , adjust the value using the following procedure.

When the offset value falls within the range  $\pm 20''$ , adjustment is not necessary.

Press **{ESC}** to return to <Instr. const>.

### PROCEDURE Adjusting

8. Store values X2 and Y2.  
Press **[OK]**. "Take F2" is displayed.



9. Rotate the top of the instrument through 180° until the displayed horizontal angle is 180° ±1' and **[OK]** is displayed.
10. Wait a few seconds for the display to stabilize, then store the automatically compensated angles X1 and Y1. Press **[YES]** to store tilt angles X1 and Y1. The new correction constant is displayed.

Tilt offset		
Current	X-10	Y 7
New	X 4	Y-11
		<b>NO</b> <b>YES</b>

11. Confirm that the values are in the adjustment range. If both correction constant are within the range ±180, select **[YES]** to renew the correction angle. <Instr. const> is restored. Continue to step 12. If the values exceed the adjustment range, select **[NO]** to cancel the adjustment and restore <Instr. const>. Contact your local dealer to perform the adjustment.

### PROCEDURE Rechecking

12. Press **{ENT}** at <Instr. const>.
13. Wait a few seconds for the display to stabilize, then read the automatically compensated angles X3 and Y3.
14. Rotate the top of the instrument through 180°.
15. Wait a few seconds for the display to stabilize, then read the automatically compensated angles X4 and Y4.
16. In this state, the following offset values (tilt zero point error) are calculated.  
 $X_{\text{offset}} = (X3+X4)/2$   
 $Y_{\text{offset}} = (Y3+Y4)/2$   
 When both offset values fall within the range ±20", adjustment is completed.  
 Press **{ESC}** to return to <Instr. const>.

If one of the offset values ( $X_{\text{offset}}$ ,  $Y_{\text{offset}}$ ) exceeds ±20", repeat the check and adjustment procedures from the beginning. If the difference continues to exceed ±20" after repeating the check 2 or 3 times, have your local dealer perform the adjustment.

### 35.3 Collimation

With this option you can measure collimation error in your instrument so that the instrument can correct subsequent single face observations. To measure the error, make angular observations using both faces.



- Perform adjustment in weak sunlight and no scintillation.

#### PROCEDURE Adjusting

1. Carefully level the instrument.
2. Install a target at a point about 100 m in the horizontal direction from the instrument.
3. Select "Instr.const" in the Config. mode screen and select "Collimation".
4. While the telescope is in Face 1, sight the center of the target correctly and press **[OK]**.
5. Wait until a beep sound and rotate the instrument 180°. Sight the center of the target correctly in Face 2 and press **[OK]**.
6. Press **[YES]** to set the constant.
  - Press **[NO]** to discard the data and return to the screen in step 4.



Collimation	
ZA	34° 56' 12"
HA-R	123° 45' 26"
Take F1	
<b>OK</b>	

Collimation	
EL	-0° 00' 15"
V Off.	0° 00' 10"
<b>NO</b> <b>YES</b>	

### 35.4 Reticle

#### PROCEDURE Check 1: Perpendicularity of the reticle to the horizontal axis

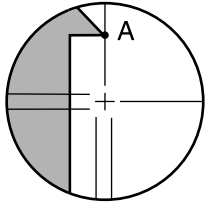
1. Carefully level the instrument.
2. Align a clearly visible target (the edge of a roof for example) on point A of the reticle line.
 
3. Use the telescope fine motion screw to align the target to point B on a vertical line.
 

If the target moves parallel to the vertical line, adjustment is unnecessary. If its movement deviates from the vertical line, have our service representative adjust it.

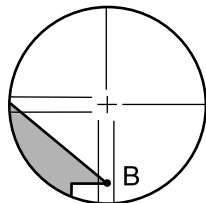

**PROCEDURE Check 2: Vertical and horizontal reticle line positions**

- Perform check in weak sunlight and no scintillation.
- "Tilt crn" should be set to "Yes (H,V)" and "coll.crn" to "Yes" in <Obs. condition> while performing checks.

1. Carefully level the instrument.
2. Install a target at a point about 100 m in the horizontal direction from the instrument.



3. While the OBS mode screen is displayed and the telescope is in Face 1, sight the center of the target correctly and read out the horizontal angle A1 and the vertical angle B1.

Example: Horizontal angle A1 = 18° 34' 00"

Vertical angle B1 = 90° 30' 20"

4. While the telescope is in Face 2, sight the center of the target correctly and read out the horizontal angle A2 and the vertical angle B2.

Example: Horizontal angle A2 = 198° 34' 20"

Vertical angle B2 = 269° 30' 00"

5. Do the calculations:

A2-A1 and B2+B1

If A2-A1 is within 180°±20" and B2 (B1 is within 360°±40", adjustment is unnecessary.

Example: A2-A1 (Horizontal angle) = 198° 34' 20" - 18° 34' 00"  
= 180° 00' 20"

B2-B1 (Vertical angle) = 269° 30' 00" + 90° 30' 20"  
= 360° 00' 20"

If the difference is large even after repeating the check 2 or 3 times, make sure that checking and adjusting of "35.2 Tilt Sensor" and "35.3 Collimation" are completed.

If the results remain the same, have our service representative perform the adjustment.

**35.5 Optical Plummet**

- Be careful that the tightening tension is identical for all the adjusting screws.
- Also, do not over-tighten the adjusting screws as this may damage the circular level.

**PROCEDURE Checking**

1. Carefully level the instrument and center a survey point precisely in the reticle of the optical plummet.

2. Turn the upper part through  $180^\circ$  and check the position of the survey point in the reticle.  
If the surveying point is still centered, no adjustment is necessary.  
If the survey point is no longer centered in the optical plummet, perform the following adjustment.

### PROCEDURE Adjusting

3. Correct half the deviation with the levelling foot screw.

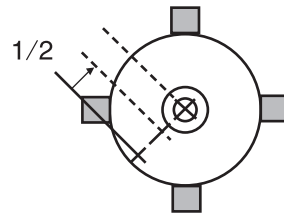

4. Remove the optical plummet reticle cover.

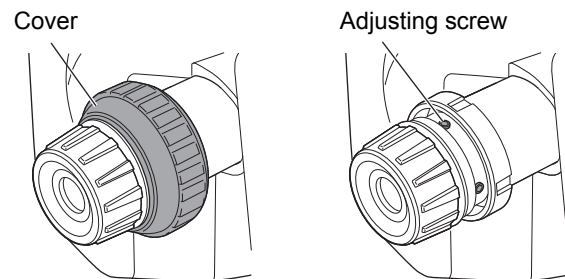

5. Turn the 4 adjusting screws of the optical plummet to adjust the remaining half of the deviation using hexagonal wrench (1.3 mm) as shown below.  
When the survey point is on the lower (upper) part of the illustration:

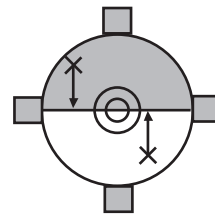

Loosen the upper (lower) adjusting screw slightly, and tighten the upper (lower) adjusting screw the same amount to move the survey point to a point directly under the center of the optical plummet.  
(It will move to the line in the figure on the right.)

If the survey point is on the solid line (dotted line):  
Loosen the right (left) adjusting screw slightly and, tighten the left (right) adjusting screw by the same amount to move the survey point to a point in the center of the optical plummet.

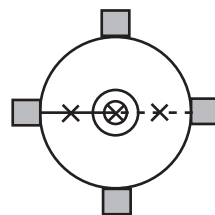

6. Check to make sure that the survey point remains centered on the reticle even if the upper part of the instrument is rotated.  
If necessary, perform the adjustment again.

- Replace the optical plummet reticle cover by matching the grooves on the cover with the grooves on the optical plummet.

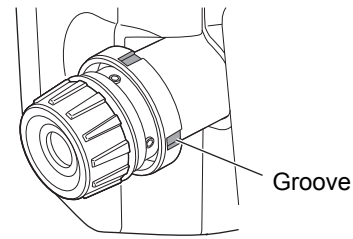

### 35.6 Additive Distance Constant

The additive distance constant  $K$  of the iM is adjusted to 0 before delivery. Although it almost never deviates, use a baseline with a known distance precision to check that the additive distance constant  $K$  is close to 0 several times a year and whenever the values measured by the instrument begin to deviate by a consistent amount. Perform these checks as follows.



- Errors in setting up the instrument and reflective prism or in sighting the target will influence the additive distance constant. Be extremely careful to prevent such errors when performing these procedures.
- Set up so that the instrument height and the target height are identical. If a flat place is not available, use an automatic level to make sure the heights are identical.

#### PROCEDURE Checking

- Find an area of flat ground where two points 100 m apart can be selected.  
Set up the Instrument at point A and the reflective prism at point B. Establish a point C half way between points A and B.

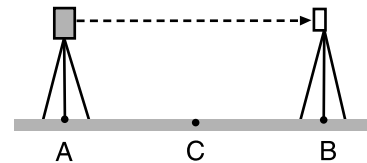

- Precisely measure the horizontal distance between point A and point B 10 times and calculate the average value.
- Place the iM at point C directly between points A and B and set up the reflective prism at point A.

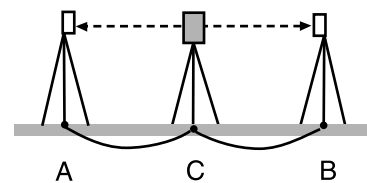

- Precisely measure the horizontal distances CA and CB 10 times each and calculate the average value for each distance.
- Calculate the additive distance constant  $K$  as follows.  
$$K = AB - (CA + CB)$$
- Repeat steps 1 to 5 two or three times.  
If the additive distance constant  $K$  is within  $\pm 3$  mm even once, adjustment is unnecessary.  
If it always exceeds this range, have our service representative perform an adjustment.

## 35.7 Laser Plummet <sup>\*1</sup>

Checks and adjustments are performed using an adjustment target. Make an enlarged or reduced copy of the figure below.

\*1: Laser plummet is available as a factory option depending on the country or the area where the instrument is purchased.

### PROCEDURE Checking

1. Level the instrument and emit the laser plummet beam.  
☞ "7.2 Levelling"
2. Rotate the upper part horizontally and place a target so that it is aligned with the center of the circle created by the rotating laser plummet beam.
  - Laser beam remains centered on the center of the target – No adjustment necessary
  - Laser beam strays from the center of the target – Adjustment necessary.
  - Laser beam draws a circle outside the target circle – Contact your local dealer.

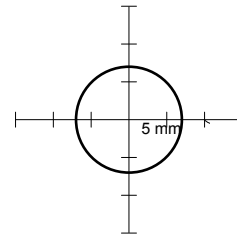

### PROCEDURE Adjusting

1. Turn the laser plummet adjustment cap anticlockwise and remove.
2. Emit the laser plummet beam.
3. Note the current position (x) of the laser beam.
4. Turn the upper part of the instrument horizontally through 180° and note the new position (y) of the laser beam. Adjustment will bring the laser beam to a point midway along a line drawn between these two positions.
5. Check the position of the desired final position. Place a target so that its center is aligned with the desired final position. The remaining deviation will be adjusted using the 4 fine adjustment screws.



- Be extremely careful to adjust all the fine adjustment screws by the same amount so that none will be over-tightened.
- Turn screws clockwise to tighten.

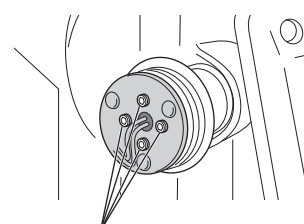
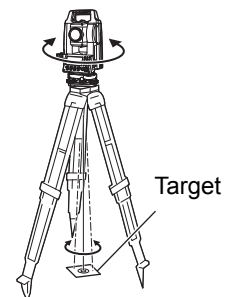
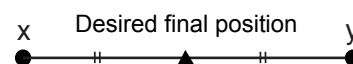
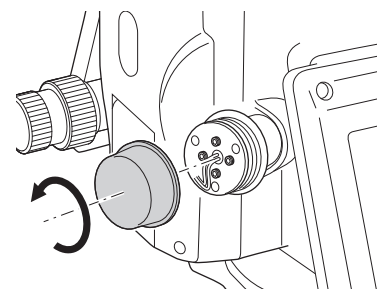

Fine adjustment screws

6. When the laser beam is on the upper (lower) part of Fig. A the up/down adjustment is made as follows:

(1) Insert the provided hexagon key wrench into both the upper and lower screws.

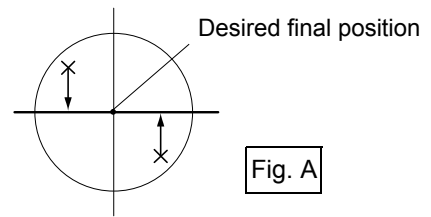

(2) Slightly loosen the upper (lower) screw and tighten the lower (upper) screw. Make sure that the tightening tension for both screws is identical. Continue to adjust until the laser beam is on the horizontal line of the target.

7. When the laser beam is in the right (left) part of Fig. B the left (right) adjustment is made as follows:

(1) Insert a hexagon key wrench into both the left and right screws.

(2) Slightly loosen the right (left) screw and tighten the left (right) screw. Make sure that the tightening tension for both screws is identical.

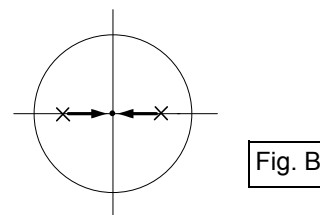

Continue to adjust until the laser beam is aligned with the target center.

8. Turn the upper part of the instrument horizontally and check that the laser beam is now aligned with the target center.

9. Re-attach the laser plummet adjustment cap.

**Note**

• Tightening each of the fine adjustment screws moves the laser plummet beam in the directions shown below.

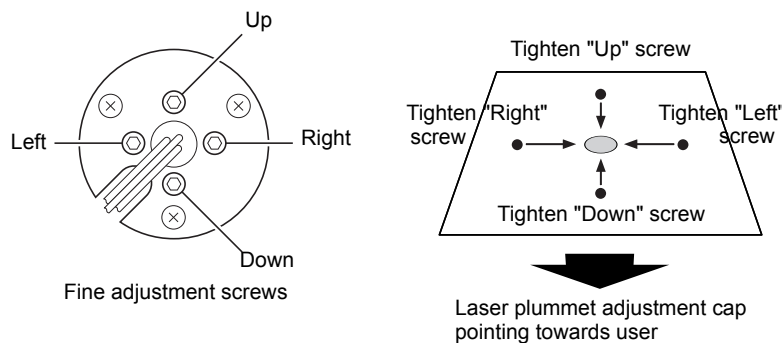

# 36.POWER SUPPLY SYSTEM

Operate your instrument with the following combinations of power equipment.



- For details about batteries and chargers, refer to each dedicated manual.
- Never use any combination other than those indicated below. If you do, the instrument could be damaged.

Those indicated by \* are standard accessories.

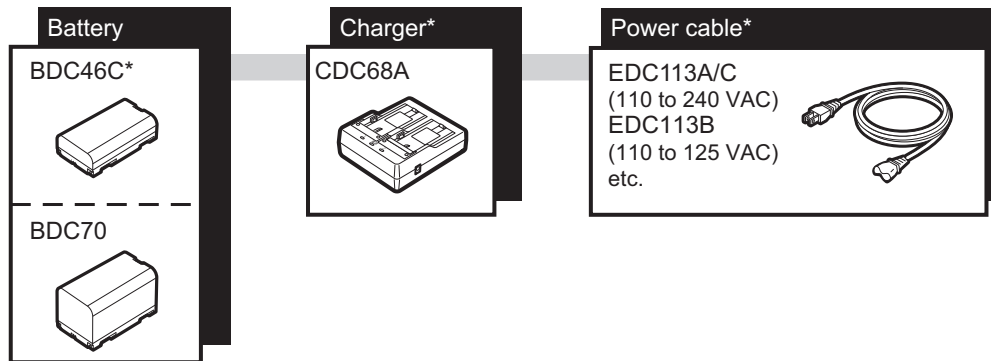

- Dedicated power cables differ according to the country or the area where the instrument is used. Contact your local dealer for the details.



# 37.TARGET SYSTEM

Select a prism or a target depending on your purpose. The following are all special accessories (sold separately).



- When using a reflecting prism equipped with a target for distance and angle measurements, be sure to direct the reflective prism correctly and sight the center of the prism target accurately.
- Each reflective prism has its own prism constant value. When changing prisms, be sure to change the prism constant correction value.

## ● Reflecting Prism System (AP Series)

Use an appropriate system for iM.

The figure on the right is an example.

Because all reflecting prisms and accessories have standardized screws, it is possible to combine these prisms, accessories, etc. according to your objectives.

Prism constant correction value : -40 mm (used alone)

Aperture : 58 mm

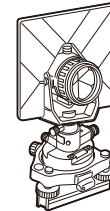

## ● Pinpole prism (OR1PA)

Prism constant correction value : -30 mm (used alone)

Aperture : 25 mm



## ● Reflective sheet target (RS series)

Prism constant correction value : 0 mm

Aperture : Target size

## ● 2-point target (2RT500-K)

This target is used for two-distance offset measurement.

Prism constant correction value : 0 mm

Aperture : 50 mm

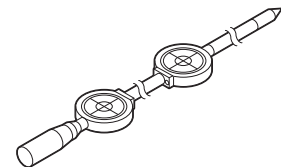

## ● Instrument height adaptor (AP41)

This device is used to adjust the height of the target.

Make sure that the instrument height "239" (mm) is displayed in the instrument height adjustment window.

1. Install the tribrach to the instrument height adaptor.

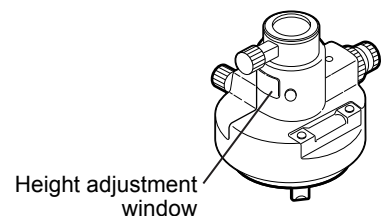

2. Level the instrument and check the position of the bubble of the plate level.

3. Turn the upper part through  $180^\circ$  and check the bubble position.  
If the bubble is still centered, no adjustment is necessary.  
If the bubble is off-center, adjust as follows.

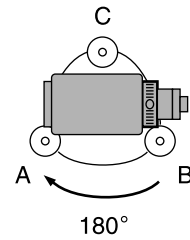

4. Correct half of the bubble displacement using levelling foot screw C.

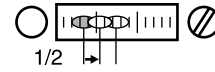

5. Correct the remaining half of the displacement by using the adjustment pin to rotate the plate level adjustment screw.  
When the plate level adjustment screw is turned in the counterclockwise direction, the bubble moves in the same direction.

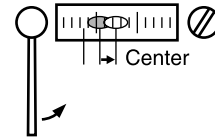

6. Rotate the top of the instrument and continue adjustments until the bubble remains centered for any position of the upper part.  
If the bubble does not move to the center even when the adjustment has been repeated, ask your local dealer to adjust it.

- Adjust the optical plummet of the AP41 instrument height adaptor following the checking and adjustment methods of optical plummet.

 "35.5 Optical Plummet"

#### ● Base Plate (TR-101/102 series)

The circular level on the base plate for prism should be adjusted in the same way with the circular level on the main body.

 "35.1 Circular Level"

# 38.ACCESSORIES

The following are outlines and how to use standard accessories (not all) and optional accessories.

The following items are explained in other chapters.

☞ Power supply and target optional accessories: "36. POWER SUPPLY SYSTEM", "37. TARGET SYSTEM".

## ● Plumb bob (optional accessory)

The plumb bob can be used to set up and center the instrument on days when there is little wind. To use the plumb bob, unwind its cord, pass it through the cord grip piece as shown in the figure to adjust its length, then suspend it from the hook attached to the centering screw.

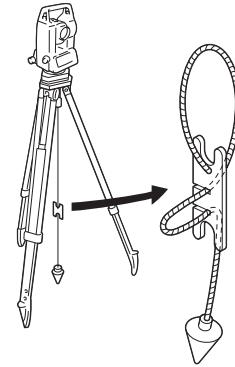

## ● Tubular compass (CP7) (optional accessory)

Slide the tubular compass into the tubular compass slot, loosen the clamp screw, then rotate the top part of the instrument until the compass needle bisects the index lines. The telescope's face 1 sighting direction in this position will indicate magnetic north. After use, tighten the clamp and remove the compass from the slot.

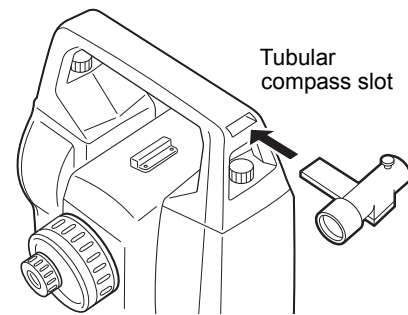

• The tubular compass is susceptible to the influence of nearby magnets or metal. Such influence could cause it to fail to accurately indicate magnetic north. Do not use magnetic north as indicated by this compass for base line surveying.

## ● Telescope eyepiece lens (EL7) (optional accessory)

Magnification : 40X  
Field of view : 1° 20'

## ● Diagonal eyepiece (DE27) (optional accessory)

The diagonal eyepiece is convenient for observations near the nadir and in narrow spaces.

Magnification: 30X

After removing the handle from the iM, loosen the attachment screw to remove the telescope eyepiece. Then screw the diagonal lens into place.

☞ Handle removal method: "4.1 Parts of the Instrument"

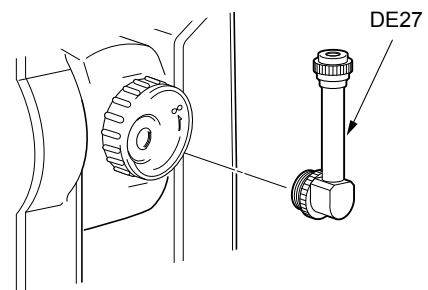

● **Solar filter (OF3A) (optional accessory)**

During solar observation, attach it to the objective lens of the instrument to protect its interior and the eyes of its operator. The filter part can be flipped up without being removed.

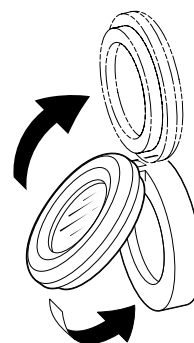

● **Power cable/Interface cable (optional accessory)**

Connect the instrument to a host computer using the following cables.

Cable	Notes
DOC210	Pin number and signal level : RS232C compatible D-Sub connector : 9 pins (female)



- By using the Y cable the instrument can perform RS232C communication (D-Sub 9-pin) at the same time as connecting to an external power source.

# 39.SPECIFICATIONS

Except where stated, the following specifications apply to all models of iM Series.

## Telescope

Length	171 mm
Aperture	45 mm (EDM:48 mm)
Magnification	30X
Image	Erect
Resolving power	2.5"
Field of view	1°30'
Minimum focus	1.3 m
Reticle illumination	5 brightness levels

## Angle measurement

Horizontal and Vertical circles type	Rotary absolute encoder
Detecting	
iM-52:	2 sides
iM-55:	1 side
IACS (Independent Angle Calibration System)	Yes
Angle units	Degree/Gon/Mil (selectable)
Minimum display	1" (0.0002 gon/0.005 mil)/5" (0.0010 gon/0.02 mil) (selectable)
Accuracy	
iM-52:	2" (0.0006 gon/0.010 mil)
iM-55:	5" (0.0015 gon/0.025 mil)
(ISO 17123-3 : 2001)	
Measuring time	0.5 sec or less
Collimation compensation	On/Off (selectable)
Measuring mode	
Horizontal angle:	Right/Left (selectable)
Vertical angle:	Zenith/Horizontal/Horizontal $\pm 90^\circ$ /% (selectable)

## Tilt angle compensation

Type	Liquid 2-axis tilt sensor
Minimum display	1"
Range of compensation	$\pm 6'$ ( $\pm 0.1111$ gon)
Automatic compensator	ON (V & H/V)/OFF (selectable)
Compensation constant	Can be changed

## Distance Measurement

Measuring method	Coaxial phase shift measuring system
Signal source	Red laser diode (690 nm) Class 3R (IEC60825-1 Ed.3.0: 2014/ FDA CDRH 21CFR Part 1040.10 and 1040.11 (Complies with FDA performance standards for laser products except for deviations pursuant to Laser Notice No.50, dated June 24, 2007.)) (When the prism or reflective sheet is selected in Config mode as target, the output is equivalent to Class 1).
Measuring range	(Using the following reflective prism/reflective sheet target during normal atmospheric conditions*1 / *2 is good atmospheric conditions.)
Mini pole prism OR1PA*3:	1.3 to 500 m (1,640 ft)
Compact prism CP01*3:	1.3 to 2,500 m (8,200 ft)

Standard prism AP01AR X 1 <sup>*3</sup> :	1.3 to 4,000 m (13,120 ft) (1.3 to 4,000 m (13,120 ft)) <sup>*2</sup>
Reflective sheet RS90N-K <sup>*4</sup> :	1.3 to 500 m (1,640 ft) 1.3 to 300 m (980 ft) <sup>*5</sup>
Reflective sheet RS50N-K <sup>*4</sup> :	1.3 to 300 m (980 ft) 1.3 to 180 m (590 ft) <sup>*5</sup>
Reflective sheet RS10N-K <sup>*4</sup> :	1.3 to 100 m (320 ft) 1.3 to 60 m (190 ft) <sup>*5</sup>
Reflectorless (White):	0.3 to 500 m (1,640 ft) <sup>*6</sup> (0.3 to 500 m (1,640 ft)) <sup>*2 *7 *8</sup>
Prism (tracking) <sup>*3</sup> :	1.3 to 1,000 m (3,280 ft)
Reflective sheet target (tracking) <sup>*4</sup> :	1.3 to 350 m (1,140 ft) 1.3 to 210 m (680 ft) <sup>*5</sup>
Reflectorless (White) (tracking, road):	0.3 to 300 m (980 ft) <sup>*6</sup>
Minimum display	
Fine/Rapid measurement:	0.0001 m (0.001 ft / 1/16 inch) / 0.001 m (0.005 ft / 1/8 inch) (selectable)
Tracking/Road measurement:	0.001 m (0.005 ft / 1/8 inch) / 0.01 m (0.1 ft / 1/2 inch) (selectable)
Maximum slope distance display (Except for tracking)	
	9,600.000 m (31,490 ft) (using prism or reflective sheet target)
	1,200.000 m (3,930 ft) (Reflectorless)
Maximum slope distance display (Except for tracking)	
Using prism or reflective sheet target	9,600.000 m (31,490 ft)
Reflectorless (Tracking)	1,200.000 m (3,930 ft)
Using prism or reflective sheet target	1,280.000 m (4,200 ft)
Reflectorless	768.000 m (2,520ft)
Distance unit	m/ft/inch (selectable)
Accuracy (D: measurement distance; Unit: mm) (Under normal atmospheric conditions <sup>*1</sup> ) (Using prism) <sup>*3</sup>	
Fine measurement:	(1.5 + 2 ppm X D) mm <sup>*9 *11</sup>
Rapid measurement:	(5 + 2 ppm X D) mm
(Using reflective sheet target) <sup>*4</sup>	
Fine measurement:	(2 + 2 ppm X D) mm
Rapid measurement:	(5 + 2 ppm X D) mm
(Reflectorless (White)) <sup>*6</sup>	
Fine measurement:	(2 + 2 ppm X D) mm (0.3 to 200 m) <sup>*10</sup> (5 + 10 ppm X D) mm (over 200 to 350 m) (10 + 10 ppm X D) mm (over 350 to 500 m)
Rapid measurement:	(6 + 2 ppm X D) mm (0.3 to 200 m) <sup>*10</sup> (8 + 10 ppm X D) mm (over 200 to 350 m) (15 + 10 ppm X D) mm (over 350 to 500 m)
Measurement mode	Fine measurement (single/repeat/average)/Rapid measurement (single/repeat)/Tracking/Road (reflectorless) (selectable)
Measuring time <sup>*12</sup> :	
Fine measurement:	less than 1.5 sec + every 0.9 sec or less
Rapid measurement:	less than 1.3 sec + every 0.6 sec or less
Tracking measurement:	less than 1.3 sec + every 0.4 sec or less

Atmospheric correction:	
Temperature input range:	-35.0 to 60.0°C (in 0.1°C step)/ -31.0 to 140.0°F (in 0.1°F step)
Pressure input range:	500.0 to 1,400.0hPa (in 0.1hPa step) 375.0 to 1,050.0mmHg (in 0.1mmHg step) 14.80 to 41.30inchHg (in 0.01inchHg step)
Humidity input range:	0.0 to 100.0% (in 0.1% step)
ppm input range:	-499.9 to 499.9 ppm (in 0.1 ppm step)
Prism constant correction	-99.9 to 99.9 mm (in 0.1 mm step) 0 mm fixed for reflectorless measurement
Earth curvature and refraction correction	No/Yes K=0.142/Yes K=0.20 (selectable)
Scale factor setting	0.5 to 2.0
Sea level correction	No/Yes (selectable)

\*1: Slight haze, visibility about 20 km, sunny periods, weak scintillation.

\*2: No haze, visibility about 40 km, overcast, no scintillation.

\*3: Face the prism toward the instrument during the measurement with the distance at 10 m or less.

\*4: Figures when the laser beam strikes within 30° of the reflective sheet target.

\*5: Measurement at 50 to 60°C (122 to 140°F).

\*6: Figures when using Kodak Gray Card White side (reflection factor 90%), brightness level is less than 5,000 lx and the laser beam strikes orthogonally the White side.

\*7: Figures when using Kodak Gray Card White side (reflection factor 90%), brightness level is less than 500 lx and the laser beam strikes orthogonally the White side. (800 m or more)

\*6,\*7: When performing reflectorless measurement, the possible measurement range and precision will change depending on the target reflection factor, weather conditions and location conditions.

\*8: Figures may differ according to the country or the area.

\*9: Accuracy is (2 + 2 ppm X D) mm for distance range 1.3 to 2 m.

\*10: Accuracy is (5 + 2 ppm X D) mm for distance range 0.3 to 0.66 m or less.

\*11: ISO 17123-4: 2012

\*12: Figures are as follows when EDM eco mode is selected. Fine measurement: less than 2.0 sec + every 0.9 sec or less, Rapid measurement: less than 1.8 sec + every 0.6 sec or less, Tracking measurement: less than 1.8 sec + every 0.4 sec or less

#### Internal memory

Capacity about 50,000 points

#### External memory

USB flash memory (up to 32 GB)

#### Data transfer

Data input/output Asynchronous serial, RS232C compatible

USB USB Revision 2.0 (High Speed), Host (Type A), Only a USB flash drive is compatible.

#### Bluetooth wireless technology (Option)<sup>\*13</sup>

Transmission method FHSS

Modulation GFSK (Gaussian-filtered frequency shift keying)

Frequency band 2.402 to 2.48GHz

Bluetooth profile SPP, DUN

Power class Class 1.5

Usable range about 10 m (while in communication with SHC500)<sup>\*14 \*15</sup>

\*13: Bluetooth function may not be built in depending on telecommunications regulations of the country or the area where the instrument is purchased. Contact your local dealer for the details.

\*14: No obstacles, few vehicles or sources of radio emissions/interference in the near vicinity of the instrument, no rain.

\*15: Usage range could be shorter depending on specifications of *Bluetooth* device to communicate.

### Power Supply

Power source	Rechargeable Li-ion battery BDC46C
Working duration at 20 °C	
Distance and angle measurement (Fine single measurement = every 30 sec.):	
BDC46C:	about 10 hours
(EDM eco mode)	
BDC46C:	about 14 hours
Battery state indicator	4 levels
Auto power-off	5 levels (5/10/15/30 min/Not set) (selectable)

### Battery (BDC46C)

Nominal voltage:	7.2 V
Capacity:	2,430mAh
Dimensions:	38 (W) x 70 (D) x 20 (H) mm
Weight:	about 103 g

### Charger (CDC68A)

Input voltage:	100 to 240 VAC
Charging time per battery (at 25°C):	
BDC46C:	about 2.5 hours (Charging can take longer than the times stated above when temperatures are either especially high or low.)
Charging temperature range:	0 to 40°C
Storage temperature range:	-20 to 65°C
Size:	94 (W) X 102 (D) X 36 (H) mm
Weight:	about 170 g

### General

Display unit	LCD graphic display, 192 dots X 80 dots
Backlight:	On/Off (selectable)
Operation panel (keyboard)	28 keys (soft function, operations, power on, light) with illuminator
Sensitivity of levels	
Circular level:	10'2 mm
Electronic Circular levels:	Graphic display range: 6' (inner circle) Digital display range: ±6' 30"
Optical plummet	
Image:	Erect
Magnification:	3X
Minimum focus:	0.5 m
Laser plummet*16	
Signal source:	Red laser diode 635 ±10 nm (Class 2 IEC60825-1 Ed. 3.0:2014/FDA CDRH 21CFR Part 1040.10 and 1040.11 (Complies with FDA performance standards for laser products except for deviations pursuant to Laser Notice No.50, dated June 24, 2007.))
Beam accuracy:	1 mm or less (when tripod head height is 1.3 m).
Spot diameter:	ø3 mm or less
Brightness control:	5 levels
Auto power-off:	Provided (power cut off after 5 minutes)
Calendar/clock function	Yes



---

Laser-pointer function	Provided On/Off (selectable)
Operating temperature (no condensation)	-20 to 60 °C (-4 to 140 °F) <sup>*17</sup>
Storage temperature range (no condensation)	-30 to 70 °C (-22 to 158 °F)
Dust and water resistance:	IP66 (IEC 60529: 2001)
Instrument height	192.5 mm from tribrach mounting surface 236 mm +5/-3 mm from tribrach bottom
Size (with handle)	
Display on both sides:	183 (W) X 181 (D) X 348 (H) mm
Display on one side:	183 (W) X 174 (D) X 348 (H) mm
Weight (with handle and battery)	5.1 kg (11.3 lb)

**\*16:** Laser plummet is available as a factory option depending on the country or the area where the instrument is purchased.

**\*17:** No direct sunlight for using high temperatures of 50 to 60 °C (122 to 140 °F).

# 40. EXPLANATIONS

## 40.1 Manually Indexing the Vertical Circle by Face 1/2 Measurement

The 0 index of the vertical circle of your instrument is almost 100% accurate, but when it is necessary to perform particularly high precision vertical angle measurements, you can eliminate any inaccuracy of the 0 index as follows.



- If the power is cut off, the vertical circle indexing is ineffective. Do it again every time the power is turned on.
- If it necessary to renew the registered collimation offset constant in your instrument, perform the collimation checking and adjusting.

"35.3 Collimation"

### PROCEDURE

1. Select "Obs. condition" in Config mode. Set "V manual" (vertical circle indexing method) to "Yes".

2. Press **[OBS]** on the status screen.

The electric circular level is displayed in the screen.

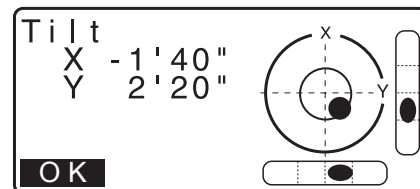

3. Carefully level the instrument and press **[OK]**.

The vertical angle V1 is displayed under "Take F1."

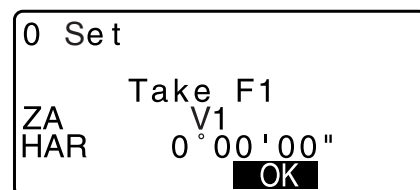

4. Accurately sight a clear target with a distance of about 30 m in the horizontal direction with the telescope in Face 1. Press **[OK]**. The vertical angle V2 is displayed under "Take F2."

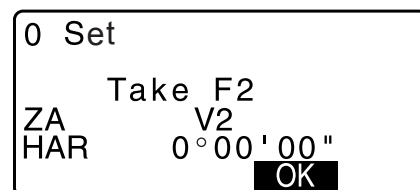

5. Turn the upper part through 180° and clamp it. Then set the telescope in the Face 2 position and accurately sight the same target.

Press **[OK]**.

The vertical and horizontal angles are displayed.

This concludes the vertical circle indexing procedure.

## 40.2 Correction for Refraction and Earth Curvature

The instrument measures distance, taking into account correction for refraction and earth curvature.

### Distance Calculation Formula

Distance Calculation Formula; with correction for refraction and earth curvature taken into account. Follow the Formula below for converting horizontal and vertical distances.

Horizontal distance  $D = AC(\alpha)$

Vertical distance  $Z = BC(\alpha)$

$D = L\{\cos\alpha - (2\theta - \gamma) \sin\alpha\}$

$Z = L\{\sin\alpha + (\theta - \gamma) \cos\alpha\}$

$\theta = L \cdot \cos\alpha / 2R$  : Earth curvature correcting item

$\gamma = K \cdot L \cos\alpha / 2R$  : Atmospheric refraction correcting item

$K = 0.142$  or  $0.2$  : Coefficient of refraction (Ref.index)

$R = 6371\text{km}$  : Radius of earth

$\alpha$  : Altitude angle

$L$  : Slope distance

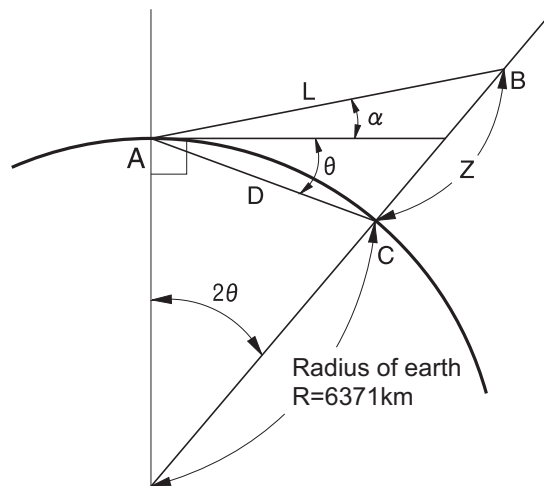



 Changing "K (Coefficient of refraction)" value: "33.2 Observation Conditions - Dist"

# 41.REGULATIONS

Region/ Country	Directives/ Regulations	Description
U.S.A.	FCC-Class B	<p><b>FCC Compliance</b></p> <p><b>WARNING:</b> Changes or modifications to this unit not expressly approved by the party responsible for compliance could void the user's authority to operate the equipment.</p> <p><b>NOTE:</b> This equipment has been tested and found to comply with limits for a Class B digital device, pursuant to Part 15 of the FCC Rules. These limits are designed to provide reasonable protection against harmful interference in a residential installation. This equipment generates, uses, and can radiate radio frequency energy and, if not installed and used in accordance with the instructions, may cause harmful interference to radio communications. However, there is no guarantee that interference will not occur in a particular installation. If this equipment does cause harmful interference to radio or television reception, which can be determined by turning the equipment off and on, the user is encouraged to try to correct the interference by one or more of the following measures:</p> <ul style="list-style-type: none"> <li>- Reorient or relocate the receiving antenna.</li> <li>- Increase the separation between the equipment and receiver.</li> <li>- Connect the equipment into an outlet on a circuit different from that to which the receiver is connected.</li> <li>- Consult the dealer or an experienced radio / TV technician for help.</li> </ul> <p><b>Means of conformity</b> This device complies with part 15 of the FCC Rules, Operation is subject to the following two conditions: (1) This device may not cause harmful interference, and (2) this device must accept any interference received, including interference that may cause undesired operation.</p> <p>This transmitter must not be co-located or operated in conjunction with any other antenna or transmitter.</p> <p>This equipment complies with FCC radiation exposure limits set forth for an uncontrolled environment and meets the FCC radio frequency (RF) Exposure Guidelines. This equipment has very low levels of RF energy that it deemed to comply without maximum permissive exposure evaluation (MPE). But it is desirable that it should be installed and operated keeping the radiator at least 20cm or more away from person's body.</p>
California, U.S.A	Proposition 65	<div style="border: 1px solid black; padding: 5px;"> <p><b>WARNING :</b> Handling the cord on this product or cords associated with accessories sold with this product, will expose you to lead, a chemical known to the State of California to cause birth defects or other reproductive harm. <b><i>Wash hands after handling.</i></b></p> </div>
California, U.S.A	Perchlorate Material (CR Lithium Battery)	<div style="border: 1px solid black; padding: 5px;"> <p>This product contains a CR Lithium Battery which contains Perchlorate Material-special handling may apply. See <a href="http://www.dtsc.ca.gov/hazardouswaste/perchlorate/">http://www.dtsc.ca.gov/hazardouswaste/perchlorate/</a> Note ; This is applicable to California, U.S.A. only</p> </div>

Region/ Country	Directives/ Regulations	Description
California and NY, U.S.A.	Recycling Batteries	<p style="text-align: center;"><u>DON'T THROW AWAY RECHARGEABLE BATTERIES, RECYCLE THEM.</u></p> <p style="text-align: center;"><b><u>Topcon Positioning Systems Inc., United States Return Process for Used Rechargeable Nickel Metal Hydride, Nickel Cadmium, Small Sealed Lead Acid, and Lithium Ion, Batteries</u></b></p> <p>In the United States Topcon Positioning Systems Inc., has established a process by which Topcon customers may return used rechargeable Nickel Metal Hydride(Ni-MH), Nickel Cadmium(Ni-Cd), Small Sealed Lead Acid(Pb), and Lithium Ion(Li-ion) batteries to Topcon for proper recycling and disposal. Only Topcon batteries will be accepted in this process.</p> <p>Proper shipping requires that batteries or battery packs must be intact and show no signs of leaking. The metal terminals on the individual batteries must be covered with tape to prevent short circuiting and heat buildup or batteries can be placed in individual plastic bag. Battery packs should not be disassembled prior to return.</p> <p>Topcon customers are responsible for complying with all federal, state, and local regulations pertaining to packing, labeling, and shipping of batteries. Packages must include a completed return address, be prepaid by the shipper, and travel by surface mode. <b><u>Under no circumstance should used/recyclable batteries be shipped by air.</u></b></p> <p>Failure to comply with the above requirements will result in the rejection of the package at the shipper's expense.</p> <p>Please remit packages to: Topcon Positioning Systems, Inc. C/O Battery Return Dept. 150 7400 National Dr. Livermore, CA 94551</p> <p style="text-align: center;"><b><u>DON'T THROW AWAY RECHARGEABLE BATTERIES, RECYCLE THEM.</u></b></p>
Canada	ICES-Class B	<p>This class B digital apparatus meets all requirements of Canadian interference-Causing Equipment Regulations. Cet appareil numérique de la class B respecte toutes les exigences du Règlement sur le matériel brouilleur du Canada.</p> <p>This Class B digital apparatus complies with Canadian ICES-003 Cet appareil numérique de la Class B est conforme a la norme NMB-003 du Canada.</p> <p>Operation is subject to the following two conditions: (1) this device may not cause interference, and (2) this device must accept any interference, including interference that may cause undesired operation of this device.</p> <p>This equipment complies with IC radiation exposure limits set forth for an uncontrolled environment and meets the RSS-102 of the IC radio frequency (RF) Exposure Guidelines. This equipment has very low levels of RF energy that it deemed to comply without maximum permissive exposure evaluation (MPE). But it is desirable that it should be installed and operated keeping the radiator at least 20cm or more away from person's body.</p>

Region/ Country	Directives/ Regulations	Description
EU	EMC-Class B RE	<p><b>EMC NOTICE</b></p> <p>In industrial locations or in proximity to industrial power installations, this instrument might be affected by electromagnetic noise. Under such conditions, please test the instrument performance before use.</p> <p>This product complies with the electromagnetic environmental testing of industrial locations.</p> <p>Hereby, TOPCON CORPORATION declares that the radio equipment type of this product is in compliance with Directive 2014/53/EU. EU declaration of conformity is available depending on your request. Contact your local dealer.</p> <p><b>Manufacturer</b>  Name : TOPCON CORPORATION  Address : 75-1, Hasunuma-cho, Itabashi-ku, Tokyo, 174-8580 JAPAN</p> <p><b>Europe Representative and Importer</b>  Name : Topcon Europe Positioning B.V.  Address : Essebaan 11, 2908 LJ Capelle a/d IJssel, The Netherlands</p>
EU	WEEE Directive	<div style="border: 1px solid black; padding: 5px;">  <p><b>WEEE Directive</b>  This symbol is applicable to EU members states only.</p> <p>Following information is only for EU-member states:  The use of the symbol indicates that this product may not be treated as household waste. By ensuring this product is disposed of correctly, you will help prevent potential negative consequences for the environment and human health, which could otherwise be caused by inappropriate waste handling of this product. For more detailed information about the take-back and recycling of this product, please contact your supplier where you purchased the product or consult.</p> </div>
EU	EU Battery Directive	<div style="border: 1px solid black; padding: 5px;">  <p><b>EU Battery Directive</b>  This symbol is applicable to EU members states only.</p> <p>Battery users must not dispose of batteries as unsorted general waste, but treat properly.  If a chemical symbol is printed beneath the symbol shown above, this chemical symbol means that the battery or accumulator contains a heavy metal at a certain concentration. This will be indicated as follows:  Hg: mercury(0.0005%), Cd: cadmium(0.002%), Pb: lead(0.004%)</p> <p>These ingredients may be seriously hazardous to human and the global environment.</p> </div> <div style="border: 1px solid black; padding: 5px; margin-top: 10px;"> <p>This product contains a coin cell.  You cannot replace batteries by yourself. When you need to replace and/or dispose batteries, contact your local dealer.</p> </div>

Region/ Country	Directives/ Regulations	Description																																																							
China	Chinese Environmental Directive	<p style="text-align: center;">&lt; 产品中有毒有害物质或元素的名称及含量 &gt;</p> <table border="1" style="width: 100%; border-collapse: collapse;"> <thead> <tr> <th rowspan="2" style="width: 20%;">部件名称</th> <th colspan="6" style="text-align: center;">有毒有害物质或元素</th> </tr> <tr> <th style="width: 10%;">铅 (Pb)</th> <th style="width: 10%;">汞 (Hg)</th> <th style="width: 10%;">镉 (Cd)</th> <th style="width: 10%;">六价铬 (Cr(VI))</th> <th style="width: 10%;">多溴联苯 (PBB)</th> <th style="width: 10%;">多溴二苯醚 (PBDE)</th> </tr> </thead> <tbody> <tr> <td>望远镜部位 (除了印纹主板)</td> <td style="text-align: center;">×</td> <td style="text-align: center;">○</td> <td style="text-align: center;">×</td> <td style="text-align: center;">×</td> <td style="text-align: center;">○</td> <td style="text-align: center;">○</td> </tr> <tr> <td>主机托架部 (除了印纹主板)</td> <td style="text-align: center;">×</td> <td style="text-align: center;">○</td> <td style="text-align: center;">×</td> <td style="text-align: center;">×</td> <td style="text-align: center;">○</td> <td style="text-align: center;">○</td> </tr> <tr> <td>主板部位</td> <td style="text-align: center;">×</td> <td style="text-align: center;">○</td> <td style="text-align: center;">×</td> <td style="text-align: center;">×</td> <td style="text-align: center;">○</td> <td style="text-align: center;">○</td> </tr> <tr> <td>显示器</td> <td style="text-align: center;">×</td> <td style="text-align: center;">○</td> <td style="text-align: center;">○</td> <td style="text-align: center;">○</td> <td style="text-align: center;">○</td> <td style="text-align: center;">○</td> </tr> <tr> <td>印纹主板</td> <td style="text-align: center;">×</td> <td style="text-align: center;">○</td> <td style="text-align: center;">×</td> <td style="text-align: center;">×</td> <td style="text-align: center;">○</td> <td style="text-align: center;">○</td> </tr> <tr> <td>其他 (电源、充电器、盒子等)</td> <td style="text-align: center;">×</td> <td style="text-align: center;">○</td> <td style="text-align: center;">○</td> <td style="text-align: center;">○</td> <td style="text-align: center;">○</td> <td style="text-align: center;">○</td> </tr> </tbody> </table> <p>○: 表示该有毒有害物质在该部件所有均质材料中的含量均在电子信息产品中有毒有害物质的限量要求标准规定的限量要求 (SJ/T11363-2006)以下</p> <p>×: 表示该有毒有害物质至少在该部件的某一均质材料中的含量超出电子信息产品中有毒有害物质的限量要求标准规定的限量要求 (SJ/T11363-2006)</p> <p style="text-align: center;">This information is applicable for People's Republic of China only.</p> <div style="border: 1px solid black; padding: 5px; margin-top: 10px;"> <p style="text-align: center;"> 环保使用期限标识是根据《电子信息产品污染控制管理办法》以及《电子信息产品污染控制标识要求》制定的，适用于中国境内销售的电子信息产品的标识。</p> <p style="text-align: center;">只要按照安全及使用说明内容在正常使用电子信息产品情况下，从生产日期算起，在此期限内产品中含有的有毒有害物质不致发生外泄或突变，不致对环境造成严重污染或对其人身、财产造成严重损害。</p> <p style="text-align: center;">产品正常使用后，要废弃在环保使用年限内或者刚到年限的产品，请根据国家标准采取适当的方法进行处置。</p> <p style="text-align: center;">另外，此期限不同于质量/功能的保证期限。</p> <p style="text-align: center;">The Mark and Information are applicable for People's Republic of China only.</p> </div>	部件名称	有毒有害物质或元素						铅 (Pb)	汞 (Hg)	镉 (Cd)	六价铬 (Cr(VI))	多溴联苯 (PBB)	多溴二苯醚 (PBDE)	望远镜部位 (除了印纹主板)	×	○	×	×	○	○	主机托架部 (除了印纹主板)	×	○	×	×	○	○	主板部位	×	○	×	×	○	○	显示器	×	○	○	○	○	○	印纹主板	×	○	×	×	○	○	其他 (电源、充电器、盒子等)	×	○	○	○	○	○
部件名称	有毒有害物质或元素																																																								
	铅 (Pb)	汞 (Hg)	镉 (Cd)	六价铬 (Cr(VI))	多溴联苯 (PBB)	多溴二苯醚 (PBDE)																																																			
望远镜部位 (除了印纹主板)	×	○	×	×	○	○																																																			
主机托架部 (除了印纹主板)	×	○	×	×	○	○																																																			
主板部位	×	○	×	×	○	○																																																			
显示器	×	○	○	○	○	○																																																			
印纹主板	×	○	×	×	○	○																																																			
其他 (电源、充电器、盒子等)	×	○	○	○	○	○																																																			
Taiwan	NCC	<p style="text-align: center;"><u>低功率電波輻射性電機管理辦法</u></p> <p>第十二條</p> <p style="padding-left: 2em;">經型式認證合格之低功率射頻電機，非經許可，公司、商號或使用者均不得擅自變更頻率、加大功率或變更原設計之特性及功能。</p> <p>第十四條</p> <p style="padding-left: 2em;">低功率射頻電機之使用不得影響飛航安全及干擾合法通信；經發現有干擾現象時，應立即停用，並改善至無干擾時方得繼續使用。</p> <p style="padding-left: 2em;">前項合法通信，指依電信法規定作業之無線電通信。</p> <p style="padding-left: 2em;">低功率射頻電機須忍受合法通信或工業、科學及醫療用電波輻射性電機設備之干擾。</p>																																																							

---

**TOPCON CORPORATION** (Manufacturer)

75-1 Hasunuma-cho, Itabashi-ku, Tokyo 174-8580, Japan <http://www.topcon.co.jp>

Please see the attached address list or the following website for contact addresses.

**GLOBAL GATEWAY** <http://global.topcon.com/>

---