



# HALLMARK HOME CABINETS®



# A KITCHEN MADE FOR GENERATIONS

Step into the world of Hallmark Home®—a cabinetry line inspired by the natural beauty of wood, the elegance of clean design, and the modern homeowner's need for both style and function. From the heart of your kitchen to the serenity of your bathroom vanity, our cabinets are crafted to transform everyday spaces into something extraordinary.

At the core of Hallmark Home is a commitment to quality, simplicity, and beauty. Our curated collection features a versatile range of painted and stained door styles, thoughtfully chosen to suit a wide variety of home aesthetics—from warm and rustic to sleek and contemporary. Whether you prefer the crisp, clean lines of a painted cabinet in a soft neutral tone or the depth and richness of a stained finish that celebrates the natural grain of the wood, Hallmark Home offers a palette and profile to reflect your personal style.

Hallmark Home® Cabinets are more than just a design choice—they're a statement about how you live. They invite calm, order, and elegance into your everyday routine, helping to create a home that's warm, welcoming, and uniquely yours.

Explore our collections. Be inspired. And bring home cabinetry that's as refined as it is real.





# CONTENT



- 6 Quality
- 8 Design
- 10 Style
- 20 Range



# QUALITY IN EVERY DETAIL

At Hallmark Home®, we've redefined cabinetry by making premium features standard across every collection. Our frameless cabinets offer a clean, modern look and are built with durable  $\frac{3}{4}$ " all-plywood box construction. Inside,  $\frac{5}{8}$ " dovetail drawers with  $\frac{3}{8}$ " bottoms provide lasting strength, while soft-close hardware and six-way adjustable hinges ensure smooth, quiet performance. Crafted for style, function, and lasting value.

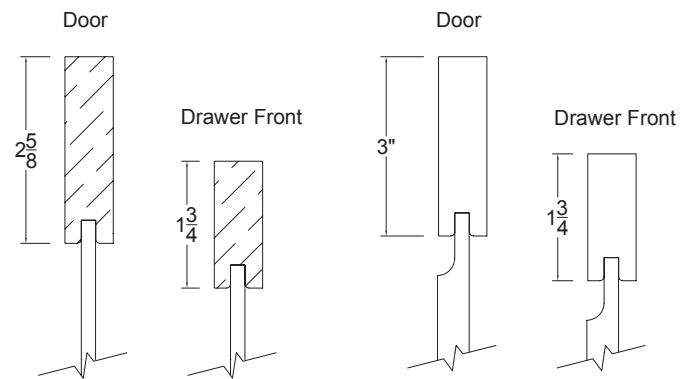

Door joints in particular are likely to react to the conditions of their environment. Gaps that may develop are not included or covered by this limited liability warranty. This limited liability warranty does not cover or apply to hairline cracks of painted finishes; hairline cracks are unavoidable in wood cabinets given the nature of the material. Every species and grade of solid wood behaves in such a way as to eventually result in hairline cracks.

9) Drawer box 5/8" solid wood, Fully captured 3/8" bottom with dovetail joints. Guide undermount soft-close full extension

5) Back panel 1/2" plywood recessed 1/8"

1) Side Panels 3/4" nominal (18mm) Birch veneer plywood Int/Ext

7) Hinge Six-way adjustable soft-close

2) Stretchers 3/4" nominal (18mm) Birch veneer plywood Int/Ext

6) Door Panel

10) Adjustable Legs

4) Shelf Full depth 3/4" nominal (18mm) Birch veneer plywood Int/Ext

8) Toe Kick in 3/4"x96" L

3) Bottom 3/4" nominal (18mm) Birch veneer plywood Int/Ext

### FRAMELESS BOX CONSTRUCTION

Maximum storage space, ease of access. No frame means cleaner lines and a more modern look.

### ALL PLYWOOD, 3/4" NOMINAL CONSTRUCTION

No particle board/MDF - 100% plywood proves a higher quality cabinet with waterproof glue.

### 5/8" DOVETAIL DRAWERS WITH 3/8" BOTTOM,

Dovetail joints are strongest joint type in cabinetry, known for strength and durability. 3/8" thick bottom panel shows a high weight bearing capacity

### SOFT CLOSE, SIX WAY ADJUSTABLE HINGES

Gentle and controlled closing, adjustment for precise alignment and customisation.

### 13" DEPTH UPPER CABINET

Maximum storage space.

### FULL DEPTH BASE CABINET SHELVES

Maximum storage space.

### DOWEL/CASE CLAMP CONSTRUCTION (GLUE, STAPLES AND SCREWS USED)

Balance of strength and efficiency in cabinet assembly - traditional cabinetry construction, with furniture grade box.

### INTEGRATED CABINET ALUMINIUM PULL ON WALL DOOR CABINETS

This type of design is often chosen for modern and minimalist aesthetic, where the hardware becomes a subtle part of the overall cabinet design

### COMPOSITE ADJUSTABLE LEGS

Waterproof engineering

### MARINE GRADE PLYWOOD

Waterproof glues make these cabinets the strongest cabinets in the market against moisture.

# DESIGN

## THAT WILL STAND THE TEST OF TIME

---

**TERRA DOORSTYLE** - 2 5/8" Wide stile & rail, 3/4" thick 5 piece French oak door with a 5mm thick veneer panel - available in 2 colors, LAGUNA (light brown) French white oak look and NEWPORT (medium brown) French white oak.



LAGUNA



NEWPORT

---

**LUNA DOORSTYLE** - 5/8" Wide stile & rail, slim shaker door style. 5 piece front door and drawer fronts - available in NEWPORT (medium brown) French white oak and Creative Black.



NEWPORT



CREATIVE BLACK

---

**SOLANO DOORSTYLE** - 3" wide stile and rail, ¾" thick five piece MDF door & drawer front with reversed raised center panel – available in three solid colors, white, grey and blue.



WHITE

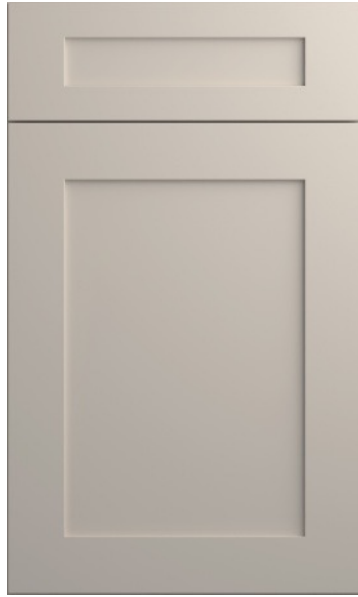

GREY

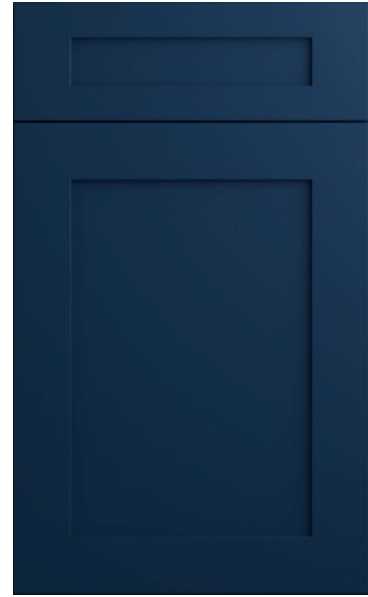

BLUE



# FRENCH WHITE OAK

Bring natural elegance and understated luxury into your home with Hallmark Home's French White Oak Cabinets. Carefully crafted to highlight the distinctive grain patterns and subtle color variations of real white oak, these cabinets embody a timeless, organic beauty. The soft, neutral finish brightens kitchens and vanities, creating a sense of warmth and openness that complements both modern and traditional styles. Whether paired with sleek quartz countertops or classic marble, French White Oak adds texture, character, and depth to any space. With durable construction and a refined, natural aesthetic, these cabinets are designed to make a lasting impression—elevating your home with every detail.





# CREATIVE BLACK

Daring, modern, and undeniably elegant—Hallmark Home’s Black French Oak Cabinets are designed for those who embrace bold design and refined craftsmanship. The rich, deep finish brings out the dramatic grain patterns of genuine French Oak, creating a stunning contrast that anchors any space with confidence. These cabinets exude contemporary sophistication while retaining the natural texture and warmth of real wood. Whether featured in a minimalist kitchen or paired with luxe materials like brass, marble, or concrete, Black French Oak adds depth, drama, and distinction. Built with enduring quality and a fearless aesthetic, this collection transforms everyday spaces into unforgettable showcases of design.





# ELEGANT WHITE

Elevate your space with the timeless elegance of Hallmark Homes White Cabinets. With their clean, crisp finish, these cabinets bring a sense of sophistication and light to any kitchen or bathroom. The versatile white hue complements a wide range of countertops, from sleek modern styles to rustic charm, making them the perfect foundation for any design. Built for durability and easy maintenance, Hallmark Homes White Cabinets offer both functionality and beauty, creating a bright, welcoming atmosphere in your home.





# STYLISH GREY

Elevate your space with the timeless sophistication of Hallmark Home's Stylish Grey Cabinets. Designed to blend seamlessly into both modern and classic interiors, these cabinets offer a perfect balance of soft neutrality and sleek charm. Whether you're updating a kitchen or refreshing a vanity, our grey finish adds depth and versatility—complementing everything from warm wood tones to bold countertops. Built with precision craftsmanship and durable finishes, Hallmark Home cabinets bring beauty, function, and lasting style to the heart of your home.





# CLASSIC BLUE

Add a touch of sophistication with Hallmark Homes Blue Cabinets. This rich, deep blue hue brings a bold yet calming vibe to any kitchen or bathroom, blending modern style with classic appeal. Durable and easy to maintain, these cabinets offer both beauty and functionality, providing ample storage and a smooth finish that stands up to daily use. Versatile enough to complement any countertop, they create a serene and inviting atmosphere in your home for years to come.





ELEMENT, AURA AND VERO DOORSTYLES & COLORS ALSO AVAILABLE.

**AURA DOORSTYLE** - SUPER MATTE - 3/4" thick slab doorstyle with a Slab drawer front. Core of door is HDF with super matte lacquered external face. All four edges are edgebanded with ABS on both doors and drawerfronts. With high abrasion and scratch resistance, the lacquered surface offers a silky soft and anti-fingerprint finish.

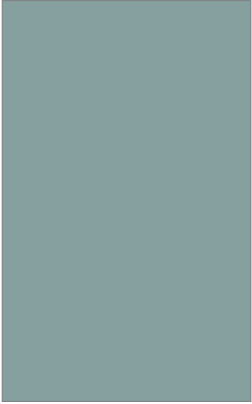

AQUA SKY  
SM

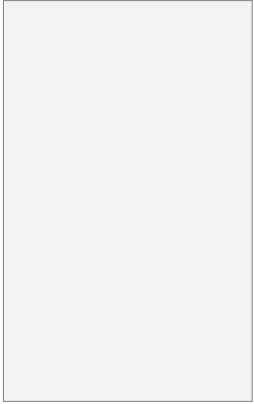

ARCTIC WHITE  
SM

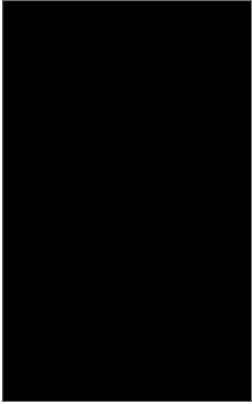

CARBON BLACK  
SM

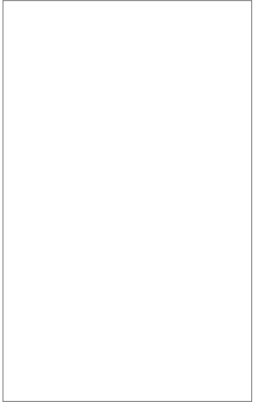

CLASSIC WHITE  
SM

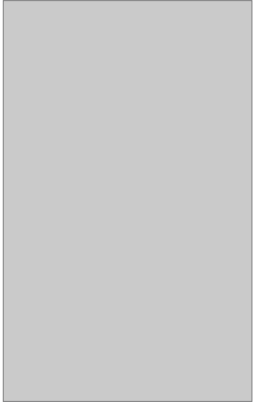

COASTAL GREY  
SM



CYPRESS GREEN  
SM

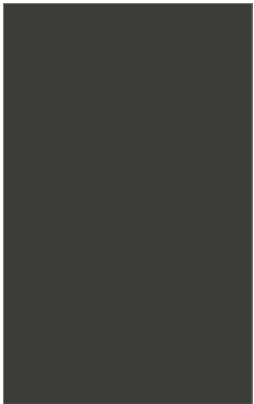

DEEP GREY  
SM

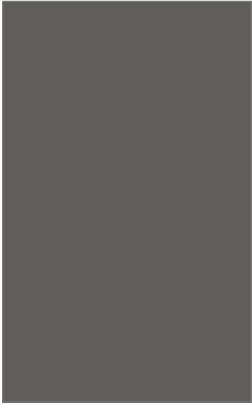

FOSSIL GREY  
SM

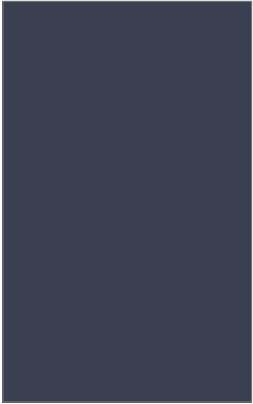

MIDNIGHT BLUE  
SM

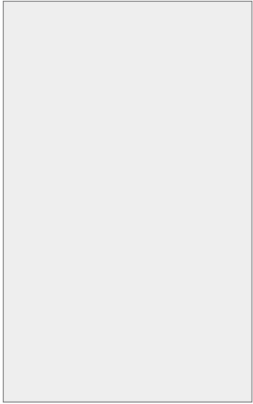

PASTEL GREY  
SM



SAPPHIRE BLUE  
SM

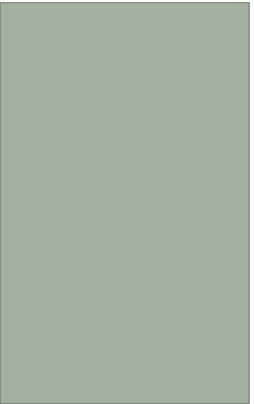

SPRING FERN  
SM

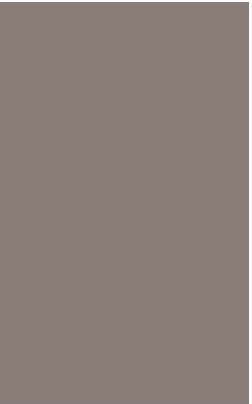

STONE SM

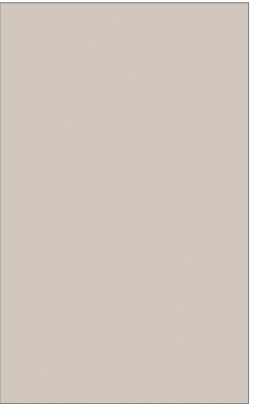

OYSTER SM

**ELEMENT DOORSTYLE** - TFL - 3/4" thick slab doorstyle with a slab drawer front. Drawerfront grain runs perpendicular to door on standard applications. Core of door is particleboard (furniture board) with TFL textured melamine external face. All four edges are edgebanded with ABS on both doors and drawerfronts.



IMPERIA 1



IMPERIA 2



IMPERIA 3



IMPERIA 4



LAGOS



MILAN 1



MILAN 4



NAPLES 1



NAPLES 2



NAPLES 3



ODESSA 3



PORTO 1



PORTO 2



PORTO 3



ROMA 1



ROMA 2



ROMA 3

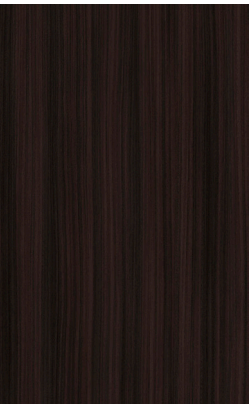

WARSAW 3



WARSAW 4



CASTELO ASH

All custom shipped doorstyles use the same cabinet box; due to local custom panel sourcing, they have a longer lead time.

---

**VERO DOORSTYLE** - HIGH GLOSS - 3/4" thick slab doorstyle with a slab drawer front. Core of door is HDF with high gloss lacquered external face. All four edges are edgebanded with HG ABS on both doors and drawerfronts.

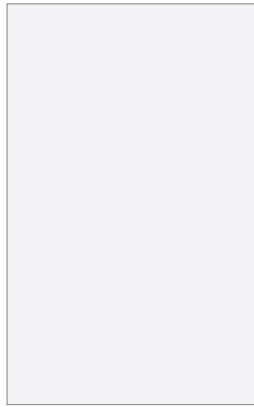

ARCTIC WHITE  
HG



CARBON BLACK HG

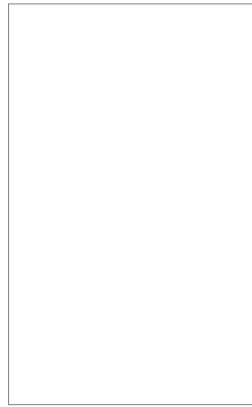

CLASSIC WHITE  
HG

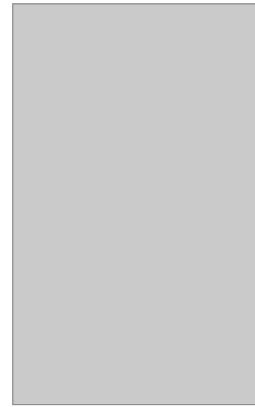

COASTAL GREY  
HG



DEEP GREY  
HG

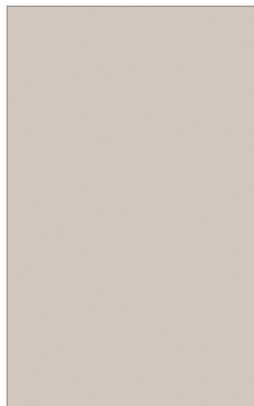

OYSTER HG





HALLMARKHARDWOODS.COM