

SPIDER TIE

WWW.SPIDER TIE.COM

PATENT PENDING

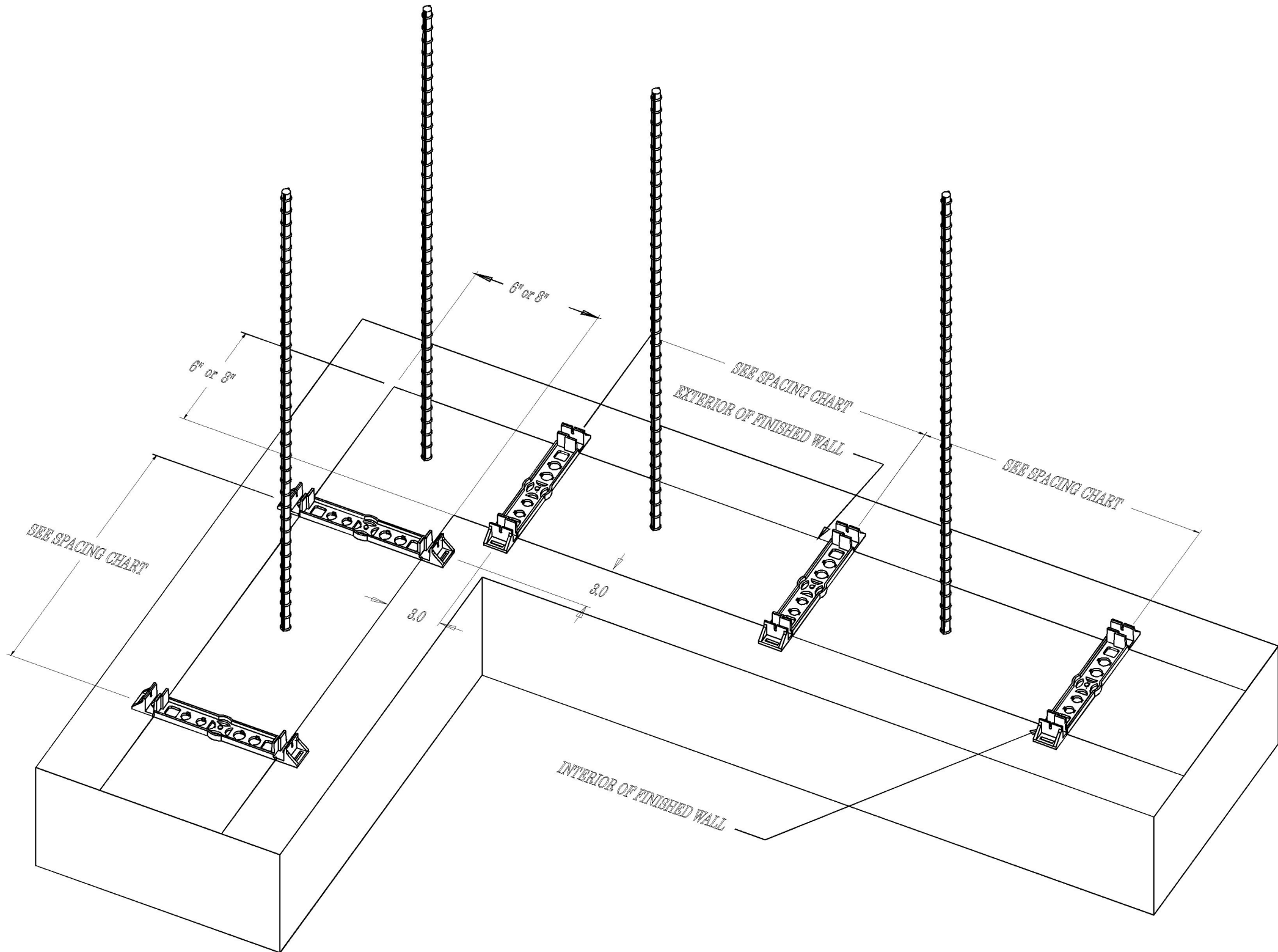

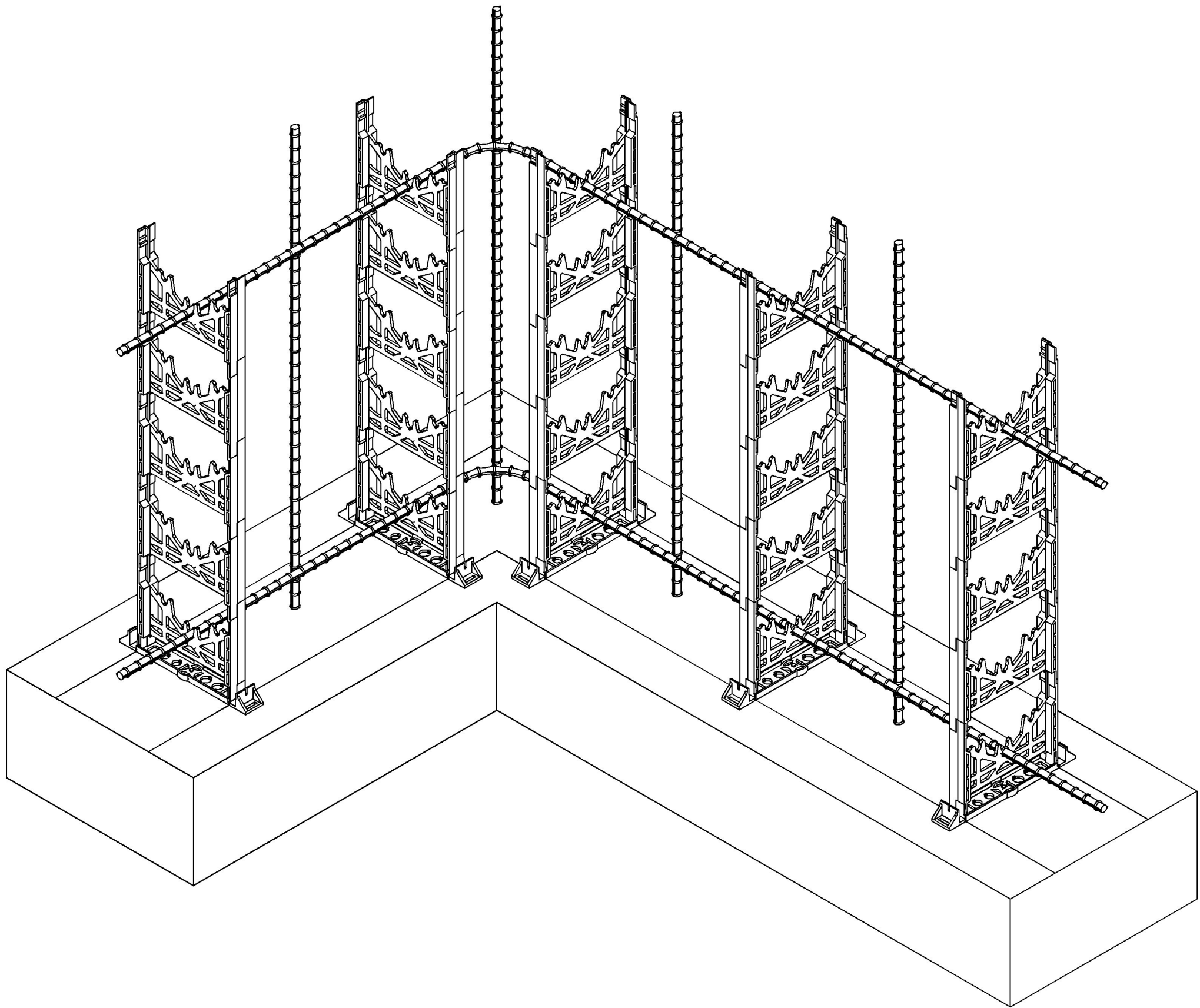

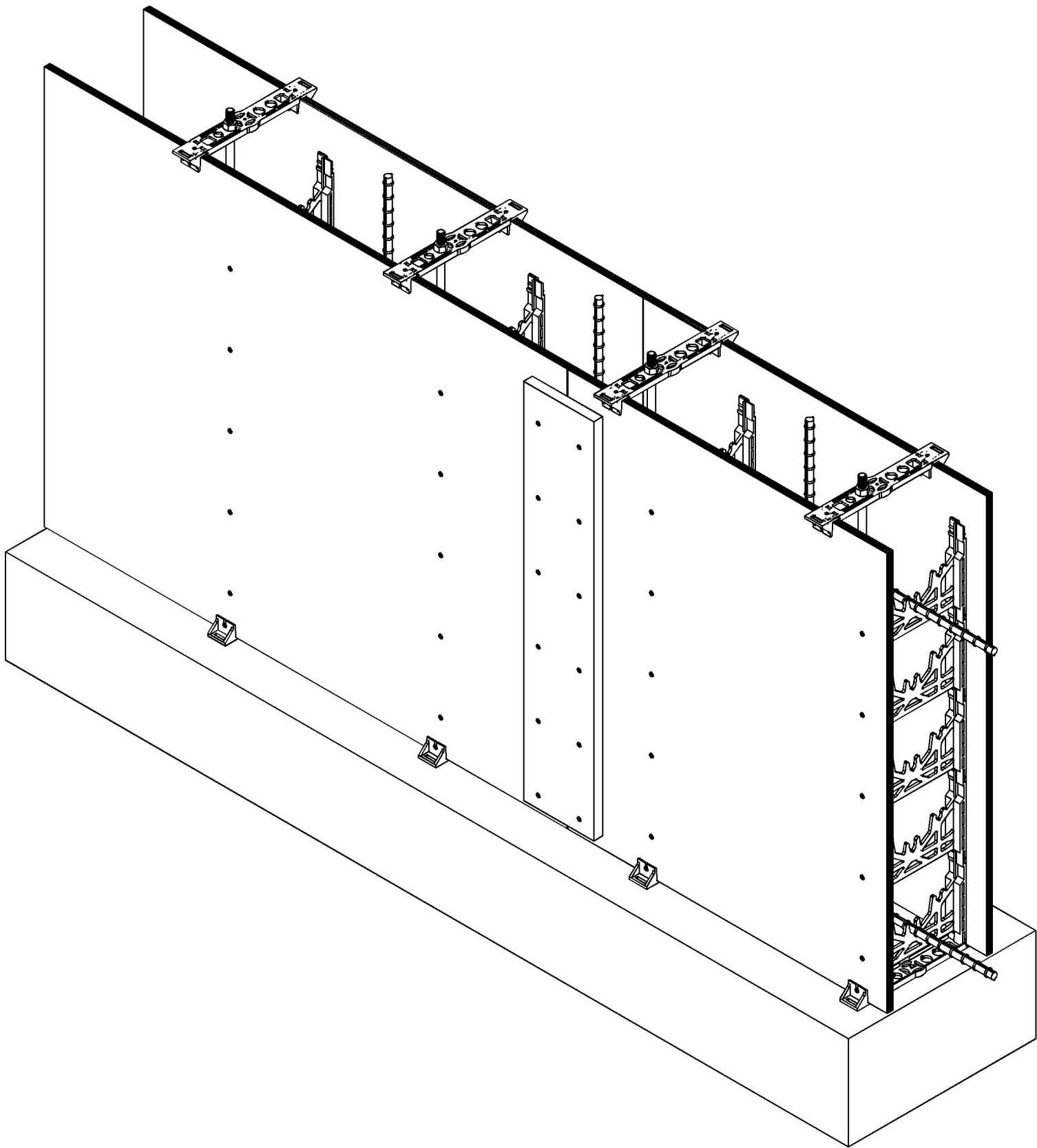

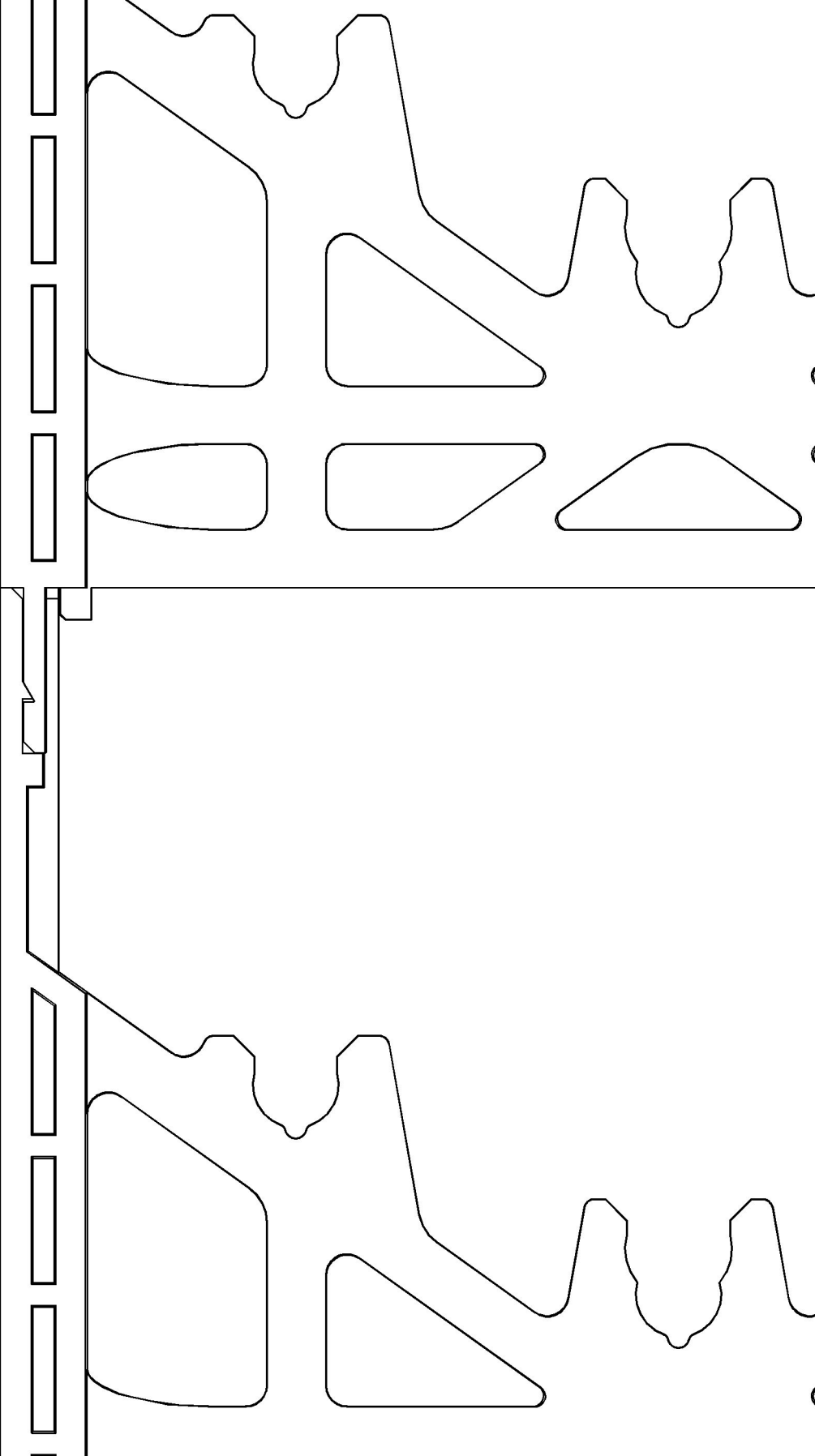

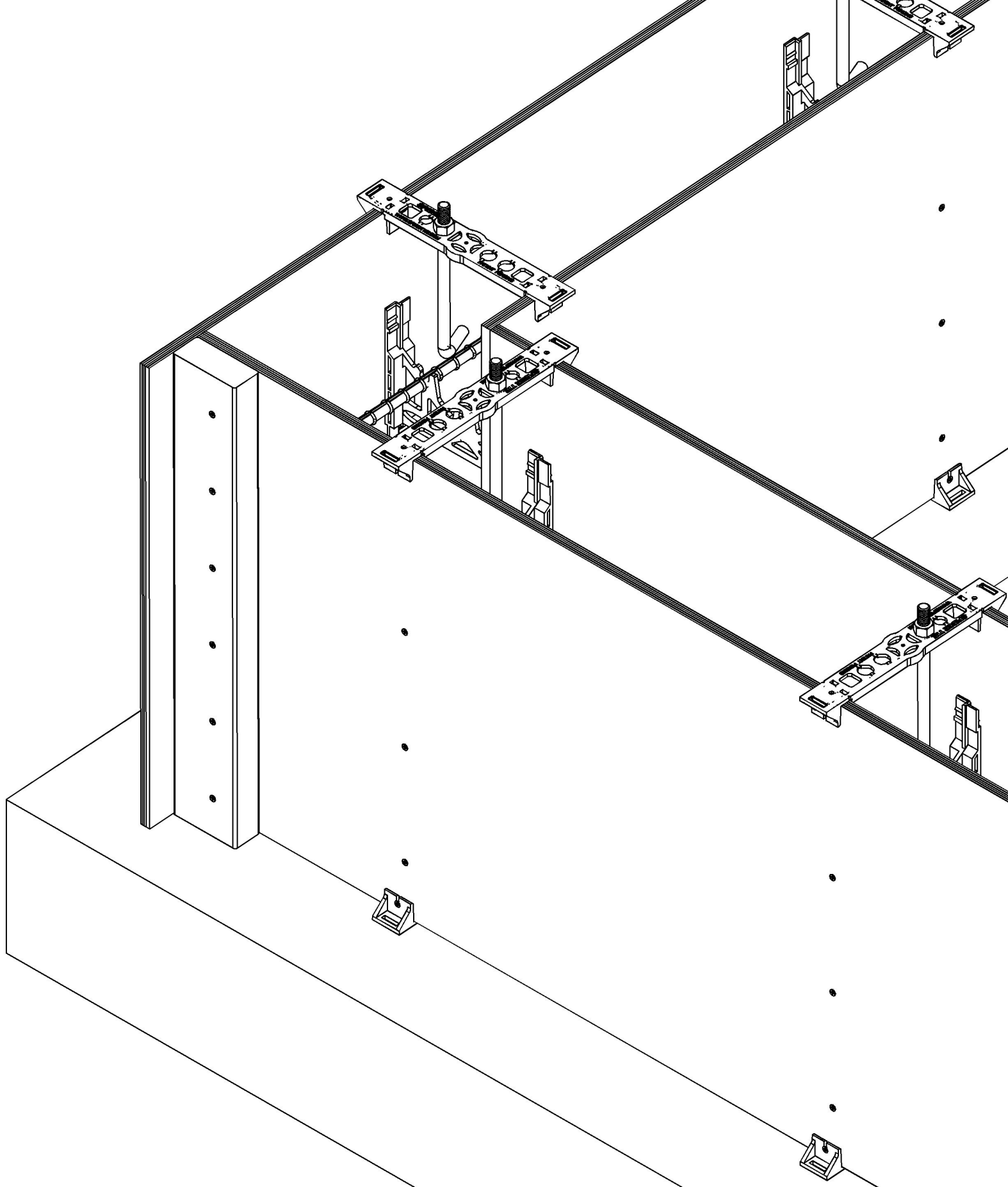

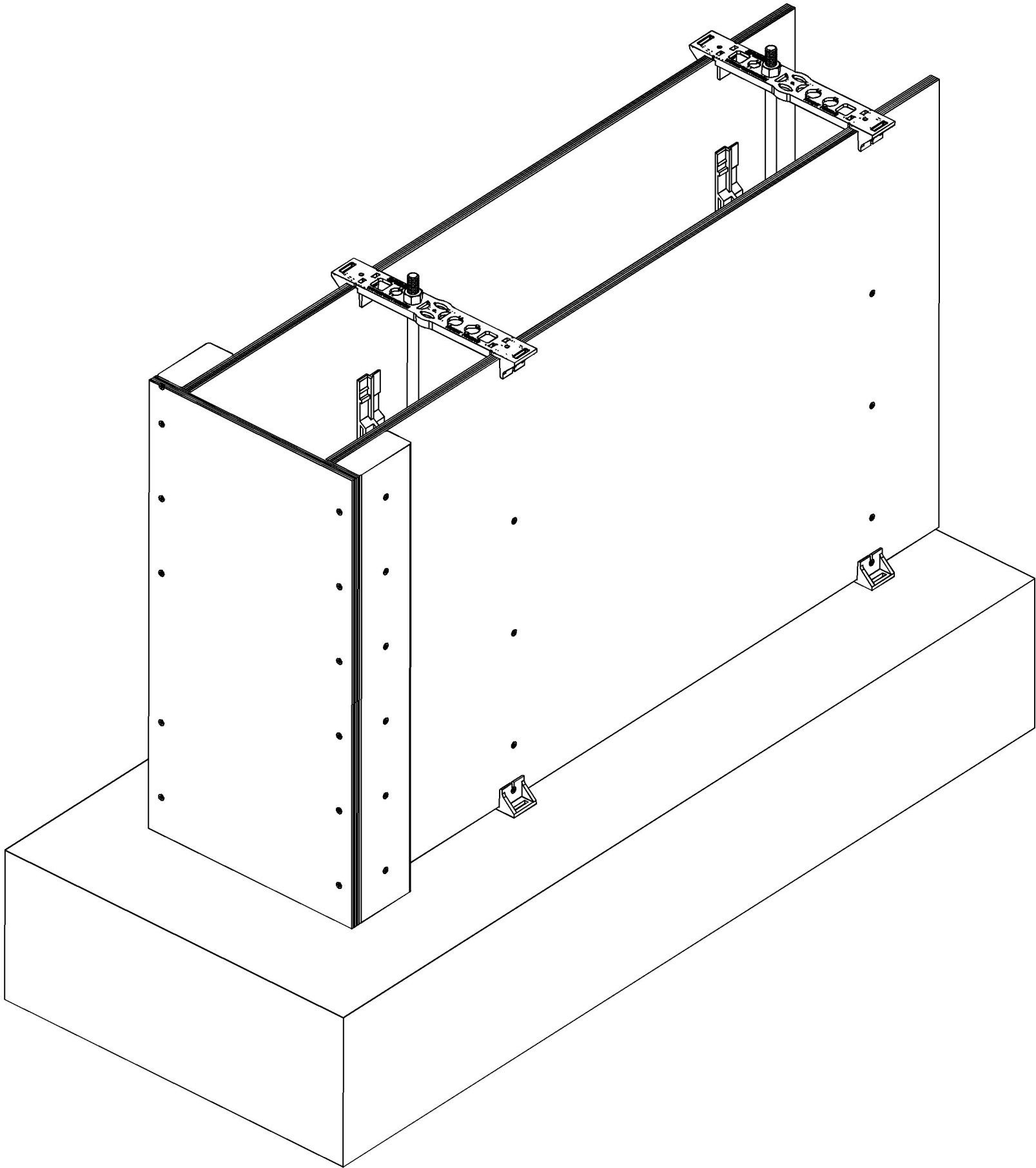

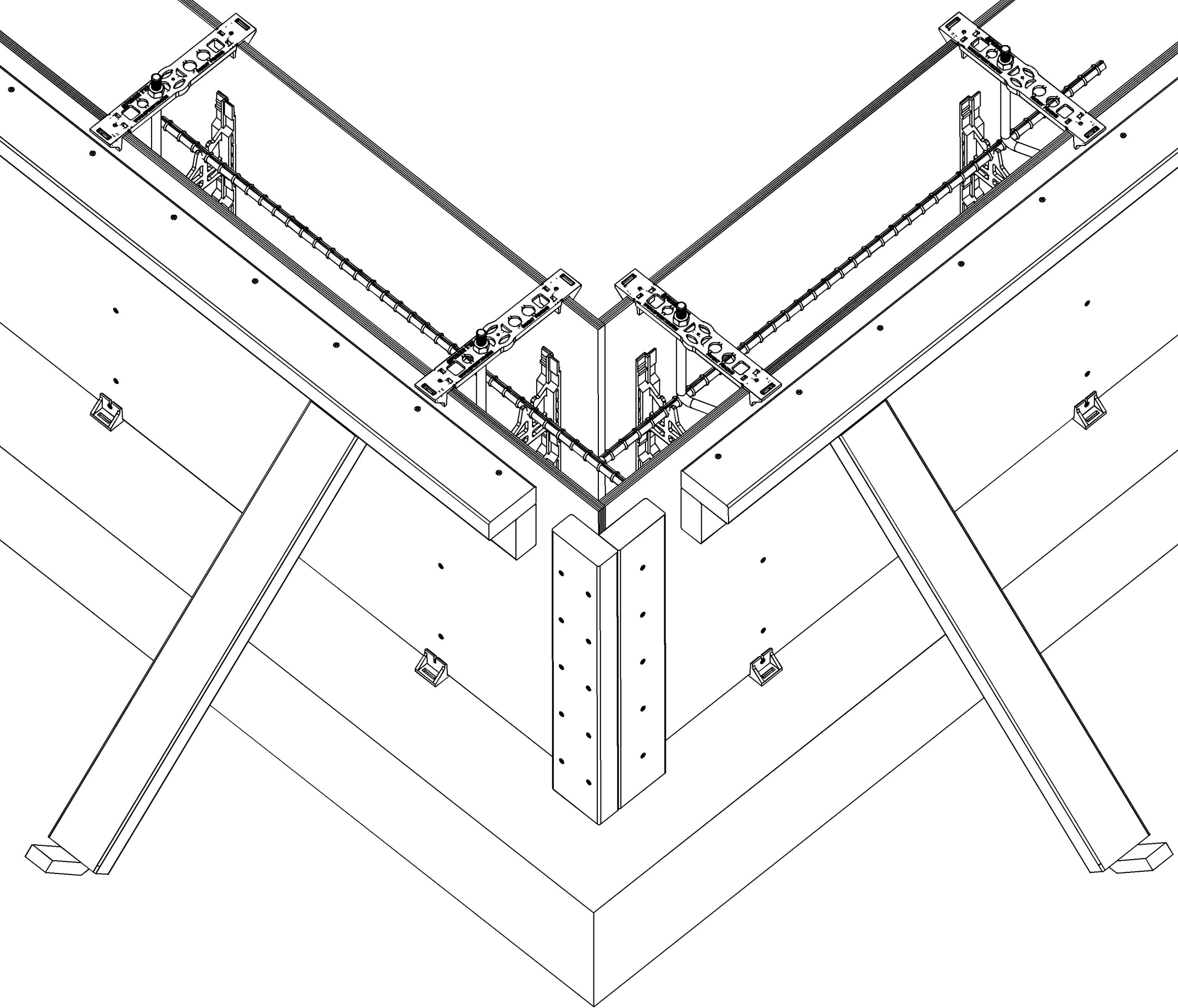

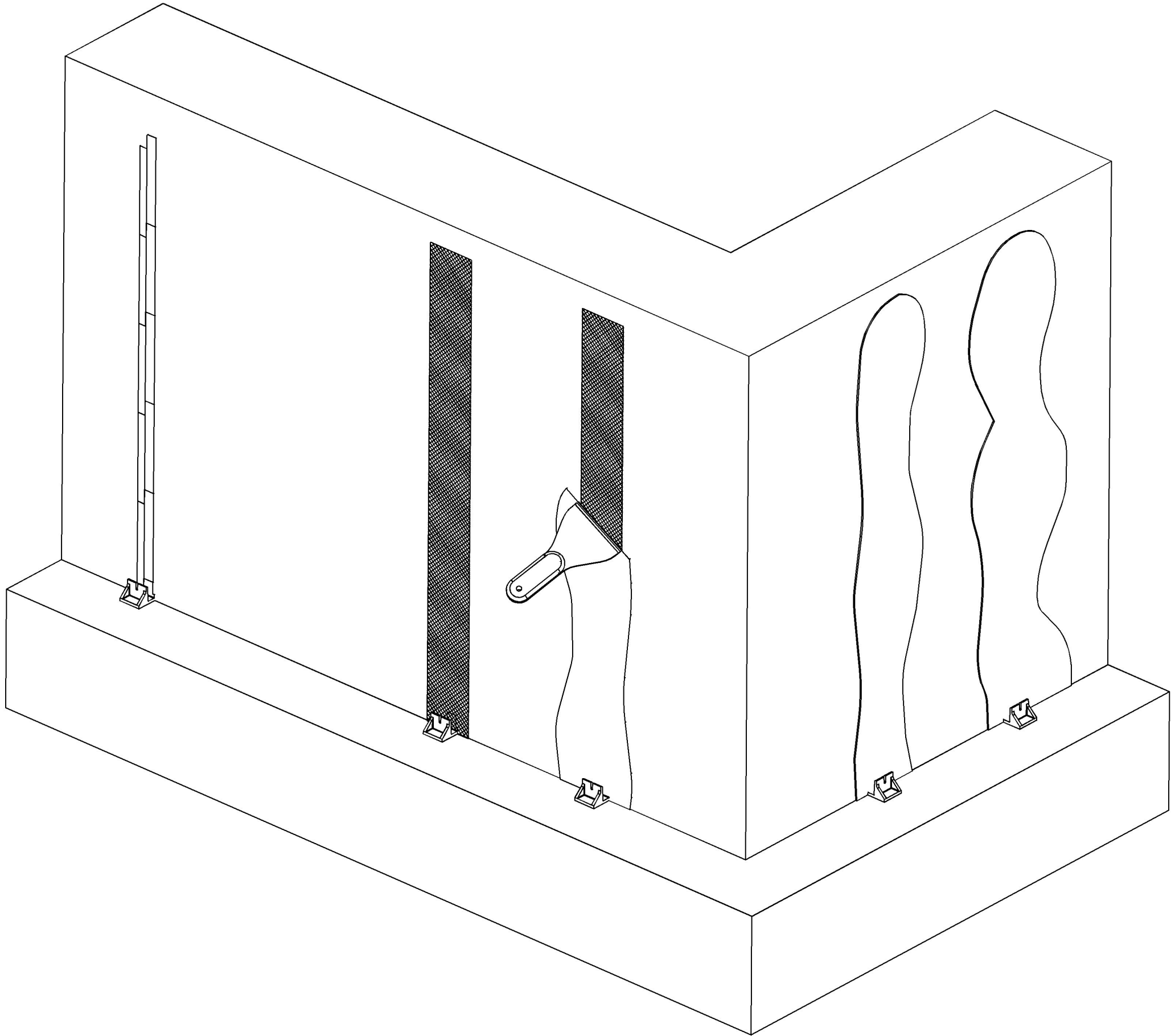

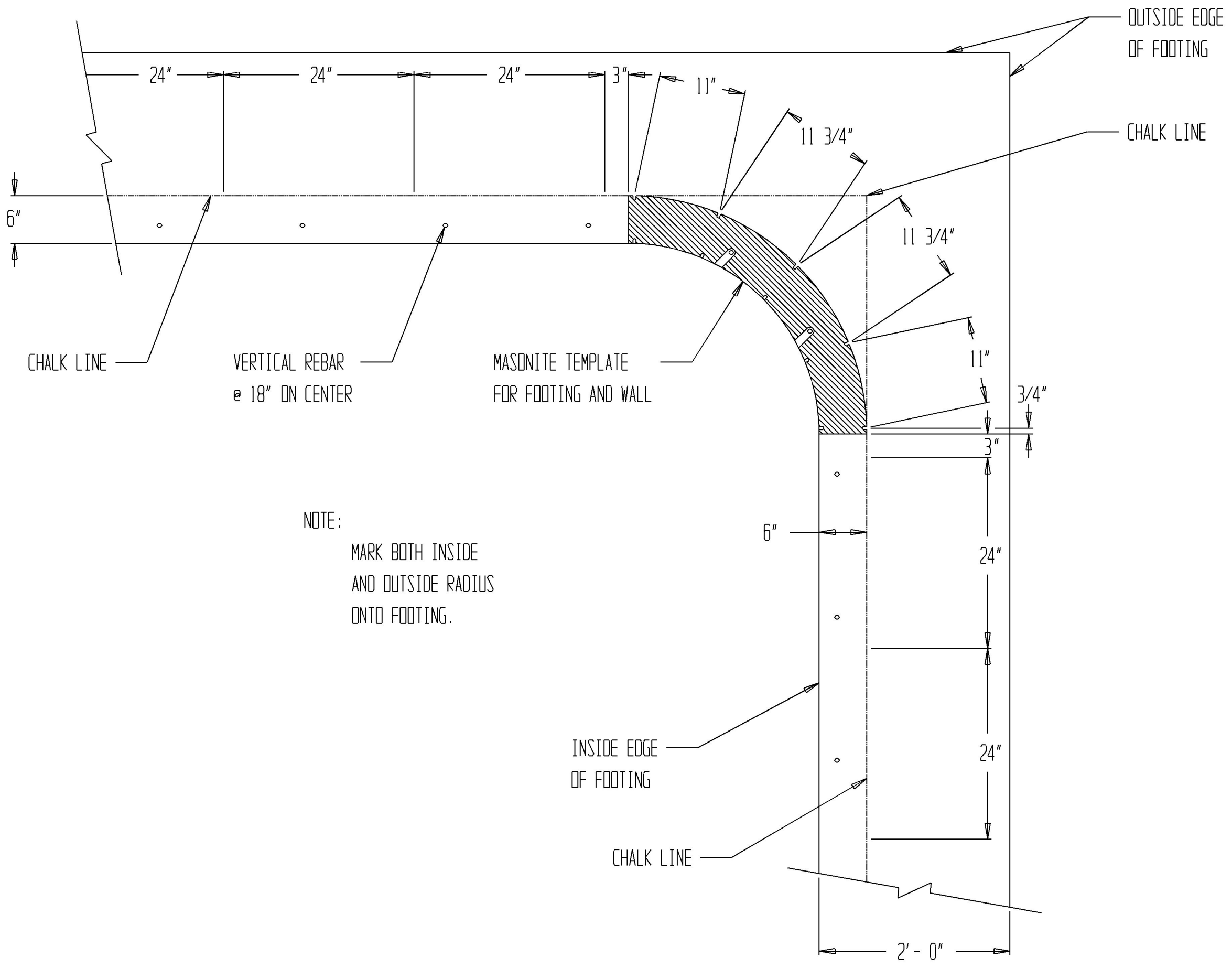

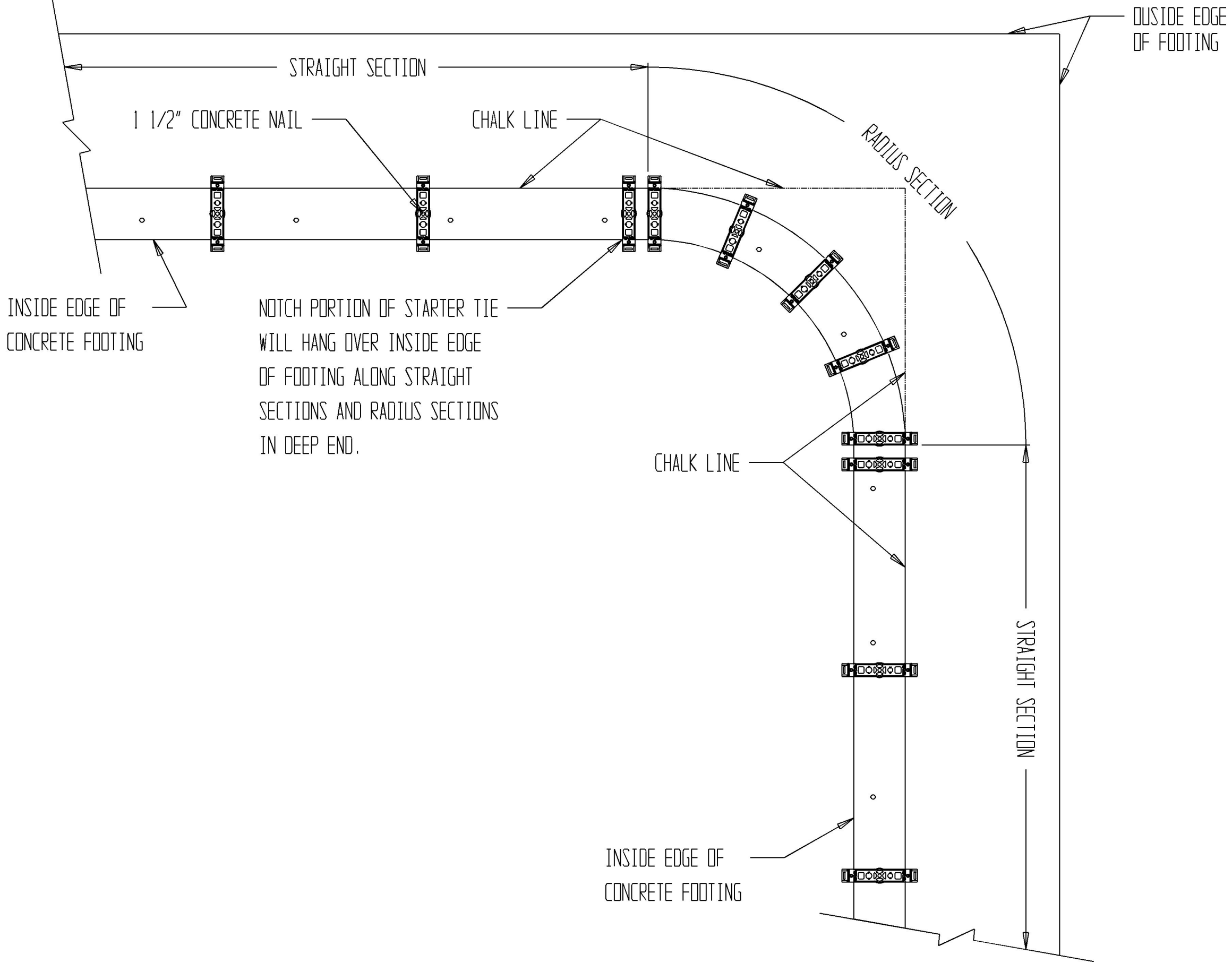

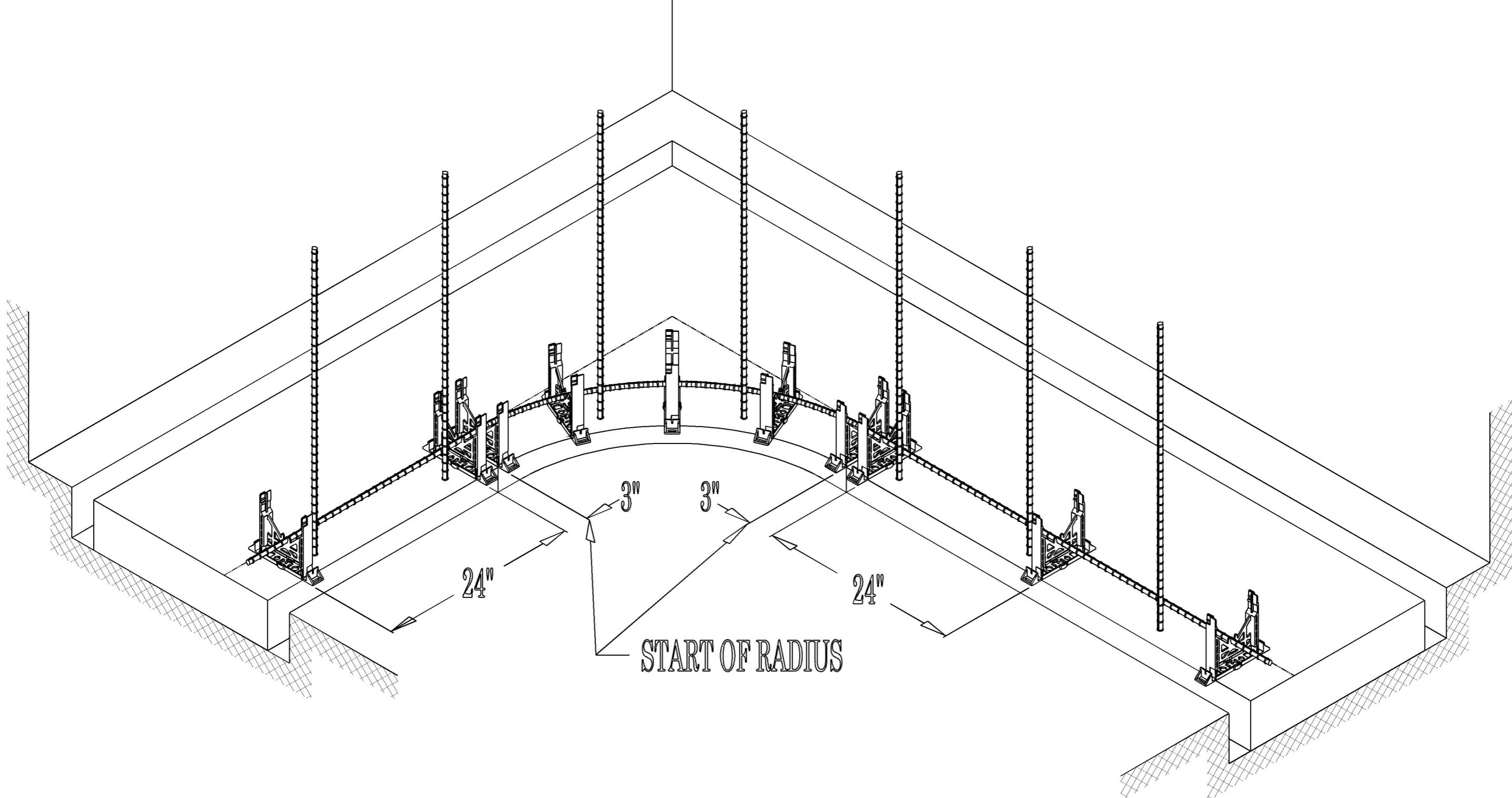

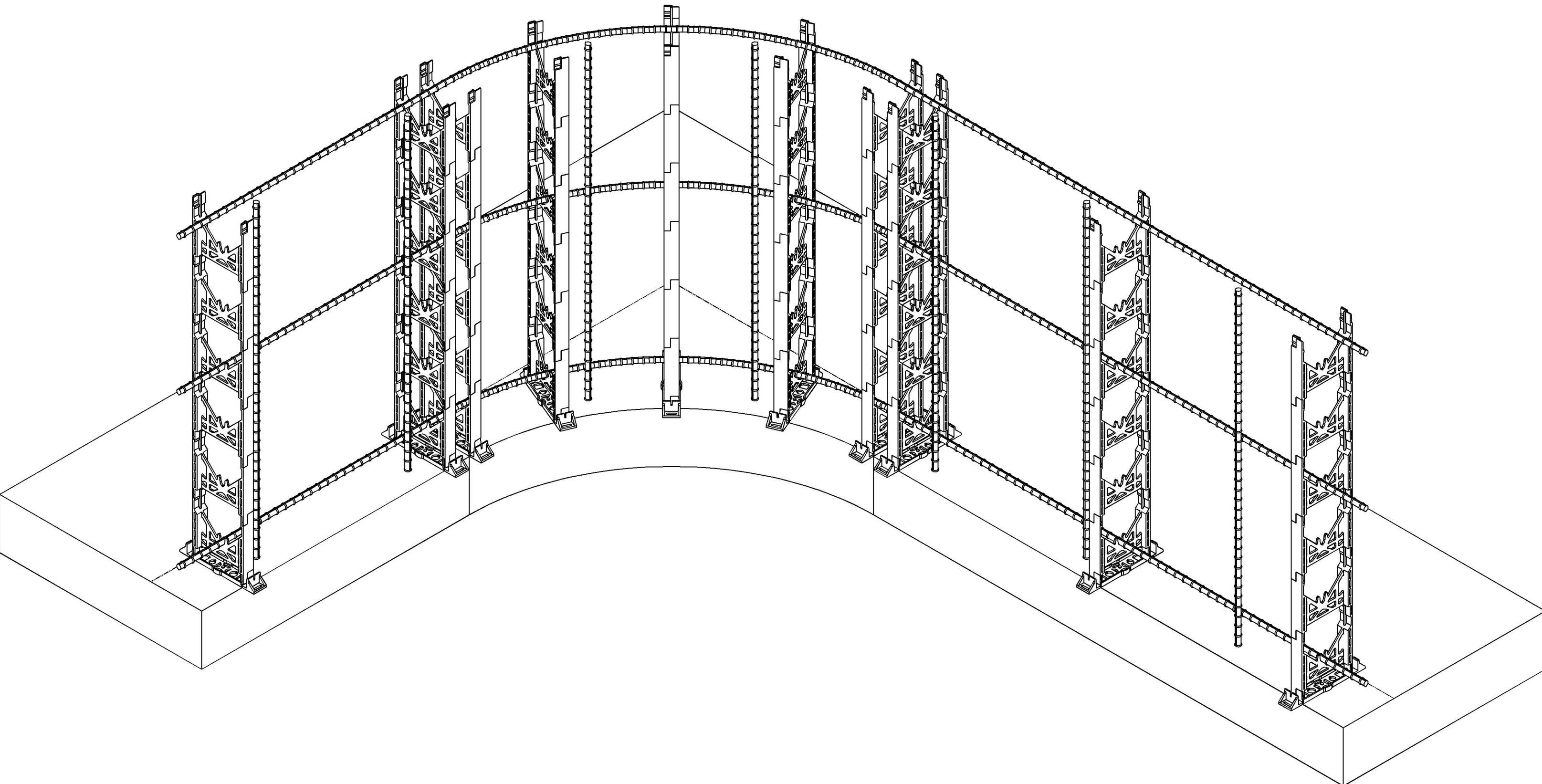

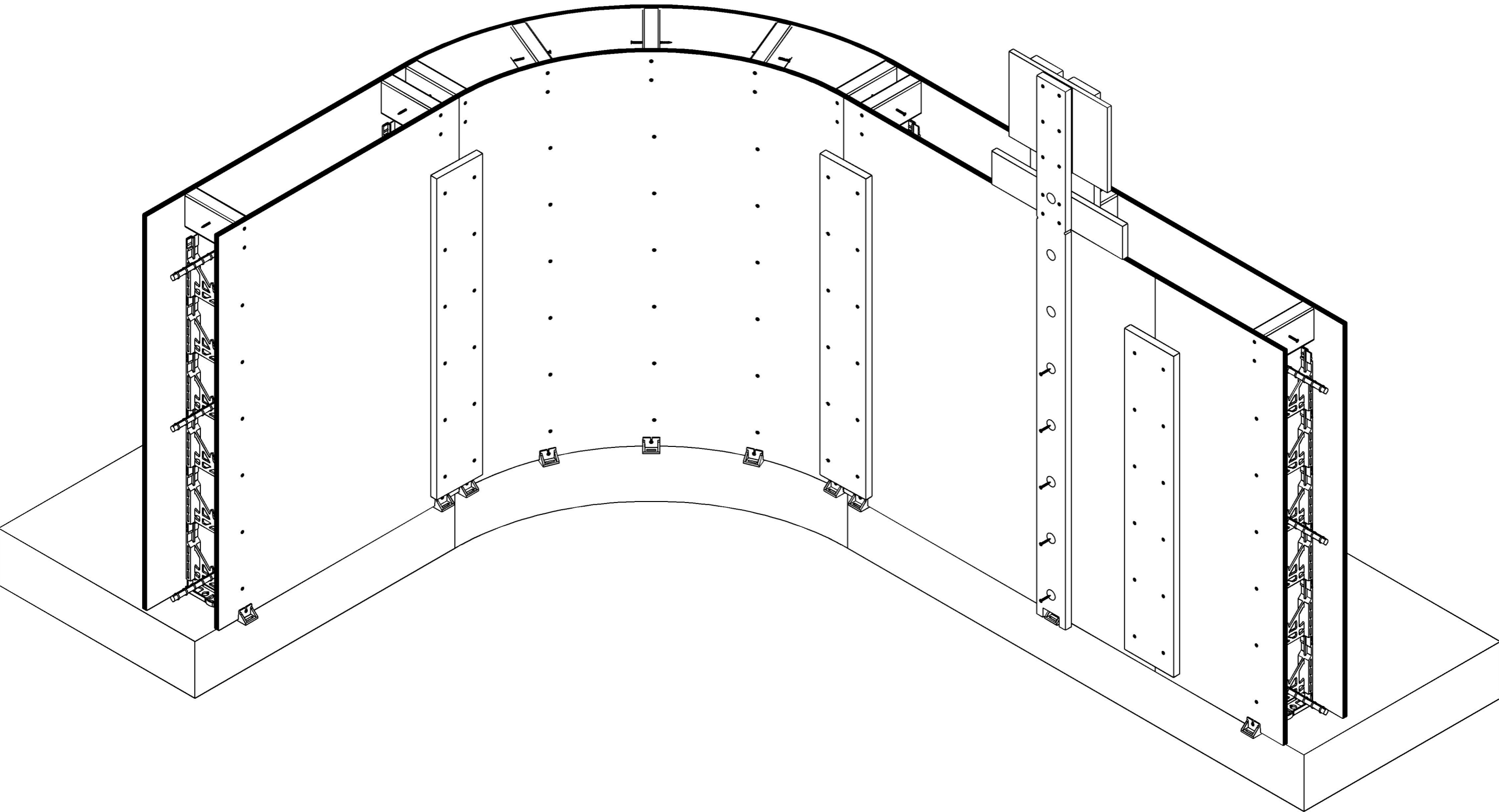

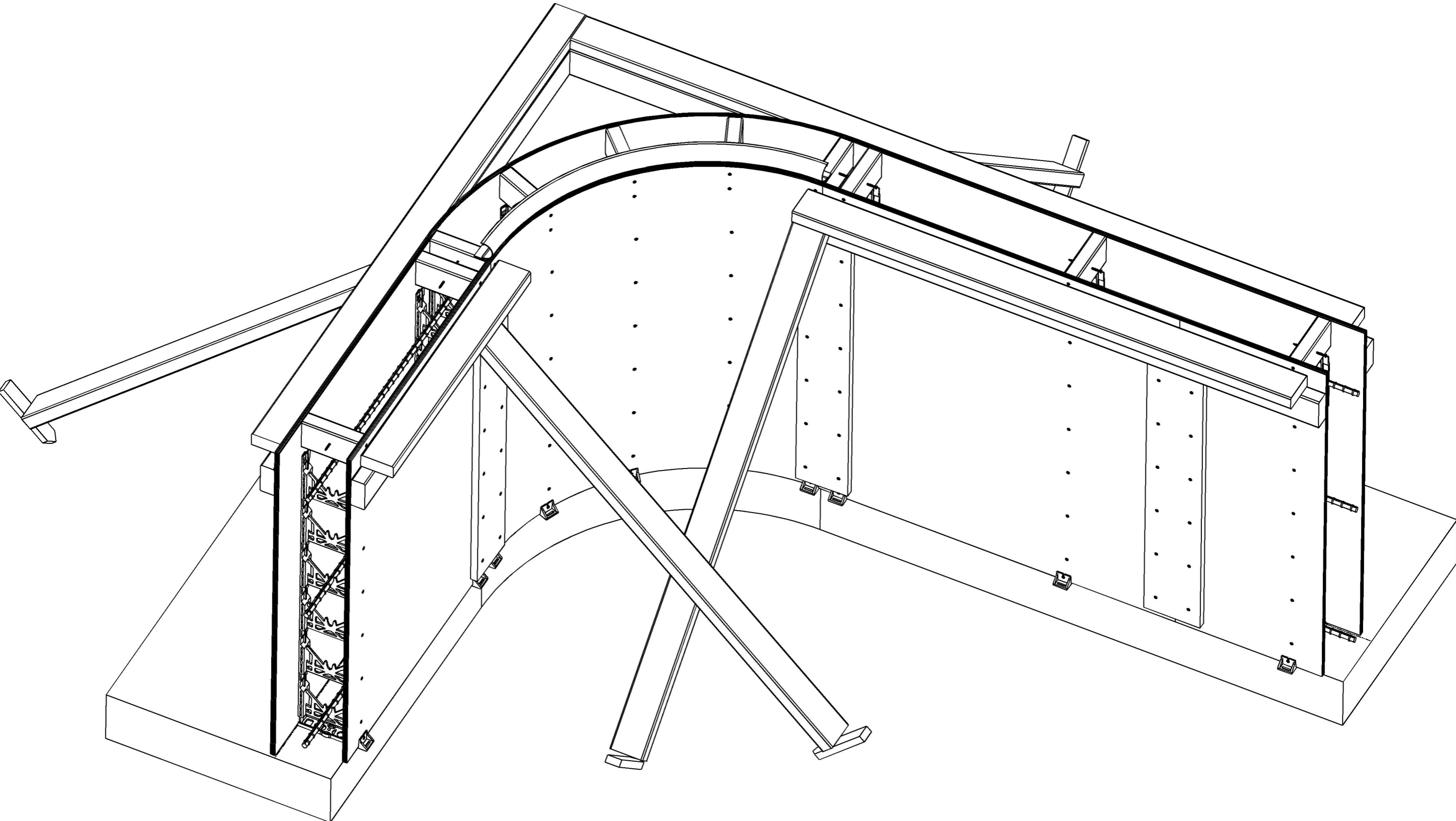

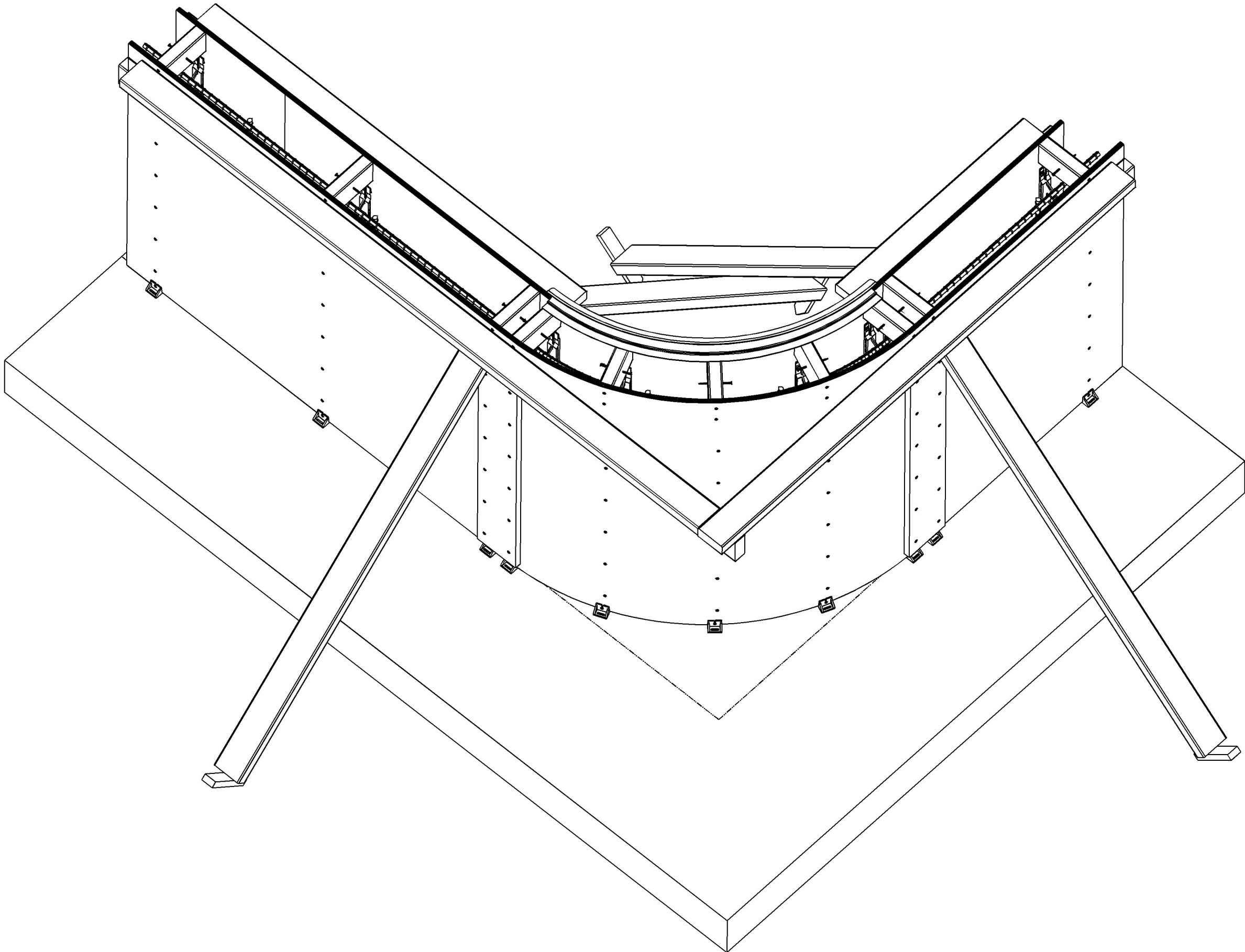

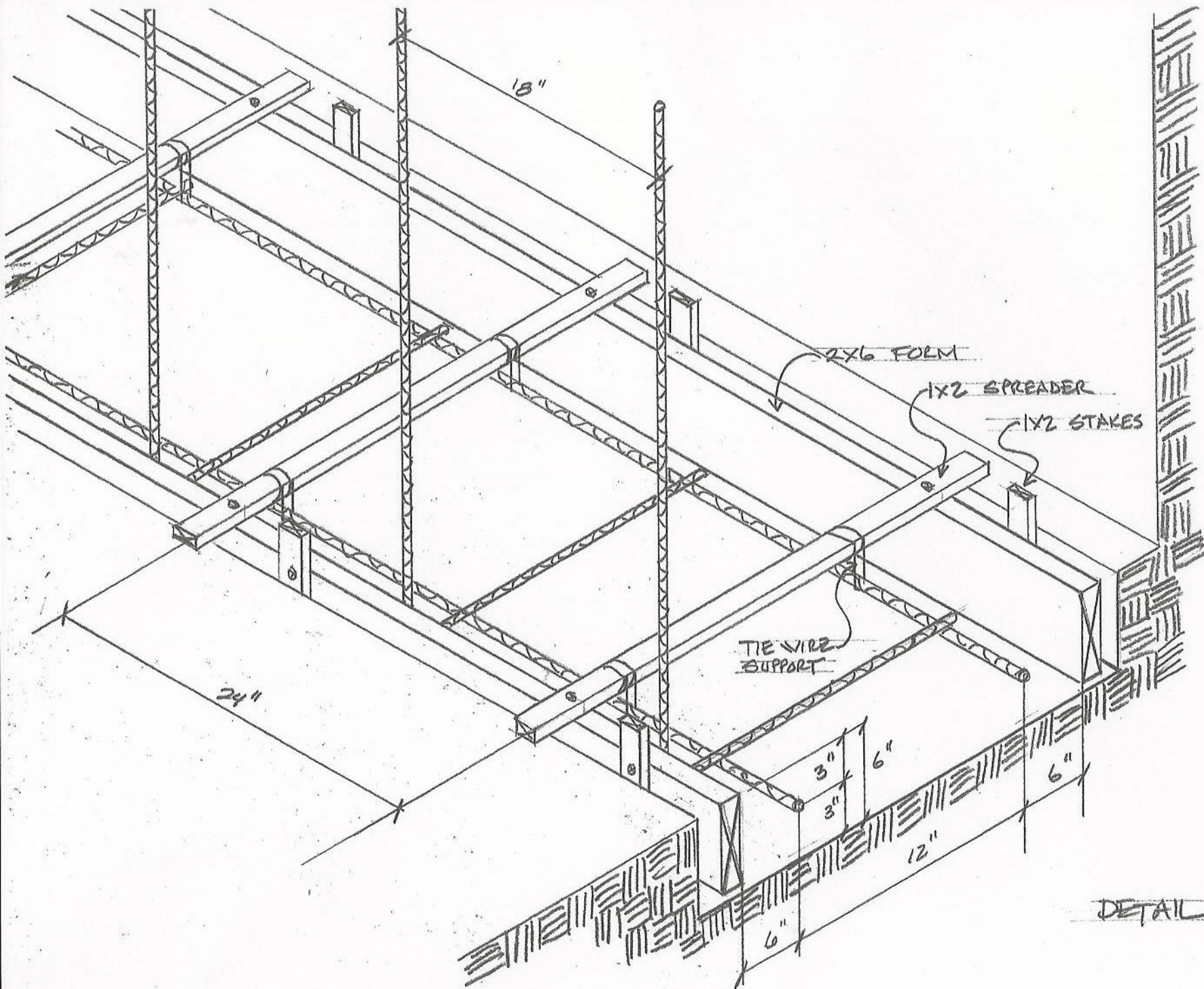

DETAIL 6 A

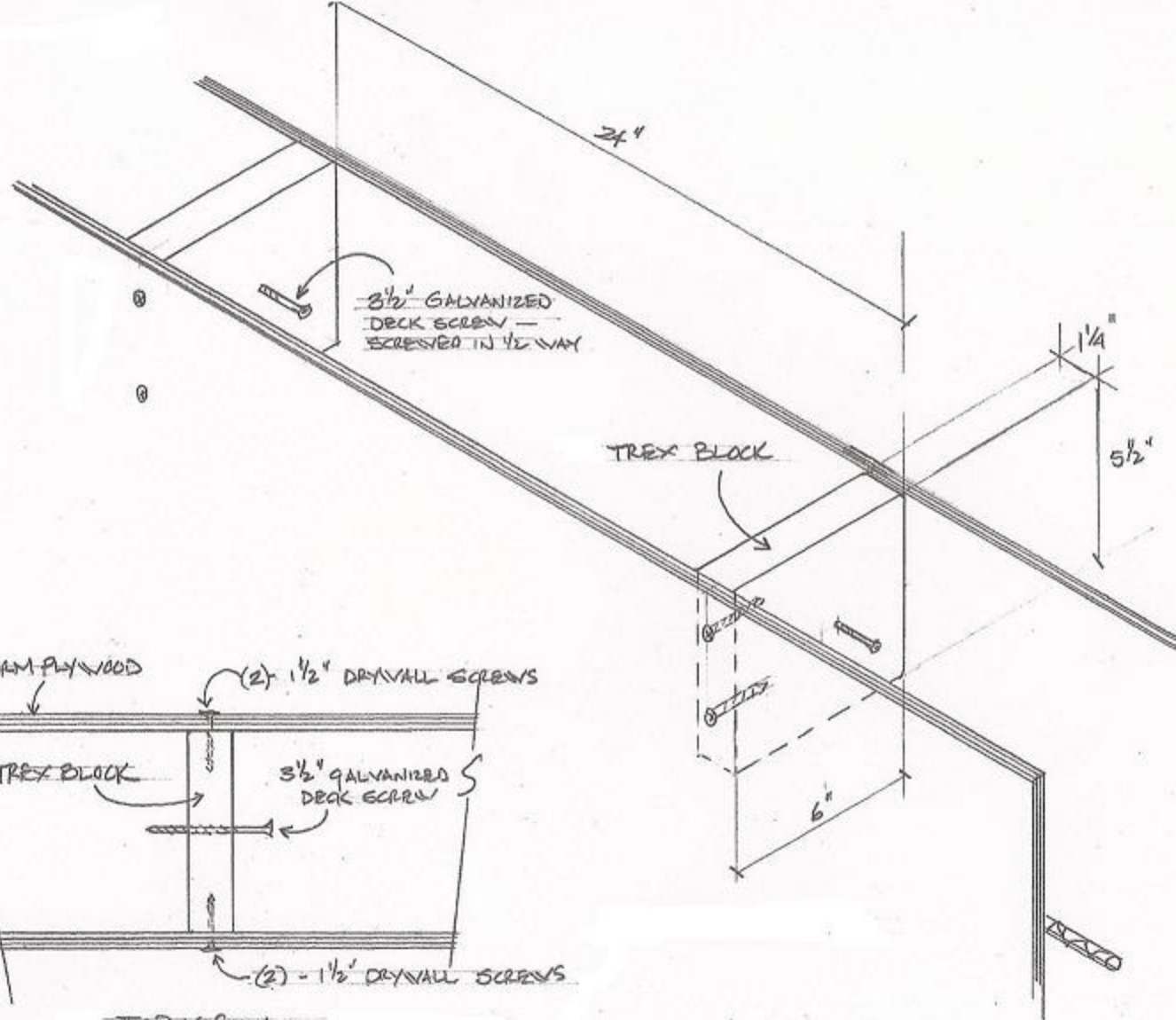

TOP VIEW

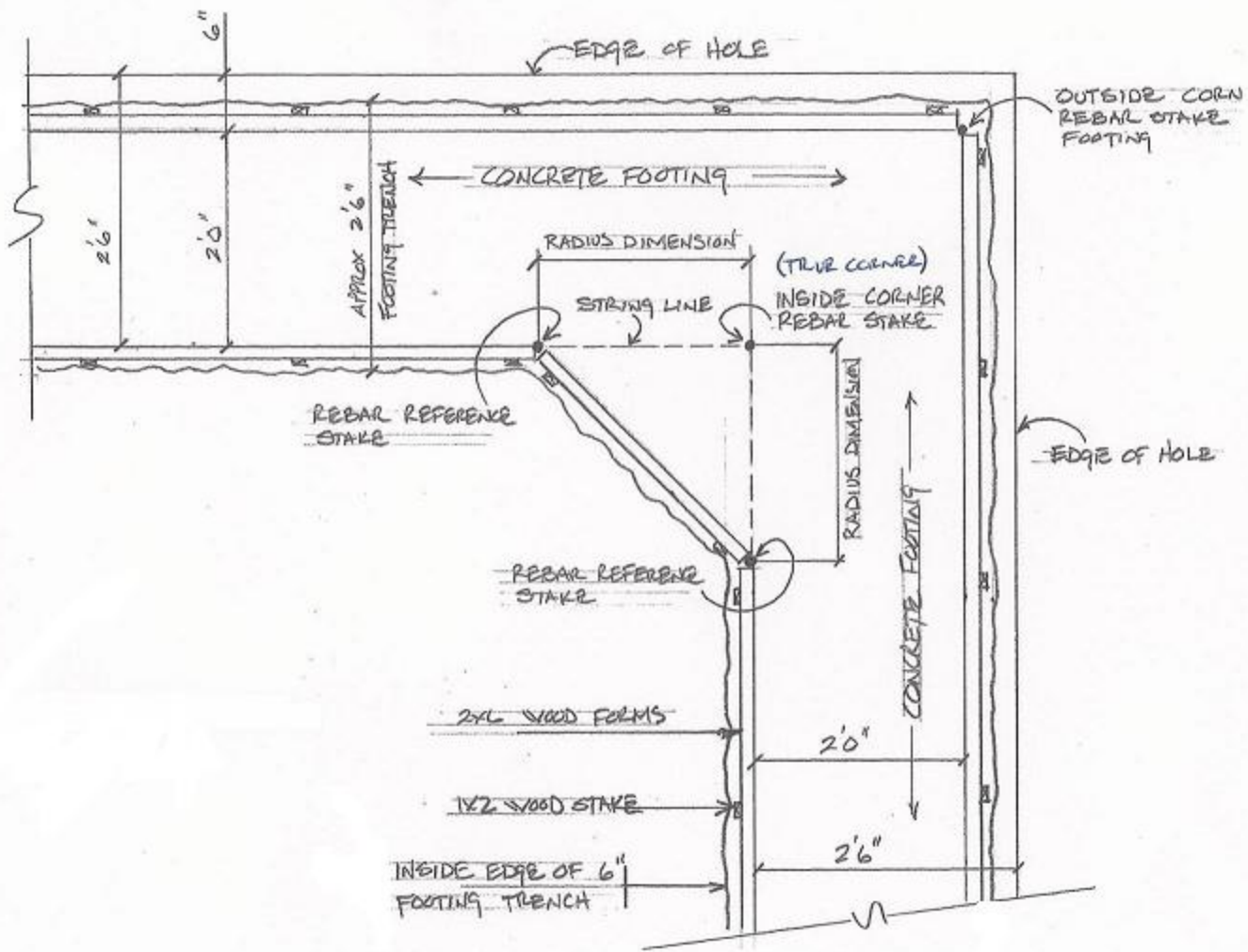

EDGE OF HOLE

EDGE OF HOLE

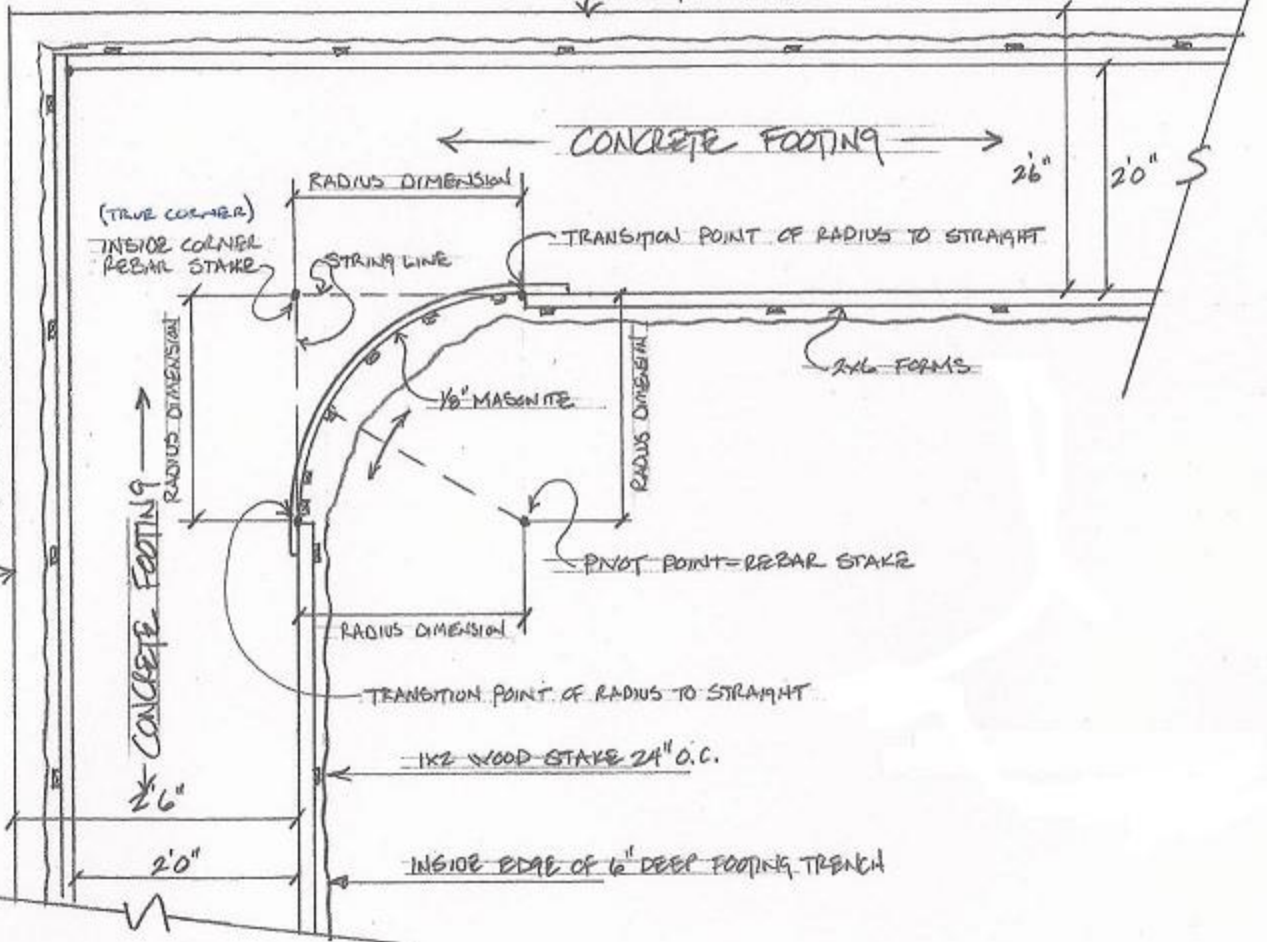

(TRUE CORNER)
INSIDE CORNER
REBAR STAKE

RADIUS DIMENSION

CONCRETE FOOTING

26"

20"

STRING LINE

TRANSITION POINT OF RADIUS TO STRAIGHT

2x6 FORMS

CONCRETE FOOTING

RADIUS DIMENSION

RADIUS DIMENSION

RADIUS DIMENSION

TRANSITION POINT OF RADIUS TO STRAIGHT

Pivot POINT = REBAR STAKE

1x2 WOOD STAKE 24" O.C.

26"

20"

INSIDE EDGE OF 6" DEEP FOOTING TRENCH

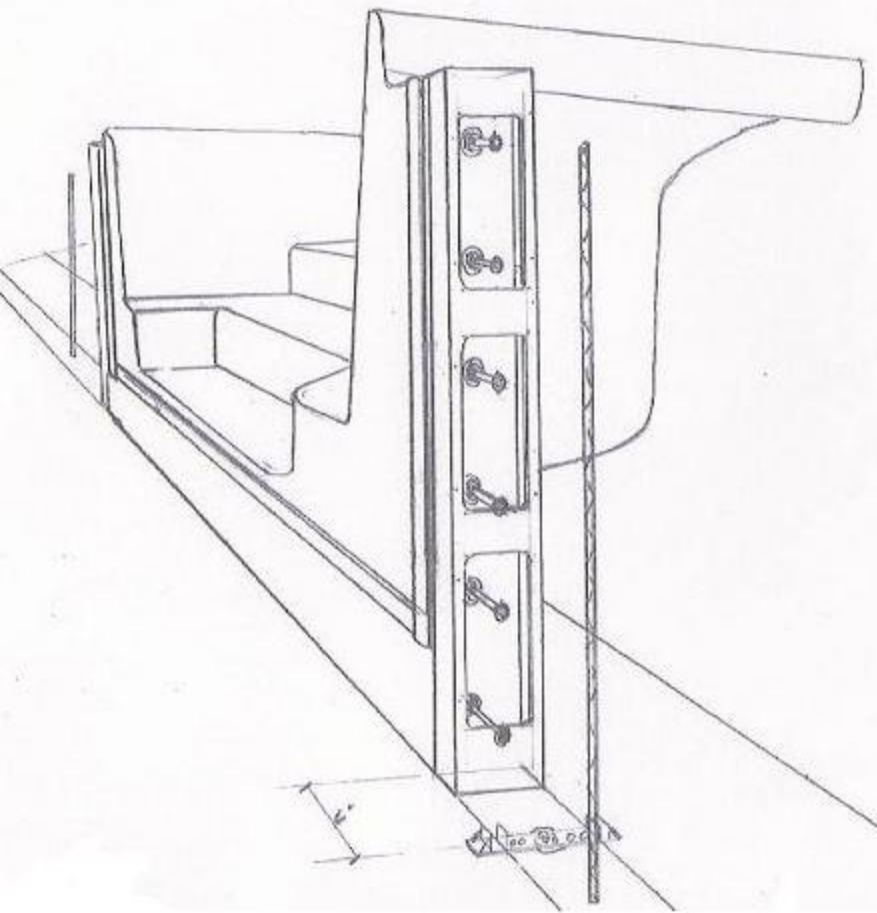

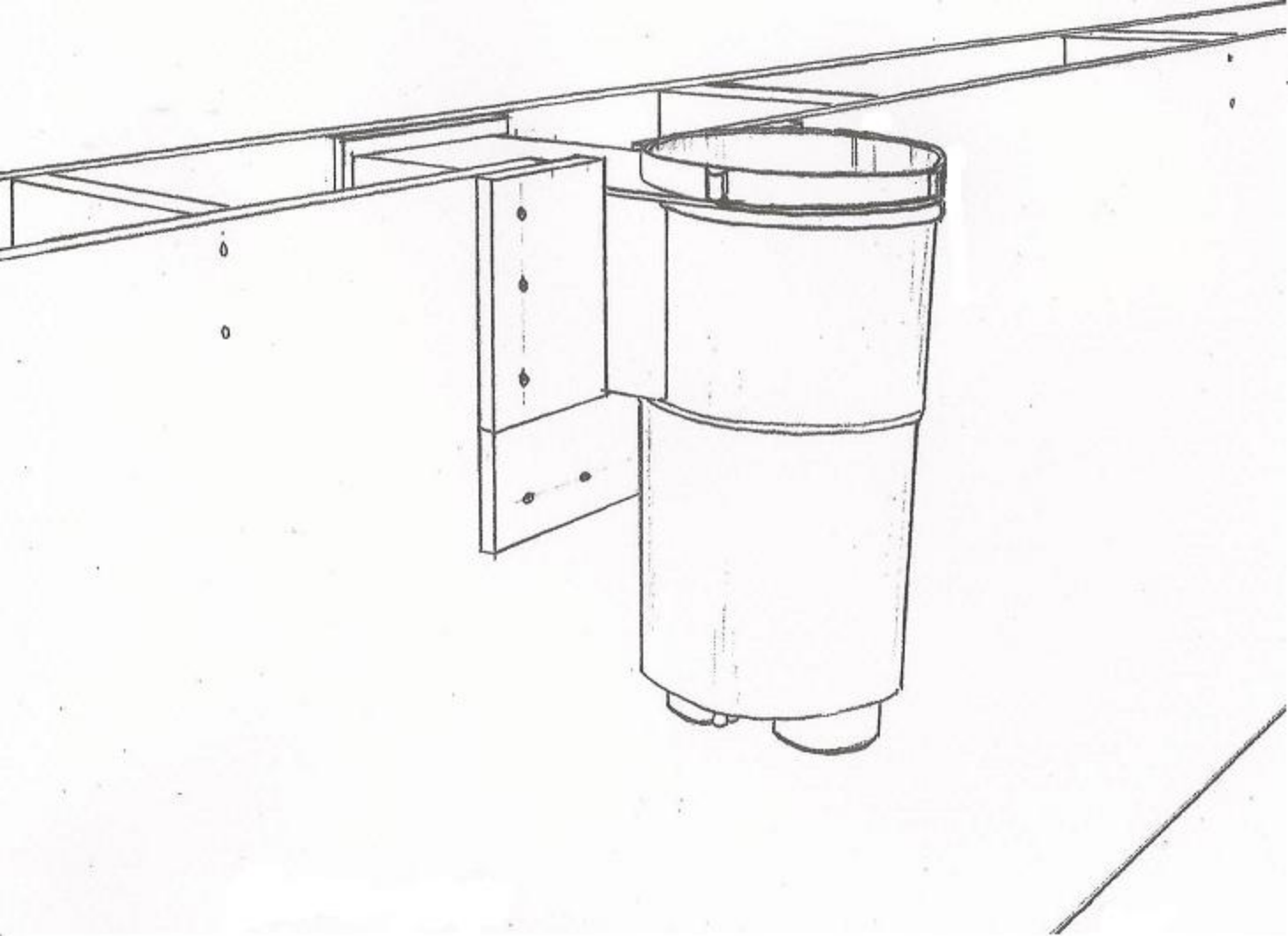

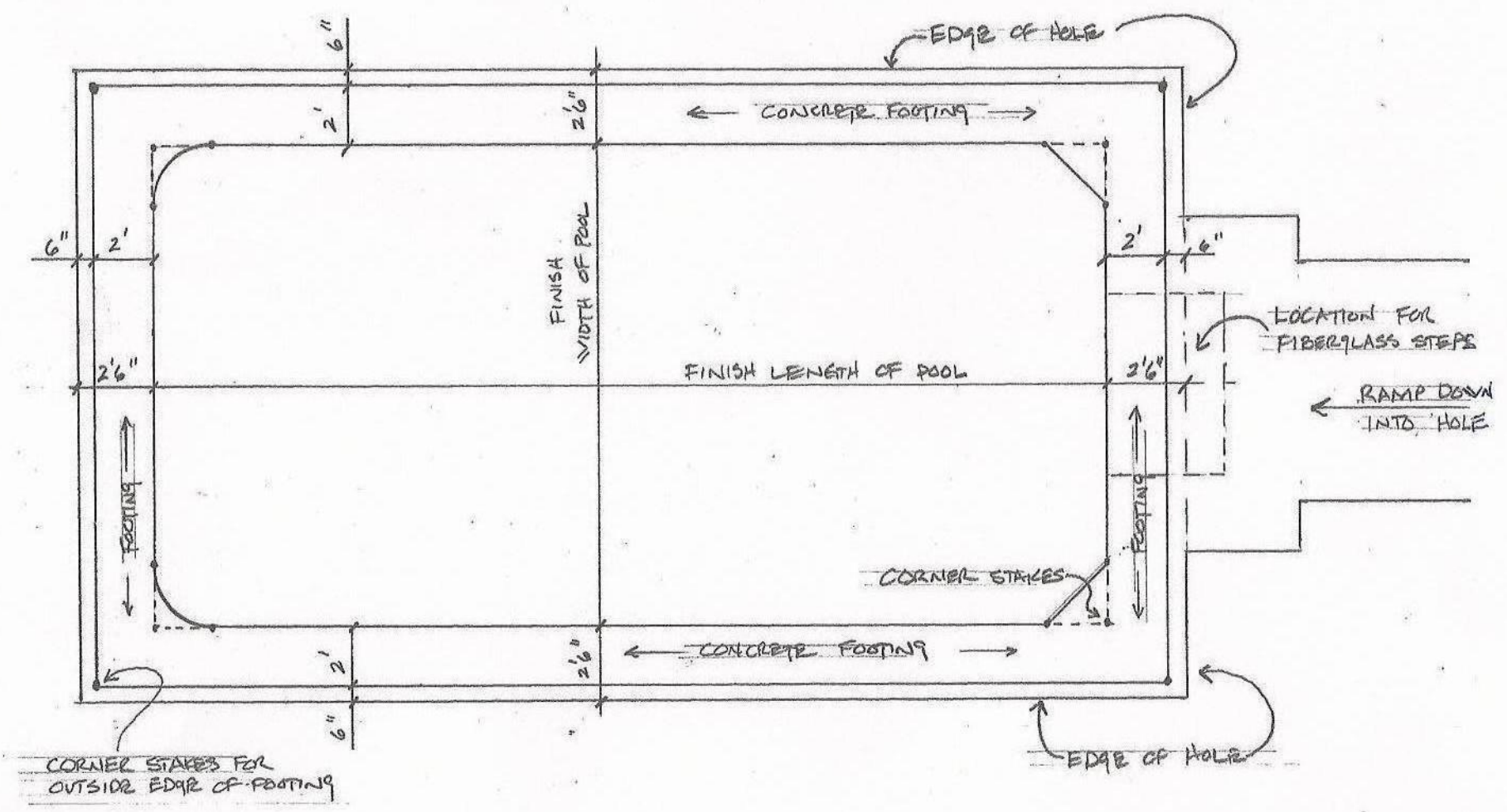

DETAIL 4 A

