

# Tri-County SUPER HEAT ASHRAE

American Society of Heating, Refrigeration, and Air-Conditioning Engineers

## IN THIS ISSUE...

ASHRAE's Core Values	1
Local Businesses	2
Leadership	3
CRC 2018	4
Upcoming Meeting	6
Local Events	7
Partial Roster	8



Making Energy Efficiency a Reality

## MEETING INFORMATION

**Date:** September 18, 2018

**Location:** Claim Jumper  
Restaurant, Corona

**Dinner:** 6:30-8:30

**Member Cost:** \$45

**Non-Member Cost:** \$50

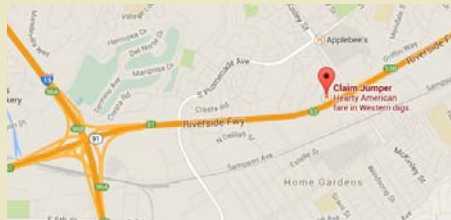

We look forward to seeing you again at our next meeting. Claim Jumper Restaurant is located on 380 McKinley Street in Corona, near the 15 and 91 freeway interchange. Please e-mail Ryan Rodriguez at [ashraetricounty@gmail.com](mailto:ashraetricounty@gmail.com) to reserve your spot for the upcoming meeting.

Claim Jumper Restaurant  
380 McKinley Street, Corona

## ASHRAE'S CORE VALUES

As we begin our 2018-2019 Tri-County ASHRAE season, let's take a moment to review ASHRAE's core values...

### **Excellence**

ASHRAE education, technical information and all other activities and products will always reflect the best practices that lead our industry. We strive for continuous improvement and innovation in all our practices and products.

### **Commitment**

ASHRAE and its members are passionate about serving the built environment, creating value, and recognizing the accomplishments of others.

### **Integrity**

ASHRAE is committed to the highest ethical standards. We work transparently, observing essential requirements for due process and peer reviews to assure our members and stakeholders that we do the right things the right way.

### **Collaboration**

ASHRAE seeks and embraces collaborative efforts with organizations, agencies, and individuals sharing our commitment to sustainable built environments.

### **Volunteerism**

Members lead ASHRAE at every level, serving ASHRAE and helping ASHRAE serve society.

NOTE: Statements made in this publication are not the expressions of the Society or of the Tri-County chapter but may not be reproduced without special permission of the Tri-County chapter.

PLEASE SUPPORT OUR  
BUSINESS CARD  
ADVERTISERS LOCATED  
HERE AND ELSEWHERE IN  
THIS PUBLICATION...

**MAKE AN INVESTMENT  
IN OUR INDUSTRY'S  
FUTURE!**

If you would like to place a  
business card ad in Super  
Heat for the 2018-2019  
Tri-County ASHRAE season,  
please contact

Ryan Rodriguez via e-mail  
at...

[ashraetricounty@gmail.com](mailto:ashraetricounty@gmail.com)

*Looking for a unique marketing opportunity?*

*We've got a deal for you!*

*For only \$50 (that's right, only \$50!) you and  
many more can see your business card appear on  
THIS PAGE of THIS PUBLICATION*

*for the 2018-2019 Tri-County ASHRAE season!*

*Now that you're interested, send a \*.jpg version of  
your business card to [ashraetricounty@gmail.com](mailto:ashraetricounty@gmail.com)  
while sending a check for \$50 made out to  
Tri-County ASHRAE.*

*We will let you know where to send the check  
when you send your business card file to us at the  
above e-mail address.*

**RYAN RODRIGUEZ**

TCSH Editor

*Our ASHRAE Tri-County leaders for the 2018-2019 season!*

## OFFICERS

President: Kakeru Fujikawa / Goss Engineering Inc.

President Elect: Felix Monterroso / Willdan Energy Solutions

Secretary: Elyse Johnson / IMEG Corp.

Treasurer: Alvah Bickham / Goss Engineering Inc.

## BOARD OF GOVERNORS

Board Member: Chris Robles / DMG Corp.

Board Member: Ian Villazana / ACCO Engineered Systems

Board Member: Shaw Gentry / Goss Engineering Inc.



# CHAPTER REGIONAL CONFERENCE



## 2018 Region X Chapter Regional Conference (CRC)

The recent CRC for ASHRAE Region X took place on August 16-18, 2018 at the DoubleTree by Hilton Fresno Convention Center in California.













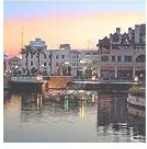

The San Joaquin Valley Chapter (SJV) hosted this year's event, welcoming members of Region X and local industry professionals for a weekend of Region & Chapter Business, Training, and fun. Below is a copy of the itinerary for those of you who were not able to attend or may be unfamiliar with what the CRC entails.

Region X CRC 2018 Event Schedule August 16-18, 2018				Intended Attendees						
				Society Staff	Regional Officers	Nominating	Delegates & Alternates	Committee Chairs	Chapter Officers	Companions / Guests
<b>Thursday 8/16/18</b>										
Time	Event	Location	Attire	Attendees						
12:30 PM - 2:30 PM	CRC Orientation and Motion Workshop	Salon D-3	Business Casual	*	*	*	*	*	*	*
12:00 PM - 5:00 PM	Hospitality Lounge / Historian Displays	Salon E	Business Casual	*	*	*	*	*	*	*
12:00 PM - 5:00 PM	Hospitality Room		Business Casual	*	*	*	*	*	*	*
2:30 PM - 4:00 PM	Technical Tour of Tioga Brewery	Dep: FRONT LOBBY	Business Casual			*				
4:00 PM - 5:00 PM	Leadership Workshop	Salon D-3	Business Casual	*	*	*	*	*	*	*
5:00 PM - 7:30 PM	Product Show & Welcome Reception	Salons A-1 & A-2	Business Casual	*	*	*	*	*	*	*
<b>Friday 8/17/18</b>										
Time	Event	Location	Attire	Attendees						
6:00 AM - 7:30 AM	Breakfast	Salon B	Business Casual	*	*	*	*	*	*	*
7:30 AM - 12:00 PM	Business Session 1	Salon C	Business Casual	*	*	*	*	*	*	*
10:00 AM - 12:00 PM	STEM Lego Competition	Salon A-1	Business Casual	*	*	*	*	*	*	*
12:00 PM - 1:30 PM	President's Lunch & PAOE Awards	Salon B	Business Casual	*	*	*	*	*	*	*
12:00 PM - 5:00 PM	Hospitality Lounge / Historian Displays	Salon E	Business Casual	*	*	*	*	*	*	*
12:00 PM - 5:00 PM	Hospitality Room		Business Casual	*	*	*	*	*	*	*
1:30 PM - 3:00 PM	Caucus 1	Salon D-1	Business Casual	*	*	*	*	*	*	*
3:00 PM - 5:30 PM	Business Session 2	Salon C	Business Casual	*	*	*	*	*	*	*
6:00 PM - 7:00 PM	Women in ASHRAE Happy Hour	Waterfall LOBBY / BAR	Western Rodeo	*	*	*	*	*	*	*
7:00 PM - 9:00 PM	Awards Dinner	Salon B	Western Rodeo	*	*	*	*	*	*	*
9:00 PM - 10:00 PM	YEA - Pub Quiz	Salon A-1	Western Rodeo	*	*	*	*	*	*	*
<b>Saturday 8/19/17</b>										
Time	Event	Location	Attire	Attendees						
6:00 AM - 7:30 AM	Breakfast	Salon B	Business Casual	*	*	*	*	*	*	*
6:00 AM - 7:30 PM	Executive Session	Salon D-1	Business Casual			*	*			
7:30 AM - 12:30 PM	CRC Workshops									
	7:30 AM - 9:00 AM	Historian	Salon D-1							
	7:30 AM - 10:00 AM	Membership	Salon D-2							
	7:30 AM - 10:30 AM	Student Activities	Salon D-3							
	7:30 AM - 10:30 AM	CTTC	Salon A-1							
	7:30 AM - 9:30 AM	ECC/Webmaster	Salon F	Business Casual	*		*	*	*	
	9:00 AM - 11:00 AM	Research Promotion	Salon D-1							
	10:30 AM - 12:00 PM	GAC	Salon A-1							
	11:00 AM - 12:30 PM	Treasurer	Salon D-1							
11:00 AM - 12:30 PM	YEA	Salon D-2								
11:00 AM - 12:30 PM	Student Branch	Salon D-3								
10:00 AM - 3:00 PM	Touchdown Lounge / Historian Displays	Salon E	Business Casual	*	*	*	*	*	*	*
12:00 PM - 1:00 PM	Lunch	Pick-up in Salon B; return to Workshops	Business Casual	*	*	*	*	*	*	*
1:00 PM - 3:00 PM	Chapter Operations	Salon C	Business Casual	*	*	*	*	*	*	*
3:30 PM - 4:30 PM	Debrief	TBD	Business Casual	*	*	*				

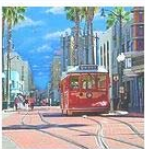

# CHAPTER REGIONAL CONFERENCE

**A reminder of the fourteen chapters and one section, which make up our Region and banded together for this year's event:**

	<b>Central Arizona</b> <i>Phoenix, AZ</i> Chapter #086 Chartered 1953		<b>Redwood Empire</b> <i>Napa, CA</i> Section of Golden Gate Chartered 1988		<b>Sierra Delta</b> <i>Stockton, CA</i> Chapter #144 Chartered 1984
	<b>Golden Gate</b> <i>San Francisco, CA</i> Chapter #082 Chartered 1937		<b>Sacramento Valley</b> <i>Sacramento, CA</i> Chapter #081 Chartered 1952		<b>Southern California</b> <i>Los Angeles, CA</i> Chapter #084 Chartered 1930
	<b>Hawaii</b> <i>Honolulu, HI</i> Chapter #108 Chartered 1969		<b>San Diego</b> <i>San Diego, CA</i> Chapter #085 Chartered 1959		<b>Southern Nevada</b> <i>Las Vegas, NV</i> Chapter #092 Chartered 1962
	<b>Northern Nevada</b> <i>Reno, NV</i> Chapter #126 Chartered 1975		<b>San Joaquin</b> <i>Fresno, CA</i> Chapter #083 Chartered 1955		<b>Tri County</b> <i>Redlands, CA</i> Chapter #155 Chartered 1988
	<b>Orange Empire</b> <i>Anaheim, CA</i> Chapter #105 Chartered 1968		<b>San Jose</b> <i>San Jose, CA</i> Chapter #101 Chartered 1965		<b>Tucson</b> <i>Tucson, AZ</i> Chapter #087 Chartered 1959

# UPCOMING MEETING

## PRESENTATION TOPIC

“A technical reference to VAV, CAV, VAD system concepts and general applications for various climate zones part I.” This presentation is brought to you by Thomas Podgurski, Group Director at Royal Service. The presentation includes several drawing samples to help illustrate the various system configurations and thought process involved for each, with discussion around control strategies and plenty of opportunity to dive into the technical details behind each of the system types listed below:

- VAV- Variable air volume
- CAV- Constant air volume Valves. Mechanical and electrical
- VAD- Variable air volume diffusers.

## MEETING PREVIEW

A sample of what's to come in this month's presentation (content borrowed from Royal Service):

### AHU1 System

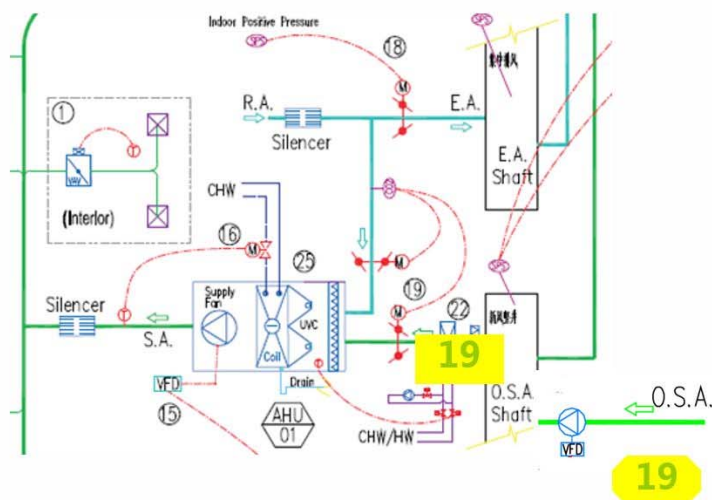

**ASHRAE CO<sub>2</sub> recommendation Set-point 600ppm less then OSA PPM.**

**19, IAQ Fresh Air Volume Control:**  
**CO<sub>2</sub> Sensor+ Fresh Air/Return Air Volume Damper or exhaust fan Control**  
**CO<sub>2</sub> required setting from ASHRAE is 600PPM less Outside PPM AVG**  
**CO<sub>2</sub> overrides all other control demand Normal setting (500-1000PPM)**

# LOCAL EVENTS

## Net Zero 2018 Conference: Net Zero For All

Hosted by Verdical Group  
September 12 - 14, 2018  
Los Angeles, CA

Net Zero 2018 is the nation's largest net zero building conference and the hub for thought-leaders and industry-shapers in the Energy, Water, Waste, and Transit sectors. Net Zero 2018 will bring 900+ green building pioneers from across the United States and around the world to Southern California to inspire, educate, and ultimately evolve our built environment into the net zero future that's fast approaching. The three day event offers up to 19 CEUs for AIA, GBCI, and LFA credential holders, and includes 9 technical workshops provided by the most influential organizations in the industry, over 75+ world-class education sessions with case studies and seasoned speakers, an expo hall with 75+ exhibitor tables, and premium networking opportunities that include the Robin Hood Benefit Gala and an Evening Reception.

The International Living Future Institute (ILFI) and U.S. Green Building Council (USGBC) serve as the conference's program partners and confirmed keynote speakers include Mahesh Ramana-jam (President & CEO, USGBC) and Kevin Payne (CEO, Southern California Edison). This year, NZ18 is an official affiliate event of the Global Climate Action Summit and our focus is Net Zero For All; we're reserving a pool of free, need-based tickets for disadvantaged communities, students, and others to ensure equity and diversity are a priority in the net zero conversation. Complimentary tours of our revolutionary net zero venue will be provided.

Sept. 12 - 14  
L.A.

# NZ18

**Net Zero 2018 Conference: Net Zero For All**  
**ENERGY + WATER + WASTE + TRANSIT**  
THE NATION'S LARGEST NET ZERO BUILDING CONFERENCE

Register  
Sponsor

Sponsored By

SOUTHERN CALIFORNIA EDISON  
An EDISON INTERNATIONAL® Company

IBEW & NECA  
LOCAL 11 LOS ANGELES

SDGE  
A Sempra Energy unit

LA DWP  
Los Angeles Department of Water & Power

SoCalGas  
A Sempra Energy unit

OLUTRON Hathaway Dinwiddie SKANSKA Pankow KRAVITZ INSULATION Metro

BDC OurSource UNITED FARMBOX Antellimeter P25 POWERMATHS

WEBCOR BERKARDER MITSUBISHI ELECTRIC TURNER HILTI

VCA MEL Temu Schneider MILLER HALL hempitecture

UBER CURET ALIASF

Workshops by: URS nbl

VG Verdical Group [www.NetZeroConference.com](http://www.NetZeroConference.com)



# 2018-2019 PARTIAL ROSTER



## Officers

<b>President</b>	<b>Kakeru Fujikawa</b> Goss Engineering, Inc. — 714-310-8126
<b>President-Elect</b>	<b>Felix Monterroso</b> Willdan Energy Solutions — 626.629.9658
<b>Secretary</b>	<b>Elyse Johnson</b> IMEG Corp. — 909-942-5522
<b>Treasurer</b>	<b>Alvah Bickham</b> Goss Engineering, Inc. — 442-242-8522

## Board of Governors

<b>Chris Robles</b> DMG Corp.— 562-692-1277
<b>Shaw Gentry</b> Goss Engineering, Inc. — 951-233-1827
<b>Ian Villazana</b> ACCO Engineered Systems — 714-287-8325

## Committee Chairs

<b>Historian</b>	<b>Jim Toda</b> Custom Cooling Company — 909-599-9222
<b>Student Activities</b>	<b>Jim Toda</b> Custom Cooling Company — 909-599-9222
<b>Research Promotion</b>	<b>Joe Sanders</b> Dynamic Engineered Systems, Inc — 951-278-0282
<b>Newsletter Editor</b>	<b>Ryan Rodriguez</b> Engie Services — 626-808-2072
<b>Membership Promotion</b>	<b>Vacant</b> Contact one of our officers to inquire about this position
<b>Young Engineers in ASHRAE (YEA)</b>	<b>Vacant</b> Contact one of our officers to inquire about this position
<b>Chapter Technology Transfer</b>	<b>Vacant</b> Contact one of our officers to inquire about this position



**Everyone in Tri-County is responsible for building a better tomorrow!**

# Tri-County SUPER HEAT

**CELEBRATING PLUS 29 YEARS 1989-2018 TRI-COUNTY ASHRAE!**

## P A S T P R E S I D E N T S

1988-1989	SUKHDEV MATHAUDHU	2014-2015	RYAN RODRIGUEZ
1989-1990	SUKHDEV MATHAUDHU	2015-2016	SHAW GENTRY
1990-1991	JEFF LEONARD	2016-2017	CHRIS ROBLES
1991-1992	DEL THOMAS	2017-2018	IAN VILLAZANA
1992-1993	TONY PIERCE		
1993-1994	GREG MORIN		
1994-1995	TONY HENKEL		
1995-1996	JOHN HAVILAND		
1996-1997	JOEL CARTER		
1997-1998	CHANDRA CHINDE		
1998-1999	JIM TODA		
1999-2000	RICHARD MCLEOD		
2000-2001	KERRY PARKER		
2001-2002	DEBRA CHAVIRA-SMITH		
2002-2003	LUCAS HYMAN		
2003-2004	JOE SANDERS		
2004-2005	BOB GASTEL		
2005-2006	ART ANDRES		
2006-2007	JIM PARKER		
2007-2008	KYLE LANDIS		
2008-2009	RICK CREED		
2009-2010	ROBERT MORSE		
2010-2011	TIM HALD		
2011-2012	JAIMELopez		
2012-2013	ERICK DELGADO		
2013-2014	NICOLAS ROSNER		

— journal of the tri-county chapter of the —

## American Society of Heating, Refrigerating, and Air Conditioning Engineers

ASHRAE, founded in 1894, is an international organization of 55,000 persons. Its sole objective is to advance through research, standards writing, publishing and continuing education the arts and sciences of heating, ventilation, air conditioning and refrigeration to serve the evolving needs of the public.