

F.Y.C Kiddy Ride Instruction Manual

FL-002 Classical Carrousel



Specification

Dimension Diameter 225cm H275cm

Weight 320kgs

Voltage 3 phase 220V AC, 60Hz, 50A

F.Y.C Kiddy Ride Instruction Manual

Classical Carrousel FRP Model Assembly

Classical Carrousel Detail Manual

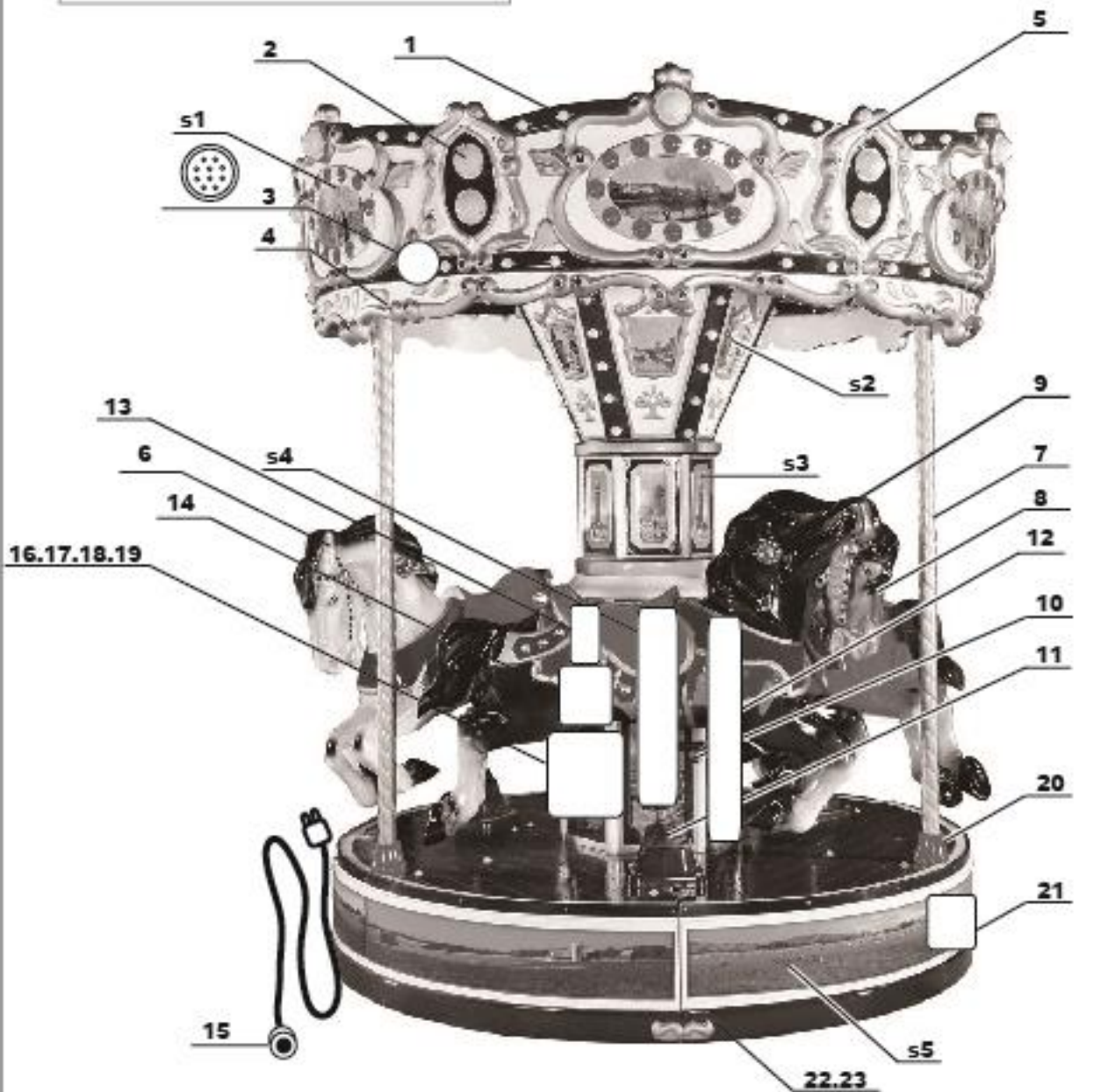

- | | | |
|--------------------------------|--|----------------|
| 1. Light#3 | 10. Pedal#1 | 19. Controller |
| 2. Light#2 | 11. Dust Cover | 20. Base FRP |
| 3. Speaker | 12. Maintenance door | 21. Motor |
| 4. Diamond#1 | 13. Mechanical coin machine(key#1) | 22. Fixer |
| 5. Classical Carrousel top FRP | 14. Coin box(key#2) | 23. Wheel |
| 6. White horse FRP | 15. Power-plug locates at rear of base | |
| 7. Pillar FRP | 16. Control door(key#1) | |
| 8. Black horse FRP | 17. Double frame | |
| 9. Handlebar#5 | 18. Music box | s1~s5. Sticker |

F.Y.C Kiddy Ride Instruction Manual

FC-P0026 Electronic Coin Machine

Electronic Coin Machine Operating Manual

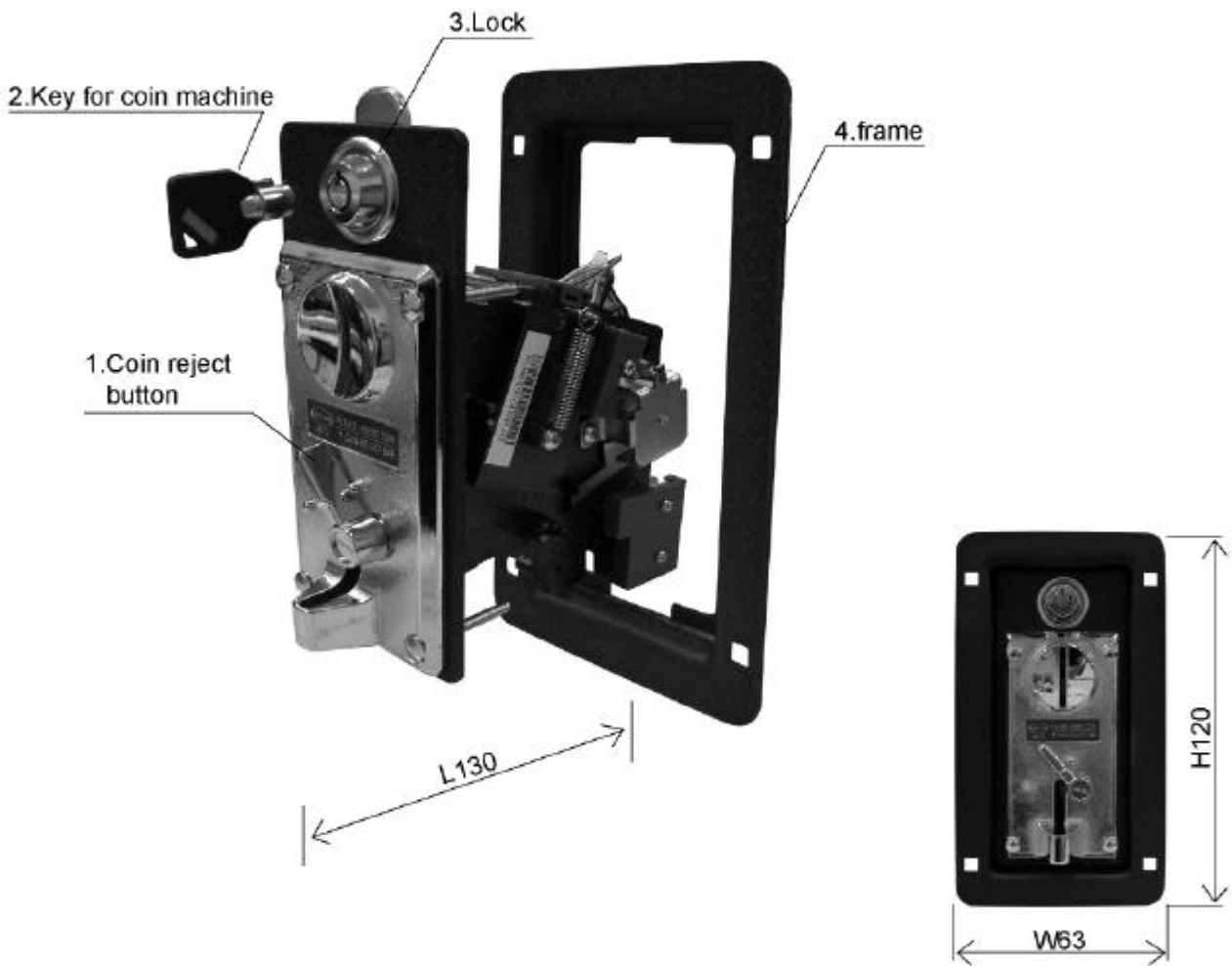

F.Y.C Kiddy Ride Instruction Manual

FC-P0026 Electronic Coin Machine

Electronic Coin Machine Operating Manual

DIDGITAL COMPARABLE ELECTRONIC INSTALLATION HI-07CS+LED

STEP1

Cheng the right coin for use from the clamp.

STEP2

Adjust the right insert size for use from the front panel back side.

STEP3

Select the right mode: Normal Open/ Normal Close* TIMER SWITCH* for synchronizing your system.
100ms (Slow Speed/ Long Pulse)
50ms (Medium Speed/ Medium Pulse)
30ms (Fast Speed/ Short Pulse)

STEP4

Adjust VR sensitivity tuning
Clockwise: slack selection (LED dark->light)
Anti-clockwise: strict selection (LED light->dark)

STEP5

Gray Line ○ Counter (+/-)
Red Line ○ DC+12V
White Line ○ Coin Signal
Black LINE ○ GND (Ground)
Gray Line ○ Counter (+/-)

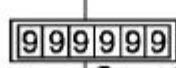

Counter

STEP6

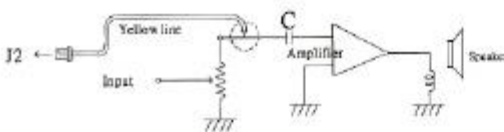

COIN SPECIFICATION
Diameter: 18mm~31mm
Thickness: 1.2mm - 3.0mm

USER EQUIPMENT
Voltage: DC 12V ±20%
Currents: 200mA

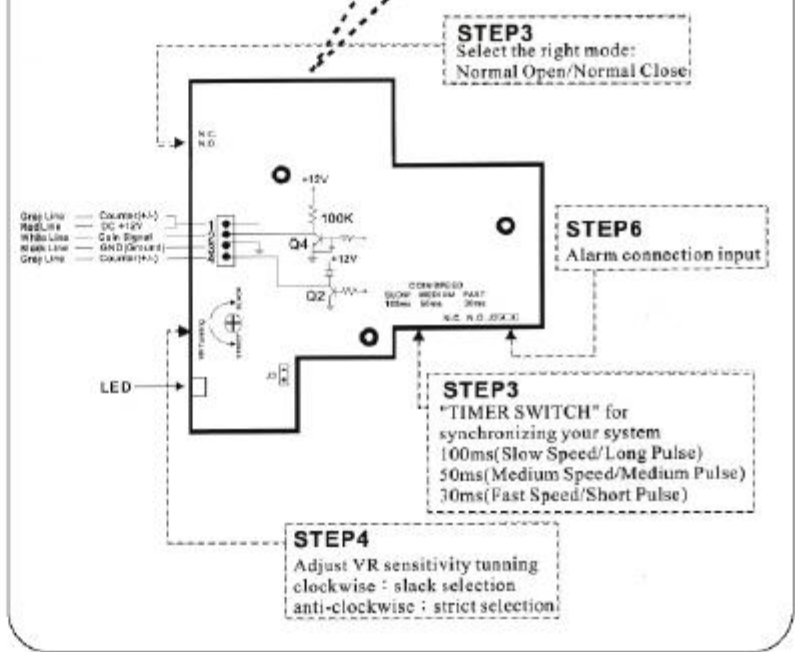
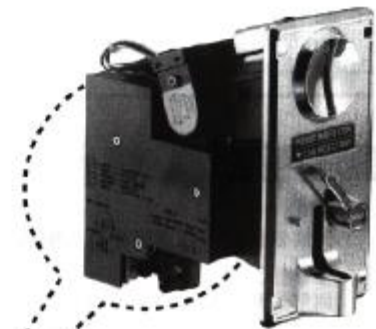

F.Y.C Kiddy Ride Instruction Manual

FC-P0007 Coin Box

Coin Box Manual

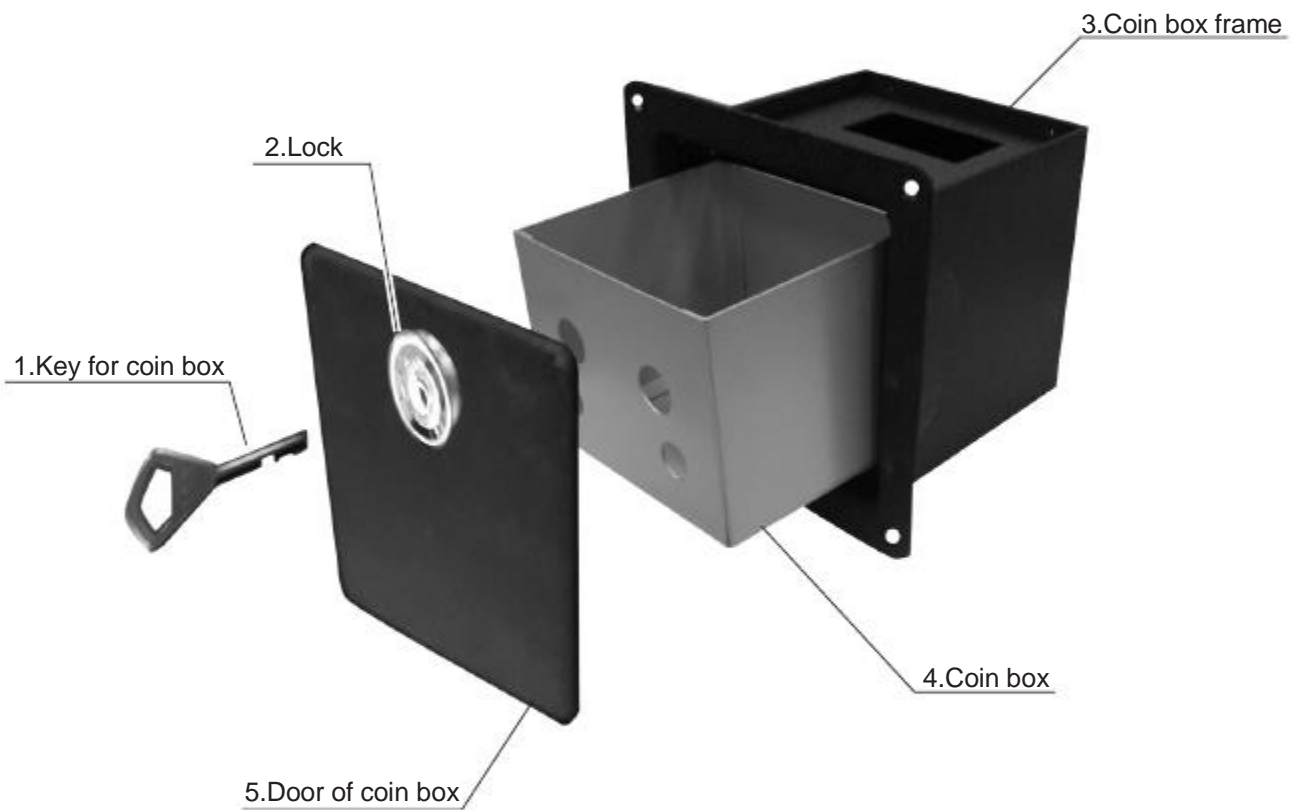

size: W175mm x L145mm x H175mm

OPERATION MANUAL - SILVER CONTROL & MUSIC BOX

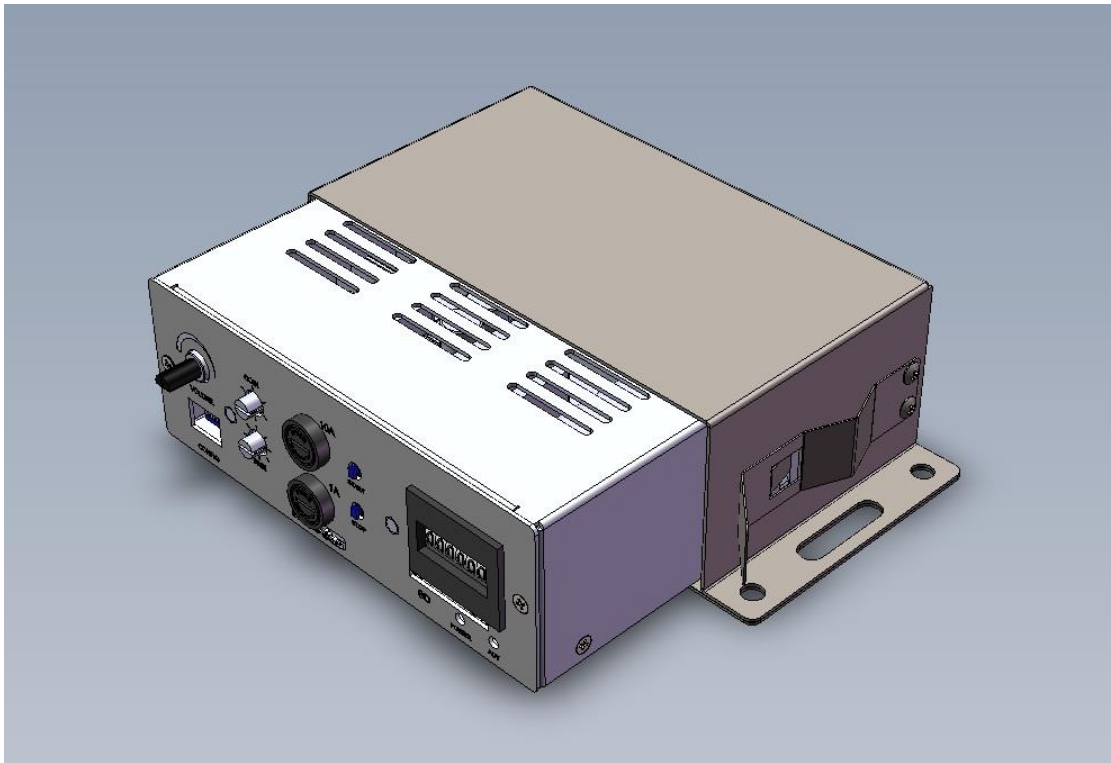

CONTENT

1. Function Introduction
2. Specification Introduction
3. Function Description :
 - Control Panel*
 - Connect Panel*
 - SD CARD Set Up Introduction*
 - Music Installation*
4. Attention
5. Rear Panel Pin Assignment

1. Function Introduction

The equipment is for Kiddy Ride machine only.

Function and feature:

1. 15W sound-stereo · and volume adjustment.
2. Set up the meter value by coin or play-time.
3. Multiple coins value set up for game-play.
4. Multiple times value set up for game-play.
5. AC Power 10A fuse · DC Power 5A fuse protection.
6. Use the mechanical-meter to count the coins or game-play.
7. The SD Card save music and may change the music by operator.
8. Power and Action led light directive for working.

2. Specification Introduction

MUSIC BOX

Specification	
AC input	AC 85V~265V 50/60Hz
AC output (motor)	AC110 / AC220V , 10A
DC12V output	4A (TOTAL)
Speaker	15W / 8Ω STERO
Music Storage	SD CARD (Up To 8G)
Music Format	MP3
AC Fuse	10A
DC Fuse	4 A
Weight	1.5 KG
Dimension	D:187mm x W:208mm x H:58mm

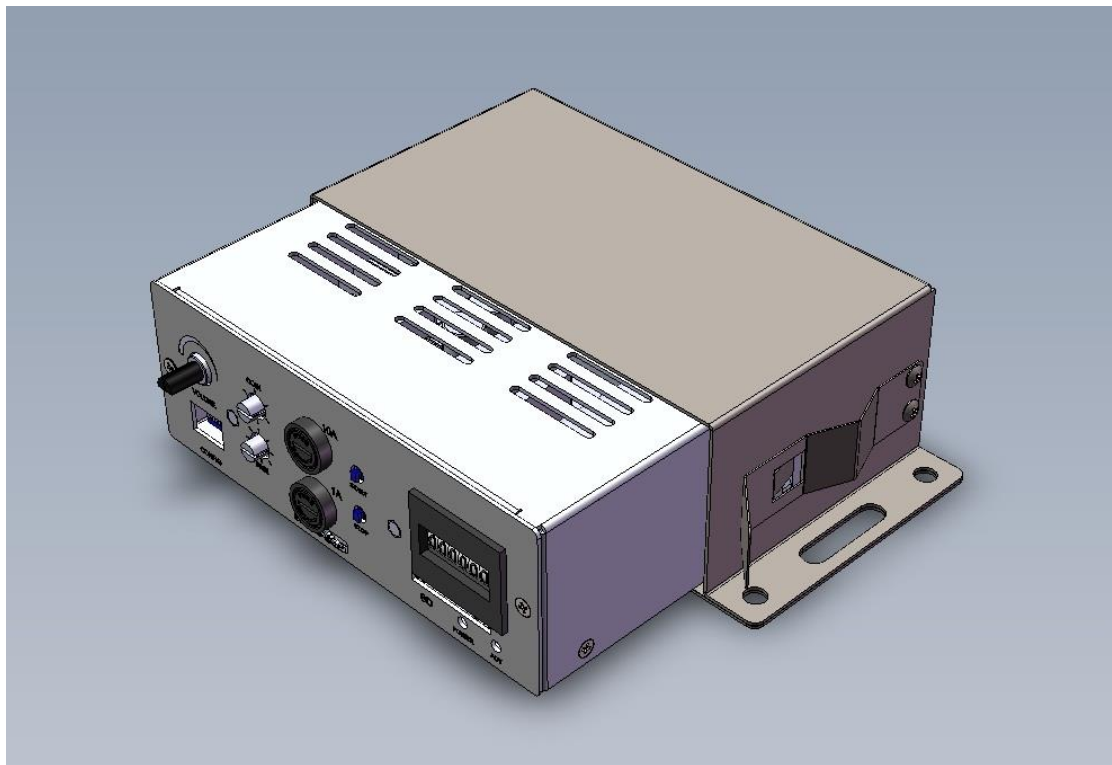

Main Unit

Specification

Dimension D : 170mm x W : 168mm x H : 54mm



Connect Unit

Specification

Dimension D : 90mm x W : 208mm x H : 58mm

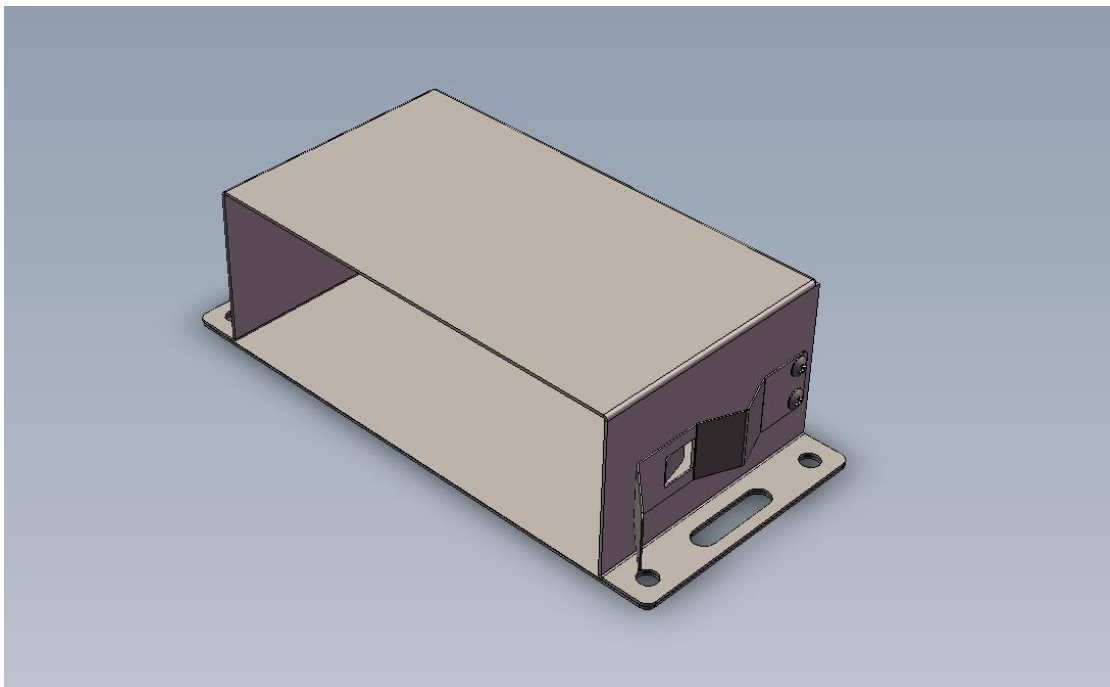

3. Function Description :

Control Panel

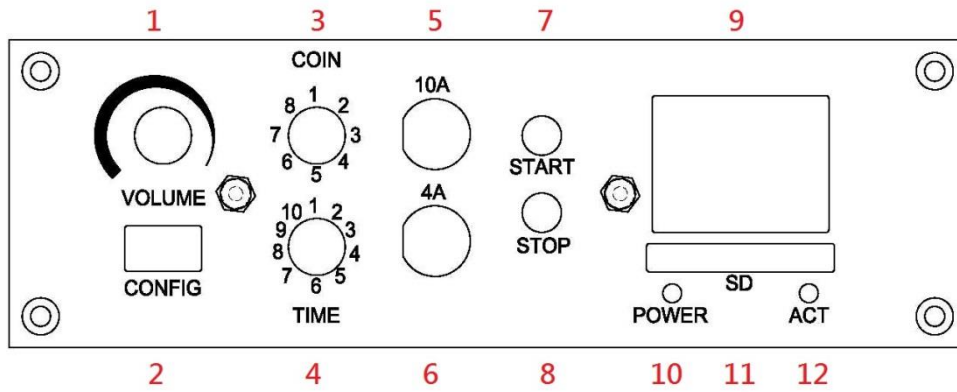

1.	VOLUME	volume adjustment																																																																		
2.	FUNCTION SETTING	<table border="1"> <thead> <tr> <th>1</th> <th>2</th> <th>3</th> <th>4</th> <th>5</th> <th></th> </tr> </thead> <tbody> <tr> <td>○</td> <td></td> <td></td> <td></td> <td></td> <td>Coin Start</td> </tr> <tr> <td>×</td> <td></td> <td></td> <td></td> <td></td> <td>Button Start</td> </tr> <tr> <td></td> <td>○</td> <td></td> <td></td> <td></td> <td>Coin Record</td> </tr> <tr> <td></td> <td>×</td> <td></td> <td></td> <td></td> <td>Coin Unrecorded</td> </tr> <tr> <td></td> <td></td> <td>×</td> <td></td> <td></td> <td>Coin Selector- NO</td> </tr> <tr> <td></td> <td></td> <td>○</td> <td></td> <td></td> <td>Coin Selector- NC</td> </tr> <tr> <td></td> <td></td> <td></td> <td>○</td> <td></td> <td>Testing Mode</td> </tr> <tr> <td></td> <td></td> <td></td> <td>×</td> <td></td> <td>Normal Mode</td> </tr> <tr> <td></td> <td></td> <td></td> <td></td> <td>○</td> <td>Coin Counter</td> </tr> <tr> <td></td> <td></td> <td></td> <td></td> <td>×</td> <td>Game-Play Counter</td> </tr> </tbody> </table> <p>Testing Mode : The cycle work 60 sec and then stop 60 sec. Normal Mode : The business mode. Coin Counter : The meter work for every coin. (1Coin 1 Play) Game-Play Counter : The meter work for every game-play.</p>	1	2	3	4	5		○					Coin Start	×					Button Start		○				Coin Record		×				Coin Unrecorded			×			Coin Selector- NO			○			Coin Selector- NC				○		Testing Mode				×		Normal Mode					○	Coin Counter					×	Game-Play Counter
1	2	3	4	5																																																																
○					Coin Start																																																															
×					Button Start																																																															
	○				Coin Record																																																															
	×				Coin Unrecorded																																																															
		×			Coin Selector- NO																																																															
		○			Coin Selector- NC																																																															
			○		Testing Mode																																																															
			×		Normal Mode																																																															
				○	Coin Counter																																																															
				×	Game-Play Counter																																																															
3.	COIN	Turn the knob to direct number and the function as follow :																																																																		

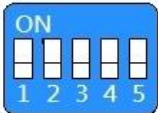

	SETTING	<table border="1"> <thead> <tr> <th>Position</th> <th>Function</th> </tr> </thead> <tbody> <tr> <td>1</td> <td>1Coin 1 Play</td> </tr> <tr> <td>2</td> <td>2 Coins 1 play</td> </tr> <tr> <td>3</td> <td>3 Coins 1 play</td> </tr> <tr> <td>4</td> <td>4 Coins 1 play</td> </tr> <tr> <td>5</td> <td>5 Coins 1 play</td> </tr> <tr> <td>6</td> <td>6 Coins 1 play</td> </tr> <tr> <td>7</td> <td>7 Coins 1 play</td> </tr> <tr> <td>8</td> <td>8 Coins 1 play</td> </tr> </tbody> </table>	Position	Function	1	1Coin 1 Play	2	2 Coins 1 play	3	3 Coins 1 play	4	4 Coins 1 play	5	5 Coins 1 play	6	6 Coins 1 play	7	7 Coins 1 play	8	8 Coins 1 play				
Position	Function																							
1	1Coin 1 Play																							
2	2 Coins 1 play																							
3	3 Coins 1 play																							
4	4 Coins 1 play																							
5	5 Coins 1 play																							
6	6 Coins 1 play																							
7	7 Coins 1 play																							
8	8 Coins 1 play																							
4.	TIME The Game-Play time setup.	<table border="1"> <thead> <tr> <th>Position</th> <th>Function</th> </tr> </thead> <tbody> <tr> <td>1</td> <td>The Game-Play time : 30 sec.</td> </tr> <tr> <td>2</td> <td>The Game-Play time : 60 sec.</td> </tr> <tr> <td>3</td> <td>The Game-Play time : 90 sec.</td> </tr> <tr> <td>4</td> <td>The Game-Play time : 120 sec.</td> </tr> <tr> <td>5</td> <td>The Game-Play time : 150 sec.</td> </tr> <tr> <td>6</td> <td>The Game-Play time : 180 sec.</td> </tr> <tr> <td>7</td> <td>The Game-Play time : 210 sec.</td> </tr> <tr> <td>8</td> <td>The Game-Play time : 240 sec.</td> </tr> <tr> <td>9</td> <td>The Game-Play time : 270 sec.</td> </tr> <tr> <td>10</td> <td>The Game-Play time : 300 sec.</td> </tr> </tbody> </table> <p>Turn the knob to direct number and the function as follow :</p>	Position	Function	1	The Game-Play time : 30 sec.	2	The Game-Play time : 60 sec.	3	The Game-Play time : 90 sec.	4	The Game-Play time : 120 sec.	5	The Game-Play time : 150 sec.	6	The Game-Play time : 180 sec.	7	The Game-Play time : 210 sec.	8	The Game-Play time : 240 sec.	9	The Game-Play time : 270 sec.	10	The Game-Play time : 300 sec.
Position	Function																							
1	The Game-Play time : 30 sec.																							
2	The Game-Play time : 60 sec.																							
3	The Game-Play time : 90 sec.																							
4	The Game-Play time : 120 sec.																							
5	The Game-Play time : 150 sec.																							
6	The Game-Play time : 180 sec.																							
7	The Game-Play time : 210 sec.																							
8	The Game-Play time : 240 sec.																							
9	The Game-Play time : 270 sec.																							
10	The Game-Play time : 300 sec.																							
5.	AC Fuse	10A																						
6.	DC Fuse	4 A																						
7.	START BUTTON	Press the button for game start.																						
8.	STOP BUTTON	Press the button for game stop.																						

9.	METER	The mechanical-meter to count the coins or game-play.
10	SD Card	For SD Card install and work.
11.	POWER	Power led light directive for working.
12.	ACT	ACT led light directive for working.

*****NOTE*****

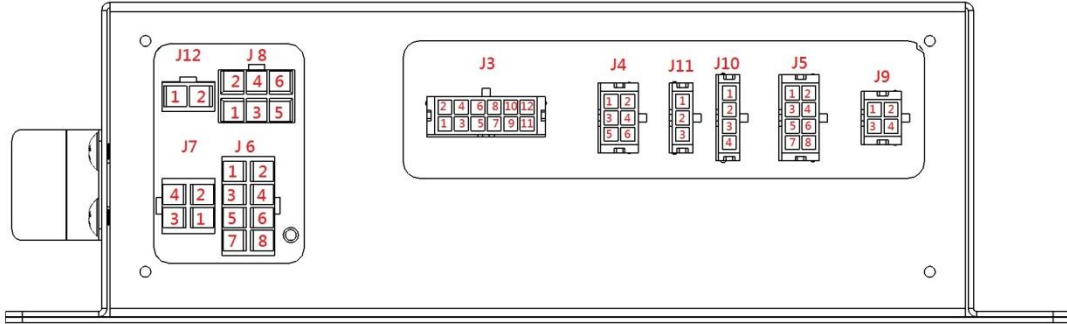

For each function change, the unit must reboot (power off/on) and the function is working.

Connect Panel

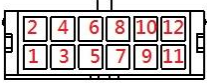
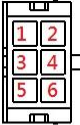

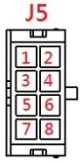
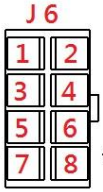
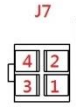
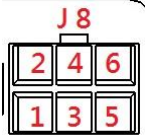
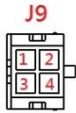
<p>J3 12-PIN LED LAMP</p> <p style="text-align: center;">J3</p>  <p>*NOTE 1</p>	1	GND	GND
	2	The game-playing and DC power output.	DC 12V
	3	GND	GND
	4	The game-playing and DC power output.	DC 12V
	5	GND	GND
	6	The game-playing and DC power output per 0.5 sec.	DC 12V
	7	GND	GND
	8	The game-playing and DC power output per 0.5 sec.	DC 12V
	9	GND	GND
	10	The unit power-on and DC power output.	DC 12V
	11	GND	GND
	12	The unit power-on and DC power output.	DC 12V
<p>J4 6-PIN COIN</p> <p style="text-align: center;">J4</p> 	1	Coin Power VCC	DC 12V
	2	Coin Power GND	GND
	3	Coin Signal	SIGNAL
	4	Start-Button light GND	GND
	5	enable VCC	DC 12V
	6	NO USE	NO USE
<p>J5 8-PIN EFFECT SWITCH</p>	1	Start-Button	SW-1-NO
	2	Start-Button	SW-1-COM

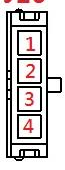
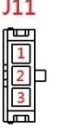
 <p>J5</p>	3	Effect-Button -1-	SW-2-NO
	4	Effect-Button -1-	SW-2-COM
	5	Effect-Button -2-	SW-3-NO
	6	Effect-Button -2-	SW-3-COM
	7	NO USE	NO USE
	8	NO USE	NO USE
<p>J6 8-PIN AC INPUT</p>  <p>J6</p>	1	AC INPUT GND	AC INPUT 85V~265V MAX 10A
	2	AC INPUT GND	
	3	AC INPUT L	
	4	AC INPUT N	
	5	AC INPUT L	
	6	AC INPUT N	
	7	AC INPUT L	
	8	AC INPUT N	
<p>J7 4-PIN AC OUTPUT</p>  <p>J7</p>	1	AC OUTPUT N	AC OUTPUT 85V~265V
	2	AC OUTPUT GND	
	3	AC OUTPUT L	
	4	AC OUTPUT GND	
<p>J8 6-PIN MOTOR AC POWER</p>  <p>J8</p>	1	MOTOR AC OUTPUT L	110V/220V MAX 10A
	2	MOTOR AC OUTPUT L	
	3	MOTOR AC OUTPUT N	
	4	MOTOR AC OUTPUT N	
	5	MOTOR AC OUTPUT GND	
	6	MOTOR AC OUTPUT GND	
<p>J9 4-PIN RS 232</p>  <p>J9</p>	1	RS232 COM	
	2	RS232 TX	
	3	RS232 COM	
	4	RS232 RX	
<p>J10 4-PIN SOUND</p>	1	SPEAKER R+	15W/8Ω
	2	SPEAKER R-	
	3	SPEAKER L-	
	4	SPEAKER L+	

<p>J10</p> 			
<p>J11 3-PIN LIMIT SWITCH</p> 	<p>1 2 3</p>	<p>+12v SIGNAL GND</p>	
<p>J12 2-PIN MOTOR AC LAMP</p> 	<p>1 2</p>	<p>MOTOR AC LAMP OUTPUT L MOTOR AC LAMP OUTPUT N</p>	<p>110V/220V</p>

***NOTE 1 : DC 12V power output maximum is 4A °**

SD CARD Set Up Introduction

Tools : Flathead screwdriver · SD CARD ·



Install :

Insert the SD CARD into the slot then use the flathead screwdriver to press it.

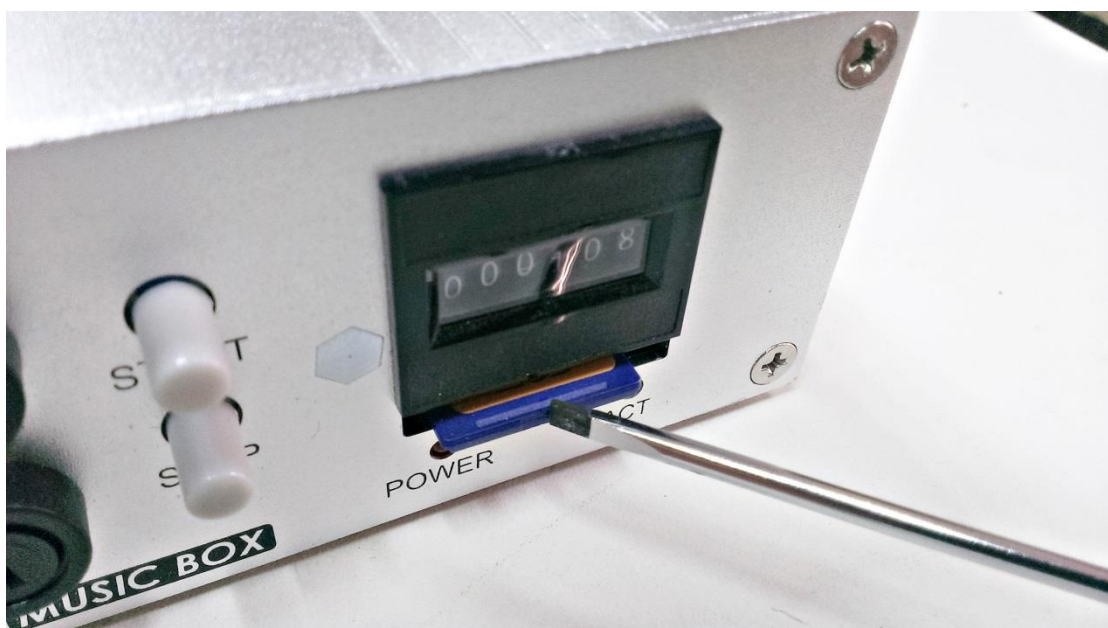

Press to bottom and the SD CARD stuck. The install finished.

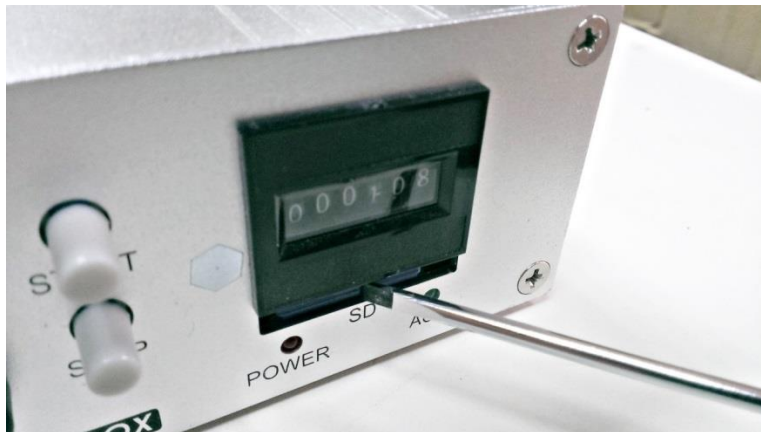

Uninstall

Use the flathead screwdriver to press the SD CARD to bottom. And the slot will release the SD CARD.

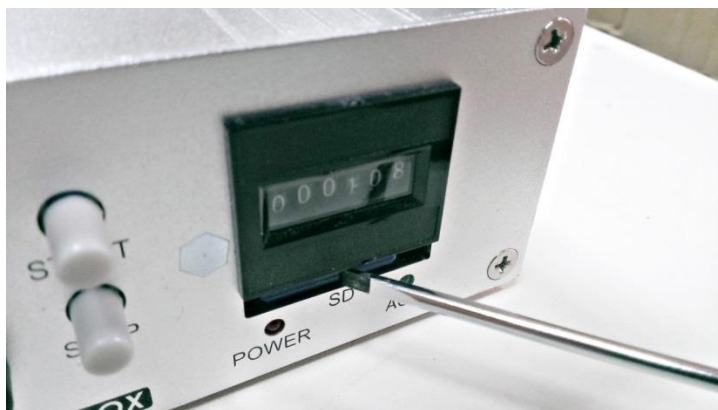

Remove the flathead screwdriver and the SD CARD eject. And then take out the SD CARD.



Music Installation

1. Set up the folders are named as below in the SD CARD.

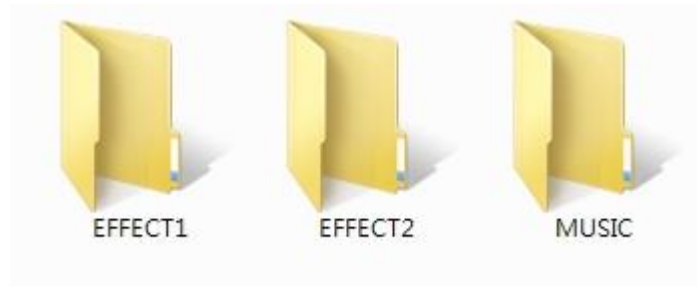

2. Saving music files to the folder as your require and file type is .mp3.
3. MUSIC : The game-play mode use and play by turns.

EFFECT1 : Press Effect-Button -1-, the mode use and play by turns.

EFFECT2 : Press Effect-Button -2-, the mode use and play by turns.

4. Attention

** The equipment for maintenance staff operate only.

** Power off to remove the Main Unit.

** Please follow the operation manual to operate the equipment.

Rear Panel Pin Assignment

