



Customizing Family Fun



SKU# BGFC-091

Fantasy Coffee Cups

Instruction Manual

Assembly, Operation, and Care Instructions

Serial #: _____

Distributed By: _____

Sales Person: _____

Technical Service #: _____

Inspect Immediately after Transporting the Product

After receiving the shipment, inspect the product thoroughly to ensure that it has been shipped with care. Before turning the power on, please check the following:

- Check the unit for any damage or shifting that may have occurred during shipping. Are there any dented portions or defects (cuts, etc.) on the external surfaces of the unit?
- Are all of the major operating pieces intact?
- Do the power supply voltage and frequency requirements meet with those of the location (110V/220V)?
- Are all wires linked correctly and securely connected to each other? If coupled in an incorrect manner, the connection will not be made accurately and it could cause not only irreparable damage to the machine, but also is a potential fire hazard. **DO NOT INSERT CONNECTORS FORCIBLY.**
- Check that the all the cables, including power cables, are undamaged. Do power cables or other wires have any splices, cuts, or dents?
- Have you been provided with all of the associated accessories?
- Can all doors/lids be opened with the accessory keys? Can doors/lids be firmly closed? Does the coin box key open the coin box(es)?



Safety Instructions



- This equipment may contain hazardous voltage which can cause electrical shock. Only **qualified personnel*** should work inside the equipment.
*Note: Keep reading for a list of qualified personnel.
- To maintain personal safety and the safe operation of this product, read the entire manual before using it. The following instructions are intended for the users, operators, and the personnel in charge of the operation of the machine. **Be sure to keep this manual close to the product or in a convenient place for future reference.**



IMPORTANT NOTICES

- This product is intended for indoor use only
- Do not approach or attempt to climb onto the ride while it is in use, as this could be hazardous.
- Adults should not climb or lean on the unit. Children may sit on the designated seats and hold on.
- Do not place anything, especially liquids, on or around the unit.
- Do not drag the machine when moving it, as this could damage the cabinet/unit beyond repair.

Definition of Site Maintenance Personnel or Other Qualified Individuals



WARNING

Servicing and maintenance work of the contents herein stated should be performed by the *SERVICEMAN* stipulated as per IEC Standard. Those who do not have technical expertise and knowledge other than the *SERVICEMAN* are not allowed to perform the work herein stated. Executing the aforementioned work by such non-technical personnel can cause serious accidents that may endanger life.

Replacing parts, maintenance inspections, and troubleshooting should be carried out by **Site Maintenance Personnel** or other **Qualified Professionals**. This manual includes directions for potentially dangerous procedures which should only be performed by professionals with appropriate and specialized knowledge.

The **Site Maintenance Personnel** or other **Qualified Professionals** mentioned in this manual are defined as follows:

- **Site Maintenance Personnel:** Individuals with experience in maintaining amusement equipment, vending machines, etc., working under the supervision of the owner and/or operator of this product. Maintenance Personnel frequently service machines within amusement facilities or similar premises by carrying out everyday procedures such as: assembly, maintenance inspections, and replacement of units or replaceable parts.
 - **Actions Approved for Site Maintenance Personnel:** Machine assembly, maintenance inspection, and replacement of units or replaceable parts.
- **Other Qualified Professionals:** Personnel employed by the amusement equipment manufacturer. Personnel may also have been involved in design, production, testing, or maintenance of said amusement equipment. This individual should have either graduated from a technical school or hold similar qualifications in electrical, electronics, or mechanical engineering.
 - **Actions Approved for Other Qualified Professionals:** Assembly, maintenance, inspection, and replacement of units or replaceable parts for amusement equipment and/or vending machines, including repair or adjustments of electrical, electronic, or mechanical parts.

Before Using This Product

Please be sure to read the following before using this machine, in order to ensure the safe operation of this product. The following instructions are intended for users, operators, and personnel in charge of the operation and maintenance of the machine. After carefully reading and sufficiently understanding the warning displays and cautions, please handle the machine appropriately. Be sure to keep this manual for future reference.

Qualified Personnel: Only personnel who have technical expertise should perform the work stated herein to avoid hazardous situations. The instructions state that site maintenance personnel should be the only personnel performing work. Please perform maintenance work in accordance with the stated instruction; provided instructions for maintenance work are to minimize risk and prevent accidents. Failing to perform work as stated within the Instruction Manual may potentially be dangerous to both maintenance personnel and users.

- **Be sure to turn off the power before working on the machine.** To prevent electric shock, be sure to turn the power off before carrying out any work that requires direct contact with the interior of the product. If the work is to be performed in the power-on status, the Instruction Manual will state to do so.
- **Be sure to ground the Earth Terminal.** This is not required in the case where a power cord with earth/ground is used.
- **Ensure the power supply used is equipped with an Earth Leakage Breaker.** This product does not incorporate an Earth Leakage Breaker. Using a power supply which is not equipped with an Earth Leakage Breaker can cause a fire when or if earth leakage occurs.
- **Before installing the product, check for electrical specifications; the product must meet the requirements.** Ensure the product is compatible with the power supply voltage and frequency requirements of the location. Using any electrical specifications that are different from the designated specifications can cause a fire and/or electric shock.
- **Install and operate the product where appropriate lighting is available, allowing warning and safety labels to be read clearly.** To ensure customer safety, labels and printed instructions describing potentially hazardous situations are applied to places where risk for potential accidents are increased.

If any label is peeled off, apply it again immediately. Please contact Barron Games Technical Support at 1+716-866-0054 or email service@barrongames.com if you are in need of new stickers or parts. Visit www.BarronGames.com for more information about Barron Games' Parts and Service Department.

INSTALLATION AND MAINTENANCE SAFETY

This product is an indoor amusement ride for small children.

Do not install it outside. Even indoors, it is strongly recommended to avoid installing it in the places mentioned below, to avoid causing a fire, electric shock, machine malfunction, or even death. Do not install or maintain this product in/on/within/near:

- places subject to rain or water leakage, places subject to high humidity, or in the proximity of an indoor swimming pool, shower, steam room, etc.
- places subject to direct sunlight, places subject to high temperatures, or in the proximity of heat dispensing units or portable heating devices.
- places filled with inflammable gas, within the vicinity of highly flammable or volatile chemicals, or other hazardous materials.
- dusty places.
- sloped surfaces.
- places subject to any type of violent impact.
- the vicinity of anti-disaster solutions, such as fire exits and extinguishers.
- places where the operating (ambient) temperature range is not 5°C to 30°C (41°F to 86°F).
- places near water or spray from water (such as a jet wash, hot tub, or swimming pool).

To ensure maximum safety for the users and service personnel, ensure that where the product is operated has sufficient lighting to allow all safety labels to be read clearly. Operation under insufficient lighting is not advised.



ASSEMBLY NOTES

1. Read this Instruction Manual carefully before assembling or operating.
2. Ensure that there is sufficient space to place and shift the product prior to assembling.
3. Three strong adults are recommended to assemble the product.
4. Inspect and ensure all parts are securely attached before operating.

*Note: Please retain the original packaging, so that it may be used for storage or transport later.



TOOLS NEEDED



- 2GB SD Card (included)

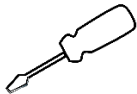

- Flathead Screw Driver



- Two Strong Adults



- Fantasy Coffee Cup Instruction Manual

Weight	411 lbs.
Base Diameter	65 in. *Note: Approximately 75" minimum space required to rotate
Height	72 in.
Voltage	110V AC, 60Hz, 3A, Max 6A 220V AC, 50Hz, 3A, Max 6A

Assembly – Step A Product Specifications

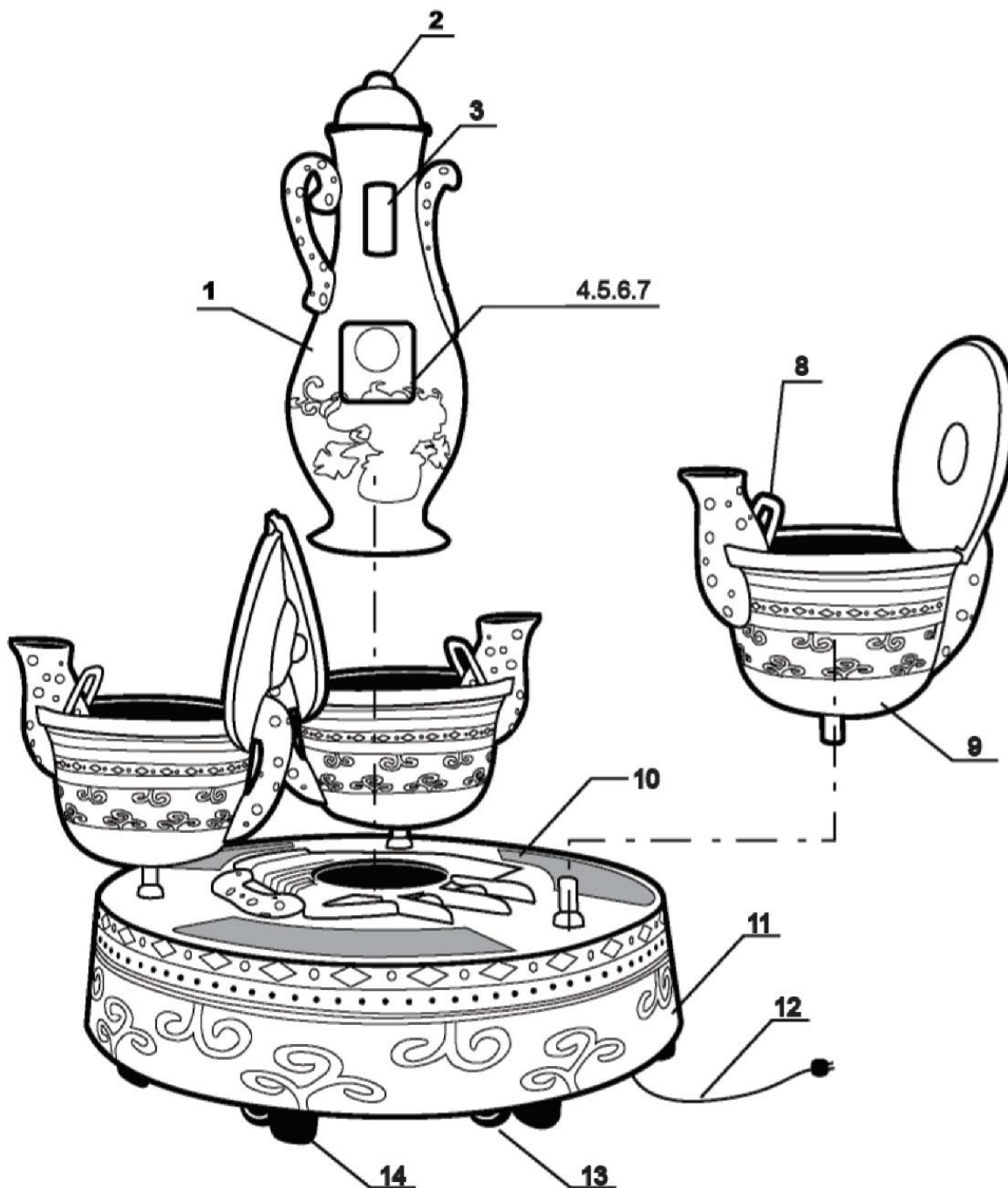

1	Coffee Cup FRP	6	Control & Music Box	11	FRP Base
2	Light #2	7	Speaker	12	Power Supply / Power Cord (located at rear of base)
3	Coin Mechanism (Key #1)	8	Handlebar #2		
4	Control Door (Key #1)	9	Cup FRP	13	Wheel
5	Coin Box (Key #2)	10	Aluminum Footboard	14	Fixer / Foot

Assembly – Step B Control Panel Settings

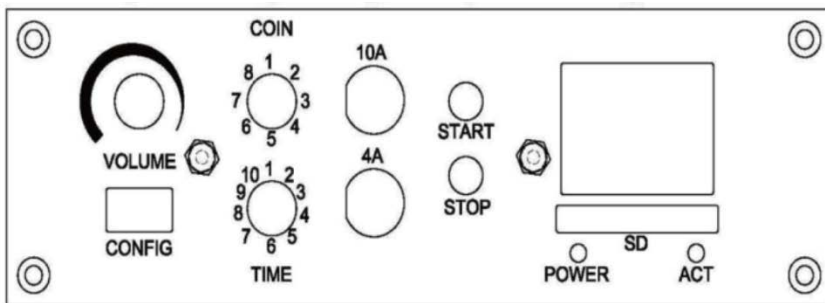

<- Control Panel

Note: In order to activate each function change, the unit must be rebooted (turn the power off and back on).

VOLUME SETTINGS



Adjust the volume using knob.
Turn counter-clockwise for more volume.

“CONFIG” FUNCTION SETTINGS

(O = OFF = Down; X = ON = Up)

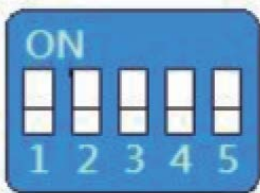

1	2	3	4	5	Function
O					Coin Start
X					Button Start
	O				Coin Record
	X				Coin Unrecorded
		X			Coin Selector – NO
		O			Coin Selector – NC
			O		Testing Mode
			X		Normal Mode
				O	Coin Counter
				X	Game Play Counter

- **Testing Mode:** The cycle will work for 60 seconds and then stop for 60 seconds
- **Normal Mode:** The business operation mode
- **Coin Counter:** The meter work for every coin (1 coin 1 play)
- **Game-Play Counter:** The meter work for every game-play.

COIN SETTINGS





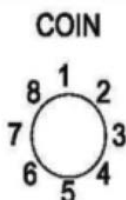

Turn the knob to direct number and function as follows:

Cost per Ride:

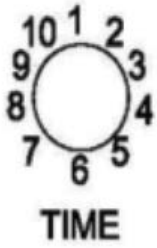
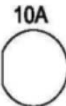

Position	Function
1	1 Coin per Ride
2	2 Coins per Ride
3	3 Coins per Ride
4	4 Coins per Ride
5	5 Coins per Ride
6	6 Coins per Ride
7	7 Coins per Ride
8	8 Coins per Ride

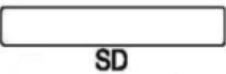
Assembly – Step B Control Panel Settings

TIMER SETTINGS		Turn the knob to direct number and function as follows:
<p>Ride Length Timer:</p> 	Position	Function
	1	Ride Time = 30 seconds
	2	Ride Time = 60 seconds
	3	Ride Time = 90 seconds
	4	Ride Time = 120 seconds
	5	Ride Time = 150 seconds
	6	Ride Time = 180 seconds
	7	Ride Time = 210 seconds
	8	Ride Time = 240 seconds
	9	Ride Time = 270 seconds
10	Ride Time = 300 seconds	
AC FUSE		
	10A	
DC FUSE		
	4A	
START BUTTON		
	Press the button for ride to start	
STOP BUTTON		
	Press button to stop ride.	
METER / COUNTER		
	A mechanical meter that counts coins and times played.	
SD CARD		
	For SD Card installation	
POWER		
	Power LED light directive, indicates machine is functioning	
ACT		
	ACT LED light directive; indicates ACT is functioning	

Assembly – Step C Connect Panel Settings

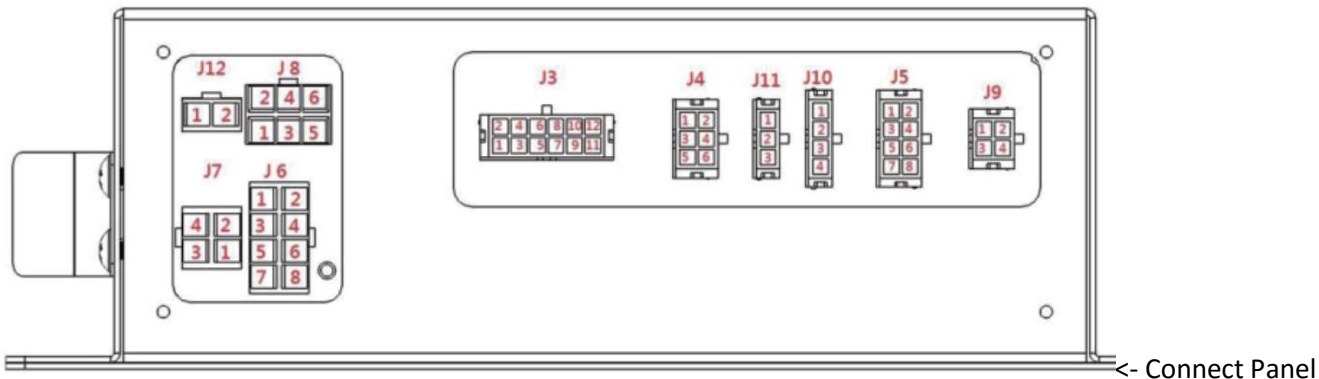

J3: 12-PIN LED LAMP

J3

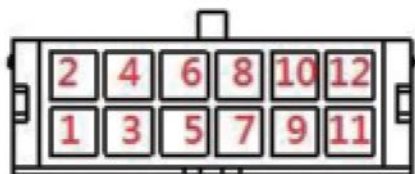

Note:
DC 12V power output maximum is 4A

1	GND	GND
2	Game-play & DC power output	DC 12V
3	GND	GND
4	Game-play & DC power output	DC 12V
5	GND	GND
6	Game-play & DC power output per 0.5sec	DC 12V
7	GND	GND
8	Game-play & DC power output per 0.5sec	DC 12V
9	GND	GND
10	Unit power-on & DC power output	DC 12V
11	GND	GND
12	Unit power-on & DC power output	DC 12V

J4: 6-PIN COIN

J4

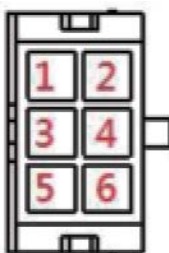

1	Coin Power VCC	DC 12V
2	Coin Power GND	GND
3	Coin Signal	SIGNAL
4	Start Button Light GND	GND
5	Enable VCC	DC 12V
6	NO USE	NO USE

J5: 8-PIN EFFECT SWITCH

J5

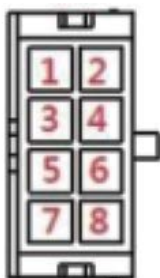



1	Start Button	SW-1-NO
2	Start Button	SW-1-COM
3	Effect Button -1-	SW-2-NO
4	Effect Button -1-	SW-2-COM
5	Effect Button -2-	SW-3-NO
6	Effect Button -2-	SW-3-COM
7	NO USE	NO USE
8	NO USE	NO USE

J6: 8-PIN AC INPUT

1	AC INPUT GND	
---	--------------	--

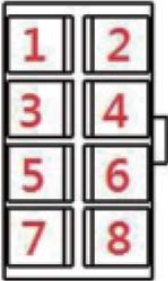
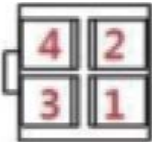
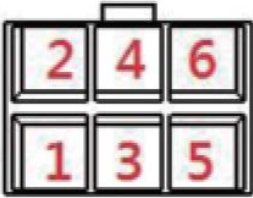
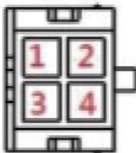
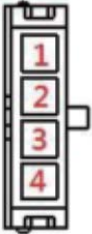
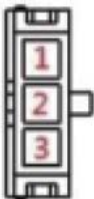
Assembly – Step C Connect Panel Settings

J6		2	AC INPUT GND	AC INPUT 86V~265V MAX 10A
		3	AC INPUT L	
		4	AC INPUT N	
		5	AC INPUT L	
		6	AC INPUT N	
		7	AC INPUT L	
		8	AC INPUT N	
J7: 4-PIN AC OUTPUT				
J7		1	AC OUTPUT N	AC OUTPUT 85V~265V
		2	AC OUTPUT GND	
		3	AC OUTPUT L	
		4	AC OUTPUT GND	
J8: 6-PIN MOTOR AC POWER				
J8		1	MOTOR AC OUTPUT L	110V/220V MAX 10A
		2	MOTOR AC OUTPUT L	
		3	MOTOR AC OUTPUT N	
		4	MOTOR AC OUTPUT N	
		5	MOTOR AC OUTPUT GND	
		6	MOTOR AC OUTPUT GND	
J9: 4-PIN RS 232				
J9		1	RS232 COM	
		2	RS232 TX	
		3	RS232 COM	
		4	RS232 RX	
J10: 4-PIN SOUND				
J10		1	SPEAKER R+	15w/8Ω
		2	SPEAKER R-	
		3	SPEAKER L-	
		4	SPEAKER L+	
J11: 3-PIN LIMIT SWITCH				
J11		1	+12V	
		2	SIGNAL	
		3	GND	
J12: 2-PIN MOTOR AC LAMP				
J12		1	MOTOR AC LAMP OUTPUT L	110V/220V
		2	MOTOR AC LAMP OUTPUT N	

Assembly – Step D Coin Comparator Instructions (U.S. Model Only)

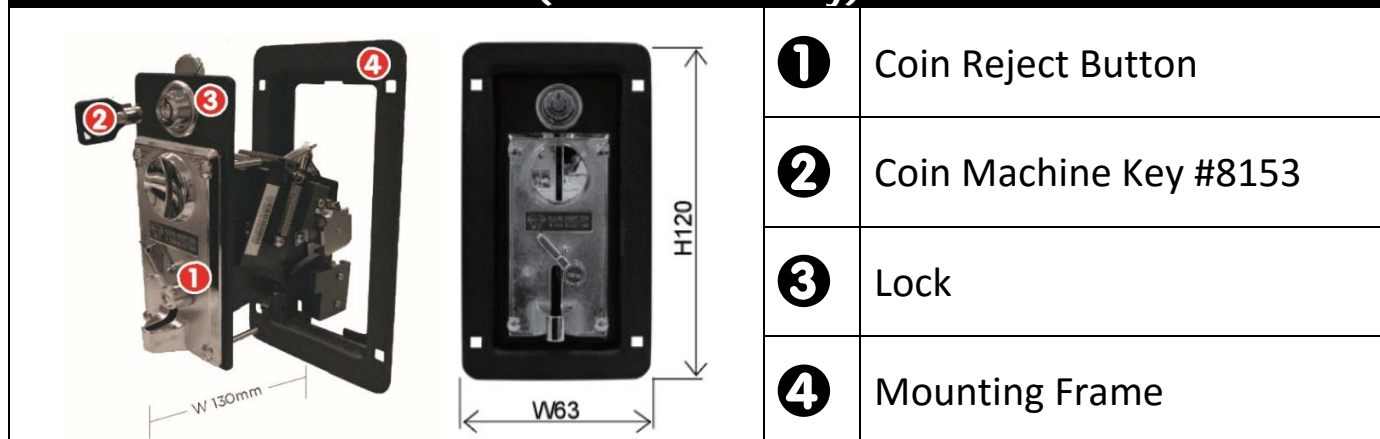

How to Set a Constant Coin*

Continue reading for a visual diagram of these steps.

Step 1

Choose the desired coin for use and insert it in the clamp on the side of the coin comparator/coin mechanism. This coin is now considered the “constant” based on coin size, thickness, metallic properties, and coin diameter. Only these types of coins will be accepted until a new constant coin is installed.

Step 2

Adjust the *coin insert size* to the size of your Constant Coin (front panel back side).

Step 3

Select the correct mode: Normal Open/Normal Close

“Timer Switch” for synchronizing your system:

- 100ms (Slow Speed / Long Pause)
- 50ms (Medium Speed / Medium Pause)
- 30ms (Fast Speed / Short Pause)

Step 4

Adjust VR Sensitivity Tuning:

- Clockwise: Slack Selection (LED Dark -> Light)
- Counter-Clockwise: Strict Selection (LED Light -> Dark)

Step 5

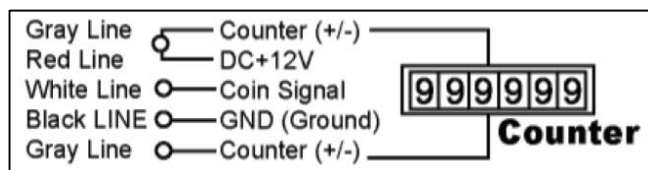

Step 6: Alarm Connection Input

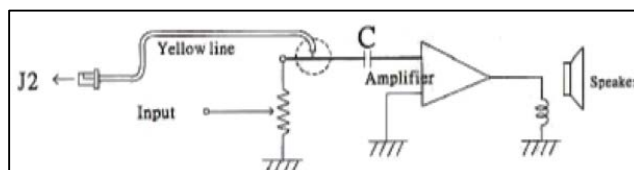

*Note: Models may vary in style.

Coin Comparator Operating Manual

COIN SPECIFICATION

Diameter: 18mm~31m
Thickness: 1.2mm~3.0mm

USER EQUIPMENT

Voltage: DC 12V \pm 20%
Currents: 200mA

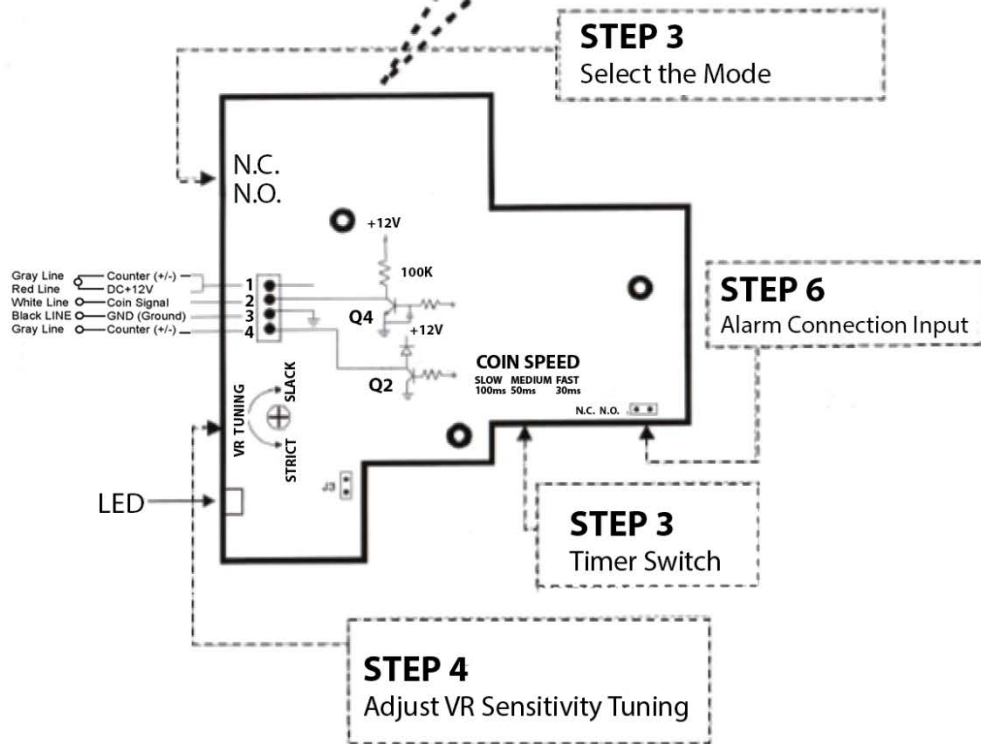
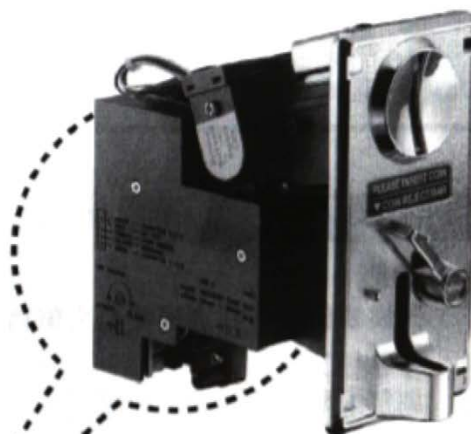

Coin Box Description



1 Key for Coin Box #103

2 Lock

3 Coin Box Frame

4 Coin Box

5 Access Door to Coin Box



Size: W 175mm x L 145mm x H 175mm

Assembly – Step ③ Control & Music Box Specifications

Function: This equipment is for Kiddie Rides only

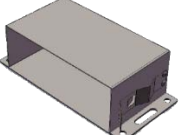

AC Input	AC 85V~265 50/60 Hz
AC Output (Motor)	AC110 / AC220V, 10A
DC12V Output	4A (Total)
Speaker	15W / 8 ΩSTERO
Music Storage	SD Card (Up to 8G)
Music Format	MP3
AC Fuse	10A
DC Fuse	4A
Weight	1.5 KG

<p>Dimensions: D 187mm x W 208mm x H 58mm</p>	
<p>Dimensions - Main Unit: D 170mm x W 168mm x H 54mm</p>	
<p>Dimensions - Connect Unit: D 90mm x W 208mm x H 58mm</p>	

Functions and Features

1. 15W sound-stereo and volume adjustment
2. Set up the meter value by coin or play-time
3. Multiple coin values set up for game-play
4. Multiple times value set up for game play
5. AC Power 10A fuse – DC Power 5A fuse protection
6. Use mechanical-meter to count coins or game-plays
7. Power and Action LED light directive for working.

Rear Panel Pin Assignment

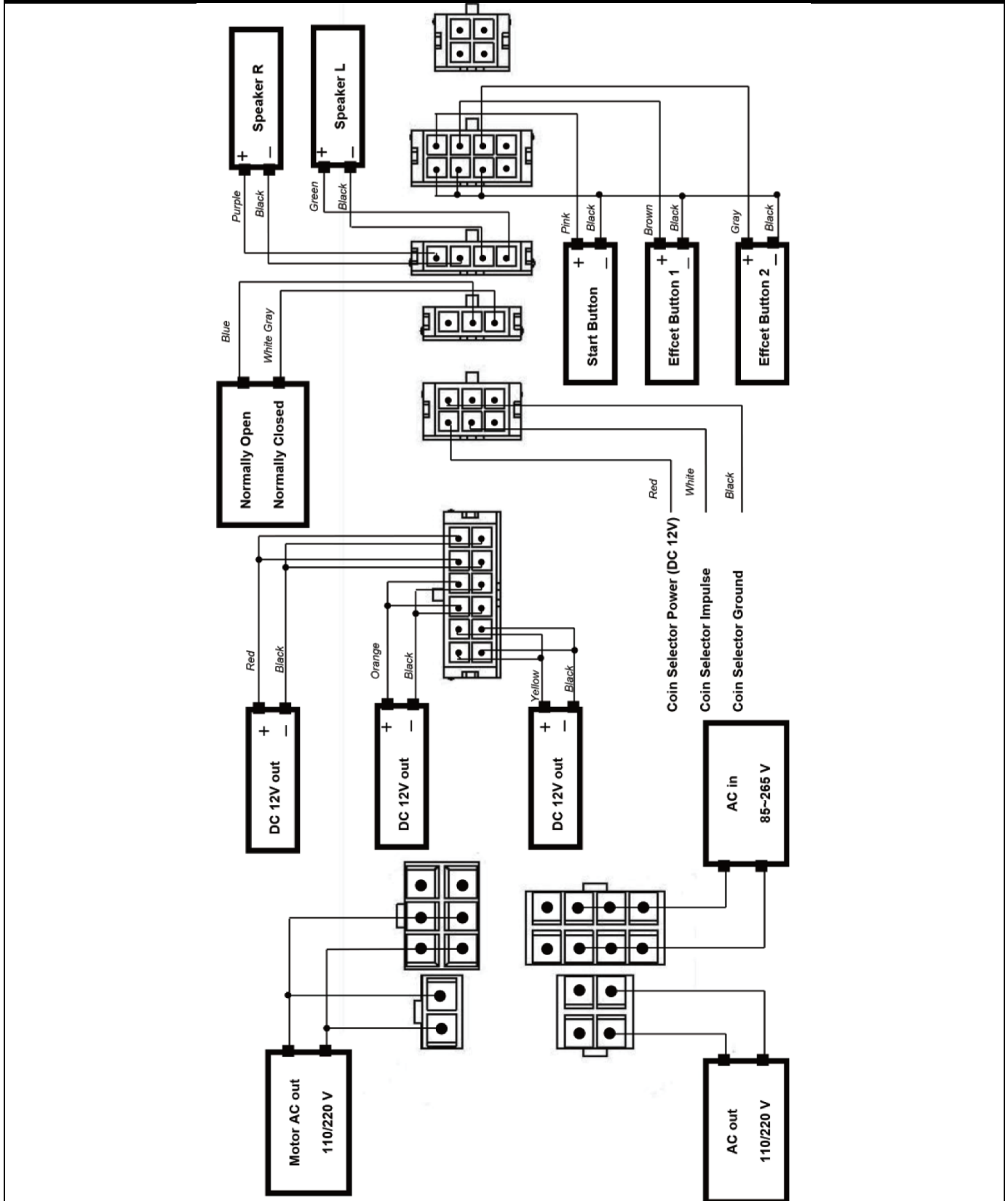

After Installing the Product

1. Check the voltage regularly to avoid a short circuit or potential fire. Do not overload the circuit.
2. Keep the power cord out of areas with busy foot traffic to ensure the safety of users and the machine.
3. Keep children away from all power sources and power supply units. Children should always be under adult supervision while using the machine.
4. Regular maintenance should be performed on the machine to ensure that it is clean, smooth, and debris-free (see section "Care and Maintenance").
5. Do not use any sharp instruments on any part of the machine as it may cause irreparable damage.
6. Remove and replace any piece or part that becomes damaged.
7. Turn off the ride and have it inspected by an electrician or service technician if it is operating abnormally.
8. Contact an electrician or service technician if your product experiences the following:
 - Power Failure
 - Liquid or Objects Found Near/Inside Electronic Components
 - Abnormal Sounds
9. Use caution while transporting.
10. Do not use outdoors or in damp areas.

Care and Maintenance

1. Always connect the machine to a grounded electrical outlet. **Be sure to always turn off the power before servicing.**
2. Always turn OFF the power and unplug the power supply before opening or replacing any parts. When unplugging the machine from an electrical outlet, grasp the plug, not the cord.
3. **Caution:** Always use digital multimeter, logic tester, or oscilloscope for testing integrated circuits. Do not connect or disconnect any of the integrated circuits while the machine is ON. Do not install any fuse that does not meet the specified rating.
4. Use a soft cloth and a non-ammonia-based non-bleach household cleaner to clean the unit. Do not apply cleaner or any other liquid directly onto the machine, instead, apply it to the cloth and then wipe the surface. We've found that a microfiber cloth works great to remove dirt and fingerprints with ease.
5. Periodically check the functionality of the coin mechanisms and empty coin boxes.
6. To extend the life of this product, routinely maintain and inspect the machine.
 - a. Exterior Inspection
 - Check if warning labels are coming off or are dirty and unrecognizable
 - Check if the light board is fastened or not
 - Clean the coin slot machine
 - Check each plug for frays or damage
 - b. Check Parts
 - Check if speakers are normally producing sound
 - Check if LED lights and buttons are normally functioning
 - Ensure the emergency button is clear of debris

Troubleshooting

No Power:

- Make sure the power supply cord is connected and is the correct voltage
- Make sure all power switches are "ON"
- Check power going out of the 24V transformer

Cannot Insert Coin:

- Go to operator menu and check the coin setting
- Reinstall reference coin
- Make sure DIP switches are set for desired settings

No Sound:

- Go to operator menu and check the volume setting
- Adjust the amplifier volume
- Check the wires connecting to the speakers
- Make sure the game is credited and ON

START/FX Button Failure:

- Change micro switch
- Check wire connections
- Check PCB connections

Ride Not Moving:

- Check motor for damage
- Inspect orange torque safety arm
- Inspect gear box for leaking oil
- Check to see if there is debris blocking the base from moving



**Barron Games International
84 Aero Drive, Suite 5
Buffalo, NY 14225**

Phone: 1+716-866-0054

Fax: 1+716-630-0055

www.BarronGames.com

For Parts and Service Information, please contact us:

Phone: +1-716-866-0054

Email: Service@BarronGames.com