

Set up and Service Manual

Version: PB-A-01



★ Please read this manual before operating your game.

★ Please keep this manual in good condition for future reference.



Need parts or service, please contact us:

Injoy Motion Corp.



Injoy Motion

Technical support: +886-2-2267-6317

Fax: +886-2-2267-5906

E-mail: support@injoymotion.com

Note:

- The product specifications are subject to change without notice.
- This game content, equipment and design protected by law, including patents, copyrights and intellectual property rights.
- Unauthorized reproduction of this document or any of its contents is strictly prohibited.

VERIFICATION OF COMPLIANCE

to the requirements of

EMC Directive 2004/108/EC

Verification Report No. : ED/2012/C0017C
Representative Model : DIDO KART AIR-1
Series Model(s) : X AIR-Z
(X=Street Racing Stars, DIDO KART, POWER BOAT & NEW GAME NAME ;
Z=1, 2, 4)
Product Name : AIR Series Motion Simulator
Applicant : Injoy Motion Corp.
Address of Applicant : 48, Yongping Street, Tucheng District, New Taipei City 236, Taiwan
Test Report Number : ED/2012/C0017
Date of Tests : December 25, 2012
Date of Issue : January 09, 2013
Applicable Standards : SGS Onsite Test Standard: 2012
EN 61000-6-2: 2005, EN 61000-6-4: 2007

Conclusion

In the opinion of SGS, the equipment complies with the principle requirement of the above standards and following directive:

Electromagnetic Compatibility Directive 2004/108/EC

Note: The verification is only valid for the equipment and configuration tested and in conjunction with the test data described in the Test Report.

The CE mark as shown below can be used, under the responsibility of the manufacture, after completion an EC Declaration of Conformity and compliances with all relevant EC Directives.

Authorized Signatory:

SGS TAIWAN LTD.
Jason Lin
Technical Manager



Unless otherwise stated the results shown in this test report refer only to the sample(s) tested. This test report cannot be reproduced, except in full, without prior written permission of the Company. 除非另有說明，此報告結果僅對測試之樣品負責。本報告未經本公司書面許可，不可部份複製。

This document is issued by the Company subject to its General Conditions of Service printed overleaf, available on request or accessible at www.sgs.com/terms_and_conditions.htm and, for electronic format documents, subject to Terms and Conditions for Electronic Documents at www.sgs.com/terms_e-document.htm. Attention is drawn to the limitation of liability, indemnification and jurisdiction issues defined therein. Any holder of this document is advised that information contained hereon reflects the Company's findings at the time of its intervention only and within the limits of Client's instructions, if any. The Company's sole responsibility is to its Client and this document does not exonerate parties to a transaction from exercising all their rights and obligations under the transaction documents. This document cannot be reproduced except in full, without prior written approval of the Company. Any unauthorized alteration, forgery or falsification of the content or appearance of this document is unlawful and offenders may be prosecuted to the fullest extent of the law.

SGS Taiwan Ltd. | No. 134, Wu Kung Road, Wuku Industrial Zone, Taipei County, Taiwan. / 台北縣五股工業區五工路134號
台灣檢驗科技股份有限公司 | t (886-2) 2299-3939 f (886-2) 2298-2698 www.tw.sgs.com

Member of SGS Group

TWA3895598

1008



ADVANCED SAFETY PRODUCT
ASP TECHNOLOGY CORP

8F.-1, No. 1, Zhongzheng Rd., Tucheng Dist., New Taipei City 23670, Taiwan(R.O.C.)
TEL:886-2-22613919, FAX:886-2-22613918, E-mail:ASP.twn@gmail.com

VERIFICATION OF CONFORMITY

We Hereby Certify that

The following mentioned product has been tested in typical configuration by ASP.

Applicant:

INJOY MOTION CORP.
NO. 48, YONGPING ST., TUCHENG DIST.,
NEW TAIPEI CITY 236, TAIWAN(R.O.C.)

Product Type:

AIR SERIES MOTION SIMULATOR

Model Name:

X AIR-Z
(X=STREET RACING STARS, DIDO KART, POWER BOAT, ALLIED TANK ATTACK;Z=1,2,4)

Is in compliance with the European Council Directive 2006/95/EC.

The submitted samples comply with the requirements of the following standard(s):

EN 60950-1:2006+A12:2011



This verification refers only to the units submitted for test. The CE mark as shown above can be used, under the responsibility of the manufacturer, after completion of an EC Declaration of Conformity and compliance with all relevant EC Directives.

Signed for and on behalf of ASP Technology Corp.

Kevin Ku/ Manager.
ASP Technology Corp.



Jan.3, 2014
Date.

The technical report issued by ASP will support you affix the CE marking.

EC DECLARATION OF CONFORMITY

INJOY MOTION CORP.
NO. 48, YONGPING ST., TUCHENG DIST.,
NEW TAIPEI CITY 236, TAIWAN(R.O.C.)
(Name / Address)

We herewith declare that the following designated product type:

Product Type:

AIR SERIES MOTION SIMULATOR

Product Name:

X AIR-Z

(X=STREET RACING STARS, DIDO KART, POWER BOAT, ALLIED TANK ATTACK;Z=1,2,4)

Conform with the essential requirement of the relevant European Directive:
- LVD Directive: 2006/95/EC

They are based on the following standards :

Safety Reference Standard:

- EN 60950-1:2006+A12:2011 - Information technology equipment – Safety - Part 1: General requirements.

MANUFACTURER / IMPORTER

Albert Wu

(Surname, forename)
(Company Stamp)



2014.01.27 Taiwan
(Date and place)



Index

1. General Information	6
1.1 Safety Notes.....	6
1.2 Specifications.....	7
2. Installation	8
2.1 Checklist.....	8
2.2 Installation.....	9
3. Game setting (Operator menu)	14
3.1 Coin Options.....	15
3.2 Game Options.....	16
3.3 Pedal Setting.....	17
3.4 Volume setting.....	19
3.5 Device Test.....	19
3.6 Save & Exit.....	21
3.7 Free Key.....	21
3.8 System Recovery.....	22
4. Trouble shooting	23
4.1 Error code.....	23
4.2 General issues.....	26
4.3 Display.....	27
4.4 Sound.....	28
4.5 Control.....	28
4.6 Link.....	29
4.7 Technical Support.....	31
Appendix A: How to change potentiometer in pedal module	32
Appendix B: How to connect tubes	35
Appendix C: How to change airbag	37
Appendix D: Clean the drain valve	44
Appendix E: Connection for coin acceptor	48

1. General Information

1.1 Safety Notes

Please read the following instructions carefully before using the game.



Using separate power supply for this machine



Handling with care

The game contains glass and fragile electronic equipment, should be very careful when handling



Be sure to turn off the power before maintenance



Earth Connection

To avoid electrical shock! Please use earth connection.



Using connectors properly

Check direction before connect



Move PC with care

1.2 Specifications

Size	218 x 112 x 235 cm
Weight	350 kg
Rate Power	USA : AC 100-120V, 50/60Hz, 1320W Europe : AC 220V, 50Hz, 1320W
Occupant weight limit	150 kg

2. Installation

2.1 Checklist

Number	Item (For 1 machine)	Quantity
①	TV cabinet	1
②	Cockpit	1
③	Light set	1
④	Service manual	1
⑤	Parts kit (screws, keys)	1

Note: This Machine must be installed indoor, need to maintain a distance of 50 cm with the wall. Make sure the unit stands are placed flat on the ground and the machine is not moving when playing.

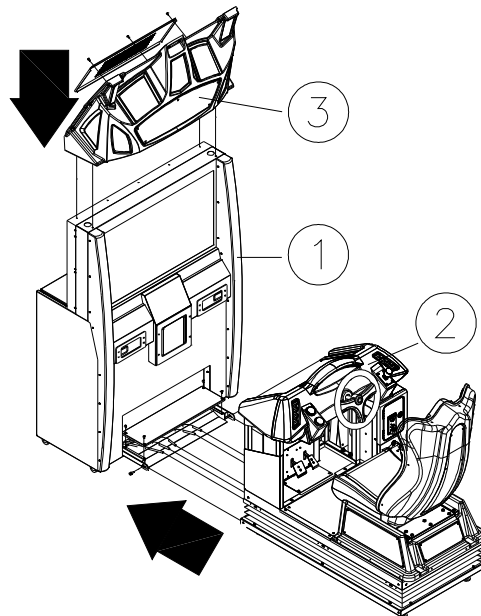
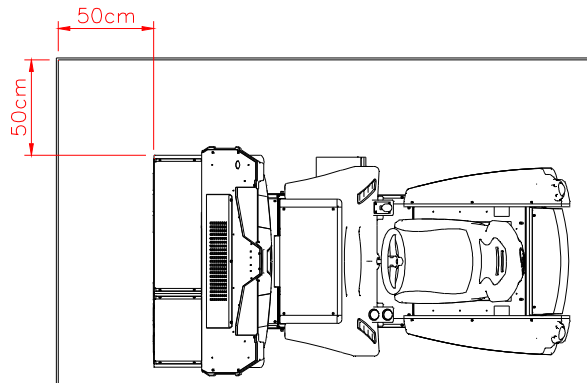

Assembly Diagram

2.2 Installation

Step1 : Take out tubes and connectors

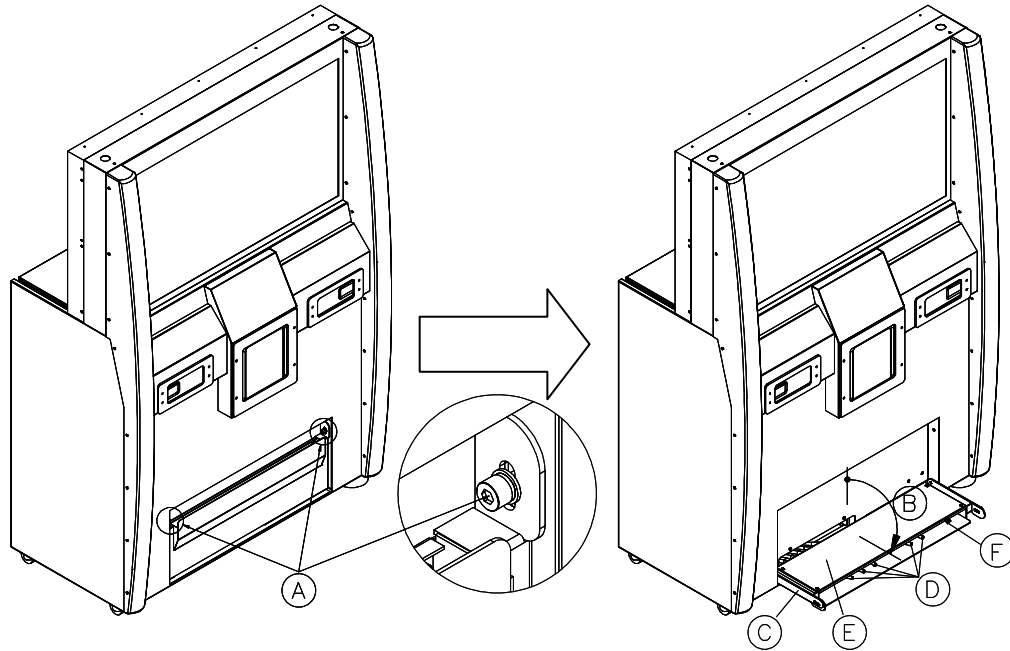

Note:

1. Remove 2 screws (A).
2. Open the case (C) until horizontal position (B).
3. Open case cover (E), Take out tubes (D) and all connectors (F).

Step2: Connecting the tubes

Move cockpit close to TV cabinet, and connect the tubes ⑤ ⑥ ⑦ ⑧ ⑨ from TV cabinet to cockpit ⑤ ⑥ ⑦ ⑧ ⑨ according to the same color.

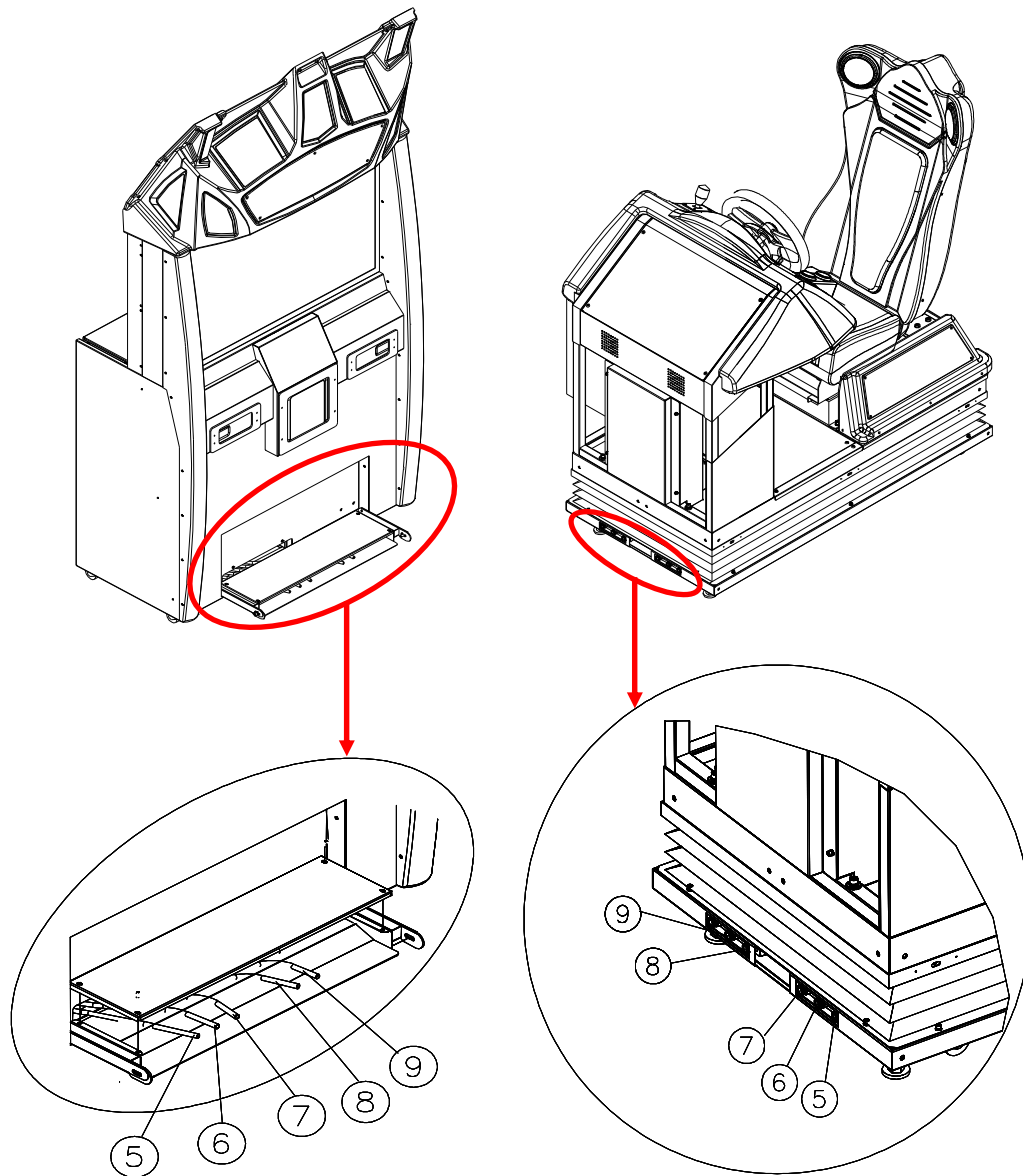

⑤	Black Tube	⑧	No-color Tube
⑥	Orange Tube	⑨	Transparent-Blue Tube
⑦	Blue Tube		

Step3: Connecting the TV cabinet connectors ①⑥ ①⑦ ①⑧ ①⑨ ②① ②② ②③ with cockpit connectors①⑥ ①⑦ ①⑧ ①⑨ ②① ②② ②③ by the same pin-number and the same name tag.

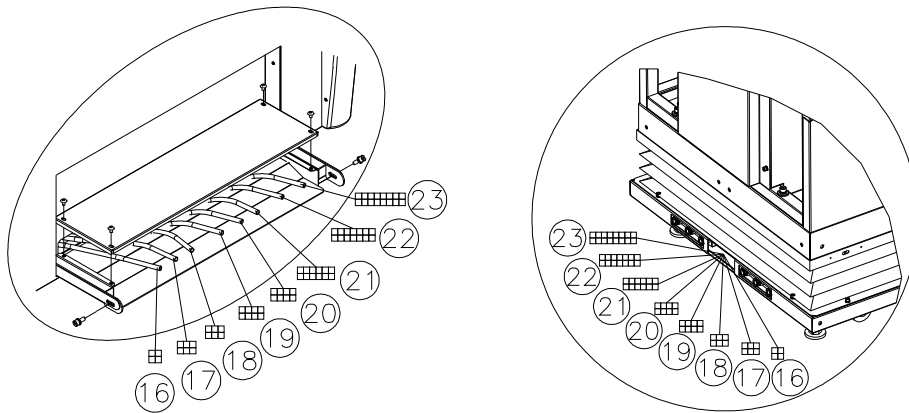

Number	Shape	Pin	Tag name
①⑥		4	Motor
①⑦		6	Coin Power
①⑧		6	Tail light module
①⑨		8	Coin cable
②①		8	Free OP
②②		14	AI0-3
②③		16	Belt & Gear

Step4: Use screws⑩ to combine TV cabinet and cockpit together. Sort out all wires and then cover the cover④. Use screws⑩ to fix it.

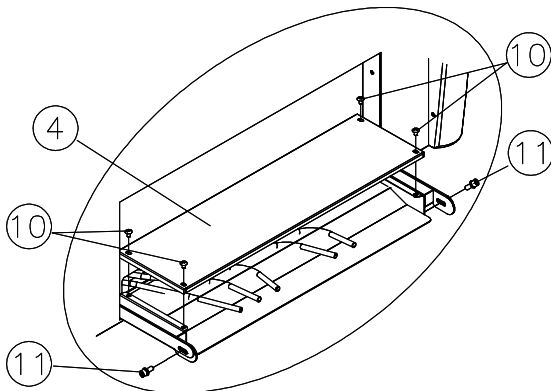

④	Cover
⑩	Phillips screws M5*10L
⑪	SHCS M8*25L with double washer

Step5: Check Light set⑫ and open back cover⑬. Put the light set on the TV cabinet and aligned it to the 4 bottom holes inside, then use Phillips screws to fix it.

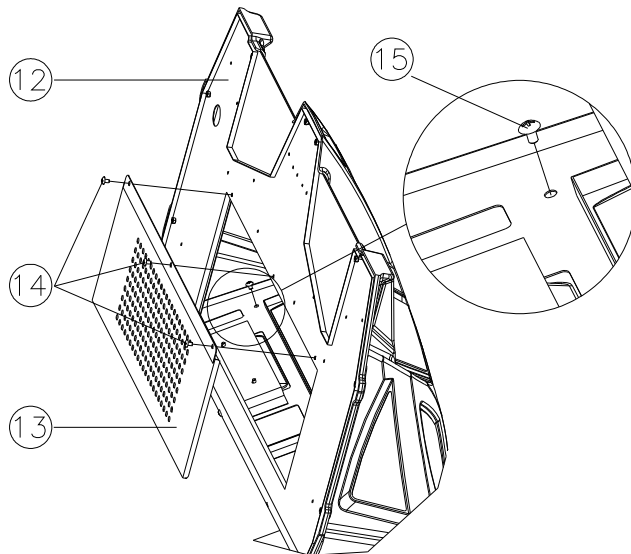

⑫	Light set
⑬	Cover
⑭	Phillips screws M6*12L
⑮	Phillips screws M5*16L

Step6: Connect the power cable inside the light set and use Screw⑭ to fix the cover⑬.

Step7: Connect machine power (220V/8A, 110V/15A)



1. When using power extension cord, the current capacity should be double.
2. Every power loop only support 2 machine at max.

Coin Acceptor Setting

Step8: Pull up the slider of the coin acceptor and insert the coin into the coin acceptor. Release the slider to fix the coin acceptor.

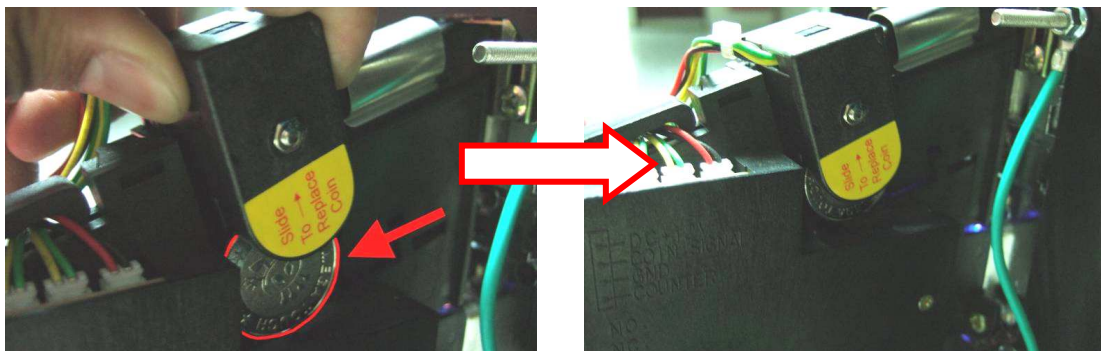

Step9: Check the Coin Acceptor Setting. (Select “NO” on top switch, “SLOW” on bottom switch)

Placement for external plate

Step10: Put a plate on the floor and right under the drain valve.

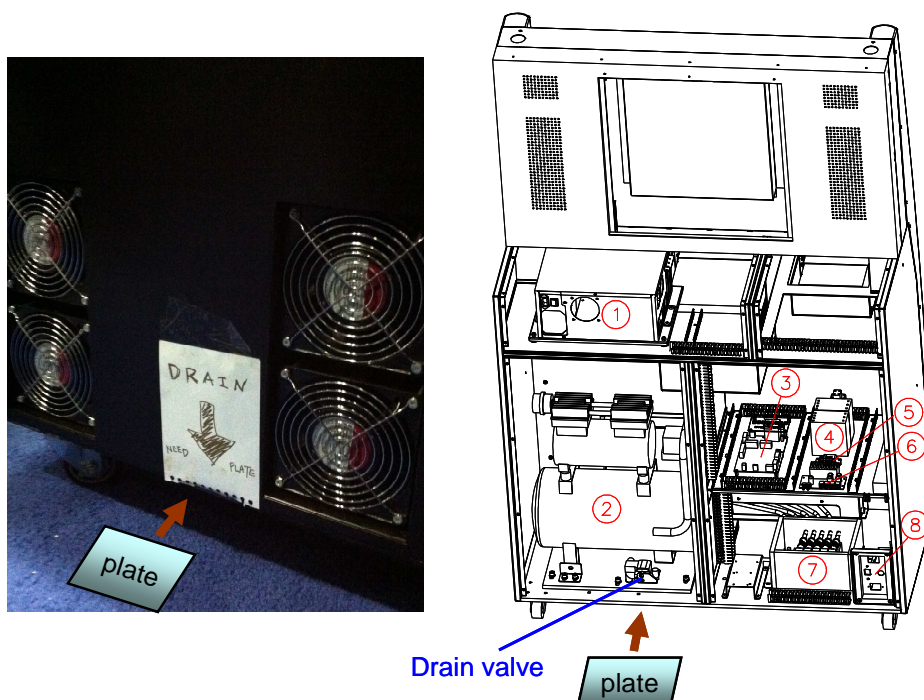

Note: The air compressor tank drains water after machine power off. So it is necessary to put a container on the floor and right under the drain valve to catch the water. Generally, a plastic plate around 25x20x3(LxWxH)cm is suggested.

3. Game setting (Operator menu)

To access Operator Menu, after the Power is switched ON and the screen shows “insert coin”, find the red Operator menu switch located inside the coin box, switch it to “I” position to enter.



Then you will see below screen.



3.1 Coin Options

1. **“Coins per Play”** allows you to set how many coins it will take for a player to start a game. The factory default setting value is 4 coins per play.
2. **“Coins per Continue”** allows you to charge a different price for continue-play from the first game play. The factory default setting value is 4 coins per play.
3. **“Currency Type”** is not to select the currency of a country, but allows selection of the forms of currency
4. **“Coins per Pulse (Coin Acceptor 1)”** allows you to adapt different currency acceptors. The default value is 1.
5. **“Coins per Pulse (Coin Acceptor 2) (Figure 4-4)”** allows you to adapt different currency acceptors. The default value is 1.
6. **“Winner Continue”** allows you to set up “insert coin to continue or free to continue” if Winner wants to continue game. This setup is for the single player mode.
7. **“Winner Continue (Net)”** allows you to set up “insert coin to continue or free to continue” if Winner wants to continue game. This setup is for the multi-player mode.



Coin per Play	5
Coin per Continue	5
Currency Type	Coin
Coin per Pulse(Coin Acceptor 1)	1
Coin per Pulse(Coin Acceptor 2)	1
Winner Continue	Insert Coin
Winner Continue(Net)	Insert Coin
Coin Acceptor Training	
Save & Exit	

3.2 Game Options

1. “**Game Time**” no function.
2. “**Game Show Operation**” - **Enable** sets free game play. Click “+” or “-” button to “Enable” or “Disable” this function.
3. “**Player Number**” no function.

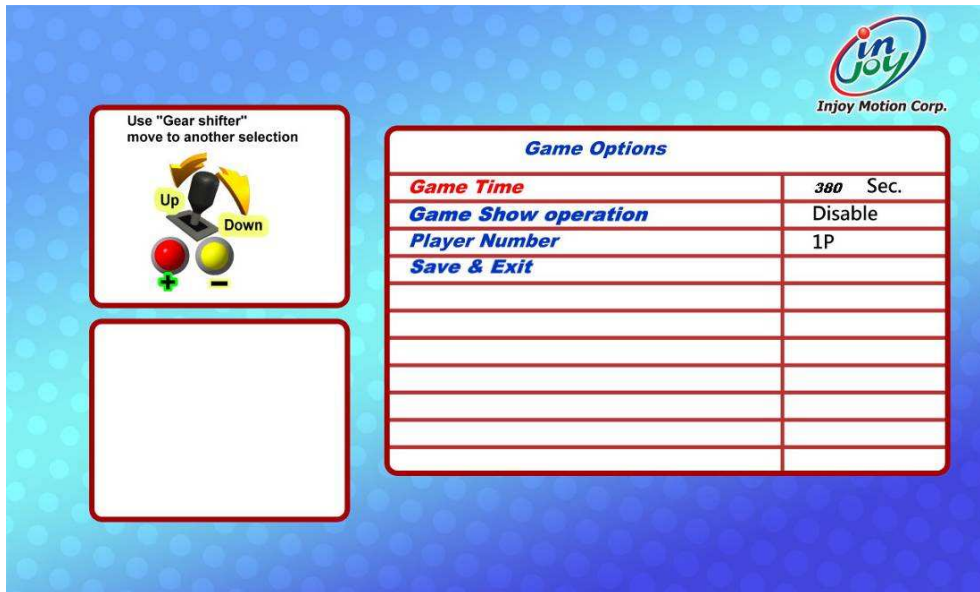

3.3 Pedal Setting

Replacing the accelerator or the brake pedal potentiometer may refer to screen values to install. If the potentiometer values set exceed the safe range or dead zone after installation, the screen will show the error. Please re-set the potentiometer values within the safe range.

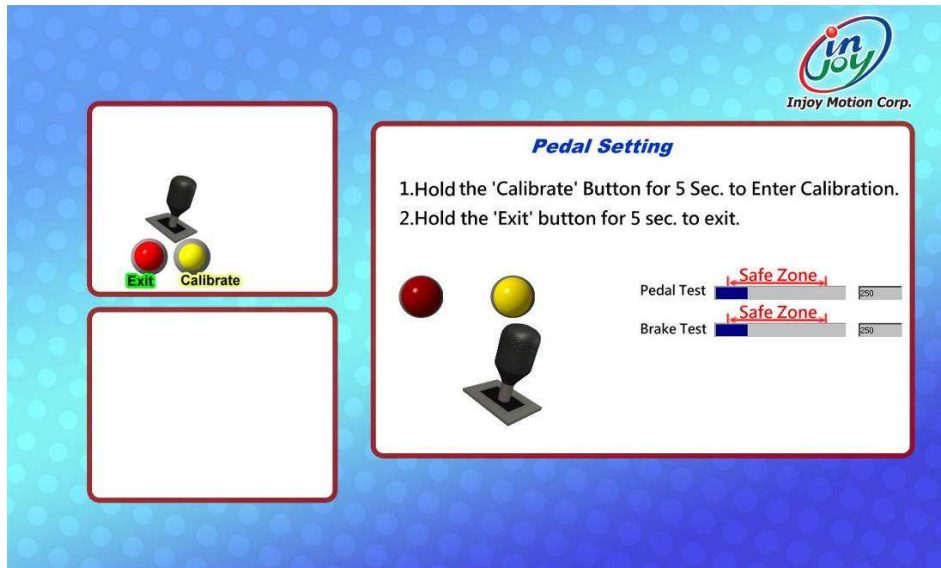

To calibrate the Pedal and Brake, follow the directions on the screen and go through these steps.

Step1: Hold the “Calibrate” button on the Panel to calibrate the pedal and brake. Release the Brake and Pedal, then press “Next” button.

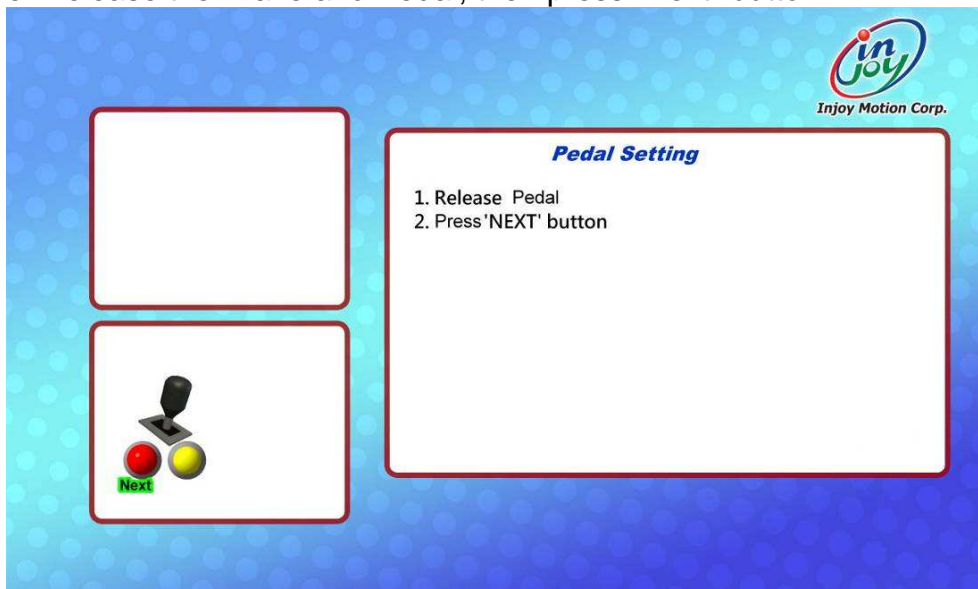

Step2: Press the Brake and Pedal to limit and then press “Next” button.

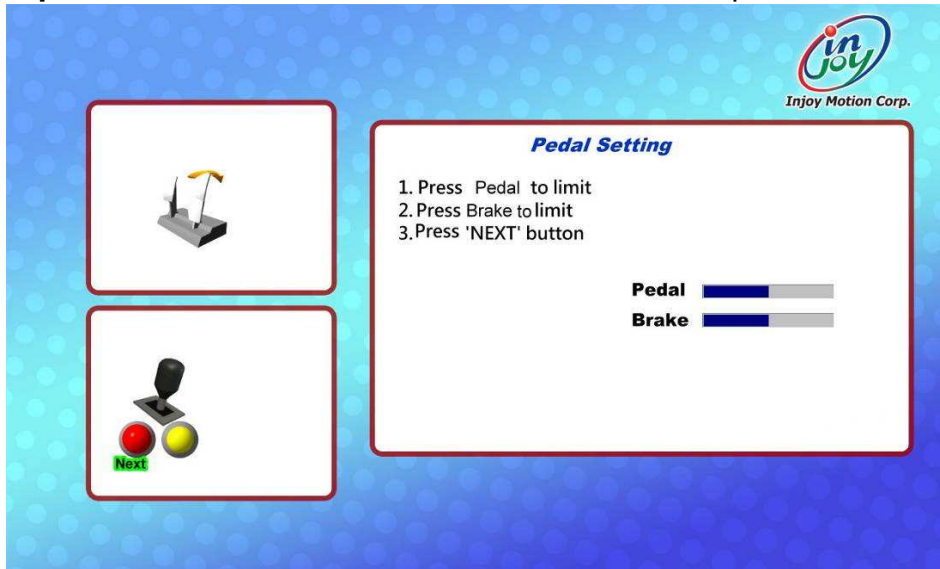

Step3: After finishing the calibration, press the “Exit” button to exit.

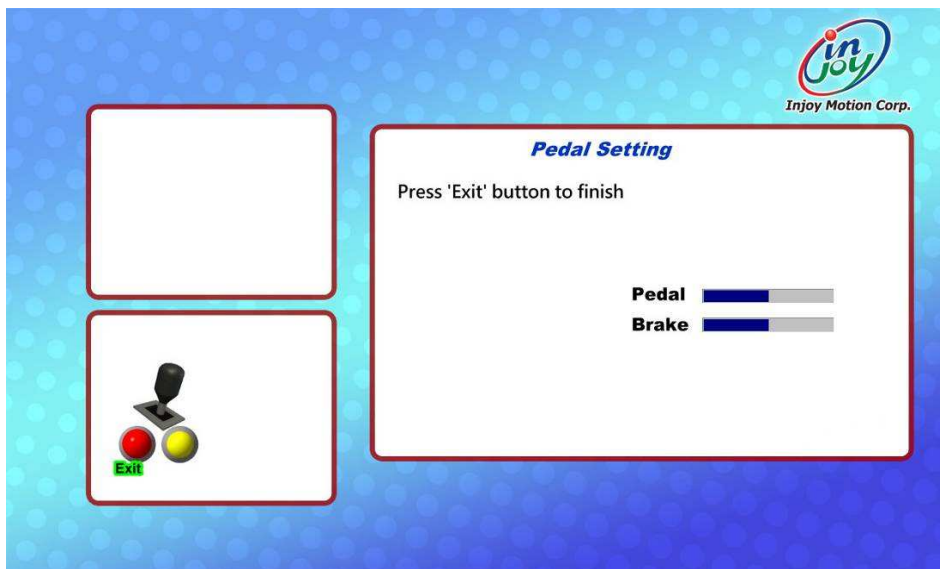

3.4 Volume setting

“Game Volume” can adjust the system volume, suggestion 75~85.

“Idle Movie Volume” can adjust Idle Movie volume, suggestion 15~35.

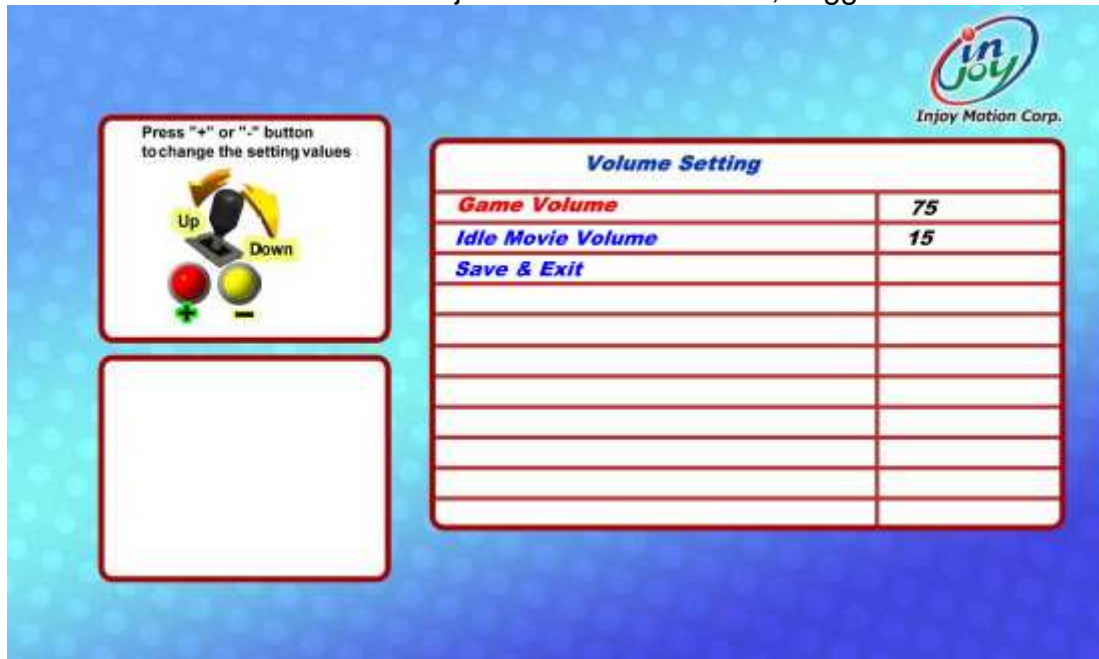

3.5 Device Test

When into device test, 5 airbags will be aerated, and we can check the their conditions.

Normal (Full)



Broken (Soft)



Check if all device work properly as well.

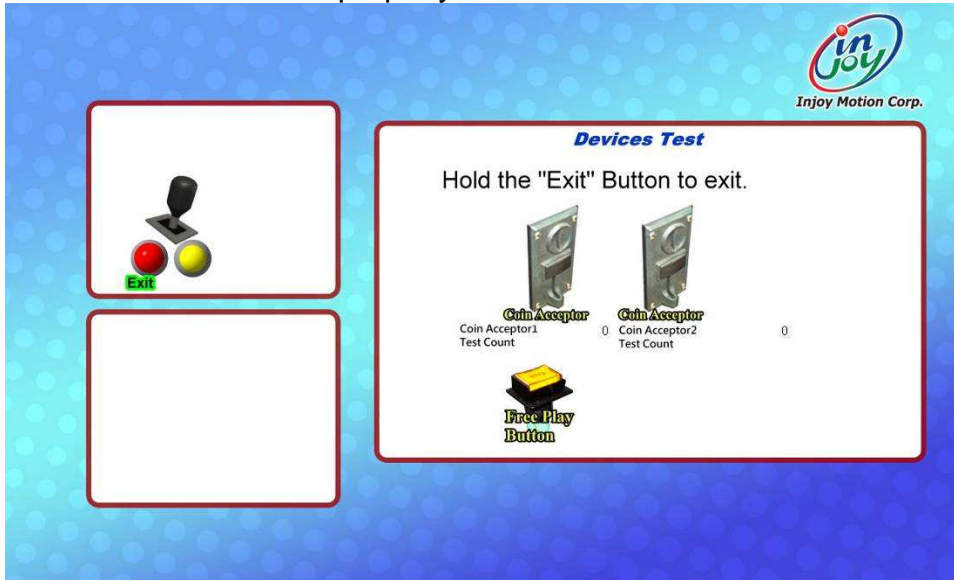

3.6 Save & Exit

After the setup is completed, please select “Save & Exit”, and then select “Yes”. Lastly, switch red Operator menu switch to “O” position and turn OFF the machine. Then wait for 30secs and turn ON machine power.

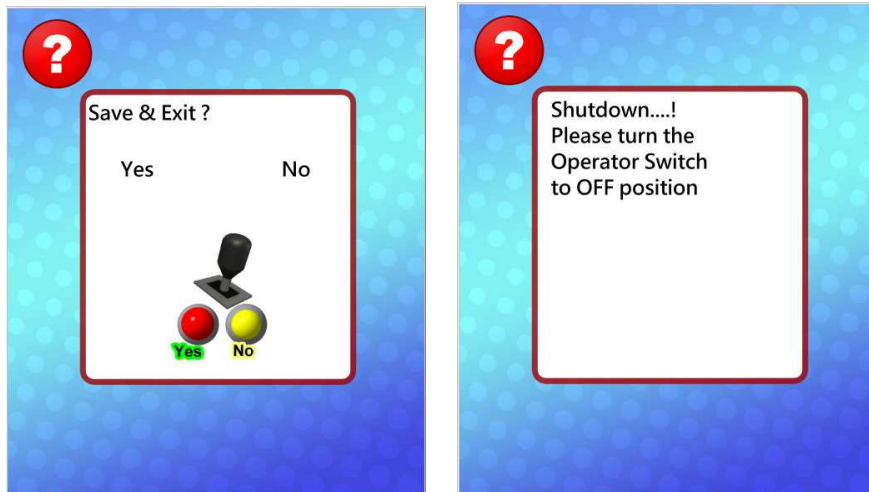

3.7 Free Key

Open coin box, press "Free Key" button allows you to play game for free once.



3.8 System Recovery

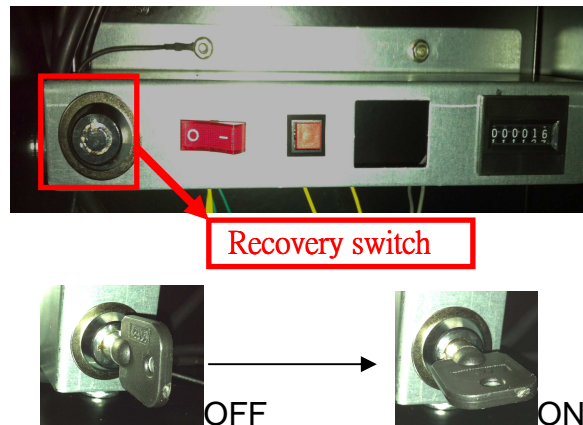

Step1: When the screen shows “insert coin”, Use the key specified for recovery switch and turn it right.

Step2: Turn the machine off, wait for 30 seconds

Step3: Turn on the power, and you will see screen as below. When recovery is in progress, do not turn off the power, or the system will be destroyed permanently.

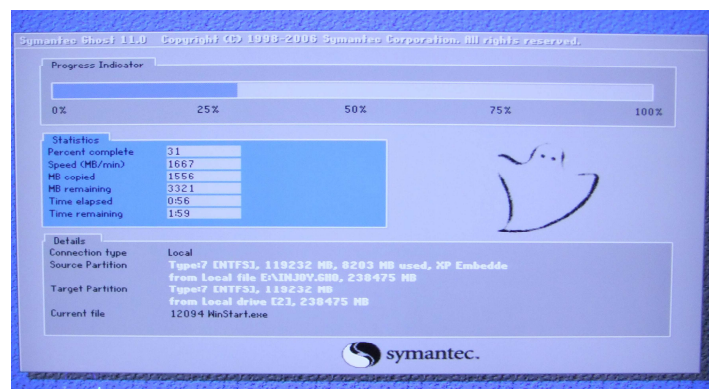

Step4: If success, will see screen as below.

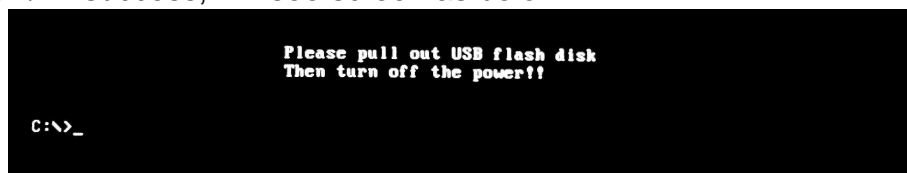

Step5: Turn the key left and take it out.

Step6: Turn the machine off, wait for 30 seconds

Step7: Turn on the power. <Finish>

4. Trouble shooting

4.1 Error code

EC001

Description	The steering wheel fails in automatic calibration. (The steering wheel does not rotate.)	
	Check steps	Troubleshooting
	1. Check out if the belt is broken or come off.	1. If the belt is come off, please check out the reason. 2. If the belt is broken or wear out, please replace it with the new one with the same specifications.
	2. Check out if the 24V power supplier is out of work.	1. Check out if the cockpit card connector is off. 2. Replace the 24V power supplier.
	3. Check out if the 24V power is connected to the cockpit card. 4. Check out if the cockpit card has output when the machine is booting up.	1. If there is a 24VDC power connected to the cockpit card but there is no output to the motor, please replace the cockpit card. 2. If a voltage is transmitted to the motor and the motor does not rotate, please change the motor.
	5. The cockpit card is out of order.	Replace the cockpit card

EC002

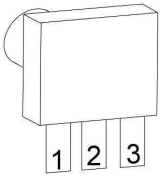
Description	The automatic calibration of the steering wheel is done, but the value is wrong.	
	Check steps	Troubleshooting
	1. Check out if the potentiometer pins of the steering wheel are connected inversely. (Measure the potentiometer resistance values on feet 2 and 3 with an electric meter. The potentiometer resistance increases as the steering wheel moves clockwise, and decreases as the steering wheel moves counterclockwise.) 	If the changes in the potentiometer resistance are reversed, please swap foot 1 and foot 3. If there is no change in the potentiometer resistance, please replace the potentiometer.
	2. The cockpit card breaks down.	Replace the cockpit card.

EC003

Description	The cockpit card can not be recognized.	
	Check steps	Troubleshooting
	1. Check out if the USB port of the IPC motherboard is out of order.	Replace the USB connector to the other USB port.
	2. Check out if the USB signal line malfunctions.	Replace the USB signal line.
	3. The cockpit card malfunctions.	Replace the cockpit card.

EC004

Description	The communication of the Cockpit Card USB is disrupted.	
	Check steps	Troubleshooting
	1. Check out if the USB signal line malfunctions.	Change the USB signal line and check out if the ground wire of the motor is fixed on the plate.
	2. The cockpit card malfunctions.	Replace the cockpit card.

EC005

Description	Pedal calibration error	
	Check steps	Troubleshooting
	1. Use an electric meter to check out if the pedal potentiometer exceeds the dead zone. (The resistance value varies from maximum to minimum or from minimum to maximum when the pedal is press.)	Make sure the pedal potentiometer does not exceed the dead zone, re-enter the game operation menu to calibrate again.
	2. Use an electric meter to check out if the pedal potentiometer is normal. (The resistance value will increase or decrease when the pedal is pressed.)	Change the potentiometer of the pedal, and enter the game operation menu to calibrate again.

EC006

Description	Brake calibration error	
	Check steps	Troubleshooting
	1. Use an electric meter to check out if the brake potentiometer exceeds the dead zone. (The resistance value varies from maximum to minimum or from minimum to maximum when the pedal is press.)	1. Make sure the brake potentiometer does not exceed the dead zone, re-enter the game operation menu to calibrate again. 2. Change the brake potentiometer, and enter the game operation menu to calibrate again.
	2. Use an electric meter to check out if the brake potentiometer is normal. (The resistance value will increase or decrease when the pedal is press.)	Change the brake potentiometer, and enter the game operation menu to calibrate again.

EC007

Description	Automatic calibration of the steering wheel fails.	
	Check steps	Troubleshooting
	1. Use an electric meter to check out if the wheel potentiometer is normal. (The resistance value will increase or decrease when the steering wheel turns left and right.)	Replace the wheel potentiometer. (Please note if the wheel potentiometer exceed the dead zone the wheel potentiometer is to be replaced.)
	2. The cockpit card malfunctions.	Replace the cockpit card.

4.2 General issues

Problem	Solution
No power	Make sure the power connector is connected and have correct voltage. Make sure all switches are "ON".
	Check the distribution switch is "ON".
PC can not recognize token	Reconnect the token and restart.
	Change token to another USB port.
	Contact Injoy Motion Corp. to change token.
PC shut down suddenly	Using a separate power supply
	Make sure the computer power cord and switch work properly.
	Reconnect RAM, VGA card
	Change the PC power supply.
PC Crash	Restart the PC.
Machine overheat	Check all fans work properly.
	Ensure no objects block the vents.
Can not insert coin	Remove stuck coins.
	Go to operator menu check coin setting.
	Reinstall reference coin.
Can not recover system	Make sure recover USB disk is connect to the PC.
	Contact Injoy Motion Corp. to change the Hard Disk.
Can not enter operator menu	Check wire connecting between cockpit card and OP switch.
	Recover the system
	Contact Injoy Motion Corp. to change the cockpit card.
Free Key not functional	Check wire connecting.
	Contact Injoy Motion Corp. to change the cockpit card.

4.3 Display

Problem	Solution
No screen	Update VGA driver.
	Check screen wire connecting.
	Check VGA card wire connecting.
	Contact Injoy Motion Corp. to change the VGA card.
	Contact Injoy Motion Corp. to change the LCD.
No screen and no sound	Ensure PC power input is correct. Ensure PC power switch is "ON" Restart the PC.
	Recover the system
	Contact Injoy Motion Corp. to change the Hard disk.
Lag problem	Update VGA driver and restart the PC.
	Contact Injoy Motion Corp. to change the VGA card.
Resolution is not right	Change resolution to 1280x768.
LCD abnormal	Contact Injoy Motion Corp. to change the LCD.

4.4 Sound

Problem	Solution
No sound	Go to operator menu change volume setting. Adjust amplifier volume.
	Check wire connecting.
	Contact Injoy Motion Corp. to change the amplifier.
Poor sound	Contact Injoy Motion Corp. to change the amplifier.

4.5 Control

Problem	Solution
START / VIEW Button failure	Change micro switch.
	Check wire connecting.
	Contact Injoy Motion Corp. to change the cockpit card.
Wheel failure	Check motor wire connecting.
	Contact Injoy Motion Corp. to change the motor.
	Change the potentiometer.
	Contact Injoy Motion Corp. to change the cockpit card.
Gear not working	Check wire connecting and micro switches.
	Contact Injoy Motion Corp. to change the cockpit card.
Pedal and brake not working	Go to operator menu check pedal setting and do calibration.
	Change the potentiometer.
	Contact Injoy Motion Corp. to change the cockpit card.
Airbag not working in the game.	Go to operator menu device test and check if all airbags work fine.
	Make sure the power switch of the air compressor is ON.
	Check if air compressor works properly.
	Check the 12V on the SSR card near the cockpit card.
	Contact Injoy Motion Corp. to change air compressor or SSR card.

4.6 Link

Problem	Solution
Can not link	Make sure cable is good. Contact Injoy Motion Corp. to Change the cable.
	Make sure no duplicate IP address.
	Make sure no duplicate computer name.
	Make sure all software is the same version.

Main Parts

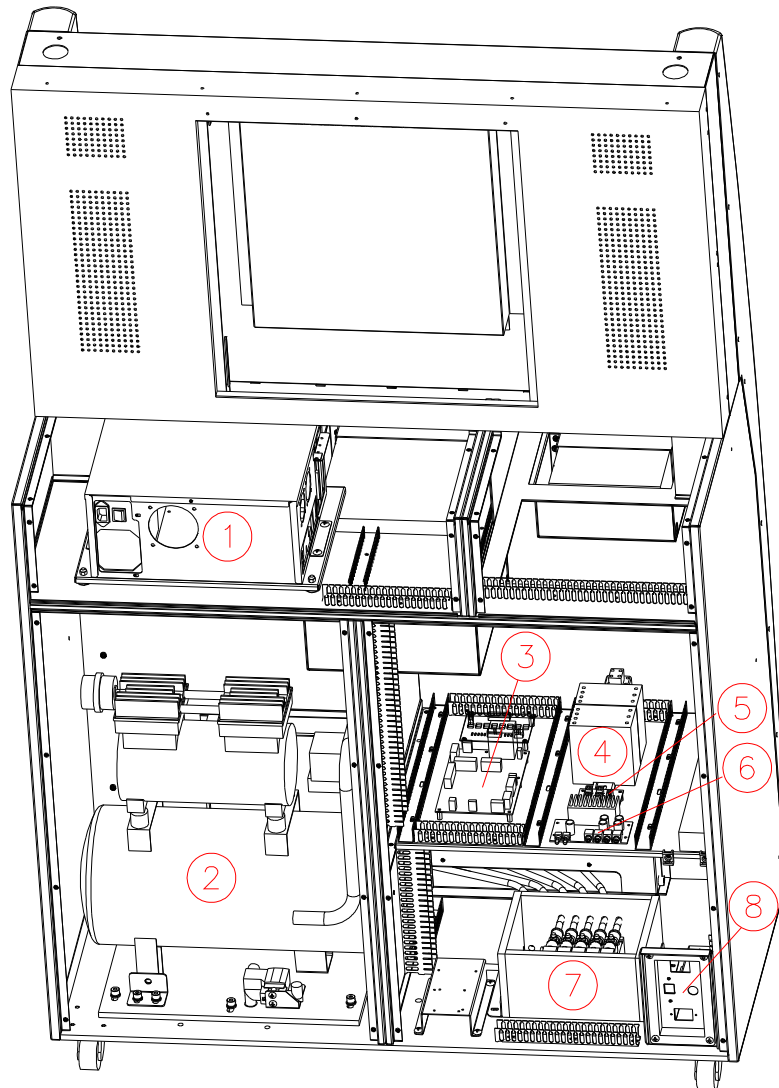

①	PC	⑤	Extension card
②	Air compressor	⑥	Transformer (only for 220V machine)
③	Cockpit card	⑦	Pneumatic valve
④	Power supply	⑧	Input AC power

4.7 Technical Support

Service center: Injoy Motion Corp.

Phone: +886-2-2267-6317

Fax: +886-2-2267-5906

Time: 9:00AM~6:00PM (GMT+8), Monday to Friday

E-mail: support@injoymotion.com

When you contact technical support, please provide the following information so that we can understand the situation and solve your problem as soon as possible, thank you for your cooperation:

- 1、Machine serial number _____
- 2、Software version _____
- 3、Error code _____
- 4、Problem Description _____
- 5、Any changes to the system _____

Appendix A: How to change potentiometer in pedal module

Pedal module:

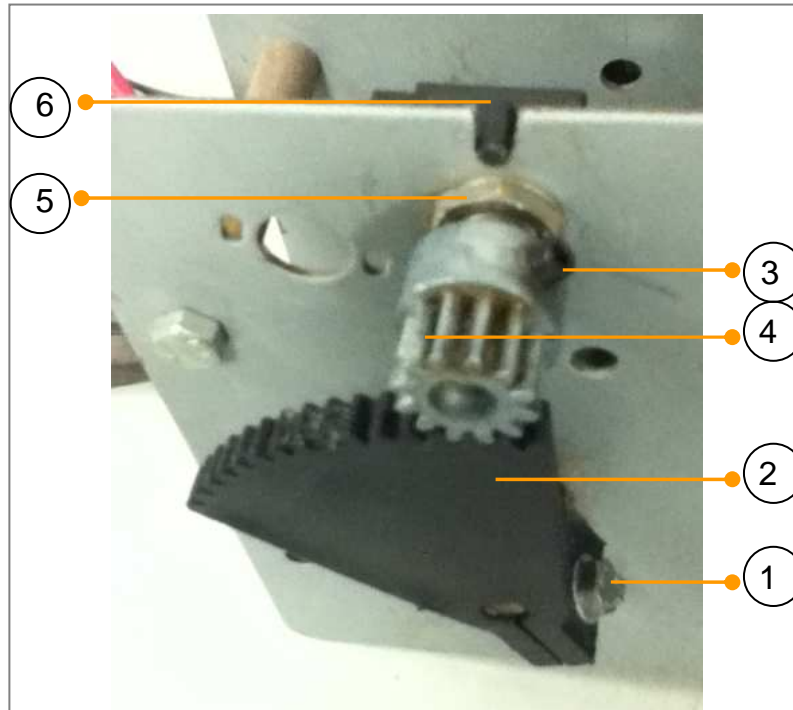

1. Remove potentiometer:

Step1: Loosen and remove screw①.

Step2: Take off gear②.

Step3: Loosen screw③.

Step4: Take off gear④.

Step5: Loosen and remove the washer⑤.

Step6: Take out potentiometer⑥.

2. Install potentiometer:

Step1: Put in potentiometer⑥.

Step2: Placed Washer⑤ and fix it.

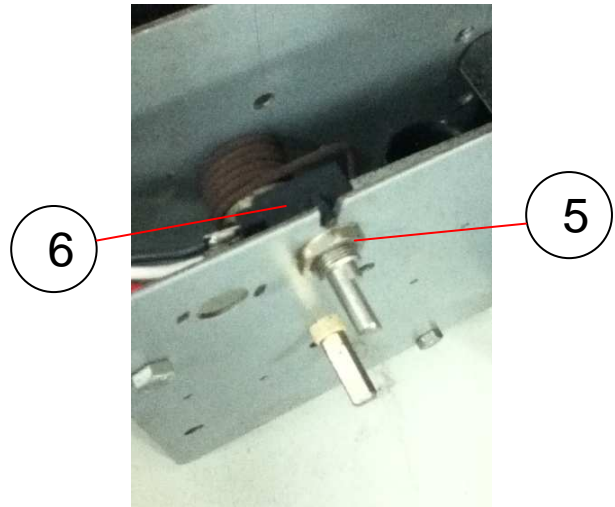

Step3: Use meter to measure resistance value between pin2 and pin3 of the potentiometer, and make sure 1.6Kohm for pedal, 2.6Kohm for brake.

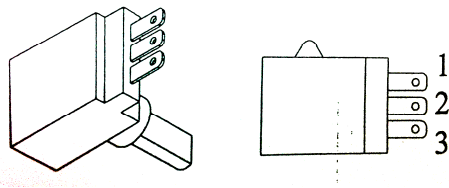

Step4: Install gear④.

Step5: Fix screw③.

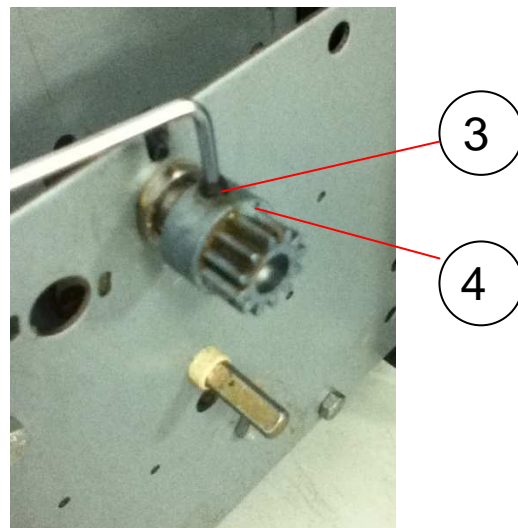

Step6: Install gear②, and make sure gear④ close to second tooth of the gear②.

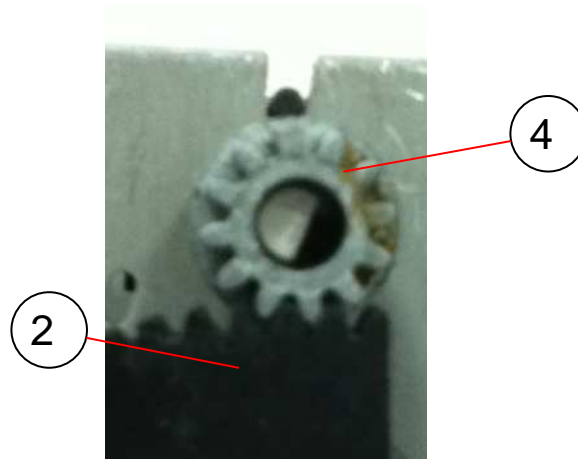

Step7: Install screw① and fix it.

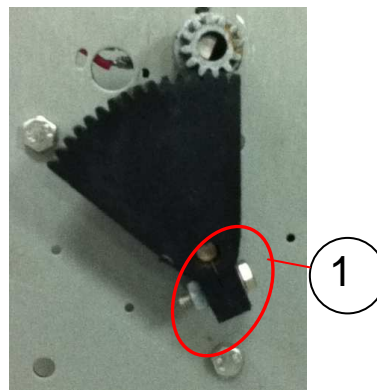

Step8: Use meter to measure resistance value between pin2 and pin3 of the potentiometer. <Finish>

Release accelerator should be 1.6 Kohm
Press the accelerator should be 3.2 Kohm

Release the brake should be 2.6 Kohm
Press the brake should be 3.5 Kohm

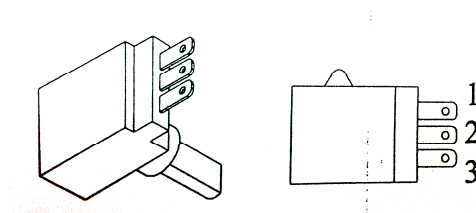

Appendix B: How to connect tubes

1. Insert

A. Insert the tube to the end.

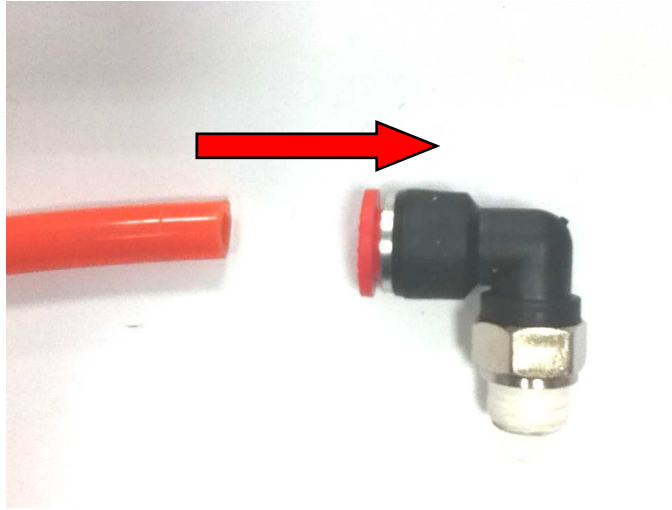

B. Finish



2. Pull out

A. Push the releasing ring in front of the quick coupler.

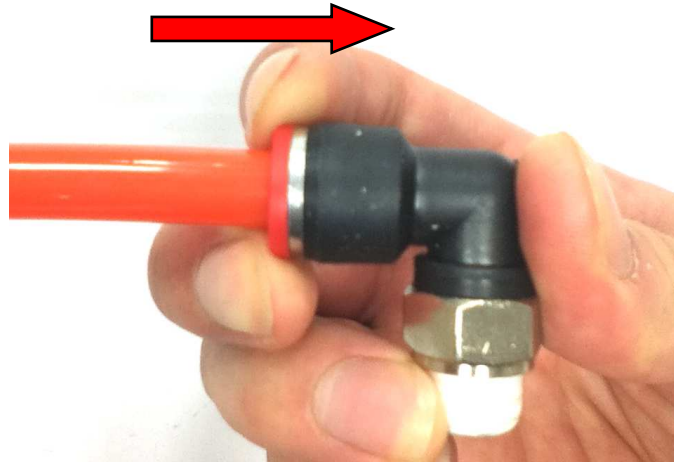

B. Pull out the tubes



Appendix C: How to change airbag

A. Introduction B. Change Airbag no.1~4 C. Change Airbag no.5

A. Introduction

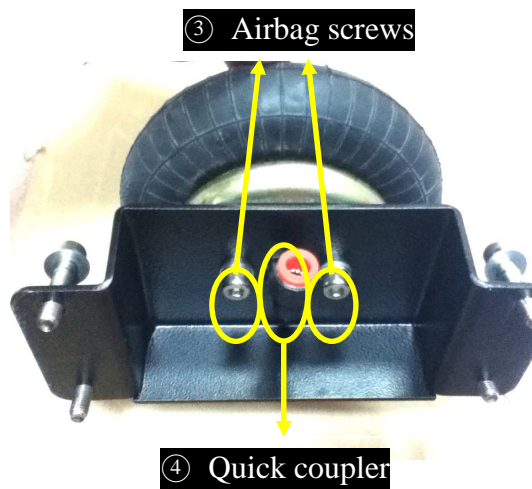
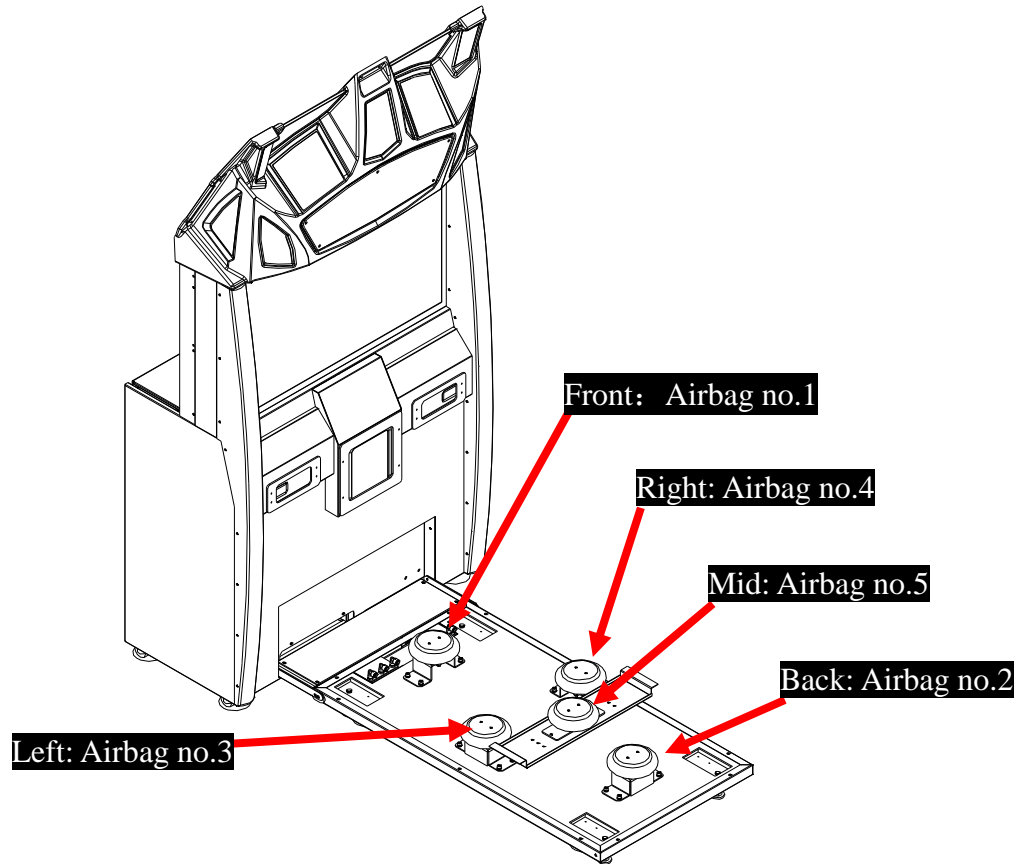

B. Change Airbag no.1~4 (Take changing airbag no. 3 for example)

Step1: Use solid object to support the motion base.



Step2: Remove 2 airbag screws.

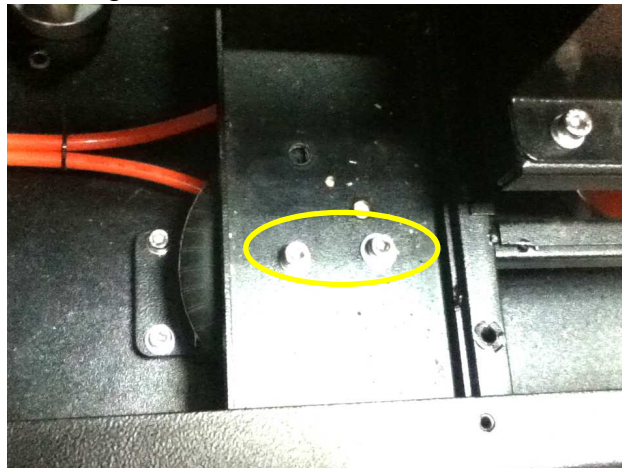

Step3: Remove 4 fixation screws.



Step4: Remove the tube (refer to Appendix B) .

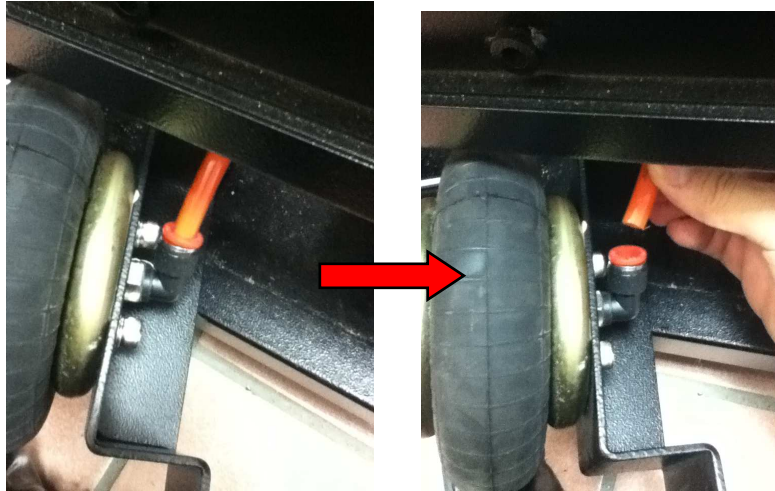

Step5: Remove 2 airbag screws and quick coupler.



Step6: All Components are as below.

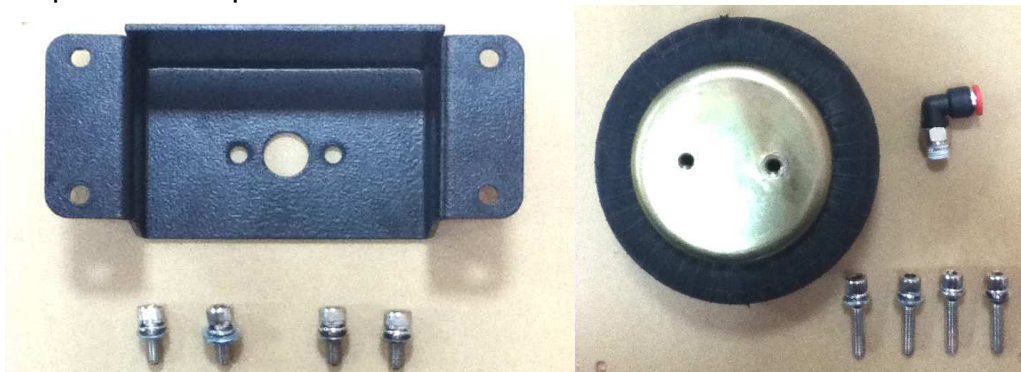

Step7: After change airbag, tighten 2 airbag screws and quick coupler.

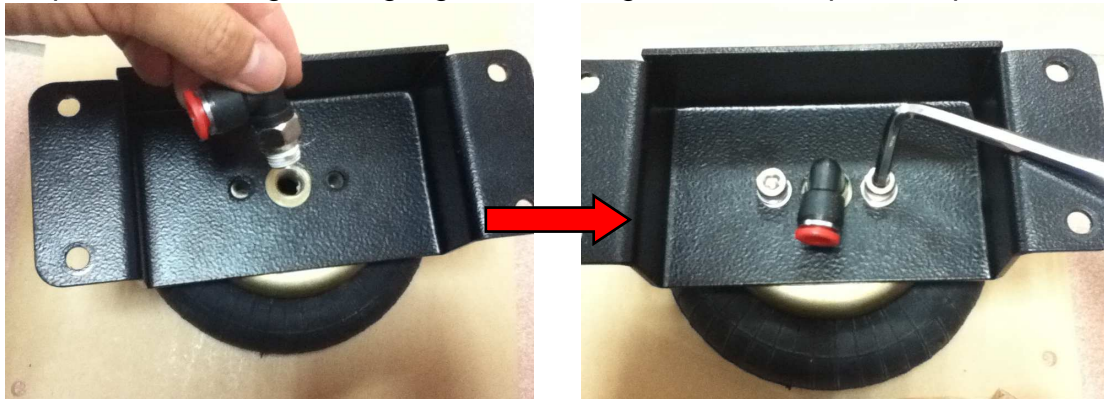

Step8: Install 4 fixation screws.

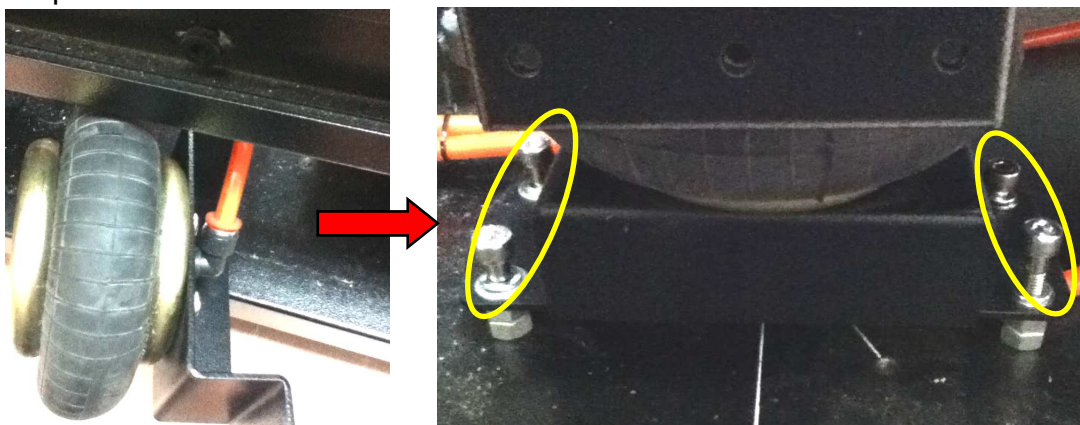

Step9: Install 2 airbag screws. <Finish>

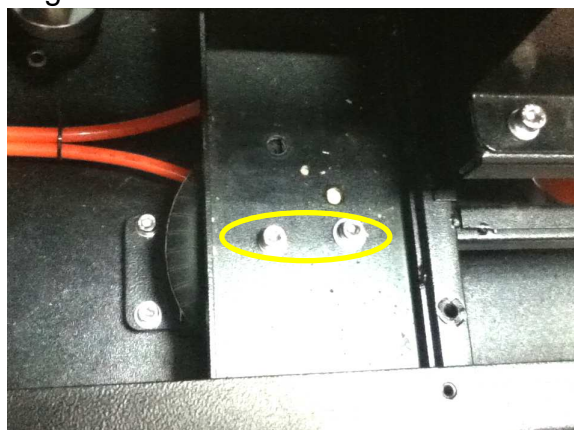

C. Change Airbag no.5

Step1: Remove 4 seat fixation screws.



(Left)

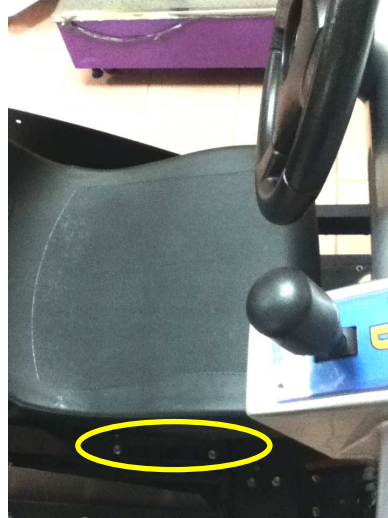

(Right)

Step2: Remove the seat.



Step3: Remove 2 airbag screws.



Step4: Open the seat base, and find the airbag 5.

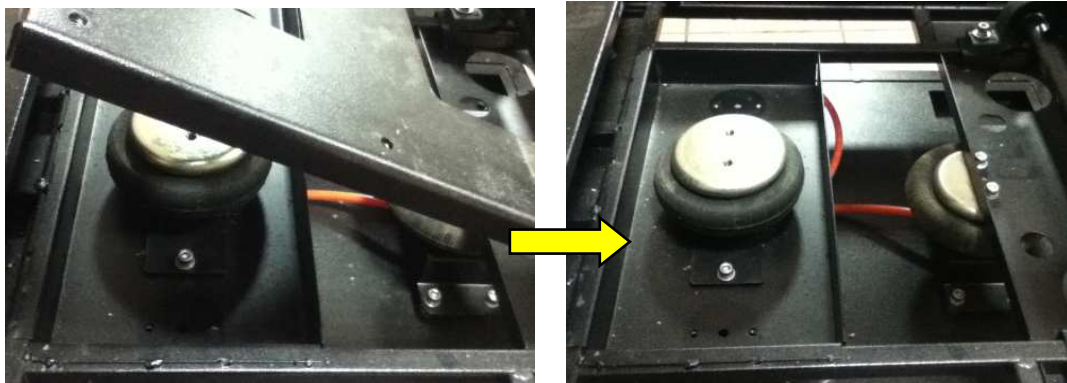

Step5: Remove 2 fixation screws.



Step6: Remove the tube and screws, and change airbag.

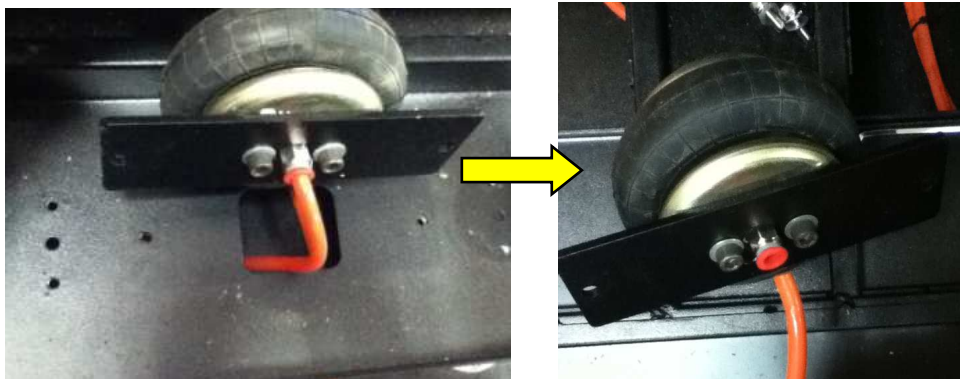

Step7: After changing, lock 2 airbag screws, tube, and 2 fixation screws.

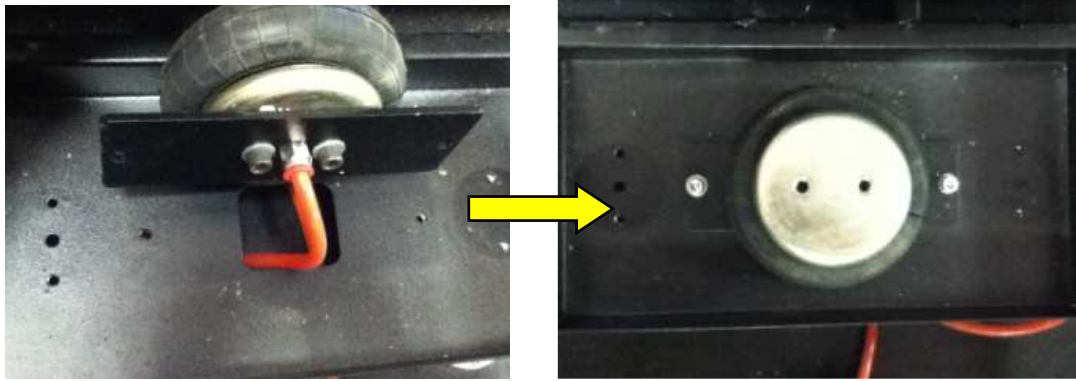

Step8: Cover the seat base, tighten 2 airbag screws.

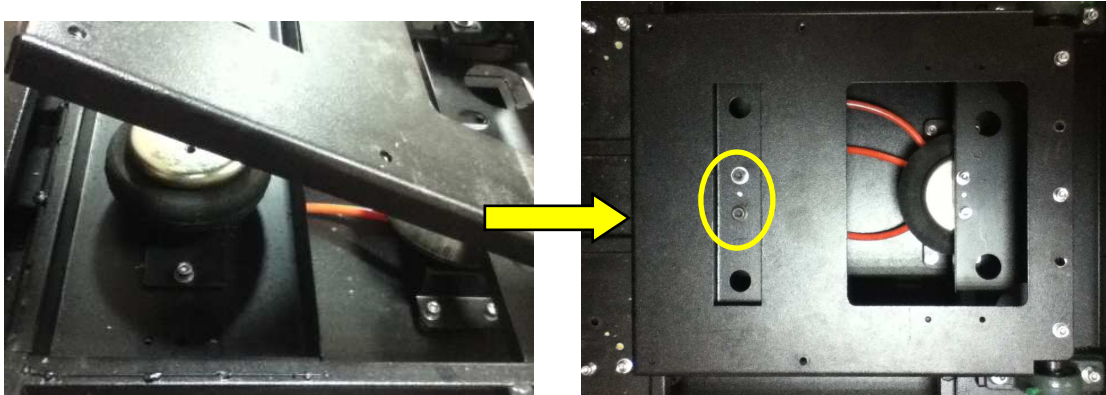

Step9: Install the seat back. <Finish>

Appendix D: Clean the drain valve

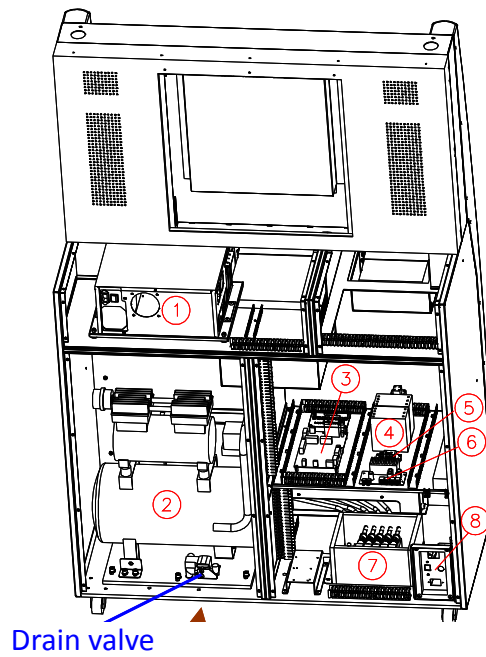

Follow the steps below to clean the pathway inside the drain valve:

1. Remove the metal piece



2. Remove the body-part



3. Remove 4 screws



4. Remove the core-part



5. Clean the two-way valve inside



6. Install the core-part



7. Install 4 screws



8. Install the body-part



9. Install the metal piece <Finish>



Appendix E: Connection for coin acceptor

LINE-AP-COIN is the main cable for the coin acceptor. There are three branches for LINE-AP-COIN:

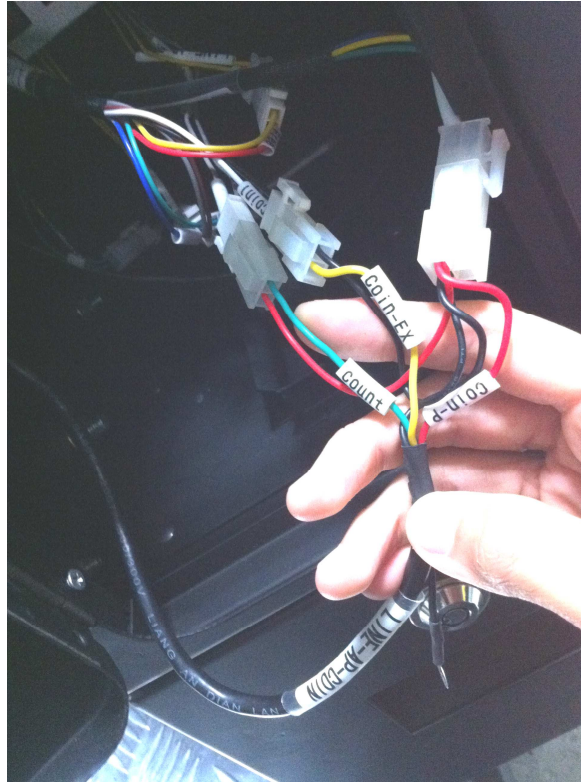

1. **“Coin-P”** input power 12V to the coin acceptor.

Connector assignment:

- Pin1: 12VDC (red)
- Pin2: ground (black)
- Pin3: none
- Pin4: none

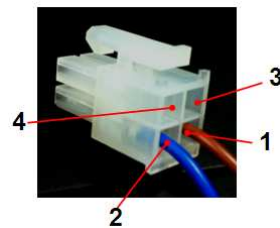

2. **“Coin-Ex”** output credit signal from the coin acceptor

Connector assignment:

- Pin1: credit pulse
- Pin2: ground (black)

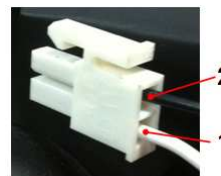

3. **“Count”** output coin count to the counter

Connector assignment:

- Pin1: coin count
- Pin2: 12VDC (red)

