

# Commercial Microwave Oven INSTRUCTION MANUAL

Model : 1817G1A  
2117G1A  
1217G1A



Read these instructions carefully before using your microwave oven, and keep it for reference  
If you follow the instructions, your oven will provide you with many years of dependable service.

READ CAREFULLY



# CONTENTS

## IMPORTANT SAFEGUARDS

PRECAUTIONS	3
IMPORTANT SAFETY INSTRUCTIONS	3
GROUNDING INSTRUCTIONS	5
RADIO INTERFERENCE	6
SAFETY	6

---

## BEFORE THE FIRST USE

UTENSILS	7
----------	---

---

## PARTS & FEATURES

NAMES OF PARTS & ACCESSORIES	9
INSTALLATION	10

---

## OPERATION INSTRUCTION

CONTROL PANEL	11
DEFAULT COOK TIMES	11
USER OPTION	12
FUNCTION INSTRUCTION	13

---

## CLEANING & MAINTENANCE

HOW TO SET THE U DISK	19
CLEANING INSTRUCTION	22
MAINTENANCE	25

# SPECIFICATIONS

Model:	1817G1A	Oven Capacity:	0.6 Cu.ft.
Rated Voltage:	208/230V~60Hz	External dimensions:	16.5x22.2x13.4 inch
Rated Input Power:	2800 W	Net Weight:	Approx. 66.1 lbs
Rated Output Power:	1800 W		

Model:	2117G1A	Oven Capacity:	0.6 Cu.ft.
Rated Voltage:	208/230V~60Hz	External dimensions:	16.5x22.2x13.4 inch
Rated Input Power:	3200 W	Net Weight:	Approx. 66.1 lbs
Rated Output Power:	2100 W		

Model:	1217G1A	Oven Capacity:	0.6 Cu.ft.
Rated Voltage:	120V~60Hz	External dimensions:	16.5x22.2x13.4 inch
Rated Input Power:	2150 W	Net Weight:	Approx. 66.1 lbs
Rated Output Power:	1200 W		

# PRECAUTIONS TO AVOID POSSIBLE EXPOSURE TO EXCESSIVE MICROWAVE ENERGY

---

- (a) Do not attempt to operate this oven with the door open since open-door operation can result in harmful exposure to microwave energy. It is important not to defeat or tamper with the safety interlocks.
- (b) Do not place any object between the oven front face and the door or allows soil or cleaner residue to accumulate on sealing surfaces.
- (c) Do not operate the oven if it is damaged. It is particularly important that the oven door close properly and that there is no damage to the:
  - (1) DOOR (bent)
  - (2) HINGES AND LATCHES (broken or loosened)
  - (3) DOOR SEALS AND SEALING SURFACES
- (d) The oven should not be adjusted or repaired by anyone except properly qualified service personnel.

## IMPORTANT SAFETY INSTRUCTIONS

---

When using electrical appliances basic safety precautions should be followed, including the following:

### **WARNING** - To reduce the risk of burns, electric shock, fire, injury to persons or exposure to excessive microwave energy:

1. Read all instructions before using the appliance.
2. Read and follow the specific: "PRECAUTIONS TO AVOID POSSIBLE EXPOSURE TO EXCESSIVE MICROWAVE ENERGY" found on page 3.
3. This appliance must be grounded. Connect only to properly grounded outlet. See "GROUNDING INSTRUCTIONS" found on page 5.
4. Install or locate this appliance only in accordance with the provided installation instructions.
5. Some products such as whole eggs and sealed containers - for example, closed glass jars - are able to explode and should not be heated in this oven.
6. Use this appliance only for its intended use as described in the manual. Do not use corrosive chemicals or vapors in this appliance. This type of oven is specifically designed to heat, cook or dry food. It is not designed for industrial or laboratory use.
7. As with any appliance, close supervision is necessary when used by children.
8. Do not operate this appliance if it has a damaged cord or plug, if it is not working properly, or if it has been damaged or dropped.

# IMPORTANT SAFETY INSTRUCTIONS

---

9. This appliance should be serviced only by qualified service personnel. Contact nearest authorized service facility for examination, repair, or adjustment.
10. Do not cover or block any openings on the appliance.
11. Do not store this appliance outdoors. Do not use this product near water - for example, near a kitchen sink, in a wet basement, near a swimming pool, or similar location.
12. Do not immerse cord or plug in water.
13. Keep cord away from heated surface.
14. Do not let cord hang over edge of table or counter.
15. When cleaning surfaces of door and oven that comes together enclosing the door, use only mild, nonabrasive soaps, or detergent applied with a sponge or soft cloth.
16. To reduce the risk of fire in the oven cavity:
  - 1). Do not overcook food. Carefully attend appliance when paper, plastic, or other combustible materials are placed inside the oven to facilitate cooking.
  - 2) Remove wire twist-ties from paper or plastic bag before placing bag in oven.
  - 3). If material inside of the oven ignite, keep oven door closed, oven off, and disconnect the power cord, or shut off power at the fuse or circuit breaker panel.
  - 4). Do not use the cavity for storage purposes. Do not leave paper products, cooking utensils, or food in the cavity when not in use.
17. Liquids, such as water, coffee, or tea are able to be overheated beyond the boiling point without appearing to be boiling. Visible bubbling or boiling when the container is removed from the microwave oven is not always present.

## **THIS COULD RESULT IN VERY HOT LIQUID SUDDENLY BOILING OVER WHEN THE CONTAINER IS DISTURBED OR A UTENSIL IS INSERTED INTO THE LIQUID.**

To reduce the risk of injury to persons:

- 1). Do not overheat the liquid.
- 2). Stir the liquid both before and halfway through heating it.
- 3). Do not use straight-sided containers with narrow necks.
- 4). After heating, allow the container to stand in the microwave oven for a short time before removing the container.
- 5). Use extreme care when inserting a spoon or other utensil into the container.

## **SAVE THESE INSTRUCTIONS**

# GROUNDING INSTRUCTIONS

---

This appliance must be grounded. In the event of an electrical short circuit, grounding reduces the risk of electric shock by providing an escape wire for the electric current. This appliance is equipped with a cord having a grounding wire with a grounding plug. The plug must be plugged into an outlet that is properly installed and grounded.

**WARNING - Improper use of the grounding can result in a risk of electric shock.**

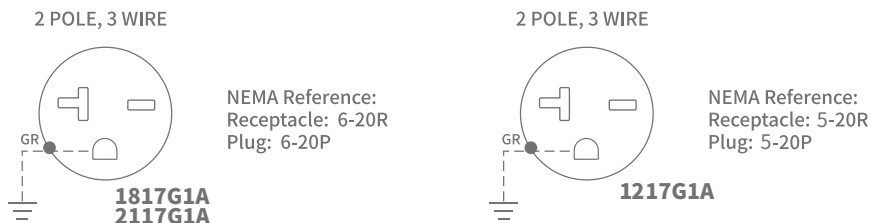

Consult a qualified electrician or serviceman if the grounding instructions are not completely understood, or if doubt exists as to whether the appliance is properly grounded. If it is necessary to use an extension cord, use only a 3-wire extension cord that has a 3-blade grounded plug, and 3-slot receptacle that will accept the plug on the appliance. The marked rating of the extension cord shall be equal to or greater than the electrical rating of the appliance.

## **DANGER - Electric Shock Hazard**

Touching some of the internal components can cause serious personal injury or death. Do not disassemble this appliance.

## **WARNING - Electric Shock Hazard**

Improper use of the grounding can result in electric shock. Do not plug into an outlet until appliance is properly installed and grounded.

1. A short power-supply cord is provided to reduce the risks resulting from becoming entangled in or tripping over a longer cord.
2. Longer cord sets or extension cords are available and may be used if care is exercised in their use.
3. If a long cord or extension cord is used:
  - 1). The marked electrical rating of the cord set or extension cord should be at least as great as the electrical rating of the appliance.
  - 2). The extension cord must be a grounding-type 3-wire cord.
  - 3). The longer cord should be arranged so that it will not drape over the counter top or tabletop where it can be pulled on by children or tripped over unintentionally.

# RADIO INTERFERENCE

---

1. Operation of the microwave oven may cause interference to your radio, TV or similar equipment.
2. When there is interference, it may be reduced or eliminated by taking the following measures:
  - 1). Clean door and sealing surface of the oven.
  - 2). Reorient the receiving antenna of radio or television.
  - 3). Relocate the microwave oven with respect to the receiver.
  - 4). Move the microwave oven away from the receiver.
  - 5). Plug the microwave oven into a different outlet so that microwave oven and receiver are on different branch circuits.

# SAFETY

---

1. The oven must be on a leveled surface.
2. The turntable and turntable roller rest must be in the oven during cooking. Place the cookware gently on the turntable and handle it carefully to avoid possible breakage. Incorrect use of browning dish may cause the turntable to break.
3. Use only the specified bag size when using Direct Access Popcorn.
4. The oven has several built-in safety switches to ensure that the power remains off
5. when the door is open. Do not tamper with these switches.
6. Do not operate the microwave oven empty. Operating the oven with no food or food that is extremely low in moisture can cause fire, charring or sparking.
7. Do not cook bacon directly on the turntable. Excessive local heating of the turntable may cause the turntable to break.
8. Do not heat baby bottles or baby food in the microwave oven. Uneven heating may occur and could cause physical injury.
9. Do not heat narrow-necked containers, such as syrup bottles.
10. Do not attempt to deep-fry in your microwave oven.
11. Do not attempt home canning in this microwave oven, as it is impossible to be sure all contents of the jar have reached boiling temperature.
12. Do not use this microwave oven for commercial purpose. This microwave oven is made for household use only.

- 
13. To prevent delayed eruptive boiling of hot liquids and beverages or scalding yourself, stir liquid before placing the container in the oven and again halfway through cooking time. Let stand in the oven for a short time and stir again before removing the container.
  14. Use carefully when cooking food in the microwave oven to avoid burning due to excessive cooking.
  15. When the appliance is operated in the combination mode, children should only use the oven under adult supervision due to the temperatures generated.  
Failure to maintain the oven in a clean condition could lead to deterioration that
  16. could adversely affect the life of the appliance and possibly result in a hazardous situation.

## UTENSILS

---

### **CAUTION - Personal Injury Hazard**

Tightly-closed utensils could explode. Closed containers should be opened and plastic pouches should be pierced before cooking.

See the instructions on "Materials you can use in microwave oven or to be avoided in microwave oven."

There may be certain non-metallic utensils that are not safe to use for microwaving. If in doubt, you can test the utensil in question following the procedure below.

### **Utensil Test:**

1. Fill a microwave-safe container with 1 cup of cold water (250ml) along with the utensil in question.
2. Cook on maximum power for 1 minute.
3. Carefully feel the utensil. If the empty utensil is warm, do not use it for microwave cooking.
4. Do not exceed 1 minute cooking time.



# Materials you can use in microwave oven

UTENSILS	REMARKS
Aluminum foil	Shielding only. Small smooth pieces can be used to cover thin parts of meat or poultry to prevent overcooking. Arcing can occur if foil is too close to oven walls. The foil should be at least 1 inch (2.5cm) away from oven walls.
Browning dish	Follow manufacturer* instructions. The bottom of browning dish must be at least 3/16 inch (5mm) above the turntable. Incorrect usage may cause the turntable to break.
Dinnerware	Microwave-safe only. Follow manufacturer's instructions. Do not use cracked or chipped dishes.
Glass jars	Always remove lid. Use only to heat food until just warm. Most glass jars are not heat resistant and may break.
Glassware	Heat-resistant oven glassware only. Make sure there is no metallic trim. Do not use cracked or chipped dishes.
Oven cooking bags	Follow manufacturer* instructions. Do not close with metal tie. Make slits to allow steam to escape.
Paper plates and cups	Use for short*erm cooking/warming only. Do not leave oven unattended while cooking.
Paper towels	Use to cover food for reheating and absorbing fat. Use with supervision for a short-term cooking only.
Parchment paper	Use as a cover to prevent splattering or a wrap for steaming.
Plastic	Microwave-safe only. Use to cover food during cooking to retain moisture. Do not allow plastic wrap to touch food.
Plastic wrap	Microwave-safe only. Follow the manufacturer* instructions. Should be labeled "Microwave Safe". Some plastic containers soften, as the food inside gets hot. "Boiling bags" and tightly closed plastic bags should be slit, pierced or vented as directed by package.
Thermometers	Microwave-safe only (meat and candy thermometers).
Wax paper	Use as a cover to prevent splattering and retain moisture.

# Materials to be avoided in microwave oven

UTENSILS	REMARKS
Aluminum tray	May cause arcing. Transfer food into microwave-safe dish.
Food carton with metal handle	May cause arcing. Transfer food into microwave-safe dish.
Metal or metal-trimmed utensils	Metal shields the food from microwave energy. Metal trim may cause arcing.
Metal twist ties	May cause arcing and could cause a fire in the oven.
Paper bags	May cause a fire in the oven.
Plastic foam	Plastic foam may melt or contaminate the liquid inside when exposed to high temperature.
Wood	Wood will dry out when used in the microwave oven and may split or crack.

# SETTING UP YOUR OVEN

---

## Names of Oven Parts and Accessories

Remove the oven and all materials from the carton and oven cavity. Your oven comes with the following accessories:

Instruction Manual 1  
Warranty card 1

- A) Control panel
- B) Observation window
- C) Safety interlock system
- D) Ceramic bottom plate
- E) Filter

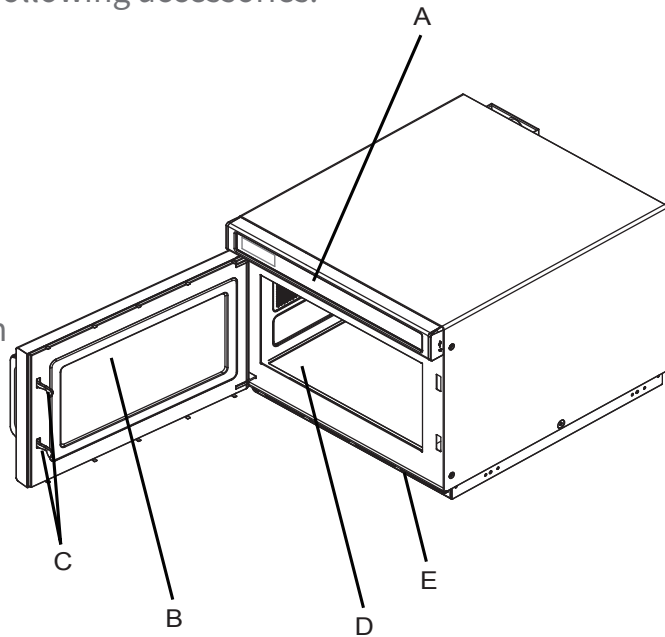

- Note:**
- 1) Don't press the ceramic bottom plate forcibly.
  - 2) Take and put the utensils gently during the operation in order to avoid damage to the ceramic .
  - 3) After using, don't touch the ceramic bottom plate by hand in order to avoid high temperature scald.

## Countertop Installation

---

Remove all packing material and accessories. Examine the oven for any damage such as dents or broken door. Do not install if oven is damaged.

Cabinet: Remove any protective film found on the microwave oven cabinet surface.

# Countertop Instructions

## INSTALLATION

1. Select a level surface that provide enough open space for the intake and/or outlet vents (Figure1).

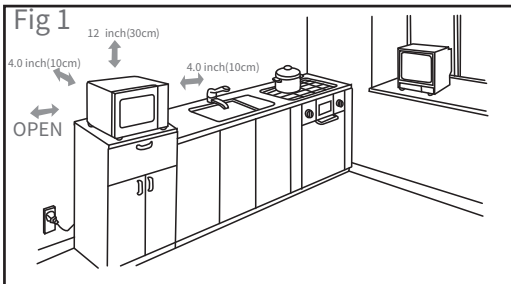

A 4.0-inch spacing should be kept between the appliance and right and back walls, and a 12-inch spacing kept on the top. Never dismantle the appliance's feet, nor block the air intake and exhaust opening. The left side must be open.

- 1) Blocking the intake and/or outlet openings can damage the oven.
- 2) Place the oven as far away from radios and TV as possible. Operation of microwave oven may cause interference to your radio or TV reception.
- 3) Plug your oven into a proper outlet. (See Page 5) Be sure the Voltage and the frequency is the same as the voltage and the frequency on the rating label.
- 4) Warning: The plug socket, electric appliances or the appliance which are liable to be effected by heat and moisture should be kept away from any vents on the oven.

2. Stacking and installation of the microwave oven. The maximum height of stacking shall be two units. Specific stacking installation is as follows

- (A) Unscrew and remove the mounting plate, and then tighten the screws.
- (B) Remove the four screws as shown in Figure. 2
- (C) Mount the mounting plate to the lower position and tighten the screws that were just loosened.

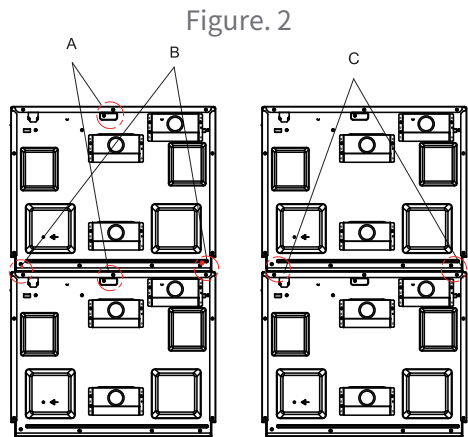

# CONTROL PANEL

## Control Panel(with braille) and Features

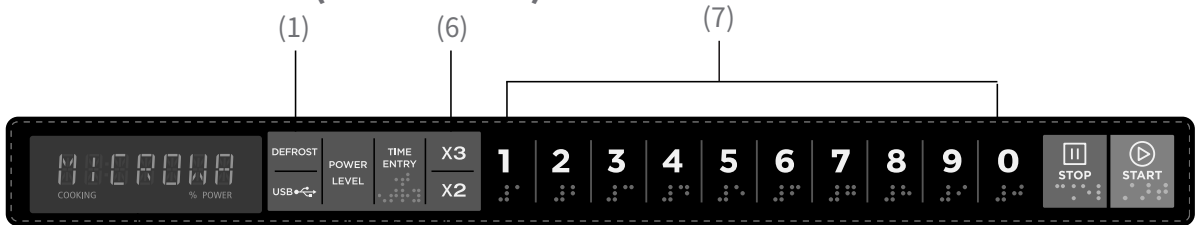

- (1) Defrost Button
- (2) USB Buttons
- (3) Power Level Button
- (4) Time Entry Button
- (5) Double Quantity Button
- (6) Triple Quantity Button
- (7) Number Buttons
- (8) Stop Button
- (9) Start Button
- (10) Display

# OPERATION INSTRUCTION

## Appendix. A Default Cook Times

The oven shall ship with the following Preset Cook Times unless otherwise noted in the product Specification.

BUTTON	DISPLAY(TIME)	POWER
1	0:10	100%
2	0:20	
3	0:30	
4	0:45	
5	1:00	
6	1:30	
7	2:00	
8	2:30	
9	3:00	
0	3:30	

# OPERATION INSTRUCTION

## Appendix. B User Options



Items bolded below are the default values.

OPTION	SETTING	DISCRIPTION
1 EOC Tone	<b>OP:10</b>	<b>3 seconds beep</b>
	OP:11	Continuous beep
	OP:12	5 quick beeps,Repeating
2 BeeperVolume	OP:20	Beeper Off
	OP:21	Low
	<b>OP:22</b>	<b>Medium</b>
3 BeeperOn/Off	OP:30	Keybeep Off
	<b>OP:31</b>	<b>Keybeep On</b>
4 Keyboard Window	OP:40	15 seconds
	OP:41	30 seconds
	<b>OP:42</b>	<b>60 seconds</b>
	OP:43	120 seconds
5 On the Fly	OP:50	On-the-Fly Disabled
	<b>OP:51</b>	<b>On-the-Fly Enabled</b>
6 Door Reset	<b>OP:60</b>	<b>Door Reset Disabled</b>
	OP:61	Door Reset Enabled
7 Max time	<b>OP:70</b>	<b>60 Minute Maximum Cook Time</b>
	OP:71	10 Minute Maximum Cook Time
8 Manual Programming	OP:80	Manual Programming Disabled
	<b>OP:81</b>	<b>Manual Programming Enabled</b>
9 Double Digit	<b>OP:90</b>	<b>Single Digit Mode-10 programs</b>
	OP:91	Doule Digit Mode-100 programs
0 Clean filter	OP:00	Off-Never Display Clean filter
	OP:01	Weekly-Display every 7 days
	<b>OP:02</b>	<b>Monthly-Display every 30 days</b>
	OP:03	Quarterly-Display every 90 days

# OPERATION INSTRUCTION

---

## 1. Power Up (1817G1A & 2117G1A ONLY)

- 1) When the oven is electrified for the first time, the voltage will display for " 230V then "TOUCH 1 208V TOUCH 2 ".
- 2) Choose the Voltage by pressing number button "1" or "2". Then screen will display "230V" or "208V" and "TOUCH START" will also display. Press "  " after selecting voltage.
- 3) Press "  " to make the oven enter to Idle Mode.

## 2. Idle Mode

- 1) The oven shall enter Idle Mode after a period of time has expired in Ready Mode or Pause Mode without any operation. The length of time is determined by the keyboard Timeout Window, set by User Option 4.
- 2) By opening and then closing the oven door, the oven will exit the Idle Mode and into Ready Mode.

**Note:** a. During Idle Mode, the screen is blank. There shall be no oven activity.  
b. During Idle Mode, any button pressed will have no response. If "  " button pressed, the beep tone will sound once and there shall be no oven activity.

## 3. Ready Mode

- 1) In Idle Mode, opening and then closing the door will put the oven into Ready Mode. The screen will display "READY".
- 2) From the Ready Mode, the oven can go to almost all of the other modes.

**Note:** In Ready Mode, the fan and oven lamp work. Do not operate oven empty.

## 4. Door Open Mode

- 1) Opening the door will put the oven into Door Open Mode.
- 2) During this mode, the screen is blank. If the door is opened during cooking state, "DOOR" and "OPEN" will display in order once. Then the screen will display the remaining cooking time. The fan and oven lamp work.
- 3) When the door is closed, the oven shall be enter Ready Mode.

**Note:** If the operator opens the door while the oven is in cooking state.



If User Option OP:60 has been set, the oven shall enter Pause Mode;

If User Option OP:61 has been set, the oven will clear out any information about cooking state which was running and it will enter Door Open Mode.

# OPERATION INSTRUCTION

---

## 5. Pause Mode



- 1) While cooking, if the door is opened and then closed, or if the "  " pad is pressed, the oven will enter Pause Mode.
- 2) While paused, the screen will display the remaining cook time.
- 3) In Pause Mode, if the "  " button is pressed, the oven shall immediately enter Ready Mode; If the "  " button is pressed, the oven will go into working mode.

## 6. End of Cook Cycle Mode

- 1) When the cooking time has expired, the oven shall go into the End of Cook Cycle Mode. And the screen will display " DONE ".
- 2) If either User Option OP:11 or OP:12 is selected, the oven shall continue the beep tone until opening the door or pressing the "  " pad; If User Option OP:10 is selected, after the 3 second beep, the oven shall display "DONE". After the beep, "READY" will display and the oven will enter Idle Mode without any operation for a period of time.

## 7. User Option Mode

This allows the user to change the configurations of the oven.

- 1) Open the oven door and press "2" pad for 5 seconds. The beep tone sounds once and oven will enter the User Option Mode.
  - 2) The screen displays "OP: - -".
  - 3) Press corresponding number button to enter related mode setting. (refer to Appendix B)(Page 12) For example: to set the volume of the beep to medium. Press " 2 ", "OP:22" displays. If you want to change it, keep pressing "2", the screen displays "OP:20", "OP:21", "OP:22", "OP:23", "OP:20" .....in cycle.
  - 4) Press "  " to save the current setting. After saved, "OP: - -" will display again.
- Note:** a. During setting process, press "  " to enter Door Open Mode. Close the door will enter Ready Mode.
- b. If "  " button not pressed at the last step, the program will not be saved but stay in the previous setting.

## 8. Manual Cook Mode

- 1) In Ready Mode, press the "Time Entry" pad. And the screen will display "00:00".
- 2) Press number buttons to input the cooking time.

# OPERATION INSTRUCTION

---

3) Press "Power Level" button, "%POWER" displays. Press number buttons to select power level you want, and the corresponding power will light. If you want to choose full power level, press "1" and "0" successively. Then the screen will display "%POWER" . If no power chosen, 100% power is default.

4) Press "  " to start cooking.

**Note:** a. During setting process, if you press "  " , the oven will enter Ready Mode.

b. During cooking process , If you press "  " button under this mode, the oven will enter Pause Mode.

## 9. Preset Program Cook Mode

This mode allows the user to assign cook times and power levels to each numbered button.(Up to 100)

1) Open the door and press "1" pad for 5 seconds, the beep tone will sound once and "PROGRAM" appears in the display.

2) Press number button to set the program( If User Option OP:91 is selected , you can set program from 0 to 100).2 seconds later, the screen will display the saved time. (refer to Appendix B)

3) Press number buttons to input the amount of time you want.

4) Press "Power Level" button, "%POWER" displays. Press number buttons to select power level you want, and the corresponding power will light. If you want to choose full power level press "1" and "0" successively. Then the screen will display "%POWER" . If no power chosen, 100% power is default.

**Note:** Set the time first, then choose the power for each stage.

5) After setting the time and power, press "  " , the cooking program will be saved. When the program saved, "PROGRAM" displays.

6) Close the door, the oven will turn back to Ready Mode.

7) In Ready Mode, pressing number buttons will cause the oven to run the Preset Program associated with that number button.

8) The screen displays the remaining cooking time. If it is multi-stage cooking, the oven will display the total remaining cooking time displays rather than a particular stage cooking time.

9) While the oven is cooking, if User Option OP:51 is selected, when the operator presses number buttons, the preset cooking program will start automatically.



# OPERATION INSTRUCTION

---

For example: set the program as memory cooking. Power level 70% and cooking time is 1 minute and 25 seconds.

Step1: Open the door, press number button "1" for 5 seconds,"PROGRAM" displays.



Step 2: Press number button "3", the screen will display "P:03",After two seconds, the screen will display the related time " :30".

Step 3: Press number buttons "1", "2" and "5" to input the cooking time.

Step 4: Press"PowerLevel" button and then press" 7", "1:25 70 " displays. Setting finished.

Step 5 : Press "  " to save. When use the program next time, just press "3", the related program will start.

## Note:

- a. If the electricity is cut off, the saved program will not lost.
- b. If the program need to be reset , just repeat the aboved steps.
- c. If all the cooking time exceeds the MAX.time User Option 7,when press "  " to save the program, the beep tone will sound three times briefly to tell you the time is unavailable. Then the screen will turn back to display " PROGRAM ". The time set before will not change.
- d. If the "  " button is pressed during setting process, the oven returns to Door Open Mode.  
The program that is not saved will be lost. If there is program saved press the related number button, the saved program will start. If there is no saved program, the beep tone will alarm when pressing number button and it will not work.

## 10. Stage Cooking Programming

- 1) This allows the user to cook food items at Manual Cook Mode and Preset Program Cook Mode. 3 stages can be set .After setting the power and time for the first stage, press " Time Entry " to set the second stage. And the same step to set the third stage.
- 2) When setting the second and/or third stage, press " Time Entry", and "STAGE-2", "STAGE3" displays.
- 3) Press "  " button to start cooking.

Example: In programming mode, press pad number "3".To set two stages cooking. The first stage is PL7 for 1 minute 25 seconds. The second stage is PL5 for 5 minutes and 40 seconds. The steps are as follows:

# OPERATION INSTRUCTION

---

- a. Open the door, press number button "1" for 5 seconds, "PROGRAM" displays.
- b. Press number button "3", the screen will display "P:03", After two seconds, the screen will display the related time.
- c. Press "1", "2", "5" to input the cooking time. "1:25" displays.
- d. Press " Power Level " button and then press "7", "1:25 70" displays.  
The first stage is finished.
- e. Press " Time Entry", "STAGE2" displays.
- f. Press "5", "4", "0" button, "5:40" displays.
- g. Press " Power Level " button and then press "5", "5:40 50 " displays.  
The second stage is finished.
- h. Press "  " button to save the program.

## 11. Double/Triple Quantity cooking

- 1) If the "X2" or "X3" button is pressed in Ready Mode, followed by the starting of a Preset Program, or if the "X2" or "X3" button is pressed in 5 seconds of starting a Preset Program, the oven will start cooking with the quantity preset cooking time.
- 2) Press "X2", "DOUBLE" displays. Press "X3", "TRIPLE" displays. When the pad number pressed, the screen will display the quantity preset time for that multiple.  
For example, number button "5" and its preset time is 1 minute. Then press "X2", then time will change to  $1:00 \times 2 = 2$  (2 minutes)

## 12. Time Defrost Function

- 1) In Ready Mode, Press " DEFROST " button, screen will display "00:00".
- 2) Press number buttons to input defrosting time. The maximum time is 99 minutes and 99 seconds.
- 3) Press "  " to start defrosting. The default power is power level 20% and it cannot be changed.

## 13. Filter Cleaning Function(See Appendix B in page 12)

- 1) If User Option OP:01, OP:02 or OP:03 OP:02 or OP:03 oven will remind the user to clean the filter.

**Note:** The oven must be electrified.

- 2) The screen will display "CLEAN FILTER". Opening and then closing the door will put the oven into Ready Mode.





# OPERATION INSTRUCTION

---

- 3) If you do not need to clean the filter , press "  " button and hold for 3 seconds to clear out the reminder information. Otherwise, the oven will remind you all the time during Idle Mode.



## 14. Factory-default setting

In Ready Mode, pressing "  " and "0" simultaneously will put the oven into Factory-default Setting Mode.

- 1) Press "  " and "0", the beep tone sounds once, and the screen will display "CHECK". If it is in the Factory-default Mode, the screen will display "11", after three seconds, the oven turns to the Ready mode. Or press "  " to cancel the display and back to ready back in the process of display. If not in the Factory-default Mode, the screen will display "00", press "  " to the Factory-default Mode, the screen will display "CLEAR". The beep tone sounds once, after self-testing, the screen will display "11" or "00".
- 2) If do not press "  " when the screen display "00", the setting will cancel.

**Note:** Be careful in the operation as it will restore all configure to Factory-default Mode.

## 15. USB Function

- 1) During the ready mode, insert the U drive into the port on the right front top side of the oven (on the side by the "  " button)
- 2) Press "USB" button to update the data of computer board. "LOADING" should display
- 3) If the update is successful, the screen will display "SUCCESS". Otherwise, "FAIL" will display. If "FAIL" display, retry.
- 4) Press "  " or open the door to complete.

# How to set the U disk

## Always keep the oven clean

1. Insert the U disk to computer and open the file called

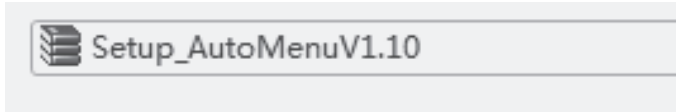

2. Double-click "MenuEdit" to enter editable interface.  
(Recommendation: Right-click and choose "Run as administrator")

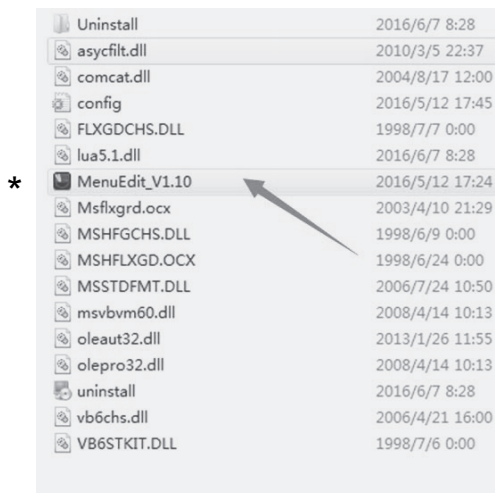

3. Set the maximum cooking time of single menu.

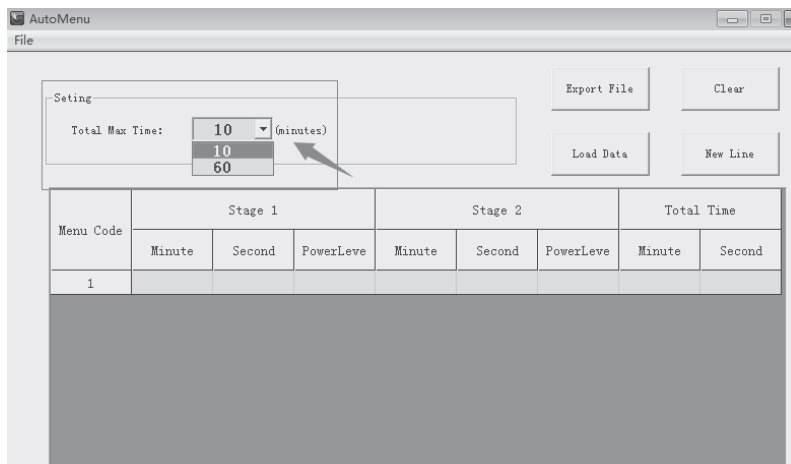

# How to set the U disk

4. Set the first menu, maximum of two stages of cooking can be set. And you can set the cooking time and power.

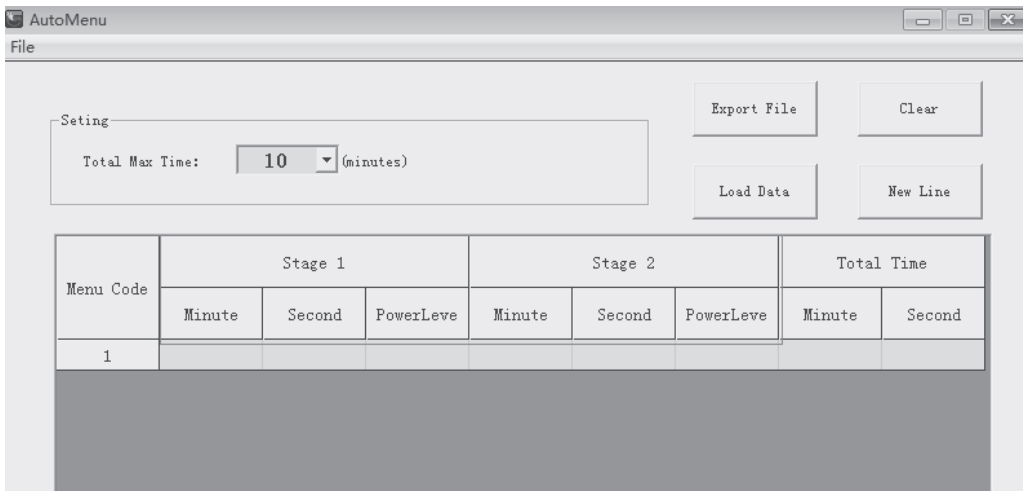

5. Click “New Line” to creat the second menu,the third menu, the forth menu...And 20 menus can be maximumly set.

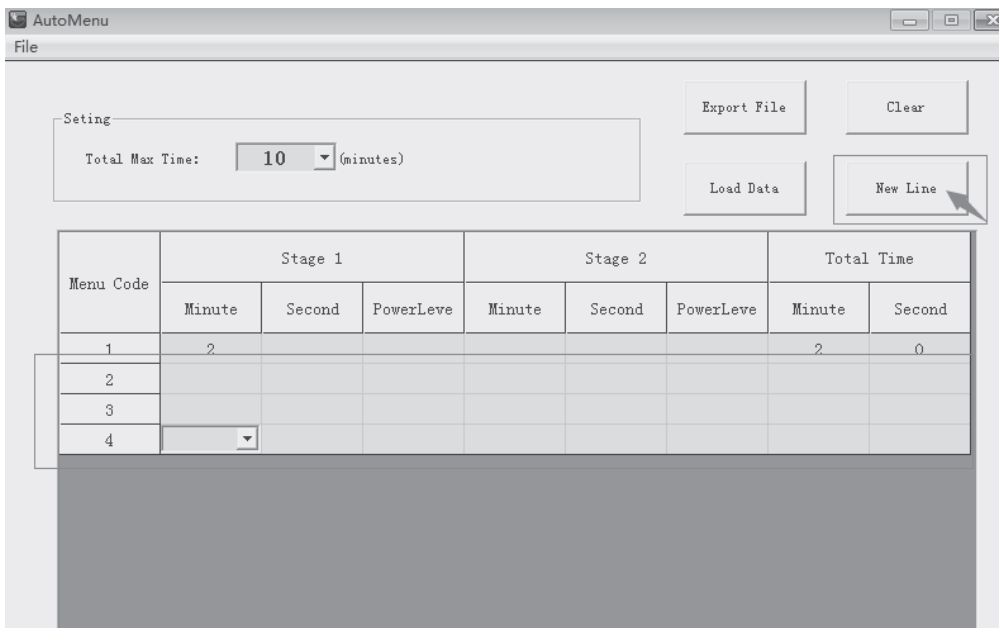

# How to set the U disk

---

- Click “Export File” to export the file to U disk .The file will be named “ UTABLE.C” . Then click “Save” to finish the setting.

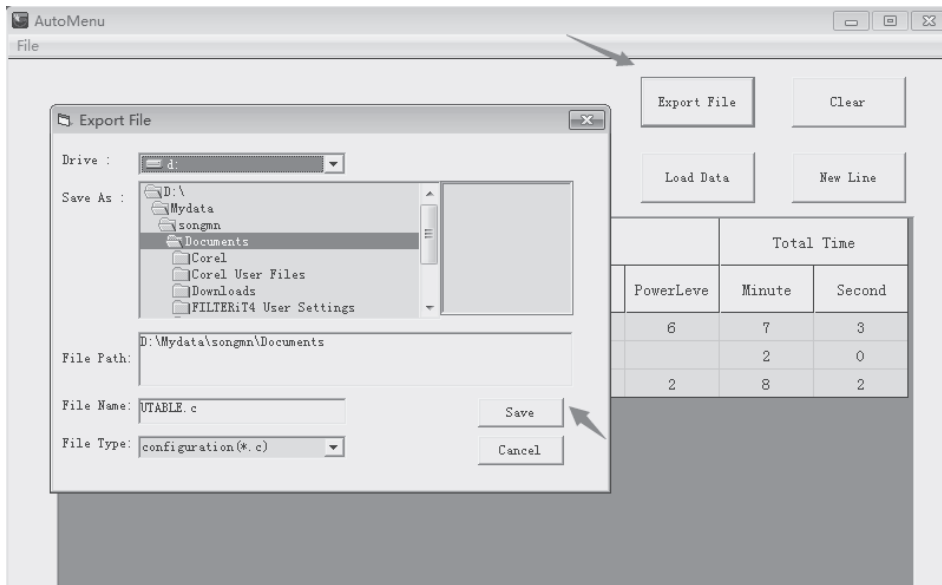

# Cleaning Instructions

---

## Always keep the oven clean

1. Cleaning the glass viewing window, the inner door panel and oven front face. For best performance and to maintain the high degree of safety, the inner door panel and oven front face should be free of food or grease build-up. Wipe these parts with a mild detergent, rinse and wipe dry. Never use abrasive powders or pads.
2. Cleaning the control panel and plastic parts.  
Do not apply a detergent or an alkaline liquid spray to the control panel and plastic parts, as this may cause damage to these parts. Use a dry cloth (not a soaked cloth) to clean these parts.
3. Cleaning the oven interior  
After use be sure to clean up spilled liquids, spattered oil and food debris as quickly as possible. If the oven is used when dirty, efficiency drops and the dirt gets stuck on the oven surface and may cause bad

CAUTION: Do Not wipe plastic and painted sections of the oven with bleach, thinners or other cleaning agents, as this may cause these parts to dissolve or change shape.

Note: Here "an ounce of prevention " can save pounds of clean up time.  
Cook all foods covered, doing so:

- .Keep foods moist
- .Shorten cooking time
- .Helps even cooking temperatures
- .Helps keep the inside of the oven clean

# Filter cleaning

---

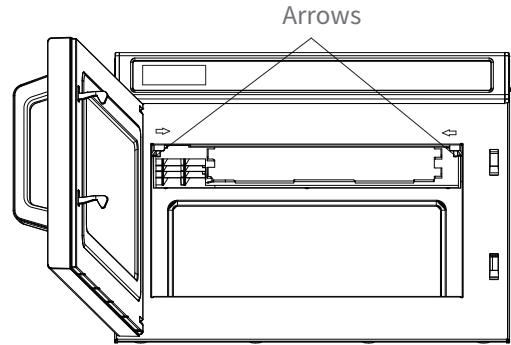
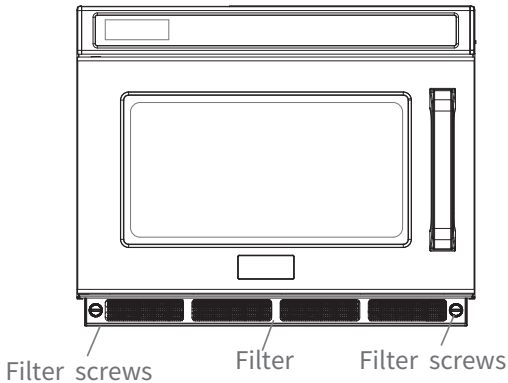

Caution! Make sure the splash shield is installed correctly before use of the microwave oven!

The front filter serves as the air inlet; the filter should be cleaned regularly, depending on the kitchen conditions.

1. Turn filter screws counterclockwise to unscrew and take off the filter ; and wash it in warm soap and water;rinse,sanitize,allow to dry.
2. Install the filter screen, tighten the screw to clockwise
3. Make sure the filter is installed before use of the microwave oven;
4. The factory setting has the function to remind the user of washing the filter every 30 days.

## (6) Splatter shield cleaning

1. Detaching: Hold the two tabs in front of the splatter shield with your hands (as shown by the arrows).Push the tabs following the direction of the arrows and pull downwards after you have pulled in the tabs:
2. Wash the splatter shield,rinse,sanitize,allow to dry.
3. Installation: Pick up the splatter shield and put it into the chamber in the way that insert the pins first at the rear into the positioning hole on the rear plate of chamber, then push the other side to insert all positioning pins into their positioning holes.
- 4.Push the front of the splatter up to set the tabs in their corresponding position.



# Installation(supplement)

---

1. The switching operation of this microwave oven can cause voltage fluctuations on the supply line. The operation of this oven under unfavorable voltage supply conditions can have adverse effects. This device is intended for the connection to a power supply system with a maximum permissible system impedance  $Z_{max}$  of 0.3 Ohms at the interface point of the user's supply. The user has to ensure that this device is connected only to a power supply system which fulfills the requirement above. If necessary, the user can ask the public power supply company for the system impedance at the interface point.
2. If there is no equipotential bonding conductor in the electric supply, an external equipotential bonding conductor must be installed at the rear of the appliance (see symbol). This terminal shall be in effective electrical contact with all fixed exposed metal parts and shall allow the connection of a conductor having a nominal cross-sectional area up to 10 mm<sup>2</sup>.



Symbol for the external connection of equipotential bonding conductors.

# MAINTENANCE

## TROUBLESHOOTING

Check your problem by using the chart below and try the solutions for each problem. If the microwave oven still does not work properly, contact the nearest authorized service center or call the help center at 1-855-238-5604.

TROUBLE	POSSIBLE CAUSE	POSSIBLE REMEDY
Oven will not start	<ul style="list-style-type: none"> <li>a. Electrical cord for oven is not plugged in.</li> <li>b. Door is open.</li> <li>c. Wrong operation is set.</li> </ul>	<ul style="list-style-type: none"> <li>a. Plug into the outlet.</li> <li>b. Close the door and try again.</li> <li>c. Check instructions.</li> </ul>
Arcing or sparking	<ul style="list-style-type: none"> <li>a. Materials to be avoided in microwave oven were used.</li> <li>b. The oven is operated when empty.</li> <li>c. Spilled food remains in the cavity.</li> </ul>	<ul style="list-style-type: none"> <li>a. Use microwave-safe cookware only.</li> <li>b. Do not operate with oven empty.</li> <li>c. Clean cavity with damp towel with mild sanitizer.</li> </ul>
Unevenly cooked foods	<ul style="list-style-type: none"> <li>a. Materials to be avoided in microwave oven were used.</li> <li>b. Food is not defrosted completely.</li> <li>c. Cooking time, power level is not suitable.</li> <li>d. Food is not turned or stirred.</li> </ul>	<ul style="list-style-type: none"> <li>a. Use microwave-safe cookware with cover only.</li> <li>b. Completely defrost food.</li> <li>c. Use correct cooking time, power level.</li> <li>d. Turn or stir food.</li> <li>e. Cook food covered.</li> </ul>
Overcooked foods	Cooking time, power level is not suitable.	Use correct cooking time, power level. Call support center.
Undercooked foods	<ul style="list-style-type: none"> <li>a. Materials to be avoided in microwave oven were used.</li> <li>b. Food is not defrosted completely.</li> <li>c. Oven ventilation ports are restricted.</li> <li>d. Cooking time, power level is not suitable.</li> </ul>	<ul style="list-style-type: none"> <li>a. Use microwave-safe cookware with cover only.</li> <li>b. Completely defrost food.</li> <li>c. Check to see that oven ventilation ports are not restricted.</li> <li>d. Use correct cooking time, power level.</li> <li>e. Cook food covered.</li> </ul>
Improper defrosting	<ul style="list-style-type: none"> <li>a. Materials to be avoided in microwave oven were used.</li> <li>b. Cooking time, power level is not suitable.</li> <li>c. Food is not turned or stirred.</li> </ul>	<ul style="list-style-type: none"> <li>a. Use microwave-safe cookware only.</li> <li>b. Use correct cooking time, power level.</li> <li>c. Turn or stir food.</li> </ul>



