

# INSTALLATION, OPERATION AND MAINTENANCE MANUAL

PLEASE READ THESE INSTRUCTIONS COMPLETELY  
BEFORE OPERATING THE ECOSMART™ FIRE.

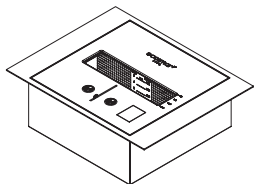

BK Series

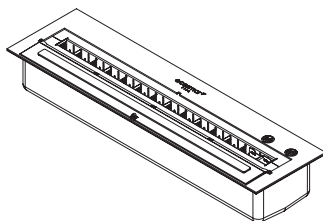

XL Series

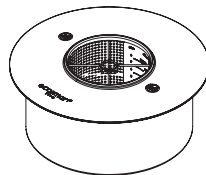

AB Series

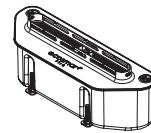

VB Series

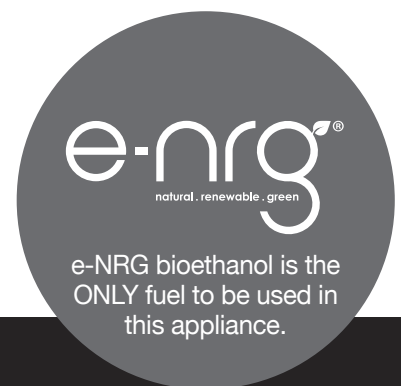

## ! WARNINGS:

IF THE INFORMATION IN THIS MANUAL IS NOT FOLLOWED EXACTLY, A FIRE OR EXPLOSION  
MAY RESULT CAUSING PROPERTY DAMAGE, PERSONAL INJURY OR LOSS OF LIFE.



Do not fill  
while hot



Do not fill while  
operating



Do not overfill



Flammable

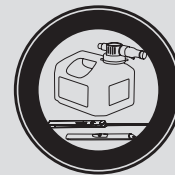

Use with supplied  
accessories



Keep away  
from children



---

<b>ENGLISH</b>	<b>INSTALLATION, OPERATION AND MAINTENANCE MANUAL</b>	<b>1 – 22</b>
	Please read these instructions completely before operating the EcoSmart™ Fire.	
<b>DEUTSCH</b>	<b>INSTALLATIONS-, BEDIENUNGS- UND WARTUNGSHANDBUCH</b>	<b>23 – 44</b>
	Bitte lesen Sie diese Anweisungen vor der Inbetriebnahme des EcoSmart™ Fire vollständig durch.	
<b>FRANÇAIS</b>	<b>MANUEL D'INSTALLATION, D'UTILISATION ET D'ENTRETIEN</b>	<b>45 – 66</b>
	Veuillez lire ces instructions dans leur intégralité avant de faire fonctionner le système EcoSmart™ Fire.	
中文	安装，操作 和维修指南	<b>67 – 88</b>
	请在使用EcoSmart Fire®产品前仔细阅读指南说明。	
<b>ITALIANO</b>	<b>MANUALE DI INSTALLAZIONE, USO E MANUTENZIONE</b>	<b>89 – 110</b>
	Leggere il manuale di istruzioni per l'uso prima di operare un prodotto EcoSmart™ Fire.	
<b>ESPAÑOL</b>	<b>MANUAL DE INSTALACIÓN, USO Y MANTENIMIENTO</b>	<b>111 – 132</b>
	Por favor, lea las instrucciones completamente antes de utilizar el EcoSmart™ Fire.	

---

MH46715

UNVENTED ALCOHOL-FUEL-BURNING DECORATIVE APPLIANCE  
35PZ

All burners are UL Listed in accordance with MH46715/Subject1370 in the USA, Certified by BSI in accordance with EN16647 (excluding VB2), and comply with the ACCC Safety Mandate for Australia.

Bioethanol fireplaces are classified by regulations and standards as decorative fireplace appliances intended for occasional use only (not for heating).

#### EDUCATE ALL USERS

This type of technology is not well known and therefore we recommend that owners diligently induct any potential user of their Fire to ensure everyone is aware of the safety procedures associated when using e-NRG Bioethanol as a fuel source.

Operational Videos and Manuals can be found on our website or by contacting your local distributor.

#### WHY REGISTER YOUR WARRANTY?

Registering your warranty achieves more than simply activating your warranty - it provides our head office with the information that we require in order to communicate important safety and regulatory information to you should the need arise.

This could include things like:

- Prompt notification in the unlikely event of a potential hazard,
- Changes to fuel storage regulations, supply channels or special offers,
- Reminders about regular safety steps and maintenance procedures,
- New model announcements or accessories that suit or enhance your purchase.

It is important that we are able to communicate effectively with our customers as part of our commitment to continual improvement, consumer safety and property protection.

If you purchased your product through an external distributor, retailer or agent MAD Design Group does not have these details on file and may have trouble sourcing them as systems and best practices vary from business to business.

Please register your warranty today. You can do this online at the following web address: [www.ecosmartfire.com/contact](http://www.ecosmartfire.com/contact) or by sending through your details via email using the details below.

#### EcoSmart Fire is designed and manufactured by MAD Design Group

Showrooms 3 & 4, 40-42 O'Riordan Street  
Alexandria NSW 2015 Australia  
Tel: +61 2 9997 3050  
Email: [info@ecosmartfire.com](mailto:info@ecosmartfire.com)



**e-NRG Bioethanol is the ONLY fuel to be used in this appliance.**

#### FLAMMABLE

**You must familiarise yourself and comply with local regulations in order to safely and legally store, handle, decant and use e-NRG Bioethanol.**

Refer to the e-NRG Safety Data Sheet (SDS) for important Health and Safety information.



**Ethanol, the primary ingredient of e-NRG fuel, presents a significant flammability risk if appropriate steps to reduce the likelihood of ignition are not followed.**

These include:

- Permitting for volumes of e-NRG (e.g. for USA, greater than 5 gallons stored inside, or greater than 10 gallons stored outside).
- Removal of all potential sources of ignition including sparks and open flames.
- Maintenance of good ventilation of enclosures where e-NRG is stored.
- Storage of e-NRG (e.g. for USA, greater than 10 gallons in an approved storage cabinet).
- Storage in such a way as to reduce the likelihood of spillage or container rupture.
- Responsible handling to include:
  - Use of the Jerry Can in an approved manner and with attention to the possible presence of flames or other ignition sources in or near the appliance,
  - Limiting access to qualified users,
  - Proper transfer techniques to limit spillage and generation of static electric discharge (i.e bonding and grounding),
  - Proper labeling and signage in accordance with applicable fire codes.

These precautions are necessary to reduce risk of damage to property, injury and death resulting from accidental ignition of e-NRG.

#### To order your e-NRG Fuel contact:

##### Australia

Visit - [www.e-NRG.com.au](http://www.e-NRG.com.au)  
Call - 1300 003 NRG

##### USA

Visit - [www.e-NRG.com](http://www.e-NRG.com)  
Call - (888) 670 ENRG

##### UK

Visit - [www.e-NRG.co.uk](http://www.e-NRG.co.uk)

Or contact your local EcoSmart Fire distributor.

---

## Contents

---

<b>Important Safety Information</b>	<b>3 – 4</b>
<b>Standard Equipment Received</b>	<b>5 – 7</b>
<b>Markings</b>	<b>8</b>
<b>Clearances &amp; Installation</b>	<b>9 – 11</b>
<b>Ventilation &amp; Efficiency</b>	<b>12 – 13</b>
<b>How to Operate the Burner</b>	<b>14 – 17</b>
Regulatory Information for the Safe Handling and Storage of e-NRG Bioethanol	14
Decanting your e-NRG Bioethanol into the Jerry Can	14
Decanting your e-NRG Bioethanol from the Jerry Can into the Burner	15
Lighting the Burner	16
Regulating the Flame	16
Baffles	16
Turning your Burner OFF - Extinguishing the flame	17
Re-igniting the Burner	17
<b>Regular Safety Checks</b>	<b>18</b>
<b>Caring for your EcoSmart Fire</b>	<b>19</b>
<b>Troubleshooting</b>	<b>20</b>
<b>Your Warranty</b>	<b>21</b>
<b>After Sales Service</b>	<b>22</b>

## Important Safety Information

Congratulations on your purchase of an EcoSmart™ Fire.

MAD Design Group is very safety conscious. We have taken every care in designing, manufacturing and assembling your Fire to ensure it operates effectively, efficiently and safely. In return, we ask that you exercise care when using this appliance and follow the instructions below:

This manual contains instructions for the safe installation and use of your new EcoSmart Fire. Before installing and using your appliance, read the entire manual and follow the instructions and warnings carefully.

The appliance must be installed in a fixed and secure position.

**WARNING!** Failure to follow these instructions and warnings could result in death, serious injury, or property damage.

### 1. EXPLOSION/FIRE HAZARD



- i. Never use any fuel other than e-NRG Bioethanol in the appliance. Never use gasoline.
- ii. Shut appliance off and allow to cool 60 minutes before refueling. Flame may be difficult to see—do not assume appliance is off. Always follow shut-off procedure before refueling.
- iii. Wipe up spills immediately with a dry cloth followed by a cloth dampened with water. Allow to dry completely before lighting Burner.
- iv. Do not operate in a room with oxygen tanks in use or if flammable vapors are present.
- v. Store fuel only in original container or provided Jerry Can. Store away from area where the appliance is located. Transport and/or store fuel only in a plastic or metal container that is acceptable for use with the fuel and non red in color.
- vi. Never smoke while refueling or lighting the appliance.

### 2. LOCATING THE FIRE

- i. Keep children away from the appliance. Never leave children unsupervised when the fire is operating.
- ii. Install a smoke alarm and test it monthly to make sure it is in working order. Have a multi purpose dry chemical type fire extinguisher (AB:E in Australia / ABC in USA). These can be purchased from your distributor or independently.
- iii. For decorative purposes only. Not suitable for continuous operation. Do not use the appliance to heat or boil water or as a cooking appliance. Do not put wood, charcoal, paper or other combustible objects in the Fire.
- iv. Do not move or relocate the appliance while in use.

### 3. VENTILATION

- i. Open fires consume oxygen and contain the risk of indoor air pollution. Use only in well-ventilated areas and those that are protected from the draft effects of cross ventilation. Improper ventilation can cause serious injury or death. People with breathing problems should consult a physician before using the appliance. Refer to ventilation information on page 12.

### 4. FUELING THE FIRE



**DO NOT FILL WHILE OPERATING**



**DO NOT FILL WHILE HOT**

- i. This appliance **ONLY** uses e-NRG Bioethanol fuel. e-NRG Bioethanol is a flammable liquid. Store in original container or supplied Jerry Can away from heat and sources of ignition. Refer to page 1 for more information.
- ii. e-NRG Bioethanol is classified as a Dangerous Goods Flammable Liquid Class 3, PGI1 and is regulated by specific standards and rules. You must familiarise yourself with the appropriate regulations of your country in order to safely and legally store, handle, decant and use this fuel.
- iii. The customer warrants to MAD Design Group that after delivery of their Fire and whilst MAD Design Group retains any interest in the goods or consigned goods (as the case may be) the customer shall comply with all applicable acts, regulations and laws dealing with the transport, unloading and storage of dangerous goods.
- iv. MAD Design Group is not liable for any damage caused by using the incorrect type of fuel.

### 5. OPERATING THE FIRE

- i. Make sure the shut-off mechanism operates freely.
- ii. Do not use if damaged or malfunctioning.
- iii. Risk of explosion or burn. Use only the lighting rod and lighter provided with your appliance to ignite the fireplace. Using matches or other lighters could result in serious injury.
- iv. Do not use the lighter without the lighting rod.
- v. Remove the Burner frequently to check for any residual fuel underneath the Burner. Accumulation of fuel underneath could cause an explosion.
- vi. **NEVER** leave a fire unguarded.

---

## Important Safety Information

---

### 6. HOT SURFACE HAZARD

- i. Due to high surface temperatures, keep children, pets, clothing and furniture away from the unit, as the unit is hot while in operation, contact with the appliance may cause skin burns.
- ii. The shut-off mechanism on the Burners will become very hot during operation and will stay hot for up to 60 minutes after use. To avoid injury, do not touch with any parts of your body nor with any combustible materials such as matches or flammable liquids. Always use the lighting rod provided with your appliance to open or close the shut-off mechanism.

### 7. USING ACCESSORIES

- i. Use only *authorised* accessories and tools with your appliance. Accessories and tools *supplied* by EcoSmart Fire are strongly recommended. Light only with the lighting rod and lighter provided. Visit [www.ecosmartfire.com](http://www.ecosmartfire.com) for a full line of accessories for your appliance.
- ii. Doors must not be added to modify any EcoSmart Fire model. To reduce the risk of fire or injury, do not modify the appliance in any way. Models that are fitted with a door by the manufacturer must not be modified in any way.
- iii. EcoSmart Fires have not been tested with an unvented gas log set. To reduce the risk of fire or injury, do not install an unvented gas log set into this appliance.
- iv. Pebbles or other refractory decorative fire accessories should not be placed directly over the Burner mouth or interfere with the flame.

**For decorative fire accessories you must:**

- Ensure the decorative fire accessories do not interfere with the shut-off mechanism.
  - Confirm quality and suitability of fire accessories to ensure the accessories will not explode, emit carbon monoxide or fumes when exposed to extreme temperature variations.
  - Fire accessories must not be smaller than the largest opening of the burner used so that the accessories cannot fall into the burner at any time.
- v. Do not use fittings or spare parts, other than those available from or recommended by MAD Design Group for the fire casings, fireboxes, grates or burners.
  - vi. Certified EcoSmart Fire screens are recommended to prevent injuries to children and pets. The fire should never be left unattended.

### 8. CUSTOM DESIGNED FIREPLACES, AUSTRALIA:

The 2017 Safety Standard introduced by the ACCC stipulates that all ethanol fireplaces must meet the following minimum criteria.

In regards to Design, a decorative alcohol fuelled device must:

- (a) require installation in a fixed position; or
- (b) have both:
  - (i) a dry weight of at least 8 kg; and
  - (ii) a footprint of at least 900 cm<sup>2</sup>

In regards to Stability, a decorative alcohol fuelled device must comply with the clause 4.5 of the European Standard.

If you are creating a custom designed fireplace with an EcoSmart Burner it is imperative that the criteria is applied.

**IF YOU HAVE ANY QUESTIONS REGARDING ANY OF THE IMPORTANT SAFETY INFORMATION PLEASE CONTACT YOUR DISTRIBUTOR OR MAD DESIGN GROUP.**

**PLEASE STORE THESE WARNINGS IN A SAFE PLACE FOR FUTURE REFERENCE.**

## Standard Equipment Received

Please ensure that all items have been received. The Burner Range includes the minimum equipment required to operate the Burner safely.

Burner		Standard Equipment Received						
Series	Model	Manual	Jerry Can	Lighting Rod	Lighter	Extension Spout	Top Tray*	Baffles
BK Series	BK5	1	1	1	1	-	1	-
XL Series	XL1200, XL900, XL700, XL500	1	1	1	1	-	1	2 - 5
	XS340	1	1	1	1	-	1	-
AB Series	AB8/AB8 (EN)	1	1	1	1	-	1	1
	AB3	1	1	1	1	1	1	-
VB Series	VB2	1	1	1	1	-	1	-

\*Top Trays are an Included Accessory when required by local standards, refer to page 11.

### Burner

The Burner is the core product of the EcoSmart Fire as it is the chamber that houses the fuel.

#### BK SERIES (Including Top Tray)



**BK5**  
 l 400mm x w 317mm x h 123mm  
 l [15.7in] x w [12.5in] x h [4.4in]  
 7.6kg [16.6lbs]

#### VB SERIES



**VB2**  
 l 330mm x w 110mm x h 122mm  
 l [13.0in] x w [4.3in] x h [4.8in]  
 1.8kg [4lbs]

#### XL SERIES



**XL1200**  
 l 1200mm x w 195mm x h 112mm  
 l [47.2in] x w [7.7in] x h [4.4in]  
 15.7kg [34.5lbs]

**XL900**  
 l 908mm x w 195mm x h 112mm  
 l [35.7in] x w [7.7in] x h [4.4in]  
 11.9kg [26.3lbs]

**XL700**  
 l 700mm x w 195mm x h 112mm  
 l [27.6in] x w [7.7in] x h [4.4in]  
 9.2kg [20.2lbs]

**XL500**  
 l 500mm x w 195mm x h 112mm  
 l [19.7in] x w [7.7in] x h [4.4in]  
 6.5kg [14.3lbs]

**XS340**  
 l 340mm x w 190mm x h 76mm  
 l [13.4in] x w [7.5in] x h [3.4in]  
 3.7kg [8lbs]

#### XL SERIES (Including Top Tray)



**XL1200**  
 l 1253mm x w 248mm x h 124mm  
 l [49.3in] x w [9.8in] x h [4.9in]  
 20.8kg [45.8lbs]

**XL900**  
 l 961mm x w 248mm x h 124mm  
 l [37.8in] x w [9.8in] x h [4.9in]  
 16.2kg [35.6lbs]

**XL700**  
 l 753mm x w 248mm x h 124mm  
 l [29.6in] x w [9.8in] x h [4.9in]  
 12.5kg [27.6lbs]

**XL500**  
 l 553mm x w 248mm x h 124mm  
 l [21.8in] x w [9.8in] x h [4.9in]  
 9.1kg [20lbs]

**XS340**  
 l 382mm x w 232mm x h 107mm  
 l [15in] x w [9.1in] x h [4.2in]  
 5.4kg [11.9lbs]

#### AB SERIES



**AB8**  
 ø 360mm x h 156mm  
 ø [14.2in] x h [6.1in]  
 5.9kg [13lbs]

**AB3**  
 ø 260mm x h 94mm  
 ø [10.2in] x h [3.7in]  
 2.4kg [5.4lbs]

**AB8 (EN)**  
 ø 420mm x h 159mm  
 ø [15.8in] x h [6.3in]  
 8.2kg [18.1lbs]

**AB3**  
 ø 291mm x h 101mm  
 ø [11.5in] x h [4in]  
 3.7kg [8.1lbs]

#### AB SERIES (Including Top Tray)

## Standard Equipment Received



### Installation, Operation and Maintenance Manual

In order to obtain optimal and safe results from your appliance, we recommend carefully reading the entire instruction manual.

h 297mm x l 210mm x d 8mm

h [11.7in] x l [8.3in] x d [0.3in]



### Jerry Can with Safety Spout (CARB Regulation compliant)

This 5 Litres [1.25Gal] Jerry Can has been chosen for its unique safety features. It includes an automatic stop flow, a fast flow rate, a locking thumb button control, and a self-venting system. The Jerry Can will allow safe storing/decanting of the e-NRG Bioethanol used in the Burner.

*Due to safety regulations the Jerry Can provided with this package comes without fuel.*

h 320mm x l 310mm x d 195mm

h [12.6in] x l [12.2in] x d [7.7in]



### e-NRG Fuel Adaptor

Adaptors are used to connect the No Spill Spout to the e-NRG bottle. Depending on the thread of the bottles used in each country the adapter may look different (if available in your country).

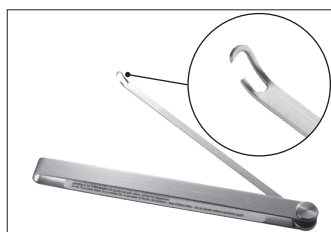

### Lighting Rod

This long slender piece of stainless steel with a small hook return at the end enables you to safely adjust the slider position on the Burner at any time. It is also used for the ignition procedure.

h 657mm x l 28mm x d 23mm

h [25.9in] x l [1.1in] x d [0.9in]



### Lighter\*

This refillable butane lighter supports the safe ignition of the lighting rod. The length of the lighter further enhances the management of the lighting process.

*\* Due to safety regulations the butane lighter provided with this package comes without fuel. Small re-charge cans of butane gas with the necessary connections can be purchased from your hardware store. Lighter image is indicative only, the model included may vary from time to time.*

h 185mm x l 15mm x d 15mm

h [7.3in] x l [0.6in] x d [0.6in]

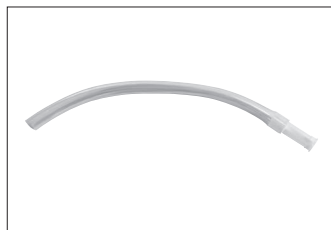

### Extension Spout (AB3 Only)

An extension spout is included with the AB3 Burner. This is for use with models that have more restricted access to the filling point so that filling can be done in a safe manner according to the procedures outlined in the Operations Manual.

l 500mm x ø 25mm

l [19.7in] x ø [1in]

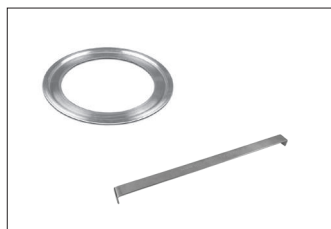

### Baffles (XL Series) / Efficiency Ring (AB8 Burner)

These efficiency devices are a standard inclusion with the XL Series and AB8 Burners. Baffles (or Rings) are placed over the internal burner vents when cold and not operating and serve to increase the efficiency of the burner as well as further stabilise the flame of the burner.

#### XL Series

h 10mm x l 80mm x d 10mm

h [0.4in] x l [3.1in] x d [0.4in]

#### Efficiency Ring

h 5mm x ø 158mm

h [0.2in] x ø [6.2in]



## Standard Equipment Received

### Wind Screen Static

For those models that come with a Wind Screen Static – the Wind Screen can be fixed to the front of the model via the four (4) fixing points on the appliance facade using the circular screws provided.

**WARNING: DO NOT OPERATE WITHOUT THE GLASS WINDSCREEN**

**The appliance must be fully assembled before being operated. Failure to install (or removal of) glass panels will void the warranty and render the product unapproved for use with the included burner.**

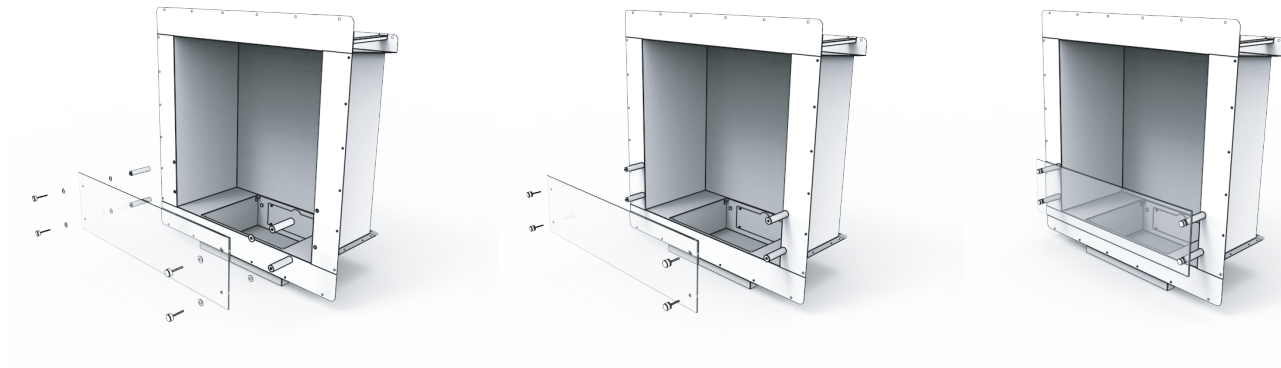

# Markings

The following safety markings are included on the Burner. It is important that you take the time to understand what they mean as failure to follow instructions related to these markings could result in property damage, bodily injury or even death.

## Burner markings

These pictograms are used to bring to your attention the following important safety messages:



**DO NOT FILL WHILE OPERATING**



**DO NOT FILL WHILE HOT**

This warning message is also on all burners to bring to your attention important safety messages:

**WARNING** Filling an alcohol fuelled device while lit has caused severe burns and deaths. When refilling use containers with a flame arrestor. When refilling first check the flame is extinguished and that the device is cool. Hot Surfaces. Keep children away. Refer to the Operations Manual for instructions before use.

## Volume markings

Inside the burner you will see the following fuel level markings. **WARNING!** Never fill above the MAX volume mark.

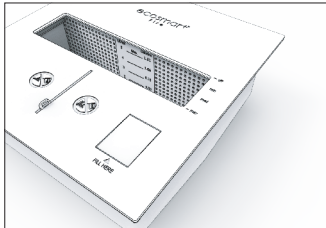

**BK SERIES**

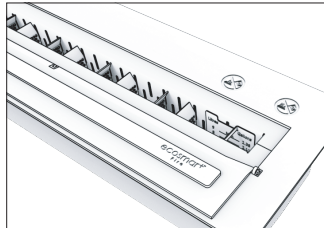

**XL SERIES**

## Slider position markings

These markings on the top of the burner illustrate the various settings the burner can be operated at using the sliding mechanism.

Feature not available for models in the XL Series.

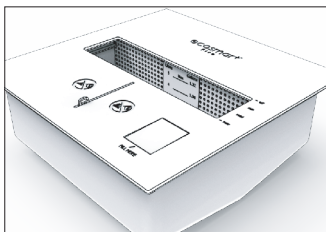

**BK5**

## Lighting rod labels

The Caution and Warning labels that are applied to the lighting rod are included to reinforce important safety messages. This is what they say:

**WARNING: Improper use can cause uncontrolled fire. To reduce fire risk: Never use any fuel other than e-NRG bioethanol (www.e-nrg.com). Never re-use original packaged fuel container. Always store fuel at room temperature in another location separate from the appliance and away from other fuel containers. Never fuel the appliance while it is operating or hot. Always let the combustion chamber cool in accordance with the manufacturer's instructions. If fire occurs: Exit quickly and warn others, call the Fire Department. Do not: Try to move appliance, try to smother fire, or put water on the fire. Hot Surfaces – Keep Children Away – Do not remove the protective guard.**

**CAUTION: Improper use can cause pollution and health problems. To reduce fire risk: Never use any fuel other than e-NRG bioethanol in the appliance (www.e-nrg.com). Operate according to manufacturers instructions. Keep the appliance clean - refer to Operating Manual for instructions. Do not operate at lower than minimum setting. Always operate with the doors of the room open. Follow all applicable code requirements when using this appliance. Keep Instruction Manual.**

## Burner data plate location

Every EcoSmart Fire Burner includes a data plate which provides minimum clearances and safety information. It also includes a unique bar code, serial number and key manufacturing information.

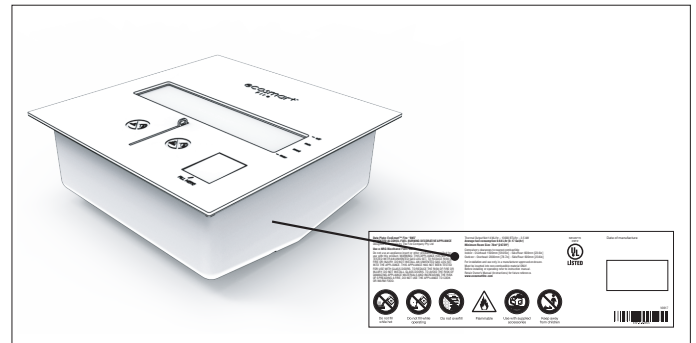

## Package Insert

A warning sheet has been included with the burner to alert you to reading the operations manual in full.



# Clearances & Installation

Ensure that the mouth of the flame is positioned a minimum of 1500mm [59.1in] away from curtains, flammable materials, and other sources of ignition. Be aware of drafts. The floor must be level and the Burner positioned on a flat surface. The Burner must only be placed into non-combustible materials and must be installed in accordance with the outlined safety requirements and clearances. Please send drawings to your local representative to confirm the setting complies with the manufacturer's requirements prior to installation.

## Burner Clearances

EcoSmart Fire Burners can be installed into two (2) types of settings:  
 A. Those that are encased by non-combustible materials similar to that which you would find in a traditional masonry set-up. We refer to this installation type as **"WITHIN A FIREBOX"**

B. Those that are not encased by non-combustible materials and set up in a more modern setting without sides or a top. We refer to this installation type as **"WITHOUT A FIREBOX"**

### A. FIREBOX MEASUREMENTS FOR "WITHIN A FIREBOX" INSTALLATION (Fig. 1)

BURNERS	Minimum Firebox Width (X)	Minimum Firebox Depth (Z)	Minimum Firebox Height (Y)
BK5	650mm [25.6in]	365mm [14.4in]	650mm [25.6in]
XL1200	1500mm [59.1in]	350mm [13.8in]	500mm [19.7in]
XL900	1200mm [47.2in]	350mm [13.8in]	500mm [19.7in]
XL700	1000mm [39.4in]	350mm [13.8in]	500mm [19.7in]
XL500	800mm [31.5in]	350mm [13.8in]	500mm [19.7in]
XS340	450mm [17.7in]	300mm [11.8in]	450mm [17.7in]
AB8/AB8 (EN)	650mm [25.6in]	450mm [17.7in]	800mm [31.5in]
AB3	400mm [15.7in]	350mm [13.8in]	500mm [19.7in]

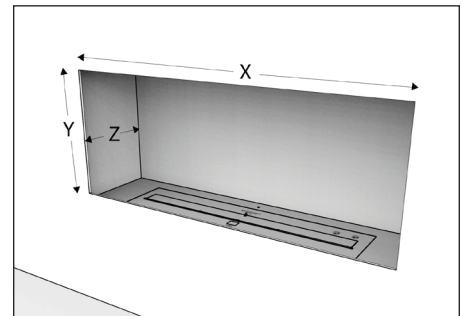

Fig. 1

**\*We recommend centering the burner within the firebox (front and back, left and right). If you choose to offset the burner placement, please follow the minimum distances shown on Table AA. Distances are measured from the outer edge of the burner flange.**

### AA. BURNER PLACEMENT "WITHIN A FIREBOX" (Fig. 2)

BURNERS	Minimum Distance to Front (A)	Minimum Distance to Rear (B)	Minimum Distance to Left (C)	Minimum Distance to Right (D)
BK5	45mm [1.8in]	30mm [1.2in]	125mm [4.9in]	125mm [4.9in]
XL SERIES	50mm [2.0in]	40mm [1.6in]	150mm [5.9in]	150mm [5.9in]
XS340	45mm [1.8in]	65mm [2.6in]	55mm [2.2in]	55mm [2.2in]
AB8/AB8 (EN)	45mm [1.8in]	30mm [1.2in]	145mm [5.7in]	145mm [5.7in]
AB3	45mm [1.8in]	30mm [1.2in]	70mm [2.8in]	70mm [2.8in]

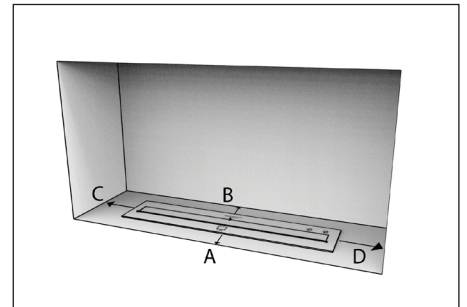

Fig. 2

Custom made fireboxes must:

- Be made out of a non-combustible material such as stainless steel
- Be constructed to accommodate a Top Tray
- have built-in spacers of 20mm (0.8 in.) on all sides to ensure that it does not sit directly against any combustible material and an air gap is incorporated for insulation around the box construction. (Fig. 3)
- Must include a static windscreen that is 180-225mm [7"-9"] high (and the full width of the firebox) to control airflow and prevent flames from coming out of the firebox.

**MAD Design Group recommends using the Burner in a firebox manufactured by MAD Design Group only. MAD Design Group is not liable for any injuries or damages sustained through the use of custom made or privately commissioned fireboxes.**

### VB BURNER

The VB2 burner is specially designed as a 'drop-in' burner system to a purpose-built, existing or new, fireplace setting. You should seek confirmation from the insert manufacturer and install the fireplace according to the manufacturers instructions before inserting the burner.

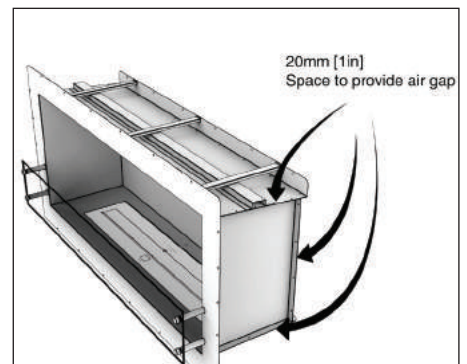

Fig. 3

## Clearances & Installation

### B. BURNER PLACEMENT "WITHOUT A FIREBOX" (Fig.4)

BURNERS	Minimum Indoor Overhead Clearance (E)	Minimum Outdoor Overhead Clearance (F)	Minimum Distance to Combustible Materials (G)
BK5	1500mm [59.1in]	2000mm [78.7in]	600mm [23.6in]
XL SERIES	1500mm [59.1in]	2000mm [78.7in]	600mm [23.6in]
AB SERIES	1500mm [59.1in]	2000mm [78.7in]	600mm [23.6in]

**\*WARNING! Fire hazard. The rear wall should be non-combustible. If it is combustible, you must allow at least 600mm [23.6in] clearance between the wall and the rear of the EcoSmart Fire.**

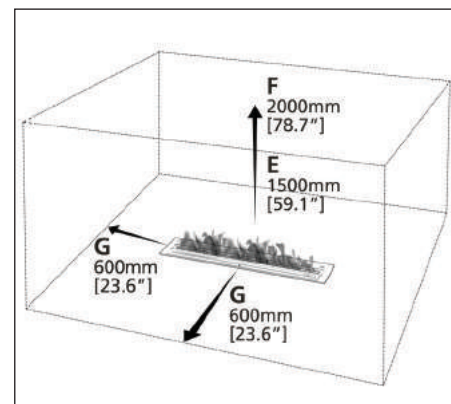

Fig. 4

## Installation

There are many different variations available for installing the Burner. In all cases, the Burner must be:

- Installed into non-combustible material ONLY, such as stainless steel, concrete, brick and natural stone.
- Installed after all gas connections or pipelines in the area are disconnected and made safe by an appropriately qualified and licensed professional.
- Installed and operated in a fixed and secure position before filling, lighting and operating. Burners are not meant to be moved because movement creates the risk of accidental fuel spillages. If you move the Burner, make sure no fuel was spilled before you ignite the Burner.
- Models from each range (Grate/Fireplace Inserts/Designer/Outdoor) have varied installation requirements. Refer to the specific section of the manual for the detailed requirements of the model purchased.
- Mounted into a level surface made of non-combustible materials.

The best location for your EcoSmart Fire is:

- In a large, open space at least 1500mm [59.1in] away from any combustible materials, such as curtains, wallpaper, veneer, etc.
- On a level floor – the floor can be made of any material.
- In a firebox made of non-combustible materials, such as steel, concrete, brick, or natural stone.
- Positioned so that any accumulation of weather debris/pooling of water is eliminated.
- NOT INSTALLED DIRECTLY BESIDE OR NEAR WALLPAPER, LAMINATE, VENEER OR ANY SURFACE THAT HAS NOT BEEN FIRE RATED (THE HEAT WILL IMPACT THE MATERIAL). REFER TO PRODUCT SPECIFICATION OF WALLPAPER, LAMINATE, VENEER OR GLUE FOR HEAT TOLERANCES.
- Installed into a setting that has a straight back – the incorporation of angled backs alters the aerodynamics of the flame environment and could lead to an unstable flame behaviour.
- Fitted within a Top Tray that is not more than 200% the size of the total Burner size. (Not applicable in USA/Canada)

Please note that:

- Any furniture items or fittings directly above or beside the Burner installation must be deemed suitable for heat tolerances by their manufacturer e.g. electronic items including screens and entertainment equipment, wallpaper, laminates, veneers, glues and reconstituted materials.
- A heat reflective panel made of non-combustible material (ideally stainless steel) must be installed as the surround and top of the fireplace setting to assist in heat distribution. MAD Design Group is not liable for any injuries or damages sustained through the use of panels not manufactured by MAD Design Group.
- Glass or mirrored surfaces near the Burner installation must be toughened.
- If inserting a Burner into an existing masonry fireplace, adjust the damper within the existing fireplace in order to keep the heat from escaping through the flue.
- **In some countries, national or rural restrictions may apply and/or approvals from building authorities may be required. Please ensure you contact the appropriate parties before installing your EcoSmart Fire.**

**WARNING! FIRE HAZARD. DO NOT PACK REQUIRED AIR SPACES, (THE AREA BETWEEN THE FIREBOX AND THE SPACER) WITH INSULATION OR OTHER MATERIALS. THE AIR SPACES ARE NEEDED TO MAINTAIN PROPER TEMPERATURE AROUND THE FIREBOX.**

**A fire extinguisher is strongly recommended (AB:E in Australia / ABC in USA).**

### FIRE SCREENS

If installing a fire screen into your setting there must be a 40mm [1.6in] gap between the burner platform and the under side of the glass edge to enable air circulation around the burner. This assists with fuel efficiency, burner temperature and flame quality.

## Clearances & Installation

### Top Tray

The incorporation of a Top Tray into your setting protects against heat transference and aids in the collection of accidental spillage. Some models come with Top Trays, others do not. Top Trays are available as an accessory through MAD Design Group or your local distributor.

**MAD Design Group is not liable for any injuries or damages sustained through the use of Top Trays not manufactured by MAD Design Group.**

When installing multiple Burners a maximum of three [3] Burners may be installed into the one Top Tray (excluding the XL Series which can only have one [1] Burner per Top Tray). Special considerations should be made to multiple Burner installations in order to avoid potential accidents. Contact your local distributor about design and analysis advice to minimise adverse impacts.

Top Trays provided by MAD Design Group are fitted directly into the Burner shelf from above. The Burner is then inserted into the Top Tray setting and adjusted (using the levelling screws) to sit flush.

The size of the cut-out should not give more than 5mm [0.196in] clearance. Top Trays must not be more than 200% of the total size of the corresponding Burner.

**For cut out dimensions for your model please contact your local distributor.**

Physical model dimensions should be verified against cut out dimensions BEFORE installation begins to confirm tolerances align.

NOTE: Top Trays are not required in USA and Canada.  
Top Trays are included as standard in UK and Europe.  
Top Trays are highly recommended in Australia.

### Environmental Conditions

**WARNING: Ensure that your fire is positioned away from flammable materials and other sources of ignition at all times. Pay very close attention to positioning the fire away from items that may move as a result of wind and drafts. For example trees/branches/curtains/paper and the like.**

The base and the sides of the burner must never come into direct contact with combustible materials.

Side clearances to fixed and stable furniture items that are not susceptible to movement such as lounges or patio furniture must remain a minimum of 600mm [23.6in] away from the flame at all times.

Overhead clearances to items that are susceptible to movement (e.g. Curtains/Trees) must remain a minimum of:

- Indoors: 1500mm [59.1in] away from the flame at all times.
- Outdoors: 2000mm [78.7in] away from the flame at all times.

Note: Stainless steel will rust or corrode over time if contamination or debris is not cleaned or removed immediately. When not in use, it is recommended that you protect your fireplace from water damage or corrosion with a protective cover and always use the Burner Lid included with your model to safeguard the burner.

**A fire extinguisher is strongly recommended (AB:E in Australia / ABC in USA).**

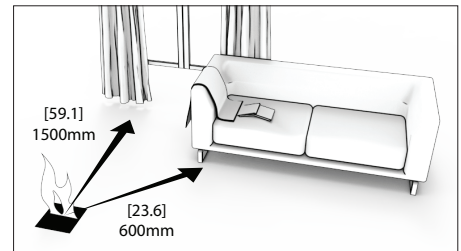

Indoor Clearances

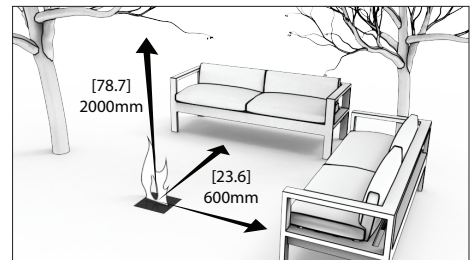

Outdoor Clearances

## Ventilation & Efficiency

### Ventilation

EcoSmart Fires do not require any form of permanent fixture or fitting, such as a flue for ventilation, a permanent connection or any kind of fixed utility for fuel supply.

**Do not cover any existing ventilation systems or structures that are built or installed within the chosen installation area.**

To ensure adequate ventilation, make sure to follow the guidelines in the table shown.

Underwriters Laboratories calculates adequate air exchange as follows:

In a house of typical construction, that is, one that is not of unusually tight construction due to heavy insulation and tight seals against air infiltration, an adequate supply of air for combustion and ventilation is provided through infiltration. However, if the unvented decorative appliance is used in a small room where less than 5.7m<sup>3</sup> [200 cubic feet] of air space is provided for each 1000 BTU per hour of unvented decorative appliance rating (considering the maximum burner adjustment), the door(s) to adjacent room(s) should be kept open or a window to the outside should be opened at least 25.4mm [1 inch] to guard against potential buildup of indoor air pollution. Do not use the appliance in a bathroom or any other small room.

Model	Minimum room size
BK5	The room cannot be less than 70m <sup>3</sup> [2472ft <sup>3</sup> ] <b>per burner.</b>
XL1200	The room cannot be less than 115m <sup>3</sup> [4061ft <sup>3</sup> ] <b>per burner.</b>
XL900	The room cannot be less than 110m <sup>3</sup> [3884ft <sup>3</sup> ] <b>per burner.</b>
XL700	The room cannot be less than 90m <sup>3</sup> [3178ft <sup>3</sup> ] <b>per burner.</b>
XL500	The room cannot be less than 80m <sup>3</sup> [2825ft <sup>3</sup> ] <b>per burner.</b>
XS340	The room cannot be less than 45m <sup>3</sup> [1589ft <sup>3</sup> ] <b>per burner.</b>
AB8	The room cannot be less than 116m <sup>3</sup> [4096ft <sup>3</sup> ] <b>per burner.</b>
AB8 (EN)	The room cannot be less than 116m <sup>3</sup> [4096ft <sup>3</sup> ] <b>per burner.</b>
AB3	The room cannot be less than 40m <sup>3</sup> [1413ft <sup>3</sup> ] <b>per burner.</b>
VB2	The room cannot be less than 45m <sup>3</sup> [1589ft <sup>3</sup> ] <b>per burner.</b>

The ventilation requirements must always be met. The burner must only be installed in areas that are protected from the draft effects of cross ventilation.

## Ventilation & Efficiency

### Efficiency

Burners	Fuel Capacity	Combustion Chamber Volume*	Thermal Output Net (MAX)	Heats on Average When used indoors.	Fuel Consumption	Approx burn time on MAX setting
BK5	5 Litres [1.3 Gallons]	1 Litres [0.26 Gallons]	14 MJ/h 13,000 BTU/h 3.5 kW	Over 35m <sup>2</sup> [376.7ft <sup>2</sup> ]	0.64 L/h [0.17 Gal/h]	7 - 11 hours
XL1200	10 Litres [2.6 Gallons]	1.2 Litres [0.31 Gallons]	17 MJ/h 15,290 BTU/h 4.5 kW	Over 65m <sup>2</sup> [700ft <sup>2</sup> ]	0.87 L/h [0.23 Gal/h]	9 - 14 hours
XL900	9 Litres [2.4 Gallons]	1.3 Litres [0.34 Gallons]	16 MJ/h 15,000 BTU/h 4.4 kW	Over 60m <sup>2</sup> [645ft <sup>2</sup> ]	0.8 L/h [0.21 Gal/h]	8 - 13 hours
XL700	7 Litres [1.8 Gallons]	1 Litres [0.26 Gallons]	14.5 MJ/h 13,650 BTU/h 4 kW	Over 50m <sup>2</sup> [538ft <sup>2</sup> ]	0.7 L/h [0.18 Gal/h]	9 - 12 hours
XL500	5 Litres [1.3 Gallons]	0.6 Litres [0.17 Gallons]	12 MJ/h 11,430 BTU/h 3.35 kW	Over 40m <sup>2</sup> [430.6ft <sup>2</sup> ]	0.5 L/h [0.13 Gal/h]	10 - 13 hours
XS340	2.5 Litres [0.7 Gallons]	0.4 Litres [0.10 Gallons]	8.93 MJ/h 8,530 BTU/h 2.5 kW	Over 20m <sup>2</sup> [215ft <sup>2</sup> ]	0.45 L/h [0.12 Gal/h]	5 hours
AB8	8 Litres [2.1 Gallons]	2 Litres [0.54 Gallons]	21.56 MJ/h 20,433 BTU/h 5.99 kW	Over 60m <sup>2</sup> [645ft <sup>2</sup> ]	1.1 L/h [0.29 Gal/h]	7- 11 hours
AB8 (EN)#	8 Litres [2.1 Gallons]	1.2 Litres [0.32 Gallons]	13.9 MJ/h 12,860 BTU/h 3.77kW	Over 30m <sup>2</sup> [322.9ft <sup>2</sup> ]	0.7 L/h [0.18 Gal/h]	9 - 11 hours
AB3	2.5 Litres [0.7 Gallons]	0.4 Litres [0.10 Gallons]	6.14 MJ/h 5,800 BTU/h 1.7 kW	Over 20m <sup>2</sup> [215ft <sup>2</sup> ]	0.31 L/h [0.1 Gal/h]	8 - 11 hours
VB2	2 Litres [0.5 Gallons]	0.9 Litres [0.2 Gallons]	7.24 MJ/h 6,180 BTU/h 2.5 kW	Over 15m <sup>2</sup> [161ft <sup>2</sup> ]	0.5 L/h [0.13 Gal/h]	6 hours

NOTE: These values are indicative only and may vary depending on the model purchased, installation, and the seasonal resource used to manufacture e-NRG.

\*This figure relates to the area within the appliance where the fuel is intended to be combusted.

# To comply with EN 16647 the AB8 efficiency ring must be installed before operating the burner.

## How to Operate the Burner

Follow these instructions to operate your Burner safely.

### Fuel Type

The EcoSmart Fire Burners are fuelled by a renewable energy source called e-NRG Bioethanol.



**FLAMMABLE!:** Refer to warnings on page 1.

Keep the fuel out of reach of children. Store e-NRG Bioethanol at a safe distance at all times - a minimum of 1500mm [59.1in] from the appliance.

**WARNING: e-NRG Bioethanol is a flammable liquid. Store only in original container or Jerry Can. Store away from all sources of ignition, including pilot lights. Check your local laws and regulations for proper handling and storage.**

### Purchasing your e-NRG Bioethanol.

e-NRG Bioethanol is the ONLY fuel to be used in this appliance.

To order your e-NRG Fuel contact:

Australia

Visit - [www.e-NRG.com.au](http://www.e-NRG.com.au)

Call - 1300 003 NRG

USA

Visit - [www.e-NRG.com](http://www.e-NRG.com)

Call - (888) 670 ENRG

UK

Visit - [www.e-NRG.co.uk](http://www.e-NRG.co.uk)

Or contact your local EcoSmart Fire distributor.

### Regulatory Information for the Safe Handling and Storage of e-NRG Bioethanol

e-NRG Bioethanol is classified as a Dangerous Goods Flammable Liquid Class 3, PGII and is regulated by specific standards and rules. You must familiarise yourself with the appropriate regulations of your country in order to safely and legally store, handle, decant and use this fuel.

e-NRG Bioethanol containers are recyclable and should be disposed of accordingly.

### Decanting your e-NRG Bioethanol into the Jerry Can

To view a video of fuelling your Fire, visit our website at [ecosmartfire.com](http://ecosmartfire.com) and click on Fire Safety.

Decanting must be performed in a well-ventilated area to ensure that any spillage is easily contained and away from any ignition source.

**NOTE: Never fill the burner using a vessel that does not have the Spill Proof Safety Spout attached.**

The burner can **ONLY** be filled following one of the two methods outlined below.

#### A. USING THE JERRY CAN INCLUDED WITH THIS BURNER:

1. Remove the nozzle from your Jerry Can.
2. Carefully decant the fuel from the bottle into the Jerry Can through its opening, avoiding spillage (you may need to decant multiple bottles depending on the packaging volume purchased). If spillage occurs, clean thoroughly before proceeding. (Refer to Troubleshooting on page 20).
3. Re-screw the cap tightly back onto the Jerry Can to contain fuel and avoid accidental spillage.
4. Test that it is closed securely before moving away from your decanting area.
5. You are ready to approach the Burner.



#### B. USING THE e-NRG FUEL BOTTLE:

1. Remove the cap from the fuel bottle.
2. Attach the adapter to the fuel bottle.

**WARNING:** Fuel containers without flame arresters, if used improperly, can result in the inflammation of the fuel within the container, which may cause personal injury or property damage. Never fill the burner directly from the e-NRG bottle, risk of explosion.

3. Attach the Spill Proof Safety Spout to the adapter. Test that it is closed securely before moving away from your decanting area.
4. You are ready to approach the Burner.





## How to Operate the Burner

### Decanting your e-NRG Bioethanol from the Jerry Can into the Burner

To view a video of fuelling your Fire, visit our website at [ecosmartfire.com](http://ecosmartfire.com) and click on Fire Safety.

**WARNING: Fire hazard. Be sure Burner is cool before filling. Let stand at least 60 minutes after flame is extinguished before refilling.**

**WARNING: Refuel only through the filling point. Never pour fuel directly onto the burner.**

**WARNING: Fire hazard. Do not overfill. Fill only to MAX mark. Never lift the Jerry Can to allow faster flow – insert the spout fully and rest it on the base of the grid. Used properly, the Jerry Can spout will help prevent over-filling and spillage.**

**WARNING: If the fire setting includes multiple burners, all burners must be OFF and cooled during the filling procedure. Turn all burners off and allow all burners to cool before refilling a burner. Finish re-fuelling all burners before lighting each burner.**

As an additional safety measure, we recommend that you remove the burner and check that there is no unexpected fuel collection in the Top Tray.

MAD Design Group recommends that the quantity of e-NRG Bioethanol poured into the burner be burnt until empty rather than extinguishing the fire early. Extinguishing the fire early can result in a larger amount of residual fumes in the Burner and a more volatile re-ignition.

When fumes are combined with excess fuel it could be a hazard to people who are unaware of the Fire operation and its condition of use (e.g smokers). Ensure only those who have read the instructions attempt to operate the burner.

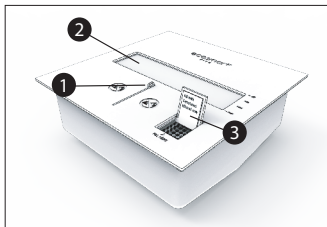

1. Remove the transport locking strip and position the slider mechanism setting so the chamber is fully open.
2. Inspect inside the burner mouth to ensure it is clean and clear of any foreign particles.
3. Access the filling point by flipping the small lid which is located in the bottom right corner of the burner.

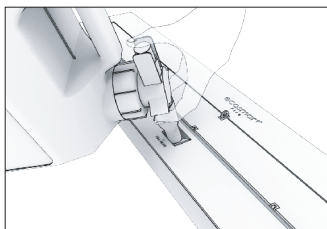

**XL Series (Not applicable for XS340):** The XL Series feature a spring loading cap. It is engineered so that the Jerry Can spout is fully enclosed prior to releasing the fuel supply, thus allowing filling at a high rate, whilst eliminating splashing as the fuel is being decanted.

The XL flame is most visible when the burner is filled to the MAX line.

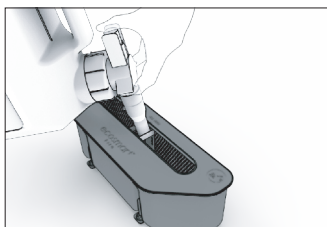

**VB2 & XS340**  
To fill the VB Series, position the Jerry Can spout in the middle of the burner mouth.

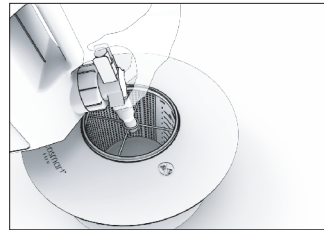

**AB Series:**  
To fill the AB Series, position the Jerry Can spout in the middle of the burner mouth.

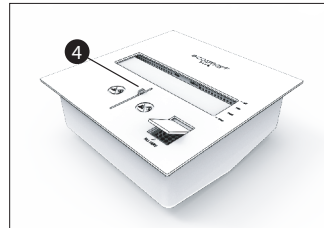

4. Re-position the Burner slider ensuring the grid work of the burner is visible through the filling point. This will clear the filling point for the insertion of the Jerry Can spout as well as allowing visual monitoring of the amount of fuel being added, according to the volume markings on the Burner.

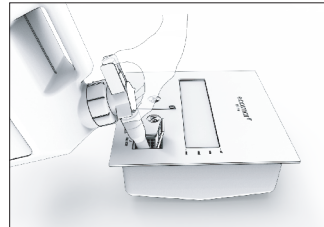

5. Once ready, carefully place the Jerry Can spout inside the filling point. **NEVER** fill over the maximum level as indicated on the burner vent inside the Burner and only fill to the level that you require for burning time.

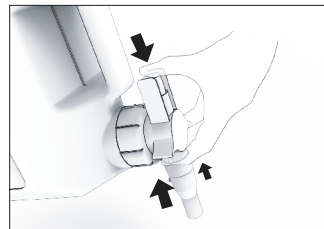

6. Use both hands to pour. Place the palm of one hand on the top of the nozzle with your thumb on the green button.

Use your other hand to tip the can vertically and hold it steady. Press down on the green button to release the fuel. To stop the flow, simply release the green button.

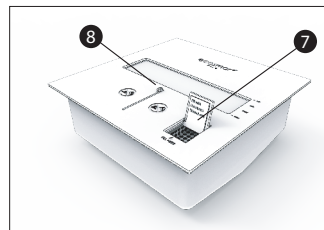

7. When filling is complete, flip the lid that covers the filling point so it closes the filling point.

8. Re-position the slider to the fully open position. Check surrounding area for any spillage. **WARNING: Fire hazard. Clean up any spilled fuel before lighting the burner. See Troubleshooting page 20 for clean-up procedure.**

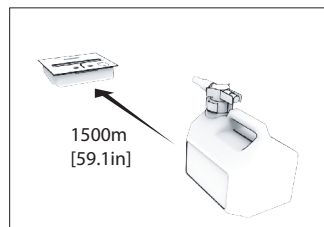

9. Make sure that the Jerry Can is at least 1500mm [59.1in] away from the fireplace before you ignite the fire.

## How to Operate the Burner

### Lighting the Burner

To view a video of *Lighting the Burner*, visit our website at [ecosmartfire.com](http://ecosmartfire.com) and click on *Fire Safety*.

**WARNING: If the fire setting includes multiple burners, all burners must be OFF and cooled during the filling procedure. Turn all burners off and allow all burners to cool before refilling a burner. Finish re-fuelling all burners before lighting each burner.**

**Keep hands and face the length of the lighting rod away from the Burner at all times, particularly when igniting.** Before lighting, ensure that the Burner is clear and ready for use. Open the slider fully and wait for 60 seconds for the residual fumes to dissipate before lighting.

Check the slider is free from obstruction and operating smoothly. (Refer to Troubleshooting section on page 20 if difficulties are experienced).

Do not smoke while lighting the Burner, and make sure that no one is in front of the fireplace while igniting the Burner. Only use the lighter supplied with your EcoSmart Fire.

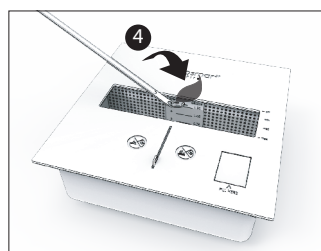
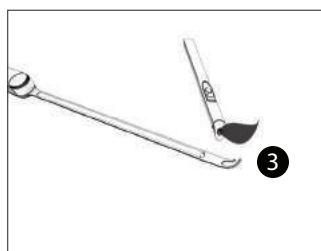
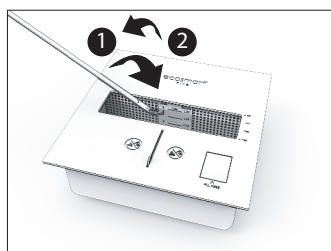

1. Dip the lighting rod tip into the chamber opening "Burner zone" to wet the end.
2. Lift the lighting rod away from the Burner (do not drip fuel on the floor).
3. Ignite the lighter and make contact with the lighting rod as if lighting a candle.
4. Dip the ignited lighting rod back into the Burner zone to ignite the contained fuel.
5. Allow residual flame on lighting rod to burn out.

NOTE: The XL1200, XL900 & XL700 is best ignited from the right hand side of the ignition zone.

Once lit there will be a residual flame on the lighting rod that must burn out before putting the rod away. If the flame on the lighting rod dies before reaching the burner, repeat the procedure until successful.

Due to some residual oil in the fibres we use in the Burner there is a stronger smell when first operating. It will decrease substantially after the first few times you use the Burner, and even more so over time. To minimise this, wash the burner out in hot water before using. The Burner must be completely dry and cool before filling with fuel.

### Regulating the Flame

Wait until the fire is established (approx 10 minutes) before regulating.

To decrease the flame intensity insert the lighting rod tip through the circular ring and push forward gently to desired setting. Only use the lighting rod supplied with your EcoSmart Fire to avoid hand burns.



To increase the flame intensity insert the lighting rod tip through the circular ring and pull back gently to desired setting. Only use the lighting rod supplied with your EcoSmart Fire to avoid hand burns.

### Baffles (XL Series) / Efficiency Ring (AB8 Burner)

These efficiency devices are a standard inclusion with the XL Series and AB8 Burners. Baffles (or Rings) are placed over the internal burner vents when cold and not operating and serve to increase the efficiency of the burner as well as further stabilise the flame of the burner. (XL1200 - 5x Baffles, XL900 - 4x Baffles, XL700 - 3x Baffles, XL500 - 2x Baffles, AB8 - 1x Efficiency Ring). To comply with EN 16647 the AB8 efficiency ring must be installed before operating the burner.

Note: Regulatory function and accessories not applicable to XS340, VB2 and AB3 – in these models, the control must be in the fully ON or fully OFF position only. The flame cannot be adjusted.

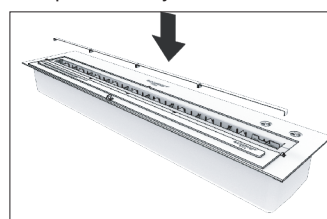

XL1200 5 x Baffles



AB8 1 x Efficiency Ring

**Important:** All Burner parts will age over the course of time through natural processes associated with use, heat and flame.

Please also note that new stainless steel has an oil coating that will burn off during the first few uses. You will notice an accumulation of carbon around the top opening of the Burner zone and its vents. This will appear quickly and is normal. You will need to perform your first maintenance after approximately 20 litres [5.28 Gal] of e-NRG Bioethanol burnt.

After this, the accumulation will be far slower and maintenance can then occur every 50 litres [13.20 Gal] of e-NRG Bioethanol burnt. If anything abnormal appears, do not operate the appliance. If the fire is running, turn it off immediately and contact your distributor before using again.

## How to Operate the Burner

### Turning your Burner OFF - Extinguishing the Flame

To view a video of extinguishing your Fire, visit our website at [ecosmartfire.com](http://ecosmartfire.com) and click on Fire Safety.

1. Let it burn until the fuel is consumed. The flame will extinguish when no fuel is left.
2. Use the lighting rod to move the circular ring to the fully OFF position.

**WARNING: Fire hazard. With either method, let burner cool for at least 60 minutes before refueling.**

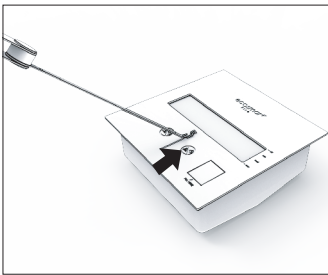

#### **XL Series:**

The XL Series have a flip lid shut-off mechanism. The lid flips across the ignition zone which extinguishes the flame.

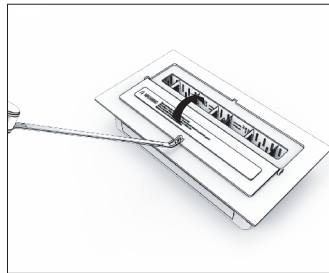
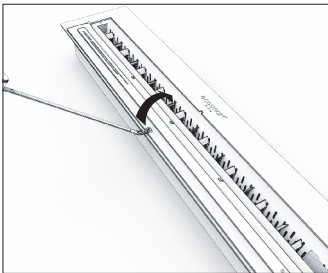

#### **AB Series and VB Series:**

A lid is used to extinguish the flame.

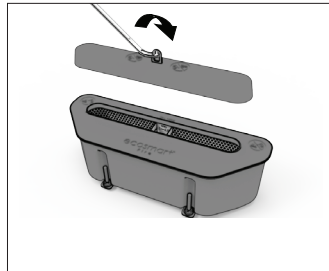
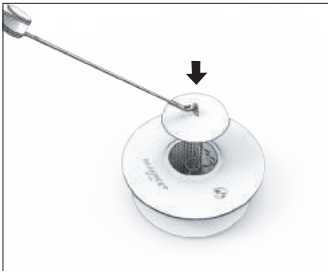

### Re-igniting the Burner

#### **WARNING!**

- **NEVER LEAVE A FIRE UNGUARDED.**
- **ONLY USE e-NRG BIOETHANOL IN THE BURNER.**
- **IGNITION OF THE LIGHTING ROD SHOULD ONLY BE PERFORMED ABOVE AND BESIDE THE BURNER TO AVOID DRIPPING THE FUEL AT ANY STAGE OF THE LIGHTING PROCESS OUT OF THE FIREPLACE ONTO THE FLOOR.**
- **THE BURNER MUST NOT BE FILLED AT ANY TIME WITH ADDITIONAL e-NRG BIOETHANOL WHEN THE FLAME IS GOING OR WHEN THE BURNER IS HOT.**
- **AN INHERENT DANGER WITH e-NRG BIOETHANOL IS THAT THE FLAME PRODUCED CAN BE NEARLY INVISIBLE IN NORMAL DAYLIGHT CONDITIONS OR WHEN FIRST LIT. BEING DIFFICULT TO SEE, AN INEXPERIENCED PERSON CAN EASILY ASSUME THE BURNER IS EMPTY AND NEEDS FILLING.**

**ASSUME BURNER IS LIT, EVEN IF YOU DON'T SEE FLAME. FOLLOW PROCEDURE TO EXTINGUISH FLAME AND ALLOW UNIT TO COOL BEFORE ATTEMPTING TO REFUEL. NEVER REFUEL WITH BURNER LIT OR WHILE UNIT IS HOT.**

1. Move the slider/hinge so the Burner opening is fully open.
2. Wait 60 minutes before re-igniting the Burner. The Burner should be at room temperature. Please be aware that if this time is not respected the ignition could be pressurised and therefore stronger. A pressurised ignition can cause serious burns if you are close to the Burner.
3. Re-ignite as described in "Lighting the Burner".

---

## Regular Safety Checks

---

**Like all fire and fireplace systems, it's important to run through regular safety checks. Please take the time to familiarise yourself (and any other users) with the safety procedures associated with using your EcoSmart Fire.**

- e-NRG bioethanol is the ONLY fuel suitable for use in this appliance.
- Check your burner is in good working condition, the shut off mechanism is working smoothly, the filling point is accessible and effective, nothing foreign has fallen into it and make sure there is no visual or physical damage to the burner
- Frequently inspect all around the installation – including lifting the burner out of its position to ensure that no fuel has accumulated in or around the setting at any time
- Take out your operations manual and refresh your memory on the operational procedures for using this product – it's available on our website too
- Give your burner a good clean, they can be washed out with hot soapy water and left to dry - or pop it in your dishwasher on the hot pan cycle with detergent (refer to your Operations Manual)
- Check the operation of your Jerry Can, fire extinguisher, lighter and lighting rod to ensure you have the right tools to use for safely operating your fire - replacement accessories are available from your closest distributor
- Check your fuel supply is stored according to regulations – if you are unsure contact your local distributor
- Check that all flammable items are within safe distance from the flame – that's a minimum of 1500mm [59.1in] at all times in all conditions
- And remember, never overfill your burner, never fill your burner whilst it is in operation or hot, never leave a fire unguarded and never leave children unsupervised

## Caring for your EcoSmart Fire

**Maintenance and cleaning must only be performed when the Burner is OFF, COMPLETELY EMPTY & DRY and at ROOM TEMPERATURE.**

If service is required, there are two specific areas to check for cleaning. These are the Burner and the firebox or immediate surrounds in cases where a firebox has not been installed.

General surrounds are maintained as you would a standard piece of furniture by dusting and polishing the surfaces on a regular basis during your general cleaning routine.

### **POWDER-COAT SURFACES**

The powder-coat will be damaged if you drip bioethanol on it when the burner is not completely cold. **WARNING!** Never fill the burner when it is hot. Refer to warnings on pages 3 & 4.

Take care not to scratch the powder-coat with the lighting rod. The powder-coat is fragile when the burner is hot.

Use only a soft cloth and warm soapy water to clean any product that has been powder-coated.

### **Cleaning the Burner**

**The surface of the Burner will change colour on very hot spots.**

In addition, over time a film of black residue will appear on the two vents of the Burner, usually starting from the MAX line within the Burner on the slider, and around the burning zone of the Burner top.

Remove with care – the black residue is a carbon left over from the combustion. It stains.

1. When the fire is off and empty, use a vacuum cleaner for general cleaning on visible surface.
2. Brush/scrape the black material gently from the vents and the slider towards the bottom inside of the Burner.
3. Use a vacuum cleaner to remove residue inside the Burner, around the slider rails and around the top opening of the burning zone.
4. To finish cleaning use a damp disposable cloth and wipe until no residue remains.

Clean your unit after you have used 50 liters [13.20 Gal.] of fuel or as soon as you notice black deposits on or near the Burner.

Black marks can be removed from the stone, solid surfaces or stainless steel with a mild abrasive washing product such as JIF® or similar. It is recommended to test a small area first to ensure the cleaning product chosen is appropriate and will not mark or damage the surface.

After extensive use, if your Burner smells unusually strong – when empty and cold, remove the Burner from its setting and wash the Burner in hot, soapy water and rinse thoroughly under running water. Let it dry before replacing in unit.

### **Cleaning the Firebox**

As the stainless steel is exposed to flame and heat for a long period of time, its colour will eventually change.

To clean:

1. Use a disposable damp cloth to wipe the surface that needs cleaning (go with the grain) using a mild abrasive product such as JIF®. Rinse well with a wet cloth.
2. After cleaning do not light the fire until all surfaces are completely dry. You can enhance the shine by using a stainless steel cleaner and polish. Spray it on a disposable cloth and wipe the surface until you achieve an even shine.

Any stainless steel cleaner and polish leaves a residual film on surfaces. This film will burn off and appear black when directly exposed to the flame, so be careful not to apply too much and rinse away thoroughly.

## Troubleshooting

### 1. There is smoke or a foreign smell coming from the Burner when burning

- There may be waste burning that should not be in the Burner.
- You are using the wrong fuel (it is imperative that you **ONLY** use e-NRG Bioethanol).
- You have placed something around/above the flame that has not been approved or recommended.
- If the Burner is empty (the flame is dying) or you have just turned the fire OFF, this is normal. Just like when you blow out candles.

#### Solution

Shut the Burner to the OFF position and wait until it cools down. Clean/service the Burner and remove objects/waste.

### 2. When I attempt to light the Burner, it does not start

- You have not put enough fuel in the Burner.
- You have not used the right fuel (it is imperative that you **ONLY** use e-NRG Bioethanol).
- The Burner opening is obstructed, there needs to be adequate ventilation for the flame to start.
- The e-NRG Bioethanol is cold and takes time to ignite.
- If used outdoors, the fuel may have been diluted with rain water.

#### Solution

Check fuel level, it must be above the 1 litre [1 Quart] line, check type of fuel used, and open the slider/hinge. Repeat starting procedure until the Burner warms up and remains ignited. If filled with water, empty burner, clean and clear Burner and re-set up ready for re-filling.

### 3. The flame is not extinguishing when turned OFF

- It may be that the speed used to close the Burner opening was too slow.
- There are particles obstructing the shut-off mechanism.

#### Solution

Ensure that there is nothing obstructing the shut-off mechanism. Attempt to extinguish again smoothly with the shut-off mechanism. If it does not extinguish, burn the fuel until empty and the flame dies out naturally and contact your distributor. Do not use again until it has been serviced.

If you have overfilled the Burner and the flame is burning strong, prepare your extinguisher just in case, and monitor the flame till the situation goes back to normal as you will not be able to turn it OFF. Do not blow or throw a blanket on it. Do not pour water on it.

### 4. The slider/hinge cannot be pushed/pulled/flipped into position when hot/cold

- The Burner slider/hinge is dirty or filled up with debris left after combustion.
- There may be something stuck or obstructing the shut-off mechanism e.g. something may have fallen into the Burner.
- The Burner has been physically damaged internally (e.g. if it has been dropped).

#### Solution

Clean/service the Burner and see if you find the obstruction. If you do not find anything, contact your distributor. Do not use again until it has been serviced.

### 5. I have spilt some fuel, what do I do before lighting?

Remove all ignition sources. Keep people away from the area. Wipe up spilt liquid thoroughly using a dry cloth, wipe again with a cloth dampened with water. Avoid breathing vapours. Ventilate enclosed space by opening windows and doors.

ONLY ignite when the area is completely dry and you are certain that all spilt fuel has been removed. Please refer to SDS for e-NRG Bioethanol.

### 6. The flame is unusually volatile and high

This is likely to be caused by a strong draft blowing on the flame.

Locate and remove the source of the draft (it may be that you have a window/door open or fan operating that is directly pushing air towards the fire). If you cannot remove the source of the draft and the flame is too volatile, turn the fire OFF. You will need to rethink the positioning of your unit before operating again or install a firescreen to minimise the draft effect. Contact your distributor.

### 7. The Jerry Can doesn't work properly

Please contact your distributor for further instructions. Do not attempt to fill the Burner with an unapproved alternative fuel can.

## Your Warranty

Your EcoSmart Fire is covered by a transferable limited warranty and a solid service and support network should you need it. At MAD Design Group, we believe in supplying you with the best, most user friendly fireplace and providing you with the means to keep it that way. Many aspects of the EcoSmart Fire are hand-produced, hand-finished and use natural materials, which makes them subject to variations in finish and size.

All of our pieces will mature and age over the course of time, through natural processes associated with use and with heat and flame. These changes are an essential part of the dynamic of the piece. MAD Design Group reserves the right to make minor amendments without prior notice.

Length of warranty	MAD Design Group undertakes to:	The express warranties do not include:
<p><b>TWO YEAR WARRANTY</b> FROM DATE OF PURCHASE ON STAINLESS STEEL PARTS INCLUDING RAW, LISHED AND POWDER COATED.</p> <p><b>ONE YEAR WARRANTY</b> FROM DATE OF PURCHASE ON MILD STEEL INCLUDING POWDER COATED AND CHROME PLATED, CEMENT, GLASS, LEATHER, FABRIC AND MDF (PAINTED OR CEMENT RENDERED).</p> <p>Chips and scratches are not covered by warranty. Natural variation in color, texture and porosity may occur with Concrete Composite products and are considered inherent and valued qualities of the material. Non-structural hairline cracks are possible and shall not be considered a manufacturing defect.</p>	<p>Repair or, at our option, replace without cost to owner either for materials or labour, any part that is found to be defective.</p>	<p><b>A. Service calls to:</b></p> <ol style="list-style-type: none"> <li>1. Correct the installation of the Fire.</li> <li>2. Instruct you how to use the Fire.</li> </ol> <p><b>B. Repairs</b> when the EcoSmart Fire has been used in other than normal domestic/commercial use or when not used in accordance with the Installation, Operating and Maintenance Manual.</p> <p><b>C. Repairs</b> when the EcoSmart Fire parts or models have been modified or altered in any way that has not been approved in writing by MAD Design Group.</p> <p><b>D. Repairs</b> when the Fire has been dismantled, repaired or serviced by anyone other than an authorised representative of MAD Design Group.</p> <p><b>E. Pick up and delivery.</b></p> <p><b>F. Normal maintenance</b> as required in the Installation, Operating and Maintenance Manual supplied with the EcoSmart Fire.</p> <p><b>G. Transportation or traveling costs</b> involved in the repair when the appliance is installed outside MAD Design Group AUTHORISED CUSTOMER SERVICE CENTRES's normal service area.</p> <p><b>H. Damage to the Fire</b> caused by accident, misuse or Act of God.</p> <p><b>I. Any incidental shipping or holding costs</b> to deliver your Fire or parts to an Authorized Customer Service Centre.</p>

The Warranties set out are express Warranties given by the manufacturer and are in addition to the rights and remedies which are conferred upon consumers by the Competition and Consumer Act 2010 of the Commonwealth and other Commonwealth, State or Territory legislation.

**Service under the warranties set out above must be provided by MAD Design Group Authorised Customer Service Centre which shall provide service during their normal working hours.**

**This warranty certificate along with proof of date of purchase must be produced when making any claim.**

FIRST NAME \_\_\_\_\_

LAST NAME \_\_\_\_\_

EMAIL \_\_\_\_\_

CITY \_\_\_\_\_ STATE \_\_\_\_\_ ZIP \_\_\_\_\_

COUNTRY \_\_\_\_\_

DATE OF PURCHASE \_\_\_\_\_

PURCHASED FROM \_\_\_\_\_

PRIMARY USE \_\_\_\_\_

MODEL NAME \_\_\_\_\_

SERIAL NUMBER \_\_\_\_\_

*You will find this on the dataplate on the side of the burner.*

For warranty claims please contact your local distributor. If there is not a local distributor in your country please visit **www.ecosmartfire.com** to source the details of the country closest to you.

\*Do not return this form to MAD Design Group, please retain for your own reference.

---

## After Sales Service

---

**It is our aim for you to be totally satisfied with your EcoSmart Fire product. NOTICE: If you need service or assistance, we suggest you follow these steps.**

### **After Sales Service for your EcoSmart Fire**

MAD Design Group offers an international network of authorised service agents. The use of other than approved EcoSmart Fire parts and accessories may damage or reduce the performance of your Fire and may also endanger the user. The Terms and Conditions of warranty may also be affected. A full list of contacts can be found on [www.ecosmartfire.com](http://www.ecosmartfire.com)

### **Please note**

Charges will apply for services performed outside the warranty period. If you are asked to send your Fire into a service centre please ensure that it is securely packed in materials equivalent to how you received your Fire to avoid possible damage that will not be covered by MAD Design Group. Freight must be pre-paid. Include a covering letter outlining the defect and your contact details.

### **1. Before calling for assistance**

Check the things you can do yourself. Refer to the Installation, Operating and Maintenance Manual supplied with your Fire to ensure that it is correctly installed and that you are familiar with its normal operation.

### **2. If You Need Service\***

MAD Design Group has a network of independent EcoSmart Fire Authorised Customer Service Centres whose fully trained technicians can carry out any service necessary on your appliance.

Contact the dealer from whom you purchased the appliance, who can advise you where to obtain service.

### **3. If you need assistance or have a problem\***

If you need assistance or have a problem please contact your local retailer or distributor, or visit [www.ecosmartfire.com](http://www.ecosmartfire.com) for Head Office details.

Talk to one of our customer service representatives. They can instruct you in how to obtain satisfactory operation from your appliance or, if necessary, recommend an Authorised Customer Service Centre in your area.

\*If you must call or write, please provide: Name and Address, Model Number, Serial Number, Date of Purchase, venue and a complete description of the problem. This information is needed in order to better respond to your request for assistance.

Reproduction of this manual in any manner, in any language, in whole or in part without prior written permission is prohibited. MAD Design Group reserves the right to correct any errors or misprints. We also reserve the right to alter information without notification. The information provided herein is believed to be correct but is not guaranteed.

International Patent Pending – Trademarks Pending – All Designs Registered.