

COMPONENTS

RC	CORNER BRACKET	x4	
UC	UPRIGHT CORNER BRACKET with attached 4 x FLANGED BUSHES	x2	
B	NYLON SPIGOT	x4	
D	MULTI-SURFACE ANCHOR (80mm)	x4	
E	GROUND PEG	x8	
F	NYLON STANCHION ELBOW	x2	
G	NYLON LOWER BACK STANCHION CONNECTOR	x2	
J	M10 SOCKET DOME SCREW AND HEX DOME NUT - 80 mm LONG	x12	
K	M8 HEX SCREW AND HEX DOME NUT - 50mm LONG	x8	
FXB	SLOT NET FIXINGS	x28	
NT	NET TIES	x26	
AK	HEX KEY FOR COMPONENT J	x1	
NET	GOAL NET	x1	

80 ALUMINIUM FLAT-PACK 6' X 4' GOAL

CARE & MAINTENANCE - see separate sheet supplied or visit www.itsagoal.net for additional copies. Our goalpost if used correctly will last many years. We do also offer a full spare part service and if your goals need refurbishment this can be arranged.

FITTING GOALPOST SLOT NET FIXINGS

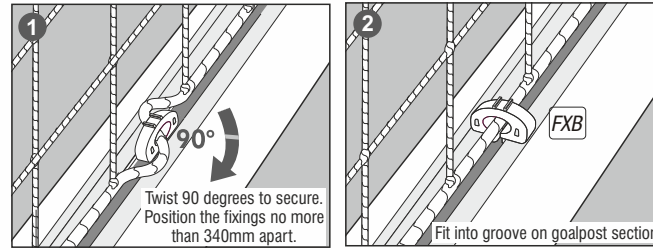

FITTING INSTRUCTION



www.itsagoal.co.uk

TEL: 0114 24 34 200
SPARE PARTS

POST SECTIONS

Aluminium Sections and Tubes

M	CROSSBAR SECTION 1726 mm LONG - 80mm Diameter	x1	
N	BACKBAR SECTION 1726 mm LONG - 80mm Diameter	x1	
O	SIDEBAR SECTION 80mm Diameter	x2	
P	UPRIGHT SECTION 80mm Diameter	x2	
Q	TOP STANCHION TUBE 40mm Diameter	x2	
R	BACK STANCHION TUBE 40mm Diameter	x2	

GOAL POSTS MUST BE ANCHORED AT ALL TIMES

Optional longer pegs are available for use on sandy ground. On grass, a risk assessment of soil and weather conditions suitability should be carried out when anchors or optional counter weights are to be used. TEL: 0114 2434200

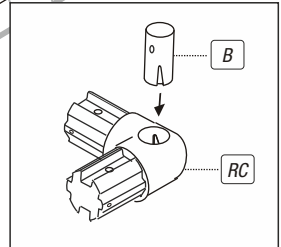
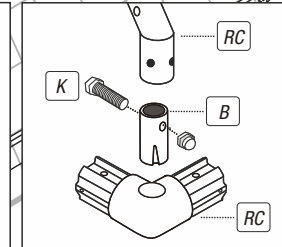
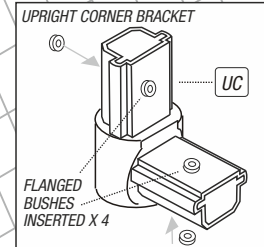
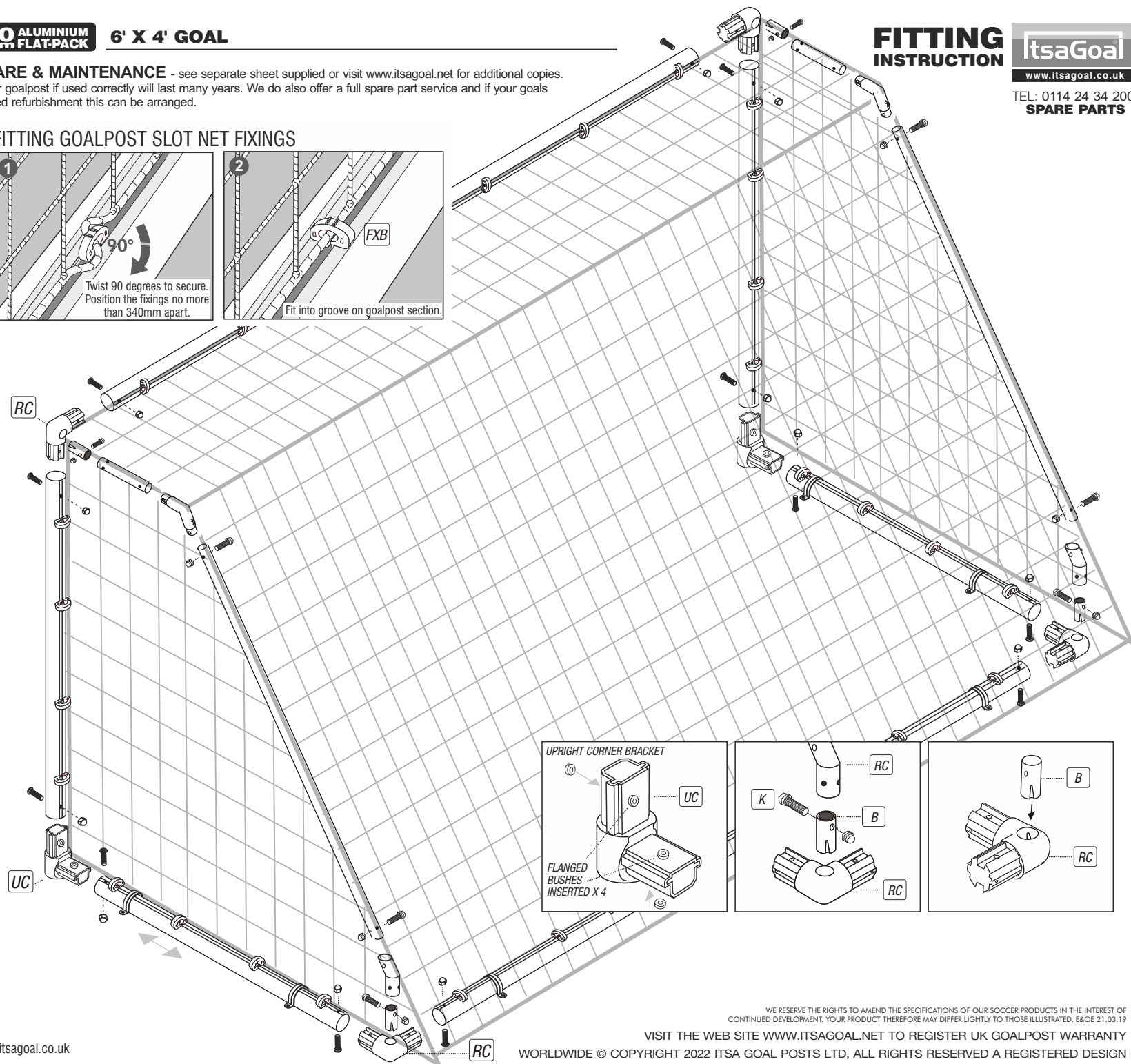

Visit our YouTube site for assembly videos :
www.youtube.com/user/Footballgoalposts

Goalpost spare parts and replacement nets are available at - www.itsagoal.co.uk

WE RESERVE THE RIGHTS TO AMEND THE SPECIFICATIONS OF OUR SOCCER PRODUCTS IN THE INTEREST OF CONTINUED DEVELOPMENT. YOUR PRODUCT THEREFORE MAY DIFFER LIGHTLY TO THOSE ILLUSTRATED. E&OE 21.03.19

VISIT THE WEB SITE WWW.ITSAGOAL.NET TO REGISTER UK GOALPOST WARRANTY

WORLDWIDE © COPYRIGHT 2022 ITSA GOAL POSTS LTD, ALL RIGHTS RESERVED A REGISTERED DESIGN

STEP BY STEP FITTING

STEP 1

Lay out and check all posts shown below
Also check you have all the components.

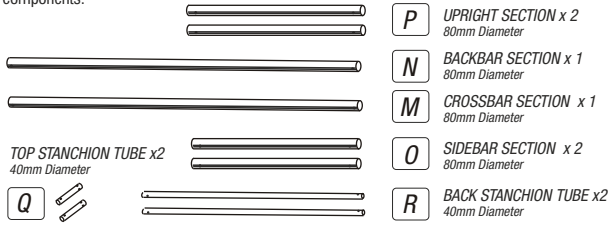

STEP 2

Insert spigot B into corner bracket RC (x 4)

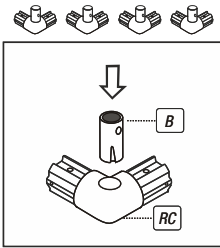

STEP 3

Using two of the corner brackets from step 2, insert Lower back stanchion connector G into the spigot B, fix with nut and bolt K (x 2)

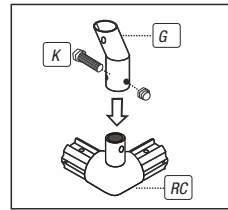

STEP 4

Insert upright corner bracket UC into side sections O, fix with nut and bolt J. Insert the corner bracket RC with the insert spigot B and lower back stanchion connector into the side section O. Connect the back bar section, bolt both ends with J.

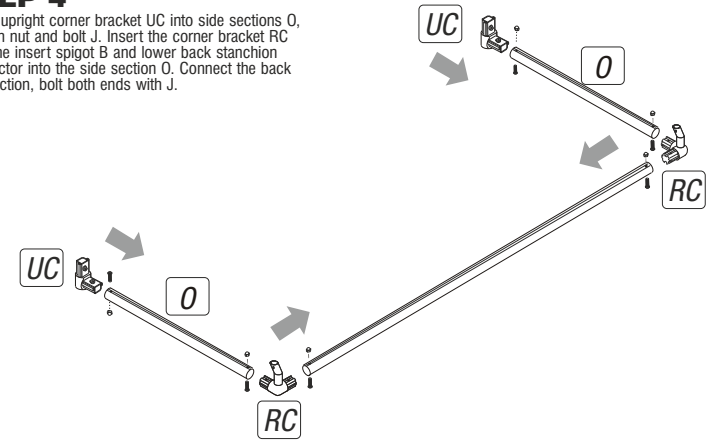

STEP 5

With the ground base assembled now insert the upright posts P into the upright corner brackets UC and Bolt with J, support the uprights from falling with a second person until you have the remaining crossbar and back supports fitted in step 6 & 7.

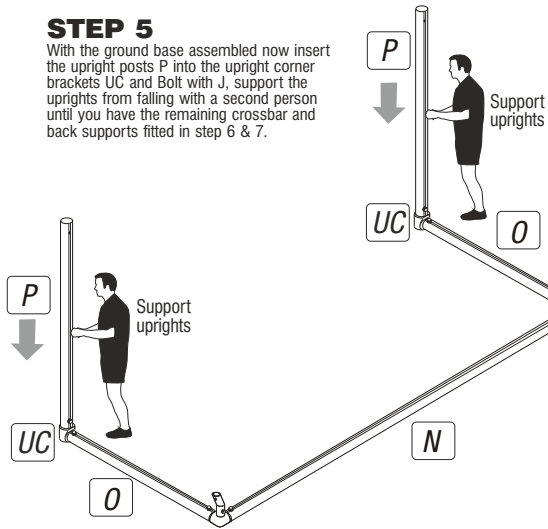

STEP 6

Connect the corner brackets RC into the crossbar M with the nuts and bolt J. Insert the crossbar with fitted corner brackets RC into the upright posts.

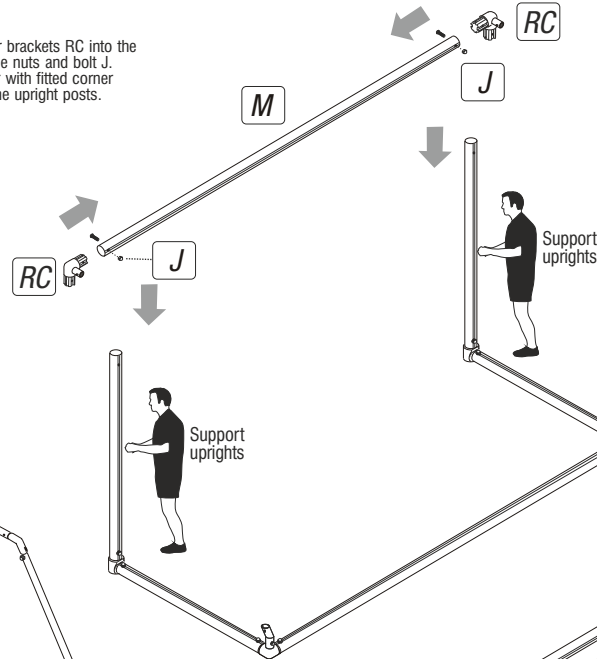

STEP 7

Fit the nylon stanchion elbow F into the top stanchion tube Q and also the back tube stanchion R, connect with nuts and bolts K. With the full back stanchion assembled insert it into the corner bracket with fitted spigot at the top of the upright, and the lower back stanchion connector G

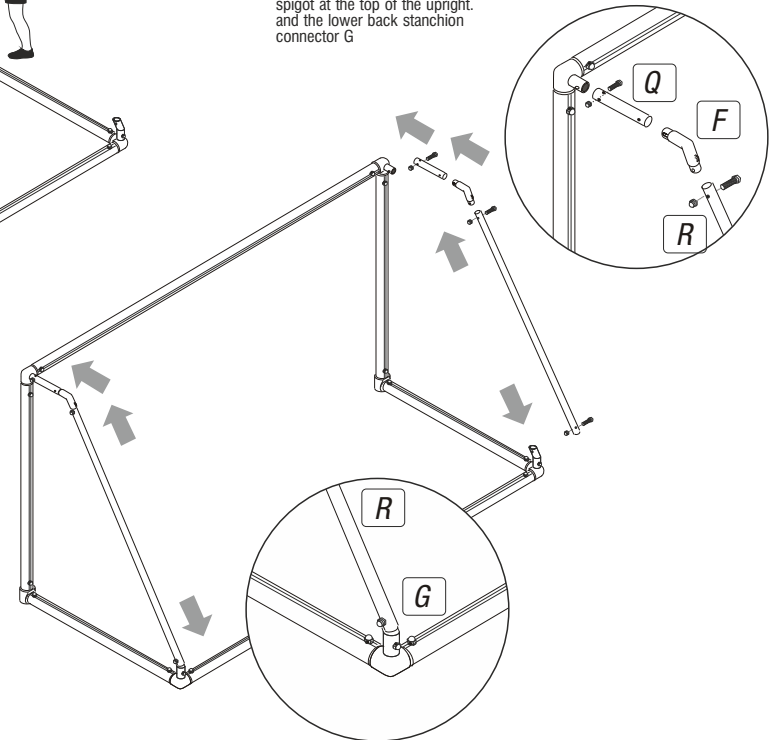

FITTING GOALPOST SLOT NET FIXINGS

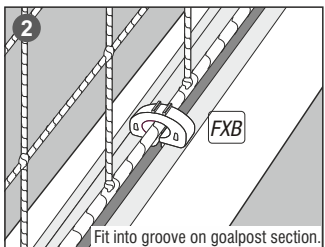
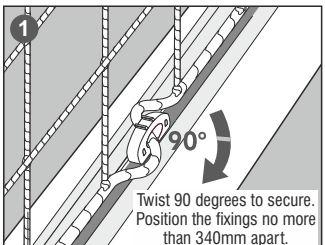

STEP 8

Insert all net fixings & fit the net - see over page

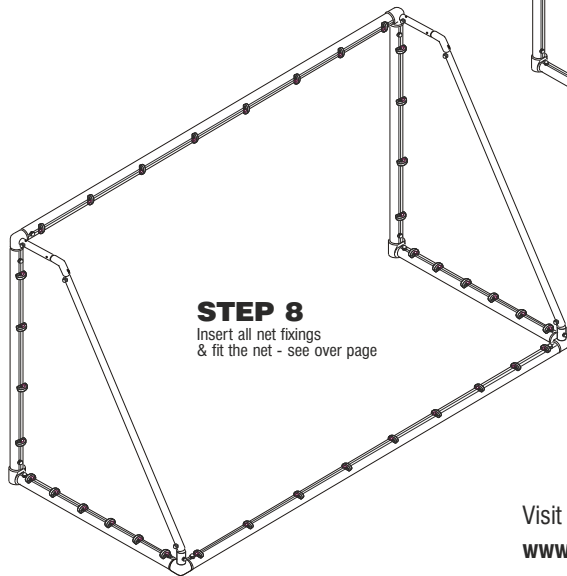

Visit our YouTube site for assembly videos :
www.youtube.com/user/Footballgoalposts

STEP BY STEP NET FITTING

STEP 1

Open net and check the lengths of a and b correspond with the diagram below.

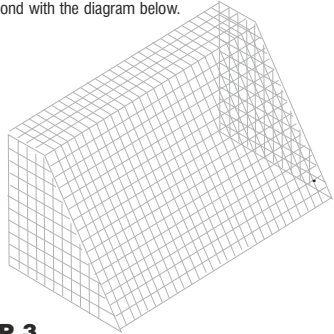

STEP 2

With the net the correct way round lift the net onto the goalpost frame. This is easier with two people.

NOTE: If your net does not fit the first time, you may be fitting it to the goal frame upside down i.e. that is to say the net from the crossbar to the floor (a) is longer than the length of the net to the bottom of the upright (b).

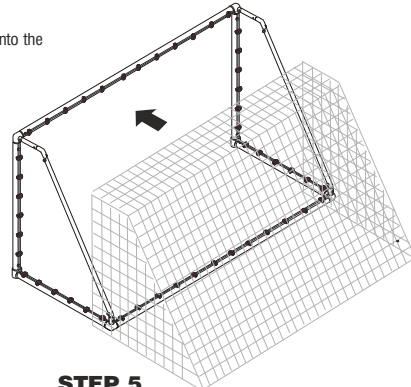
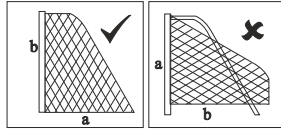

STEP 3

Attach the corners first, where the upright posts meet the crossbar as shown. Then attach the net to the post using the net fixings

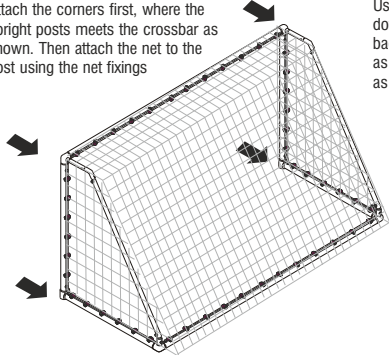

STEP 4

Using the small net ties attach the net down the back of the sloping back net supports (optional) as shown to the posts as shown.

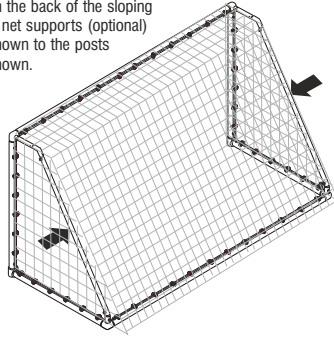

STEP 5

To help define the roof of the net Tie the cord to one side and pull the net chord tight and wrap neatly down and around the stanchion section. If you are regularly attaching or detaching the net then apply coloured tape to the roof corners of net to help identify the roof area.

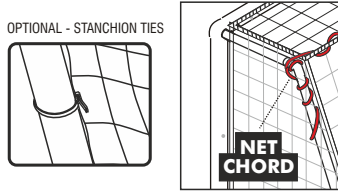

ANCHORING YOUR GOAL

WARNING: Check the position of any underground services before using the ground anchors and pegs. We take no responsibility for any damage or injury caused in this manner. HARD SURFACES: to prevent damage to goal or its components, loosen soil with a steel pole and moisten with some water before inserting the ground anchors. Do not use the goal in sub zero temperatures. ANCHORING YOUR GOAL ON GRASS - POSITION YOUR GOAL ON A LEVEL PLAYING SURFACE. PLACE THE MULTI-SURFACE ANCHOR OVER EACH SIDE OF THE GROUND FRAME (POSITIONS SHOWN) HAMMER THE PEGS THROUGH THE HOLES (DO NOT USE METAL HAMMERS USE RUBBER MALLETS) ON THE ANCHOR DOWN UNDER THE FRAME INTO THE GRASS ADDITIONAL ANCHORS OR LARGER PEGS CAN BE PURCHASED FOR USE ON SOFT GROUND OR SAND. THESE ANCHORS CAN BE USED FOR HARD SURFACES SUCH AS TARMAC WITH OPTIONAL BOLTS. ON HOT/SUNNY DAYS TARMACADAM SOFTENS AND THEREFORE TO ANCHOR YOUR GOAL PROPERLY YOU MUST:- 1 DIG HOLES IN YOUR TARMAC FILL HOLES WITH CONCRETE, 2 DRILL TWO 14MM HOLES 12CM APART AND 70MM DEPTH. 3 POSITION GOAL AND ANCHOR, INSERT AND TIGHTEN BOLT. FOR OTHER SURFACES SUCH AS WOODEN SPORTS HALL FLOORS WOOD SCREWS (INSTEAD OF BOLTS) OR COUNTER BALANCE WEIGHTS CAN ALSO BE USED (SUPPLIED SEPARATELY).

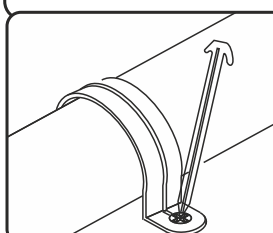
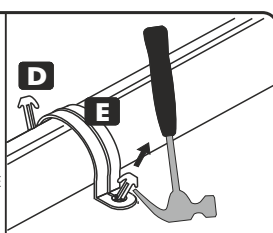
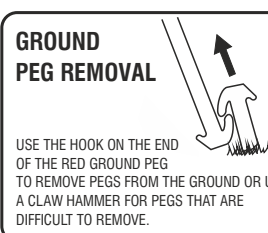
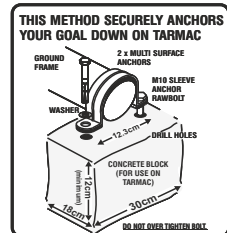
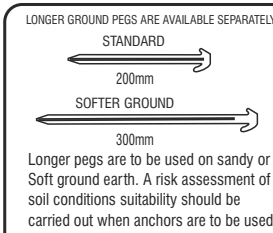
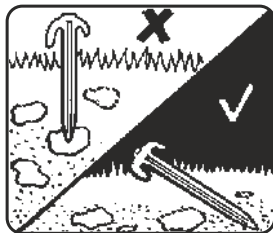
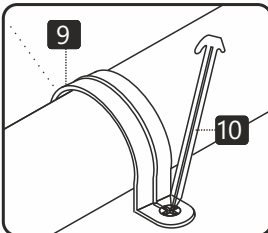
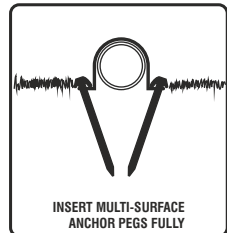

Goalpost Slot Net Fixing

A net fixing that works on most aluminum goalposts that have a slot on the rear of the posts. This net fixing can be left in place in the slot on the goal extrusion or can be twisted out and left attached in position on the net.

To attached the net turn the net fixing upside down and lay it into the slot with the opening facing up. Do this with goal post extrusion laid on the ground. The two lugs on the top of the fixing will hold the fixing clip firmly in the goalpost slot upside down to enable the net to be pushed through the opening on the back of the fixing. This is a unique design feature that makes it easier to insert the net inside the fixing compared to other similar types of net fittings. Much easier to fit than other similar net fixings.

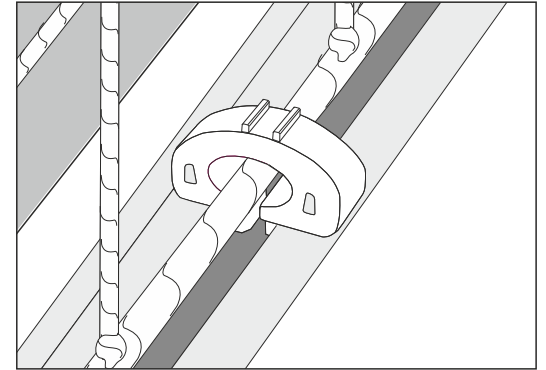

Fitting Instructions

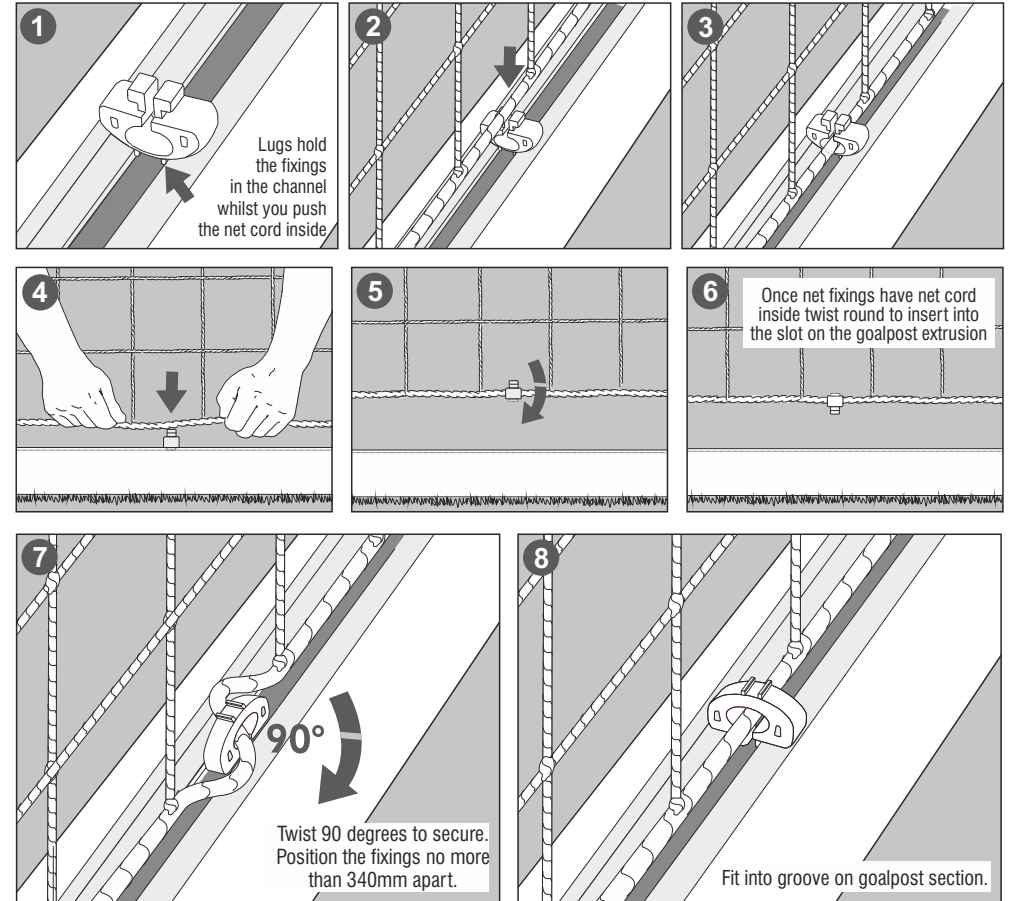

MADE IN ENGLAND www.itsagoal.co.uk

SPARE PARTS TEL: 0114 24 24 244

WORLDWIDE © COPYRIGHT 2016 ITSA GOAL POSTS LTD, ALL RIGHTS RESERVED A REGISTERED DESIGN