





COMPONENTS

A	M10 SOCKET DOME SCREW AND HEX DOME NUT - 80mm LONG	x2	
B	GROUND ANCHOR 900mm HIGH - 70mm Diameter	x2	
AK	ALLEN KEY FOR COMPONENT A	x1	
ALUMINIUM POST SECTIONS - 80mm			
C	UPRIGHT POSTS	x2	
E1	CROSSBAR	x1	

80mm ALUMINIUM PORTABLE

LIGHTWEIGHT PORTABLE RUGBY POST GOAL

YOUTH RUGBY POST 5.6M HIGH X 4.6M WIDE - PORTABLE SPIKED VERSION.

IT IS ADVISABLE IN ANY CONTACT SPORT TO TAKE OUT THE RELEVANT INSURANCES TO COVER AGAINST INJURY BOTH FROM TAKING PART, EQUIPMENT AND OTHER UNFORESEEABLE CIRCUMSTANCES.

WARNING: CHECK THE POSITION OF ANY UNDERGROUND SERVICES BEFORE USING THE GROUND ANCHOR. WE TAKE NO RESPONSIBILITY FOR ANY DAMAGE OR INJURY CAUSED IN THIS MANNER. OUR GROUND ANCHOR SYSTEM IS DESIGNED TO GIVE SLIGHTLY UNDER HEAVY IMPACT TO HELP PREVENT SERIOUS INJURY. TO LOOSEN TAP SIDES OF THE ANCHOR WITH HAMMER BEFORE EXTRACTING.

GROUND ANCHORS - NOTE: ALWAYS ENSURE ALIGNMENT OF GROUND SPIKES IS CORRECT TO ALLOW UPRIGHTS TO EASILY SLIDE OVER TOP OF SPIKE. **DO NOT** USE FRONT GROUND SPIKES IF THEY BECOME MISSHAPEN OR DAMAGED AS THIS COULD CAUSE DAMAGE TO THE BASE OF UPRIGHT, AND WOULD NOT BE COVERED UNDER GUARANTEE.

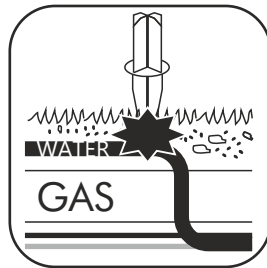

NEVER INSTALL THE POSTS IN HIGH WINDS.



IF GALES ARE FORECAST WE RECOMMEND THAT YOUR GOAL IS DISMANTLED AND STORED SAFELY



PLEASE WEAR A HARD HAT AND SAFETY BOOTS WHEN INSTALLING & DISMANTLING THE GOAL



ENSURE NO CHILDREN ARE PRESENT WHEN INSTALLING POSTS AT ANY TIME.

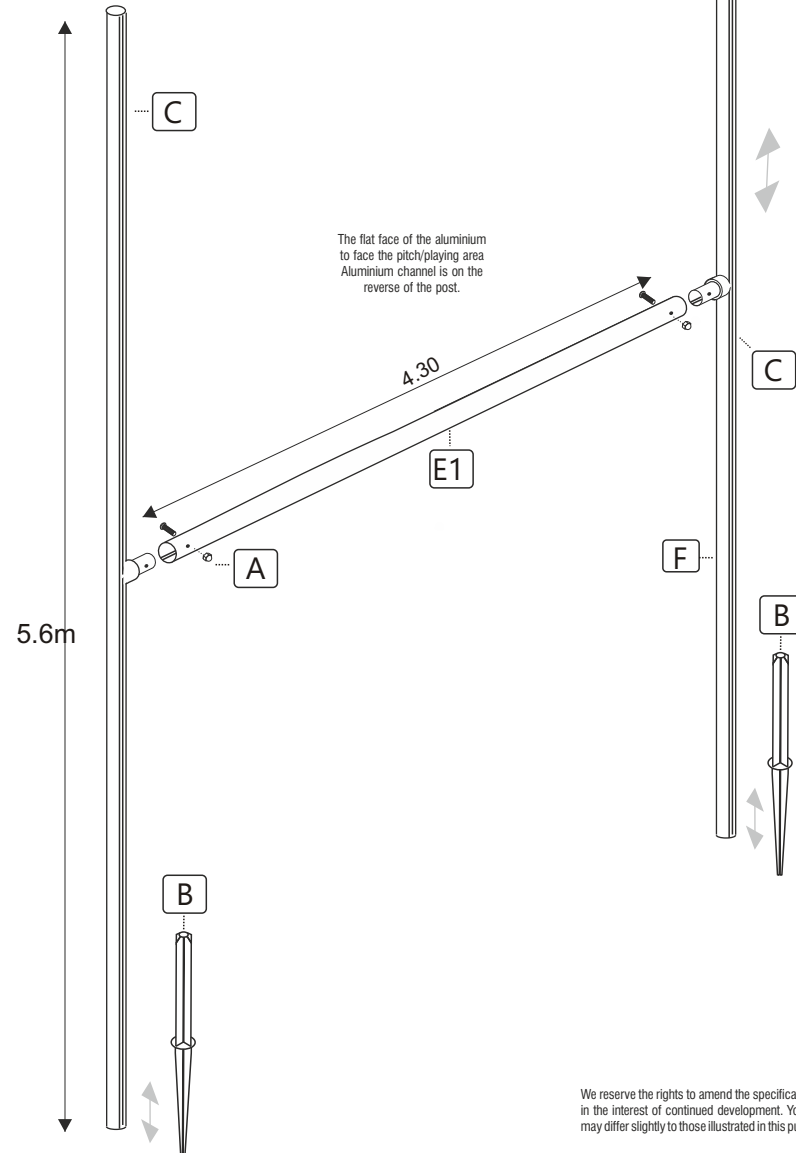

FITTING INSTRUCTION

tsaGoal

www.itsagoal.co.uk
TEL: 0114 24 24 244

WARNING

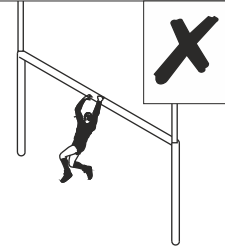

DO NOT SWING ON CROSSBARS.

CROSSBARS WILL NOT BE REPLACED WITHIN THE GUARANTEE PERIOD IF BROKEN BY SWINGING OR CLIMBING OR ANY OTHER MISUSE.

WARNING

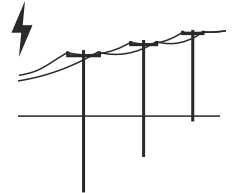

DO NOT TOUCH OVERHEAD SERVICES

DO NOT TOUCH OVERHEAD SERVICES WITH GOALPOST SECTIONS. CHECK THE POSITION OF ANY OVERHEAD SERVICES WHEN SETTING UP OR DISMANTLING THE GOALS, EG. POWER LINES, TELEPHONE CABLES ETC.

WARNING

MAKE SURE NO CHILDREN ARE PRESENT AT ANY TIME DURING GOAL INSTALLATION, REMOVAL OR ASSEMBLY.

POSTS MUST ALWAYS BE DISMANTLED IF NOT IN USE.

We reserve the rights to amend the specifications of our products in the interest of continued development. Your product therefore may differ slightly to those illustrated in this publication.

! NEVER INSTALL THE POSTS IN HIGH WINDS. ENSURE NO CHILDREN ARE PRESENT WHEN INSTALLING POSTS AT ANY TIME.

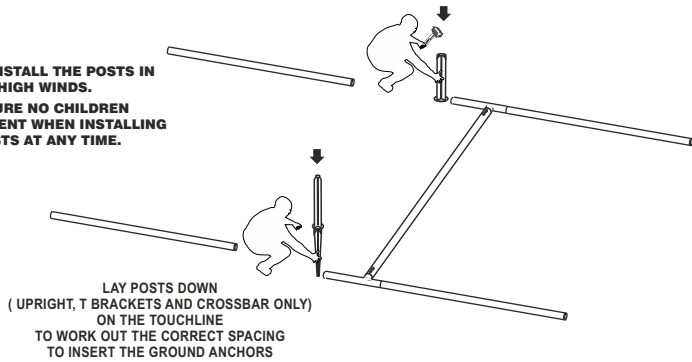

ALWAYS USE A PROTECTIVE PIECE OF WOOD (NOT INCLUDED) BEFORE HAMMERING THE TOP OF THE METAL SPIKE.

This will protect the metal anchor spike and prevent the top becoming misshapen. If the metal spike becomes misshapen and is not covered under the guarantee. If the ground is hard, water the ground to soften and use a starter metal pole not included.

! **IMPORTANT**

When installing your portable rugby posts always be aware of safety. See overleaf for details on recommended installation. **Remember** always insert the ground anchors the correct distance apart - lay the crossbar on the ground to mark the space apart. **Always** insert the ground anchors perpendicular - use a spirit level. If the ground is very hard water the ground to soften before hammering the anchors in. Once the posts are assembled you must risk assess the stability of the posts. If you find the posts are unstable ie because your ground is loose sandy soil we recommend purchasing the optional ground sockets that can be concreted in position. NEVER INSTALL POSTS IF YOU DO NOT HAVE SUFFICIENT PEOPLE TO DO SO SAFELY; WE OFFER AN INSTALLATION SERVICE AT ADDITIONAL COSTS IF REQUIRED.

The portable spiked rugby post is designed to be used in different locations. Ideal for tournaments and when posts are dismantled and stored or used in multiple locations. If you find you would like to have the posts permanently in position on one position it is advisable to concrete in optional extra ground sockets. Separate instructions can be supplied with details about installing concrete sockets.

OPTIONAL EXTRA - TRAINING AID RUGBY POST CONVERSION TRAINING NET

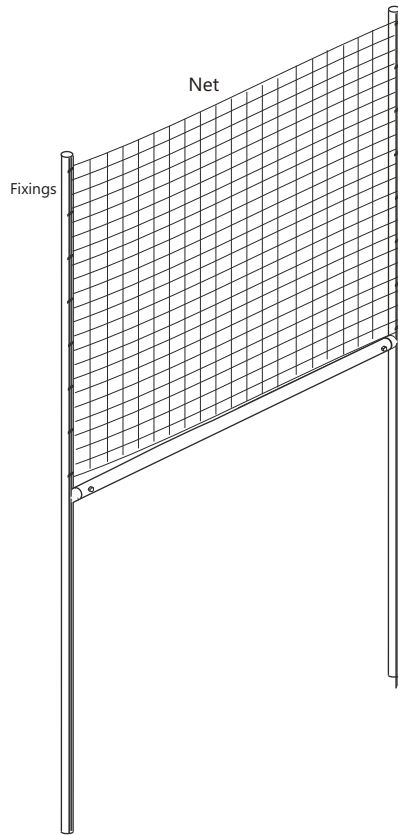

The quick fitting removable net will give you more time practicing Rugby conversions

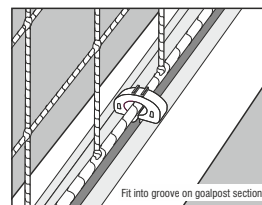
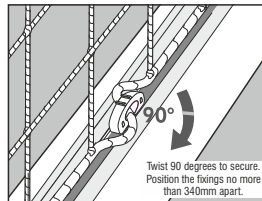

DAMAGED COMPONENTS requested under guarantee must be returned for inspection. Failure to follow the warnings, assembly and fitting instructions contained in this document, may invalidate your guarantee.

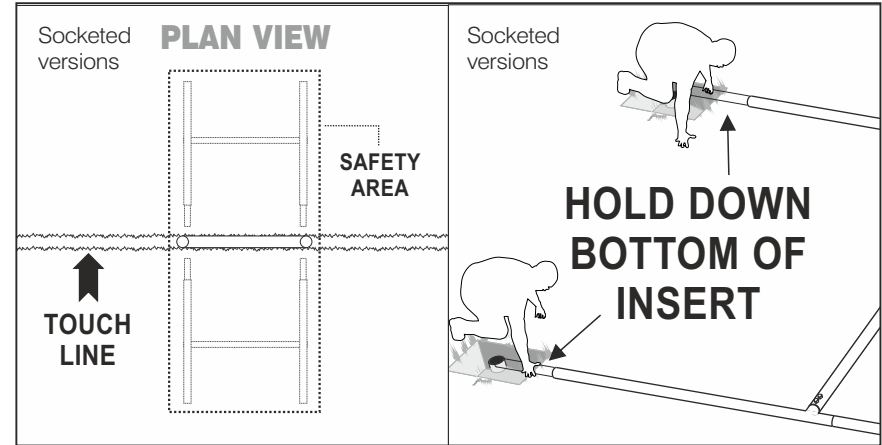

Make sure no children are present before you install the goal, and mark out a child free safety area which is **28 ft** long and **18ft** wide in front and behind the goal in case it topples during installation

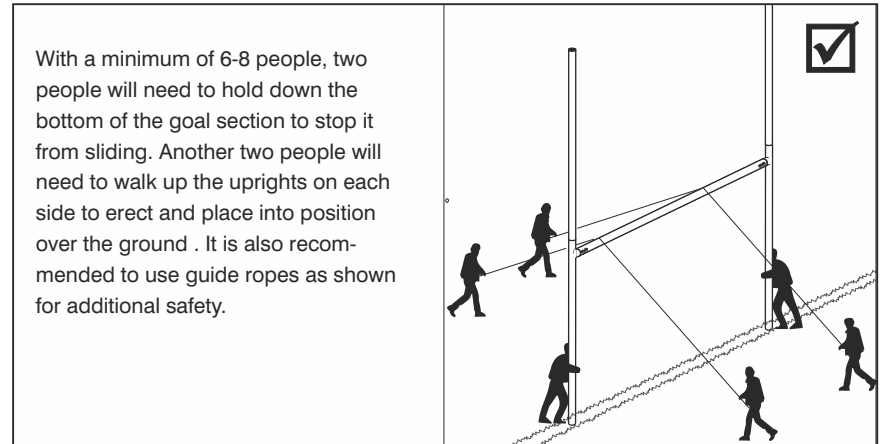

With a minimum of 6-8 people, two people will need to hold down the bottom of the goal section to stop it from sliding. Another two people will need to walk up the uprights on each side to erect and place into position over the ground. It is also recommended to use guide ropes as shown for additional safety.

