





# COMPONENTS

- A** CHROME BARREL LOCK & KEY **x2** 
- B** GROUND SOCKET **x2** 
- B1** SOCKET BOLT 45mm THREAD LENGTH **x2** 
- FXB** SLOT NET FIXING **x40** 

# POST SECTIONS

- F** CROSSBAR SECTION (Elliptical) **x1**
- H** UPRIGHT SECTION (Elliptical) **x2**

# STADIUM SOCKETED 24' X 8' STADIUM ELLIPTICAL SOCKETED GOAL

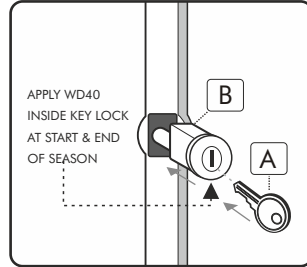

**LOCK & SECURE PATENTED SYSTEM**

# GOALPOST SLOT NET FIXINGS FOR THE CROSSBAR & UPRIGHTS

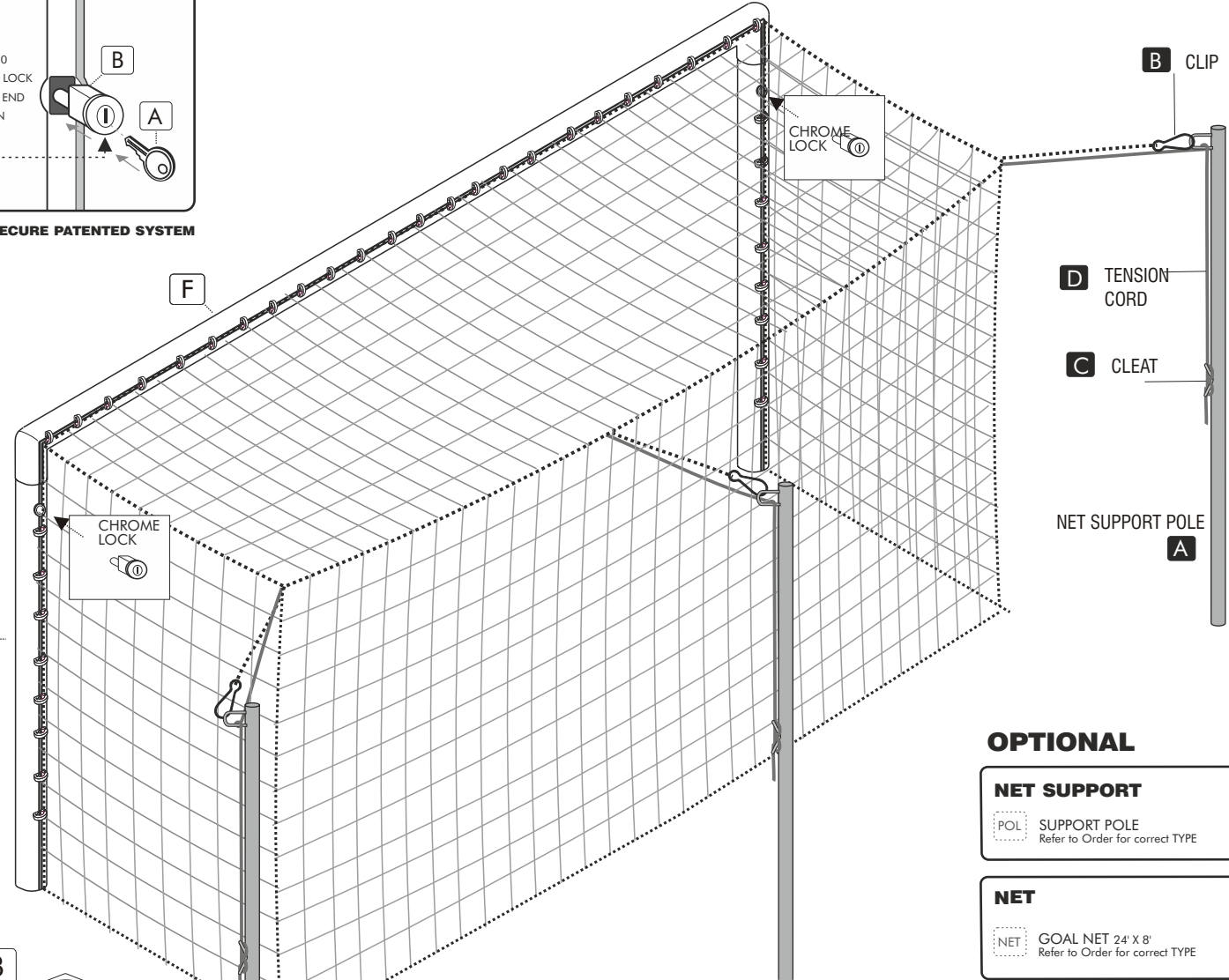
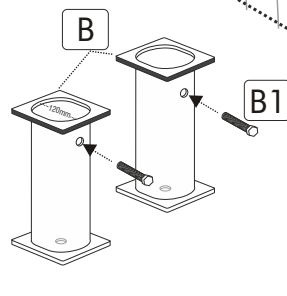
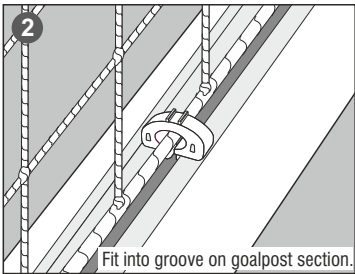
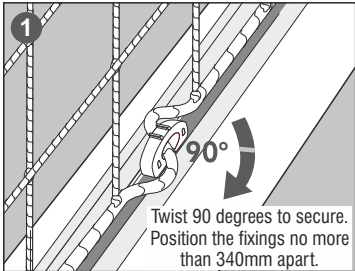

**WARNING**  
MAKE SURE NO CHILDREN ARE PRESENT AT ANY TIME DURING GOAL INSTALLATION, REMOVAL OR ASSEMBLY.  
GOALS MUST ALWAYS BE DISMANTLED IF NOT IN USE.

# OPTIONAL



## NET SUPPORT

- POL** SUPPORT POLE Refer to Order for correct TYPE

## NET

- NET** GOAL NET 24' X 8' Refer to Order for correct TYPE **x1**

## SOCKET CAP

- CAP** OVAL LOCKING SOCKET CAP **x2** 
- KEY** HEAVY DUTY OVAL LOCKING SOCKET CAP **x2** 
- KEY** OVAL SOCKET CAP KEY **x1** 

# OPTIONAL

## ACCESSORIES

SUPPLIED IF PURCHASED WITH GOAL.

- GP** GROUND PEG **x40** 
- NET** NET RETAINER - ALLOY **x1**
- NET** NET RETAINER - STEEL **x1**

# GROUND SOCKET *Installation diagram*

- 1 Upright
- 2 Sport Surface
- 3 Concrete Block
- 4 Ground Socket
- 5 Drainage Hole
- 6. Socket Bolt
- 7. Pea Gravel

Note 'Socket bolt' must be inserted to prevent ingress of soil into ground socket. Put a dab of grease on it and insert the screw into the hole and just leave it in place. At any time in the future it can be locked'.

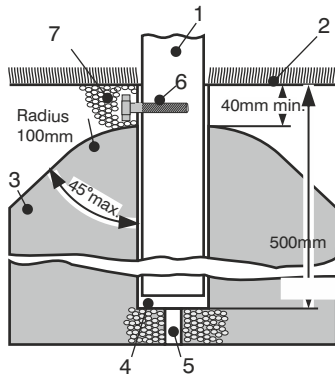

## IMPORTANT- GROUND SOCKET

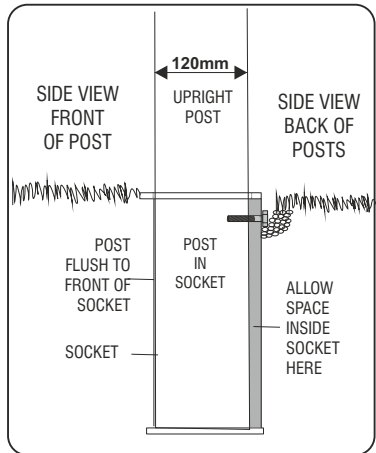

Grey area on diagram denotes the space that should be present once goal is inserted in socket. When fitting any ground socket, tape the top over to prevent concrete dropping inside the socket DURING INSTALLATION OF THE GROUND SOCKET. Locate Upright locking screw to the back of the post when fitting.

GOAL POST  
in ground socket  
side view

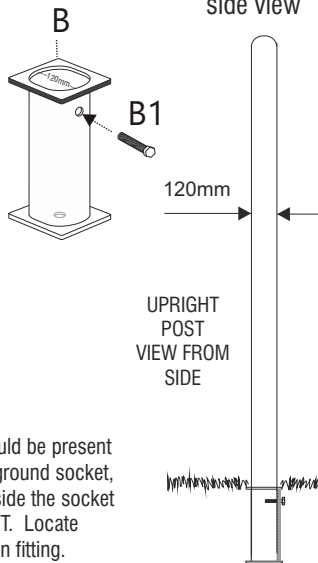

**GOALPOST PROTECTOR TAPE**  
AVAILABLE SEPARATELY

Protects paintwork at the base of the upright.

TO PURCHASE VISIT  
[www.soccertackle.com](http://www.soccertackle.com)

**LOCKABLE GROUND SOCKET CAPS**  
ARE AVAILABLE SEPARATELY

To cover and protect Ground Socket.

TO PURCHASE VISIT  
[www.soccertackle.com](http://www.soccertackle.com)



MADE IN ENGLAND [www.itsagoal.net](http://www.itsagoal.net)

For spare parts or additional products call the goal-line 0114 2434200 or visit our online supplier [www.soccertackle.com](http://www.soccertackle.com)

## Goalpost Slot Net Fixing *Fitting Instructions*

A net fixing that works on most aluminum goalposts that have a slot on the rear of the posts. This net fixing can be left in place in the slot on the goal extrusion or can be twisted out and left attached in position on the net. To attached the net turn the net fixing upside down and lay it into the slot with the opening facing up. Do this with goal post extrusion laid on the ground. The two lugs on the top of the fixing will hold the fixing clip firmly in the goalpost slot upside down to enable the net to be pushed through the opening on the back of the fixing. This is a unique design feature that makes it easier to insert the net inside the fixing compared to other similar types of net fittings. Much easier to fit than other similar net fixings.

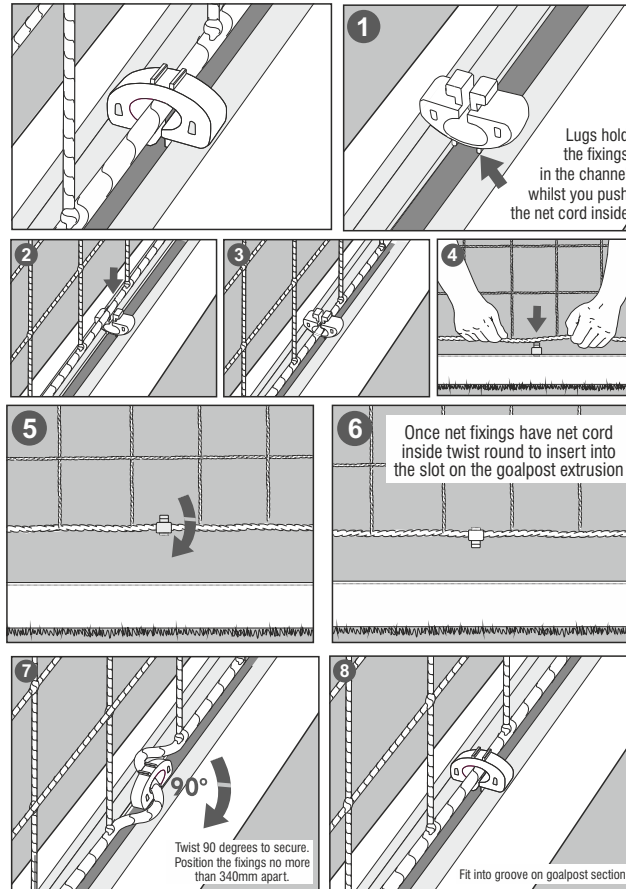

**OPTIONAL NET RETAINER** - designed to quickly lift nets for grass cutting.

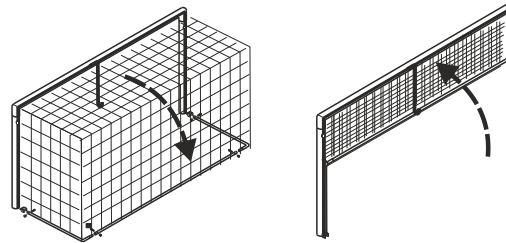

## Net Fixing

- STEP 1** Attach the net to the net fixings on the crossbar and uprights. Fit the corners of the net to the top of each upright first then clip the net onto all other net fixings.
- STEP 2** Insert the red safety pegs (optional) to peg your net to the ground, fit corners first. Always insert pegs at an angle. When removing pegs use the back of a peg to take out. Do remove pegs by pulling nets.
- STEP 4** The net will have a net head cord. This is to lift the roof of the goal up behind the crossbar. Wrap the cord on the top of the net support on one side and tie off then go to the other side and pull tight and then wrap around the top support and tie off.

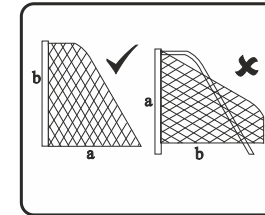

STANDARD NET

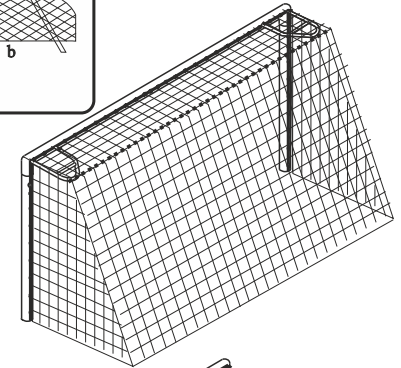

OPTIONAL BOX NETS WITH POLES

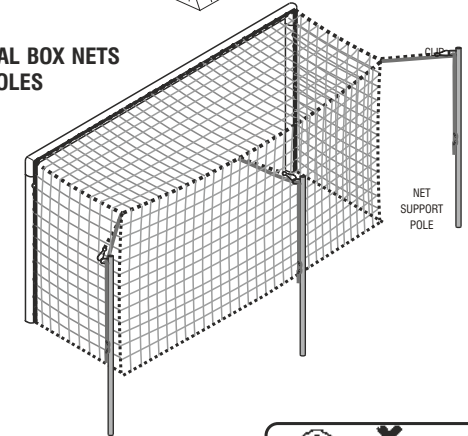

**GROUND PEGS**

LONGER GROUND PEGS ARE AVAILABLE SEPARATELY.

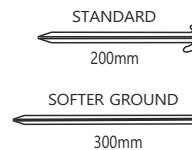

Longer pegs are to be used on sandy or Soft ground earth. **A risk assessment of soil conditions suitability should be carried out when anchors are to be used.**

