

COMPONENTS

A	CORNER BRACKET	x4	
X	CORNER BRACKET UPRIGHT 4 HOLES	x2	
B	SPIGOT	x4	
C	BLANKING CAP	x2	
D	MULTI-SURFACE ANCHOR	x2	
E	GROUND PEG	x4	
TTE	STANCHION ELBOW	x2	
G	LOWER BACK STANCHION CONNECTOR	x2	
H	LARGE QUICK RELEASE BUTTON	x12	
I	SMALL QUICK RELEASE BUTTON	x12	
STC	STANTION CONNECTOR	x2	
J	NET TIE	x38	
L	STRAIGHT CONNECTOR	x1	
K	ARROW HEAD NET FIXING with attached LOCKING PIN	x23	
NET	GOAL NET	x1	

POST SECTIONS

NI	CROSSBAR SECTION with insert	x2	
N	CROSSBAR SECTION	x1	
M	BACKBAR SECTIONS	x2	
O	SIDEBAR SECTION	x2	
PI	UPRIGHT SECTION with insert	x2	
P	UPRIGHT SECTION	x2	
Q	TOP STANCHION TUBE	x2	
R	BACK STANCHION TUBE	x4	

CARE & MAINTENANCE - see separate sheet supplied or visit itsagoal.co.uk and itsagoal.net for additional copies. Our goalpost if used correctly will last many years. We do also offer a full spare part service and if your goals need refurbishment this can be arranged

3M x 2M(10'6" X 6'6") UPVC FUTSAL GOAL

Multi-Surface - Three section crossbar - Arrow fixings included

Guarantee

REGISTER YOUR GUARANTEE

To register for your guarantee visit www.itsagoal.net scroll to the bottom of the page and click on the link 'Guarantee' and follow the instructions. Thank you.

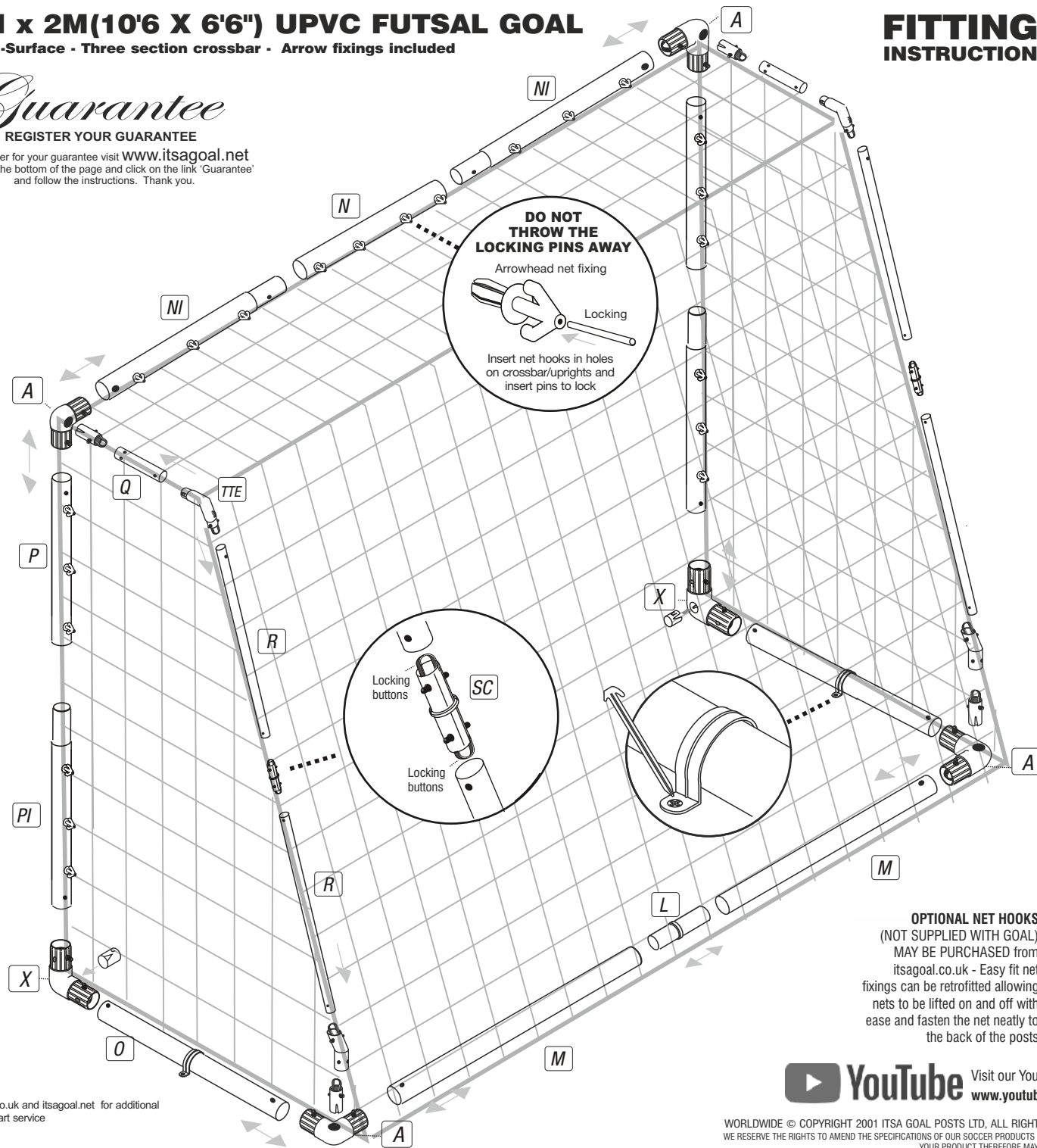

FITTING INSTRUCTION

tsaGoal

www.itsagoal.co.uk

TEL: 0114 242 4244

SPARE PARTS

ARROW NET FIXING

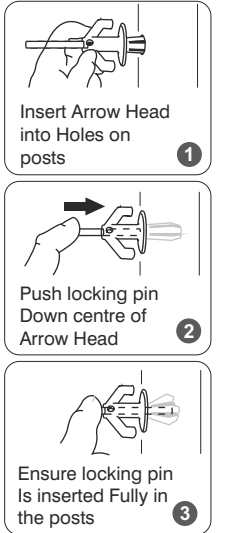

OPTIONAL NET HOOKS
(NOT SUPPLIED WITH GOAL)
MAY BE PURCHASED from
itsagoal.co.uk - Easy fit net
fixings can be retrofitted allowing
nets to be lifted on and off with
ease and fasten the net neatly to
the back of the posts

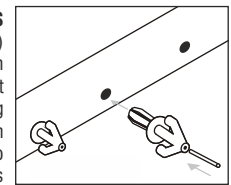

YouTube Visit our YouTube site for assembly videos :
www.youtube.com/user/Footballgoalposts

WORLDWIDE © COPYRIGHT 2001 ITSA GOAL POSTS LTD, ALL RIGHTS RESERVED A REGISTERED DESIGN
WE RESERVE THE RIGHTS TO AMEND THE SPECIFICATIONS OF OUR SOCCER PRODUCTS IN THE INTEREST OF CONTINUED DEVELOPMENT.
YOUR PRODUCT THEREFORE MAY DIFFER LIGHTLY TO THOSE ILLUSTRATED. E&OE

STEP BY STEP ASSEMBLY

FOR EASIER ASSEMBLY Use a rubber mallet and also spray furniture polish inside posts. Do not use a metal hammer. Do not apply grease or vaseline.

SPARE PARTS : www.itsagoal.co.uk

STEP 1

Lay out all Posts & components

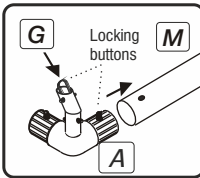
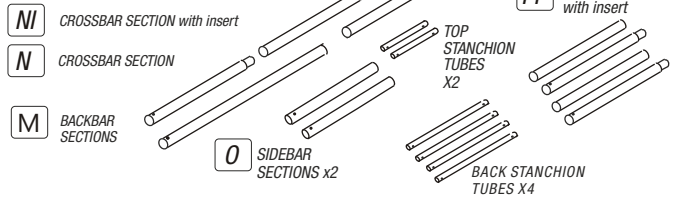

STEP 7
Join backbars M x2 with straight connector SC x1. Insert Corner Brackets A into each end of the backbar.

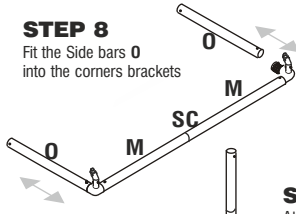

STEP 8
Fit the Side bars O into the corners brackets

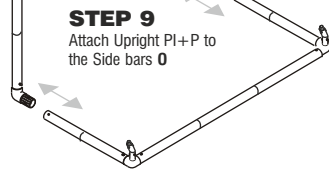

STEP 9
Attach Upright PI+P to the Side bars O

STEP 2

Insert Blanking Cap part C and insert Large Quick Release Button H (x2) into Corner Bracket X. (NOTE: Corner Bracket X is different from Corner Bracket A. Corner Bracket X is to be fitted into the upright posts and has 8 holes.)

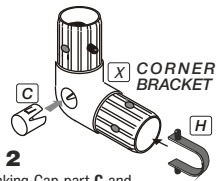

STEP 3

Insert Small Quick Release Black Button I into the Spigot B. Insert Spigot B and insert H (x2) into Corner Bracket A. (NOTE: Corner Bracket A has 4 holes.)

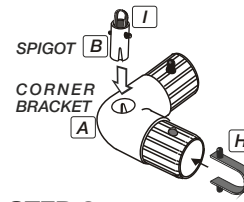

STEP 4

Insert Arrow Net Fixings into crossbar and upright posts. Insert pin to lock.

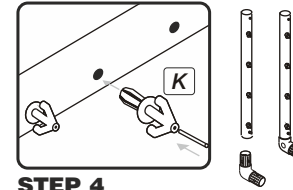

STEP 5

Insert Corner Brackets X into the upright posts P+PI (uprights slot together)

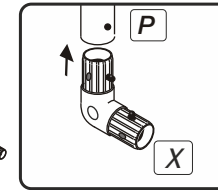

STEP 6

Fit the crossbar NI, N & NI. Insert Corner Brackets A into each end of the crossbar

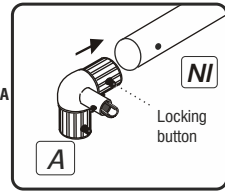

STEP 10

Attach Crossbar NI+N+NI to uprights P

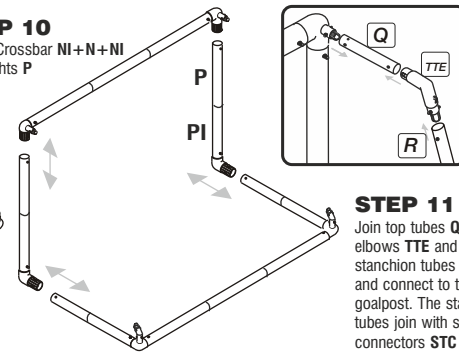

STEP 11

Join top tubes Q to elbows TTE and back stanchion tubes R and connect to the goalpost. The stanchion tubes join with stanchion connectors STC

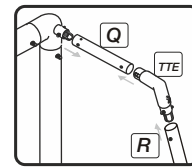

STEP 12

Attach Ground Anchors

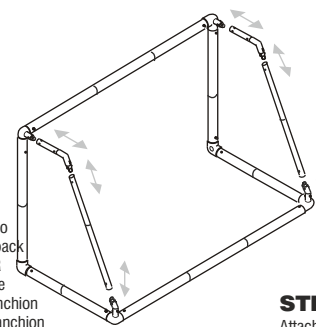

STEP 13

Attach The Net to the goal Start with each corner.

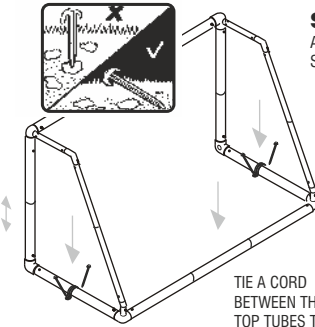
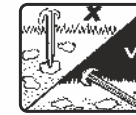

TIE A CORD BETWEEN THE TOP TUBES TO SUPPORT THE ROOF OF THE NET.

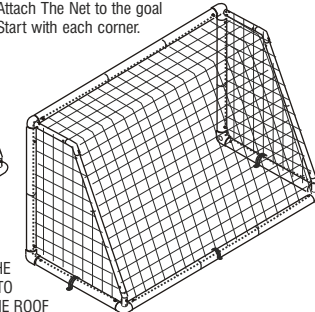

ANCHORING YOUR GOAL

WARNING: Check the position of any underground services before using the ground anchors and pegs. We take no responsibility for any damage or injury caused in this manner. **HARD SURFACES:** to prevent damage to goal or its components, loosen soil with a steel pole and moisten with some water before inserting the ground anchors. Do not use the goal in sub zero temperatures. **ANCHORING YOUR GOAL ON GRASS - POSITION YOUR GOAL ON A LEVEL PLAYING SURFACE. PLACE THE MULTI-SURFACE ANCHOR OVER EACH SIDE OF THE GROUND FRAME (POSITIONS SHOWN) HAMMER THE PEGS THROUGH THE HOLES (DO NOT USE METAL HAMMERS USE RUBBER MALLETS) ON THE ANCHOR DOWN UNDER THE FRAME INTO THE GRASS. ADDITIONAL ANCHORS OR LARGER PEGS CAN BE PURCHASED FOR USE ON SOFT GROUND OR SAND. THESE ANCHORS CAN BE USED FOR HARD SURFACES SUCH AS TARMAC WITH OPTIONAL BOLTS. ON HOT/SUNNY DAYS TARMACADAM SOFTENS AND THEREFORE TO ANCHOR YOUR GOAL PROPERLY YOU MUST- 1 DIG HOLES IN YOUR TARMAC FILL HOLES WITH CONCRETE 2 DRILL TWO 14MM HOLES 12CM APART AND 70MM DEPTH. 3 POSITION GOAL AND ANCHOR, INSERT AND TIGHTEN BOLT. FOR OTHER SURFACES SUCH AS WOODEN SPORTS HALL FLOORS WOOD SCREWS (INSTEAD OF BOLTS) OR COUNTER BALANCE WEIGHTS CAN ALSO BE USED (SUPPLIED SEPARATELY).**

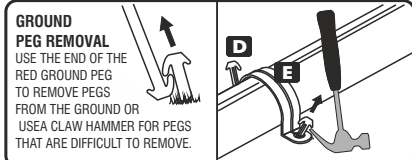
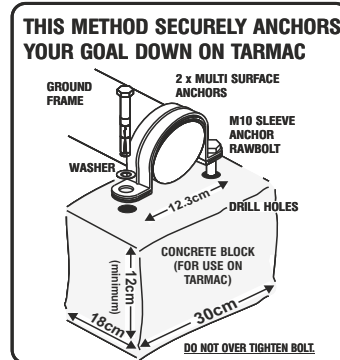
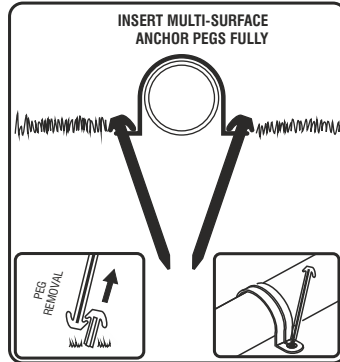

Longer pegs are to be used on sandy or soft ground earth. A risk assessment of soil conditions suitability should be carried out when anchors are to be used.

CARE & MAINTENANCE

We advise adult supervision during assembly and use. Observe and follow warning labels attached to goal.

Do not use any components, nets or parts if they are damaged or broken. Spare parts and replacement nets are readily available. If others are to install your goal you should show them how to erect and dismantle the goal and hand them a copy of the fitting instruction.

Do not drop any heavy objects on ends of tubes. Hard surfaces: to prevent damage to goal or its components, loosen soil with a steel pole and moisten with some water before inserting the ground anchors.

Do not use the goal in sub zero temperatures. warning labels should be replaced when worn and we recommend replacing them every two years - spare labels available. damaged components requested under guarantee must be returned for inspection. Failure to follow the warnings, fitting instructions contained in this document, may invalidate your guarantee.

The company, its agents and representatives do not accept any product liability if used outside the EU. Use of the product in other countries outside the EU including the USA is not covered and appropriate insurance should be taken out by the user to cover for any eventuality.

We reserve the rights to amend the specifications of our soccer products in the interest of continued development. Your product therefore may differ slightly to those illustrated. Not suitable for children under 36 months until assembled due to small parts.

NET TIES : We recommend placing the net ties no more than 340mm apart. The net ties supplied are designed to permanently fix the net to the goal frame. If you require to take nets on and off, other net fixings can be used.

NOTE: Goal must be anchored otherwise breakages may occur. At the end of the season nets can be tied into a bundle and placed into a pillow case (not to damage washing machine) and washed at 40 C with normal washing powder. The ground frame can be washed with hot soapy water. Any scuff marks on posts can be rubbed off with a light abrasive scouring pad.

If you find the nets are worn along the floor it may be rodents, by spreading pepper along the base frame rodents will be deterred. Crossbars will not be replaced within the guarantee period if broken by swinging or climbing or any other misuse.

DO NOT try to glue any damaged fixings. Plastic materials in this product vary and this may cause the plastic to break. Always replace any damaged components.

NOTE : All plastic extrusions vary and therefore some tubes may be looser or tighter to connector fittings. If you want to increase the diameter of the fitting just wrap masking tape around the part that fits into the tube, twist as you insert the fitting and it will grab to the tube tight. You can make tighter fits by adding more tape.

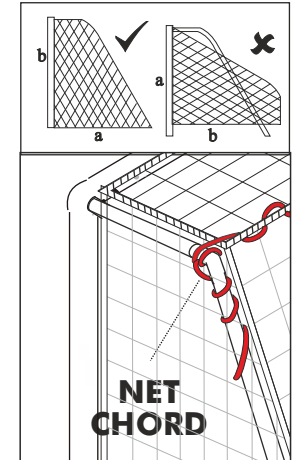

OPTIONAL NET HOOKS (NOT SUPPLIED WITH GOAL) MAY BE PURCHASED from itsagoal.co.uk - Easy fit net fixings can be retrofitted allowing nets to be lifted on and off with ease and fasten the net neatly to the back of the posts



Visit our YouTube site for assembly videos : www.youtube.com/user/Footballgoalposts