

# 12' X 4' FIVE-A-SIDE MULTI-SURFACE GOAL (12' x 4') -Three section crossbar.

**FITTING INSTRUCTION**



**SPARE PARTS** TEL: 0114 24 34 200  
**SPARE PARTS**

## COMPONENTS

<b>A</b>	CORNER BRACKET	x4	
<b>X</b>	CORNER BRACKET UPRIGHT 4 HOLES	x2	
<b>B</b>	SPIGOT	x4	
<b>C</b>	BLANKING CAP	x2	
<b>D</b>	MULTI-SURFACE ANCHOR	x4	
<b>E</b>	GROUND PEG	x8	
<b>F</b>	STANCHION ELBOW	x2	
<b>G</b>	LOWER BACK STANCHION CONNECTOR	x2	
<b>H</b>	LARGE QUICK RELEASE BUTTON	x12	
<b>I</b>	SMALL QUICK RELEASE BUTTON	x8	
<b>J</b>	NET TIE	x38	
<b>K</b>	STRAIGHT CONNECTOR	x4	
<b>L</b>	ARROW HEAD NET FIXING with attached LOCKING PIN	x20	
<b>NET</b>	GOAL NET 12' x 4'	x1	

## POST SECTIONS

<b>M</b>	CROSSBAR SECTION 1205mm LONG - 68mm Diameter	x3	
<b>N</b>	BACKBAR SECTION 1205mm LONG - 68mm Diameter	x3	
<b>O</b>	SIDEBAR SECTION 1020mm LONG - 68mm Diameter	x2	
<b>P</b>	UPRIGHT SECTION 865mm LONG - 68mm Diameter	x2	
<b>Q</b>	TOP STANCHION TUBE 239mm LONG - 40mm Diameter	x2	
<b>R</b>	BACK STANCHION TUBE 1265mm LONG - 40mm Diameter	x2	

IF GOALS HAVE INTENSIVE USE ADD THE ADDITIONAL NET TIES TO THE GROUND BASE FRAME

**CARE & MAINTENANCE** - see separate sheet supplied or visit [www.itsagoal.net](http://www.itsagoal.net) for additional copies. Our goalpost if used correctly will last many years. We do also offer a full spare part service and if your goals need refurbishment this can be arranged

IF GOALS HAVE INTENSIVE USE ADD THE ADDITIONAL NET TIES TO THE GROUND BASE FRAME

**DO NOT THROW THE LOCKING PINS AWAY**

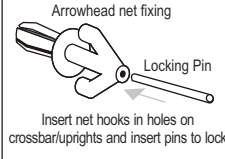

Note : Make sure part C, blanking Cap is inserted in the corner bracket X with the 8 holes. This part may already be inserted.

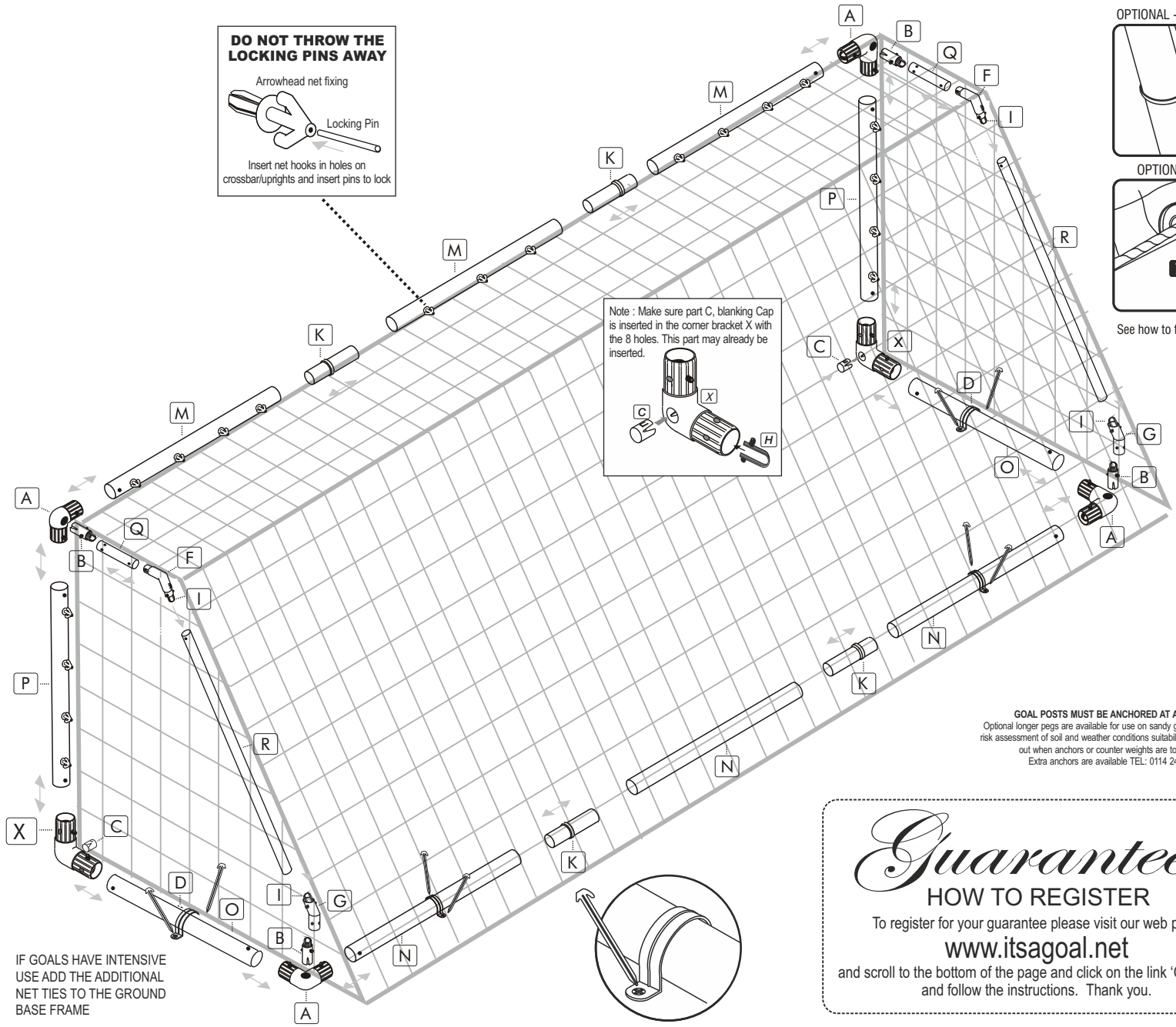

OPTIONAL - STANCHION TIES

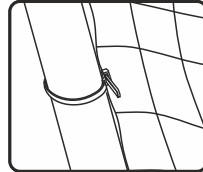

OPTIONAL - NET TIES

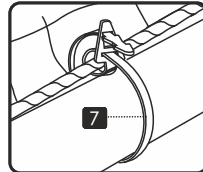

See how to fit the net overleaf

**GOAL POSTS MUST BE ANCHORED AT ALL TIMES**  
Optional longer pegs are available for use on sandy ground. On grass, a risk assessment of soil and weather conditions suitability should be carried out when anchors or counter weights are to be used.  
Extra anchors are available TEL: 0114 2434200

*Guarantee*  
**HOW TO REGISTER**

To register for your guarantee please visit our web page  
[www.itsagoal.net](http://www.itsagoal.net)  
and scroll to the bottom of the page and click on the link 'Guarantee' and follow the instructions. Thank you.

## DO NOT THROW THE PINS AWAY

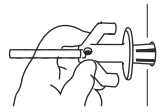

**1**  
Insert Arrow Head into Holes on posts

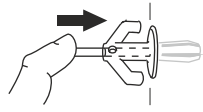

**2**  
Push locking pin Down centre of Arrow Head

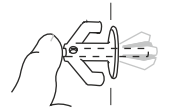

**3**  
Ensure locking pin is inserted Fully in the posts

At the end of the season nets can be tied into a bundle and placed into a pillow case (not to damage washing machine) and washed at 40 C0 with normal washing powder. The ground frame can be washed with hot soapy water. Any scuff marks on posts can be rubbed off with a light abrasive scouring pad.

**WARNING:** Check the position of any underground services before using the ground anchors and pegs. We take no responsibility for any damage or injury caused in this manner.

**NEVER** use the goals without the ground anchor system. In severe weather or windy conditions it is advisable to take your goal down as damage is not covered by the guarantee in such circumstances. If you find the nets are worn along the floor it may be rodents, by spreading pepper along the base frame rodents will be deterred.

It is advisable in any contact sport to take out the relevant insurance's to cover against injury both from taking part, equipment and other unforeseeable circumstances.

Crossbars will not be replaced within the guarantee period if broken by swinging or climbing or any other misuse.

**DO NOT** try to glue any damaged fixings. Plastic materials in this product vary and this may cause the plastic to break. Always replace any damaged components.

**SQUARE MESH** Net is cut to shape. Simply throw over the frame and fit each end onto top stanchion by securing on each corner of crossbar.

**NOTE:** If your net does not fit the first time, you may be fitting it to the goal frame upside down i.e. that is to say the net from the crossbar to the floor (a) is longer than the length of the net to the bottom of the upright. (b)

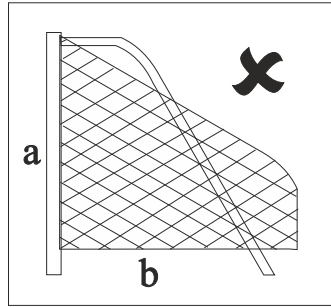
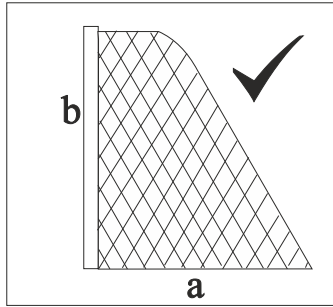

## CORNER BRACKETS

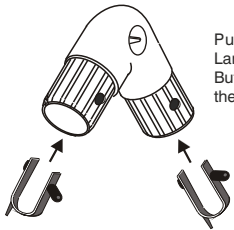

Push and Lock the Large Quick Release Buttons into the ends of the Corner Brackets.

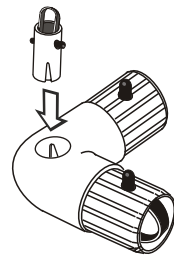

Push and Lock the spigots to two of the four Corner Brackets.

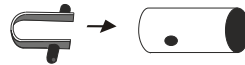

Push and Lock the Small Quick Release Buttons into the ends of the Spigots.

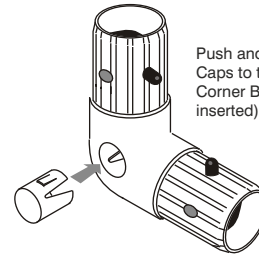

Push and Lock the Blanking Caps to the two remaining Corner Brackets. (already inserted)

## NET TIES

Ensure the teeth of the Net tie are facing you (see step 1). Loop the Net Tie around the Net Cord and slide the end into the horizontal slot and pull tight onto Net Cord (see step 1-2).

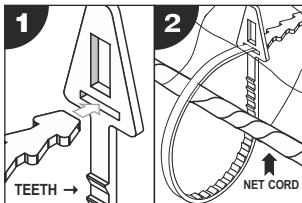

The vertical slot of the Net Tie is used to secure the net to the post. Loop the Net Tie around the post and insert through vertical slot and twist to lock. (steps 3 - 5).

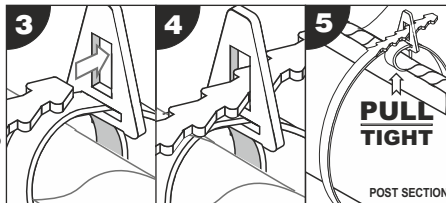

Any excess Net Tie can looped back into the vertical slot. This will also secure the net tie in a fixed position (steps 6 - 8). If Net Ties are to be removed after use then do not loop back into vertical slot.

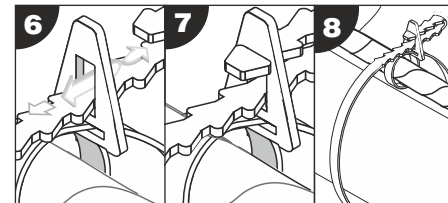

We advise adult supervision during assembly and use. Observe and follow warning labels attached to goal. Do not use any components, nets or parts if they are damaged or broken. Spare parts and replacement nets are readily available. If others are to install your goal you should show them how to erect and dismantle the goal and hand them a copy of the fitting instruction. If you lose your instructions copies can be attained from our company website. To avoid damage when dismantling the goal follow these guidelines: it is advisable in extreme windy conditions to dismantle the goal and store away. Do not drop any heavy objects on ends of tubes. When dismantling the goal ensure that all fittings are packed away and that non are left on the playing surface. Warning goals must never be left up or used unless they are properly fitted with ground anchors with net attached and securely pegged down.

**Hard surfaces:** to prevent damage to goal or it's components, loosen soil with a steel pole and moisten with some water before inserting the ground anchors. Do not use the goal in sub zero temperatures. warning labels should be replaced when worn and we recommend replacing them every two years -spare labels available. damaged components requested under guarantee must be returned for inspection. Failure to follow the warnings, fitting instructions contained in this document, may invalidate your guarantee. The company, its agents and representatives do not accept any product liability if used outside the EU. Use of the product in other countries outside the EU including the USA is not covered and appropriate insurance should be taken out by the user to cover for any eventuality. We reserve the rights to amend the specifications of our soccer products in the interest of continued development. Your product therefore may differ slightly to those illustrated. Not suitable for children under 36 months until assembled due to small parts.

**NOTE :** All plastic extrusions vary and therefore some tubes may be looser or tighter to connector fittings. If you want to increase the diameter of the fitting just wrap masking tape around the part that fits into the tube, twist as you insert the fitting and it will grab to the tube tight ...you can make tighter fits by adding more tape.

*Guarantee*

**REGISTER YOUR GUARANTEE**

To register for your guarantee visit [www.itsagoal.net](http://www.itsagoal.net) scroll to the bottom of the page and click on the link 'Guarantee' and follow the instructions. Thank you.

**ItsaGoal**  
[www.itsagoal.net](http://www.itsagoal.net)

**SPARE PARTS**  
TEL: 0114 24 34 200