

## COMPONENTS

A	CORNER BRACKET 4 HOLES	x4	
X	CORNER BRACKET UPRIGHT 8 HOLES	x2	
B	SPIGOT	x4	
C	BLANKING CAP	x2	
D	MULTI-SURFACE ANCHOR	x3	
E	GROUND PEG	x6	
F	STANCHION ELBOW	x2	
G	LOWER BACK STANCHION CONNECTOR	x2	
H	LARGE QUICK RELEASE BUTTON	x12	
I	SMALL QUICK RELEASE BUTTON	x12	
J	NET TIE	x28	
K	STRAIGHT CONNECTOR	x1	
SC	STANCHION CONNECTOR	x2	
NET	GOAL NET	x1	

## POST SECTIONS

KI	CROSSBAR SECTION - with insert 865 mm LONG - 68mm Diameter	x1	
K	CROSSBAR SECTION 865 mm LONG - 68mm Diameter	x1	
L	BACKBAR SECTION 865 mm LONG - 68mm Diameter	x2	
M	SIDEBAR SECTION 865mm LONG - 68mm Diameter	x2	
NI	UPRIGHT SECTION with insert - 68mm Diameter	x2	
N	UPRIGHT SECTION - 68mm Diameter	x2	
O	TOP STANCHION TUBE 239mm LONG - 40mm Diameter	x2	
P	BACK STANCHION TUBE 639mm LONG - 40mm Diameter	x4	

# 6' X 4' FOOTIEGOAL Sectional - with Base

SPARE PARTS AND NETS ARE AVAILABLE

TEL 0114 242 4244 www.itsagoal.co.uk

*Guarantee*  
REGISTER YOUR GUARANTEE

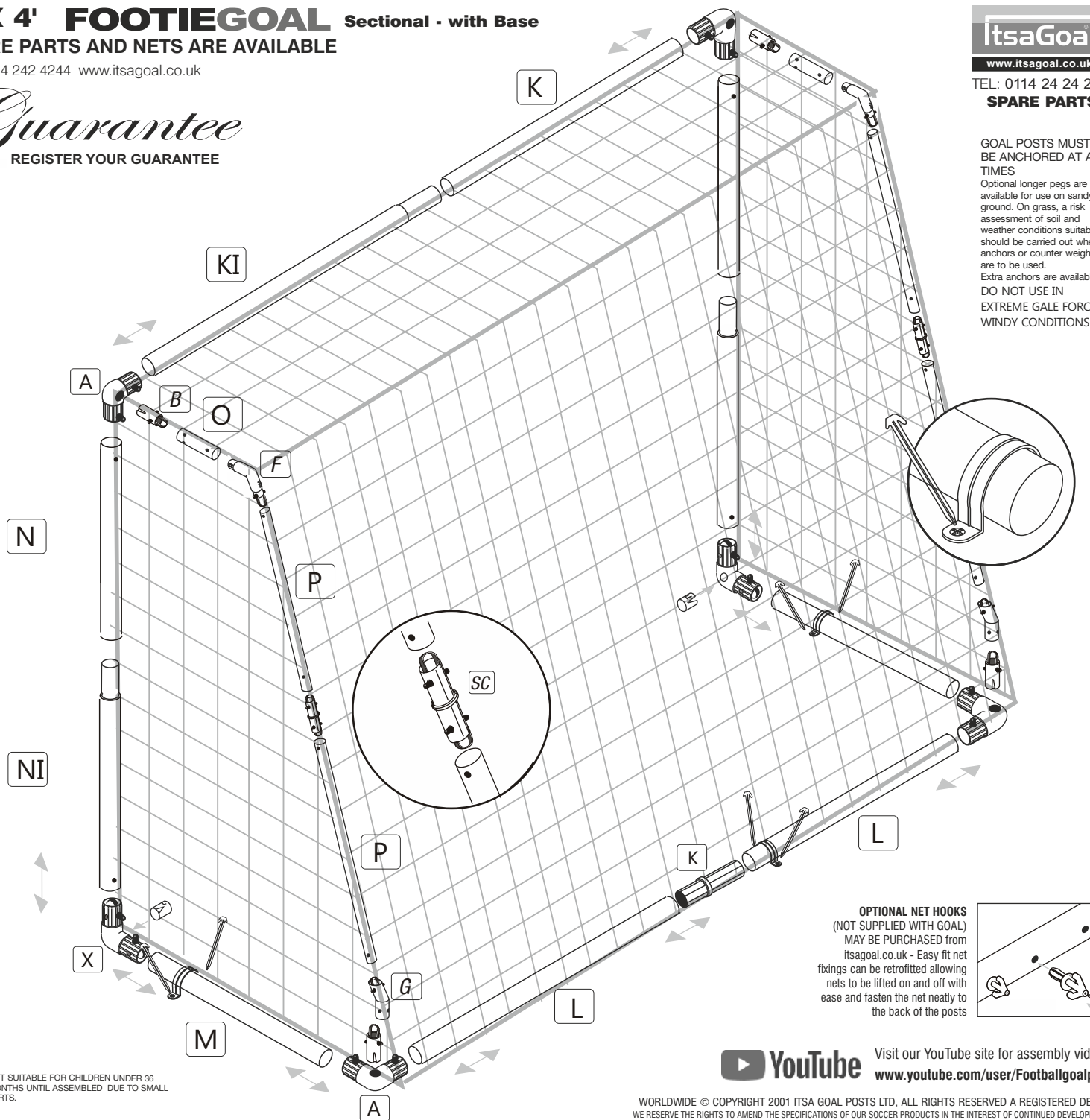

**itsaGoal**  
www.itsagoal.co.uk  
TEL: 0114 24 24 244  
**SPARE PARTS**

GOAL POSTS MUST BE ANCHORED AT ALL TIMES  
Optional longer pegs are available for use on sandy ground. On grass, a risk assessment of soil and weather conditions suitability should be carried out when anchors or counter weights are to be used.  
Extra anchors are available. DO NOT USE IN EXTREME GALE FORCE WINDY CONDITIONS

**OPTIONAL NET HOOKS**  
(NOT SUPPLIED WITH GOAL) MAY BE PURCHASED from itsagoal.co.uk - Easy fit net fixings can be retrofitted allowing nets to be lifted on and off with ease and fasten the net neatly to the back of the posts

CE NOT SUITABLE FOR CHILDREN UNDER 36 MONTHS UNTIL ASSEMBLED DUE TO SMALL PARTS.

Visit our YouTube site for assembly videos : [www.youtube.com/user/Footballgoalposts](http://www.youtube.com/user/Footballgoalposts)

WORLDWIDE © COPYRIGHT 2001 ITSA GOAL POSTS LTD. ALL RIGHTS RESERVED A REGISTERED DESIGN  
WE RESERVE THE RIGHTS TO AMEND THE SPECIFICATIONS OF OUR SOCCER PRODUCTS IN THE INTEREST OF CONTINUED DEVELOPMENT.  
YOUR PRODUCT THEREFORE MAY DIFFER LIGHTLY TO THOSE ILLUSTRATED. E&OE

**STEP 1**

Lay out all Posts & components

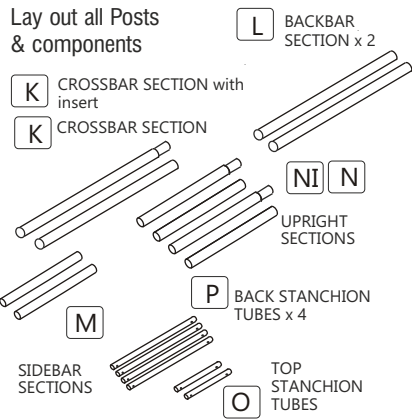

**STEP 2**

Insert Blanking Cap part C into two corners

Note : Make sure part C, blanking Cap is inserted in two corner brackets. This part may already be inserted.

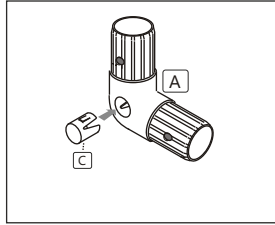

**STEP 3**

Insert Spigots B into four corner brackets and insert the small quick release button I into the Spigots

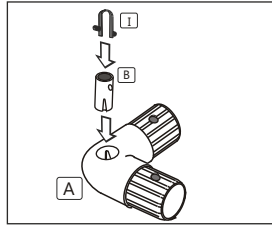

**STEP 4**

Insert the Lower Back Stanchion Connector LB into two of the corner bracket that already have the spigot in place.

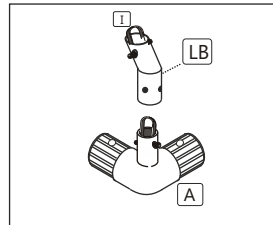

**Care and maintenance of your goals**

We advise adult supervision during assembly and use. Observe and follow warning labels attached to goal. Do not use any components, nets or parts if they are damaged or broken. Spare parts and replacement nets are readily available. If others are to install your goal you should show them how to erect and dismantle the goal and hand them a copy of the fitting instruction. Do not drop any heavy objects on ends of tubes. Hard surfaces: to prevent damage to goal or its components, loosen soil with a steel pole and moisten with some water before inserting the ground anchors. Do not use the goal in sub zero temperatures. warning labels should be replaced when worn and we recommend replacing them every two years - spare labels available. damaged components requested under guarantee must be returned for inspection. Failure to follow the warnings, fitting instructions contained in this document, may invalidate your guarantee. The company, its agents and representatives do not accept any product liability if used outside the EU. Use of the product in other countries outside the EU including the USA is not covered and appropriate insurance should be taken out by the user to cover for any eventuality. We reserve the rights to amend the specifications of our soccer products in the interest of continued development. Your product therefore may differ slightly to those illustrated. Not suitable for children under 36 months until assembled due to small parts.

**NET TIES :** We recommend placing the net ties no more than 340mm apart. The net ties supplied are designed to permanently fix the net to the goal frame. If you require to take nets on and off, other net fixings can be used. **NOTE:** Goal must be anchored otherwise breakages may occur. You must anchor your goals with the multi surface ground anchors provided. At the end of the season nets can be tied into a bundle and placed into a pillow case (not to damage washing machine) and washed at 40 C0 with normal washing powder. The ground frame can be washed with hot soapy water. Any scuff marks on posts can be rubbed off with a light abrasive scouring pad. **WARNING:** Check the position of any underground services before using the ground anchors and pegs. We take no responsibility for any damage or injury caused in this manner. If you find the nets are worn along the floor it may be rodents, by spreading pepper along the base frame rodents will be deterred. Crossbars will not be replaced within the guarantee period if broken by swinging or climbing or any other misuse. **DO NOT** try to glue any damaged fixings. Plastic materials in this product vary and this may cause the plastic to break. Always replace any damaged components. **NOTE :** All plastic extrusions vary and therefore some tubes may be looser or tighter to connector fittings. If you want to increase the diameter of the fitting just wrap masking tape around the part that fits into the tube, twist as you insert the fitting and it will grab to the tube tight. You can make tighter fits by adding more tape.

**STEP 5**

Firstly form the ground frame - Connect Backbar L+K+L with the Corner Brackets with the Lower Back Stanchion Connectors (parts from step 3) Insert the sidebar sections M into the Corner Brackets.

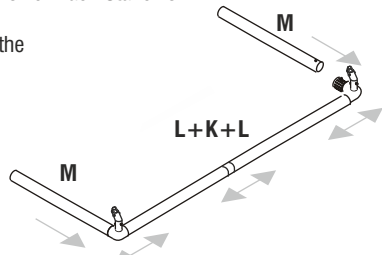

**STEP 6**

Insert Corner Brackets with Blanking Caps into upright posts N+NI



**STEP 7**

Insert uprights N+NI with the Corner Brackets with Blanking Caps into the ground side bars M

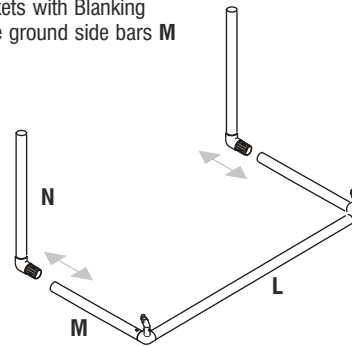

**STEP 8**

Connect the remaining corners brackets to the Crossbar K+KI and slide onto the uprights

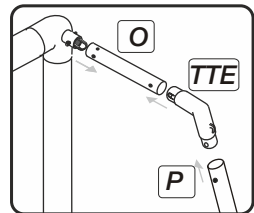
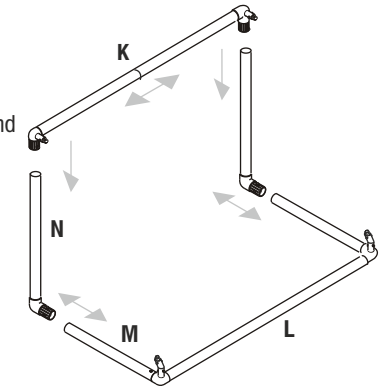

**STEP 9**

Join top tubes O with Top Tube Elbows TTE and back tubes P+SC+P and connect to the goalpost.

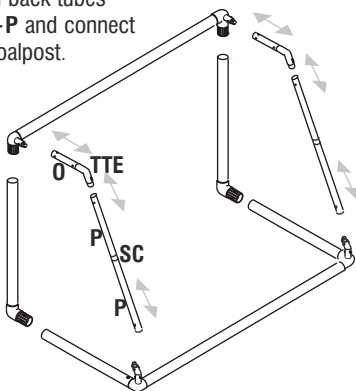

**GOAL TIP**

Press button in and out to warm up, this helps fitting, once in place this button stays connected

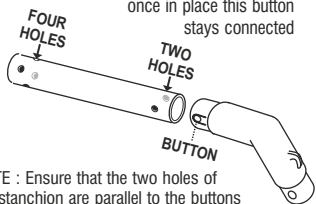

**NOTE :** Ensure that the two holes of the stanchion are parallel to the buttons of the Top Tube Elbow before connecting.

**STEP 10**

Attach Ground Anchors. Anchors must be inserted for the stability of the whole goal see details of use overleaf.

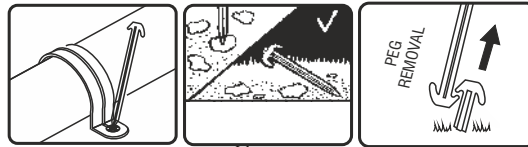

**STEP 11**

Start with each corner and attach the Net to the goal with the net ties. The net must be attached to use the goal.

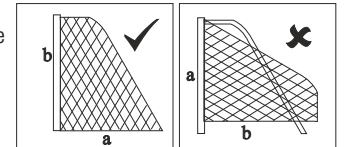

**SQUARE MESH** Net is cut to shape. Simply throw over the frame and fit each end onto top stanchion by securing on each corner of crossbar.

**NOTE:** If your net does not fit the first time, you may be fitting it to the goal frame upside down i.e. that is to say the net from the crossbar to the floor (a) is longer than the length of the net to the bottom of the upright.(b)

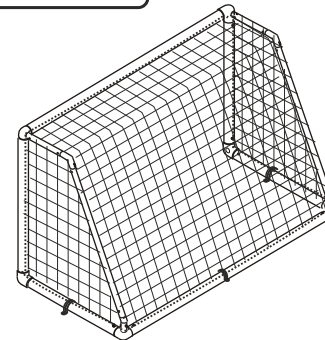

**OPTIONAL -** Net ties are ideal to fit nets tightly to the side ground frames and stanchions. This is ideally when nets are left attached to the fully assembled side frames.

**TIE A CORD BETWEEN THE TOP STANCHION TUBES TO SUPPORT THE ROOF OF THE NET (THIS CAN BE LEFT TIED MIN POSITION WHEN DISMANTLED)**

**IF YOU WOULD LIKE TO CREATE A TIGHT FIT BETWEEN CORNER BRACKETS AND POSTS IT IS POSSIBLE TO ADD A SMALL AMOUNT OF MASKING TAPE (NOT INCLUDING) THIS CREATES A SEAL. IDEAL IF GOALS ARE LEFT IN SITU see over.**