

Model 12-140AE

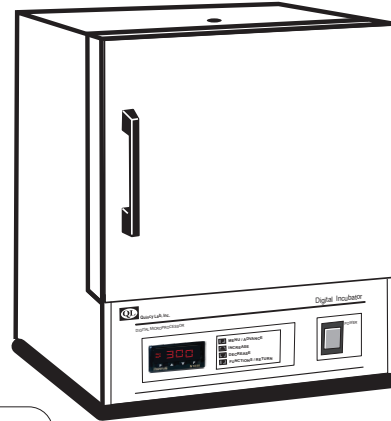

Model 10-180AE

SPECIFICATIONS	MODEL 10-140AE	MODEL 12-140AE	MODEL 10-180AE	MODEL 12-180AE
----------------	-------------------	-------------------	-------------------	-------------------

<b>Interior Dimensions</b>	INCHES W x H x D	12x10x10	16x15.5x12	12x10x10	16x15.5x12
	(CM) W x H x D	31x25x25	46x41x30	31x25x25	46x41x30
<b>Exterior Dimensions</b>	INCHES W x H x D	13x15x11	19x21x13	13x15x11	19x21x11
	(CM) W x H x D	33x38x28	48x53x33	33x38x28	48x53x33
<b>Weight (lbs)</b>		23 lbs	39 lbs	23 lbs	39 lbs
<b>Cubic Foot Capacity</b>		.7 ft <sup>3</sup>	1.72 ft <sup>3</sup>	.7 ft <sup>3</sup>	1.72 ft <sup>3</sup>

<b>Standard Electrical</b>	VOLTS / WATTS	115 / 270	115 / 270	115 / 310	115 / 420
	FREQUENCY (Hz)	50/ 60	50/ 60	50/ 60	50/ 60

<b>Temperature Range</b>				
Ambient +8°C to:	62°C	62°C	94°C	94°C

### Common Unit Specifications

<b>Operating Environment:</b>	Indoor use, altitude to 6,500 ft. (2,000m) Installation Category II, Pollution Degree 2, ambient temperature 10°C/50°F to 35°C/95°F, 80% RH maximum.
<b>Storage Temperature:</b>	-10°C/14°F to 70°C/158°F, 70% RH maximum.
<b>Approvals:</b>	Underwriter's Laboratory Listed, Laboratory Equipment, C/UL United States/Canadian. E212550 (115VAC models only)
<b>Compliance:</b>	UL Standard 61010-1, IEC 61010-1, 2nd Edition.

### Common Unit Construction

<b>Exterior:</b> Powder-Coated Steel	<b>Interior:</b> Aluminum
<b>Insulation:</b> Fiberglass	<b>Door:</b> 140AE: Acrylic, 180AE: Steel Insulated
<b>Thermo-control:</b> PID Microprocessor	<b>Heater:</b> Resistive-Tubular Incoloy

## Safety Precautions Read Operating Instructions Thoroughly Prior to Operation

Read Operating Instructions thoroughly prior to operation and observe the following safety precautions:

- Use only a grounded outlet that is rated for your model's electrical requirement.
- Do not modify the unit or factory control settings to operate the unit above the stated maximum operating temperature.
- Exterior surfaces on the 180AE models may become hot to the touch when operating at higher set temperatures.

 Do not place volatile or combustible materials inside the incubators.

 Incubators are not intended for use with any flammable liquids or vapors, or with chemicals that produce toxic gases.

## Set-Up and Installation

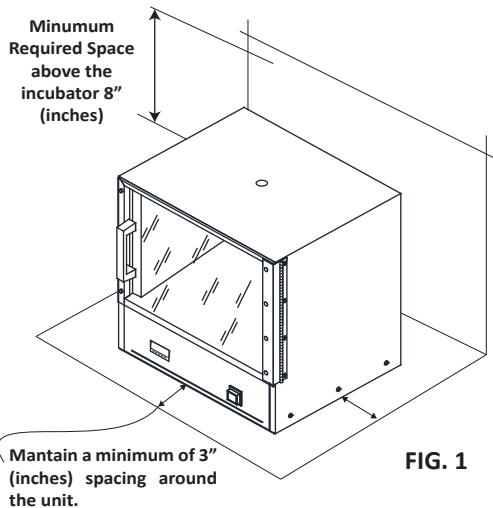

FIG. 1

### INCUBATOR SET-UP

- Place the Incubator on a flat surface. Maintain a minimum of 3" (7.6 cm) of airspace around the unit and a minimum of 8" (20.32 cm) above the unit (FIG.1).
- Install the desired shelves in the unit (see Shelf Installation).
- Plug the unit into a grounded outlet that is rated for your model's electrical requirement.

#### IMPORTANT:

Do NOT modify the provided plug. Do NOT use an extension cord. Use an individual branch circuit for your incubator. For information on your unit's electrical specifications and rated voltage, refer to label on the back of the unit.

## INCUBATOR SHELF INSTALLATION

Your incubator allows shelves to be adjusted at different heights in the unit and are easy to install and adjust using the wire shelf brackets. To install and/or adjust shelves follow the steps below:

- 1 Align bracket ends with holes located inside the ovens walls (FIG. 2)
- 2 Insert shelf bracket ends into the hole and press down on the bracket as shown in (FIG. 3). Repeat process on the opposite side of the wall.
- 3 Place shelf on top of the shelf brackets.

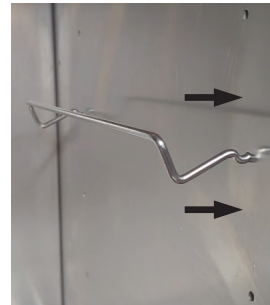

FIG. 2



FIG. 3

## General Operation

The unit is ready for your immediate use. All control parameters, calibration and tuning has been done at the factory, no adjustments are necessary.

Push the illuminated power button. All LED's on the temperature control will light up and display the current chamber temperature. The **OUT** and **RUN** indicators will also light up once the unit has been powered ON.

The incubator will immediately start to heat to the factory preset temperature set-point. To change the set-point temperature follow the quick sequence shown to the right on FIG 4.

The temperature control is set at the factory to read 1/10th degree C or Celsius units. To change the temperature unit refer to page 3 of this manual.

**See Menu Functions Guide for controller functions.**



FIG. 4



Press **P** once to see 





Press **▲** or **▼** to Increase / Decrease



Press **P** 3 times to return to chamber temperature

 Once the unit nears the desired temperature allow the incubator to cycle for 20 minutes at the set-point before the temperature becomes fully stable.

 Upon each initial powering-up, the control may typically overshoot the set temperature by 3 or 4 degrees especially if the temperature set point is close to the operating ambient temperature. After equilibrium is achieved the control will hold the set temperature within specified model's tolerance.

 **RUN and OUT lights ON** indicates normal heating process.

 **The OUT light will flash intermittently after achieving the set-point.**

# Menu Functions Guide

To navigate the controller's menu, please refer to the easy-to-use Menu Guide below: Menu setting changes can be done quickly with our 4-button digital microprocessor. Your incubator's controller allows you to perform the following:

- Set the operating set-point temperature
- Select between degrees Fahrenheit or Centigrade
- Calibrate your unit to your independent temperature sensing device.
- Auto-tune your Incubator for maximum efficiency
- Lock the set-temperature

## MENU GUIDE

**CONTROLLER KEY DESCRIPTION**

- P Menu/Advance** - Use to advance to successive parameter or menu
- ▲ Increase** - Use key to increase the parameters value.
- ▼ Decrease** - Use key to decrease the parameters value.
- F Special Function** - Use key to return and exit.

### OPERATION INDICATORS

**AT Indicator**  
ON- Indicates that auto-tuning is in process. (See Auto-Tuning the oven for more information).

**OUT**  
ON- Indicates normal activation of outputs.  
FLASHING - Indicates normal operation

**RUN**  
ON - Control is enable to run. (This light remains ON during use)

**ALM**  
ON - Indicates an alarm condition when the process value is above the defined alarm value.

### SET-POINT CHANGE

To change the temperature set-point of your oven, use the indicated arrow keys to increase or decrease temperature.

- Press **P** once to see **SP**
- Press **▲** or **▼** to Increase / Decrease
- Press **P** 3 times to return to chamber temperature

### TEMPERATURE UNITS

To change the oven's operational unit to read either degrees Celsius or degrees Fahrenheit you will need to:

- Press **P** 2 times to see **UNIT**
- Press **▲** or **▼** to select unit
- Press **P** 2 times to return to chamber temperature

## TEMPERATURE OFFSET / CALIBRATION

Your unit has been calibrated at our factory using a NIST-certified temperature instrument.

Over time a temperature adjustment (offset) may be necessary to maintain the unit's controller temperature reading consistent with the interior temperature. To maintain this temperature accuracy, we recommend verifying twice a year that there is a temperature consistency between the controller and the chamber using a known accurate temperature measuring device.

### To execute an OFFSET you will need to:

- 1 Place a trusted, preferably certified digital temperature probe at the center of the unit's chamber.
- 2 Record the temperature reading at the controller and at the center of your unit's chamber.
- 3 Access the **OFFS** parameter and input the temperature difference from your controller to your digital probe.

To change the offset value on your incubator:

Press **P** 3 times to see **PASS**

Press **▲** to input factory passcode **1111**

Press **P** ONCE to see **OFFS**

Press **▲** or **▼** to input temperature difference

Press **P** ONCE to exit calibration

Factory set passcode 1111

- ⚠ Once a temperature adjustment has been made, allow the unit some time to stabilize before making any subsequent adjustments.
- ⚠ The temperature difference between the controller and your independent probe can be a positive or negative number.

## AUTO-TUNING THE UNIT

Your unit's controller has been tuned from our factory to achieve set-point temperatures at a faster rate. However, you can auto-tune your unit's controller to work best with your application and set-points. The two auto-tuning options available are:

### FAST Tuning

This option prioritizes speed over accuracy, allowing you to reach set-point temperatures faster.

### FULL Tuning

This tuning option gives priority to accuracy over speed.

**⚠ Although there are other tuning options available, we recommend only using the two options mentioned above. Any other tuning option performed will affect the unit's performance and accuracy.**

To execute an auto-tuning you will need to:

- 1 Select the desired set-point temperature to tune the unit.



Press **P** once to see **SP**



Press **▲** or **▼** to Increase / Decrease



Press **P** 3 times to return to chamber temperature

- 2 Once the desired set-point temperature has been set, you will need to input the factory set passcode to access the tuning parameter.



Press and **HOLD P** to see **PASS**



Press **▲** to input passcode



Press **P** **ONCE** to see **Factory set passcode 1111**. Continue to 3

Factory set passcode 1111

- 3 Select either the **FAST** or **FULL** tuning option to be executed. Once a selection has been made exit tuning menu. The indicator **AT** will light up and remain ON during the tuning process.



Press **▼** to select tuning option



Press and **HOLD P** or **F** to exit tuning menu

### IMPORTANT:

**⚠** During the tuning process, it is common to see the temperature fluctuate by a few degrees above and below the setpoint.

**⚠** Allow the unit some time to reach temperature stability after the tuning process has been completed.

## CONTROLLER LOCK

Your unit's controller allows you the option to "lock" the controller buttons to prevent any changes to the parameter values. You can do this by following the sequences shown below:

1. Press **P** (3) times to see **PASS**
2. Enter the password of **1111** by holding **▲**
3. Press and hold **P** until the display **CALib**
4. Press **P** (3) times to see **Prot**
5. Change the **4** to **5** by pressing **▲**
6. Press **P** again (4) times to return to temperature



PASSWORD PROMPT



ENTER PASSWORD



CALib Prompt



Prot PROMPT



CHANGE 4 TO 5



RETURN TO TEMPERATURE

## CONTROLLER ALARM

**Controller Alarm-** If the unit exceeds the high limit alarm value, the controller will stop the heating process and display the ALM indicator on the controller until the unit is manually reset.

**To reset alarm condition-** Power the unit OFF and allow it to cool down to room temperature before powering ON. If the problem persists contact technical support.



## Chamber Loading

Understanding the unit's light pressure thermal convection and "load-effect" are necessary to optimize unit's performance. Article or media processing times and/or uniformity are largely dependent on load density and positioning.

### Important guidelines to chamber loading and processing:

- Load the incubator so that air circulation within the chamber is not impaired. (FIG. 5)
- Leave a space between articles on the shelf.
- Avoid the use of large solid trays or foil on shelves, this can limit heat circulation within the chamber.
- Avoid blocking the return air port in the back of the lower plenum/shelf.
- Avoid extremely large (in quantity or size), or high-density loads ( FIG. 6 ). This will show by non-uniform processing and long or impossible "heat-through" times. To help determine a large load's suitability, use the set-point recovery time (the time it takes for the temperature to recover to the original set temperature once load is placed and door is closed), as a guide.
- To reduce recovery time, reduce load proportionally. Also, large loads such as a beaker containing 2 liters of a solution may require an elevated set temperature for the solution to reach and maintain a lower target temperature. When possible, measure large loads or solution temperatures directly with an ancillary thermometer or probe. **Probes can be inserted at the top port.**
- Process the smallest possible load the application or workload will permit. For best processing of small multiples or a single item, adjust one shelf so that the article(s) is centered in the incubator.
- Avoid placing articles or media against or within an inch of the walls. Heated air from the lower heat-shield, is designed to travel up the sidewalls and can have a slightly elevated temperature from setpoint and the rest of the chamber.

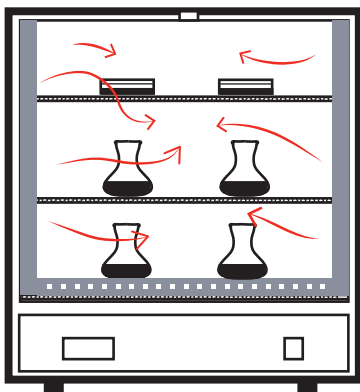

FIG. 5

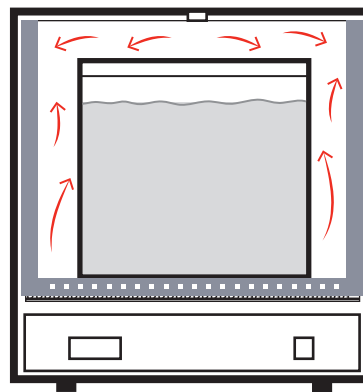

FIG. 6

### Important Operational Notes:

The incubator's chamber temperature stability can be affected by changes in ambient (room) temperature and/or equipment running in close proximity (creating microclimates) or cycling on the same electrical circuit. Take time to see how the unit's location or changes in room temperature from seasonal heating or air conditioning may influence the incubator's set temperature. **For best chamber temperature stability, keep the ambient temperature stable.**

#### IMPORTANT

- **The unit's minimum operating temperature is largely determined by ambient (room) temperature.** The unit can operate 8°C above room temperature but temperature stability will be degraded.
- The unit's stability improves appreciably for settings that exceed ambient (room) temperature by 10°C or better. Also, the lower the ambient temperature the lower the minimum adjustable operating temperature.
- Adjusting the operational temperature range of the unit for *non-typical ambient conditions* can be done by performing an auto-tune to the unit (see Auto-tuning the unit on page 4).



## Maintenance

To clean interior and exterior surfaces, use a damp cloth with or without an all-purpose cleaner. Avoid commercially available oven cleaners. The acrylic door should only be cleaned using a lint-free cloth, with or without water. Paper towels can mar the surface of the acrylic door. Use of any commercial cleansers on the acrylic door will cause crazing and cracking of the surface of the acrylic over time. **Periodically, verify the temperature accuracy “calibration” of the controller’s temperature display (with the unit empty of contents), against a know accurate or calibrated temperature device ( See Temperature offset/calibration on pg. 3 of this manual or Scan the QR-code and see the Digital Incubator Calibration section at the bottom of the page for additional information).**

- If a liquid is spilled inside the unit, disconnect it from the power supply and have it checked by a competent person.
- It is the user’s responsibility to carry out the appropriate decontamination if hazardous material is spilled on or inside the unit.
- It is the user’s responsibility not to use decontamination or cleaning agents that could cause a hazard as a result of a reaction with parts of the equipment or with the material contained in it.



## Troubleshooting

PROBLEM	POSSIBLE CAUSE	WHAT TO DO BEFORE CALLING TECH. SUPPORT
Unit not turning ON when switch is in the ON position	1. <i>Tripped GFCI power outlet</i>	1. Check if the unit tripped a GFCI outlet or fuse. Try a different power outlet connection before moving to number 2 on this list.
	2. <i>Damaged or missing fuse</i>	2. Check (red) fuse holder in the back of the unit for missing fuse or broken fuse. Replace as needed.
	3. <i>Disconnected / loose wires.</i>	3. Check all wire connections in the electrical area (bottom) and make sure there are no loose or disconnected wires in the unit.
Incubator not heating or over heating.	1. <i>Set temperature not set correctly or set too low.</i>	1. Make sure the setpoint temperature is set correctly on the lower right corner and is above the stated 2°C (140 series) or 3°C (180 series) above room temperature.
	2. <i>The unit overheated and alarmed</i>	2. Turn unit OFF and ON to clear (SUB/OUT) Alarm, if the problem persists contact Quincy Lab. for further assistance.
	3. <i>Incorrect OFFSET ( <math>\square \square \square</math> ) value</i>	3. Verify that the <b>Temperature Offset</b> (pg.3) is between -10°F to 10°F. Any value higher than this may affect the heating process. Bring value down to zero, and perform a temperature calibration. Scan QR-code above for additional information.

## Common Replacement Components

Digital P.I.D Controller <b>PART # 101-1230</b>	AE Motor Assembly <b>PART # 401-2025</b>
S.S Relay <b>PART # 401-1235</b>	

## Common Additional Equipment

10 Series Wire Shelf <b>PART # F-6033A</b>	10 Series Shelf Support <b>PART # 101-1001</b>
12 Series Wire Shelf <b>PART # F-6043A</b>	12 Series Shelf Support <b>PART # 101-3001</b>

For a complete list of replacement components, part and additional equipment, visit us on the web at [www.quincylab.com](http://www.quincylab.com)

## Technical Support

If you have any questions or need technical assistance, contact Quincy Lab technical support for further assistance, or visit us on the web at [www.quincylab.com](http://www.quincylab.com)

**Email:** [information@quincylab.com](mailto:information@quincylab.com)  
**Voice:** 800-482-4328  
**Tech Support:** 773-622-2428, Extension 2.

Quincy Lab, Inc.  
 109 Shore Dr.,  
 Burr Ridge, Illinois 60527

## Limited Warranty



Quincy Lab, Inc. warrants to the original purchaser that this product will be free from defects in material and workmanship under normal use throughout the warranty period. The standard warranty period for this instrument is twenty four (24) months from date of shipment. The instrument warranty is supplemented with a three year warranty on the heating element. Please refer to your invoice or shipping documents to determine the active warranty period. This warranty covers parts & labor (labor at factory only) and shipping cost for replacement parts.