



hi-lo

GAS CUTTING
AND WELDING EQUIPMENT

Industrial Gas Cutting & Welding Catalogue

www.hilouk.co.uk | 0114 349 4749 |
sales@hilouk.co.uk |
56 Newhall Road, Sheffield S9 2QL



About Us

Hi-Lo UK prides itself on its versatility, not only stocking standard gas welding and cutting equipment but also it's capability in being able to produce special fittings for adapting non-standard equipment.

With advanced technology and ultra-modern manufacturing techniques, we can offer the most reliable, heavy-duty and hard-wearing products. Also, the confidence that you are dealing with a market leader when it comes to safety.

The Hi-Lo brand, which has one of its manufacturing facilities based in York operates with state of the art CNC machines and is capable of producing high quality cutting nozzles and brass fittings for a wide range of applications, from the fabrication shop to heavy steel mill equipment.



Get In Touch

www.hilouk.co.uk
0114 349 4749
sales@hilouk.co.uk



HiloUKSheffield



hi.lo.uk



Hi-Lo UK



@hilo_uk

56 Newhall Road, Sheffield, S9 2QL
Mon - Thurs: 8:30 - 17:00
Fri: 8:30 - 16:30



Contents

Regulators		Outlet Valve	36
The difference between Single and Two Stage Regulators	5	Brassware	37
Single Stage Regulator	6-7	Hoses	
Two Stage Regulator	8-9	Fitted Hose	38
High Pressure Regulator	10 - 11	Unfitted Hose	39
High Flow Regulator	12	Hose Fittings	40
Line Regulator	13	Comet Style	
FabMaster Regulator	25	AGA Style Type-21	41
Tapping Points	14	Cutting Tip	41
Flowmeter Purge Regulator	14	Cutting Attachment & Handle	42
Elite Series Regulator/ Flowmeter & Heater Regulator	15	Comet Style Mixer	43
Torches		Cutting & Welding Kit	43
Flat Handle	18-19	Victor Type	
Round Handle	26	Welding Handle	45
Propane Heating Torch	29	Cutting Attachment	45
Nozzles		Nozzles	45 - 46
Cutting Nozzles	20	One Piece Cutting Torch	48
Heavy Duty Nozzles	22	Machines	
Special Nozzles	23	UA-12 Straight Line Cutter	49
Supacut Nozzles	27	Pipe Cutter	49
Contractors Kit		HL-200 Straight Line Cutting Machine	50
Elite Contractors Kit	23	Tapping Points	51
FabMaster Contractors Kit	27	Manifolds	51
FabMaster Deluxe Contractors Kit	44	Bespoke Burner	52
Flashback Arrestors	30	Distribution Panels	53
Quick Release	31	Leatherware	54
Shank & Accessories		Aquasol	55 - 58
Light Duty	32	Trolleys & Cages	59 - 60
Type 3	32	CP7	62
Mixers	32	Procedures	63
Nozzles	33	Performance Data	64 - 66
Bent Necks	33	Safety Checklist	67
Cylinder Adapter	34		
Fillet Gauge	34		
Marker Pens	34		
Spark Lighter	34		
Circle Cutting Attachments	34		
Nozzles Cleaner	35		
Spindle Key & Spindle	35		
Wire Brush	35		
Gas Economisers	35		
Model O Torch	35		



The Difference Between Single And Two Stage Regulators

Single Stage

High-pressure gas from the supply enters into the regulator through the inlet valve. The gas then enters the body of the regulator, which is controlled by the needle valve. The pressure rises, which pushes the diaphragm, closing the inlet valve to which it is attached, and preventing any more gas from entering the regulator. The outlet side is fitted with a pressure gauge. As gas is drawn from the outlet side, the pressure inside the regulator body falls. The diaphragm is pushed back by the spring and the valve opens, letting more gas in from the supply until equilibrium is reached between the outlet pressure and the spring. The outlet pressure, therefore, depends on the spring force, which can be adjusted using an adjustment handle or knob.

The outlet pressure and the inlet pressure hold the diaphragm/valve assembly in the closed position against the force of the large spring. If the supply pressure falls, it is as if the large spring compression is increased allowing more gas and higher pressure to build in the outlet chamber until an equilibrium pressure is reached. Thus, if the supply pressure falls, the outlet pressure will increase, provided the outlet pressure remains below the falling supply pressure. This is the cause of end-of-tank dump where the supply is provided by a pressurised gas tank. With a single-stage regulator, when the supply tank gets low, the lower inlet pressure causes the outlet pressure to climb. If the spring compression is not adjusted to compensate, the valves can remain open and allow the tank to rapidly dump its remaining contents. In other words, the lower the supply pressure, the lower the pressure differential the regulator can achieve for a given spring setting.

Two Stage

Two-stage regulators are two single-stage regulators in one that operates to reduce the pressure progressively in two stages. The first stage, which is preset, reduces the pressure of the supply gas to an intermediate stage; gas at that pressure passes into the second stage. The gas now emerges at a pressure (working pressure) set by the pressure adjusting control knob attached to the diaphragm. Two-stage regulators have two safety valves for added protection. A major objection to the single-stage regulator is the need for frequent torque adjustment. If the supply pressure falls, the outlet pressure increases, necessitating torque adjustment. In the two-stage regulator, there is automatic compensation for any drop in the supply pressure. Single-stage regulators may be used with pipelines and cylinders. Two-stage regulators are used with cylinders and manifolds. Two-staged regulators are recommended for applications that require a constant outlet pressure for the life of a gas cylinder.

The Chart shows the characteristic of a single stage regulator

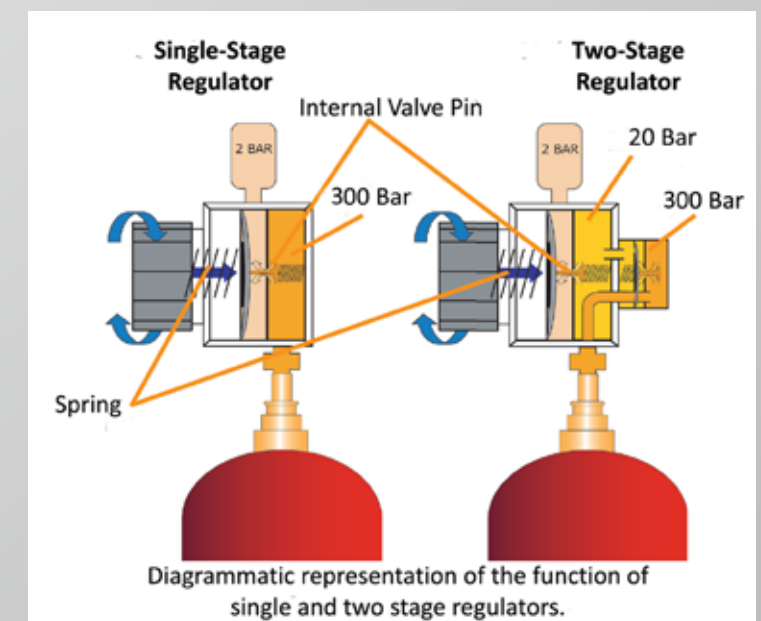
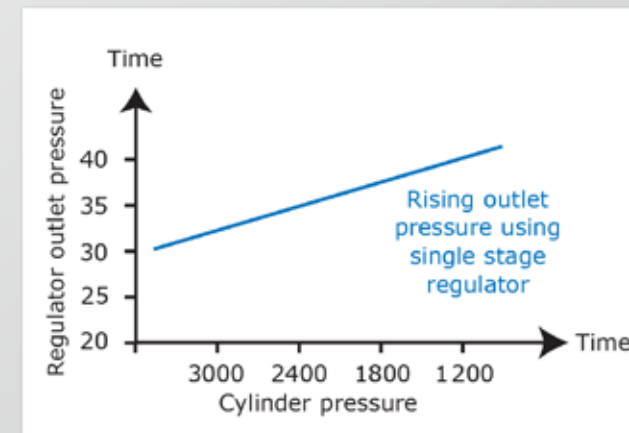

Single Stage Regulators

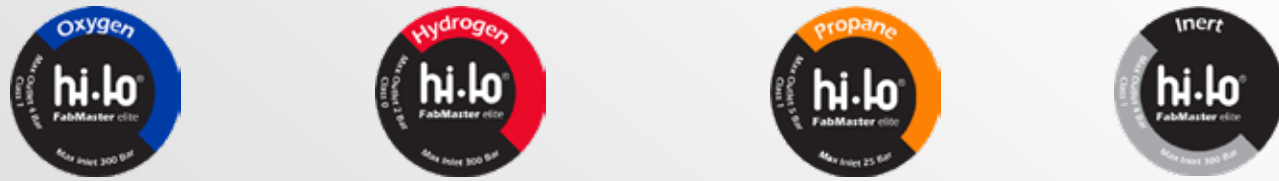

- 2 years warranty
- 300 bar service.
- Manufactured under BS EN ISO 9001.
- Conforms to BS EN ISO 2503.
- Alloy Bonnet for high strength.
- High contrast, easy to read gauges.
- Made in Britain.
- Available in bottom or side entry



FabMaster Elite Single Stage Regulator

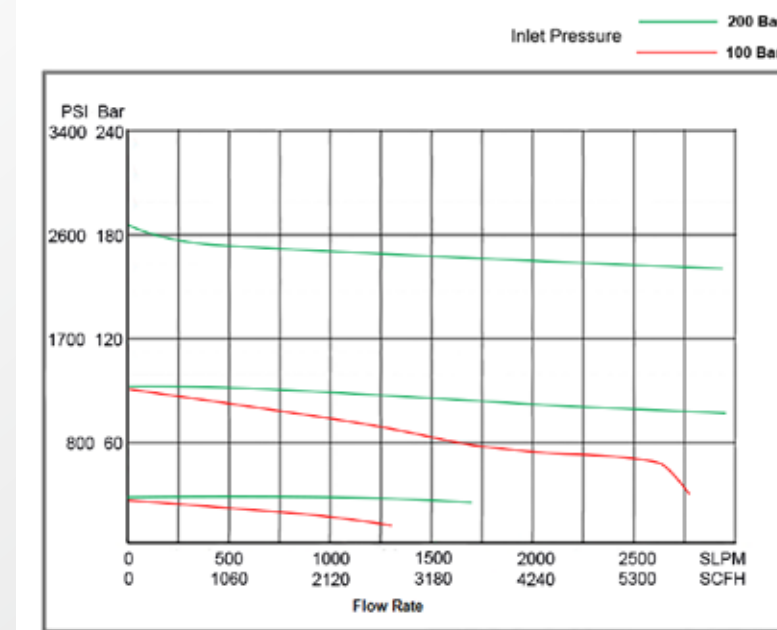

Model	Part Number	Outlet
Oxygen		
Single Stage Indicator Oxygen Regulator	HL050007	10 Bar
Single Stage Plugged Oxygen Regulator	HL050001	10 Bar
Single Stage 2 Gauge Oxygen Regulator	HL050071 HL050072	5 Bar 10 Bar
Single Stage 2 Gauge Oxygen Hand Tight Nevoc Regulator	HL050151	10 Bar
Single Stage Oxygen Spanner Tight Regulator	HL050158	10 Bar
Fuel Gas		
Single Stage 2 Gauge Acetylene Regulator	HL050073	1.5 Bar
Single Stage 2 Gauge Propane Regulator	HL050178 HL050076	2 Bar 4 bar
Single stage 2 Gauge Hydrogen Regulator	HL050123	10 Bar
Single Stage Plugged Propane Regulator	HL050004 HL050005	2 Bar 4 Bar
Single Stage Plugged Acetylene Regulator	HL050002	1.5 Bar
Inert		
Single Stage Pre-Set 1 Gauge Argon Regulator	HL050033	2 Bar
Single Stage 2 Gauge Argon Regulator	HL050075	10 Bar
Single Stage 2 Gauge Nitrogen Regulator	HL050075NIT	10 Bar
Single Stage 2 Gauge Argon Regulator	HL050074	35LPM
Single Stage 2 Gauge Helium Regulator	HL050126	10 Bar
Single Stage 2 Gauge CO2 Regulator	HL050075CO2	10 Bar
Single Stage Plugged Argon Regulator	HL050094	10 Bar
Single Stage Argon Nevoc Spanner Tight Regulator	HL050036	10 Bar
Single Stage Argon Nevoc Spanner Tight Regulator	HL050037	CFH
Single Stage Argon Nevoc Hand Tight Regulator	HL050311	CFH
Single Stage Argon Nevoc Hand Tight Regulator	HL050038	10 Bar

Two Stage Regulators



- 2 years warranty
- 300 Bar Service
- Available in bottom and side entry.
- High contrast, easy to read gauges.
- Alloy bonnet for high strength.
- Manufactured under BS EN ISO 9001.
- Conforms to BS EN ISO 2503.
- Made in Britain



FabMaster Elite Two Stage Regulator

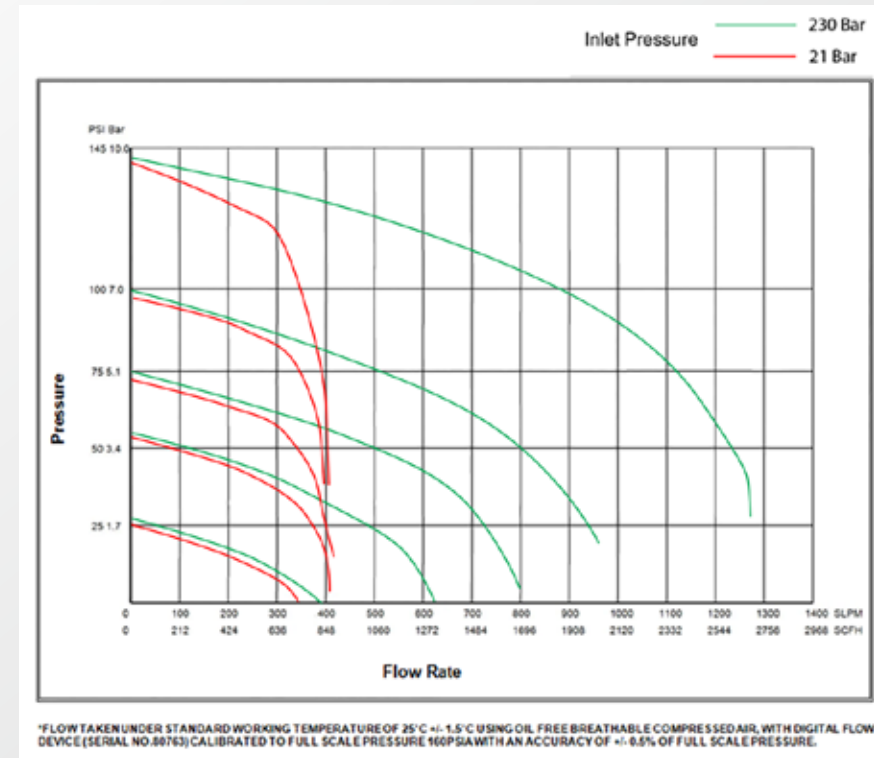

Model	Part Number	Outlet
Oxygen		
Two Stage 2 Gauge Oxygen Regulator	HL060002	5 Bar
	HL060003	10 Bar
Two Stage Oxygen Nevoc Hand Tight Regulator	HL060157	10 Bar
Two Stage Regulator 2 Gauge Oxygen Nevoc Spanner Tight Regulator	HL060058	10 Bar
Fuel Gas		
Two Stage 2 Gauge Acetylene Regulator	HL060004	1.5 Bar
Two Stage 2 Gauge Propane Regulator	HL060024	5 Bar
Two Stage 2 Gauge Hydrogen Regulator	HL060017	5 Bar
	HL060019	10 Bar
Inert		
Two Stage 2 Gauge Argon Regulator	HL060009	5 Bar
	HL060010	10 Bar
Two Stage 2 Gauge Helium Regulator	HL060015	5 Bar
	HL060016	10 Bar
Two Stage 2 Gauge Nitrogen Regulator	HL060021	5 Bar
	HL060022	10 Bar
Two Stage 2 Gauge Nitrogen Nevoc Spanner Type Regulator	HL060068	10 Bar
Two Stage 2 Gauge Helium Nevoc Spanner Type Regulator	HL060059	10 Bar
Two Stage Argon Nevoc Spanner Tight Regulator	HL060010SENEV	10 Bar
Two Stage Argon Nevoc Hand Tight Regulator	HL060118	35L

High Pressure Regulators

Operates with a high-pressure cylinder. Ideal for use with chemical plants, research laboratories, oil refineries, pressurising aircraft struts, charging accumulators, high-pressure testing, general industry and high pressure manifold distribution.

- 2 years warranty
- Manufactured from brass bar
- Manufactured under BS EN ISO 9001
- Pressure gauges conforms to BS EN 5171
- 300 bar service
- Inlet connection: G5/8 BSP RH
- Outlet connection: G3/8 BSP RH
- Fuel Gas on request
- Available in bottom or side entry
- 2500 / 3500 psi available in side entry only



High Pressure Regulator

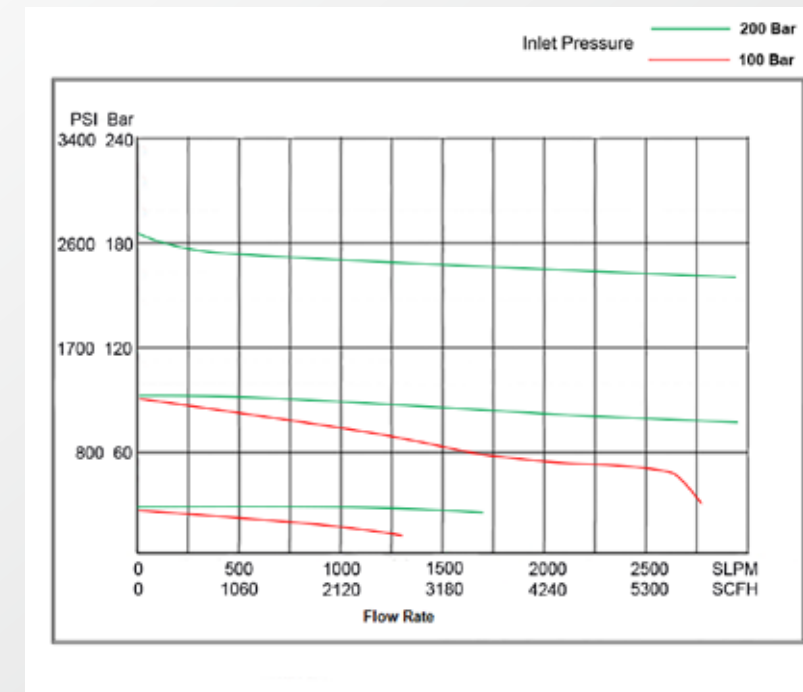

Model	Product Number	Gas
HL400 High Pressure Regulator (Available in bottom & side entry)	HL050104	Oxygen
	HL050105	Nitrogen
	HL050106	Inert
	HL050189	Nitrogen Nevoc
HL600 High Pressure Regulator (Available in bottom & side entry)	HL050107	Oxygen
	HL050108	Nitrogen
	HL050109	Inert
	HL050108SEN	Nitrogen Nevoc
HL800 High Pressure Regulator (Available in bottom & side entry)	HL050110	Oxygen
	HL050111	Nitrogen
	HL050112	Inert
HL1500 High Pressure Regulator (Available in bottom & side entry)	HL050113	Oxygen
	HL050114	Nitrogen
	HL050115	Inert
	HL050114SEN	Nitrogen Nevoc
HL2500 High Pressure Regulator (Side Entry Only)	HL050116	Oxygen
	HL050117	Nitrogen
	HL050233	Inert
HL3500 High Pressure Regulator (Side Entry Only)	HL050117SEN	Nitrogen Nevoc
	HL050167	Nitrogen
	HL050168	Oxygen
	HL050169	Inert
	HL050167SEN	Nitrogen Nevoc

High Flow Oxygen Regulator

HL060026

- 2 years warranty
- Manufactured under BS EN ISO 9001
- Gauges conform to ISO 5171
- Supplied with 1" -5/8" adapter
- 300 bar service
- 14 bar outlet
- Inner connection 1" BSP RH
- Outlet connection G3 / 8 BSP RH and 1/2 BSP RH



Line Regulator



Key Features:

- Manufactured under BS EN ISO 9001
- Conforms to BS EN ISO 7291
- Gauges conform to ISO 5171
- Rear entry
- High contrast, easy to read gauges
- Alloy bonnet for high strength
- 20 Bar Service
- Inlet connection 1/4 NPT R/H. 3/8 running Nut L/H or R/H depending on gas type
- Outlet connection 3/8 BSP LH or R/H depending on gas type
- Available at 3 O'clock and 6 O'clock outlet
- Acetylene - 1.5 Bar, Propane - 4 bar
- Oxygen - 4, 5, 10 & 12 Bar
- Inert Gas - 4, 5, 10 & 12 Bar

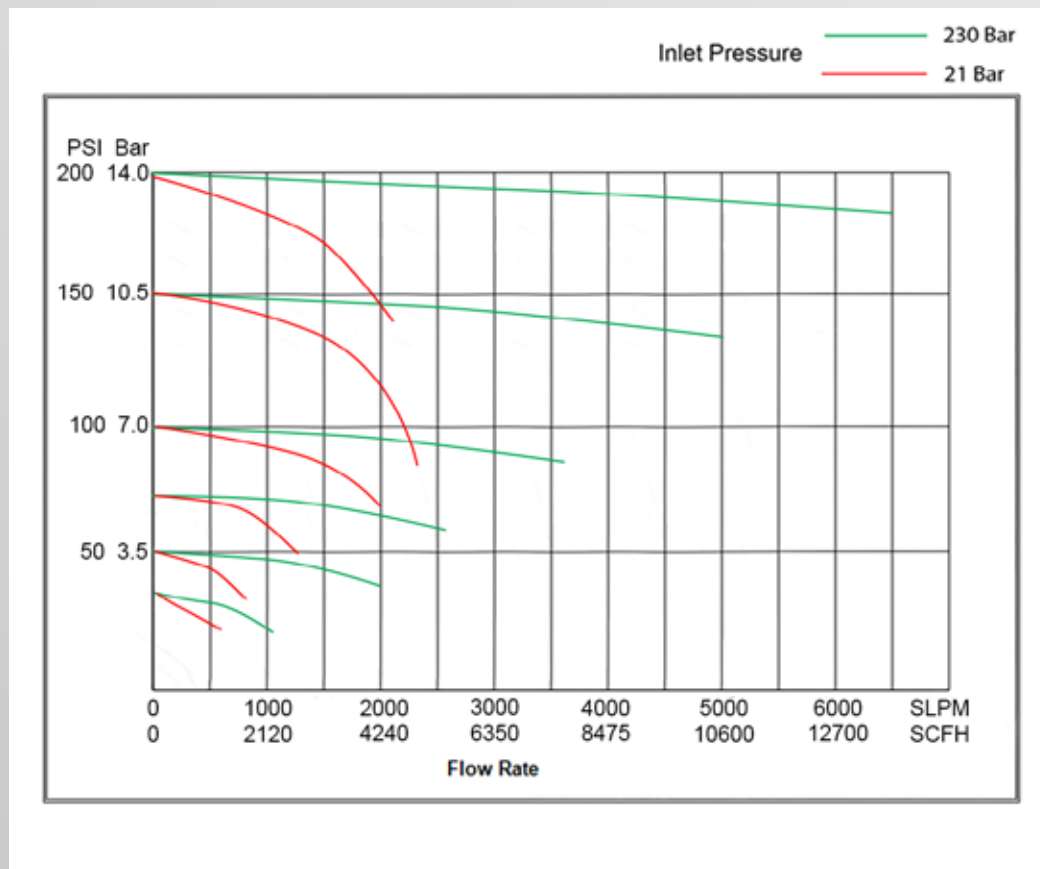

Model	Product Number	Gas
Line Regulator Fuel Gas	HL050132	Oxygen
Line Regulator Fuel Gas	HL050310	Argon
Line Regulator Fuel Gas	HL050134	Propane

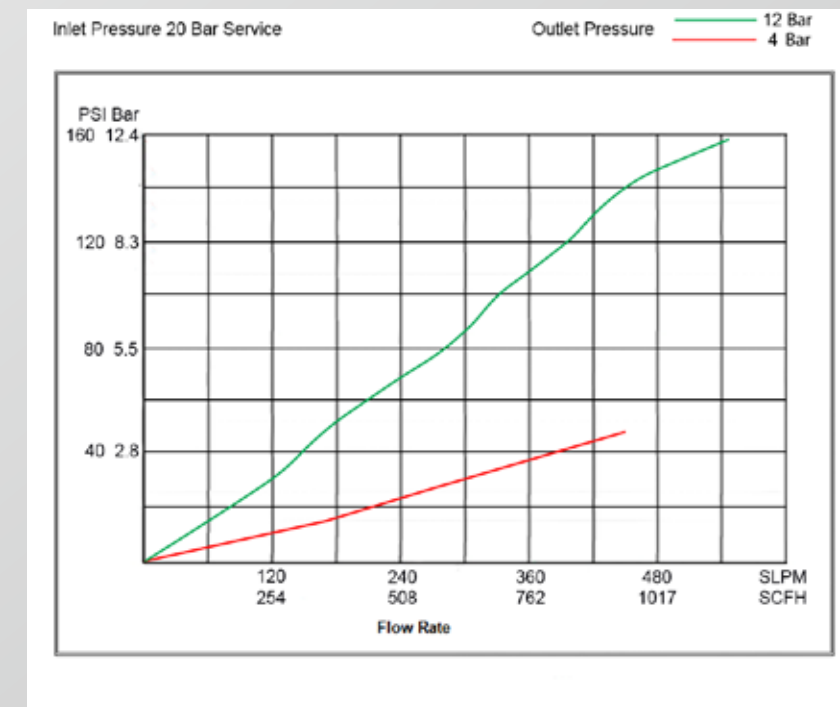

Contact us for Line Regulator Variations

Tapping Points Wall Brackets



Flowmeter Purge Regulator

Key Features:

- Gauges conform to ISO 5171
- 300 bar service
- Two flowmeters in either 0-14 or 0-25LPM or a mix of both.
- Calibration certificate on request for full traceability
- Ideal for twin machine operation.
- Back & tail purging
- Made in Britain



Model	Product Number	LPM
Rear Entry Pre Set 3.5 Bar Twin Flowmeter Purge Regulator	HL050245	14
Rear Entry Pre Set 3.5 Bar Twin Flowmeter Purge Regulator	HL050242	25

FabMaster Elite Co2 Regulator / Flowmeter with Intergral heater

Key Features:

- 200 bar service
- Manufactured under BS EN ISO 9001
- Conforms to BS EN ISO 2503
- Temperature automatically controlled between 50°C - 60°C
- Precise control over flow rate between 0-25L/min



Model	Product Number
Co2 Flowmeter with Integral Heater - CCA320	HL050137
Co2 Flowmeter with Integral Heater – BS341 No.8 (UK)	HL050138



FabMaster Elite Series Regulator / Flowmeter

Key Features:

- Regulator / flowmeter integral compact unit
- Manufactured under BS EN ISO 9001
- Conforms to BS EN ISO 13918
- Polycarbonate calibrated flow tube (LPM)



Model	Product Number	Inlet Connection
FabMaster Elite Series Regulator / Flowmeter	HLRF992 HLRF580	CGA992 CGA580



At Hi-Lo we produce a wide range of specialist steelwork products including nozzles, heavy-duty hoses, cutting & scarfing equipment

Cutting Torches

Our British made flat handled cutting torches are manufactured to a high standard and are 100% fully tested and built to last with a lifetime warranty.

There are two basic forms of hand cutting, the NM (Nozzle Mix) in which the fuel gas and oxygen are mixed in the nozzle and the Universal where the gases are mixed in the cutting torch head. Both versions can come as a “press to cut” or “release to cut” option. There is a wide range of lengths available from the standard 18”, 27” and 36”. Also, special requirements such as 3 metres are available upon request.

These cutting torches are of rugged construction and with a full range of spare parts and all torches are fully repairable.

Hi-Lo UK Cutting Torches are available with Acetylene or Propane nozzles.



MS Universal Flat Handle Cutting Torch

Key Features:

- British Made
- Lifetime warranty
- Manufactured under BS EN ISO 9001
- Conforms to EN ISO 5172
- Can be used with Acetylene & Propane nozzles.
- Available in Press To Cut or Release To Cut

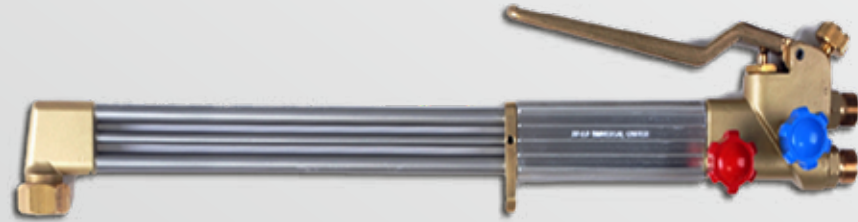

Model	Product Number	Head Degree	Cut Type
MS Universal 18" Cutting Torch	090042	75°	Release To Cut
	090041	90°	Release To Cut
	090043	180°	Release To Cut
	090032	75°	Press To Cut
	090031	90°	Press To Cut
	090033	180°	Press To Cut
MS Universal 27" Cutting Torch	090045	75°	Release To Cut
	090044	90°	Release To Cut
	090046	180°	Release To Cut
	090035	75°	Press To Cut
	090034	90°	Press To Cut
	090036	180°	Press To Cut
MS Universal 36" Cutting Torch	090048	75°	Release To Cut
	090047	90°	Release To Cut
	090049	180°	Release To Cut
	090038	75°	Press To Cut
	090037	90°	Press To Cut
	090039	180°	Press To Cut

Custom sizes available contact us for further information

Nozzle Mix Flat Handle Cutting Torch

Key Features:

- British Made
- Lifetime warranty
- Manufactured under BS EN ISO 9001
- Conforms to EN ISO 5172
- Can be used with Acetylene & Propane nozzles
- Available in Press To Cut or Release To Cut



Model	Product Number	Head Degree	Cut Type
NM Flat Handle 18" Cutting Torch	090002	75°	Press To Cut
	090001	90°	Press To Cut
	090003	180°	Press To Cut
	090020	75°	Release To Cut
	090021	90°	Release To Cut
	090022	180°	Release To Cut
NM Flat Handle 27" Cutting Torch	090005	75°	Press To Cut
	090004	90°	Press To Cut
	090006	180°	Press To Cut
	090023	75°	Release To Cut
	090024	90°	Release To Cut
	090025	180°	Release To Cut
NM Flat Handle 36" Cutting Torch	090010	75°	Press To Cut
	090009	90°	Press To Cut
	090011	180°	Press To Cut
	090026	75°	Release To Cut
	090027	90°	Release To Cut
	090028	180°	Release To Cut

Custom sizes available contact us for further information

Cut Safer

Cutting Nozzles

The principle of mixing Oxygen and Fuel gas within the nozzle of the cutting blowpipe is generally accepted as the best and safest arrangement for cutting mild steel. The safety is enhanced in the design of the nozzle also gives a suction to the Fuel Gas line of the blowpipe.

The Hi-Lo nozzle design illustrated (acetylene version) limits the amount of explosive oxy/fuel gas mixture to the low volume of the drilled and swaged pre-heat passages in the solid copper from which the nozzle is made.

Blowpipes which mix the oxygen and fuel gas using an injector situated near the handle of the blowpipe has a relatively large volume of explosive oxy/fuel gas mixture in the pre-heat tube and any backfire can be much more severe.

Hi-Lo ANM / PNM nozzles are precision manufactured to give an efficient performance and before leaving the factory, each one is individually tested to ensure suction to the acetylene line, quality of the pre-heat flame and accuracy of the oxygen cutting stream

Note: For operators who require a greater preheat flame, The Hi-Lo Supacut nozzles have been designed and manufactured for the Hi-Lo range. However, these do not incorporate the suction feature as shown above

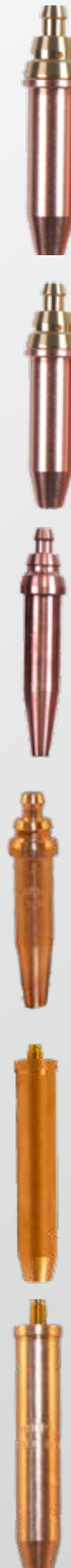

Nozzles

Model	Product Number	Size
PNM9S Cutting Nozzle	020001	1/32
	020002	3/64
	020003	1/16
	020004	5/64
	020005	3/32
	020007	1/8

Model	Product Number	Size
PNM9L Cutting Nozzle	020201	1/32
	020202	3/64
	020203	1/16
	020204	5/64
	020205	3/32
	020206	7/64
	020207	1/8

Model	Product Number	Size
ANM6S Cutting Nozzle	010001	1/32
	010002	3/64
	010003	1/16
	010004	5/64
	010005	3/32
	010007	1/8

Model	Product Number	Size
3P9 Cutting Nozzle	HL020472	3/64
	HL020473	1/16
	HL020477	1/8

Model	Product Number	Size
4" HD Prop Cutting Nozzle	020479	9/64

Model	Product Number	Size
'H' Type Cutting Nozzle	HL020483	1/16
	HL020487	1/8

Heavy Duty Cutting Nozzles



Model	Product Number	Size
PNMHD Cutting Nozzle	020421	1/8
	020422	3/16
	020423	7/32



Model	Product Number	Size
DBH Type Heavy Duty Nozzle	05010049	300-500mm
	05010050	500-700mm
	05010046	1000mm



Model	Product Number
MS Headnut	05092013
NM Headnut	05092012 – UK Made HL090020
Cutogen Headnut	05TR-10033



Special Nozzles



Model	Product Number	Size
AGNM Gouging Nozzle	HL010325	No.13 - 1/8
	HL010326	No.19 - 3/16
	HL010327	No.25 - 1/4
PGNM Gouging Nozzle	HL020009	No.1
	HL020007	No.2
	HL020006	No.3
	HL020008	No.4
GG Cutting Nozzle	HL040230	GG1
	HL040226	GG2
	HL040227	GG3
	HL040228	GG4
MA133D Cutting Nozzle	HLMA133DN01	No.1
	HLMA133DN02	No.2
	HLMA133DN03	No.3
	HLMA133DN04	No.4
	HLMA133DN05	No.5
VVC Cutting Nozzle	HL020425	5/0
	HL020426	4/0
	HL020427	000
	HL020428	00
	HL020429	0
	HL020430	0 ½
	HL020431	1
	HL020432	1 ½
	HL020433	2
	HL020434	2 ½
	HL020435	3
	HL020436	4
	HL020437	5

Elite Contractors Kit

HL3842550 - Oxygen / Propane
 HL3842549 - Oxygen / Acetylene

Kit Includes:

- Flat Handed Cutting Torch.
- 2 x Single Stage Regulators.
- 2 x Flashback Arrestors.
- 2 x Supacut Nozzles
- Sparklighter.
- Combi Spanner.
- Hose.
- Available with Plugged or Two Gauge Regulators.



FabMaster Single Stage Regulator

Key Features:

- 1 year warranty.
- 300 Bar Service
- Conforms to BS EN ISO 2503.
- Available in Oxygen, Argon, Acetylene and Propane
- Fully Tested Product
- Base Entry Only

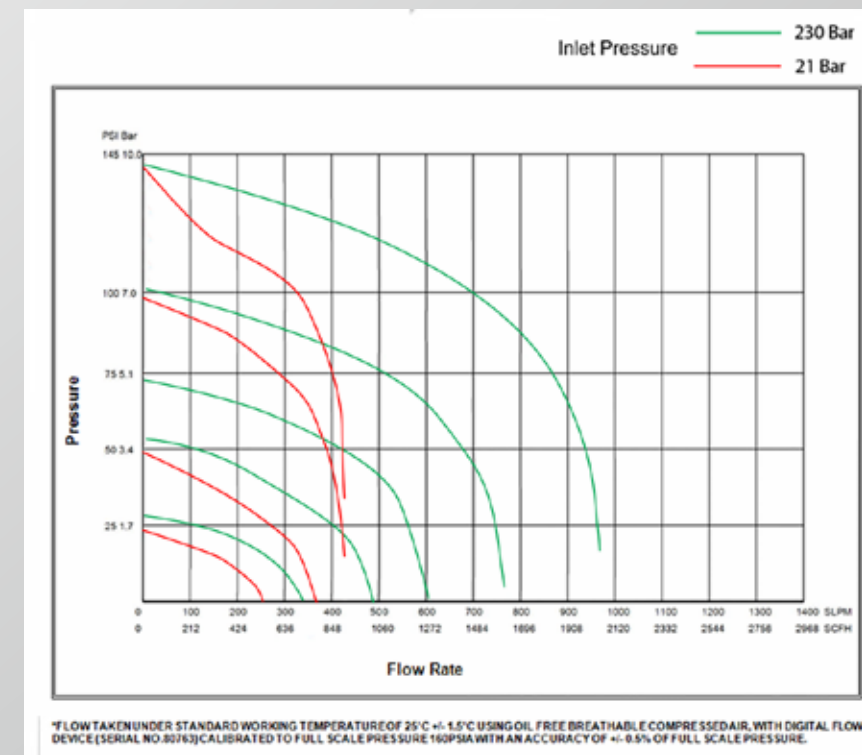

Model	Product Number	Output
FabMaster Oxygen Plugged Regulator	HL050012	10 Bar
FabMaster Argon 2 Gauge Regulator	HL050011	35LPM
FabMaster Propane Plugged Regulator	HL050013	4 Bar
FabMaster Acetylene 2 Gauge Regulator	HL050010	1.5 Bar
FabMaster Oxygen 2 Gauge Regulator	HL050009	10 Bar
FabMaster Argon 2 Gauge Regulator	HL050011-10BAR	10 Bar

Nozzle Mix Round Handle Cutting Torch

Key Features:

- Press to cut.
- Cutting capacity 200mm.
- Manufactured under BS EN ISO 9001.
- Conforms to 5172.
- Can be used with Acetylene and Propane nozzles.
- 1 year warranty.



Model	Product Number	Head Degree
NM Round Handle 18" Cutting Torch	HL090007	90°
	HL090008	180°
NM Round Handle 27" Cutting Torch	HL090017	75°
	HL090016	90°
NM Round Handle 36" Cutting Torch	HL090009	180°
	HL090019	75°
NM Round Handle 48" Cutting Torch	HL090018	90°
	HL090015	180°
NM Round Handle 60" Cutting Torch	HL090022	75°
	HL090021	90°
NM Round Handle 72" Cutting Torch	HL090028	180°
	HL090023	75°
NM Round Handle 60" Cutting Torch	HL090013	90°
	HL090158	180°
NM Round Handle 72" Cutting Torch	HL090024	75°
	HL090053	90°
	HL090052	180°

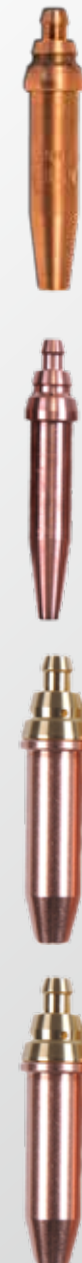

Supacut Nozzles

Model	Part Number	Size
ANMS S/C Cutting Nozzle	HL010001SC	1/32
	HL010002SC	3/64
	HL010003SC	1/16
	HL010004SC	5/64
	HL010005SC	3/32
	HL010007SC	1/8
ANML S/C Cutting Nozzle	HL010201SC	1/32
	HL010202SC	3/64
	HL010203SC	1/16
	HL010204SC	5/64
	HL010205SC	3/32
	HL010207SC	1/8
PNMS S/C Cutting Nozzle	HL020001SC	1/32
	HL020002SC	3/64
	HL020003SC	1/16
	HL020004SC	5/64
	HL020005SC	3/32
	HL020007SC	1/8
PNML S/C Cutting Nozzle	HL020201SC	1/32
	HL020202SC	3/64
	HL020203SC	1/16
	HL020204SC	5/64
	HL020205SC	3/32
	HL020207SC	1/8

Fabmaster Contractors Kit

HL3842547- Oxygen / Propane

HL3842548 - Oxygen / Acetylene

Kit Includes:

- Round Handle Cutting Torch
- 2 x Eco Single Stage Regulators
- 2 x Flashback Arrestors
- 3 x Supacut nozzles
- Sparklighter
- Combi Spanner
- Hose



FabMaster Elite Propane Heating Torch

The FabMaster Elite Propane heating torch can be used for numerous applications such as preheating, flame cleaning and paint removal. The torch includes twin gas control valves for precise adjustment of the Main Heater & Pilot Flame. New and improved propane heating torch.

Key Features:

- Manufactured under BS EN ISO 9001.
- Torch All Brass Construction
- Ergonomic Moulded Handle
- Fuel Gas Inlet 3/8 BSP (LH)
- Torch Kit Includes Handle, Neck & Nozzle.



Model	Product Number	Size
Propane Heating Torch	HL100064	8 (38mm) - 100mm (Neck)
	HL100065	18 (50mm) - 370mm (Neck)
	HL100066	38 (63mm) - 550mm (Neck)
Propane Heating Torch c/w Regulator & Hose	HL100067	8 (38mm) - 100mm (Neck)
	HL100068	18 (50mm) - 370mm (Neck)
	HL100069	38 (63mm) - 550mm (Neck)
Propane Nozzle Only	HL030944	8 (38mm)
	HL030945	18 (50mm)
	HL030946	38 (63mm)
Propane Heating Torch - Neck only	HL100073	100mm
	HL100074	370mm
	HL100075	550mm

Flashback Arrestors

Key Features:

- Safety devices for single cylinders, tapping points and distribution lines.
- Conforms to EN730-1 ISO / 5175.
- Stops flashback through flame arrestor.
- Avoids dangerous gas mixtures by a gas non-return valve.



Model	Product Number	Gas
Non-Reset DGN	HL070302	Fuel Gas
	HL070301	Oxygen

Model	Product Number	Gas
Resettable DS2000	HL070312	Fuel Gas
	HL070311	Oxygen

Model	Product Number	Gas
High Flow DG91N 3/8	HL070318	Fuel Gas
	HL070317	Oxygen

Model	Product Number	Gas
High Flow DG91N 1/2	HL070324	Fuel Gas
	HL070323	Oxygen

Model	Product Number	Gas
DG91N UA	HL070320	Fuel Gas
	HL070319	Oxygen

Model	Product Number	Gas
GG 3/8	HL070370	Fuel Gas
	HL070371	Oxygen

Model	Product Number	Gas
TT (6mm)	HL070366	Fuel Gas
	HL070365	Oxygen

Model	Product Number	Gas
GT 3/8	HL070359	Fuel Gas
	HL070360	Oxygen

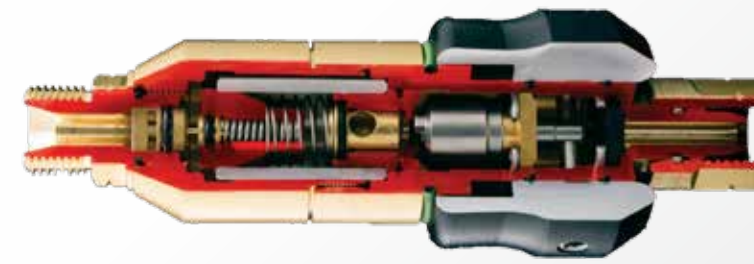

Inside Flashback Arrestors

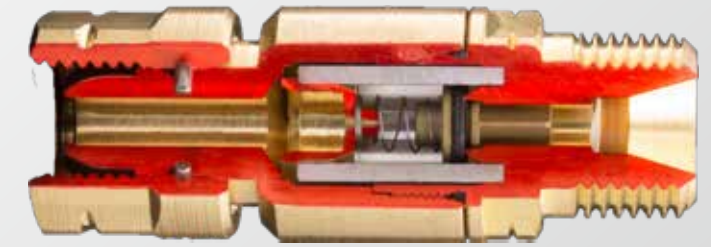

Quick Release Fittings

Key Features:

- Assist and avoiding the mix-up of the product for the different gas types
- Worldwide Compatible coupling system, type DKG for in-hose or torch side connection.
- Type DKG-W for in-hose or torch side connection.



Model	Product Number	Gas
D1 Coupling Pin 3/8	HL0069-4002	Fuel Gas
	HL0069-4007	Oxygen
D2 Coupling Pin 9mm	HL069-0403	Fuel Gas
	HL069-0407	Oxygen
D4 Coupling Pin 3/8	HL0069-0281	Fuel Gas
	HL0069-4212	Oxygen

Model	Product Number	Gas
DKD Coupling 3/8	HL3000-0635	Fuel Gas
	HL3000-0636	Oxygen

Model	Product Number	Gas
DKG Coupling 3/8	HL3000-0188	Fuel Gas
	HL3000-0637	Oxygen

Model	Product Number	Gas
DKG-W Coupling 3/8	HL3001-8423	Fuel Gas
	HL3001-8474	Oxygen

Shank & Accessories



Model	Product Number
LD Cutting Attachment	HL100056
LD Shank (Light Duty)	HL100055
LD Mixer	HL100057
Type 3 Heavy Duty Shank	HL100004
Type 3 Cutting Attachment	HL100005
FabMaster Elite Type 3 Standard Welding Mixer	HL100006
3 Heavy Duty Acetylene Mixer	HL100007
Prop Heating Mixer	HL100008

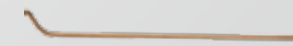

Mode	Product Number	Size
Lightweight Welding Nozzle – 145mm	HL040001	No.1
	HL040002	No.2
	HL040003	No.3
	HL040005	No.5
	HL040007	No.7
	HL040010	No.10
Lightweight Welding Nozzle – 220mm	HL040013	No.13
	HL040018	No.18
Type 2/3 Welding Nozzle – 150mm	HL040025	No.25
	HL040101	No.1
	HL040102	No.2
Type 2/3 Welding Nozzle – 185mm	HL040103	No.3
	HL040105	No.5
	HL040107	No.7
Type 2/3 Welding Nozzle – 290mm	HL040110	No.10
	HL040113	No.13
	HL040118	No.18
	HL040125	No.25
	HL040135	No.35

Mode	Product Number	Size
Super Heating Nozzles	HL030501	1HC
	HL030502	2HC
	HL030503	3HC
	HL030504	4HC
	HL030505	5HC
NM Super Heating Adaptor	HL150010	Use with superheating nozzles
Bent Necks	HL100021	10" Brass
	HL100023	12" Stainless Steel
	HL100034	28" Stainless Steel
AHT Heating Nozzle	HL030506	AHT 25
	HL030507	AHT 50
	HL030508	AHT 100
AFN Heating Nozzle	HL010391	1/32
	HL010392	3/64
	HL010393	1/16

Shank & Accessories



Model	Part Number
90 DEG Cylinder Adaptor R/H	HL100025
90 DEG Cylinder Adaptor L/H	HL100026
180 DEG Cylinder Adaptor R/H	HL100027
180 DEG Cylinder Adaptor L/H	HL100028
3 Way Cylinder Branch Adaptor R/H	HL100085
3 Way Cylinder Branch Adaptor L/H	HL100086

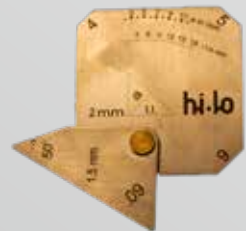

Model	Product Number
Fillet Gauge Multi-purpose	HL00014
Marker Pens (Ideal for Steel Surfaces) Box of 12	HL400009 – Black HL400010 – Blue HL400011 – Red HL400012 – White HL400013 – Yellow
Cup Type Spark Lighter	HL150004
Triple Flint Spark Lighter	HL150002
Renewals	HL150005 (Cup Type) HL150003 (Triple Flint)
Small Circle Cutting Attachment	HL150007
Large Circle Cutting Attachment	HL150008

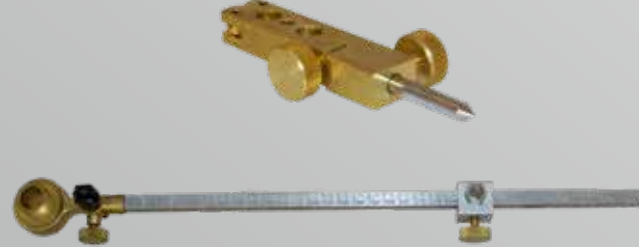

Model	Product Number
Nozzle / Tip Cleaner	HL150001
Drop forged spindle key	HL1500028
Drop forged combination spanner	HL150027
Mild Steel 4 Row Wire Brush	270036
Stainless Steel 4 Row Wire Brush	270037
Model 'O' Lead Burning Kit	HL100009
Gas Economisers	HL150029 - 3/8 Oxygen / Acetylene HL150029P - 3/8 Oxygen / Propane



Outlet Valves

Key Features:

- Connect two sets of hoses and torch equipment to a single gas inlet.
- Control the flow of gas from each outlet individually.
- Used to divide an oxygen/argon cylinder outlet to provide gas to two hoses from the same regulator.
- 3/8" BSP threaded nut and provides independently variable supplies of the gas to two hoses.



Model	Product Number	
Twin Outlet	HL150025	L/H
	HL150026	R/H

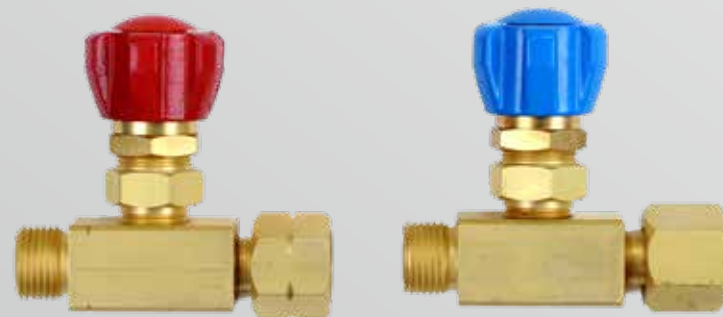

Model	Product Number	
Single Outlet	05110021	L/H
	05110022	R/H

Brassware

Our bespoke brassware below are a few examples of what we can offer:



Screwed Coupler
3/8 x 1/2 R/H

Screwed Coupler
1/2 x 1/2 R/H

3/4 Nut & Tail R/H

1/2 Nut & Tail L/H

Hoses

Fitted hoses complete with nut & tail at one end & a hose check valve at the other.



6.3mm Hose	Product Number
¼" – ¼" HCV RH Blue 5m	HL130001
¼" – ¼" HCV LH Red 5m	HL130002
¼" – ¼" HCV Propane Orange 5m	HL130002P
¼" – ⅜" HCV RH Blue 5m	HL130003
¼" – ⅜" HCV LH Red 5m	HL130004
¼" – ⅜" HCV Propane Orange 5m	HL130004P
¼" – ¼" HCV RH Blue 10m	HL130005
¼" – ¼" HCV LH Red 10m	HL130006
¼" – ¼" HCV Propane Orange 10m	HL130006P
¼" – ⅜" HCV RH Blue 10m	HL130007
¼" – ⅜" HCV LH Red 10m	HL130008
¼" – ⅜" HCV Propane Orange 10m	HL130008P
¼" – ¼" HCV RH Blue 20m	HL130009
¼" – ¼" HCV LH Red 20m	HL130010
¼" – ¼" HCV Propane Orange 20m	HL130010P
¼" – ⅜" HCV RH Blue 20m	HL130011
¼" – ⅜" HCV LH Red 20m	HL130012
¼" – ⅜" HCV Propane Orange 20m	HL130012P

8mm Hose	Product Number
⅝" – ⅜" HCV RH Blue 5m	HL130013
⅝" – ⅜" HCV LH Red 5m	HL130014
⅝" – ⅜" HCV Propane Orange 5m	HL130014P
⅝" – ⅜" HCV RH Blue 10m	HL130015
⅝" – ⅜" HCV LH Red 10m	HL130016
⅝" – ⅜" HCV Propane Orange 10m	HL130016P
⅝" – ⅜" HCV RH Blue 20m	HL130017
⅝" – ⅜" HCV LH Red 20m	HL130018
⅝" – ⅜" HCV Propane Orange 20m	HL130018P

10mm Hose	Product Number
⅜" – ⅜" HCV RH Blue 5m	HL130019
⅜" – ⅜" HCV LH Red 5m	HL130020
⅜" – ⅜" HCV Propane Orange 5m	HL130020P
⅜" – ⅜" HCV RH Blue 10m	HL130021
⅜" – ⅜" HCV LH Red 10m	HL130022
⅜" – ⅜" HCV Propane Orange 10m	HL130022P
⅜" – ⅜" HCV RH Blue 20m	HL130023
⅜" – ⅜" HCV LH Red 20m	HL130024
⅜" – ⅜" HCV Propane Orange 20m	HL130024P



Long Length Unfitted Hose

6.3 mm Hose	Product Number
¼" Blue 100m	HL130049
¼" Red 100m	HL130050
¼" Orange 100m	HL130050P
8mm Hose	
5/16" Blue 100m	HL130051
5/16" Red 100m	HL130052
5/16" Orange 100m	HL130052P
10mm Hose	
3/8" Blue 100m	HL130053
3/8" Red 100m	HL130054
3/8" Orange 100m	HL130054P

Mandril	Product Number
10mm x 20mtr 4ply Blue	HL130056
10mm x 40mtr 4ply Blue	HL130057
10mm x 20mtr 4ply Red	HL130058
10mm x 40mtr 4ply Red	HL130059
10mm x 20mtr 4ply Orange	HL130059P
10mm x 40mtr 4ply Orange	HL130061P
13mm x 20mtr 4ply Blue	HL130062
13mm x 40mtr 4ply Blue	HL130063
13mm x 20mtr 4ply Red	HL130064
13mm x 40mtr 4ply Red	HL130065
13mm x 20mtr 4ply Orange	HL130066P
13mm x 40mtr 4ply Orange	HL130067P

Hose Fittings

Model	Part Number	Size	Gas
Hose Check Valve	HL120001	3/8" RH - 3/8" Tail	Oxygen
	HL120002	3/8" LH - 3/8" Tail	Fuel Gas
	HL120003	1/4" RH - 1/4" Tail	Oxygen
	HL120004	1/4" LH - 1/4" Tail	Fuel Gas
	HL120005	3/8" RH - 1/4" Tail	Oxygen
	HL120006	3/8" LH - 1/4" Tail	Fuel Gas
	HL120007	3/8" RH - 5/16" Tail	Oxygen
	HL120008	3/8" LH - 5/16" Tail	Fuel Gas
Hose Nut	HL120010	3/8" BSP RH	Oxygen
	HL120011	3/8" BSP LH	Fuel Gas
	HL120012	1/4" BSP RH	Oxygen
	HL120013	1/4" BSP LH	Fuel Gas
Tail For Nut	HL120014	3/8" Tail - 3/8" Nut	
	HL120015	5/16" Tail - 3/8" Nut	
	HL120016	1/4" Tail - 1/4" Nut	
	HL120017	1/4" Tail - 3/8" Nut	
Coupler	HL120018	3/8" - 3/8" BSP RH	Oxygen
	HL120019	3/8" - 3/8" BSP LH	Fuel Gas
	HL120020	1/4" - 1/4" BSP RH	Oxygen
	HL120021	1/4" - 1/4" BSP LH	Fuel Gas
	HL120022	1/4" - 3/8" BSP RH	Oxygen
	HL120023	1/4" - 3/8" BSP LH	Fuel Gas
Hose Splicer	HL120024	3/8"	
	HL120025	5/16"	
	HL120026	1/4"	
'O' Clip	HL120027	1/2" Nominal	
	HL120028	9/16" Nominal	
	HL120029	5/8" Nominal - 6.3mm / 8mm	
	HL120030	3/4" Nominal - 8.0mm / 10mm	
HL120031	7/8" Nominal - 10mm		
'O' Clip Pincer	HL120032		



AGA Style Type 21

Model	Product Number	Head Degree °
Type 21 Cutting Attachment	HLA45	45°
	HLA75	75°
	HLA90	90°
	HLA180	180°

Model	Product Number
Type 21 Shank	HLASHANK

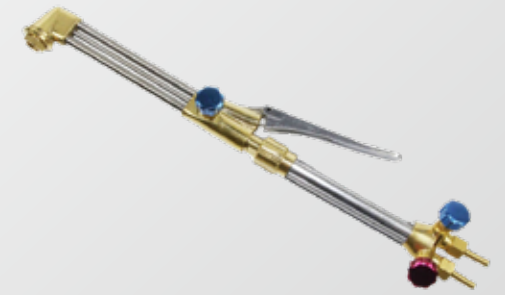

Comet Style Cutting Tip Type 41 Oxygen / Acetylene

Key Features:

- High quality
- Interchangeable with comet series.
- Type 41 for Acetylene cutting only

Model	Product Number	Size
Comet Style Cutting Tip Type 41	HLGCCTA08	#8 6-10mm
	HLGCCTA12	#12 10-20mm
	HLGGACTA15	#15 25 - 75mm
	HLGGACTA20	#20 100 - 125mm
	HLGCCTA24	#24 150 - 200mm
	HLGCCTA32	#32 225 - 300mm

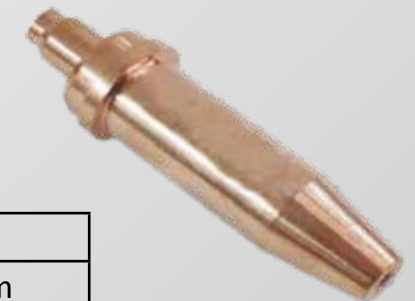

Comet Style Cutting Tip Type 41 Oxygen / Acetylene

Key Features:

- High quality and interchangeable
- Type 44 series for LPG cutting only.

Model	Product Number	Size
Comet Style Cutting Tip Type 44	HLGCCTL06	#6 3 - 6mm
	HLGCCTL08	#8 6 - 10mm
	HLGCCTL12	#12 10 - 20mm
	HLGCCTL15	#15 25 - 75mm
	HLGCCTL20	#20 100 - 125mm
	HLGCCTL25	#25 150 - 200mm



Comet Style 3 Cutting Attachment Suits Type 41 / 44 Tips

Key Features:

- Cuts up to 150mm
- Suits 41 and 44 type cutting tips
- Suits Acetylene / LPG
- Suits 41 and 44 gouging tips
- Comet 3 connection
- High quality needle valve for fast and accurate flame adjustment
- O-ring seal to form a perfect gas-tight seal.
- Press lever for easy cutting use
- Cigweld style
- Industrial Quality
- Cutting Tips Sold Separately



Model	Product Number
Comet Style 3 Cutting Attachment Suits Type 41 /44 Tips	HLCA3210

Comet Style 3 Handle 5/8 UNF

Key Features:

- Suitable for fusion, welding, brazing, soldering, heating and metal hand cutting.
- Tapered seat head allows multi-positioning of gouging nozzles.
- Twin tube construction gives good visibility.
- Unique multi-mixer design accommodates Oxygen/Acetylene, Oxygen/LPG and Oxygen/Natural gas.



Model	Product Number
Comet Style 3 Handle 5/8 UNF	HLTH3220

Comet Style Mixer

Key Features:

- Suitable for use with Oxygen-Acetylene, Oxygen-LPG or Oxygen-natural gas.
- Hand tightening for easy attachment onto blowpipe.



Model	Product Number
Comet Style Mixer M8 Brazing	HL034002
Comet Style Mixer Oxygen / LPG / Acetylene Heating M10	HL034003
Comet Style Mixer Oxygen / LPG Heat M10	HL0304166

Gas Cutting & Welding Kit

HL3842551

Key Features:

- Set includes everything you need to get up and running.
- Available in both Oxygen /LPG and Oxygen / Acetylene.



Victor Style FabMaster Outfit Deluxe Contractors Kit

HL3842544

Kit Includes:

- Single Stage Regulators
- 300 series handle
- 300 series cutting attachment
- 2 x Welding nozzle
- 2 x Cutting Nozzle
- 2 x GG Flashback
- Heating Nozzle - Size 6
- GG Torch mounted flashback arrestors
- 1/4 Bore T-grade fitted hose set
- Triple flint lighter
- Cutting / Welding goggles
- Nozzle cleaner set



Victor Style FabMaster Welding Handle

Key Features:

- Conforms to BS EN ISO 5172
- Manufactured under BS EN ISO 9001
- Drop forged body
- Gas specific colour coded control valves



Model	Product Number	Length
FabMaster Welding Handle Medium Duty - 100 Series	HL270WH	205
FabMaster Welding Handle Heavy Duty 300 Series	HL370WH	215

Victor Style FabMaster Cutting Attachment

Key Features:

- Conforms to BS EN ISO 5172
- Manufactured under BS EN ISO 9001
- Drop forged body
- Gas specific colour coded control valves



Model	Product Number	Length
FabMaster Cutting Attachment Medium Duty 100 Series	HL270CA	200mm
FabMaster Cutting Attachment Heavy Duty 300 Series	HL370CA	265MM

Victor Style Nozzles

Key Features:

- General purpose hand and machine torch cutting tips.
- Use with Acetylene or natural gas and propane.

Model	Product Number	Size	
Victor Type Series 1	HL013303	Size 000	
	HL013304	Size 00	
	HL013305	Size 0	
	HL013306	Size 1	
	HL013307	Size 2	
	HL013308	Size 3	
	HL013309	Size 4	
	HL013310	Size 5	
	HL013311	Size 6	
	HL013312	Size 7	
	HL013313	Size 8	
	Victor Type Series 3	HL013314	Size 000
		HL013315	Size 00
HL013316		Size 0	
HL013317		Size 1	
HL013318		Size 2	
HL013319		Size 3	
HL013320		Size 4	
HL013321		Size 5	

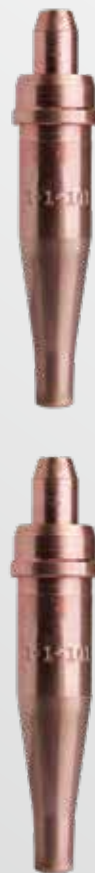

Key Features:

- Manufactured under BS EN ISO 9001
- 100% Flame Tested Product
- Brass Coupling nut & mixer
- Dual 'O' ring
- Hand tight secure connection
- C111 Grade copper

MFA Heating Nozzle

Model	Product Number	Size
MFA Type Heating Nozzle	HL1-MFA-6	6
	HL1-MFA-8	8
	HL1-MFA-10	10
	HL1-MFA-12	12
	HL1-MFA-15	15

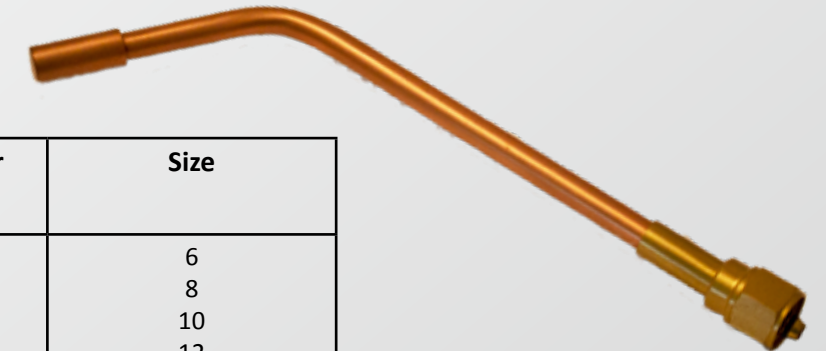

W Series Welding Nozzle

Model	Product Number	Size
W Series Welding Nozzle	HL1-W-0	0
	HL1-W-00	00
	HL1-W-000	000
	HL1-W-1	1
	HL1-W-2	2
	HL1-W-3	3
	HL1-W-4	4
	HL1-W-5	5
	HL1-W-6	6
	HL1-W-7	7
	HL1-W-8	8
HL1-W-9	9	
HL1-W-10	10	

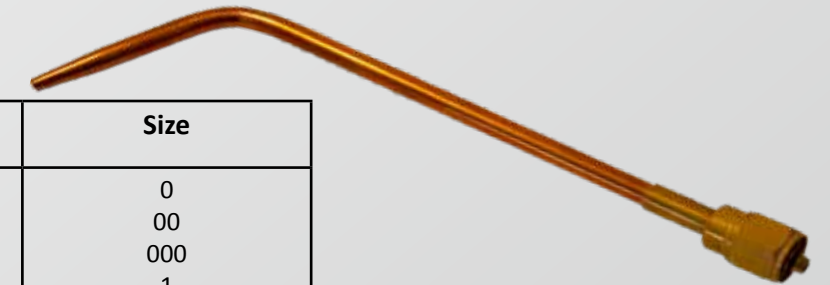

Model	Product Number	Size
W-1 Series Welding Nozzle	HL3-W1-0	0
	HL3-W1-00	00
	HL3-W1-000	000
	HL3-W1-1	1
	HL3-W1-2	2
	HL3-W1-3	3
	HL3-W1-4	4
W-1 Series Welding Nozzle	HL3-W1-5	5
	HL3-W1-6	6
	HL3-W1-0	0
	HL3-W1-00	00
	HL3-W1-000	000
	HL3-W1-1	1
	HL3-W1-2	2
HL3-W1-3	3	
HL3-W1-4	4	
HL3-W1-5	5	
HL3-W1-6	6	

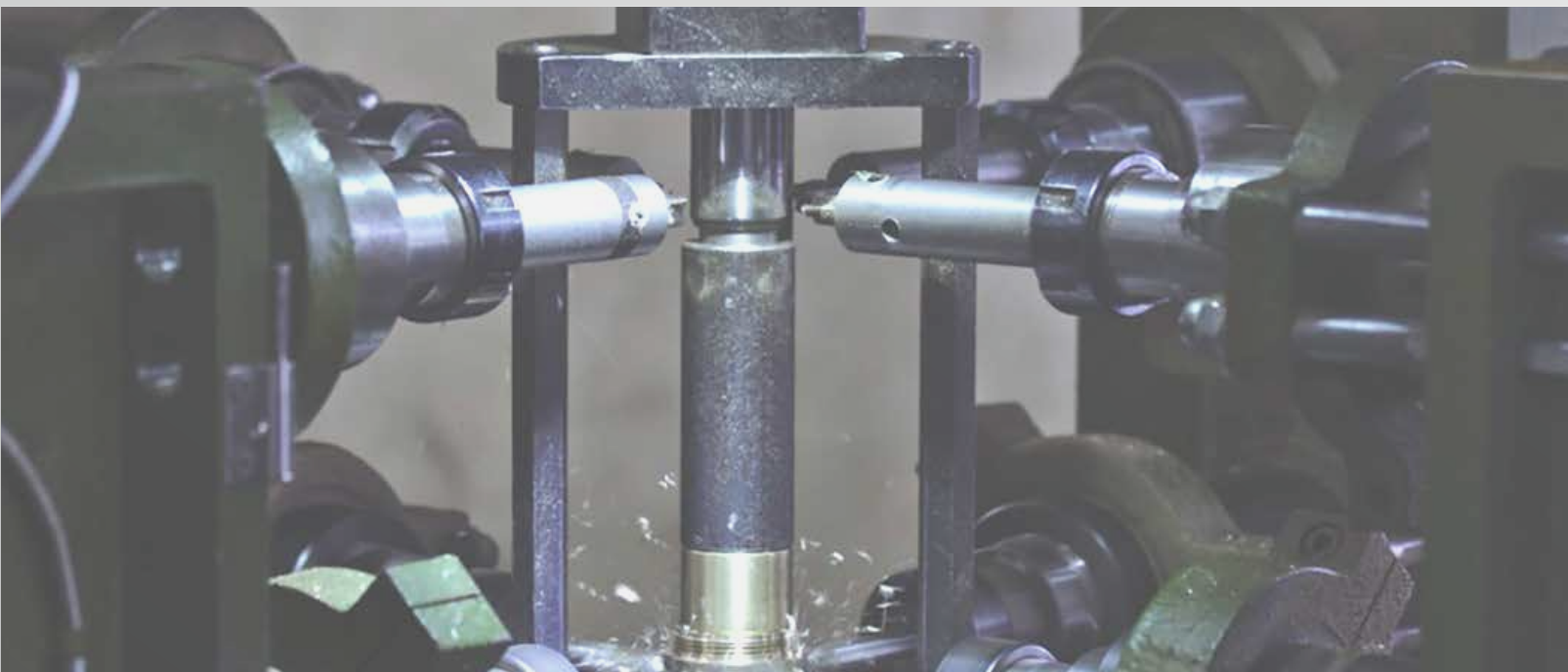
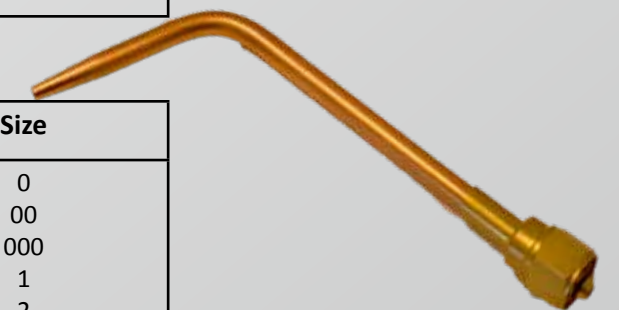

Victor Style FabMaster One Piece Cutting Torch

Key Features:

- 200mm maximum cut capacity
- Conforms to BS EN ISO 5172
- Manufactured under BS EN ISO 9001
- Drop forged cutter body



Model	Product Number	Size
FabMaster One Piece Cutting Torch	HLSCT2130090	21" / 90°
	HLSCT2730090	27" / 90°
	HLSCT36300180	36" / 90°
	HLSCT3630075	36" / 75°
	HLSCT4830075	48 / 75°
	HLSCT4830090	48" / 90°

Headnuts

100 Series Headnut
HL090050



300 Series Headnut
HL090051



UA-12 Straight Line Cutter

Key Features:

- Ideal for light and heavy industrial use.
- Quick Touch Gas Control system.
- Supplied with 1.8m length of distortion-proof steel track.
- Adjustable travel speed - in forward and reverse to provide good, quality cuts.
- Easy-to-use interface.
- Allows the operator to turn the supply on and off with one lever.
- All Spares Available.

Model	Product Number	Voltage
UA-12 Straight Line Cutter	HL090110	110V
	HL090111	230V

Model	Product Number	Size
UA-12 Twin torch Upgrade Kit	HL090169	
UA-12 Radius Arm	HL090170	600mm
	HL090171	1000mm



1.8mtr Track available separately



Model	Product Number
UA-12 1.8mtr TrXK	HL091000

Pipe Cutter
HL090112

Key Features:

- For cutting straight or bevelled edges on pipe from 114 - 600mm
- Using Acetylene or Propane up-to thickness of 50mm.

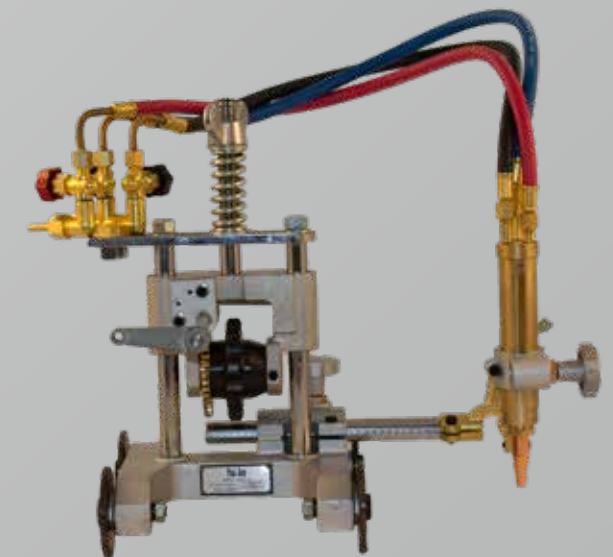

HL-200 Straight Line Cutting Machine

HL090047A

The HL-200 Portable Flame Cutting Machine is a tough, ruggedly constructed cutting machine, yet compact and light enough that it may be taken to the worksite. It is versatile, economical with a basic guidance system that can be used for dependable, trouble-free flame cutting, flame treating or hardening.

Key Features:

- Makes straight line cuts of any length.
- Calibrated scale for torch angle selection for bevel or chamfer cuts.
- Dual speed and clutch controls for easy operation from either end.
- Integral carrying handle, light weight and balanced design.
- Makes X, Y, V or K cuts with multiple torches for plate edge operation.
- 360° free-roating torch pivot knuckle
- 360° free-roating rack bar holder



Mobile Gas Tapping Points

Key Feature:

- Used for the mobile gas supply of welding and cutting stations.
- Supply five welding stations with both fuel gas and oxygen on construction sites.



Model	Product Number
Argon Pig Manifold	HLAM8-3/8FS

Manifolds

Key Features:

- Ensure the continuous supply of technical gases from the gas cylinder or bundle to the point of use.
- Safety-critical components are BAM tested and approved.
- Additionally we supply all components for movable and stationary manifolds.



6 Way Argon
HL14000015



6 Way Oxygen
HL14000014

Bespoke Burner

This 5 burner head is just one of the examples of our bespoke heating products, we can design, build and supply.



Contact us if you have any bespoke requirements

Distribution Panels

Four-way distribution panels complete with isolation valve and flashback arrestor.

Oxygen Manifold 4 outlet c/w Flashback, 10 Bar working pressure.



Propane Manifold 4 outlet c/w Flashback, 5 Bar working pressure.



Leatherware



Model	Product Number
Heavy Duty Gold Welding Gauntlets	HL140038
Standard TIG Gloves	HL14-0085
Reinforced Kevlar Stitched TIG Gloves (Gold/White)	HL-14-1159
Leather Jacket (Available in sizes S-XXXL)	HL14-S12515
Heavy Duty Rigger Gloves (Gold / Grey)	HL400007
Standard Rigger Gloves (Red/ Grey)	HL400008
Protective Welding Sleeves	HL140001
Leather Gaiter / Spats	HL140019



Protective Welding Sleeves

Chrome Leather Gaiter / Spats

Aquasol

CORPORATION

Aquasol is a leading manufacturer of water-soluble and other cutting edge purging technologies for the welding industry.

www.hilouk.co.uk | 0114 349 4749 | sales@hilouk.co.uk |
56 Newhall Road, Sheffield, S9 2QL



Aquasol® Water Soluble Paper is made of sodium carboxy methyl, a cellulose and wooden pulp that dissolves rapidly and completely in most liquids including water. Can be used to dam argon or helium gases during tungsten inert gas (TIG) welding of steel or aluminium pipes. Environmentally friendly and non-toxic. Aquasol® Paper can be formed into any size purge dam when used in conjunction with water soluble tape.

Item No	Type	Dimensions		Case Qty
		English	Metric	
ASW-35/S-11RW	Sheet	8 1/2" x 11"	22cm x 28cm	500
ASW-35/S-14R	Sheet	8 1/2" x 14	22cm x 36cm	500
ASW-35/S-22R	Sheet	17" x 22"	43cm x 56cm	500
ASW-60/S-22R	Sheet	15 1/2" x 22"	39cm x 56cm	250
ASW-35/R-15	Roll	15 1/2" x 165'	39cm x 50m	4
ASW-35/R-9	Roll	9" x 165'	23cm x 50m	4
ASW-40C/R-20	Roll	20 1/2" x 165'	52cm x 50m	4
ASW-60/R-15	Roll	15 1/2" x 165'	39cm x 50m	4
ASW-60/R-31	Roll	31" x 165'	79cm x 50m	4

Aquasol® Water Soluble Tape is a pressure sensitive water soluble tape recommended to hold purge dams in position, and when needed to splice two or more pieces of Aquasol® paper together. Sold in rolls.

Item No.	Type	Dimensions		Case Qty.
		English	Metric	
ASWT-1	Roll	1" x 300'	2.5cm x 92m	24
ASWT-2	Roll	2" x 300'	5.0cm x 92m	12

EZ Purge® is a pre-formed, self-adhesive, water soluble purge dam that enables welders to save time on weld preparation as well as improve project timeliness. Since EZ Purge® is pre-formed; there is no need to measure, cut or construct a purge dam. Setup and installation time is completed in minutes, making EZ Purge® the most efficient and economical purge dam available.



Item No.	Dimensions		Case Qty
	English	Metric	
EZP-2	2"	51mm	192
EZP-3	3"	76mm	192
EZP-4	4"	102mm	48
EZP-5	5"	128mm	48
EZP-6	6"	152mm	48
EZP-8	8"	203mm	48
EZP-10	10"	254mm	48
EZP-12	12"	305mm	48
EZP-14	14"	356mm	24
EZP-16	16"	406mm	24

Item No.	Dimensions		Case Qty
	English	Metric	
EZP-18	18"	457mm	24
EZP-20	20"	508mm	24
EZP-22	22"	559mm	24
EZP-24	24"	610mm	24
EZP-26	26"	660mm	24
EZP-28	28"	711mm	24
EZP-30	30"	765mm	24
EZP-32	32"	813mm	24
EZP-36	36"	918mm	24

Sizes 40 - 84" & Custom Sizes Available Upon Request

PRO OX®-100 Oxygen Monitor accurately measures concentration of oxygen in purged tubing and high purity weldments with 0.01% (100 ppm) resolution.

Features: A battery powered, rechargeable, programmable, handheld digital oxygen monitor with an internal pump. The state-of-the-art device is equipped with several features including an audiovisual alarm system; easy to read high-contrast, digital LCD display; data logging capability and data output to a computer for recording history. One Year Warranty.

Kit Contents: PRO OX-100® Monitor, Sensor and Polycarbonate Carrying Case; Ultra Slim Stainless Steel Probe with Neoprene Extension Tubing for Remote Monitoring, Rechargeable Battery & Charging Dock, Phillips Head Screwdriver, USB Cable, Manual and Quick Instructions.



Item No	Description	Dimensions		Weight	
		English	Metric	English	Metric
P-OXKIT	PRO OX-100 Oxygen Monitor & Accessories Kit	11" x 9" x 4"	279mm x 227mm x 102mm	4.00lb	182g
P-OX KIT Euro	PRO OX-100 Oxygen Monitor & Accessories Kit with European Charger	11" x 9" x 4"	279mm x 227mm x 102mm	4.00lb	182g
P-OX Sensor	PRO OX-100 Oxygen Sensor	1" x 1"	21mm x 20mm	0.03lb	16g
P-OX Batt	PRO OX-100 9V NIMH Battery	2" x 1" x 1"	48mm x 26mm x 17mm	0.12lb	54g
P-OX Charger/US	PRO OX-100 12V NiMH Battery Charger with US Type Plug	3" x 2" x 1"	8mm x 60mm x 25mm	0.10lb	59g
P-OX Charger/EU	PRO OX-100 12V NiMH Battery Charger with European Type Plug	3" x 2" x 1"	8mm x 60mm x 25mm	0.10lb	59g
P-OX Charger/PSE	PRO OX-100 12V NiMH Battery Charger with Japanese Type Plug	3" x 2" x 1"	8mm x 60mm x 25mm	0.10lb	59g
P-OX USB	PRO OX-100 USB Cable (72" or 1.8m)	4" x 4" x 1"	102mm x 102mm x 25mm	0.11lb	50g



PURGE GAS RETAINING TAPE

EZ Zone® Tape is a purge gas retaining tape used to seal the root gap between pipes to trap argon gas. Composed of two adhesive sections separated by an adhesive-free center zone. The adhesive portion of the tape never comes in contact with the pipe

Item No.	Dimensions		Adhesive Free Zone		Case Qty
	English	Metric	English	Metric	
EZ-ZT 2.5	2.5" x 75'	64mm x 23m	1"	25mm	18
E-ZT 4.0	4.0" x 75'	102mm x 23m	2"	51mm	12

EZ Tape® is a traditional aluminum tape that can be used for sealing the root gap while purging and sealing pipe ends for transport. Conventional uses include; sealing ducts for heating, air conditioning and refrigeration; and acting as an a vapor barrier. EZ Tape® is high temperature resistant, halogen-free and conforms to irregular surfaces.

Item No.	Dimensions		Case Qty
	English	Metric	
EZ-T 2.0	2" x 75'	51mm x 23m	24



BACKING TAPE

Fiback® fiberglass backing tape is a heat resistant aluminum tape with a woven fiberglass center strip, designed to eliminate or reduce the need for back purging and post weld grinding. Available in 200 AMP & 600 AMP formats.



Item No.	Dimensions		Case Qty
	English	Metric	
200 AMP			
AFBT-2.5-200	2.5" x 82'	64mm x 25m	5
AFBT-4.0-200	4.0" x 82'	102mm x 25m	5
600 AMP			
AFBT-2.5	2.5" x 41'	64mm x 12.5m	5
AFBT-4.0	4.0" x 41'	102mm x 12.5m	5

SOLUGAP® WATER SOLUBLE SOCKET WELD SPACER RINGS AND STEELSPACE® CERTIFIED 316L STAINLESS STEEL SOCKET WELD RINGS Provide the 1/16" (1.6 mm) minimum gap required by ANSI 31.1, Section III, ASME, US & Navy and Military Codes.

SoluGap® Water Soluble Socket Weld Spacer Rings are made of EPA Approved Aquasol® Water Soluble Board. Dissolves completely and rapidly in most liquids. Unique tabs secure placement regardless of orientation. Compatible with any metal.



Item No.	Pipe Size		Packaging
	English	Metric	
SGP-0.5	1/2"	20mm	50pcs/bag
SGP-0.75	3/4"	25mm	50pcs/bag
SGP-1.0	1"	32mm	50pcs/bag
SGP-1.25	1 1/4"	40mm	50pcs/bag

Item No.	Pipe Size		Packaging
	English	Metric	
SGP-1.50	1 1/2"	50mm	50pcs/bag
SGP-1.75	1 3/4"	57mm	50pcs/bag
SGP-2.0	2"	63mm	50pcs/bag
SGP-2.5	2 1/2"	73mm	50pcs/bag

SteelSpace® Socket Weld Rings are traditionally designed and manufactured with Certified 316L stainless steel. Secures in place with spring tension and remains a permanent part of the joint.

Item No.	Pipe Size		Packaging
	English	Metric	
SGP-0.5	1/2"	20mm	25pcs/bag
SGP-0.75	3/4"	25mm	25pcs/bag
SGP-1.0	1"	32mm	25pcs/bag
SGP-1.50	1 1/2"	50mm	25pcs/bag
SGP-1.75	1 3/4"	57mm	25pcs/bag
SGP-2.0	2"	63mm	25pcs/bag



Spacers

SoluShim® Water Soluble Alignment Sticks provide and maintain a consistent and precise minimum gap between plates, flanges and pipes. Made of EPA Approved Aquasol® Water Soluble Board. Compatible with any metal.

Item No.	Thickness		Dimensions		Packaging
	English	Metric	English	Metric	
SS-2-38-132	1/32"	0.8mm	3/8" x 2"	9mm x 50.5mm	100pcs/bag
SS-2-38-16	1/16"	1.6mm	3/8" x 2"	9mm x 50.5mm	100pcs/bag
SS-2-38-332	3/32"	2.0mm	3/8" x 2"	9mm x 50.5mm	100pcs/bag
SS-2-38-18	1/8"	3.3mm	3/8" x 2"	9mm x 50.5mm	100pcs/bag
SS-4-38-132	1/32"	0.8mm	3/8" x 4"	9mm x 101mm	50pcs/bag
SS-4-38-16	1/16"	1.6mm	3/8" x 4"	9mm x 101mm	50pcs/bag
SS-4-38-332	3/32"	2.0mm	3/8" x 4"	9mm x 101mm	50pcs/bag
SS-4-38-18	1/8"	3.3mm	3/8" x 4"	9mm x 101mm	50pcs/bag





I-Purge® Modular Inflatable Bladder System is the only CE approved and modular system for pipe purging. The patent-pending I-Purge® comes equipped with:

- Quick Connect Interchangeable Fittings for Rapid Assembly and Replacement
- A Kink Free, High Heat Harness Available In Extended Lengths to Accommodate Pre-heating and High Heat Applications
- Inert Gas Diffuser to Reduce Turbulence of Gas Flow within the Weld Zone.

I-Purge® Isolator is an inflatable pipe stopper and single purge bladder. Accommodates a wide range of applications including pipe system servicing, cleaning, inspection and sealing. Available in sizes 2" - 48" (51-1219 mm) with 10' hose and valve.



Item No	Dimensions		Std Harness Length	
	English	Metric	English	Metric
ABLD 2*	2"	51mm	11"	279mm
ABLD 3*	3"	76mm	11"	279mm
ABLD 4	4"	102mm	11"	279mm
ABLD 5	5"	127mm	11"	279mm
ABLD 6	6"	152mm	11"	279mm
ABLD 8	8"	203mm	11"	279mm
ABLD 10	10"	254mm	12"	305mm
ABLD 12	12"	305mm	12"	305mm
ABLD 14	14"	356mm	16"	406mm
ABLD 16	16"	406mm	16"	406mm
ABLD 18	18"	457mm	16"	406mm
ABLD 20	20"	508mm	18"	457mm
ABLD 22	22"	559mm	18"	457mm
ABLD 24	24"	610mm	18"	457mm
ABLD 26	26"	660mm	20"	509mm
ABLD 28	28"	711mm	20"	509mm
ABLD 30	30"	762mm	20"	509mm
ABLD 32	32"	813mm	20"	509mm
ABLD 34	34"	864mm	20"	509mm
ABLD 36	36"	914mm	20"	509mm
ABLD 38	38"	965mm	24"	610mm
ABLD 40	40"	1016mm	24"	610mm
ABLD 42	42"	1066mm	24"	610mm
ABLD 44	44"	1117mm	30"	762mm
ABLD 46	46"	1168mm	30"	762mm
ABLD 48	48"	1219mm	30"	762mm

I-Purge®X Modular Expandable Bladder System is a revolutionary, versatile design, equipped with the same features of the standard I-Purge® but offers the advantage of expanding to multiple sizes with a single unit. The proprietary Bladder Expansion Technology (BET) assures an airtight seal is maintained for multiple inflation dimensions, resulting in a high quality weld, free of oxidation, every time!



Item No.	Minimum Diameter		Maximum Diameter	
	English	Metric	English	Metric
XABLD 2-3	2"	51mm	3"	76mm
XABLD 4-6	4"	102mm	6"	152mm
XABLD 8-12	8"	203mm	12"	305mm
XABLD 14 - 18	14"	356mm	18"	457mm
XABLD 20-26	20"	509mm	26"	660mm
XABLD 28-36	28"	711mm	36"	914mm
XABLD 38-48	38"	965mm	48"	1219mm

Item No.	English	Metric
ABLD-ELH-24	24"	610mm
ABLD-ELH-36	26"	914mm
ABLD-ELH-48	48"	1219mm
ABLD-ELH-72	72"	1829mm
ABLD-ELH CUSTOM Available Upon Request	ANY SIZE	ANY SIZE
ABLD-CNADP	¼" Female MPT to ¼" Female BSPP Conversion	

WATER SOLUBLE PURGE FILM & ADHESIVE

LiquiFilm® is a water soluble plastic film used as a purge gas barrier during TIG welding. Highly flexible and transparent. Place 8"-12" from the weld joint on each side after applying water soluble adhesive to pipe. Brick format and adhesive sold separately. Kit format includes film wound on core plus two 250 ml bottles.

Item No.	Dimensions		Case Qty
	English	Metric	
AWSF-1/20RG Kit	39' x 66'	1m x 20m	12
AWSF-1/20B Brick	39' x 66'	1m x 20m	12
AWSG-500 Adhesive	16oz	500ml/bottle	24
AWSG-250 Adhesive	8oz	250ml	48



Single Cylinder Trolley

Key Features:

- 20cm solid rubber tyres.
- Suitable for a range of gases
- Available with 2 or 3 wheels
- Dimensions; Height 90cm, Width 28cm, Depth 28cm and Weight 12.5kg.
- 3 wheel dimensions; Height 145cm, Width 28cm, Depth 80cm and Weight 11.5kg



Model	Product Number	Gases
Single Cylinder Trolley -1x	HLKB07	Oxygen Size W Acetylene Size F,G,H
Single Cylinder Trolley -8"	HLKB10	Propane Size E
Single 3 Wheel Cylinder Trolley	HLKB09MG	Oxygen Size W Acetylene Size F,G,H

Twin Cylinder Trolley

Key Features:

- 20cm Solid Rubber Tyres
- Suitable for a range of gases
- Available with 2 or 3 wheels
- Dimensions: Height: 90 , Width: 59 , Depth: 30 and Weight: 10 /14 kg
- 3 wheel Dimensions; Height: 145, Width: 59, Depth: 94 and Weight: 18kg.



Model	Product Number	Gases
Twin Cylinder Trolley 2x Oxygen or Propane	HLKB04	Oxygen Size W Propane Size E
Twin Cylinder Trolley 2x Oxygen or Acetylene	HLKB01	Oxygen Size W Acetylene Size F,G,H
Twin Superior Cylinder Trolley with 3 Wheels	HLKBS03	Oxygen Size N,W,E Acetylene Size N,W,E
Twin Superior Cylinder Trolley 3 Wheels	HLKBS08	Oxygen Size F,L,N,W,E Propane Size F,L,N,W,E
Twin Plus Cylinder Trolley	HLKB02	Oxygen Size W Acetylene Size F,G,H

Cylinder Cages

Key Features:

- Self assembly and powder coated.
- 8.5mm wall and floor bolt holes.
- Approximate dimensions.
- Suitable for a range of cylinder sizes.
- Suitable for various gases.
- Various dimensions available.



GLOBAL PATENT PCT/G2016/052623 COPYRIGHT OWNERSHIP REFLEX
Assembles within 6 seconds and no tools needed for assembly

Model	Product Number	Gases	Size
Acetylene Expanding Cylinder Cage	HLKBCC12	Acetylene	1 or 2 Size H
Various Cylinder Size Expanding Cage	HLKBCC13	Various	1 or 3 Acetylene Size A & J 1 or 8 Acetylene Size M & K 1 or 10 Hydrogen Size B 1 or 3 Carbon Dioxide Size LR/VR 1 or 10 Carbon Dioxide Size VB/LB
Expanding Cylinder Cage	HLKBCC11	Argon, Oxygen, Acetylene, Nitrogen	1 or 6
Propane Expanding Cylinder Cage	HLKBCC08	Propane	1 or 2 47kg
Propane Expanding Cylinder Cage	HLKBCC09	Propane	1 or 2 19kg
Propane Expanding Cylinder Cage	HLKBCC10	Propane	1 or 4 19kg

Visit www.hilouk.co.uk for more information on these products or contact us at sales@hilouk.co.uk 0114 3494749

CP7 Mobile Oxy-Fuel Inspection Course

Personnel associated with the use of compressed gases must understand the properties of the gases and are conversant with the relevant Codes of Practice and Guidance. Notes issued by the British Compressed Gases Association.

Personal safety and the safety of others may depend on knowledge of the gas and the equipment in use, as well as the behaviour of the operator and all those involved in gas usage.

Training leads to greater awareness of the hazards and risks involved with compressed gases resulting in improved safety standards.

Hi-Lo offers a training course on inspecting CP7 Mobile Oxy-Fuel to ensure safety in the workplace.

During the course, you will learn how to check the following:

- Welding / Cutting Station
 - Test Kit
 - Cylinders
- Regulators (Oxygen & Fuel Gas) Pressure & Leak Test
- Flashback Arrestor (Oxygen & Fuel Gas) Pressure & Leak Test
 - Hose (Oxygen & Fuel Gas)
 - Hose Check Valve Pressure & Leak Test
 - All Torch Types
- Pressure & Leak Test Welding / Cutting Torch

Hi-Lo offers a training course on inspecting CP7 Mobile Oxy-Fuel to ensure safety in the workplace.

Procedures

Light Up Procedure	
Check	<ul style="list-style-type: none"> • Local fire procedures are followed • Fire extinguishers are available • Appropriate PPE is in use.
Visual Check	<ul style="list-style-type: none"> • Before use visual checks are completed.
Purge	<p>Purge oxygen & fuel hoses in turn whilst setting working pressure.</p> <ul style="list-style-type: none"> • Purge oxygen & fuel assembly in turn. • Open cylinder valve to a maximum 1.5 turns • Open torch valve • Open regulator & adjust to set for initial working pressure. • Purge each hose & gas assembly checking for gas flow from torch. • Close torch valves. <p><small>Purging should only take place in well ventilated areas, not in confined spaces.</small></p>
Leak Check	<ul style="list-style-type: none"> • All Joints
Ensure torch valves are closed before proceeding	
Purge Torch	<ul style="list-style-type: none"> • Open oxygen torch valve, purge 3-5 seconds, then close the valve. • Open fuel torch valve, purge 3-5 seconds, then close the valve.
Lighting the system	<p>Select the correct spark lighter. Naked flames must not be used.</p> <ul style="list-style-type: none"> • Open fuel gas torch valve • Ignite the fuel gas with the correct spark lighter. • For acetylene increase fuel gas valve to reduce smoke if necessary. • Slowly open the oxygen torch valve until a clear sharply defined flame is achieved.

Shut Down Procedure	
The fuel gas is normally switched off first - consult the Equipment Supplier's handbook as there may be variations	
Extinguish the working Flame at the torch	<ul style="list-style-type: none"> • Fuel gas off • Oxygen off
Close Cylinder Valve	<ul style="list-style-type: none"> • Turn the cylinder valve keys clockwise until closed.
Vent System (No Gas)	<ul style="list-style-type: none"> • Open torch valves in turn. • Vent the gas from each of the hoses • Check gauges are reading zero.
Close Torch Valves	<ul style="list-style-type: none"> • Close all torch valves.
Close Regulator	<ul style="list-style-type: none"> • Close regulator pressure adjustment screw.
Check Three Stops	
Three Stops Employed	<ol style="list-style-type: none"> 1.) Torch Valves Closed 2.) Cylinder Closed 3.) Regulator Closed
Safely Store Equipment	<ul style="list-style-type: none"> • Preferably do not stow hoses around the cylinders • Remove the cylinders from any confined space.

Gas Control Regulators

Performance Data

Two-Stage and Single-Stage Regulators are designed for use with industrial gases and are available with several options of pressure and gauges.

Single Stage Regulators					
	Maximum Inlet Pressure		Maximum Outlet Pressure		Applications
	BAR	PSI	BAR	PSI	
Oxygen	300	4410	5	72	Welding, Light Cutting, Heating
Oxygen	300	4410	10	145	Welding, Heavy Cutting, Heating
Acetylene	20	290	1.5	21.75	Welding, Cutting, Heating
Propane	20	290	2	30	Cutting, Heating

Products Manufactured To Current Standards

Two Stage Regulators					
	Maximum Inlet Pressure		Maximum Outlet Pressure		Applications
	BAR	PSI	BAR	PSI	
Oxygen	300	4410	2	30	Welding
Oxygen	300	4410	5	72	Welding, Light Cutting, Heating
Oxygen	300	4410	10	145	Welding, Heavy Cutting, Heating
Acetylene	20	290	1.5	21.75	Welding, Cutting, Heating

Hand Cutters

Performance Data

There are two basic forms of Hand Cutters, The Hi-Lo NM (Flat and Round handled) in which the fuel gas and oxygen are mixed in the nozzle itself and the Hi-Lo Universal(Flat Handled only) which mixes in the cutter head. Both flat handled types are supplied with either a "press-To-Cut" or "Release-To-Cut" action.

Either cutter may be used with the alternative fuel gas merely by changing the nozzle. The table below lists nozzles which may be used with these cutters.

NM Hand Cutter	
Range of cutting mild steel 1/8" - 12" (3mm - 300mm)	
Nozzles	
Acetylene	Propane
ANM6-S	PNM9-S
ANM6-L	PNM9-L
ANM6-XL	PNM18-S
ANM6-XXL	PNM18-L
ANM-10	PNM-HD
ASNM	
AGNM	Heating
ARCNM	PHNM

Universal Hand Cutter	
Range of cutting mild steel 1/8" - 12" (3mm - 300mm)	
Nozzles	
Acetylene	Propane
2" ACET	2" PROP
3" ACET	3" PROP
2" HD ACET	4" HD PROP
'H' Type ACET	Heating
	PHS

Combined Welding & Cutting Blowpipes

Performance Data

Performance Data

The Hi-Lo 3 combined welding and cutting blowpipe conforms to current standards and is suitable for a variety of applications using appropriate equipment as shown in the table below.

Light Welding Up to 3/8" (10mm)	Standard Mixer used with Type 2/3 welding nozzles sizes 1 -35.
Light Heating Up to 57,000 BTU	Standard Mixer used with brass bent heating neck and AHT 25.
Heating Up to 139,000 BTU	Heavy Duty Mixer used with heavy duty brass bent heating neck and AHT 25, 50 and 100.
Super Heating (with propane) Up to 600,000 BTU	Propane Mixer used with stainless steel necks, 700mm (28") and 270mm (10") bent neck, 300mm (12") brass connector and super heating nozzles 1H, 2H, 3H, 4H and 5H together with castellated versions.
Cutting Up to 1" (25mm)	Cutting Attachment used with LD (AFN-type) nozzle sizes 1/31" - 1/16" and LD (ASFN-type) sheet metal nozzles.

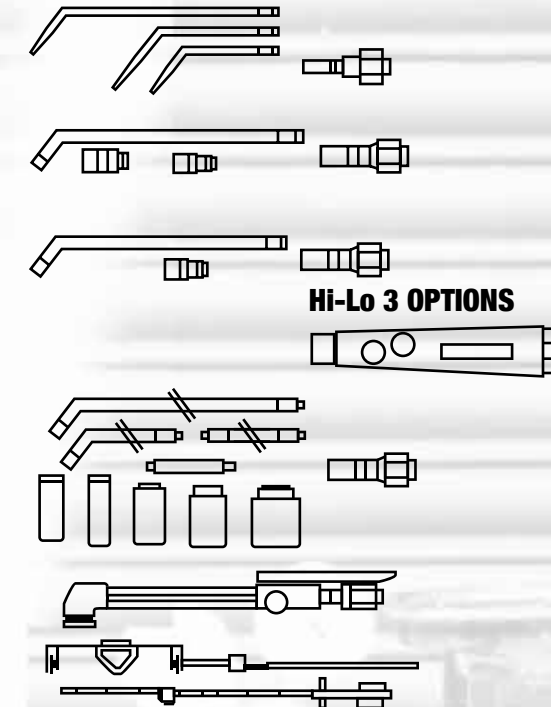

HI-Lo 3 OPTIONS

The Hi-Lo LD combined welding and cutting blowpipe is designed for light-duty application as shown in the table below.

Light Welding Up to 5/16" (8mm)	Standard Mixer used with lightweight welding nozzles sizes 1 - 25 or with a bent neck and DH nozzles sizes 1 - 25.
Heating	Standard Mixer used with heating attachment
Cutting Up to 1" (25mm)	Cutting Attachment used with LD (AFN-type) nozzle sizes 1/32" = 1/16" and LD (ASFN-type) sheet metal nozzles

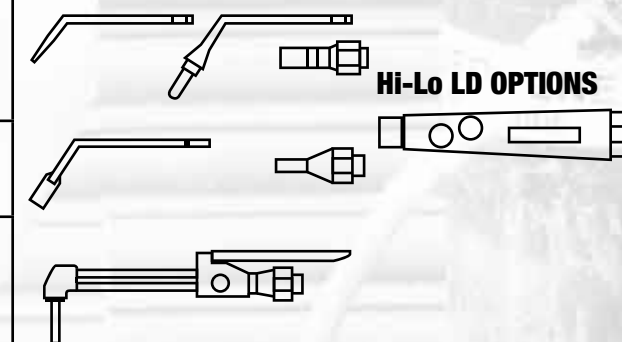

HI-Lo LD OPTIONS



hi-lo®

Hi-Lo UK Ltd

56 Newhall Road Sheffield S9 2QL United Kingdom

Tel: 0114 349 4749

Email: sales@hilouk.co.uk

Web: www.hilouk.co.uk

