



AIR FORCE HANDBOOK 10-222, VOLUME 1

23 January 2012

CIVIL ENGINEER BARE BASE DEVELOPMENT



DEPARTMENT OF THE AIR FORCE

**BY ORDER OF THE
SECRETARY OF THE AIR FORCE**

**AIR FORCE HANDBOOK 10-222
VOLUME 1**

23 January 2012

Operations



CIVIL ENGINEER BARE BASE DEVELOPMENT

ACCESSIBILITY: Publications and forms are available on the e-Publishing website at www.e-publishing.af.mil for downloading or ordering.

RELEASABILITY: There are no releasability restrictions on this publication.

OPR: AFCESA/CEXX
Supersedes AFH 10-222V1,
1 February 2006

Certified by: AF/A7CX
(Colonel Darren P. Gibbs)
Pages: 239

This handbook provides USAF civil engineers with guidance on developing bare bases to beddown personnel and weapons systems in support of Air Force contingency operations. It addresses procedures to build-up, expand and repair airfields, facilities, utilities, and other key infrastructure for beddown locations. This publication applies to all Air Force active duty, Air National Guard (ANG), and Air Force Reserve Command Civil Engineer units. It supports Air Force Instruction (AFI) 10-210, *Prime Base Engineer Emergency Force (BEEF) Program* and AFI 10-211, *Civil Engineer Contingency Response Planning*. Refer recommended changes and questions about this publication to the Office of Primary Responsibility (OPR) using AF Form 847, *Recommendation for Change of Publication*: route AF Form 847s through Major Command (MAJCOM) publications/forms managers. Ensure that all records created as a result of processes prescribed in this publication are maintained in accordance with Air Force Manual (AFMAN) 33-363, *Management of Records*, and disposed of in accordance with Air Force Records Disposition Schedule (RDS) located at <https://www.my.af.mil/afirms/afirms/afirms/rims.cfm>. The use of the name or mark of any specific manufacturer, commercial product, commodity, or service in this publication does not imply endorsement by the Air Force.

SUMMARY OF CHANGES

This document is substantially revised and must be completely reviewed. This revision updates changes to Basic Expeditionary Airfield Resources (BEAR), including the new BEAR Water System, and BEAR Order of Battle (BOB) capabilities-based equipment configurations; and highlights safety guidelines to include arc flash protection and other personal protective equipment (PPE) requirements. It also incorporates the construction of roads, berms, ditches, and expedient field hygiene and sanitation facilities; pest management and waste disposal activities; and support for medical and services facilities.

Chapter 1—BARE BASE DEVELOPMENT	12
1.1. Overview	12
1.2. Roles and Responsibilities	12
Figure 1.1. Air Force Civil Engineer Publications Hierarchy	13
Table 1.1. Prime BEEF Beddown Teams and Capabilities.....	14
Table 1.2. Typical RED HORSE Special Capabilities.....	18
Figure 1.2. RED HORSE Constructing Warehouse Facility in Iraq (2008).....	19
Table 1.3. 49th MMG Teams and Capabilities	19
Figure 1.3. 49th MMG Assembles Large Area Maintenance Shelter	20
Table 1.4. CEMIRT Specialized Capabilities	21
Figure 1.4. CEMIRT Members Perform Depot-Level Repairs	21
1.3. Planning Information and Resources	22
1.4. Employment	22
Figure 1.5. Force Modules	23
Figure 1.6. Building an Army TOC at FOB Kalsu, Iraq (2007).....	24

1.5. Expeditionary Site Planning.....	24
Table 1.5. Bare Base/Beddown Information.....	25
Figure 1.7. Non-BEAR Water Tank Used At Operating Location	28
1.6. Stages of Development	30
Table 1.6. General Bare Base Development Priorities.....	30
Figure 1.8. Airfield Repair at Bagram Airfield, Afghanistan (2007).....	31
Figure 1.9. Positioning an M-22 Automatic Chemical Agent Alarm.....	33
Figure 1.10. Assembling Field Showers at Operating Location.....	34
Figure 1.11. “Dirt Boy” Grading Road at Airfield in Afghanistan (2009).....	35
Figure 1.12. Preparing MEP-12 Generator at Forward Operating Location	35
Figure 1.13. Digging Trench for Water Lines at Ali Base, Iraq (2008)	37
Figure 1.14. EOD Inventories Ordnance in Preparation for Disposal.....	38
Figure 1.15. Raising Aircraft Sun Shade On Balad Air Base, Iraq (2008)	40
Chapter 2—SAFETY	41
2.1. General Safety Guidelines	41
2.2. Job Hazards.....	42
2.3. Basic Safety Rules	42
Figure 2.1. Typical Arc Flash Warning Label.....	42
Chapter 3—SITE LAYOUT	43
3.1. Layout Plan	43
Figure 3.1. Site Planning and Layout Is Vital	43

Figure 3.2. Conventional Site Layout	44
Table 3.1. Airfield Layout Facility/Group Dispersed Distances	45
Figure 3.3. Notional Airfield w/Dispersed Aircraft Parking Layout	46
3.2. Facility Placement and Spacing	46
Figure 3.4. Notional 1,100-Person Facility Layout (Before Expansion)...	47
Figure 3.5. Notional 3,300-Person Facility Layout (After Expansion)	48
Chapter 4—BARE BASE AIRFIELDS	51
4.1. General Information	51
4.2. Airfield Hazard Clearance	51
Table 4.1. Tasks Supporting EOD	52
Table 4.2. Minimum Evacuation Distances during UXO Clearing	53
Figure 4.1. Suppressive Barricades Isolate Explosions	54
Figure 4.2. Protective Barricades Shields Resources	55
Figure 4.3. Removing Destroyed Iraqi Tank near Taxiway, Iraq (2008)	57
4.3. Airfield Repairs and Restoration	57
Table 4.3. MOS Layout Tasks	58
Figure 4.4. C-17 Lands on Semi-Prepared LZ	59
Figure 4.5. Repairing Spall Damage at Deployed Location	61
Figure 4.6. Crater with Upheaval	61
Figure 4.7. EALS Supports Contingency Airfield Lighting Requirements	62
Figure 4.8. Examples of Portable Area Lighting	63

Figure 4.9. F-22 Engaging MAAS	64
Figure 4.10. Firefighters Responding to Vehicle Fire, Iraq (2008)	66
Figure 4.11. Typical Road Cross Section	67
4.4. Revetment and Soil Berm Construction	67
Table 4.4. Construction Man-Hour Comparisons	68
Figure 4.12. Expedient Revetments at Deployed Locations	69
4.5. Raised Dikes	69
Figure 4.13. Fuel Dikes Control Spills and Forms Protective Barrier	70
Figure 4.14. Fuel Dikes Around Jet Fuel Storage Bladders	71
Figure 4.15. Typical Berm Layout for a 10K Fuel Bladder	72
Figure 4.16. Typical Berm Layout for 50K and 210K Fuel Bladders	73
Figure 4.17. Illustration of Fuel Dike with Secondary Dike	73
4.6. Ditches	74
Figure 4.18. Creating Drainage Ditch to Reduce Road Erosion	74
Chapter 5—BARE BASE FACILITIES	75
5.1 Contingency Construction Standards in Theater	75
Figure 5.1. Contingency Construction Standards	76
5.2. Facility Assets and Preparation Actions	77
Figure 5.2. Arrange Storage of BEAR Shipping Containers	78
5.3. BEAR Shelters	78
Table 5.1. Typical Bare Base Facility Allocations	80
5.4. Services Facilities	80
Figure 5.3. BEAR 550 Kitchen (550-Personnel)	81

Table 5.2. Lodging Facility Breakout Groups (Typical).....	82
Figure 5.4. Self-Help Laundry (SHL).....	83
Figure 5.5. Field Mortuary Operation Set Up In Small Shelter System....	84
5.5. Non-BEAR Facilities	84
Figure 5.6. Expeditionary Medical Support Facility	85
Figure 5.7. Engineers Relocate Aircraft Sunshades	86
Figure 5.8. Force Provider Assets Similar to BEAR.....	87
Table 5.3. Force Provider/BEAR Assets Comparison	87
Figure 5.9. Building Army Shower Facilities at FOB	88
5.6. Cryogenics Facilities.....	88
Figure 5.10. Liquid Oxygen Storage and Servicing Facility	89
Table 5.4. LOX Facility Minimum Separation Distances.....	90
Chapter 6—EXPEDIENT HYGIENE AND SANITATION	
FACILITIES	91
6.1. Expedient Field Facilities.....	91
Figure 6.1. Field Expedient Latrine Often First Sanitation Facility	91
6.2. Expedient Latrines	92
Figure 6.2. Commercial Latrines Used Alongside Field Latrines	92
Figure 6.3. Straddle Trench Latrine without Partitions.....	93
Figure 6.4. Straddle Trench Latrine with Partitions	94
Figure 6.5. Bored Hole Latrine	94
Figure 6.6. Deep Pit Latrine	95
Figure 6.7. Mound Latrine	96

Figure 6.8. Cat Hole Latrine	96
Figure 6.9. Cross Tree Latrine	97
Figure 6.10. Basic Burn-Out Latrine.....	98
Figure 6.11. Pail Latrine.....	99
Figure 6.12. Portable Pit Latrine	100
Figure 6.13. Portable Burn-Out Latrine	100
6.3. Expedient Urine Disposal Facilities.....	101
Figure 6.14. Single Pipe Urinal with Privacy Screen.....	101
Figure 6.15. Multiple Pipe Urinal Illustration with Soakage Pit.....	102
Figure 6.16. Basic Trough Urinal.....	102
Figure 6.17. Variation of Basic Trough Urinal	103
6.4. Expedient Hand-Washing Station	103
Figure 6.18. Simple and Effective Hand-Washing Device	103
Figure 6.19. Basic Arrangement of Expedient Hand Wash Station	104
Figure 6.20. Other Types of Expedient Hand Wash Stations.....	104
6.5. Expedient Shower and Shave Facilities	104
Figure 6.21. Expedient Field Shower Facility.....	105
Figure 6.22. Expedient Shave Station	106
Chapter 7—PEST MANAGEMENT	107
7.1. General Information.....	107
Figure 7.1. Judicious Application of Pesticides Help Control Insects	107
7.2. Guidance and Resources	107
Figure 7.2. Disease Vector Ecology Profiles (DVEPs)	108

7.3. Safety	109
Table 7.1. General Pest Management Safety Checklist	109
7.4. Sanitation	109
7.5. Contingency Pesticides	110
Figure 7.3. Using Traps to Control Rodent Population.....	110
7.6. Using Pesticides in Foreign Countries	110
7.7. Emergency Procurement of Pesticides and Pest Management Equipment.....	111
Table 7.2. DLA Contact Information.....	111
7.8. DOD Pesticide Hotline.....	112
7.9. Contingency Pesticide Storage.....	112
Figure 7.4. Isolated Pesticide Storage Facility at Deployed Location.....	112
7.10. Transporting Pesticides	113
7.11. DOD Repellents	113
7.12. Controlling Vegetation with Herbicides	113
Chapter 8—WATER AND WASTEWATER SYSTEMS.....	114
8.1. General Information.....	114
Figure 8.1. Typical Contingency Water System Components	114
Table 8.1. Water Use Planning Factors.....	115
Table 8.2. Wastewater Sources and Estimates.....	116
Figure 8.2. Raw Water Pumps Retrieve Source Water	117
Figure 8.3. Tanker Trucks Used To Transport Raw Water.....	117
8.2. Initial Water Production.....	118

Figure 8.4. ROWPU and Water Bladders Included in Initial Water Production Package.....	118
8.3. Water Operations Area (WOA) Site	118
Table 8.3. WOA Layout Dimensions and Water Production Data	119
Figure 8.5. Location of WOA (Typical).....	119
8.4. BEAR Water System	120
Table 8.4. BEAR Water Subsystems	120
Figure 8.6. Typical Water Production Subsystem Layout	121
Figure 8.7. Total Wastewater Collection Layout (1100-Person Camp)	123
Figure 8.8. Partial Wastewater Collection Layout (1100-Person Camp)	124
8.5. Wastewater Disposal.....	125
8.6. Expedient Wastewater Disposal Methods.....	125
Figure 8.9. Typical Evaporation Bed Construction.....	126
Figure 8.10. Evaporation Field.....	126
Figure 8.11. Soakage Trench with Barrel-Filter Grease Trap	127
Figure 8.12. Barrel-Filter Grease Trap Design.....	127
Figure 8.13. Imbedded Grease Trap.....	128
Figure 8.14. Sewage Lagoon.....	128
Figure 8.15. Leach Field and Septic Tank Configuration	129
Chapter 9—ELECTRICAL POWER GENERATION AND DISTRIBUTION.....	130
9.1. General Information.....	130

9.2. Mobile Electric Power (MEP) Generators	130
9.3. Prime Power Plants	131
Figure 9.1. MEP-12 Power Plant	131
9.4. Electrical Power Distribution.....	132
Figure 9.2. Secondary Distribution Center (SDC)	132
Figure 9.3. Primary Switching Center (PSC).....	133
Figure 9.4. Primary Distribution Center (PDC)	133
Figure 9.5. Power Distribution Panel (PDP)	134
Figure 9.6. Typical SDC/Facility Configuration with FDECUs	135
Figure 9.7. Remote Area Lighting Systems Connect to SDCs.....	135
Figure 9.8. Burying Electrical Distribution Cable.....	136
Chapter 10—SOLID WASTE DISPOSAL	137
10.1. General Information.....	137
10.2. Basic Guidelines	137
Table 10.1. Waste Diversion and Disposal Hierarchy	137
10.3. Waste Reduction and Disposal Methods.....	138
Figure 10.1. Escorts Monitor Host-Nation Contractors on Base.....	139
Figure 10.2. Solid Waste Landfills.....	140
Figure 10.3. Incinerator Facility at Forward Operating Location	141
10.4. Hazardous Waste	142
Chapter 11—BASE DEFENSE.....	143
11.1. General Information.....	143
Figure 11.1. CE and SF Coordinate Building of Guard Tower	143

Figure 11.2. Erecting Non-Hardened BEAR Shelter	145
11.2. Physical Security Measures	145
Figure 11.3. Improvised Bunker Using Concrete Culverts and Sandbags	147
Figure 11.4. Metal Culvert Shelter.....	148
Figure 11.5. Constructing Security Barrier around Flightline.....	149
11.3. CBRN Defense.....	150
Attachment 1—GLOSSARY OF REFERENCES AND SUPPORTING INFORMATION	151
Attachment 2—ENGINEER REACH-BACK AND OTHER USEFUL LINKS	167
Attachment 3—BARE BASE DEVELOPMENT TASK TIMELINE..	169
Attachment 4—PERSONAL PROTECTIVE EQUIPMENT (PPE) FOR CIVIL ENGINEER OPERATIONS.....	180
Attachment 5—CIVIL ENGINEER SAFETY CHECKLISTS	186
Attachment 6—PROS AND CONS OF EXPEDIENT LATRINES	203
Attachment 7—PROS AND CONS OF EXPEDIENT WASTEWATER DISPOSAL FACILITIES	210
Attachment 8—ELECTRICAL CURRENT CHARACTERISTICS IN SOUTHWEST ASIA	214
Attachment 9—CONVERSION TABLES.....	215
Attachment 10—BEDDOWN/BARE BASE DEVELOPMENT CHECKLISTS	223



Chapter 1

BARE BASE DEVELOPMENT

1.1. Overview. Development of a bare base, while comprised of many tasks is performed with one goal in mind—quickly setting up infrastructure to support aircraft operations and other contingency missions. Engineer efforts and work force must be focused and concentrated on the establishment of facilities, structures and services that help bring about an initial operational capability (IOC). Civil engineer (CE) bare base development actions relies heavily on the use of Basic Expeditionary Airfield Resources (BEAR) mobile assets, as well as the type of information and procedures addressed here. This handbook contains tactics, techniques, and procedures (TTPs) for use by civil engineers in supporting precepts outlined in Air Force Doctrine Document (AFDD) 4-0, *Combat Support*, and AFDD 3-34, *Engineer Operations*, and it aids in the implementation of Air Force Policy Directive (AFPD) 10-2, *Readiness*. This relationship is illustrated in the Air Force CE hierarchy of publications (**Figure 1.1**). Prime Base Engineer Emergency Force (Prime BEEF) team leaders, supervisors, and other members may find this handbook useful when organizing beddown operations, including management of beddown teams, and the erection, construction, and repair of airfield pavements, facilities, utilities, and other vital infrastructure.

1.2. Roles and Responsibilities. Air Force civil engineers play a key role in the development of bare bases and the beddown of Air Force units and weapons systems. Moreover, they are often tasked to help develop operating locations to beddown personnel and weapons systems for joint, combined, and multinational operations. Regardless of the military service supported or location, efficient planning and use of available resources to erect, construct, install, and repair expedient facilities and critical infrastructure is essential to meet initial mission requirements. Bare base development typically involves both Prime BEEF and RED HORSE forces, and while RED HORSE will be mentioned at times throughout this handbook, our primary focus is on Prime BEEF support for bare base development.

Figure 1.1. Air Force Civil Engineer Publications Hierarchy.



Operational Doctrine

AFDD 4-0, Combat Support
AFDD 3-34, Engineer Operations



Policy Directives

AFPD 10-2, Readiness
AFPD 10-25, Emergency Management
AFPD 32-10, Installations & Support
AFPD 32-20, Fire Emergency Services
AFPD 32-30, Explosive Ordnance Disposal
AFPD 32-60, Housing
AFPD 32-70, Environmental Quality
AFPD 32-90, Real Property Asset Management



Tactical Guidance

Air Force Instructions
Air Force Manual
Air Force Pamphlets
Air Force Tactics, Techniques, and Procedures
Air Force Handbooks

1.2.1. **Prime BEEF Teams.** Personnel and equipment needs vary at each beddown or operating location. **Table 1.1.** lists common Prime BEEF beddown responsibilities by team and capability. Each team has personnel and equipment unit type codes (UTC) to support its capability. To determine actual or specific team composition and skills, or to view other CE personnel and equipment UTCs, refer to the [Expeditionary Engineering](#) Community of Practice (CoP) website. Multiskilling plays an important role in engineer operations and though personnel are generally organized around specialties and abilities, many tasks will require more than one skill for accomplishment and many more are not solely Air Force Specialty (AFS) unique. Requirements such as camouflage and concealment, dispersal site construction, hardening, revetment erection, facility erection, etc., will require more workers than is provided by any one AFS. The main points to remember are to remain flexible and keep a mission perspective.

Table 1.1. Prime BEEF Beddown Teams and Capabilities.

Team	Capability
Basic Engineer Beddown/ Sustainment Team	Provides initial engineer beddown force with light vertical/horizontal construction capability. Requires augmentation UTCs for airfield damage repair (ADR) activities and full engineer capability depending on mission beddown size.
Engineer Command and Control Team	Provides initial beddown planning and command and control (C2) to engineer forces. Requires additional augmentation for ADR activities. Includes Squadron Commander, Engineer Officer, First Sergeant, Chief Enlisted Manager, Engineering Craftsman, and Operations Craftsman.
Engineer Logistics Support Team	Provides engineer logistics support for materiel acquisition, inventory and issue. Provides AF and Joint engineer Base Operating Support (BOS) where intrinsic AF BOS is not available.

Table 1.1. (Continued)

Water and Fuels Systems Maintenance Team	Provides specialized capabilities for establishing and maintaining fixed fuel systems. Augments Beddown/Sustainment Team when permanent fuel systems are located at austere sites.
Pest Management Team	Provides pest management support where required to control hazardous insect, rodent, and animal species.
Water and Wastewater Systems Team	Provides capability to operate water purification, production, and distribution. Team can operate one Reverse Osmosis Water Purification Unit (ROWPU) capable of producing 6,000 gallons of water per day. Installs, operates, and maintains waste water systems to include wastewater removal using pumper trucks. Provides construction oversight/operation of sewage lagoons. Provides additional maintenance/operation support of fixed and mobile water and waste production and distribution systems and equipment.
Heat, Air Conditioning, Refrigeration and Control Team	Provides additional maintenance and operation support of fixed and mobile heating and air conditioning systems, and heating, ventilation and air conditioning (HVAC) controls.
Power Generation/Aircraft Arresting System (AAS) Team	Provides additional capability for large power plant operations. Can be used in conjunction with Beddown/Sustainment Team to provide additional support for maintenance/operation for power generation/distribution systems and mobile/fixed AASs, and ADR activities. Can be used as a stand-alone team for establishing and operating power production or mobile aircraft arresting systems (MAAS).

Table 1.1. (Continued)

<p>Electrical Distribution Team</p>	<p>Provides additional primary and secondary electrical systems maintenance and sustainment support. Constructs primary electrical distribution using BEAR equipment sets. Maintains and operates fixed and mobile electrical systems and equipment.</p>
<p>Engineer Operations Management Team</p>	<p>Provides additional operations management support. Assists in the control and direction of base recovery and ADR activities. Operates the CE communications network. Provides a control point for damage reporting and dispatches workers, equipment, and material to work sites. Oversees and manages non-technical contracts to include service contracts.</p>
<p>Pavement/ Construction Team</p>	<p>Provides additional airfield/road maintenance and construction support. Operates heavy construction equipment and special purpose vehicles.</p>
<p>Carpentry/Sheet Metal Team</p>	<p>Provides additional maintenance and operation support for fixed and expeditionary facilities, and existing infrastructure. Supports BEAR facility erection, repairs to existing host nation or other permanent facilities, small vertical projects, and ADR activities.</p>
<p>Survey/Design Construction Management Team</p>	<p>Provides additional computer-aided drafting and design, surveying, design, and construction management support. Maintains base vector data (base map). Develops site beddown plans to include facility and aircraft parking plans.</p>

Table 1.1. (Continued)

Explosive Ordnance Disposal (EOD) Teams	Provide EOD management and support to major combat, contingency, and homeland defense operations. Provides capability to protect personnel and resources from the effects of explosive hazards, munitions, accidents and unexploded ordnance (UXO)s to include improvised explosive devices (IED)s. Provides limited capability to assess access, disrupt, neutralize, or render safe chemical, biological, radiological, nuclear and high-yield explosives (CBRNE) and irregular warfare threats.
Fire Emergency Services (FES) Teams	Provide fire prevention and protection, fire fighting, rescue, and Hazardous Materials (HazMat) response capabilities to prevent or minimize injury, loss of life, and damage to property and the environment
CBRN/ Emergency Management) Teams	Provide CBRN/EM management and installation support, including activities spanning the full range of military operations and response to major accidents and natural disaster operations.

1.2.2. **Specialized Skills.** Although **Table 1.1.** does not list every possible CE beddown team, the skills and knowledge possessed by members of these teams substantiates the tremendous bare base development capability that Prime BEEF teams bring to the fight. For some beddown requirements, however, specialized skills and equipment may be necessary; in those cases RED HORSE forces and specialized teams from the 49th Material Maintenance Group (MMG) and Air Force Civil Engineer Support Agency (AFCESA) Civil Engineer Maintenance, Inspection, and Repair Team (CEMIRT), can be deployed to locations requiring their expertise.

1.2.2.1. **RED HORSE.** Provides a capability for heavy civil engineering repair and construction beyond the ability of Prime BEEF forces. They can perform major vertical and horizontal construction and have specialized bare base taskings. These squadrons are self-sufficient and can deploy to remote sites with little or no outside support except for construction materials, rations, petroleum, oils, and lubricants (POL), and other expendable type supplies. Each squadron has its own housing, medical, food service, maintenance, and limited security (small arms) capabilities. Their specialized capabilities include those listed in **Table 1.2.**

Table 1.2. Typical RED HORSE Special Capabilities.

Team	Capability
Self-Sufficient Squadron with Multiple Teams and Elements	Emergency Airfield Lighting Installation
	Erection of K-Span or Similar Storage facilities (Figure 1.2.)
	Construction of aircraft parking pavements, pads and ramps
	Erection of major earthwork revetments and bunkers
	Installation of expeditionary aircraft arresting systems
	Construction of paved roads and access ways
	Expansion and development of water sources
	Erection of modular and pre-engineered facilities
	Asphalt batch plant operations
	Bare base setup
	Concrete batch plant operations
Quarry Operations	

Figure 1.2. RED HORSE Constructing Warehouse Facility in Iraq (2008).

1.2.2.2. **49th MMG.** Responsible for storage, inspection, repair, deployment and accountability (excluding in-theater accountability) of BEAR assets belonging to Air Combat Command and is tasked to respond worldwide for deployment, setup, operations, maintenance, teardown and reconstitution of all BEAR equipment in support of combat-related and other contingencies, and natural disasters. The 49th MMG provides three types of enabling teams to assist in erection and teardown of BEAR assets. The capabilities of these specialized teams are listed in **Table 1.3.**

Table 1.3. 49th MMG Teams and Capabilities.

Team	Capability
<p>Technical</p> <p>Supervision Team</p>	<p>Provides technical oversight and training teams to assist Prime BEEF or RED HORSE (or joint equivalent) personnel to erect/repackage/redeploy BEAR.</p> <p>Provides initial accountability, control, and supply support of BEAR equipment sets. Provides support for operational beddown requirements throughout the theater of operation (TO).</p>

Table 1.3. (Continued)

<p>Large Structures Team</p>	<p>Provides a team composed of Aircraft Maintenance and CE structures AFSs. Provides technical oversight and training to assist the lead Prime BEEF or RED HORSE (or joint equivalent) in erecting or disassembly/reconstitution of BEAR large structures (Figure 1.3.).</p> <p>Provides capability to erect BEAR Aircraft Hangars (ACH), Large Area Maintenance Shelters (LAMS) and Dome Shelters. Provides capability to repair/sustain BEAR assets.</p>
<p>Housekeeping Support</p>	<p>Provides one supply specialist (AFS 2S0X1). Provides supervision and assistance with accountability of all BEAR equipment and mobility EM spares package assets. Performs supply “reachback” actions to sustain the BEAR equipment.</p>

Figure 1.3. 49th MMG Assembles Large Area Maintenance Shelter.

1.2.2.3. **CEMIRT**. Provides specialized teams that can rapidly deploy within 24 hours to a TO for contingency support of equipment failures beyond the repair capabilities of the in-place engineer forces. These specialized capabilities are listed in **Table 1.4**.

Table 1.4. CEMIRT Specialized Capabilities.

Team	Capability
Four 7-Person Teams (Provide intermediate and expeditionary depot-level)	Maintenance and repair of diesel-driven power generators.
	Maintenance and repair of electrical distribution and control systems.
	Maintenance and repair of fixed or mobile aircraft arresting systems.
	Emergency troubleshoot, maintenance, and repair of bare based and real property-installed electrical power generation and distribution equipment (Figure 1.4).

Figure 1.4. CEMIRT Members Perform Depot-Level Repairs.



1.3. Planning Information and Resources. Initial beddown planning and execution at bare bases and forward operating locations require engineers have a basic knowledge of bare base assets and their use. Air Force Pamphlet (AFPAM) 10-219, Volume 5, *Bare Base Conceptual Planning Guide*, has additional information on bare base planning and resources. Users should also refer to AFPAM 10-219, Volume 1, *Contingency and Disaster Planning*, and the Air Force Handbook (AFH) 10-222 Series for more information on bare base development and beddown actions. In addition, contact the AFCESA Reach-Back Center when seeking information not found in this publication or the references in **Attachment 1**. Contact the Reach-Back Center at 888-232-3721 (comm), DSN 523-6995, or email at afcesareachbackcenter@tyndall.af.mil. Other reach-back resources are listed in **Attachment 2**.

IMPORTANT NOTE

The information in this handbook is for guidance ONLY. It is not intended to replace policy documents, technical orders and manuals, or any applicable mandatory procedures or instructions. Specialists should review applicable technical, safety, and policy references before performing specific tasks.

1.4. Employment. A significant amount of forethought and advance planning occurs before bare bases are developed in any TO. In simple terms, Air Force planners, responding to guidance from our military decision-makers, prepare solutions to meet or satisfy specific taskings or missions. These missions are based on Air Force distinctive capabilities or what we “bring to the fight.” According to AFDD 4-0, one of several distinctive capabilities the Air Force brings is Agile Combat Support or ACS; and one of ACS’s master capabilities is to “Establish Operating Locations (EOL).” This EOL capability is the cornerstone for the Air Force civil engineer’s bare base development mission and although other functions share this mission, CE has a significant role when tasked to plan, develop and sustain airfields or operating locations (OL) in support of Air Force, joint, combined, or multinational operations.

1.4.1. The Air Force organizes and deploys under the Air & Space Expeditionary Task Force (AETF) Force Modules. Moreover, much of the planning for bare base development usually revolves around the force module concept addressed in Air Force Instruction (AFI) 10-401, *Air Force Operations Planning and Execution*. The force module concept is the method used by the AETF to standardize force packaging, and it integrates light and lean operational and support capabilities that are scalable and flexible. It is made up of six modules that are not executed sequentially, but rather overlap each other over time to build the capability to support operations. As shown in **Figure 1.5**, the modules are *open the airbase*, *command and control*, *establish the airbase*, *generate the mission*, *operate the airbase*, and *robust the airbase*.

Figure 1.5. Force Modules.



1.4.2. Civil engineers, including airborne RED HORSE and those assigned to contingency response groups (CRG), airfield assessment teams, and other small units responsible for specific initial assessment and repair tasks will likely deploy with the *Open the Airbase* force module. Then, after completing their tasks, redeploy home to reconstitute or forward deploy to open a different site. Prime BEEF units tasked to beddown and sustain forces at a given site typically deploy a six-person C2 team with the *Command and Control* force module, with the remainder of the tasked Prime BEEF forces deploying with the *Establish the Airbase* and later modules. In general, Prime BEEF forces use their bare base development capabilities along with expedient facilities and utilities to beddown deploying forces. They erect engineer and services shops, billets, latrine, laundry, dining, and other critical facilities. They also assist in the construction or erection of personnel, vehicle, and aircraft revetments, and modify or restore

runways, taxiways, or aircraft parking areas. There may also be a minimum cadre of engineers available to assist personnel of other base functions erect their base facilities. Refer to [Attachment 3](#) for a timeline of CE bare base development and beddown tasks.

1.4.3. In addition to bare base development, civil engineers may also be tasked to support beddown operations for other Services, such as building Army tactical operations centers (TOC) and other structures at forward operating bases (FOB) as shown in **Figure 1.6.**, and may even provide support to joint, combined, and multinational forces.

Figure 1.6. Building an Army TOC at FOB Kalsu, Iraq (2007).



1.5. Expeditionary Site Planning (ESP). ESPs are usually developed long before Prime BEEF teams are deployed to establish bare bases or other operating locations. AFI 10-404, *Base Support and Expeditionary Site Planning*, states “ESPs are chiefly associated with locations without a permanent Air Force presence and may contain only the minimum data necessary to make initial beddown decisions. ESPs may be developed in short periods to meet contingency needs without full staffing or coordination. It is the installation level or site plan to support unified and specified command wartime operations plans, as well as major command (MAJCOM) supporting plans. It cuts across all functional support areas in a consolidated view of installation

missions, requirements, capabilities, and limitations to plan for actions and resources supporting war or contingency operations, including deployment, post-deployment, and employment activities (as appropriate).” This definition suggests even when an ESP is accomplished, it may lack sufficient details to satisfy the needs of every tasked function, and significant planning may still be required to develop a bare base efficiently to support the incoming mission. In any case, Prime BEEF team leaders should have as much information as possible about factors affecting the beddown location before deploying—use every available resource at your disposal to help ensure mission success.

1.5.1. Site Planning Resources. In addition to the ESP, **Table 1.5.** lists other resources that may provide valuable information about beddown locations and bare base development data.

Table 1.5. Bare Base/Beddown Planning Information.

Resource	Purpose
<p style="text-align: center;">Base Support & Expeditionary (BaS&E) Planning Tool</p>	<p>BaS&E Planning Tool is a versatile, web-enabled application delivering the capability to collect and centrally store military value data to support beddown planning. This expedient identification of resources and critical combat support enables rapid assessment for potential beddown locations around the world. Contains access to imaging and command surveys and reports, including previous airfield, pavements, threat, and initial beddown assessments.</p> <p>BaS&E replaces the Logistician’s Contingency Assessment Tools (LOGCAT) system. To gain access to this application, contact your host/installation Logistics Plans office or MAJCOM In-Garrison Expeditionary Site Plan (IGESP) point of contact (POC).</p>

Table 1.5. (Continued)

<p>GeoReach and Expeditionary Basing</p>	<p>Provides a Common Installation Picture (CIP) using information acquired from intelligence sources and assists with various planning aspects such as aircraft parking, munitions storage, and other beddown force requirements.</p>
<p>Geospatial Expeditionary Planning Tool (GeoExPT)</p>	<p>GeoExPT is an advanced expeditionary base-planning tool that combines camp and aircraft parking planning capabilities.</p>
<p>Army Facilities Components System (AFCS) / Theater Construction Management System (TCMS)</p>	<p>Provides contingency construction information to military engineers. AFCS/TCMS is a US Army PC-based automated construction planning, design, management, and reporting system primarily used to support outside the continental United States (OCONUS) requirements.</p>
<p>CENTCOM Regulation 415-1, “The Sand Book”</p>	<p>Addresses construction and base camp development in the USCENTCOM Area of Responsibility (AOR). The “Sand Book” establishes consistent standards for the Service components program and use regarding infrastructure development, security, sustainment, survivability, safety, and affordable working and living environments for personnel in the USCENTCOM AOR.</p>

Table 1.5. (Continued)

Installation Geospatial Information and Services (IGI&S), Installation Viewers and AOR Maps	Provides site imagery and other information useful for expeditionary site planning in the AOR, including: CENTCOM, SOUTHCOM, EUCOM, PACOM, AFRICOM and NORTHCOM AORs.
---	--

1.5.2. **Materiel Resources.** In addition to deploying skilled personnel to a bare base or operating location, appropriate types and numbers of systems and materiel must also be available to develop or set up the base or location quickly to support the operational mission. This is where BEAR mobile assets and other bare base development materiel play a huge role.

1.5.2.1. **BEAR Assets.** BEAR is a critical ACS capability. It provides vital equipment and supplies necessary to beddown and support combat forces at expeditionary sites with limited infrastructure and support facilities. BEAR assets are flexible, modular and scaleable to meet an array of beddown missions. It consists of a variety of systems and equipment, such as personnel shelters, aircraft shelters, food service facilities and equipment, hygiene facilities, power and water production and distribution equipment, heating, air conditioning, and refrigeration equipment, vehicles, runway lighting, vehicle maintenance equipment, and civil engineering equipment and associated spares configured into Mobility Readiness Spares Packages (MRSPs). When combined, these systems and equipment make-up the infrastructure needed to establish an air base in a deployed environment. Traditionally, BEAR assets was configured into six materiel sets (Swift BEAR, 550 Initial/Follow-on, Industrial Operations, and Initial/Follow-on Flightline) with a variety of Playbook Options that allow sets to be tailored for a specific mission. However, with the advent of BEAR Order of Battle (BOB), BEAR assets are being transformed into capability-based configurations. These new configurations will allow Air Force and Combatant Commanders (CCDRs) to employ only those capabilities required to meet the mission, thereby reducing the overall logistics footprint of the previous larger BEAR set.

1.5.2.2. Other Assets. The importance of BEAR assets (including legacy equipment sets) to bare base development is readily apparent. However, non-BEAR assets also play an essential role. Items like non-BEAR support equipment and vehicles, expeditionary medical, communications, and services facilities, fuels mobility support equipment, Air Force Contract Augmentation Program (AFCAP) and locally contracted resources, and the Army's Force Provider assets are just a few examples. Any of these resources can be part of the asset mix needed to successfully develop a bare base for deploying forces. Although our engineer workforce has a long tradition of innovative and flexible use of available resources to satisfy command and mission requirements, we continue to apply lessons learned and use the ever-changing tools that improve our processes and product. For Prime BEEF forces, this includes employment of non-BEAR assets we may encounter at expeditionary OLs (**Figure 1.7.**).

Figure 1.7. Non-BEAR Water Tank Used At Operating Location.



1.5.3. Movement of Bare Base Assets. The proper flow of bare base assets into a contingency location is critical to establishing the airbase and generating the mission. Obtaining non-essential assets early in the logistics flow merely congests off-load areas, increases the potential for loss or damage to items, and does little to provide immediate mission capability. The BOB transformation

and capabilities-based configuration of BEAR assets should remedy many of these problems. However, as users and installers of much of the bare base equipment, and in some cases planners for bare base contingency operations, civil engineers have a vested interest in, and responsibility for, influencing the flow of bare base equipment. Selection and time-phasing of BEAR and other assets for a given site is usually determined by the theater logistics staff, with input from the civil engineer staff. Engineers can influence the process by working with their unit-level logistics plans office and the theater civil engineer staff. While the planned flow of equipment can be influenced, the real-time availability of transportation assets is a significant factor. Understanding the pressures applied to limited airlift resources available to support all the Services' deployment requirements, BEAR is designed with transportation flexibility in mind. Therefore, it is being packaged in a multi-modal configuration for both air and surface transportation. Anticipate nearly one-third of all BEAR assets to be configured for air shipment.

1.5.4. BEAR UTCs. BEAR capabilities, in the form of UTCs, are critical to employment planning for locations ranging from austere to main OLs depending on specific missions, locations, and population requirements. Built with the end-user in mind, BEAR is synchronized to other combat support UTCs to arrive as needed to enhance the incremental buildup of an OL. As a critical enabler of the force module construct, BEAR plays a key role in open, establish and operate the airbase force modules.

1.5.4.1. The only BEAR UTC found in the *Open the Base* force module is Swift BEAR (SB). Two of each SB UTCs are operationally linked to eight CRGs positioned around the world. Each SB UTC includes basic hygiene, billeting, power, lighting, water and Meals Ready-to-Eat (MREs) for an initial cadre of 150 personnel. This package normally remains in-place even if the base is turned over to follow-on forces in the Establish/Operate the Airbase force modules. Unlike the other BEAR UTCs, SB is configured exclusively for airlift due to requirements to deploy with little or no notice.

1.5.4.2. BEAR UTCs in *Establish the Airbase* force module are synchronized with other combat support capabilities to provide shelters, billeting, messing,

lighting, and power capabilities that arrive on or about C-day, and are designed to provide an IOC within the first few days of arrival.

1.5.4.3. The BEAR UTCs in the *Operate the Base* force module includes engineering, structural and fuels facilities necessary to complete the deployed location layout and support quality of life activities, such as Chaplain and the Tactical Field Exchange.

1.5.4.4. BEAR *Generate the Mission* UTCs support both Combat Air Forces (CAF) and Mobility Air Forces (MAF), and contain maintenance shelters, lighting, and aircraft supporting structures. Generate the Mission UTCs are tasked in response to increasing numbers of aircraft to be supported. Currently, the MAF-specific UTCs are structured to support 12 MAF aircraft at a location, while the CAF UTCs are configured to support from 12–72 aircraft, or up to the equivalent of three Fighter Squadrons.

1.6. Stages of Bare Base Development. There are normally four stages of bare base development: *initial, intermediate, follow-on and sustainment* stages. Beddown tasks within these stages are generally prioritized as shown in **Table 1.6**. During the initial and intermediate stages, most tasks will fall in the upper two priorities. In the follow-on stage, tasks will shift more toward the lower priorities on the list. In any case, some of the task efforts in the various stages will overlap because of their scope or manpower requirements.

Table 1.6. General Bare Base Development Priorities.

Priority	Task
1	Operational requirements
2	Utility systems and services
3	Transportation network
4	Essential support facilities
5	Other support facilities

1.6.1. **Initial Stage.** During the initial stage of bare base development, engineer efforts should be concentrated on accomplishing those tasks that are necessary to meet the combat sortie generation requirements of the CDR. These tasks (not in sequential order) include:

1.6.1.1. Establishing and developing water points.

1.6.1.2. Inspecting airfield pavements for serviceability and accomplishing expedient repairs and marking if required (**Figure 1.8.**).

Figure 1.8. Airfield Repair at Bagram Airfield, Afghanistan (2007).

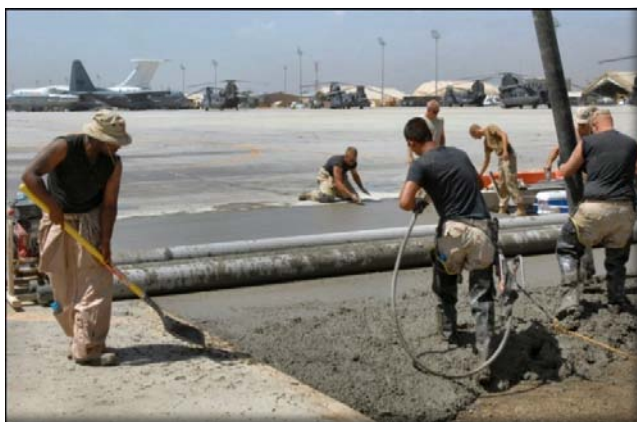

1.6.1.3. Hauling water from water points to purification site.

1.6.1.4. Establishing expedient field latrines.

1.6.1.5. Establishing basic water treatment plant (facility and purification/storage).

1.6.1.6. Verifying arresting barrier serviceability or installing MAAS.

1.6.1.7. Verifying airfield lighting serviceability or installing emergency airfield lighting set (EALS).

- 1.6.1.8. Providing site preparation support for navigational aids (NAVAID), Fuels, Cryogenics, and other mission critical facilities.
- 1.6.1.9. Provide engineer assistance for Fuels System.
- 1.6.1.10. Providing mission-essential power to critical facilities using mobile generators (up to 100 kW in size).
- 1.6.1.11. Setting up emergency security/area lighting.
- 1.6.1.12. Performing EOD inspection of the entire installation.
- 1.6.1.13. Preparing a site plan for the entire installation to include facility group, road and utility system locations.
- 1.6.1.14. Laying out facility groups and roads.
- 1.6.1.15. Starting layout and trenching for utility systems.
- 1.6.1.16. Grading primary roads and access ways to major facility group areas.
- 1.6.1.17. Establishing basic base defense network.
- 1.6.1.18. Establishing a munitions holding area.
- 1.6.1.19. Establishing engineer supply points for receiving, sorting and releasing BEAR assets.
- 1.6.1.20. Setting up engineer command and control center and billeting/dining area.
- 1.6.1.21. Establishing a “taxi/bus” service to move work crews to and from work areas (vehicles will be in short supply).
- 1.6.1.22. Establishing alerting system and contamination control areas.
- 1.6.1.23. Establishing fire emergency services.
- 1.6.1.24. Establishing 24/7 support for the airfield (sweeping and maintenance of airfield lights, MAAS, etc.).
- 1.6.1.25. Establishing CBRN monitoring points (**Figure 1.9**).

1.6.1.26. Performing Environmental Baseline Survey (comply with theater-specific requirements). Useful references may include FM 3-34.5/MCRP 4-11B, *Environmental Considerations* and AFH 10-222, Volume 4, *Environmental Guide for Contingency Operations Overseas*.

Figure 1.9. Positioning an M-22 Automatic Chemical Agent Alarm.



1.6.2. **Intermediate Stage.** During the intermediate stage of bare base development, emphasis should be placed on erecting all BEAR facilities and placing utility systems in service. Some engineer workers are usually devoted to system operations and maintenance. The thrust in this stage is to provide the ability for all base agencies and functions to establish basic operating capability within the first ten days of deployment. Engineer tasks (not in priority order) include:

1.6.2.1. Establishing fully functioning water plant(s).

1.6.2.2. Installing over-the-ground pipeline and pumps from water source to treatment plant.

1.6.2.3. Laying out “flexible hose” water distribution system for initial water supply to latrines, kitchens and storage bladders.

1.6.2.4. Connecting facilities and systems requiring water to the flexible hose distribution system.

1.6.2.5. Establishing a waste collection capability using sewage collection trailers.

1.6.2.6. Installing field latrines and shower/shave units (**Figure 1.10**).

Figure 1.10. Assembling Field Showers at Operating Location.



1.6.2.7. Starting aboveground layout and connection of hardwall water distribution system once basic softwall distribution system is in service.

1.6.2.8. Leveling sites and constructing berms/dikes for POL storage areas.

1.6.2.9. Grading road network throughout installation (**Figure 1.11**).

1.6.2.10. Clearing hazards in airfield clearance zones, if necessary.

Figure 1.11. “Dirt Boy” Grading Road at Airfield in Afghanistan (2009).



1.6.2.11. Constructing expedient berms for munitions storage area.

1.6.2.12. Expanding aircraft parking surfaces, if necessary.

1.6.2.13. Installing static grounds at fueling points, arming pads, hot cargo pads, maintenance areas, etc.

1.6.2.14. Set up power plant(s) using Prime Power generators (**Figure 1.12.**).

Figure 1.12. Preparing MEP-12 Generator at Forward Operating Location.



1.6.2.15. Laying out and burying the high-voltage distribution cabling and connecting the primary and secondary distribution centers.

1.6.2.16. Connecting base facilities to power system as they are erected.

1.6.2.17. Placing MEP generators into service as backup power to mission essential facilities once primary power is provided.

1.6.2.18. Installing grounding systems at munitions areas, electrical components, etc.

1.6.2.19. Erecting engineer maintenance and shop facilities.

1.6.2.20. Providing technical guidance to other base organizations on facility erection.

1.6.2.21. Constructing evaporation ponds/stabilization lagoons as necessary.

1.6.2.22. Start sanitary landfill operation, if required.

1.6.2.23. Installing heaters in facilities.

1.6.2.24. Assisting other base organizations in moving BEAR assets from holding areas to site locations.

1.6.2.25. Increasing engineer supply point operations to include storage of BEAR shipping containers and engineer related BEAR equipment.

1.6.2.26. Establishing hazardous waste control areas.

1.6.2.27. Laying out and begin constructing aircraft revetments.

1.6.2.28. Clearing perimeter areas and expanding the base defense network.

1.6.3. **Follow-On Stage.** During the follow-on stage, final installation of BEAR assets takes place and survivability enhancements to the base are considered. Most of these types of tasks should be completed within the first 30 days. Engineer tasks (not in sequential order) for this stage include:

1.6.3.1. Burying of the “hardwall” water distribution system (**Figure 1.13.**).

1.6.3.2. Installing environmental control units (ECU) in facilities.

1.6.3.3. Constructing aircraft and vehicle wash racks.

1.6.3.4. Installing the BEAR sewage collection system.

1.6.3.5. Connecting showers and latrines to the sewage collection system.

1.6.3.6. Connecting all facilities requiring water to the hardwall system.

1.6.3.7. Retrieving and repacking the “softwall” water distribution system.

1.6.3.8. Burying electrical distribution cables that were originally on the ground surface.

1.6.3.9. Establishing ice-making capabilities in water plant(s).

Figure 1.13. Digging Trench for Water Lines at Ali Base, Iraq (2008).



1.6.3.10. Building fixed defensive fighting positions around the base perimeter.

1.6.3.11. Building and placing obstacles supporting base defense requirements.

1.6.3.12. Modifying host-nation-provided facilities for US use.

1.6.3.13. Constructing basic personnel shelters for survivability purposes.

1.6.3.14. Siting and developing dispersal locations.

1.6.3.15. Performing camouflage, concealment, and deception activities with available resources (primarily netting).

1.6.3.16. Hardening critical facilities/utility nodes with revetments, sandbags and berms.

1.6.3.17. Preparing an emergency disposal range for EOD use in munitions destruction (**Figure 1.14.**).

Figure 1.14. EOD Inventories Ordnance in Preparation for Disposal.



1.6.4. **Sustainment Stage.** When the sustainment stage begins, most BEAR support work has been completed and the engineer's focus shifts to operations, maintenance and upgrade activities. The extent of many of these activities will be predicated on the anticipated duration of the deployment—this is a command decision that should be made early in the bare base operation. Typical engineer tasks during this period include:

- 1.6.4.1. Providing maintenance and repair support to BEAR assets and US used in-place facilities.
- 1.6.4.2. Providing essential services such as utility plant operation, refuse collection, airfield sweeping, Fire Emergency Services, environmental protection, hazardous waste management, etc.
- 1.6.4.3. Upgrading roads using soil cement, asphalt paving or crushed stone.
- 1.6.4.4. Constructing flooring in non-critical facilities.
- 1.6.4.5. Establishing material stocks for potential base recovery efforts.
- 1.6.4.6. Developing contingency response plans for base recovery and natural disasters and writing accompanying checklists.
- 1.6.4.7. Establishing supply and services contracts with local vendors, as security considerations allow, for such things as refuse collection/disposal, sewage disposal, water supply, etc.
- 1.6.4.8. Developing contingency training and exercise programs.
- 1.6.4.9. Providing quality of life improvements such as increased square footage, additional air conditioning, hot water, etc.
- 1.6.4.10. Constructing basic recreational facilities.
- 1.6.4.11. Providing more utility support to outlying/heavily populated areas.
- 1.6.4.12. Improving personnel protective shelters.
- 1.6.4.13. Increasing hardening features of base facilities.
- 1.6.4.14. Increasing security measures such as area lighting and fencing.
- 1.6.4.15. Constructing protective structures such as sun shades and wind breaks (**Figure 1.15**).
- 1.6.4.16. Replacing temporary pavement surfaces or repairs with permanent fixes.
- 1.6.4.17. Constructing permanent berms for munitions storage areas.

Figure 1.15. Raising Aircraft Sun Shade On Balad Air Base, Iraq (2008).



Chapter 2

SAFETY

2.1. General Safety Guidelines. Whether constructing a beddown location from the ground up or upgrading existing facilities and infrastructure, the nature of our business involves work that can crush, cut, pinch, burn, freeze, poison, electrocute, suffocate, and many other ills. We must be forever vigilant to avert injury and death caused by preventable unsafe acts and conditions. Compliance with all technical order warnings and cautions is essential and our engineers must wear appropriate personal protective equipment (PPE) according to applicable technical information and standards.

2.1.1. Published Guidance. When published guidance is available and followed, unsafe acts and conditions can usually be avoided. Guidance comes in many different forms, including instructions; technical orders (T.O.); technical manuals (TM); commercial manuals; tactics, techniques, and procedures (TTP); handbooks; unified facilities criteria (UFC); engineering technical letters (ETL); and various on-line resources. Depending on the project or task, the guidance and instructions provided in these sources could be the difference between success and failure. Team leaders and supervisors should ensure required technical guidance is available for their engineer teams.

2.1.2. Personal Protective Equipment (PPE). No matter how effective PPE can be, it does not protect or benefit anyone unless it is available and properly worn. One of the most important responsibilities of a supervisor is to ensure their people have and wear the necessary protective equipment for the working environment. In addition, individuals should properly use, inspect, and care for PPE assigned to them. Personal protective equipment is mandated in specific equipment T.O.s, TTPs, and local guidance. **Attachment 4** lists PPE that may be needed for selected CE activities according to AFOSHSTD 91-10, *Civil Engineering*. For certain electrical tasks, additional Arc Flash PPE is required. See UFC 3-560-01, *Electrical Safety, O&M*, NFPA 70, National Electric Code, and Engineering Technical Letter (ETL) 06-9: *Arc Flash Personal Protective Equipment (PPE) Requirements for High-Voltage Overhead Line Work at 69 kV (Nominal) or Less*, for specific requirements.

2.2. Job Hazards. Ensuring personnel observe proper safety procedures are especially critical during bare base development. Exposure to construction, heavy equipment, power production equipment, fuel systems, mechanical systems, and water and waste system operations makes for a hodgepodge of job safety hazards. Items like flammable fuels, high voltages, dangerous chemicals, and rotating, cutting, and crushing equipment associated with these operations are significant hazards, and adherence to all technical data warnings is critical to avoid personal injury or death. In particular, personnel must comply with AFI 32-1064, *Electrical Safe Practices*, any time lethal voltages are involved. It is also important that workers be protected against hazards such as high-pressure subsystems and components, harmful solvents and adhesives, and infectious black and gray water products from wastewater systems.

2.3. Basic Safety Rules. Each job or operation has its own particular safety hazards and everyone involved must follow proper safety procedures to prevent injury or illness. In addition to wearing required PPE, **Attachment 5** lists basic safety rules for specific CE operations and equipment according to AFOSHSTD 91-10. Ensure personnel check applicable safety standards and technical and operator manuals for additional safety requirements *before* performing operations or using equipment. Additionally, Arc Flash warning labels (**Figure 2.1.**) must be present on switchgear, switchboards, panelboards, disconnect switches, industrial control panels, meter socket enclosures, and motor control centers according to UFC 3-560-01.

Figure 2.1. Typical Arc Flash Warning Label.



Chapter 3

SITE LAYOUT

3.1. Layout Plan. Site planning and layout are critical tasks that set the stage for the entire bare base development operation (**Figure 3.1.**). In a worst-case situation where a true bare base is encountered, no existing facilities or developed utility systems will be available. The base will fully rely on incoming BEAR and/or other mobile assets and local resources. With limited or non-existent infrastructure, facility and group layout often depend on the physical layout of the terrain, tactical and operational requirements, and available resources.

An organized base layout is a crucial part of a master plan. Poor site layout may degrade physical health, reduce coordination and cooperation among units, erode morale, and increase operational costs.

Figure 3.1. Site Planning and Layout Is Vital.



3.1.1. A conventional site layout for an expeditionary base is depicted in **Figure 3.2**. When the base's defense boundary allows a conventional layout to be considered, support facilities, billeting, and services functions can be progressively moved away from the flightline and industrial support functions. If the base is long and narrow, a more linear layout may be appropriate. Whatever the layout, the dispersed distances listed in **Table 3.1**. should be used as a guide when planning and establishing essential facilities and groups. However, improved safety and advances in materiel (i.e. smaller footprint, reduced hazards) may decrease dispersal distances.

Figure 3.2. Conventional Site Layout.

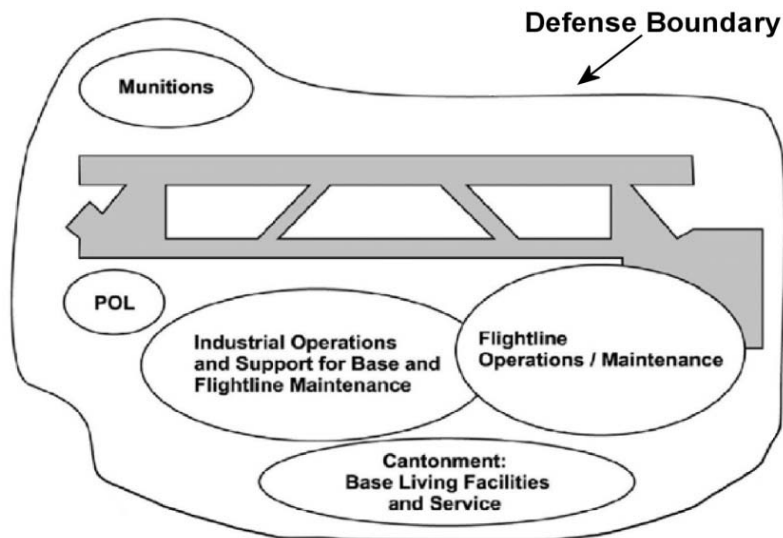
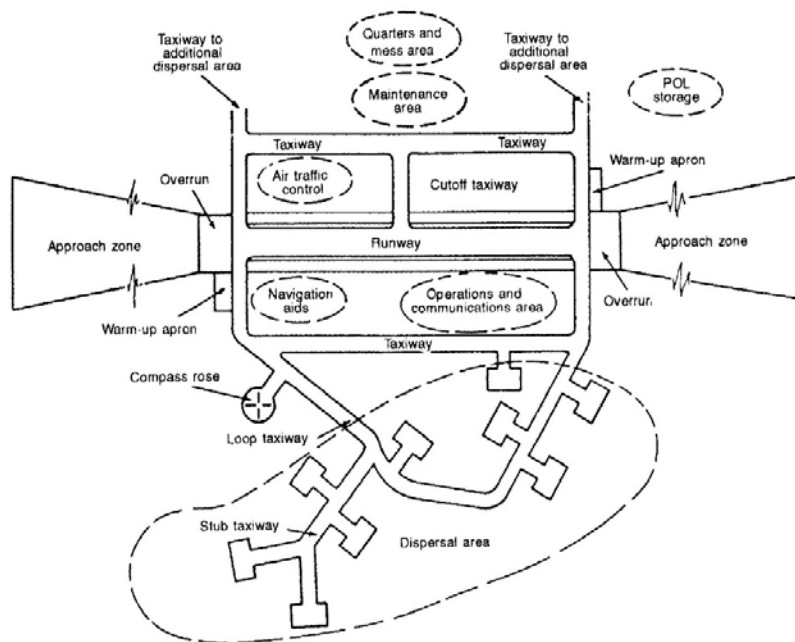

Table 3.1. Airfield Layout Facility/Group Dispersed Distances.

Dispersed Distances (feet) (Source : AFTTP (I) 3-2.68, Airfield Opening)									
Facility/ Group	Billeting	MX	Base Ops/ FES	Aerial Port	Munitions	LOX	POL	Trans- portation	Medical
Billeting		1600	1600	1600	3160	1600	2640	900	200
MX	1600		1000	1600	3160	1600	2640	200	1600
Base Ops/ FES	1600	1000		200	3160	1600	2640	1600	1600
Aerial Port	1600	1600	200		3160	1600	2640	1600	1600
Munitions	3160	3160	3160	3160		3160	1800	3160	3160
LOX	1600	1600	1600	1600	3160		2640	1600	1600
POL	2640	2640	2640	2640	1800	2640		2640	2640
Trans- portation	900	200	1600	1600	3160	1600	2640		200
Medical	200	1600	1600	1600	3160	1600	2640	200	

3.1.2. Dispersal may also play a role when protecting aircraft assets. If dispersal of aircraft is possible and consistent with active defense measures, varied parking patterns provide fewer lucrative targets for indirect-fire weapons. **Figure 3.3.** illustrates an airfield layout that provides random, dispersed aircraft parking areas.

Figure 3.3. Notional Airfield w/Dispersed Aircraft Parking Layout.



3.2. Facility Placement and Spacing. When facility groups are laid out, they often impact each other. Ensure enough room is allowed in each of the facility groups for future expansion and growth requirements (including utilities), as illustrated in **Figure 3.4.** and **Figure 3.5.** Placement and spacing of facilities will also influence the space available for construction of revetments and personnel bunkers. If these requirements are not accounted for initially, the result may be

higher risk facility configurations or a requirement to relocate utility systems. Consult the theater engineer staff about command-specific base defense construction standards and the potential for follow-on aircraft squadrons and other mission beddowns. Additionally, consult Bioenvironmental Engineering (BE) for methods to reduce or minimize base population exposures to health hazards (noise, chemical, radiation, etc) during base development. The BE flight conducts health-based site assessments from initial bare base development to enduring bases.

Figure 3.4. Notional 1,100-Person Facility Layout (Before Expansion).

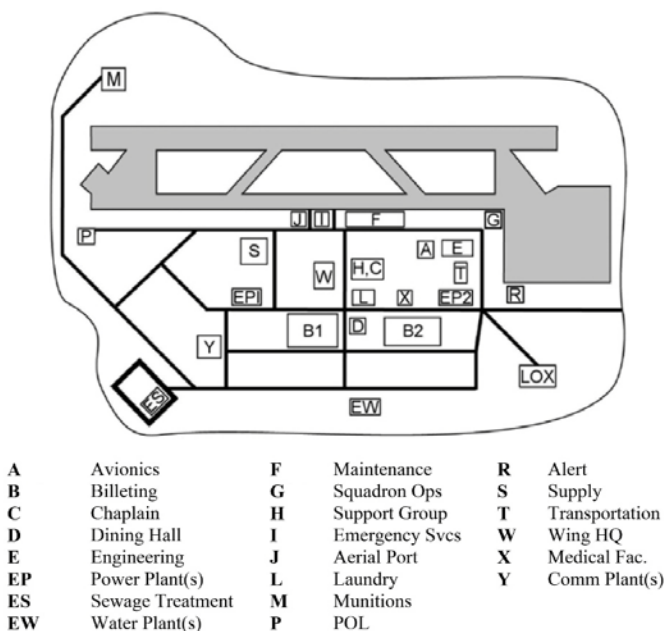
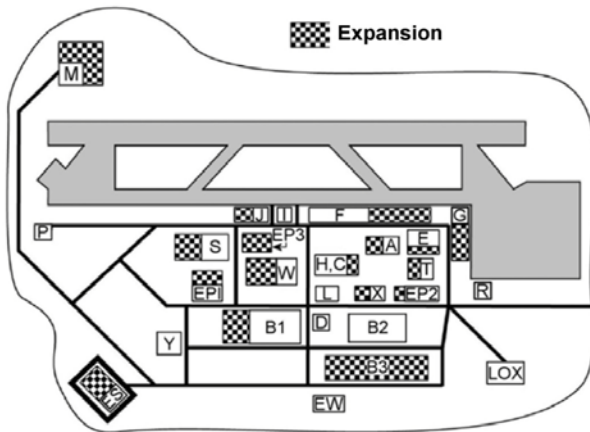

Figure 3.5. Notional 3,300-Person Facility Layout (After Expansion).

3.2.1. Minimum Antiterrorism Standards. In addition to conforming to theater-specific construction standards, expeditionary structures should comply with minimum antiterrorism standards prescribed in UFC 4-010-01, *DOD Minimum Antiterrorism Standards for Building*, Appendix D, and UFC 4-020-01, *DOD Security Engineering Facilities Planning Manual*. Standoff distances and facility separation is especially critical for these structures because hardening may or may not be possible. The following paragraphs address standoff distances, structure separation, and facility dispersal.

3.2.1.1. Standoff Distances and Structure Separation. Standoff distances are used to minimize the accessibility and vulnerability of a facility. These distances are critical when siting a facility and can effectively mitigate indirect fire and Improvised Explosive Device (IED) attacks. Structure separation requirements are established to minimize the possibility an attack on one structure causes injuries or fatalities in adjacent structures. The separation distance is predicated on the potential use of indirect fire weapons. Standoff distances and separation for expeditionary and temporary structures are listed in UFC 4-010-01 and UFC 4-010-02 (FOUO) respectively. Always refer to these two UFCs and theater construction standards for specific requirements.

3.2.1.2. Facility Dispersal. While standoff and separations distances are important to base defense, dispersed facility layouts also reduce risks from a variety of threats by taking full advantage of terrain and site conditions; therefore, nothing in the standoff distances or separation standards are intended to discourage dispersal. However, dispersal distances may be limited by other factors such as available resources and utilities. For example, If dispersed facilities will be supported by utility systems (e.g. electrical, water and waste distribution systems), appropriate adjustments must be made to the utility sizes and quantities when site plans are changed to accommodate actual field conditions, topography changes, and local dispersal requirements.

3.2.2. Other Layout Considerations. When reviewing the facility group layouts, make sure everything can fit well within the real estate available and according to facility and facility group dispersal requirements. The overall facility/group layout should be built around a road network that provides easy access to various points on the flightline, since much of the initial base traffic will be operating from flightline locations. Look at the locations for utility plants, evaporation beds, and stabilization lagoons (if required) at this time. Ensure the locations of sewage lagoons are downwind from the base.

3.2.2.1. The locations of all large facilities, such as aircraft hangers, frame supported tension fabric shelters or dome shelters should be marked on the site layout map. A representative sampling of the more common medium and small shelter systems should also be represented. A general template (and dispersal pattern if necessary) should be provided to the survey crews who will eventually stake out the facility groups.

3.2.2.2. Once site layout is completed, engineer survey crews must begin the sizable task of physically marking the locations of the various base assets. Use more than one crew and augment with other shop or base personnel, if necessary. If required, survey crews should identify and mark the locations of the mobile aircraft arresting systems and airfield lighting components.

3.2.2.3. Have crews initially mark the boundaries (corners and a few intermediate points if distances are long) of the various facility groups. Use markers that are relatively permanent (e.g. driven stakes) since they will become

benchmarks for starting the location marking of individual facilities and assets. Expedient survey methods are used during this process, for example, "walking off" distances, using vehicle odometers, or using a hand compass for turning angles.

3.2.2.4. Once facility groups are laid out, concentrate on locating individual facilities within each facility group. In smaller groups (e.g., aerial port, squadron operations, alert area, etc.), the location of all facilities can be pinpointed at one time. In large groups, such as the billeting complex, locate only a portion of the total requirement initially—don't get hung up on trying to locate positions of facilities for people who won't be arriving for a few days. These large areas can be marked after other more important operational portions of the base are completed. Use expedient survey methods for laying out individual facilities as well. Because individual facility layout is repetitious with respect to distances between buildings, a couple of pieces of rope cut to the proper spacing intervals can be used as a quick and accurate way of measuring and locating facility positions.

3.2.2.5. Plan the locations of water and electrical plants and distribution systems, in relation to facility siting, early in the site layout process. When siting and installing contingency water systems, refer to AFH 10-222, Volume 11, *Contingency Water System Installation and Operation*, and for contingency electrical systems, refer to AFH 10-222, Volume 5, *Guide to Contingency Electrical Power System Installation*. Coordinate plans with the shop superintendents and survey crews to optimize constructability, serviceability and speed of initial setup. See **Chapter 8** and **Chapter 9**, in this handbook for more information on developing bare base utilities.

3.2.2.6. Consider location and routing of fuel distribution system during initial facility layout. To ensure safety and fuel hose/line integrity, carefully consider the placement of fuel lines and hoses. Strive to design road layout so fuel lines/hoses will not cross roads. If facility expansion requires intersecting fuel hoses/lines with roads, provide a trench with a hardened cover to protect the fuel hose/line.

Chapter 4

BARE BASE AIRFIELDS

4.1. General Information. Upgrading, modifying, or restoring an existing airfield to full operational or mission-ready status are considerable bare base development tasks. Even after the “Open the Airbase” phase is completed, our Prime BEEF forces continue the enormous task of developing the airfield and support facilities for the intended mission. Airfield development tasks include clearing airfield hazards and obstacles, repairing pavement, installing and repairing aircraft arresting systems, constructing revetments and berms, setting up airfield lighting, implementing dust control measures, and many other tasks. This chapter provides insight into these and other areas related to airfield development.

4.2. Airfield Hazard Clearance. Clearing airfield hazards is a top priority and usually begins during the airfield opening phase of bare base development. Initial engineer forces, using information garnered from airfield assessments and the situation on the ground, start clearing hazards as soon as practical after arriving on station. Obviously, unexploded explosive ordnance or scattered wreckage and debris on airfield pavements pose considerable hazards, and will probably have the innate attention of both the mission commander and engineers until the airfield is operational. When Prime BEEF forces arrive, most hazards and obstacles in the airfield clear zones may be removed, but any remaining hazards should be removed or mitigated early in the beddown process.

4.2.1. Unexploded Ordnance (UXO) Hazards. Whether found during force beddown operations or recovery after an attack, the presence of UXO is a threat to operations, installations, personnel and material. Safing and clearance of these deadly hazards is a responsibility of Explosive Ordnance Disposal (EOD) teams. EOD teams may defuse, detonate, or perform other actions to neutralize munitions “in-place,” or they may move munitions to a nearby, isolated, and protected location to defuse, detonate, or otherwise abate the immediate threat. **Note:** Under certain circumstances, our joint and coalition partners with mine clearing capability may assist in clearing large numbers of mines or UXO from planned beddown areas.

4.2.1.1. During site layout, when constructing defensive fighting positions, erecting shelters, or running utilities, expect a slower, more extended UXO clearing process. EOD teams will clear UXO from these areas before construction begins. Any resulting craters from in-place UXO demolition may need to be leveled by heavy equipment operators. Once safing procedures are completed, erection of facilities and surface layout of utilities can proceed within the cleared areas.

4.2.1.2. Burying utilities may present additional challenges. Mines and UXO located below the surface, especially in areas subject to flooding with drifting soil and sand, could explode when hit or uncovered when trenching. EOD teams may need to scan or sweep for additional UXO and mines directly along the pathways for utility trenching.

4.2.1.3. While EOD teams are responsible for UXO clearing, other engineer personnel may be tasked to support them. **Table 4.1.** lists a few tasks augmenters may perform to support EOD activities. Using safe practices, other wartime tasks, such as crater repairs, can begin as soon as EOD personnel have progressed sufficiently down the airfield. Always follow EOD guidance and seek additional information on UXO operations in the references provided at the end of this chapter.

Table 4.1. EOD Support Tasks.

Support Tasks
Construct protective berms around danger zones
Provide heavy equipment support to access or remove UXO
Roping off areas around UXO
Reinforcing adjacent structures
Isolating major utilities around UXO areas

4.2.1.4. Protective Measures. Before any UXO clearance operation begins, take measures to protect personnel and equipment by evacuating, isolating, barricading, or any combination thereof.

4.2.1.4.1. Evacuate. Adhering to **Table 4.2.**, evacuate all nonessential personnel and equipment in the danger zone before commencing UXO clearance operations. Allow movement within the danger zone to essential personnel only. Personnel who must remain in the area should wear all protective equipment including Kevlar helmets and vests.

Table 4.2. Minimum Evacuation Distances during UXO Clearing.

Explosive Weight (Pounds)	Evacuation Distance (Meters)	Evacuation Distance (Feet)*
27 or less	350	1148
30	360	1181
35	380	1246
40	400	1312
45	410	1345
50	430	1410
100	540	1772
150	610	2001
200	670	2198
250	730	2395
300	770	2526
400	850	2789
500	910	2986
* Approximate conversion of meters to feet.		
(Source: AFTTP(I) 3-2.12)		

4.2.1.4.2. Isolate. For mission-related, operational, or other reasons, some mission-essential personnel or equipment cannot be evacuated. To the greatest extent possible, isolate these assets from, and limit exposure to, the immediate vicinity of the UXO.

4.2.1.4.3. Barricade. Use barricades to protect mission-essential personnel and equipment that must stay in the hazard area. Barricading provides limited protection by blocking blast and fragmentation from an explosion. *Suppressive* barricades (**Figure 4.1.**) are constructed to isolate an explosion, to deflect thermal and shock waves and absorb low-angle, high-speed fragments. On the other hand, *Protective* barricades (**Figure 4.2.**) are constructed around exposed resources to shelter them from overpressure and the impact of high-angle, low-speed fragments, which can escape over the top of “suppressive” barricades. See AFTTP (I) 3-2.12, *UXO Multi-Service Tactics, Techniques, and Procedures for Unexploded Explosive Ordnance Operations* for more information on barricade construction and UXO operations.

Figure 4.1. Suppressive Barricades Isolate Explosions.

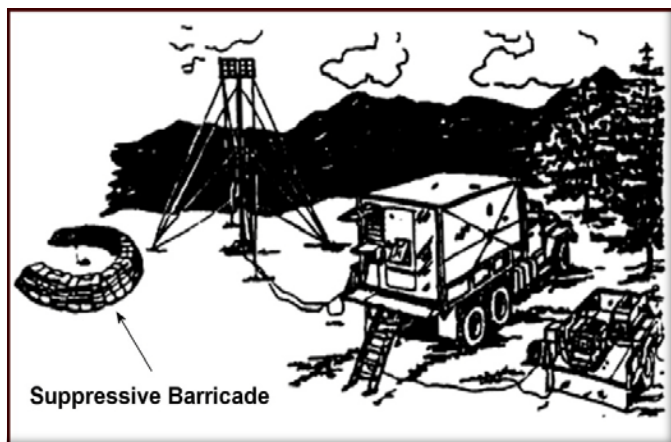
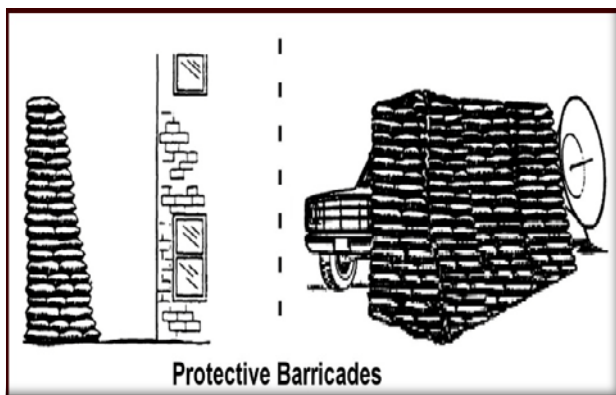

Figure 4.2. Protective Barricades Shields Resources.

4.2.2. Wreckage and Debris Hazards. Removing wreckage and debris hazards from runways, taxiways, and aircraft parking areas is essential to increase airfield operability. Material initially pushed aside to establish an expedient airfield (minimum operating strip or landing zone), or left in nonessential areas can be removed when time and resources become available. Material may be pushed into craters at the scene, moved to a central location for disposition, or loaded into dump trucks and transported to a remote location for disposal. Whatever the case, engineers must remain vigilant when using heavy equipment and be on the lookout for UXO.

4.2.2.1. Equipment. The type of equipment needed to clear aircraft operating surfaces depends on the size and amount of debris. The presence of large pieces of wreckage or debris (e.g. damaged vehicles, aircraft, or pavement sections) necessitates the use of heavy equipment such as bulldozers and cranes. However, many of the heavy equipment items needed may not be on the first series of incoming airlift sorties. Until these assets arrive, consider working with the contracting officer to find local sources of heavy equipment and materials. The following equipment items are commonly used for debris clearing operations:

4.2.2.1.1. *Crane.* For removing extremely large chunks of debris, a crane may be the only suitable piece of equipment.

4.2.2.1.2. *Bulldozer.* A bulldozer has the power to push large pieces of debris out of an area and can quickly clear large areas of smaller debris. One skilled dozer operator can clear an area that would require several hours of labor if done by hand.

4.2.2.1.3. *Front-End Loader.* Front-end loaders are especially useful in loading debris on dump trucks and other vehicles for removal from the site. They also are adequate for clearing paved areas and streets of large amounts of small debris.

4.2.2.1.4. *Dump Truck.* Dump trucks haul debris to disposal sites. Other suitable vehicles, such as cargo trucks and tractor-trailer units, can sometimes substitute for them.

4.2.2.1.5. *Sweepers.* Once larger debris is removed from an area, street sweepers and vacuum trucks are employed to clear smaller items from aircraft operating surfaces and primary access streets. If sweepers are not used, small metal items left on roadways and working areas can cause tire damage to aircraft and equipment involved in cleanup operations. Time spent repairing and replacing flat tires on these vehicles delay the overall recovery effort.

4.2.2.1.6. *Towing Devices.* Steel cable, chains, hooks, and similar items can be fashioned into towing devices for debris removal. Care must be used when selecting towing devices to ensure they are appropriate and strong enough for the job.

4.2.2.2. **Manpower.** Generally, manpower is stretched to the limit during airfield opening operations; therefore focus available resources to clear debris from minimum airfield operating surfaces first.

4.2.3. **Airfield Obstructions.** Debris is removed quickly from airfield pavements to facilitate recovery and launch of aircraft and to accommodate aircraft parking and loading requirements. However, obstructions along the approach or departure ends of the runway, around ramps and taxiways, or near the adjacent terrain may still need to be removed (**Figure 4.3.**). Be especially

observant of terrain features or obstacles that could affect wing tip clearance of wide-body aircraft. However, it may not be prudent to have crews remove items in the outer edges of the clear zones that produce minimal danger (a culvert head wall for example)—in these instances, airfield authorities may initially accept the risk. Also ensure the shoulders of runways and taxiways and the grounds along access routes to aprons and ramps are checked for potential foreign object damage (FOD) producing areas.

Figure 4.3. Removing Destroyed Iraqi Tank near Taxiway, Iraq (2008).



4.3. Airfield Repairs and Restoration. Immediate repair and restoration may include selection of a minimum operating strip (MOS), expedient airfield or landing zone (LZ) marking and repairs, pavement sweeping and cleaning, pavement marking and striping, site preparation for installation of navigational aids (NAVAIDs), and installing airfield lighting and mobile aircraft arresting systems (MAAS). The goal is to have the airfield ready to commence aircraft operations as soon as possible. As soon as a minimum operating strip is established, plan on immediately dedicating equipment and personnel to around-the-clock airfield sweeping operations since there will likely be considerable aircraft and vehicle traffic on pavement surfaces as bare base assets are delivered, off-loaded and transported from ramp areas.

4.3.1. **NAVAIDs.** Support for NAVAIDs includes clearing and leveling various sized areas for setting up mobile communications equipment. Normally these areas are not particularly large (2,500 sq ft or so), but plan on having to clear and grade vehicle access ways up to 1,000 feet long to these sites and provide electrical service. See AFPAM 10-219, Volume 5, and consult with Communications personnel for specific siting requirements.

4.3.2. **Minimum Operating Strip (MOS).** By definition, the MOS is a runway that meets the minimum requirements for operating assigned and/or allocated aircraft types on a particular airfield at maximum or combat gross weight. When airfield damage, unexploded ordnance, or other obstructions prevent immediate and full use of the runway, quickly selecting a MOS for operation of mission aircraft is essential. Minimum operating strip layout usually involves identifying the location or layout of the areas listed in **Table 4.3**. See AFPAM 10-219, Volume 4, *Airfield Damage Repair Operations*, for more MOS information.

Table 4.3. MOS Layout Tasks.

MOS Layout Tasks	
1	MOS Centerline
2	MOS Corners
3	Taxiway entrances or exits
4	“T” Clear Zones
5	Mobile Aircraft Arresting System (MAAS)
6	Distance-To-Go (DTG) Markers
7	Precision Approach Path Indicators (PAPI)
8	Edge Markers
9	Taxiway holding lines, centerlines, and changes in direction
10	Emergency Airfield Lighting

4.3.3. **Landing Zones (LZs).** Landing zones support contingency airlift operations for C-130 and C-17 aircraft. Potential LZ areas fall into two basic categories: prepared and semi-prepared (unpaved). Prepared areas may include

existing airfields, roads, highways, or other paved surfaces. Semi-prepared surfaces are natural areas such as deserts, dry lakebeds, and flat valley floors (**Figure 4.4.**). These surfaces offer the ability to construct short airstrips for a limited use and may or may not have an aggregate surface. Although Prime BEEF forces may not be involved with the initial construction of LZs, they could be tasked with maintaining LZs if flight operations continue. Surface maintenance may include soil stabilization, adding an aggregate course, compacting in-place soils, or matting. See ETL 09-6, *C-130 and C-17 Landing Zone (LZ) Dimensional, Marking, and Lighting Criteria*, for more information on LZs.

Figure 4.4. C-17 Lands on Semi-Prepared LZ.



4.3.4. **Airfield Markings.** Airfield markings must adhere to precise guidelines that conform to recognized standards for aircraft operations as identified in AFI 32-1042, *Standards for Marking Airfields*, and USAF Engineering Technical Letter (ETL) 04-2, *Standard Airfield Pavement Marking Schemes*. While these standards are considered ideal under normal circumstances, it is unlikely sufficient time will exist to restore the markings to their original condition following an attack. The marking team must be ready to apply expedient techniques that will mark the usable runway surface in the shortest possible time to launch and recover aircraft in a timely fashion.

4.3.4.1. **MOS Markings.** MOS markings consist of threshold and centerline pavement markings, edge markers, and aircraft arresting system location and distance-to-go (DTG) markers. Pavement markings and markers may be used together or independently. For the basic layouts for marking and striping a MOS, see T.O. 35E2-6-1, *Minimum Airfield Operating Surface Marking System (MAOSMS)* and AFH 10-222, Volume 16, *Guide for Use of the Minimum Airfield Operating Surface Marking System*.

4.3.4.2. **LZ Markings.** Marking and lighting schemes for LZs are covered in AFI 13-217, *Drop Zone and Landing Zone Operations*, and ETL 09-6, *C-130 and C-17 Landing Zone (LZ) Dimensional, Marking, and Lighting Criteria*.

4.3.5. **Expedient Airfield Pavement Repairs.** Repairs to airfield pavements may be needed due to war damage by our forces in a battle for the airfield; deliberate damage the enemy did before yielding the field to our forces; poor or substandard construction; or general disrepair due to inadequate upkeep and maintenance. Whatever the reason, pavement repairs during the initial period of beddown must usually be rapid in nature (e.g., compacted crushed stone, cold mix, quick set cements, etc.), due to pressing operational need. When time permits, the expedient repairs are upgraded to sustainment repairs to allow more aircraft passes between maintenance of the repairs. When appropriate, upgrade the sustainment repairs to permanent repairs.

4.3.5.1. **Spall Repair.** Spalls are generally defined as pavement surface damage that does not penetrate through the pavement surface to the underlying layers ([Figure 4.5](#)), and less than 5 feet in diameter. As a norm, spalls are easier to correct than crater damage, providing the number of spalls are not overwhelming. For specific spall repair procedures, see UFC 3-270-03, *Concrete Crack and Partial Depth Spall Repair*, ETL 09-2: *Contingency Airfield Pavement Specifications*, and ETL 07-8: *Spall Repair of Portland Cement Concrete (PCC) Airfield Pavements in Expeditionary Environments*.

4.3.5.2. **Crater Repair.** Craters represent damage that penetrates through the pavement surface into the underlying base and sub grade soil, which uplifts the surrounding pavement and ejects base, sub base soils, rock, and pavement debris around the impact area ([Figure 4.6](#)). Craters are more severe damage than

spalls. Large craters have an apparent diameter equal to or greater than 6 m (20 ft). Small craters have an apparent diameter less than 6 m (20 ft). There are several crater repair methods and newer methods are often being tested and evaluated. For specific crater repair methods and criteria, refer to UFC 3-270-07, *O&M: Airfield Damage Repair*, and AFPAM 10-219 Volume 4.

Figure 4.5. Repairing Spall Damage at Deployed Location.



Figure 4.6. Crater with Upheaval.



4.3.6. **Airfield Lighting.** Airfield lighting may not be important for routine daytime aircraft operations, but it is essential for flight in an environment with limited visibility. Restoration of the existing permanent lighting system may not be feasible due to the extent of damage or location of existing lighting relative to the MOS; if this is the situation, initially install an Emergency Airfield Lighting System (EALS). If considerable daylight will be available after anticipated ADR operations, airfield lighting should not be immediately critical to aircraft launch and recovery efforts; therefore, installation can be delayed so workers can be used on higher priorities. On the other hand, if the onset of darkness or limited visibility due to bad weather is a factor, start airfield lighting installation as soon as possible. Procedures for installing EALS (**Figure 4.7.**) are provided in T.O. 35F5-3-17-1, *Lighting System, Airfield, Emergency A/E82U-2*, and AFH 10-222, Volume 7, *Emergency Airfield Lighting System (EALS)*. In most cases, the question will be when to install the lighting system, not whether one is necessary.

Figure 4.7. EALS Supports Contingency Airfield Lighting Requirements.



4.3.7. **Perimeter and Critical Area Lighting.** Portable lighting is provided in both BEAR beddown packages and ADR equipment packages. They primarily consist of the Remote Area Lighting System (RALS) and TF-2 Light Carts (**Figure 4.8.**). However, some packages may still contain legacy lighting systems. The RALS is used for general lighting along the flightline, around POL or Cryogenics storage, etc. Refer to T.O. 35F5-5-22-1, *Remote Area Lighting System (RALS)*, for installation instructions. The TF-2 light cart is a mobile floodlight unit used for large area lighting. It is designed primarily for initial camp beddown, perimeter lighting and flightline use. To setup and operate the TF-2, see T.O. 35F5-5-21-1, *Flood Light, Trailer Mounted, Type TF-2*.

Figure 4.8. Examples of Portable Area Lighting.



4.3.8. **Mobile Aircraft Arresting System (MAAS).** Provides expedient aircraft arresting capabilities for arresting hook-equipped fighter aircraft and is capable of up to 20 aircraft engagements per hour (**Figure 4.9.**). If the arresting system is necessary, MOS layout personnel should mark its location prior to the arrival of the MAAS installation team. Additional details regarding applications and capabilities of this system are discussed at length in T.O. 35E8-2-10-1, *Mobile Aircraft Arresting Systems (MAAS)* and AFH 10-222, Volume 8, *Guide to Mobile Aircraft Arresting System Installation*.

Figure 4.9. F-22 Engaging MAAS.

4.3.9. Aircraft Parking/Pavement Expansion. After meeting initial airfield operational requirements, pavement expansions may be required to satisfy aircraft parking and servicing requirements. Potential tasks to satisfy these requirements include expanding aircraft parking aprons and providing special pavement areas such as arm/de-arm pads, hot cargo pads, quick turn areas, compass rose, wash racks, along with the accompanying tie-down anchors and static grounding points. Existing pavements may be for some requirements; however, if it is necessary to provide these additional areas, be sure to follow safety distance criteria associated with them (arm/de-arm, hot cargo, etc). Also, ensure expansion projects meet specific characteristics (e.g., size, weight, etc.) of the supported aircraft by using the Geospatial Expeditionary Planning Tool for automated aircraft parking plans. Refer to AFTTP 3-2.68 IP, *Multi-Service Tactics, Techniques, and Procedures for Airfield Opening*, for a list of aircraft characteristics.

4.3.9.1. Start aircraft pavement expansions as soon as additional requirements are known; otherwise, a massive backlog of aircraft flows and serious congestion in material and asset movement on the ground may occur. Pavement expansion could also be required to park incoming deployed aircraft. Contact wing operations during the site planning process to obtain the probable numbers and types of expected aircraft. Coordinate aircraft parking plans with maintenance personnel. If more parking positions are needed, employ construction techniques identified in [paragraph 4.3.9.2](#).

4.3.9.2. Expanded parking areas can be constructed next to existing aircraft pavements using expedient techniques such as graded and compacted earth, compacted crushed stone or AM-2 matting over a compacted subbase. Once primarily for rapid runway crater repairs, AM-2 matting is now often used to repair or expand aircraft parking areas and as warehouse floors. Refer to UFC 3-270-07, for more information on AM-2 matting assembly and installation.

4.3.10. **Access Roads and Drainages.** Construction, maintenance, repair, and rehabilitation of access roads and drainages are critical to airfield operations. In essence, these roads are the installation's arteries that support the flow of personnel and materials needed to accomplish the mission. For information in addition to that addressed in this section, refer to FM 5-430-00-1, *Planning and Design of Roads, Airfields, and Heliports in the Theater of Operations—Road Design*.

4.3.10.1. **Access Roads.** At least one access road connecting the airfield with the existing road network is required. Bases with operations and service facilities on both sides of a runway should have a perimeter road connected to the access road. Connect service roads to hardstands, the control tower, service areas, fuel storage and dispensing areas, munitions storage areas, and base camps. It may also be desirable to provide a turnaround loop to ease vehicle maneuvers around hardstands (including fuel storage and distribution areas). Below are other roadway concerns:

4.3.10.1.1. *General.* Roads on airfields should not cross or be within the lateral clearance distance for runways, high-speed taxiways, and dedicated taxiways for alert pads. This prevents normal vehicular traffic from obstructing aircraft in transit. Roads should be located so surface vehicles will not be hazards to air navigation and NAVAIDS.

4.3.10.1.2. *Firefighting and Rescue Roadways.* Firefighting and Rescue access roads shall provide unimpeded two-way access for firefighting vehicles and equipment to incident areas (**Figure 4.10**). When practical, connecting these access roads with airfield operational surfaces and other airfield roads will enhance FES operations.

Figure 4.10. Firefighters Responding to Vehicle Fire, Iraq (2008).

4.3.10.1.3. *Fuel Truck Access.* Fuel truck access points to aircraft parking aprons should be located so minimal disruptions and hazards to active aircraft movement occurs. Fuel truck access from aircraft areas to the fuel storage areas should be separate from other vehicular traffic. Bulk fuel, truck parking, and truck filling areas need to be as close to the flight line as is reasonably possible.

4.3.10.1.4. *Explosives and Munitions Transfer to Arm/Disarm Pads.* Transfer of explosives and munitions from storage areas to arm/disarm pads should occur on dedicated transfer roads. Transfer roads should be used exclusively for explosives and munitions transfer vehicles.

4.3.10.2. **Drainages.** Drainages should be constructed and maintained for all active roadways. Improperly channeled surface water can quickly undermine most roads, even when they are considered well-constructed. Pending or delayed surface water runoff can also seep into the pavement structure of paved roads if the road surface is not tightly sealed.

4.3.11. **Road Design and Construction.** Air Force engineers generally design and construct roads in the theater of operations to three standards: initial, temporary, or semi-permanent. During contingency operations, nearly all roads are constructed to temporary standards. In some rare cases, semi-permanent and

permanent roads may be designed to support long-term operations. Initial and temporary roads are usually constructed of stabilized earth or gravel, while semi-permanent roads are typically made of asphalt with concrete turn pads. Roads are generally constructed with a crowned driving surface and pavement structure, a shoulder area that slopes directly away from the driving surface to provide drainage off the driving surface, and side ditches for drainage away from the road itself (**Figure 4.11.**). Refer to FM 5-430-00-1 for complete road construction details.

Figure 4.11. Typical Road Cross Section.

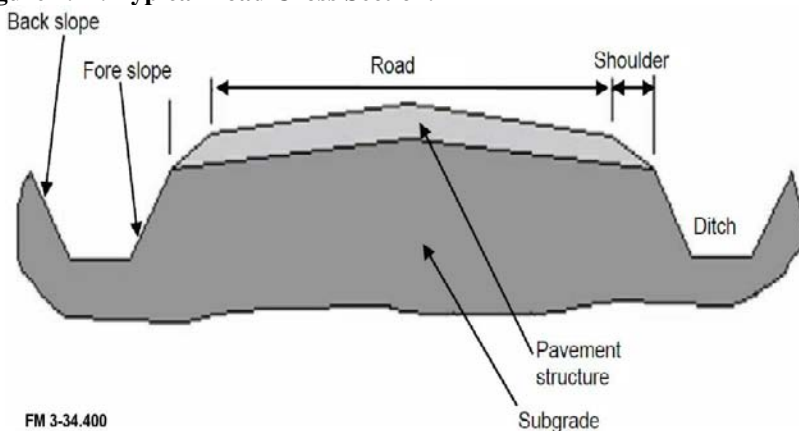

4.4. Revetment and Soil Berm Construction. Revetments and berms are simple and sometimes low-tech solutions that can satisfy certain protective and safety construction requirements. They are used primarily to protect and shield vital facilities and equipment, suppress noise, control spills, or support waste management activities in the theater of operations. **Table 4.4.** provides labor comparisons for construction of certain revetments and soil berms. As shown, berms are generally less labor intensive and quicker to build than some of the more common revetment materials, especially sandbag protective structures.

Table 4.4. Construction Man-Hour Comparisons.

Type Revetment/Soil Berm	Req. Labor
Sandbag wall (4 ft high)	1.5 mh/lf*
Freestanding soil berm (6 ft high)	0.3 mh/lf*
Fabric-reinforced soil berm (6 ft high)	0.32 mh/lf*
Sand grid wall (6 ft high)	0.4 mh/lf*
Plywood parallel walls soil-bin revetment (11 ft high)	1.53 mh/lf*
Plywood predetonation screen (12 ft tall)	0.4 mh/lf*
B-1 steel bin revetment kit (1 of 21 sections = 16 feet high by 6.9 feet wide and 12 feet long)	22.6 mh/100ft ²
* Approximate man-hours per linear foot (mh/lf) (Ref: UFC 4-020-01)	

4.4.1. Revetments. Revetments are walls or barriers generally used for base defense purposes. They are routinely constructed using soil-filled wire and fabric containers, prefabricated concrete barriers, or metal bins (**Figure 4.12.**). However, they may also be constructed using sandbags, wooden bins, sand grids, and even plastic bins or various other expedient methods. Preliminary construction plans should identify the locations for the revetments, their configuration, and a source (on-base quarry or off-base vendor) for revetment fill material. See the *Joint Forward Operations Base (JFOB) Survivability and Protective Construction Handbook (FOUO)*, UFC 4-022-02, *Selection and Application of Vehicle Barriers*, T.O. 35E4-170-2, *Aircraft Revetment Kit, Type B-1*, AFH 10-222, Volume 3, *Civil Engineer Guide to Expeditionary Force Protection*, and AFH 10-222, Volume 14, *Guide to Fighting Positions, Obstacles, and Revetments*, for more information on constructing revetments.

4.4.2. Soil Berms. Soil or earthen berms have a wide range of uses. They provide base defense as base perimeters, defensive fighting positions, traffic control barriers, or facility hardening. They also provide safety barriers for

landfills, burn pits, hazardous materials storage sites, and for noise abatement and spill protection, among other things. Refer to the *JFOB Survivability and Protective Construction Handbook*, UFC 4-022-02, AFH 10-222, Volume 14, and AFPAM 10-219, Volume 2 and Volume 7, for more information on constructing berms.

Figure 4.12. Expedient Revetments at Deployed Locations.



4.5. Raised Dikes. Raised dikes are generally used as a means to hold back water or as a spill control measure around fuel storage and distribution areas. In the context of bare base development, only dikes used for controlling fuel spills will be addressed here.

4.5.1. Fuel Dikes. Referred to as either fuel dikes or fuel berms are raised dikes around fuel storage containers designed to contain spills if tanks or bladders rupture or catch fire. They also act as a safety barrier and base defense measure (**Figure 4.13.**).

4.5.2. Engineers tasked to build fuel dikes should work closely with logistics (fuels) specialists responsible for the design and operation of fuel distribution

systems. Consider the following when constructing dikes for Fuels Support Equipment (FSE) refueling units:

Figure 4.13. Fuel Dikes Control Spills and Forms Protective Barrier.



4.5.2.1. The site should be reasonably level and well drained to prevent water damage. Low areas should be avoided to prevent danger of vapor collection. The site should not be placed in low hill areas, rolling country, uphill, or upstream from other installations that would be in the path of escaping fuel. It should also be free of rocks and obstructions.

4.5.2.2. The dike should be placed as close to the aircraft apron as practically possible (**Figure 4.14.**). The ground should be as level as possible with a maximum slope of three degrees to prevent the tank from creeping or crawling. Avoid low areas to prevent accumulation of trapped vapors. Give careful attention to receiving capabilities, such as rail cars, taxiways, and roads. If the site is dependent on aerial bulk fuel delivery system for resupply, positioned the area 100 feet from a parking apron.

Figure 4.14. Fuel Dikes Around Jet Fuel Storage Bladders.

4.5.3. Listed below are several other factors to consider when constructing fuel dikes for fuel storage and distribution areas. **Figure 4.15.** and **Figure 4.16.** illustrates typical dikes or berm layouts for various sized single and multiple fuel bladders.

4.5.3.1. The size or height of fuel dikes should be able to contain the volume of liquid in the fuel bladder within the dike should a rupture occur. Consider adding secondary dikes around the primary dike to catch residual or accidental leakage and spillage due to hose/coupling breaks (**Figure 4.17.**). If secondary dikes are used, the berm liner should be long enough to cover the secondary dike.

4.5.3.2. Roads built around fuel dikes should permit fuel trucks (fueling and de-fueling) to travel over the ground adjacent to the dike. Keep in mind most of the trucks weigh more than 80,000 lbs. If applicable, consider civilian delivery truck weights and turn radiuses when sizing the truck travel area. Refer to AFPAM

23-221, *Fuels Logistics Planning*, and T.O. 37A12-15-1, *Collapsible Fuel Bladders*, for other fuel dike or berm construction details.

4.5.3.3. When setting up a bladder area, ensure all areas can be reached using a fire-fighting vehicle with a top turret throw range of 175 feet. Minimum distance between bladder storage areas should not exceed 150 feet.

Figure 4.15. Typical Berm Layout for a 10K Fuel Bladder.

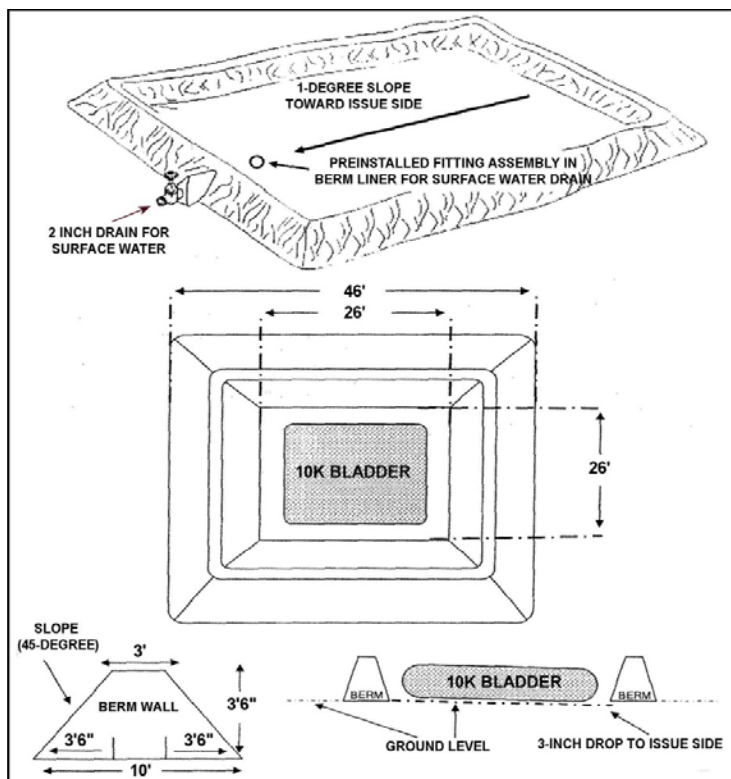

Figure 4.16. Typical Berm Layout for 50K and 210K Fuel Bladders.

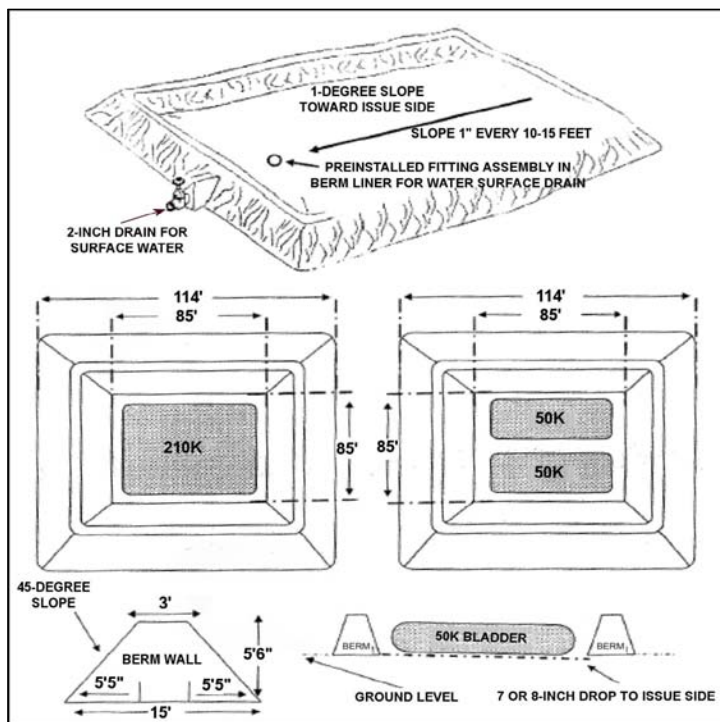
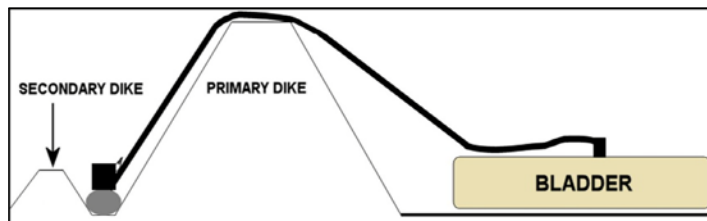

Figure 4.17. Illustration of Fuel Dike with Secondary Dike.



4.6. Ditches. Ditches are generally used during bare base development to enhance or establish proper drainage around the installation's roads, airfield, and facilities (**Figure 4.18.**), but may also be employed as an anti-vehicle barrier to stop vehicles from penetrating the base's perimeter. For specific ditch construction information, refer to FM430-00-1, UFC 4-022-02, and the JFOB Survivability and Protective Construction Handbook.

Figure 4.18 Creating Drainage Ditch to Reduce Road Erosion.



Chapter 5

BARE BASE FACILITIES

5.1. Contingency Construction Standards in Theater. Having adequate bare base facilities is essential to the success of the Air Force's force projection mission. Civil Engineers help provide the required infrastructure to support planned operations and ensure an ample quality of life for base residents. Facilities erected at bare bases must meet certain theater construction standards. Joint Publication 3-34, *Joint Engineer Operations*, indicate the combatant commander (CCDR), in coordination with Service components and the Services, specifies the construction standards (**Figure 5.1**) for facilities in the theater of operation. Beddown or bare base construction standards generally fall into three categories: *organic*, *initial*, and *temporary* construction standards.

5.1.1. Organic construction uses host nation or unit organic equipment, facilities and labor to support deployments lasting up to 90 days. Since construction is time-consuming and often costly, the intent is to seek an alternative to new construction and use a minimum amount of labor and resources, until the arrival of the full engineer capability. Minimal or no land grading or site work, tents and pit latrines are examples of this standard. Although intended for use for up to 90 days, organic construction may be used for up to six months.

5.1.2. Initial construction is also characterized by relatively austere facilities and utilities that require minimal engineer effort. This construction is intended for use during the first six months of a contingency. Wood framed tents with flooring, latrines with sewage lift stations, tactical generators for electrical distribution and portable refrigeration are examples of this standard. BEAR assets are generally categorized as "initial" construction facilities. This connotation, however, does not mean they will be totally replaced after six months; but rather they will be used at the onset of a conflict. It is possible that some of these assets will last several years before needing replacement.

5.1.3. Temporary construction is characterized by facilities and utilities of a more substantial nature. It is used to increase efficiency and sustain operations for at least 24 months and with upgrades for up to 5 years. Wood frame

buildings, bathhouses, commercial electric power and paved roads are examples of the temporary standard.

Figure 5.1. Contingency Construction Standards.

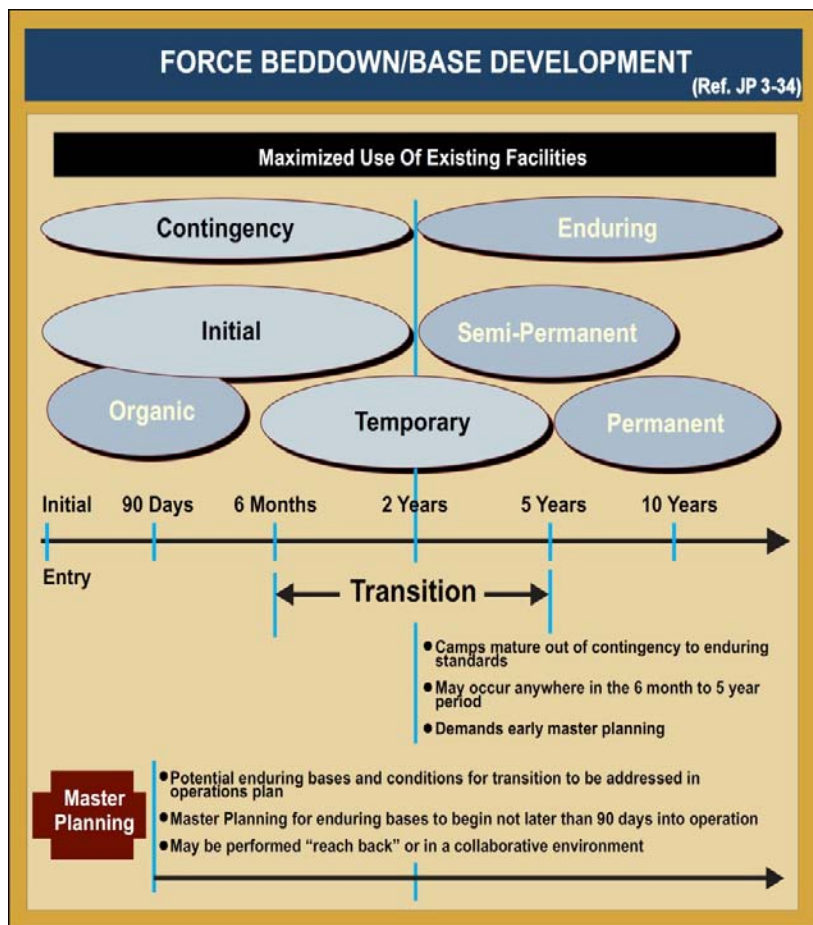

5.2. Facility Assets and Preparation Actions. Successful BEAR facility erection depends on several actions being carried out prior to and during the arrival of personnel at a bare base. Some of these actions are easy to control; others are not easily influenced. The ones easily influenced include the degree of training the base populace has had on erecting BEAR facilities, which could dictate the degree of involvement engineers will have in erecting facilities for other organizations and the arrival timing and sequence of facility assets. Always make the best of your particular situation; for purposes of this handbook, let us assume the base populace is generally knowledgeable in facility erection and assets flow into the base in a reasonable manner.

5.2.1. It is doubtful many people at a bare base will be able to identify all the various BEAR facility and utility components as they arrive. Consequently, engineers will have to accomplish this task since it is an engineer responsibility to place most of these items in service. Supply personnel deployed in support of BEAR help expedite assets as BEAR items arrive. These asset expeditors will assist aerial port personnel in identifying equipment, arrange to have engineer-related items moved from the ramp area to the job site or interim holding area and maintain asset accountability. If a supply representative from the 49th MMG is available, they may be able to help identify BEAR assets as they arrive and assist in maintaining accountability.

5.2.2. Identify a reasonably large open storage area immediately upon arrival at a bare base for temporary storage and eventual longer-term storage for shipping containers. As facility and utility assets are off loaded, they should be separated by type of system or building and moved to the holding area or work site if needed at the time. Any forklift-qualified personnel can assist in moving items if necessary. Plan to have most bare base facilities delivered to the engineer holding area, then to their final location for erection by user personnel as they arrive. Arrange with base supply personnel to consolidate all the shipping and storage containers (**Figure 5.2.**) once empty. If arrangements with supply personnel cannot be made early in the deployment, plan on initially storing these containers in the engineer holding area.

Figure 5.2. Arrange Storage of BEAR Shipping Containers.

5.2.3. As assets are being off loaded from incoming aircraft or vehicles, site layout and site preparation should be well underway. Try to have enough heavy equipment operators on the job so as not to fall way behind the site layout crews. Obviously, this tactic is dependent on equipment availability and the number of other heavy equipment tasks ongoing; however, the speed of facility erection is directly related to the degree of site preparation completed. If the terrain is relatively level, the site preparation task should go faster, if terrain is irregular, size the heavy equipment support accordingly. Look to contract support to fill heavy equipment gaps.

5.2.4. As site layout and preparations continue, begin delivering assets to the job sites; plan on doing this with engineer forces. Have someone use the site layout plan and a general list of facility allocations to oversee this effort.

5.3. BEAR Shelters.

5.3.1. **Small and Medium Sized Shelters.** Virtually all functional areas receive BEAR small shelters like the Small Shelter System (SSS), so delivery of these assets should be reasonably straightforward. On the other hand, use of the

Medium Shelter System (MSS) is unique to certain areas and must be apportioned carefully. Deliver shelter assets as close as possible to final locations to prevent moving them later. Pick up empty ship/store containers when returning to the holding area after delivering assets. This keeps the base less cluttered and protects containers from damage or misuse.

5.3.2. Large Shelters. Large shelters, such as the dome shelter, large area maintenance shelter (LAMS), and frame supported tension fabric shelter (FSTFS), are not erected by users, but rather Prime BEEF or RED HORSE teams with support from the 49th MMG large structures team. These organizations can handle the movement, unpacking, and erection of these larger facilities since they have the requisite training and skills.

5.3.3. Miscellaneous and Legacy Shelters. Some miscellaneous and legacy shelters still in use include the Expandable Light Air Mobile Shelter (ELAMS), General Purpose (GP) Shelter, Expandable Shelter Container (ESC), and the Aircraft Hangar (ACH). They are used for multiple purposes at deployed locations worldwide.

5.3.4. From an engineer aspect, a basic premise of bare base development is that users will erect their own facilities, thereby freeing engineer personnel for other, more critical beddown tasks. This does not mean engineers provide no support at all for facility erection. Plan to erect all Medium Shelter Systems—these are probably too complex for most base organizations to handle. Plan to have a small cadre of personnel knowledgeable on erection techniques for Small Shelter Systems to assist the base populace. There will be occasions where untrained people will be faced with facility erection tasks and engineers must be prepared to offer supervisory and instructional guidance. However, base populace must not attempt utility connections to facilities. The potential for damage to system components and harm to both base personnel and electrical crews is too great.

5.3.5. The facilities outlined in **Table 5.1.** are typically used to support various base functional areas. However, senior personnel determine final facility allocation locally. Make sure the base and wing command staffs are involved. Refer to AFH 10-222, Volume 2, for details and descriptions of BEAR shelters.

Table 5.1. Typical Bare Base Support Facility Allocations.

Function	Type Facility Support
Aviation Operations	Small Shelters, Medium Shelters
Aviation Maintenance	Medium Shelters, Small Shelters, Dome Shelters, Aircraft Hangars
Aircraft Maintenance Additive	Aircraft Hangars
Munitions Maintenance	Medium Shelters, Small Shelters
ADR	Small Shelters, Aircraft Hangars, Medium Shelters
Supply	Small Shelters, Dome Shelters
Transportation	Small Shelters, Dome Shelters
Engineers	Small Shelters, Medium Shelters
Aviation Admin, Aviation Supply, Aviation Intelligence, Aviation Medical, Headquarters, OSI, Intelligence Additive, Weather, Combat Camera, Medical, Postal, Security Police, Information Management, Personnel, Finance, Base Operations, Contracting, MWRS, and Fuels Lab (UTC XFBFB).	Small Shelters

5.4. Services Facilities. During bare base development, Services functions generally consist of kitchen, billeting, laundry, and mortuary facilities. While many of these facilities use BEAR small shelter assets and are erected by Services personnel, CE personnel erect the larger facilities, perform site preparation, connect utilities such as power, water, and sewage, and install some of the more complicated equipment items such as water heaters, walk-in refrigeration units and air conditioning units.

5.4.1. **Kitchens.** Two types of kitchen packages are available for bare base development, the standard BEAR 550 Kitchen and the Single Pallet Expeditionary Kitchen or SPEK.

5.4.1.1. The BEAR 550 kitchen is a complete portable food preparation and serving complex. It is designed to serve up to 550 personnel and seat 120 (**Figure 5.3.**). When siting the facility, select a site approximately 200 feet by 100 feet that is relatively level, has good drainage, is free of rocks and underbrush, is sheltered from high winds, and accessible to the rest of the installation. If two BEAR 550 kitchen facilities are configured to serve up to 1100 personnel, select a site that is approximately 300 feet by 300 feet. Refer to Work Package (WP)-005 00, T.O. 35E4-169-31, *BEAR Base Harvest Falcon/Eagle Electric Kitchen with Mess Kit Laundry*, for more information.

Figure 5.3. BEAR 550 Kitchen (550-Personnel).

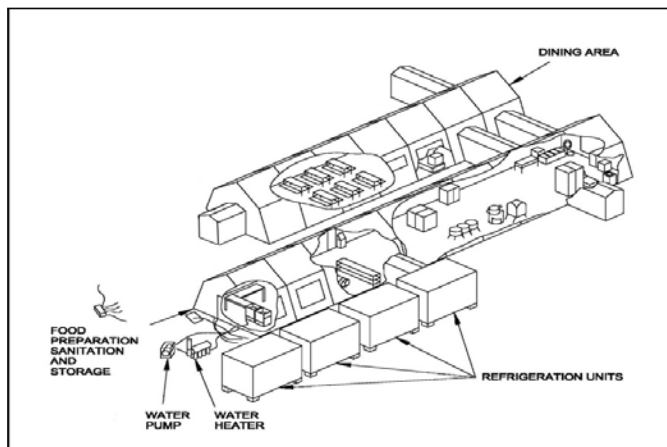

5.4.1.2. The SPEK is a complete food service facility inside an Expandable, Internal Slingable Container Unit (EISU). It is capable of providing hot meals to 500 personnel at a time but does not provide dining or seating space. It requires a clear, level area; ideally, the area underneath the container must be completely clear of all stones and branches, and it must not be placed on any depressions or

sharply raised areas. See T.O. 35E4-235-1, *Single Pallet Expeditionary Kitchen*, for siting and assembly information.

5.4.2. **Billeting (Lodging).** Billeting facilities generally utilize small and medium shelter systems from BEAR housekeeping packages for personnel shelter, showers and latrines, offices, laundries, and storage. However, in some instances, other shelters (including legacy assets) may be used.

5.4.2.1. **Personnel Shelters.** The bulk of personnel shelters are comprised of small shelter systems. These shelters should be sited and erected as discussed earlier in this chapter. It is a good idea to obtain a lodging facility breakout list from Services personnel before siting these facilities. The group breakout list identifies any personnel groups that must be within contiguous billeting blocks (examples: flight crews, officers, females, and foreign military). **Table 5.2.** lists typical breakout groups. The number of personnel planned for each group could affect the layout plan. Spacing and distance for these personnel shelters should be according to specifications in UFC 4-410-01, *DOD Minimum Antiterrorism Standards For Buildings*.

Table 5.2. Lodging Facility Breakout Groups (Typical).

1	Flight crews (by type of aircraft, expected number of aircraft, and crew numbers)
2	Officer and Senior Officers
3	Enlisted and Senior NCOs
4	Men and Women
5	Civilians
6	Foreign Military/Visitors
7	Transient and Permanent personnel
8	Any special shift crews (example: firefighters)
9	Any quarters with requirements for higher security (example: special mission or VIP)

5.4.2.2. **Showers and Latrines.** Portable shower and latrine facilities are included in BEAR housekeeping and flightline operations packages. They are usually housed in small shelter systems and should be sited on a relatively level surface that is free of debris. Refer to T.O. 35E35-5-1, *Field Deployable Latrine Assembly*, T.O.35E35-4-1, *Shower Facility Bare Base*, and T.O. 35E35-3-1, *Shave Stand Bare Base*, for more information.

5.4.3. **Self-Help Laundry.** The self-help laundry (**Figure 5.4.**) is designed for rapid deployment and continuous operation as an efficient field laundry system. The site selected for the laundry facility should be relatively level with adequate drainage. Laundry equipment requires approximately 75 square feet of space inside a small shelter system or legacy tent. Consult T.O. 50D1-4-1 or 50D1-4-11, *Self-Help Laundry*, for more information.

Figure 5.4. Self-Help Laundry (SHL).



5.4.4. **Mortuary.** Most field mortuary operations can use a small shelter system for mortuary collection point (MCP) operations (**Figure 5.5.**). The site also requires the Advanced Design Refrigerator, 300 Cubic Foot (ADR-300), or legacy 150-cubic foot refrigerators for refrigerated storage. The site and facility should be located away from other facilities. It may require a power generator if normal site power is not available during processing. The MCP should also have ample area lighting, a water supply, access for truck and forklift operations, good drainage and runoff protection, and ventilation. Depending on the location

and temperatures, an ECU may be needed during processing. A contaminated waste collection point may also be necessary.

Figure 5.5. Field Mortuary Operation Set Up In Small Shelter System.



5.5. Non-BEAR Facilities. Non-BEAR facilities come in all shapes and sizes and may be from various sources. They may be special field-deployable medical systems, commercial-off-the-shelf (COTS) items, deployable assets from other Services, locally manufactured structures, or pre-designed facilities constructed from the ground up using Class IV construction materials. Whatever the source, Prime BEEF forces are building and supporting bare base and force beddown facilities and structures around the world for Air Force, joint, combined, and multinational operations.

5.5.1. Expeditionary Medical Support (EMEDS) Facilities. Expeditionary medical and dental facilities provide an essential resource to treat (and evacuate, if necessary) casualties under all conditions. These facilities generally utilize SSS or Multipurpose Tent System (MPTS). However, other shelters may also be employed. The EMEDS (Figure 5.6.) are expandable equipment packages that range from a basic, rapid response facility to an Air Force Theater Hospital (AFTH). While medical personnel are trained and experienced in erecting medical facilities, deployed civil engineers provide significant beddown support for these facilities. EMEDS facilities require specific siting and utility requirements. Medical units should be situated in lower threat areas of the base

but as near as practical to force support facilities such as billeting, showers and laundry. In addition to performing site preparations and providing basic utilities like heat, electric, and water, engineers should also consider these factors: (a) emergency back-up power needs; (b) oxygen and vacuum lines, if required; (c) refuse and medical waste disposal requirements; (d) room for possible expansion of MTF facilities; (e) adequate access roads; (f) areas for erection of a radio antenna/satellite; (g) location of latrines (should be in close proximity), and (h) flightline accessibility (incoming/outgoing aeromedical patients).

Figure 5.6. Expeditionary Medical Support Facility.



5.5.2. Commercial-Off-The-Shelf (COTS) Facilities. When required, commercial off-the-shelf (COTS) building systems are procured to meet specific mission requirements. These facilities are usually frame, fabric, and/or steel structures that can be erected rapidly, are cost effective, and generally have a life span that exceeds theater temporary construction standards. These facilities are used as aircraft sunshades and hangars, maintenance buildings, warehouses, and other purposes. While commercial contractors may construct some of these, engineers will likely be required to maintain and repair these facilities. If the facilities are portable, like the aircraft sunshade in [Figure 5.7.](#), Prime BEEF personnel may be tasked to relocate these structures to satisfy operational requirements.

Figure 5.7. Engineers Relocate Aircraft Sunshades.

5.5.3. Force Provider Facilities and Equipment. Army beddown facilities and equipment (referred to as Force Provider) will likely be encountered when deployed to a joint environment, and engineer work crews could be tasked to help beddown troops using these facilities. In some instances, work crews may need to complete site preparation, build access roads, and provide water and power to these facilities. In other situations, crews may be required to erect these facilities. Force Provider assets are similar to Air Force BEAR and legacy equipment assets (**Figure 5.8.**), but there are some variations, and workers should review applicable technical manuals before erecting or maintaining these assets. As shown in **Table 5.3.**, some examples where Force Provider assets differ from BEAR assets includes power production equipment, Reverse Osmosis Water Purification Units (ROWPUs), and latrine and shower units. In addition, there are some differences in the water distributions systems, field laundry configurations, and methods for collecting and treating gray water.

Figure 5.8. Force Provider Assets Similar to BEAR.**Table 5.3. Force Provider/BEAR Assets Comparison.**

Army	Air Force
Army Prime Power Support and 60kW Tactical Quiet Generators	MEP (30, 60, 100kW Generators)
3,000 GPH ROWPU	600 or 1500 GPH ROWPU
Army Water Distribution System	BEAR Water Distribution System
Containerized Batch Laundry	Self-Help Laundry
ISO Container Latrines and Showers	Latrine/Shower Setup in SSS Tents
Gray Water Collection System	Gray Water Field Treatment

5.5.4. Pre-Designed Theater-Constructed Facilities. There are numerous, pre-designed initial, temporary, and semi-permanent facilities intended for OCONUS contingency operations. They include barracks, latrines, administrative areas, hospitals, storage and distribution facilities, and many others. In today's joint environment, Prime BEEF work crews are often tasked to build these and other pre-designed structures (**Figure 5.9.**) Engineering data for pre-designed, theater-constructed facilities are located on the Army Facilities Component System (AFCS) website at www.fcms.net. The AFCS website offers design plans and provides two and three-dimensional drawings of various facilities. Additionally, a 360-degree animated fly-through of selected facilities is available so builders can see what the structure looks like before it is constructed.

Figure 5.9. Building Army Shower Facilities at an FOB.



5.6. Cryogenics Facilities. Cryogenics (Liquid oxygen and liquid nitrogen) storage and servicing facilities (**Figure 5.10.**) have specific siting requirements and should be part of initial base planning. Air Force Occupational Safety and Health Standard (AFOSHSTD) 91-67, *Liquid Nitrogen and Oxygen Safety*, lists siting and safety requirements for liquid oxygen (LOX) and liquid nitrogen (LIN

or LN₂) facilities. Because of the special hazards associated with LOX and LIN, exercise care when siting these facilities. A paved road is required to and from the facility for delivery, maintenance, and emergency vehicles according to AFI 23-201, *Fuels Management*, and the area around the Cryogenics facilities where spills are most likely to occur (i.e., storage tanks, receiving and servicing area, and servicing cart parking areas) should be concrete with non-petroleum based sealant between the joints. Utility services (water, electricity and sewage) should also be coordinated with the installation civil engineer.

5.6.1. LOX storage facilities having a capacity of 100 gallons or more will conform to the minimum separation distances in AFOSHSTD 91-67 (shown in [Table 5.4.](#)), and the facility must be permanently placarded to indicate “OXYGEN-NO SMOKING-NO OPEN FLAMES” or an equivalent warning.

5.6.2. Further information can be found in the Air Force 32-series publications (Civil Engineering) and T.O. 00-25-172, *Ground Servicing of Aircraft and Static Grounding/Bonding*. Additionally, consult AFI 23-201, for information on security fencing and lighting requirements.

Figure 5.10. Liquid Oxygen Storage and Servicing Facility.



Table 5.4. LOX Facility Minimum Separation Distances.

LOX Separation Distances	
Fifty feet from flammable liquid or gas storage.	<input checked="" type="checkbox"/>
Fifty feet from any type “C” combustible structure.	<input checked="" type="checkbox"/>
Twenty-five feet from any type “N” noncombustible structure.	<input checked="" type="checkbox"/>
Twenty-five feet from property lines.	<input checked="" type="checkbox"/>
Twenty-five feet from sidewalks, roadways, or vehicle parking areas.	<input checked="" type="checkbox"/>
Fifty feet from railroads.	<input checked="" type="checkbox"/>
Seventy-five feet from aircraft parking, fueling, or defueling areas.	<input checked="" type="checkbox"/>
Liquid oxygen carts for servicing aircraft will be parked according to T.O. 00-25-172.	<input checked="" type="checkbox"/>

Chapter 6

EXPEDIENT HYGIENE AND SANITATION FACILITIES

6.1. Expedient Field Facilities. Sometimes during contingencies or in the early stages of bare base deployments, deployable hygiene and sanitation kits may not be readily available. Additionally, even when BEAR assets begin to arrive, there may be some locations on the base that still need expedient facilities because certain areas may be too far from main utility networks or the quantity of deployable assets may be insufficient to cover all worksites. In most cases, engineer support will be required to construct various types of field hygiene and sanitation facilities (**Figure 6.1**). Expedient facilities could include any of the following: latrines, urinals, hand-washing stations, shower and shaving stations, and water-heating or mess kit cleaning devices. Construct these facilities when no other practical options are available or permitted. In addition to procedures addressed here, refer to FM 21-10, *Field Hygiene and Sanitation*, AFH 10-222, Volume 4, *Environmental Guide for Contingency Operations*, and AFPAM 10-219, Volume 5 and Volume 7, for additional details on expedient hygiene and sanitation facilities.

Figure 6.1. Field Expedient Latrine Often First Sanitation Facility.



6.2. Expedient Latrines. Expedient latrines are basic versions of either pit or above-ground drum type latrines. They are normally collocated with urine tubes and hand-washing stations. Even commercial portable latrines like that shown next to the hand-constructed latrines in **Figure 6.2.** can be considered a drum type latrine because it must be emptied after some period of use—albeit by contractor personnel. In general, expedient latrines are intended for temporary use until suitable facilities are erected or an existing sanitary sewer system is being rehabilitated. See **Attachment 6** for the pros and cons of the various types of expedient field latrines.

Figure 6.2. Commercial Latrines Used Alongside Field Latrines.



6.2.1. Pit Latrines. Normally there will be a central latrine within the camp or beddown area. The number of latrines and locations will increase as the population grows. Basic pit latrines consist of digging a pit with a minimum depth of six (6) feet and providing various convenient facilities for depositing human waste. Often the earth removed from the pit is placed next to the pit so waste can be covered with earth periodically to control insects and odor. Normally, when the pit is filled to within three (3) feet of the surface, a new pit is dug and the old pit is covered with the remaining soil, treated with insecticide, and appropriately posted closed. Once closed, immediately remove latrine structure from over the pits and update base maps to show location of closed pits. The types of pit latrines presented in this section are limited to areas where

the groundwater table is deep enough to prevent groundwater contamination or water standing in the latrine pit. They are also limited to areas that are free of impervious rock formations near the surface. Several alternatives are available for locations where a high groundwater table or a rock formation near the surface prevents digging a pit of adequate depth. Examples are presented in **paragraph 6.2.2.**

6.2.1.1. Straddle Trench Latrine. A common type of multiple-user pit latrine for temporary use (one to three days) is the straddle trench or straddle-pit latrine (**Figure 6.3.**). A straddle trench latrine is usually dug 1 foot wide, 2 1/2 feet deep, and 4 feet long. In this configuration, it will accommodate two people at the same time. Another version of the straddle trench latrine with individual pits and privacy partitions is shown in **Figure 6.4.**

6.2.1.1.1. As shown in both figures, there are no seats with this type of latrine. Instead, boards may be placed along both sides of the trench to provide better footing. Place toilet paper on a suitable holder and protect it from inclement weather with a tin can or other covering. Remove the earth and pile it at the end of the trench so each individual can properly cover his excreta and toilet paper.

Figure 6.3. Straddle Trench Latrine without Partitions.

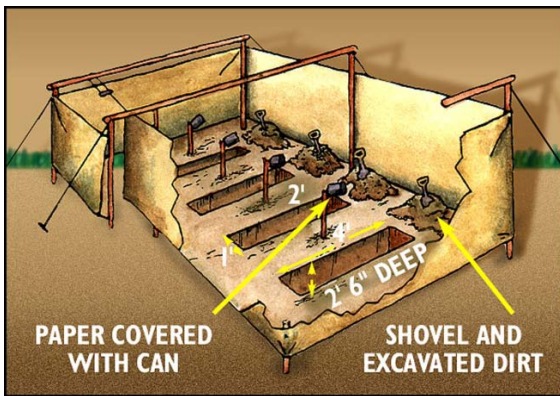
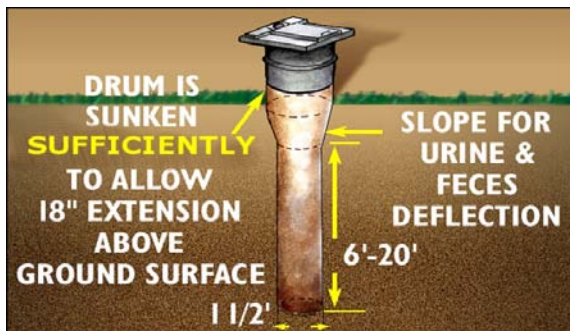

Figure 6.4. Straddle Trench Latrine with Partitions.

6.2.1.2. Bored Hole Latrine. A bored-hole latrine consists of a hole that is about 18 inches in diameter and 15 to 20 feet deep. As indicated in **Figure 6.5.**, a one-hole latrine box covers it. The actual diameter is not critical, and is usually determined by the size of the largest available auger. A metal drum (with both ends removed) placed into the ground serves as a box. A fly proof seat cover with a self-closing lid is fitted for the top of the drum. An 18-inch high wooden box is sometimes used when a metal drum is not available. A bored hole latrine is satisfactory for small groups.

Figure 6.5. Bored Hole Latrine.

6.2.1.3. Deep Pit Latrine. The deep pit latrine is used for longer periods of time and in built-up areas. As shown in **Figure 6.6.**, it is used with a latrine box. The standard latrine box has four seats, and is 8 feet long and 2 1/2 feet wide at the base. A unit of 100 men requires two four-seat latrine boxes. To prevent flies from breeding and to reduce odors, keep the latrine box clean, the seat lids closed, and the cracks sealed. Maintain a good fly control program in the area. Applying lime to the pit contents or burning it does not effectively control flies or odor. The box and latrine seats should be scrubbed with soap and water daily. **Note:** If the ground is too hard for digging, or if the water table is too high, use a pail latrine or a burnout latrine instead.

Figure 6.6. Deep Pit Latrine.

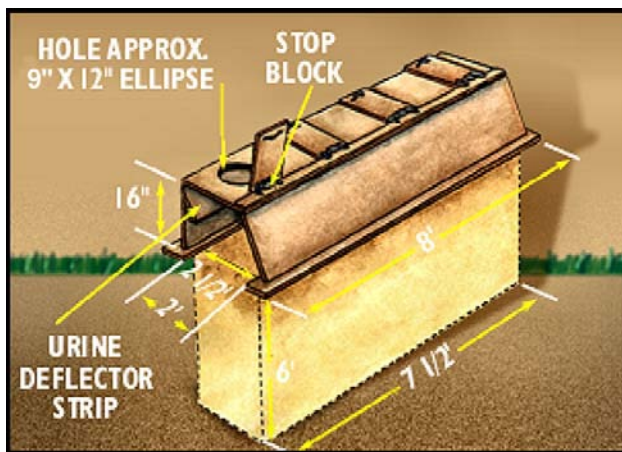

6.2.1.4. Mound Latrine. As illustrated in **Figure 6.7.**, a dirt mound makes it possible to build a deep-pit latrine without the pit extending into water or rock. The mound latrine should be fly-proofed and enclosed as described for deep pit latrines. **Note:** The size of the mound base depends on the type of soil in the area. A larger mound will be likely be required if the slope is steep. It may also be necessary to build steps up a steep slope.

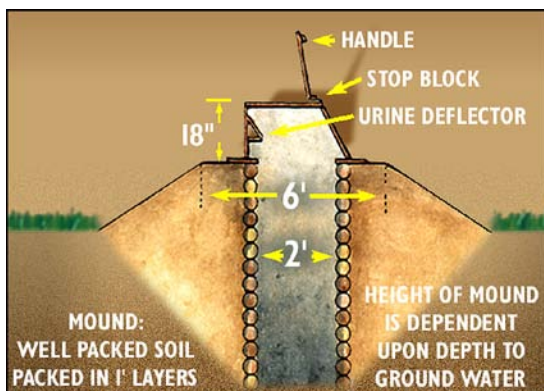
Figure 6.7. Mound Latrine.

6.2.1.5. **Cat Hole Latrine.** The simplest of all field human waste disposal devices is the cat hole latrine (**Figure 6.8.**). This latrine is used by individuals on the move or when on patrol (if individual waste collection bags are not available) and is covered immediately after use. It is also used in situations when individual chemical toilets and other latrine facilities are not available. After use, replace and repack the removed soil.

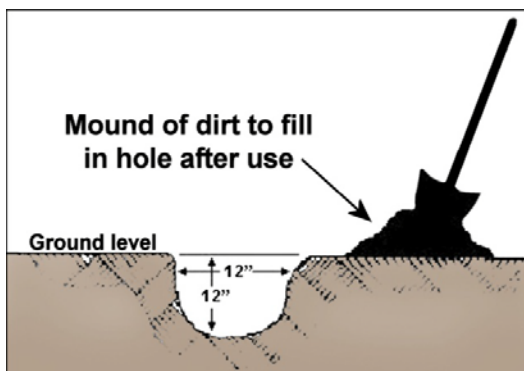
Figure 6.8. Cat Hole Latrine.

6.2.1.6. Cross Tree Latrine. Another very basic latrine is the cross tree type (**Figure 6.9.**). One latrine will usually serve the needs of 6 to 8 people. As might be expected, the latrine is situated downwind from the encampment area, but not so far from the shelters as to encourage individuals to break sanitary discipline. In areas where it is difficult to dig a pit, ration boxes or similar material should be used to collect waste. A urinal, designated for each shelter, should also be located within 4 to 5 meters (4 to 5 yards) of the shelter. A windbreak of boughs, tarpulins, ponchos, or snow wall can be constructed to provide both privacy and protect the latrine from the wind.

Figure 6.9. Cross Tree Latrine.

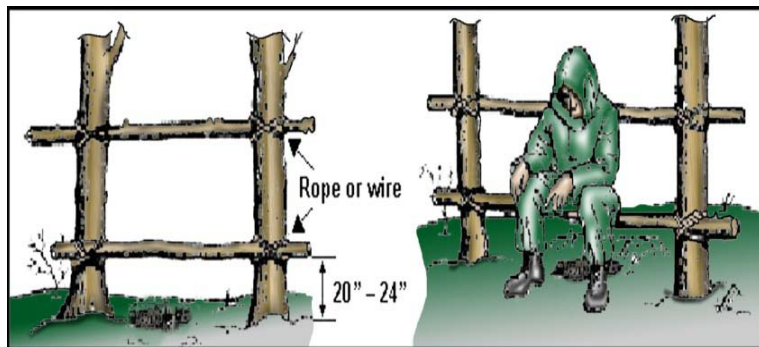

6.2.2. Drum and Pail Latrines. Drum and pail latrines are often used when the groundwater table is high and ground-water contamination or water standing in the latrine pit is probable. They are also ideal when an impervious rock formation is close to the surface, preventing adequate dispersal of liquids.

6.2.2.1. Burn Out Latrine. A burn out latrine is particularly suitable for areas with high groundwater tables. It is also useful in desert regions where an impervious rock layer lay a short distance under the sand. When using this technique, ensure the burning location is downwind of the base camp. For a unit of 100 men and 100 women, at least eight men's latrines and eight women's latrines are needed. As illustrated in **Figure 6.10.**, a 55-gallon is used for a basic burn out latrine drum (sometimes cut in half to make two latrines). Handles are

welded to the sides of the drum so two people can carry it with ease, because drums must be moved before the contents are burned. Have two sets of drums, if possible, so one set can be used while the other set is being burned out. Encourage male personnel to urinate in a urine disposal facility rather than a burn out latrine because more fuel is required to clean a latrine with a liquid content. Burn the contents of each drum daily by adding sufficient fuel to incinerate the fecal matter. Do not use highly volatile fuel because of its explosive nature. A mixture of 1-quart of gasoline to 5 quarts of diesel oil is effective; nevertheless, use it with caution. Burn the contents again if they are not rendered dry and odorless in one effort. Once the burning process is complete, bury the residual ash.

Figure 6.10. Basic Burn-Out Latrine.

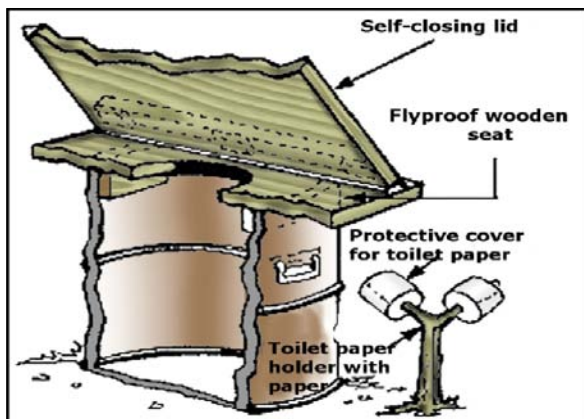

6.2.2.2. Pail Latrine. Pail latrines can be used when conditions (populated areas, rocky soil, marshes) are such that a latrine cannot be dug. A standard, deep pit latrine box is used with a pail under each seat (**Figure 6.11**). Urinals should also be available in male latrines with a drainpipe leading to a pail outside. Pails should be cleaned at least once daily and bury or burn the contents or dispose of them by another sanitary method.

Figure 6.11. Pail Latrines.

6.2.2.3. **Portable Latrines.** If access to BEAR or similar latrine assets will be delayed during a sizeable deployment or beddown activity; the more substantial portable latrine may serve large groups better than some of the expedient options discussed previously in this chapter. Portable latrines vary, however all are built on the same basic precepts of mobility, adequate ventilation, proper sanitation, and reasonable privacy.

6.2.2.3.1. **Portable Pit Latrines.** For portable pit latrines (**Figure 6.12.**), once the supporting pit is filled, the latrine is simply relocated to another spot, usually in the same vicinity, and the old pit is then filled and closed as discussed previously.

6.2.2.3.2. **Portable Burn-Out Latrine.** Similar to the portable pit latrine, the burn-out latrine variation (with access doors in the rear for removing drums) depicted in **Figure 6.13.** can easily be relocated as needed to accommodate facility expansion or to support remote areas.

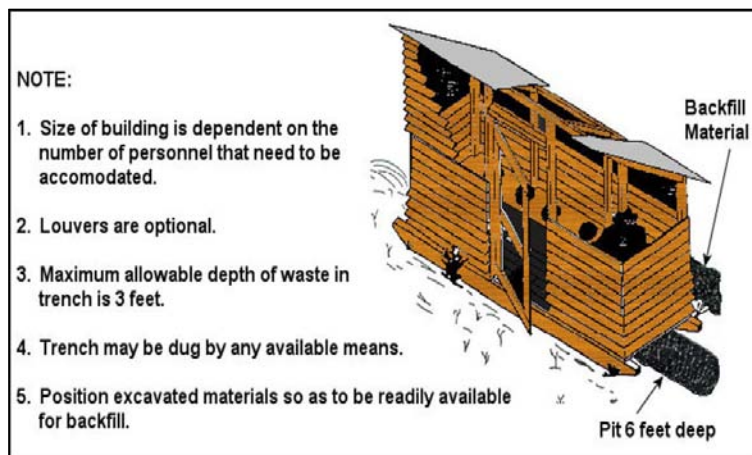
Figure 6.12. Portable Pit Latrine.**Figure 6.13. Portable Burn-Out Latrine.**

6.3. Expedient Urine Disposal Facilities. There are several good reasons to construct separate male urine disposal facilities. One of the more important reasons is to limit the amount of liquid content that accumulates in expedient drum (burnout) or pail latrines. As mentioned previously, waste containers with a high liquid content require more fuel to burn and must be cleaned more frequently than those containing less liquid content. In addition, separating male urine facilities from toilets will help prevent soiling toilet seats and the immediate areas. At least one urine disposal facility is required for each male latrine or per 100 personnel. Below are some examples of expedient field devices used for the disposition of urine. Each facility incorporates a soakage pit to dispose of urine. As a general rule, urinals should always be situated either in or very near latrines that are used by male personnel.

6.3.1. Pipe Urinal. The pipe urinal is one of the most common expedient urine disposal methods. It may be constructed as a single unit or multiple units as shown in **Figure 6.14.** and **Figure 6.15.** Privacy screens should be used where appropriate.

Figure 6.14. Single Pipe Urinal with Privacy Screen.

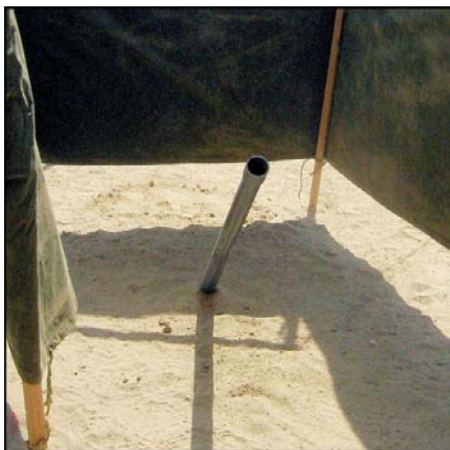
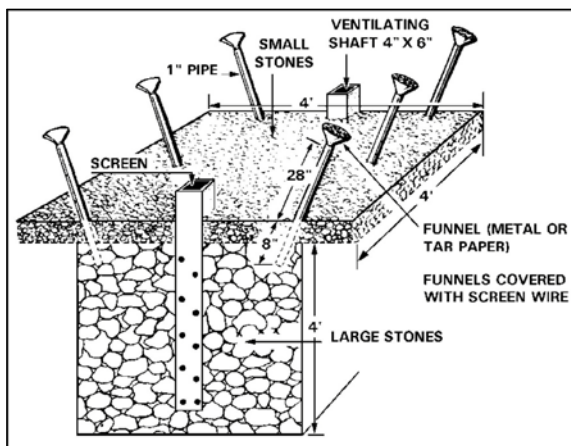

Figure 6.15. Multiple Pipe Urinal Illustration With Soakage Pit.

6.3.2. **Trough Urinal.** If materials are available and facilities that are more permanent are desired, a trough urinal can replace pipe urinals. The trough urinal is normally U-shaped or V-shaped and made of sheet metal or wood (Figure 6.16.). Another expedient trough urinal variation is shown in Figure 6.17.

Figure 6.16. Basic Trough Urinal.

Figure 6.17. Variation of Basic Trough Urinal.

6.4. Expedient Hand-Washing Station. Simple hand-washing devices must be available at field latrine locations. These devices should be easy to operate and have a constant supply of water. As previously mentioned, the importance of hand-washing devices must be given aggressive emphasis because hands contaminated with fecal material are a common means of disease transmission. An expedient hand-washing station can be constructed rather quickly using material that is readily available like that shown in **Figure 6.18.** and **Figure 6.19.** However, stations that are more durable can be assembled using Lyster bags and water cans (**Figure 6.20.**).

Figure 6.18. Simple and Effective Hand Washing Device.

Figure 6.19. Basic Arrangement of Expedient Hand Wash Station.**Figure 6.20. Other Types of Expedient Hand Wash Stations.**

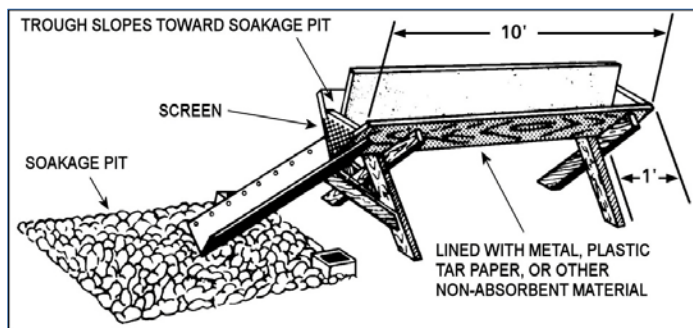
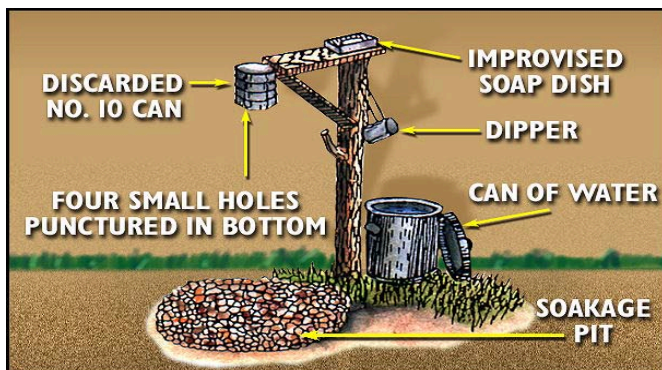
6.5. Expedient Shower and Shave Facilities. Although very important to hygiene, sanitation and quality of life, shower and shave facilities do not represent the critical requirement that latrines do. Recent operations have shown that shower/shave kits will be bumped by higher priority assets for daily intra-theater airlift. Therefore, engineers should be ready to construct field expedient shower and shave facilities with any construction material that may be available

locally. If it is known in advance that showers will be a high priority, pack enough Class IV construction material to build rudimentary showers until BEAR assets arrive. Expedient field showers and washing devices, including various types of water-heating devices, are generally collocated with a base camp to support residents. Engineer personnel are usually responsible for the installation and upkeep of these devices to include disposition of the resulting wastewater.

6.5.1. Expedient Showers. When it comes to bathing in the field, showers have many advantages over bathtubs. Specifically, they use a lot less water and afford much better sanitation. Each field shower will require a soakage pit or trench to absorb discarded water. **Figure 6.21.** is an example of an expedient field shower. **Note:** In some climates, heat from the sun will take the chill from shower and bath water (painting water containers black can absorb more heat from the sun).

Figure 6.21. Expedient Field Shower Facility.

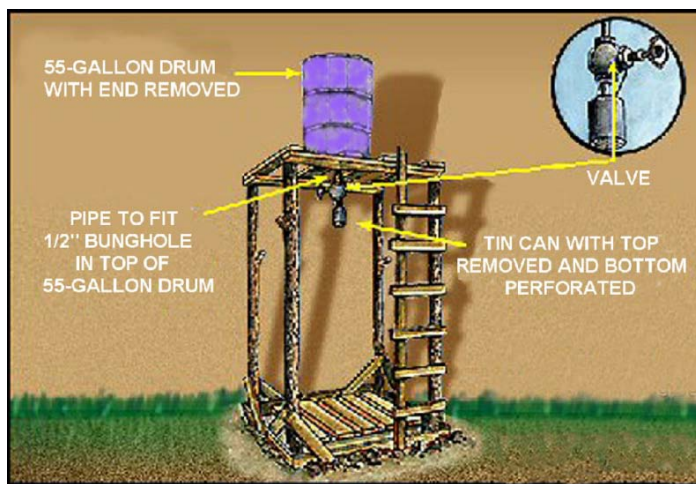

6.5.2. Expedient Shave Station. The likelihood that an expedient shave station would be needed during a bare base deployment is probably remote. However, if needed, a skilled craftsman can easily improvise a shave stand made of wood

with accompanying water can or bucket in very little time. **Figure 6.22.** illustrates how a basic shave station may look. If the station will be used heavily or for an extended period, the addition of a soakage pit to dispose of discarded water and a grease trap to prevent the premature clogging of the pit will be necessary.

Figure 6.22. Expedient Shave Stations.

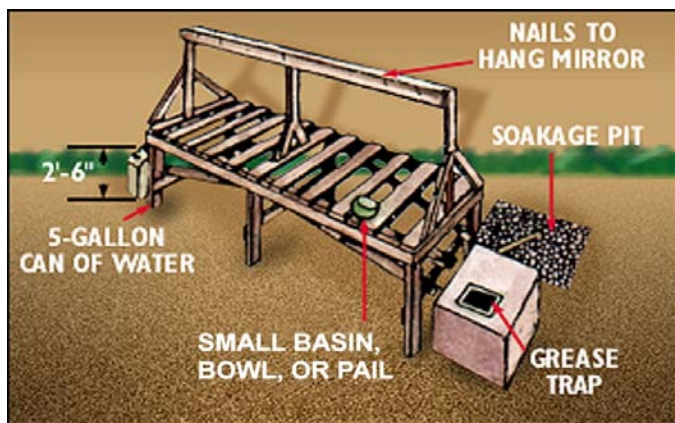

Chapter 7

PEST MANAGEMENT

7.1. General Information. Control of insects, rodents, and associated vermin is important during force beddown. These pests carry disease and quickly spread contamination throughout the airbase if left uncontrolled. The CE pest management team performs critical tasks that help preserve the health and welfare of deployed forces. Primarily, they provide entomological services to rid an installation of pests and help maintain a healthy work and rest environment under austere conditions (**Figure 7.1**). This task includes more than the sensible use of pesticides, but rather a comprehensive, integrated pest management (IPM) program. The IPM approach combines a variety of techniques--including physical, mechanical, educational, biological and chemical--to prevent medical injury or economic damage from pests and disease vectors.

Figure 7.1. Judicious Application of Pesticides Help Control Insects.



7.2. Guidance and Resources. Although AFI 32-1053, *Integrated Pest Management Program*, implements DOD and Air Force pest management policies, it generally applies to Air Force installations in the United States and its territories. For installations outside the United States and its territories, the Overseas Environmental Baseline Guidance Document (OEBGD), the Final

Governing Standards (FGS) for the host country, or theater specific requirements take precedence. The Armed Forces Pest Management Board (AFPMB) is also an important resource. It provides, collects, stores and disseminates published and unpublished information on arthropod vectors and pests, natural resources, and environmental biology important to the DOD. Other products include technical guides (TGs) and country- or region-specific Disease Vector Ecology Profiles (DVEPs), like that illustrated in **Figure 7.2**, for Afghanistan and the South Central Asia region. The [AFPMB TG No. 24, Contingency Pest Management Guide](#), provides basic information on using pesticides to control insects that transmit disease and other pests during field situations worldwide. Information from TG-24 is used extensively in this section. See the AFPMB web site at <http://www.afpmb.org> for this and other contingency-related entomological information.

Figure 7.2. Disease Vector Ecology Profiles (DVEPs).

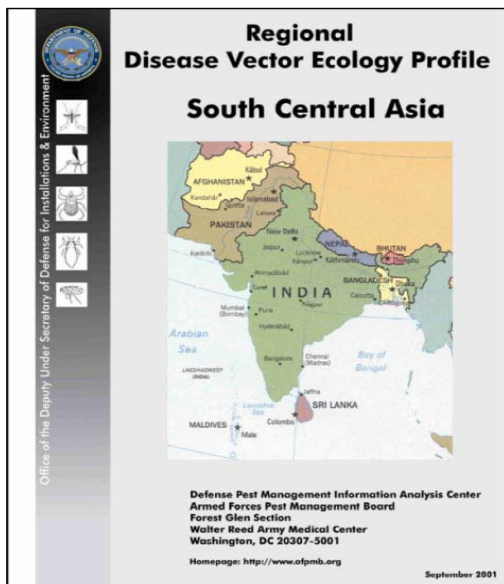

7.3. Safety. When working with pesticides and pest management equipment, safety is paramount. A dangerous temptation during contingency operations is to relax safety requirements. Some people think, “The rules don’t apply here.” Yielding to that temptation can cost you your health and the health of those around you. **Table 7.1.** lists some general safety requirements and precautions that should be observed.

Table 7.1. General Pest Management Safety Checklist.

Item or Activity	Yes	No
Are pesticides only used as part of an IPM program?		
Is proper PPE on hand and utilized IAW pesticide label?		
Do workers adhere to safety requirements and restrictions on pesticide labels?		
Do workers follow all directions, restrictions, and warnings for protecting the general population and non-target organisms?		
Are empty pesticide containers rendered “UNUSABLE” and properly disposed as per label?		

7.4. Sanitation. Good sanitation and proper waste disposal under contingency conditions are the most important principals in combating diseased pests such as filth flies and rodents. Even in mobile field situations, these pests have historically amplified sanitation problems, often causing epidemics of diarrheal diseases. This threat is even greater in urban areas converted to temporary or semi-permanent military use because personnel will not move every day to a different, cleaner area. In this situation, cockroaches may join other pests associated with poor sanitation in compounding the problem, especially in and around structures used for food storage, preparation and consumption, and buildings used for troop housing. All these pests must be controlled, but only in conjunction with efforts to correct the sanitation problems that provide them food, breeding areas, and harborage. Successful pest control requires good sanitation practices be established and maintained. *You can't control pests with pesticides alone.*

7.5. Contingency Pesticides. As previously addressed, the ideal means of pest control is good sanitation and proper disposal of waste materials and garbage. Sometimes that may not be enough to control the pest population, and extermination may be required. Insects are controlled by spraying an insecticide in and around nesting and feeding areas and fogging or spraying throughout the installation. Rodents are controlled with poison baits, trapping, and sealing access points (**Figure 7.3.**). The pesticides found on the AFPMB contingency pesticide list are suitable for contingency use by one or more of the Military Services. A current list is posted to the AFPMB web site at <http://www.afpmb.org/standardlist.htm>.

Figure 7.3. Using Traps to Control Rodent Population.



7.6. Using Pesticides in Foreign Countries. Different rules concerning the application of pesticides may apply in areas outside the jurisdiction of the Environmental Protection Agency. The DOD should follow the FGS for installations in each host country or applicable theater requirements—which ever takes precedence. For NATO operations, STANAG 2048, *Chemical Methods of Insect and Rodent Control*, provides a list of pesticides approved for use by member nations. See AFPMB TG-24 for additional guidance on use of pesticides during contingencies.

7.7. Emergency Procurement of Pesticides/Pest Management Equipment.

Deploying forces often need pesticides and equipment on short notice. The Defense Logistics Agency (DLA) has established an Emergency Supply Operations Center (ESOC) to provide equipment and supplies to deploying forces with urgent requirements and in a timely manner. Use the contact information in **Table 7.2**. The most current list of pesticide dispersal and surveillance equipment is found on the **DOD Pest Management Material list**. All items may be suitable for contingency use by one or more of the military Services. The list contains the most current products and prices.

Table 7.2. DLA Contact Information.

Equipment and Supplies	Contact
For insect repellents, pesticides, pesticide application equipment, and personal protection equipment (bed nets, head nets, etc.) and respirators:	Contact the DLA Customer Interaction/ Contact Center at 1-877-DLA-CALL (1-877-352-2255) or DSN: 661-7766. They are open 24/7 365 days a year for all customer inquiries and submittal of requisitions. Email and related info is listed below: Email Address: DLAContactCenter@dla.mil Phone: 1-877-352-2255 Phone: 269-961-7766 Fax: 269-961-7791 DSN Fax: 661-7791
Information and Assistance	Contact
For technical, quality, logistical, ordering inquires, or questions:	Contact the DLA Chemist/Product Manager at (804) 279-3995/DSN: 695-3995. Normal duty hours are 0800-1700 hours weekdays EST.

7.8. DOD Pesticide Hotline. The DOD Pesticide Regulatory Action System (DOD PRAS) provides the pesticide hotline service as a DOD-wide source for all pesticide-related information and enables DOD personnel to obtain information on pesticide labels, Material Safety Data Sheets (MSDS), recent pesticide regulatory actions, and pesticide use and disposal information. Pre-deployment units can utilize this service to determine the current availability of approved pesticides in the military supply system and to receive recommendations on the availability and suitability of non-standard pesticides for use in the deployed areas. Contact the DOD Pesticide Hotline at (410) 436-3773/DSN: 584-3773, Email at pesticide.hotline@amedd.army.mil.

7.9. Contingency Pesticide Storage. Pesticide storage areas should be isolated from congested areas for reasons of health and safety, fire protection, environmental protection, and security (**Figure 7.4**). The most compelling reason for the isolation of pesticide storage facilities is the fire safety. If a fire occurs in a facility located within or adjacent to an office complex, extensive decontamination of nearby areas from drift of toxic vapors, smoke, liquids, and particulates is required. Designated pesticide storage areas are essential to safely protect and store pesticides and related chemicals. See [AFPMB TG-24](#) for additional guidance.

Figure 7.4. Isolated Pesticide Storage Facility at Deployed Location.



7.10. Transporting Pesticides. Vehicles used to transport pesticides should be single use vehicles and clearly identified as vector control vehicles. If vehicles cannot be designated single use, vehicles used to transport pesticides will NOT be used to transport food, water, or medical supplies. Vehicles will be maintained with a clean and orderly appearance, free from observable pesticide spills, or residues. Vehicles used to transport pesticides will be equipped with a fire extinguisher and a spill kit capable of handling the maximum amount of pesticide transported at any given time.

7.11. DOD Repellents. The best strategy for defense against disease-bearing arthropods includes the application of extended-duration DEET lotion to exposed skin, coupled with the application of permethrin to the field uniform. When used with a properly worn uniform, this system will provide nearly complete protection from arthropod-borne diseases. Additional information on repellents and their application is available in the [AFPMB TG 36](#), “Personal Protection Measures Against Insects and Other Arthropods of Military Significance.”

7.12. Controlling Vegetation with Herbicides. There are specific limits imposed on the use of herbicides during wartime and peacetime, inside and outside the United States. According to Executive Order 11850, *Renunciation of Certain Uses in War of Chemical Herbicides and Riot Control Agents*, 8 April 1975, the United States has renounced first-use of herbicides in war except under regulations applicable to their domestic use on bases or for control of vegetation around the immediate defensive perimeters of bases. Only the President of the US may authorize other wartime uses. Make sure any use of herbicides is according to established procedures and limits.

Chapter 8

WATER AND WASTEWATER SYSTEMS

8.1. General Information. Establishing a viable water and wastewater system is essential to the success of deployed military operations. It has a direct impact on the health, welfare, and morale of the troops. The Air Force's contingency water system (aka BEAR Water System) fulfills both potable water and wastewater recovery needs at austere locations (**Figure 8.1.**). The water system provides water to support kitchens, latrines, showers, laundries, and other bare base facilities and recovers the wastewater for appropriate disposal. Besides the information addressed here, refer to T.O. 40W4-21-1, *Basic Expeditionary Airfield Resources (BEAR) Water System*, AFH 10-222, Volume 11, *Contingency Water System Installation and Operation*, and UFC 3-240-02N, *Wastewater Treatment Systems Augmenting Handbook*, for information on setting up contingency water and wastewater systems. Additionally, consult Bioenvironmental Engineering (BE) in design and development of drinking water systems/processes. The BE flight plays an instrumental role in drinking water quality, treatment, and vulnerability.

Figure 8.1. Typical Contingency Water System Components.



8.1.1. Water Consumption. Water consumption is based on the size of the deployed force and its consumption requirements. Joint Publication 4-03, *Joint Bulk Petroleum and Water Doctrine*, describes essential water requirements as

drinking, personal hygiene, field feeding, medical treatment, heat casualty treatment, personal contamination control, patient decontamination in CBRN environments, and in arid regions, vehicle and aircraft maintenance. When requirements exceed production, all but essential consumption should be reduced. Air Force engineer panels have determined that when mobile water treatment and distribution assets are used, the water-use planning factor is 30 gallons per person per day (gpppd) at a bare base. If a permanent water treatment plant and adequate storage capability are available at the beddown location, a 60-gpppd factor may be used. A breakdown of the 30-/60-gpppd planning factor is shown in **Table 8.1**.

Table 8.1. Water Use Planning Factors.

Functions	Water Usage Factor (gal/person/day)	
Potable Water	Using BEAR	Using Fixed Water Treatment Plant
Drinking	4.0	4.0
Personal Hygiene	3.0	3.0
Shower	3.0	15.0
Food Preparation	4.0	5.0
Hospital	1.0	2.0
Heat Treatment	1.0	1.0
Non-Potable Water	Using BEAR	Using Fixed Water Treatment Plant
Laundry	5.0	14.0
Construction	2.0	2.0
Graves Registration	0.5	0.2
Vehicle Operations	0.5	1.8
Aircraft Operations	2.0	3.0
Firefighting	2.0	4.0
10% Loss Factor	2.0	5.0
Total	30.0	60.0

8.1.2. Wastewater Estimates. Since potable water is often viewed as the most essential element to bare base operations, the disposal of wastewater and other wastes may seem to be of lesser importance. On the contrary, unless wastes of all types are quickly and properly disposed of, unsanitary conditions may quickly develop. Flies, mosquitoes and rodents can overwhelm a bare base, spreading disease with them. The wastewater disposal elements of the BEAR water system use the same concept as a typical municipal wastewater system. Wastewater is collected and transported via hoses to a centralized treatment area. The wastewater receives the equivalent of secondary treatment before being discharged for disposal. Setting up this system takes time. Until the BEAR water system is operational, wastewater should be picked up at the point of generation by wastewater removal trailers. These trailers are discharged away from the base or into the lagoon system if one is available. Of the 30 gpppd of potable water provided at a bare base for initial beddown, about 21 gpppd (70 percent) will become wastewater. The information in **Table 8.2.** provides estimated quantities of wastewater generated in a given area.

Table 8.2. Wastewater Sources and Estimates.

Gallons Per Person Per Day (gpppd)		
Source	BEAR Assets	Fixed Water Plant
Latrine	7.7	7.7
Showers	5.0	15.0
Food Preparation	4.0	5.0
Hospital	1.0	1.0
Laundry	2.0	14.0
Total	19.7	42.7

8.1.3. Water Sources. Available water source has a significant impact on water system development. For example, is the water fresh, brackish, or salt water? Does it come from a well, river, lake, ocean, or municipal water supply? How far is the water source from the base? What is the water temperature? These factors determine how much effort and equipment is needed to capture and treat the water during the initial beddown period. In some instances, a road may need to be cleared to the water source or an expedient water intake system may need

to be set up. Even building a temporary dam to create an expedient reservoir could possibly be required. In any case, once the source location is made usable, install and use raw water pumps to retrieve the water (**Figure 8.2.**). If the water production plant will not be located near the water source, it may be necessary to fill bladders, tanks, or other water vessels for transport to the site chosen for the water plant (**Figure 8.3.**).

Figure 8.2. Raw Water Pumps Retrieve Source Water.

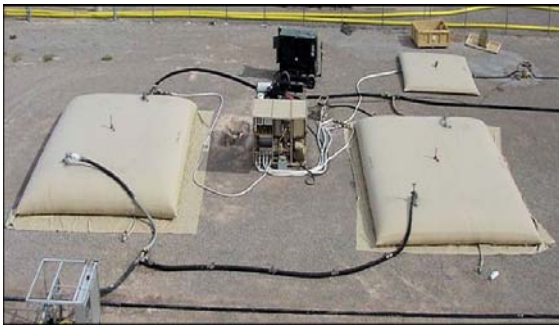

Figure 8.3. Tanker Trucks Used To Transport Raw Water.



8.2. Initial Water Production. Providing essential water to support the anticipated base population and projected mission is a priority-1 task. Complicating the situation somewhat is the fact that the entire contingency water system package is unlikely to arrive at one time early in the deployment. An initial water production package (consisting of two ROWPUs, storage bladders, pumps, hoses, fittings, and power source for standalone operation) is usually the first BEAR water production items received (**Figure 8.4.**). If the source water is located over 500 feet from the anticipated water production location, a Source Run subsystem package may also be included with the initial water package. Take immediate steps to develop water sources, set up water production, and set up potable water storage bladders. Later on, additional BEAR water system assets should arrive to enable installation of a complete water plant, distribution, and wastewater collection system.

Figure 8.4. ROWPU and Water Bladders Included in Initial Water Production Package.



8.3. Water Operations Area (WOA) Site. Wherever the camp is located, there should be enough real estate outside the camp placement area to allow for the Water Operations Area. The WOA is an area identified for the Dual Water Pump Station, Water Tank Farm, and Water Production subsystems. The WOA should be sited on terrain that is relatively flat and free of debris. **Table 8.3.** provides WOA dimensions and the quantity of water production subsystems

required based upon camp population. **Figure 8.5.** shows a typical location for a WOA in relation to the camp facilities layout area.

Table 8.3. WOA Layout Dimensions and Water Production Data.

Camp Populace	Gallons Required Per Day (30 GPPPD)	Tank Farm (TF) ONLY	TF w/600 Water Production Subsystem (WPS)	TF w/1500 Water Production Subsystem (WPS)	600 WPS Quantities 36,000 GPD	1500 WPS Quantities 60,000 GPD
550	16,500	50 x 130	160 x 230	140 x 230	1	1
1100	33,000	80 x 130	160 x 230	140 x 230	1	1
1650	49,500	160 x 130	250 x 230	140 x 230	2	1
2200	66,000	160 x 160	250 x 260	210 x 260	2	2
2750	82,500	160 x 190	340 x 290	280 x 290	3	2
3300	99,000	160 x 190	340 x 290	280 x 290	3	2
4400	132,000	200 x 220	430 x 320	350 x 320	4	3

Figure 8.5. Location of WOA (Typical).

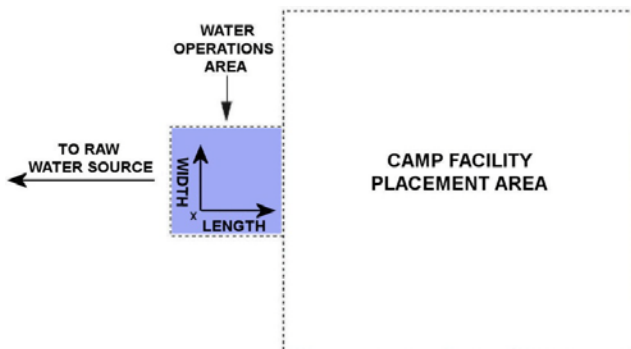

8.4. BEAR Water System. The BEAR water system consists of five distinct subsystems shown in **Table 8.4**. It provides for both potable water and wastewater distribution. The system is modular in design and scalable to meet a variety of user deployment needs. Work crews have the flexibility to configure subsystems to meet their unit's specific needs. In addition to the information addressed in this section, users should also refer to T.O. 40W4-21-1 and AFH 10-222, Volume 11 for more specific layout, configuration, and assembly instructions.

Table 8.4. BEAR Water Subsystems.

WATER SUBSYSTEMS	
1	The Source Run Subsystem (SRS).
2	Water Production Subsystem (WPS) with Reverse Osmosis Water Purification Units (ROWPU).
3	550-Initial Subsystem.
4	550-Follow-On Subsystem.
5	Industrial Operations and Flightline Extension Subsystem.

8.4.1. Source Run Subsystem. The Source Run Subsystem (SRS) provides raw water input (source water) for the contingency water system. It can pull water from a raw water source (i.e., river, lake, sea, or ocean) up to 100 feet away and 20 feet below the pumping station. The SRS can pump source water up to a distance of 6000 feet and to a height of 150 feet to a raw water storage tank.

8.4.2. Water Production Subsystem. The Water Production Subsystem (WPS) generates potable water for distribution to user facilities within the contingency water system. Water purification is accomplished using the 1500 ROWPU and/or 600 ROWPU set up in a parallel configuration. The potable water generated by the ROWPUs is distributed through another series of hoses and fittings to 20,000-gallon potable water storage tanks. A typical water production subsystem layout is illustrated in **Figure 8.6**.

Figure 8.6. Typical Water Production Subsystem Layout.

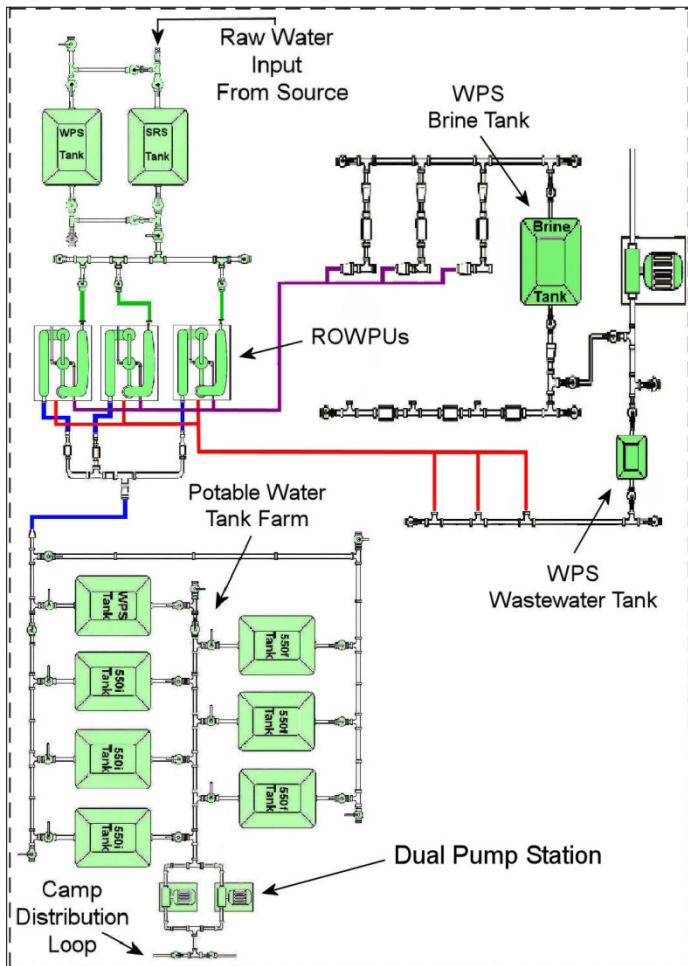

8.4.3. 550-Initial Water Distribution Subsystem. The 550-Initial Subsystem (550-I) is the primary water distribution subsystem of the contingency water system. The subsystem may be deployed as a stand-alone water distribution subsystem; however, it is designed for expansion and buildup to meet varying user deployment and operational needs. The 550-I subsystem normally receives potable water input from the WPS. However, supplied adapters also provide a means to draw water from other similar potable water sources. Potable water input to the subsystem is typically distributed to three 20,000-gallon fabric storage tanks. The water in these tanks is distributed via a variable speed dual pumping station. The two pumps are parallel configured, enabling dual or single pump operation, and single pump isolation for maintenance or repair purposes. Either pump is capable of maintaining water pressure within the loop distribution line.

8.4.4. 550-Follow-On Water Distribution Subsystem. The 550-Follow-On Subsystem (550-F) expands and builds off the 550-I subsystem; it is not intended to function alone. When used as an expansion to the 550-I subsystem, this system functions identically to the 550-I.

8.4.5. Industrial Operations and Flightline Extension Subsystem. The Industrial Operations and Flightline Extension Subsystem is a potable water expansion subsystem for the 550-Initial, 550-Follow-On, or Water Production Subsystems. The extension subsystem can branch off any part of the 3-inch pressurized feed line from these systems, and can supply potable water to isolated user facilities such as latrines, showers, and kitchens. Additionally, hose rollover protection ramps (hose bridges) safeguard hoses in the event potable water distribution lines need to cross roadways or similar heavy vehicular traffic areas.

8.4.6. BEAR Wastewater Distribution. Wastewater output from user facilities is processed by various lift pumps and wastewater lines that distribute the wastewater for disposal. In the layout shown in [Figure 8.7.](#), all wastewater is distributed to a 25,000-gallon wastewater collection tank. The wastewater tank has an aerator and pump to mix and aerate wastewater to maintain liquid state for disposal. In this configuration, it is estimated that the wastewater tank will be required to be pumped out *one or more times per day*. The waste can be sent to a

lagoon, leach field, or treatment plant, etc. In another configuration (Figure 8.8.), only wastewater from latrines and kitchens is routed to the wastewater tank. The remaining wastewater (graywater) from showers and laundries is sent to graywater drying beds. In this configuration, it is estimated the wastewater tank will be required to be pumped out *once every five days*.

Figure 8.7. Total Wastewater Collection Layout (1100-Person Camp).

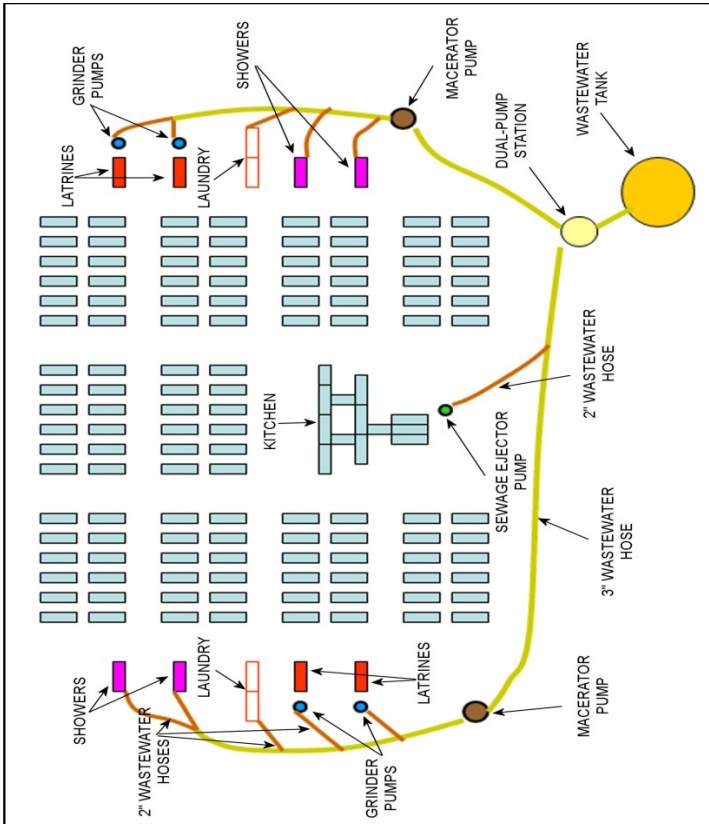
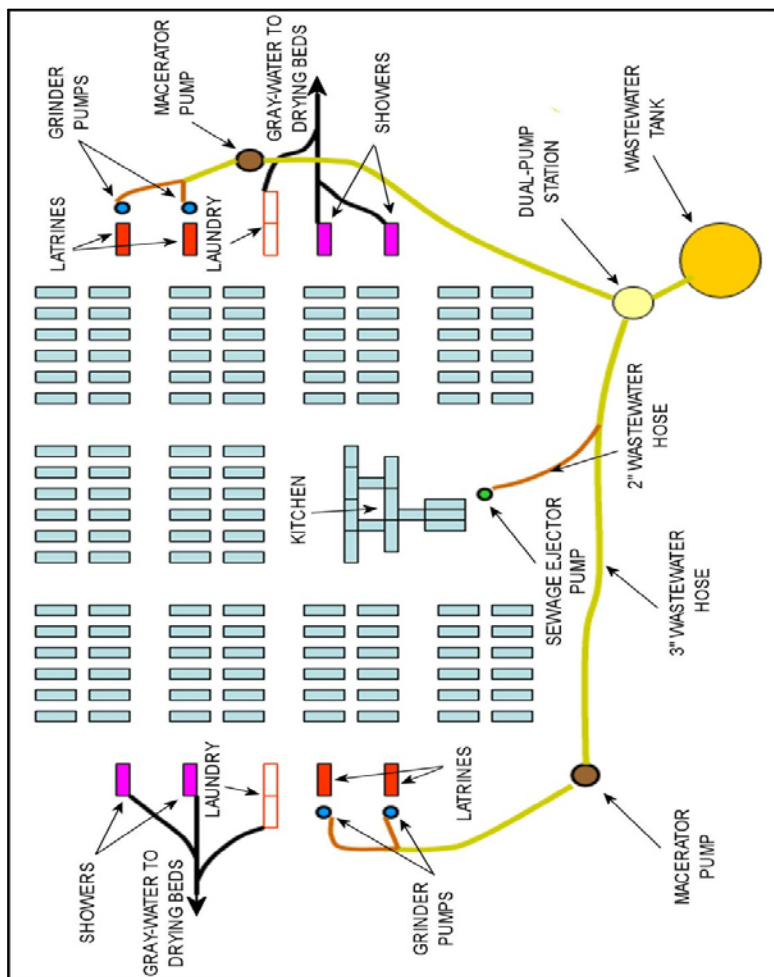

Figure 8.8. Partial Wastewater Collection Layout (1100-Person Camp).



8.5. Wastewater Disposal. Water usage generally results in wastewater that requires disposal. The volume of wastewater alone can cause significant problems in the field, and depending on the source, wastewater may also contain suspended solids and particulate matter, organic material, dissolved salts, biological and pathogenic organisms, and even toxic chemicals. In any case, proper wastewater disposal is essential to protect the health of the force. Deployed units must comply with theater-specific procedures and guidance for wastewater disposal. The following options should be considered:

8.5.1. Connection to an established installation sanitary sewer system.

8.5.2. Collection and retention of wastewater for engineer/contractor removal to a fixed treatment facility.

8.5.3. Engineer construction of semi-permanent wastewater collection and disposal systems.

8.5.4. Use of a field expedient wastewater disposal system, if available.

8.6. Expedient Wastewater Disposal Methods. There are several expedient wastewater disposal methods. Some include evaporation beds, seepage pits, soakage pits and soakage trenches, sewage lagoons and leach fields. Although each of these will be briefly discussed here, refer to UFC 3-240-02N, *Wastewater Treatment Systems Augmenting Handbook*, FM 3-34.471, *Plumbing, Pipe Fitting, and Sewerage*, theater-specific requirements, or other more definitive guidance for detailed procedures and construction information. In addition, **Attachment 7** provides the pros and cons of some of these expedient wastewater disposal methods, including special considerations for disposal facilities in desert environments.

8.6.1. **Evaporation Beds.** Evaporation beds (aka drying beds) are often used to dispose of graywater from shower and laundry facilities in hot, dry climates and where clay soil prevents the use of standard soakage pits. Generally, expedient evaporation beds measure 8 by 10 feet (**Figure 8.9.**), although larger evaporation fields can be constructed to handle greater amounts of graywater as shown in **Figure 8.10.**

Figure 8.9. Typical Evaporation Bed Construction.

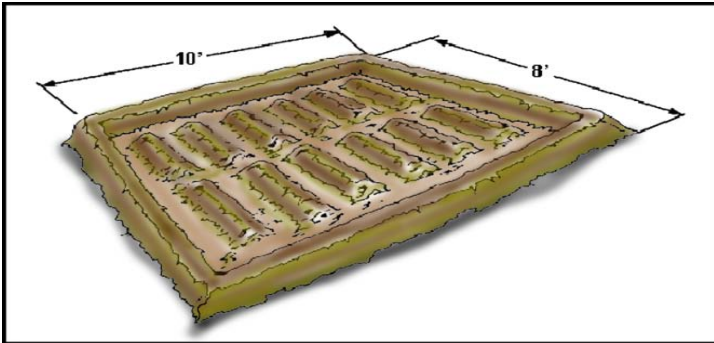

Figure 8.10. Evaporation Field.



8.6.2. Seepage Pits. Seepage pits can also efficiently dispose of wastewater. The required size of a seepage pit can be determined from a percolation test and the estimated amount of effluent from the facility. Several smaller pits for a facility may be more feasible than one large pit. When more than one pit is used, ensure that there is equal distribution of the wastewater to all the pits. The pits should be located outside the base camp and at least 100 feet from the nearest water source.

8.6.3. **Kitchen Soakage Pits and Trenches.** Prior to installation of the BEAR water system, wastewater from kitchens can be disposed of using a kitchen soakage pit or trench (**Figure 8.11.**). Soakage trenches are used when the groundwater level or a rock formation precludes digging a soakage pit.

Figure 8.11. Soakage Trench with Barrel-Filter Grease Trap.

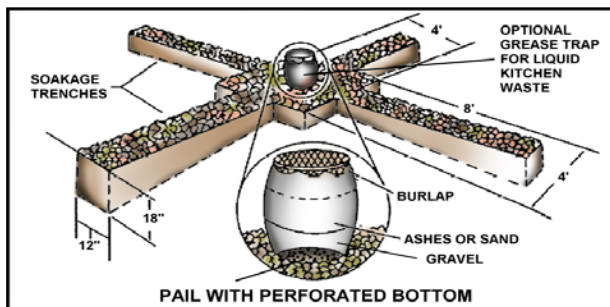

8.6.4. **Barrel-Filter Grease Trap.** There are many types and variations of expedient grease traps. The barrel-filter grease trap is typically used with kitchen soakage pits and trenches (**Figure 8.12.**). The trap is usually placed directly over the soakage pit or on a platform with a trough leading to the pit. However, it can be embedded within a soakage pit as illustrated in **Figure 8.13.**

Figure 8.12. Barrel-Filter Grease Trap Design.

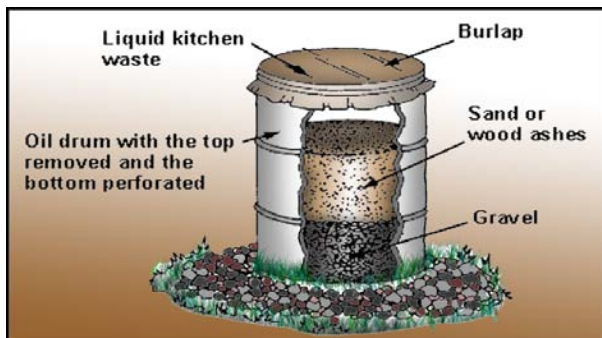
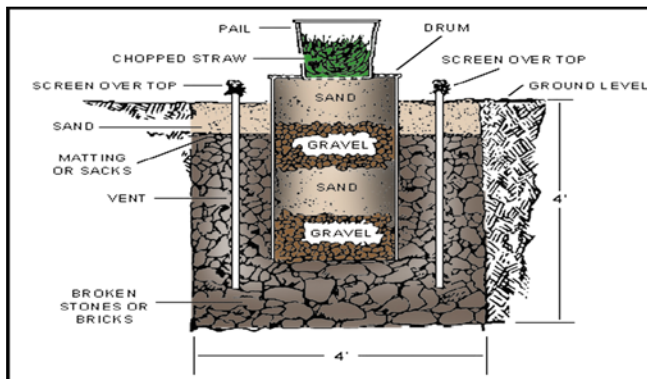

Figure 8.13. Imbedded Grease Trap.

8.6.5. Sewage Lagoons. Sewage lagoons (**Figure 8.14.**) are common throughout the world. Although easy to construct, sewage lagoons are not a recommended theater practice. Sewage lagoons must be located at least *one-half mile* from the population center because of the odors produced by anaerobic digestion. The increased length of the sewer collection system, compounded by the possible need for automatic lift stations, significantly increases the material cost and construction effort required for a complete system.

Figure 8.14. Sewage Lagoon.

8.6.6. Leach Fields. Leach fields (also termed “absorption fields”) are more complicated than wastewater disposal methods previously addressed and they are used in conjunction with septic tank treatment as the final treatment and disposal process for the septic system. Leach fields (**Figure 8.15.**) normally consist of perforated distribution pipe laid in trenches or beds that are filled with rock. The septic tank effluent is distributed by the perforated pipe and allowed to percolate through the ground, where it is filtered and treated by naturally occurring bacteria and oxygen. Once effluent is released from the septic tank, it travels by gravity through a solid PVC pipe to the distribution box. The distribution box is a reinforced concrete structure that distributes the septic tank effluent evenly throughout the absorption field through several 4-inch diameter perforated pipes.

Figure 8.15. Leach Field and Septic Tank Configuration.

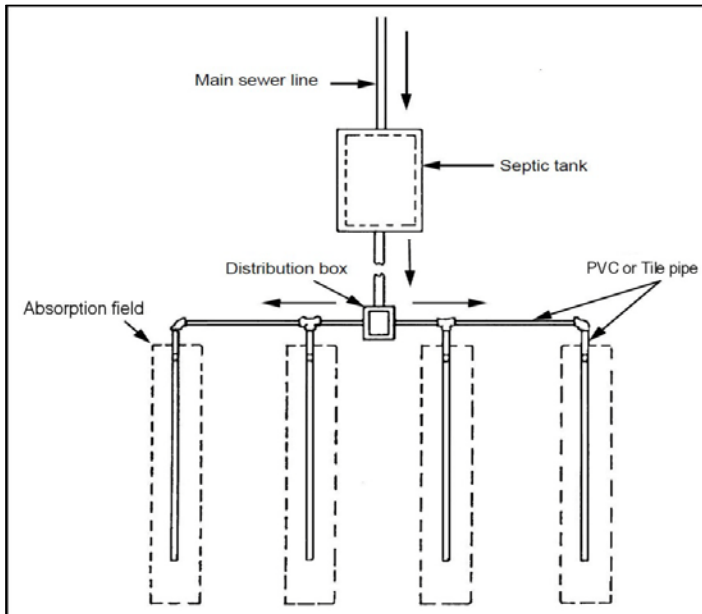

Chapter 9

ELECTRICAL POWER GENERATION AND DISTRIBUTION

9.1. General Information. Developing a bare base electrical power generation and distribution system is a two-phase approach. The first phase is to provide initial power via mobile electric power (MEP) generators to those functions critical to initial base operation. The second and much more complex phase is to establish primary power plants and install the overall base electrical distribution network. It is advantageous to have multi-skilled, and forklift qualified, electrical systems and electrical power production personnel to enable the expeditious, independent, and concurrent completion of these phases. Ensure personnel wear appropriate PPE (including arc flash protection), as required in UFC 3-560-01. In addition, noise hazard and high voltage warning signs should be installed where appropriate.

WARNING

Working on energized electrical equipment is prohibited except in rare circumstances, and then only when justified and approved by the BCE or equivalent in accordance with AFI 32-1064, *Electrical Safe Practices*.

9.2. Mobile Electric Power (MEP) Generators. During the initial base planning and layout stages, precisely identify the locations of mission-critical facilities that require immediate mobile generator support. In most instances, these facilities will also require fulltime emergency or backup power generators; AFI 32-1063, *Electrical Power Systems*, identifies emergency and standby power authorizations. Typical authorized facilities include command and control facilities, air traffic control towers, feeding facility, water plant, communication facilities, and other mission-essential facilities. The bare base Wing Commander has final authority to determine which facilities receive dedicated generator support. Once these facilities are identified and located, electrical power production personnel determine the appropriate size generator for each facility. Almost without fail, there will be more facilities requiring dedicated generator support than there are generators. One way to overcome this problem is to feed

multiple facilities from a centrally located secondary distribution center (SDC) that is power by a single generator. Attempt to place SDCs in positions where they can eventually be integrated into the primary distribution network without having to relocate them. As facilities are erected, electrical personnel connect the secondary service to the facility distribution panels when appropriate. Once mobile generators are online, specifically designate personnel to accomplish regularly scheduled operational checks, recurring maintenance, and establish a refueling plan with base fuels personnel. Anticipate that mobile generators will provide prime power between 10 and 15 days—it may take that long before the base electrical distribution grid is installed and energized.

9.3. Prime Power Plants. Concurrent with installing MEP generators, a team should setup main power plants (**Figure 9.1.**). This effort includes placing prime generators (including Interim Power Units or IPUs), installing and connecting fuel bladders, setting up control panels for remote operation, installing and connecting primary switching centers and installing grounding systems. For information in addition to that addressed here, refer to T.O. 35C2-3-474-1, *Generator Set, Diesel Engine-Driven, Wheel-Mounted 750-KW, 3-Phase, 4-Wire, 2200/3800 and 2400/4160 Volts*, when installation and siting MEP-012A generators.

Figure 9.1. MEP-12 Power Plant.



9.3.1. Centrally located high-voltage generators offer the most advantageous primary distribution system, however, in a high threat area, disperse these generators between prime and slave power plant locations to improve survivability. Multiple power plants and primary distribution loops that interconnect these plants are especially critical in high-threat locations. If a power plant becomes inoperative for any reason, the electrical grid can be energized from the remaining power plant(s).

9.3.2. Diesel generators, which generate hazardous noise levels, should be placed a sufficient distance from work or lodging facilities to prevent personnel injury. If separation distances are an issue, noise barriers or baffles should be installed. Concrete "Bitburg" revetments and earthen berms have proven to be effective in this regard. However, ensure adequate airflow and safety clearances are maintained around the equipment.

9.4. Electrical Power Distribution. The SDC (**Figure 9.2.**) is an integral part of BEAR electrical distribution. It is designed to received regulated electrical power at 2400/4160 VAC, and transform the power into 120/208 VAC. Following the site layout plan, electrical personnel place SDCs at their required locations and begin connecting the SDCs to primary switching centers (**Figure 9.3.**) or legacy primary distribution centers (**Figure 9.4.**) at the power plants.

Figure 9.2. Secondary Distribution Center (SDC).



Figure 9.3. Primary Switching Center (PSC).



Figure 9.4. Primary Distribution Center (PDC).



9.4.1. As facilities are erected, crews make secondary distribution connections between the SDCs and facility power distribution panels (**Figure 9.5.**) and the internal connections of equipment within facilities.

Figure 9.5. Power Distribution Panel (PDP).



9.4.2. For planning and installation purposes use the following “rules of thumb” regarding SDCs:

9.4.2.1. Limit the load on each SDC circuit to 21.6 kVA.

9.4.2.2. Limit the total load on each SDC to 150 kVA.

9.4.2.3. Limit the number of shelters on a SDC to ten when the Field-Deployable Environmental Control Unit (FDECU) is used in each shelter.

9.4.2.4. One MEP-12, 750 kW generator (operating at 80% of its maximum capacity) will support no more than 5 SDCs per one 200-amp PSC/PDC output circuit when facilities are operating at maximum loads with FDECUs.

9.4.2.5. Under normal operating loads, a power plant with at least two generators operating will support 6 to 10 SDCs per PSC/PDC circuit when facilities have FDECUs (**Figure 9.6.**), and 10 to 15 SDCs per circuit when facilities do not have FDECUs.

Figure 9.6. Typical SDC/Facility Configuration with FDECUs.

9.4.3. Several remote area lighting sets (RALS) are included in BEAR unit type codes (UTCs) and most should arrive relatively early in the overall asset flow. Powered by SDCs, RALS (**Figure 9.7.**) support area lighting requirements for such functions as aerial port offloading, aircraft maintenance, POL transfer and security of critical assets. Be prepared to provide electrical support to RALS as soon as these systems come on line. Refer to T.O. 35F5-5-22-1, *Remote Area Lighting System (RALS)* to site, install, and operate RALS.

Figure 9.7. Remote Area Lighting Systems Connect to SDC.

9.4.4. Facilities and SDCs should be sited to optimize both the number of facilities each SDC serves (more is generally better, up to a maximum of 10 with FDECUs or up to 16 without air conditioners as long as the total load does not exceed 150 kVA) and the length of secondary cable runs (shorter is generally better, ideally no more than 150 feet). Refer to T.O. 35CA2-2-17-1, *Operation and Maintenance Manual, Secondary Distribution Center (SDC) 150 KVA (DPGDS)*, for additional SDC installation and siting instructions.

9.4.5. When initially laying prime power (high voltage) electrical cable, if soil conditions or time and equipment constraints prevent its immediate burial, the BCE may make an operational risk management decision to leave some or all of the high-voltage cable on the surface initially. If that is the case, take measures to mitigate the risk of personnel injury or damage to the cables. As a minimum, bury or otherwise protect cables crossing roads and high-traffic walkways. Bring the base onto the electrical grid in stages as the population increases and functional area activities dictate. Whenever the primary electrical grid can pick up facilities served by MEP generators, reconfigure these units as standby or emergency backup power. Obviously, as the primary power plants energized, devote a portion of electrical power production crews to plant operations and maintenance. Once the electrical generation and distribution system is fully installed and operational, bury all aboveground primary power electrical cables (**Figure 9.8.**). See AFH 10-222, Volume 5 for more detailed information on power plant installation.

Figure 9.8. Burying Electrical Distribution Cable.



Chapter 10

SOLID WASTE DISPOSAL

10.1. General Information. Proper disposition of solid waste during and after bare base development can be an overwhelming task. The goal is to dispose of solid waste in an environmentally acceptable manner consistent with good sanitary engineering principles and still accomplish the unit mission. There are many information sources pertaining to solid waste disposal in a deployed environment, and a few general principles are addressed in this chapter. AFI 32-7001, *Environmental Management*, AFI 32-7042, *Waste Management*, UFC 3-240-10A, *Sanitary Landfill*, and AFH 10-222, Volume 4, all provide good solid waste management principles, however, engineers should follow local and theater-specific waste management guidance and procedures.

10.2. Basic Guidelines. Disposal of solid waste is dependent on the location and surrounding environment. Some bases use host-nation contractors to dispose of solid waste, some use on-site facilities, and others use a combination of these methods. Whatever method is used, installations should try to minimize the amount of solid waste that must be disposed of while still satisfying command requirements. Solid waste managers typically use the hierarchy in **Table 10.1.** when making waste diversion and disposal decisions. However, additional considerations may be necessary for overseas contingency operations.

Table 10.1. Waste Diversion and Disposal Hierarchy.

Waste Diversion and Disposal Hierarchy			
1	Source Reduction	6	Incineration with Energy Recovery
2	Reuse	7	Incineration for Volume Reduction
3	Donation	8	Other Forms of Volume Reduction
4	Recycling	9	Landfill Disposal
5	Composting/Mulching		

10.2.1. Disposal methods should be thoroughly planned out and sited (collocated if necessary) for easy use. Waste collection areas should be downwind of base populated areas to prevent nuisance odors.

10.2.2. Improper disposal of waste may contribute to environmental contamination, and accumulated waste could serve as a breeding ground for rodents and arthropods. If on-base locations are created for garbage and refuse disposal, ensure a stringent pest control program is instituted to alleviate the danger or spread of disease. See [Chapter 7](#) for information on pest management procedures and guidance.

10.2.3. Weigh all issues and alternatives before selecting the installation's disposal methods.

10.3. Waste Reduction and Disposal Methods.

10.3.1. **Recycling.** Recycling is an effective means to reduce solid waste disposal streams. Solid waste like high-grade paper, plastic, cardboard, scrap metals, glass, wood cartons, pallets, used oil, tires, batteries, and more can be disposed of without burying or burning. Keep in mind equipment may need to be purchased or contracted to grind, compress, and bundle the recyclables for movement. Materials separated for recycling should be stored so they do not constitute a fire, health or safety hazard or provide food or harborage for vectors. They should also be contained or bundled to avoid spillage.

10.3.2. **Solid Waste Contractors.** Using host-nation contractors can sometimes be the most practical approach to disposing of solid waste. Many expeditionary air bases are located at existing airports near towns and cities with large municipal solid waste disposal operations. While there are clear advantages to using a well-established and proficient local contractor for waste disposal, use of host-nation workers could create security issues. Some installations may address these security issues by using military escorts ([Figure 10.1.](#)) and establish waste collection points outside of key areas; others may establish a solid waste transfer station near a base entry point where waste is picked up by the contractor, thereby denying their access to other areas of the base. The latter method, while more secure, requires significant resources and personnel for on-base waste collection before moving the solid waste to a transfer station.

Figure 10.1. Escorts Monitor Host-Nation Contractors.

10.3.3. Composting. Another method of reducing solid waste, composting is an engineered process that promotes the biochemical decaying of organic material. During bare base beddown, a large percentage of the solid waste is packaging materials (such as cardboard, paper, and plastic), waste food, and sewage sludge. Although plenty of this material is biodegradable, it still presents a significant waste management challenge, especially in countries with few modern waste facilities. When composting, solid waste is usually shredded with most of the nonorganic material removed. The remaining organic material is then arranged into a row and turned frequently to promote decomposition. In addition to disposing of unwanted solid waste, compost can be useful for agricultural purposes and as a cover material on slopes or at sanitary landfills because of its resistance to erosion. If a compost operation is near the airfield, it should be monitored to ensure it does not adversely affect air operations. Installations anticipating establishing a composting operation should comply with DOD Final Governing Standards composting regulations or other applicable theater requirements.

10.3.4. Landfills. Disposing of solid waste in a landfill is a common practice at expeditionary bare bases (**Figure 10.2.**). However, before establishing a new or expanding an existing landfill, units must have the approval of the CCDR.

Landfills at expeditionary bare bases generally fall into two categories, municipal solid waste landfills (MSWLF) or sanitary landfills.

Figure 10.2. Solid Waste Landfills.



10.3.4.1. A MSWLF is a discrete area of land or an excavation, on or off an installation, that receives solid waste like durable goods (e.g., appliances, tires, batteries), non-durable goods (e.g., newspapers, books, magazines), containers and packaging, food wastes, yard trimmings, and miscellaneous organic wastes from residential, commercial, and industrial non-process sources. During landfill operations, work crews should use standard sanitary landfill techniques of spreading and compacting solid wastes and placing daily cover over disposed solid waste at the end of each operating day.

10.3.4.2. Sanitary landfilling is an engineered solid waste disposal process that minimizes environmental hazards and nuisances of land disposal. Solid waste is delivered to a carefully selected and prepared site, deposited into a trench or controlled area, compacted, and covered with soil or other material daily. The sanitary landfill is capable of accepting a wide variety of solid waste types. Nearly all rubbish, garbage, trash, ashes, solid organic waste, and miscellaneous solids may be disposed of safely. This method can also be used in combination with other waste reduction methods for example, incineration, baling, compacting, or shredding.

10.3.5. Incinerator Facilities. In the context of this chapter, an incinerator is defined as any furnace used in the process of burning solid or liquid waste for the purpose of reducing the volume of the waste by removing combustible matter (**Figure 10.3.**). Incinerators must meet published air emissions/air quality requirements. Incinerator operations at expeditionary bases are used generally as a waste reduction method and not a disposal method. However, incineration can be used for energy recovery at more technically sophisticated facilities. Regardless, ash by-product from the incineration process must be disposed of through normal waste disposal methods. Therefore, the incineration facility should be located as close to the waste collection point as possible to simplify the collection process. Although many factors affect the location of an incinerator plant, below are two basic factors:

10.3.5.1. Traffic. Consider the frequency and size of vehicles utilizing the incinerator facility. Access roads should be all-season permanent roads; however, travel on and across primary roads shall be minimized.

10.3.5.2. Location. Select locations that help mitigate noise and odors from the incinerator. Prevailing wind direction should be evaluated to avoid odors being transmitted to residential sites.

Figure 10.3. Incinerator Facility at Forward Operating Location.



10.3.6. Burn Pits. Open-air burn pits are prohibited during contingency operations except when no alternative disposal method is feasible. Open-air burn pits are a short-term solution to reduce the volume of solid waste during contingency operations. Long-term solutions include the use of incinerators and landfills. When used, open-air burn pits will be operated in a manner that prevents or minimizes risks to humans and the environment. Manage open-air burn pits in contingency operations IAW DODI 4715-19, *Use of Open-air Burn Pits in Contingency Operations*.

10.4. Hazardous Waste. Disposal of hazardous waste at expeditionary contingency bases must comply with DOD and HN regulations. Hazardous waste (HW) includes waste that is ignitable, corrosive, reactive, or toxic (especially POL and some chemicals), and requires special handling, transportation, disposal, and documentation. If HW is disposed of using an incinerator, the incinerator must be licensed or permitted by a component HN authority or approved by the DOD Environmental Executive Agent (EEA). Consult with base hazardous materials personnel for guidance and assistance on the handling and disposing of hazardous waste.

Chapter 11

BASE DEFENSE

11.1. General Information. Protection of personnel and assets is always an important task at expeditionary bases. It can be especially challenging when forces are beddown at austere, forward locations that are close to the battle area or areas with a high probability of terrorist attacks. Although absolute protection against all attacks is not possible, protective plans and procedures should be implemented based on the latest threat information. During base development, engineer and security forces (SF) coordinate base defense requirements, establish protection zones, reinforce fighting positions, clear or establish obstacles, and harden base perimeters; all in an effort to protect vital resources (**Figure 11.1.**). Depending on potential threats, engineer work crews can also be heavily engaged in bunker construction and facility hardening activities. Even at low threat locations, workers could be tasked to build FP facilities and structures, because low-threat can easily turn into high threat overnight.

Figure 11.1. CE and SF Coordinate Building of Guard Tower.



11.1.1. Establishing and maintaining certain FP measures are an important base development responsibility. For additional guidance on FP measures and protective construction requirements, refer to UFC 4-010-01, the *JFOB Survivability and Protective Construction Handbook*, AFH 10-222, Volumes 3 and 14, and the theater engineer staff. In addition, detail drawings and construction details for many protective structures can be downloaded from the Theater Construction Management System (TCMS) website at <http://www.tcms.net>.

11.1.2. Overall, base defense measures are designed to protect personnel, facilities, and critical assets. While the actual site work is often the most visible part of FP measures, engineer involvement in the planning process, including site survey and site layout, is equally important.

11.1.2.1. *Site Survey*. During the site survey, learn as much as possible about the region and specific location to assist in selecting a site suitable to beddown the expected population, weapon systems, support equipment, and other assets.

11.1.2.2. *Site Layout*. Ensure FP is addressed and integrated into site layout. If the site layout is not well thought out, it could be extremely difficult and costly to rearrange assets to provide increased protection once beddown is complete.

11.1.3. As expeditionary airbases experience planned and unplanned growth, they typically end up needing additional land and resources. Consequently, every change that increases the base's footprint usually requires modification to local FP measures. Always consider FP requirements when planning future expansion and growth.

11.1.4. Many expeditionary and temporary structures used during contingencies are composed of metal frames and fabric or wood frames and rigid walls, they are generally impractical to harden or retrofit. For this reason, *standoff distance* is the primary approach to FP in the expeditionary environment, which often drives the need for larger sites. Space should be sufficient to allow for dispersal of certain functions and equipment and to provide the commander the flexibility to increase the beddown population and standoff distances if needed in response to higher threat levels.

11.1.5. Although BEAR shelters provide beddown forces with vital temporary protection from the elements at locations with limited infrastructure and support facilities, these same shelters create additional FP challenges for the reasons addressed above. The inherent advantages of lighter, leaner, and more mobile shelters means some tradeoffs in survivability were allowed. Most BEAR facilities cannot withstand even small arms fire, let alone fused munitions detonation (**Figure 11.2**). This makes it imperative that personnel and asset protection be seriously considered at bare base locations, especially in high threat areas. In fact, in serious high threat areas, one of the first tasks might be digging foxholes and protective trenches for personnel protection.

Figure 11.2. Erecting Non-Hardened BEAR Shelter.



11.1.6. BEAR packages also include assets for aircraft protection, such as bin revetment kits addressed in **Chapter 4**. However, because of their weight, do not expect to receive these kits until well into the deployment timeline. In fact, they may even arrive by ship rather than air. Nevertheless, have all parking plans, revetment locations and configurations and fill material sources identified early. Start installing the kits as soon as they arrive.

11.2. Physical Security Measures. A key element of FP is physical security. The two broad areas of physical security that civil engineers might dedicate the majority of time and resources in expeditionary environments include *perimeter security* and *internal security*.

11.2.1. **Perimeter Security.** One of the most important FP tasks civil engineers undertake during the initial stages of deployment and beddown is establishing perimeter security. Working with SF, civil engineers help establish a continuous physical barrier that clearly defines the physical limits of the site to prevent unauthorized access. Perimeter security may include the following:

11.2.1.1. Perimeter berms and ditches (See **Chapter 4**).

11.2.1.2. Perimeter fencing.

11.2.1.3. Obstacles.

11.2.1.4. Terrain modification and vegetation-clear zones.

11.2.1.5. Obscuration screens.

11.2.1.6. Entry control points and search pits.

11.2.1.7. Security lighting.

11.2.1.8. Guard towers/observation posts.

11.2.1.9. Defensive fighting positions.

11.2.2. **Internal Security.** The focus on internal security, from a civil engineer perspective, generally involves establishing protective measures inside the base, and may include the following:

11.2.2.1. Side-wall protection and facility hardening.

11.2.2.2. Dispersal.

11.2.2.3. Compartmentalization.

11.2.2.4. Revetments.

11.2.2.5. Personnel bunkers.

11.2.2.6. Power and water protection.

11.2.3. **Protective Shelters or Bunkers.** When the installation of BEAR assets nears completion, attention should be turned to providing protective shelters or

bunkers for the base populace. These protective structures are intended for short-term use and are generally employed to shelter personnel from the effects of weapon attacks. They may be constructed using prefabricated concrete modular forms, improvised materials, or built by local contractors.

11.2.3.1. Protective shelters may be the only alternative when there are not enough permanently hardened facilities in the right locations—make sure they are sited in areas readily accessible to base personnel. This is especially true in bare base or dispersed operations.

11.2.3.2. The best protective shelter is usually one that provides the most protection but requires the least amount of effort to construct. Shelters should have as much overhead cover as possible. Belowground shelters require the most construction effort but generally provide the highest level of protection from conventional and chemical weapons. Aboveground shelters provide the best observation and are easier to enter and exit than belowground shelters. They provide the least amount of protection from conventional weapons; however, they do provide protection against liquid droplets of chemical agents. Aboveground shelters are used when water levels are close to the ground surface or when the ground is so hard that digging a belowground shelter is impractical. Illustrated in **Figure 11.3.** is one example of a protective shelter currently being used in Southwest Asia.

Figure 11.3. Improvised Bunker Using Concrete Culverts and Sandbags.



11.2.3.3. If necessary, other types of improvised shelters can be constructed using general construction materials. As the base is being established, look for and store such items as 55-gallon drums, pieces of revetment material, structural steel shapes, timber and wood packing materials, ship dunnage, steel or precast concrete culvert sections, CONEX boxes, etc. Unserviceable aluminum matting may be readily available, but must be used with caution since they were not designed to support heavy loads over a large clear span. Do not use BEAR shipping and storage containers for shelter components; they will be needed intact later on for reconstitution of assets. **Figure 11.4.** illustrate an improvised shelter made from general construction materials, sandbags, containers, and other available materials.

Figure 11.4. Metal Culvert Shelter.

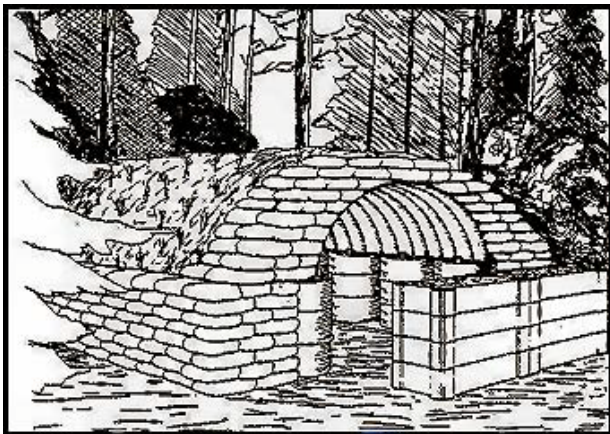

11.2.4. **Defensive Fighting Positions.** Defensive fighting positions are sited in locations that support base defense operations. They are generally positioned around the base perimeter and other areas as needed. They are also used for work party security and in conjunction with dispersed operations. These fighting positions can range from expediently constructed bunkers to elevated hardened observation towers.

11.2.5. Obstacles and Barriers. During bare base development, obstacles and barriers should also be erected/place where needed to support FP requirements. While there are many different types and functions, expedient anti-personnel and anti-vehicle structures will likely be needed at various locations around the base perimeter and at key on-base facilities. One example of a barrier is shown in **Figure 11.5**.

Figure 11.5. Constructing Security Barrier around Flightline.



11.2.6. Berms and Revetments. It may be necessary to build berms and revetments around critical facilities and utility nodes. Although it will be nearly impossible to construct protective features for all candidate locations quickly due to material, time or manpower shortfalls, prioritize your requirements carefully. Look primarily at mission sensitivity. Consider protecting water and power plants early—without these utility services bare base operations will rapidly shut down. Also, consider key secondary distribution centers, maintenance shops, and command posts. See **Chapter 4** for more information on siting berms and revetments.

11.2.7. Clearing Obstacles. In addition to erecting obstacles for FP, removing unwanted obstacles is also an important FP task for engineers. Work crews may need to clear obstacles on or around the airfield or clear terrain along the base perimeter. Especially, in areas where SF need clear areas or vegetation-free

zones for observation or to eliminate possible areas of enemy concealment near the installation's boundary.

11.3. CBRN Defense. The potential for accidental or deliberate release of CBRN agents within the operational area is a major concern. Additionally, the threat of CBRN materials being used against a bare base, either during or after construction, is always present. Engineers are responsible for a number of FP tasks associated with CBRN defense; some of them are listed below.

11.3.1. Coordinate CBRN defense operations.

11.3.2. Layout CBRN defense areas.

11.3.3. Establish CBRN monitoring points.

11.3.4. Establish alerting system and contamination control areas.

11.3.5. Construct and improve personnel shelters.

11.3.6. Determine decontamination procedures.

11.3.7. Site Decontamination Stations.

11.3.8. While emergency management (EM) specialists primarily support all of the CBRN defense tasks listed above, other engineer specialists will also be involved. For example, utilities personnel may need to run water lines to decontamination stations; engineering assistants may be needed to survey potential sites for decontamination stations, contamination control areas and shelters; HVAC personnel could be involved with installing and maintaining collective protection (COLPRO) systems; and heavy equipment operators might have to level terrain or dig drainage ditches for decontamination operations. Nearly every Prime BEEF specialty will somehow be involved in CBRN defense and FP operations.

HERBERT J. CARLISLE, Lt Gen, USAF
DCS/Operations, Plans, and Requirements

Attachment 1

GLOSSARY OF REFERENCES AND SUPPORTING INFORMATION

References

AFDD 3-34, *Engineer Operations*, 19 September 2011

AFDD 4-0, *Combat Support*, 23 March 2005

AFH 10-222, Volume 2, *Guide to Bare Base Assets*, 1 April 2006

AFH 10-222, Volume 3, *Civil Engineer Guide to Expeditionary Force Protection*, 1 May 2008

AFH 10-222, Volume 4, *Environmental Guide for Contingency Operations*, 1 March 2007

AFH 10-222, Volume 5, *Guide to Contingency Electrical Power System Installation*, 1 July 2008

AFH 10-222, Volume 6, *Guide To Bare Base Facility Erection*, 1 July 2008

AFH 10-222, Volume 7, *Emergency Airfield Lighting System (EALS)*, 1 December 2011

AFH 10-222, Volume 8, *Guide to Mobile Aircraft Arresting System Installation*, 1 May 2006

AFH 10-222, Volume 9, *Guide to Reverse Osmosis Water Purification Unit Installation and Operation*, 1 May 1999

AFH 10-222, Volume 11, *Contingency Water System Installation and Operation*, 19 May 2011

AFH 10-222, Volume 14, *Guide to Fighting Positions, Obstacles, and Revetments*, 1 August 2008

AFH 10-222, Volume 16, *Guide for Use of the Minimum Airfield Operating Surface Marking System*, 1 December 2005

AFI 10-210, *Prime Base Engineer Emergency Force (BEEF) Program*,
15 November 2010

AFI 10-211, *Civil Engineer Contingency Response Planning*,
16 November 2011

AFI 10-401, *Air Force Operations Planning and Execution*,
7 December 2006

AFI 10-404, *Base Support and Expeditionary Site Planning*, 11 October 2011

AFI 13-217, *Drop Zone and Landing Zone Operations*, 10 May 2007

AFI 23-201, *Fuels Management*, 1 December 2009

AFI 25-101, *War Reserve Materiel (WRM) Program Guidance and Procedures*,
2 May 2005

AFI 32-1042, *Standards for Marking Airfields*, 27 October 2005

AFI 32-1053, *Integrated Pest Management Program*, 23 June 2009

AFI 32-1064, *Electrical Safe Practices*, 25 May 2006

AFI 32-3001, *Explosive Ordnance Disposal (EOD) Program*,
10 October 2007

AFI 32-7001, *Environmental Management*, 4 November 2011

AFI 32-7042, *Waste Management*, 15 April 2009

AFMAN 32-4005, *Personnel Protection and Attack Actions*, 30 October 2001

AFMAN 33-363, *Management of Records*, 1 March 2008

AFMAN 91-201, *Explosives Safety Standards*, 12 December 2011

AFOSHSTD 91-10, *Civil Engineering*, 1 July 1998

AFOSHSTD 91-67, *Liquid Nitrogen and Oxygen Safety*, 1 October 1997

AFOSHSTD 91-501, *Air Force Consolidated Occupational Safety Standard*,
7 July 2004

AFPAM 10-219, Volume 1, *Contingency and Disaster Planning*, 9 June 2008

AFPAM 10-219, Volume 2, *Civil Engineer Disaster and Attack Preparations*, 9 June 2008

AFPAM 10-219, Volume 3, *Civil Engineer Disaster and Attack Recovery Procedures*, 9 June 2008

AFPAM 10-219, Volume 4, *Airfield Damage Repair Operations*, 28 May 2008

AFPAM 10-219, Volume 5, *Bare Base Conceptual Planning Guide*, 1 June 1996

AFPAM 10-219, Volume 6, *Planning and Design of Expeditionary Airbases*, 1 February 2006

AFPAM 10-219, Volume 7, *Expedient Methods*, 9 June 2008

AFPAM 23-221, *Fuels Logistics Planning*, 22 December 2006

AFPD 10-2, *Readiness*, 30 October 2006

AFPD 10-25, *Emergency Management*, 26 September 2007

AFPD 32-10, *Installations and Facilities*, 4 March 2010

AFPD 32-20, *Fire Emergency Services*, 5 August 2003

AFPD 32-30, *Explosive Ordnance Disposal*, 18 December 2009

AFPD 32-60, *Housing*, 16 September 2005

AFPD 32-70, *Environmental Quality*, 20 July 1994

AFPD 32-90, *Real Property Asset Management*, 6 August 2007

AFPMB Technical Guide No. 24, *Contingency Pest Management Guide*, August 2010

AFPMB Technical Guide No. 36, *Personal Protection Measures Against Insects and Other Arthropods of Military Significance*, October 2009

AFTTP (I) 3-2.12, *Multi-Service Tactics, Techniques, and Procedures for Unexploded Explosive Ordnance Operations*, 1 August 2005

AFTTP (I) 3-2.32, *Multi-Service Tactics, Techniques, and Procedures for Explosive Ordnance Disposal in a Joint Environment*, 1 October 2005

AFTTP (I) 3-2.42, *Multiservice Tactics, Techniques, and Procedures for Nuclear, Biological, and Chemical Defense Operations*, 1 March 2003

AFTTP (I) 3-2.68, *Multiservice Tactics, Techniques, and Procedures for Airfield Opening*, 7 May 2007

Definitive Guide to Bear Base Assets, 49 MMG, 16 December 2009

DODI 4715.19, *Use of Open-air Burn Pits in Contingency Operations*, 15 February 2011

ETL 04-2, *Standard Airfield Pavement Marking Schemes*, 19 July 2004

ETL 06-9, *Arc Flash Personal Protective Equipment (PPE) Requirements for High-Voltage Overhead Line Work at 69 kV (Nominal) or Less*, 15 August 2006

ETL 07-8, *Spall Repair of Portland Cement Concrete (PCC) Airfield Pavements in Expeditionary Environments*, 27 July 2007

ETL 09-2, *Contingency Airfield Pavement Specifications*, 11 March 2009

ETL 09-6, *C-130 and C-17 Landing Zone (LZ) Dimensional, Marking, and Lighting Criteria*, 17 August 2009

Executive Order 11850, *Renunciation of Certain Uses in War of Chemical Herbicides and Riot Control Agents*, 8 April 1975

FM 3-34.471, *Plumbing, Pipe Fitting, and Sewerage*, 31 August 2001

FM 3-34.5/MCRP 4-11B, *Environmental Consideration, Appendix E*, February 2010

FM 5-430-00-1, *Planning and Design of Roads, Airfields, and Heliports in the Theater of Operations—Road Design*, 26 August 1994

FM 5-430-00-2, *Planning and Design of Roads, Airfields, and Heliports in the Theater of Operations—Airfield and Heliport Design*, 29 August 1994

FM 21-10, *Field Hygiene and Sanitation*, 21 June 2000

GTA 90-01-011, *Joint Forward Operations Base (JFOB) Survivability and Protective Construction Handbook*, October 2009

Joint Publication 3-34, *Joint Engineer Operations*, 12 February 2007

Joint Publication 4-03, *Joint Bulk Petroleum and Water Doctrine*, 23 May 2003

STANAG 2048, *Chemical Methods of Insect and Rodent Control*,

T.O. 00-25-172, *Ground Servicing of Aircraft and Static Grounding/Bonding*,

T.O. 35CA2-2-17-1, *Operation and Maintenance Manual, Secondary Distribution Center (SDC) 150 KVA (DPGDS)*, 13 December 2006

T.O. 35C2-3-474-1, *Generator Set, Diesel Engine-Driven, Wheel-Mounted 750-KW, 3-Phase, 4-Wire, 2200/3800 and 2400/4160 Volts*, 11 January 1990

T.O. 35E2-6-1, *Minimum Airfield Operating Surface Marking System (MAOSMS)*, 5 September 1995

T.O. 35E4-132-1, *Bare Base General Purpose Shelter*, 1 September 1976

T.O. 35E4-133-1, *Bare Base 76-Foot Aircraft Maintenance Hangar*, 23 December 2002

T.O. 35E4-169-31, *BEAR Base Harvest Falcon/Eagle Electric Kitchen with Mess Kit Laundry*, 1 May 2006

T.O. 35E4-170-2, *Aircraft Revetment Kit, Type B-1*, 6 May 1982

T.O. 35E4-183-1, *Frame-Supported Tensioned Fabric Shelter*, 11 December 1991

T.O. 35E4-216-1, *Bare Base Dome Shelter*, 30 September 2005

T.O. 35E4-219-1, *Large Area Maintenance Shelter*, 1 March 2010

- T.O. 35E4-235-1, *Single Pallet Expeditionary Kitchen*, 18 June 2010
- T.O. 35E5-6-1, *Tent, Extendable, Modular, Personnel (TEMPER)*, 1 March 1993
- T.O. 35E5-6-11, *Alaska Small Shelter System (AKSSS)*, 1 December 2004
- T.O. 35E5-6-21, *California Medium Shelter System*, 9 March 2000
- T.O. 35E8-2-10-1, *Mobile Aircraft Arresting Systems (MAAS)*, 1 September 2009
- T.O. 35F5-3-17-1, *Lighting System, Airfield, Emergency A/E82U-2*, 1 October 2000
- T.O. 35F5-5-21-1, *Flood Light, Trailer Mounted, Type TF-2*, 1 June 2006
- T.O. 35F5-5-22-1, *Remote Area Lighting System (RALs)*, 29 January 2004
- T.O. 37A12-15-1, *Collapsible Fuel Bladder*, 30 January 2004
- T.O. 40W4-13-41, *Operation Manual—Water Purification, Reverse Osmosis, 600GPH Skid Mounted ROWPU Model WPES-20*, 15 September 1992
- T.O. 40W4-20-1, *Operation and Maintenance Instruction with IPB – 1500 Reverse Osmosis Water Purification Unit (ROWPU)*, 1 April 2007
- T.O. 40W4-21-1, *Basic Expeditionary Airfield Resources (BEAR) Water System PN 3000001*, 1 May 2007
- UFC 3-240-02N, *Wastewater Treatment Systems Augmenting Handbook*, 16 January 2004
- UFC 3-240-10A, *Sanitary Landfill*, 16 January 2004
- UFC 3-250-11, *Soil Stabilization for Pavements*, 16 January 2004
- UFC 3-260-01, *Airfield and Heliport Planning and Design*, 17 November 2008
- UFC 3-270-03, *Concrete Crack and Partial Depth Spall Repair*, 15 March 2001

UFC 3-270-07, *O&M: Airfield Damage Repair*, 12 August 2002

UFC 3-560-01, *Electrical Safety, O&M*, 6 December 2006

UFC 4-010-01, *DOD Minimum Antiterrorism Standards for Buildings*, 8 October 2003

UFC 4-010-02, *DOD Minimum Antiterrorism Standoff Distances for Buildings*, 8 October 2003

UFC 4-020-01, *DOD Security Engineering Facilities Planning Manual*, 11 September 2008

UFC 4-022-02, *Selection and Application of Vehicle Barriers*, 8 June 2009

US Army Center for Health Promotion and Preventive Medicine, Technical Information Paper (TIP) #32-001-0904, *Field Wastewater Management in Desert Environments*, September 2004

US Army Corps of Engineers (USACE) Afghanistan Engineer District (AED) Design Requirements: *Sanitary Sewer & Septic System, Various Locations, Afghanistan*, June 2010

USCENTCOM Reg. 415-1, *Construction and Base Camp Development in the USCENTCOM Area of Responsibility (AOR)*, 15 April 2009

Commercial Operator's Manual Power Tech 4.5/6.8 L. Tier 2 OEM Diesel Engines OMRG33324 Issue 16, February 2004

Agile Combat Support (ACS) CONOPS, 2007

Basic Expeditionary Airfield Resources (BEAR) CONOPS, 2005

Prescribed Forms

No prescribed forms are implemented in this publication.

Adopted Forms

AF Form 847, *Recommendation for Change of Publication*.

Abbreviations and Acronyms

AAS—Aircraft Arresting System

ACC—Air Combat Command

ACH—Aircraft Hangar

ACS—Agile Combat Support

ADR—Airfield Damage Repair

AF—Air Force

AFCESA—Air Force Civil Engineer Support Agency

AFCAP—Air Force Contract Augmentation Program

AFH—Air Force Handbook

AFI—Air Force Instruction

AFMAN—Air Force Manual

AFPAM—Air Force Pamphlet

AFPMB—Armed Forces Pest Management Board

AFOSHSTD—Air Force Occupational Safety and Health Standard

AFPD—Air Force Policy Directive

AFRIMS—Air Force Records Information Management System

AFS—Air Force Specialty

AFTH—Air Force Theater Hospital

AFTTP—Air Force Tactics, Techniques, and Procedures

AGE—Aerospace Ground Equipment

AOR—Area of Responsibility

ARFF—Aircraft Rescue Fire Fighting

BCE—Base Civil Engineer

BE—Bioenvironmental

BEAR—Basic Expeditionary Airfield Resources

BOS—Base Operating Support

CBRNE—Chemical, Biological, Radiological, Nuclear, and High-Yield Explosives

CCDR—Combatant Commander

CEMIRT—Civil Engineer Maintenance, Inspection, and Repair Team

CIP—Common Installation Picture

CoP—Community of Practice

COTS—Commercial-Off-The-Shelf

CRG—Contingency Response Group

DODI—Department of Defense Instruction

DLA—Defense Logistics Agency

EALS—Emergency Airfield Lighting System

ECU—Environmental Control Unit

EEA—Environmental Executive Agent

ELAMS—Expandable Light Air Mobile Shelter

EM—Emergency Management

EMEDS—Expeditionary Medical Support System

EOD—Explosive Ordnance Disposal

EPA—Environmental Protection Agency

ESC—Expandable Shelter Containers

ETL—Engineering Technical Letter

FES—Fire Emergency Services

FDECU—Field-Deployable Environmental Control Unit

FGS—Final Governing Standards

FM—Field Manual

FOB—Forward Operating Base

FOD—Foreign Object Damage

FOUO—For Official Use Only

FP—Force Protection

FSTFS—Frame-Supported Tensioned Fabric Shelter

GP—General Purpose

GPH—Gallons Per Hour

GPM—Gallons Per Minute

GPPPD—Gallons Per Person Per Day

GPS—Global Positioning System

HN—Host Nation

HQ—Headquarters

HVAC—Heating, Ventilation and Air Conditioning

HW—Hazardous Waste

IMT—Information Management Tool

IED—Improvised Explosive Device

IGI&S—Installation Geospatial Information and Services

IOC—Initial Operational Capability

IPB—Illustrated Parts Breakdown
IPM—Integrated Pest Management
ISO—International Organization for Standardization
JFOB—Joint Forward Operating Base
LAMS—Large Area Maintenance Shelter
LBS—Pounds
LOX—Liquid Oxygen
LZ—Landing Zone
MAAS—Mobile Aircraft Arresting System
MAOS—Minimum Aircraft Operating Surface
MOS—Minimum Operating Strip
MAJCOM—Major Command
MEP—Mobile Electric Power
MSS—Medium Shelter System
MSWLF—Municipal Solid Waste Landfill
MTF—Medical Treatment Facility
NAVAIDS—Navigational Aids
NPT—National Pipe Thread
NST—National Standard Threads
OCONUS—Outside the Continental United States
OL—Operating Location
OPR—Office of Primary Responsibility
PDC—Primary Distribution Center

PDP—Power Distribution Panel

POL—Petroleum, Oil, and Lubricants

PPE—Personal Protective Equipment

Prime BEEF—Prime Base Engineer Emergency Force

PSC—Primary Switching Center

PSI—Pounds Per Square Inch

PVC—Polyvinyl Chloride

QD—Quick Disconnect

RALS—Remote Area Lighting System

RDS—Records Disposition Schedule

ROWPU—Reverse Osmosis Water Purification Unit

SEAHUTS—Southeast Asia Huts

SDC—Secondary Distribution Center

SOFA—Status of Forces Agreement

SF—Security Forces

SHL—Self-Help Laundry

SPEK—Single Pallet Expeditionary Kitchen

SRS—Source Run Subsystem

SSS—Small Shelter System

STANAG—Standardization Agreement (NATO)

TCMS—Theater Construction Management System

TEMPER—Tent Extendable Modular Personnel

TF—Tank Farm

- TG**—Technical Guide
- TM**—Technical Manual
- TO**—Theater of Operations
- T.O.**—Technical Order
- TTP**—Tactics, Techniques, and Procedures
- UFC**—Unified Facilities Criteria
- USACE**—US Army Corps of Engineers
- UTC**—Unit Type Code
- UXO**—Unexploded Ordnance
- V**—Volts
- VAC**—Volts Alternating Current
- WOA**—Water Operations Area
- WP**—Work Package
- WPS**—Water Production Subsystem

Terms

Air Force Civil Engineer Support Agency (AFCESA)—A field operating agency (FOA) located at Tyndall Air Force Base, Florida. The Directorate of Readiness Support (HQ AFCESA/CEX) acts as the Air Force program manager for Base Civil Engineer (BCE) Contingency Response Planning.

Bare Base—An installation having minimum essential facilities to house, sustain, and support operations to include, if required, a stabilized runway, taxiways, and aircraft parking areas. A bare base must have a source of water that can be made potable. Other requirements to operate under bare base conditions form a necessary part of the force package deployed to the bare base.

Basic Expeditionary Airfield Resources (BEAR)—Facilities, equipment, and basic infrastructure to support the beddown of deployed forces and aircraft at austere locations; a critical capability to fielding expeditionary aerospace forces. Also known as BEAR, the resources include tents, field kitchens, latrine systems, shop equipment, electrical and power systems, runway systems, aircraft shelters, and water distribution systems needed to sustain operations.

Beddown—A location at which a deploying unit operates during a contingency. It is usually, but not always, in the area of responsibility.

Bitumen or Bituminous—The most common type of asphalt surface placed in the theater of operations.

C-day—The unnamed day on which a deployment operation commences or is to commence.

Chemical, Biological, Radiological and Nuclear (CBRN) Defense—The methods, plans, procedures and training required to establish defense measures against the effects of attack by nuclear weapons or chemical and biological agents.

Collective Protection (COLPRO)—systems protect those inside a building, room, shelter or tent against contamination through the combination of impermeable structural materials, air filtration equipment, air locks, and over pressurization.

Collective Protection Shelter—A filtered air shelter that provides a contamination-free working environment for selected portions of the force such as command and control elements. The shelter allows relief from continuous wear of chemical protective equipment.

Disease Vector—Any animal capable of transmitting the causative agent of a human disease; serving as an intermediate or reservoir host of a pathogenic organism; or producing human discomfort or injury, including (but not limited to) mosquitoes, flies, ticks, mites, snails, and rodents.

Expeditionary Structures—Those structures intended to be inhabited for no more than 1 year after they are erected. This group of structures typically includes tents, Small and Medium Shelter Systems, Expandable Shelter Containers (ESC), ISO and CONEX containers, and General Purpose (GP) Medium tents and GP Large tents, etc.

Integrated Pest Management—A sustainable approach to managing pests by combining biological, cultural, physical, and chemical tools in a way that minimizes economic, health, and environmental risks.

Minimum Aircraft Operating Surface—The minimum surface on an airfield which is essential for the movement of aircraft. It includes the aircraft dispersal areas, the minimum operating strip, and the taxiways between them.

Minimum Operating Strip—A runway which meets the minimum requirements for operating assigned and/or allocated aircraft types on a particular airfield at maximum or combat gross weight.

National Pipe Thread—A U.S. standard for tapered threads used to join pipes and fittings.

Pests—Arthropods, birds, rodents, nematodes, fungi, bacteria, viruses, algae, snails, marine borers, snakes, weeds, and other organisms (except for human or animal disease-causing organisms) that adversely affect readiness, military operations, or the well-being of personnel and animals; attack or damage real property, supplies, equipment, or vegetation; or are otherwise undesirable.

Pest Management—The prevention and control of disease vectors and pests that may adversely affect the DOD mission or military operations; the health and well-being of people; or structures, materiel, or property.

Pest Management Professional. DOD military officers commissioned in the Medical Service or Biomedical Sciences Corps or DOD civilian personnel with college degrees in biological, physical or agricultural sciences whose current job includes pest management responsibilities. DOD civilian employees shall also meet Office of Personnel Management (OPM) qualification standards. Based on assignment, some professional pest management personnel are pest management consultants. (DODI 4150.07)

Pesticide—Any substance or mixture of substances, including biological control agents, that may prevent, destroy, repel, or mitigate pests and is specifically labeled for use by the EPA. Also, any substance or mixture of substances used as a plant regulator, defoliant, desiccant, disinfectant, or biocide. The AFPMB does not review or approve disinfectants or biocides.

Solid Waste—Garbage, refuse, sludge, and other discarded materials, including solid, semi-solid, liquid, and contained gaseous materials resulting from industrial and commercial operations and from community activities. It does not include solids or dissolved material in domestic sewage or other significant pollutants in water resources, such as silt, dissolved or suspended solids in industrial wastewater effluent, dissolved materials in irrigation return flows, or other common water pollutants.

Temporary Structures—Those structures that are erected with an expected occupancy of 3 years or less. This group of structures typically includes wood frame and rigid wall construction, and such things as Southeast Asia (SEA) Huts, hardback tents, ISO and CONEX containers, pre-engineered buildings, trailers, stress tensioned shelters, Expandable Shelter Containers (ESC), and Aircraft Hangars (ACH).

Theater of Operations—An operational area defined by the geographic combatant commander for the conduct or support of specific military operations. Multiple theaters of operations normally will be geographically separate and focused on different missions. Theaters of operations are usually of significant size, allowing for operations in depth and over extended periods of time. Also called TO.

Attachment 2

ENGINEER REACHBACK AND OTHER USEFUL LINKS

Table A2.1. Useful Organizational and Product Links.

Organization and Products Links
Air Force Civil Engineer Support Agency (AFCESA), http://www.afcesa.af.mil/
USACE Protective Design Center (PDC), https://pdc.usace.army.mil/
Air Force Center for Engineering and the Environment (AFCEE), http://www.afcee.af.mil/
Whole Building Design Guide (WBDG), http://www.wbdg.org/
Unified Facilities Criteria (UFC), http://www.wbdg.org/ccb/browse_cat.php?o=29&c=4
Air Force Engineering Technical Letters (AFETL), http://www.wbdg.org/ccb/browse_cat.php?o=33&c=125
Air Force Design Guides (AFDG), http://www.wbdg.org/ccb/browse_cat.php?o=33&c=129
Construction Criteria Base (CCB)—Whole Build Design Guide (WBDG), http://www.wbdg.org/ccb
Air Force Publications and Forms, http://www.e-publishing.af.mil/
Army Publications and Forms, http://www.apd.army.mil/default.asp
Army Facilities Components System (AFCS) / Theater Construction Management System (TCMS), https://www.tcms.net/afcsportal
USACE—Afghanistan Engineer District Design Library, http://www.aed.usace.army.mil/Design.asp

Table A2.1. Continued.

Organization and Product Links
Air Force Expeditionary Engineering CoP, https://afkm.wpafb.af.mil/community/views/home.aspx?Filter=21340
USACE Engineer Research and Development Center, http://erdc.usace.army.mil/
DOD Issuances (Publications, Directives, Guides, Etc.), http://www.dtic.mil/whs/directives/
Armed Forces Pest Management Board (AFPMB), http://www.afpmb.org
DOD Pest Management Material List, http://www.afpmb.org/standardlist.htm
AFPMB Technical Guides (TG), http://www.afpmb.org/content/technical-guides
Base Support & Expeditionary (BaS&E) Planning Tool, https://www.my.af.mil/OraAS10gR2j2ee/baseapp
Installation Geospatial Information and Services (IGI&S), Installation Viewers and AOR Maps, https://www.my.af.mil/gcss-af/USAF/ep/globalTab.do?command=org&channelPageId=s6925EC133B6A0FB5E044080020E329A9&pageId=681742
Department of Commerce, Electric Current Worldwide, http://www.trade.gov/mas/ian/ecw/
On-Line Conversion Applications, http://www.onlineconversion.com ; http://www.metricconversion.ws ; and http://www.infoplease.com/pages/unitconversion.html

Table A3.1. (Continued)

TASK	DAY									
	0	5	10	15	20	25	30	30+		
Establish ice plans			•••							
Install air conditioners			•••••							
Perform camouflage and concealment activities			•••••	•••••	•••••	•••••	•••••			
Build defensive fighting positions				•••••						
Construct aircraft/vehicle wash racks				•••••						
Construct personnel shelters				•••••	•••••	•••••	•••••	•••••		
Develop dispersal locations				•••••	•••••	•••••	•••••	•••••		
Build/place obstacles					•••••					
Harden critical facilities					•••••	•••••	•••••	•••••		
Install waste collection system					•••••	•••••	•••••	•••••	•••••	•••••
Bury electrical cables						•••••	•••••			
Connect latrines/showers to waste system						•••••				
Construct flooring for facilities						•••••	•••••	•••••	•••••	•••••
Establish engineer supply stocks							•••••	•••••	•••••	•••••

Table A3.4. (Continued)

TASK	DAY									
	0	5	10	15	20	25	30	30+		
Build/place obstacles					•	•••••				
Harden critical facilities					•	•••••	•••••	••		
Install waste collection system						•••••	•••••	•••••	•••••	
Bury electrical cables						•••	•••••			
Upgrade road network								•	•••••	••
Improve personnel shelters									•••••	••
Improve camouflage/concealment/hardening									•••••	••
Increase security measures (fencing)									•••••	••
Construct permanent berms for munitions									•••••	••
Provide permanent pavement repairs									•••••	••

Attachment 4

PERSONAL PROTECTIVE EQUIPMENT (PPE) FOR CIVIL ENGINEER OPERATIONS

A4.1. Supervisors must coordinate with Bioenvironmental Engineering and Safety on PPE for their personnel. Bioenvironmental Engineering will ensure hearing protection is adequate. **Table A4.1.** lists PPE by type of operation.

WARNING

Respiratory protection is not authorized without Bioenvironmental Engineering approval.

Table A4.1. Listing of Typical PPE by Operation.

Operation or Equipment	Typical PPE Required
Dump Truck	Safety-toe boots Gloves
Loader, Grader, Sweeper, Backhoe, Bulldozer, Roller, Paver	Safety-toe boots Gloves Eye protection (dust and bright sun) Hearing protection Respiratory protection (if dusty)
Crane	Safety-toe boots Gloves Hearing protection Head protection
Jackhammer, Pneumatic Drill	Respiratory protection Safety-toe boots Eye protection Hearing protection Gloves

Table A4.1. (Continued)

Concrete Saw, Router, Pavement Grinder	Safety-toe boots Eye protection Hearing protection Respiratory protection (if dusty) Gloves
Asphalt Kettle	Safety-toe boots Eye protection Gloves Apron
Concrete Mixer	Safety-toe boots Eye protection Respiratory protection Hearing protection
Walk-Behind Mower, Powered Edger	Safety-toe boots Eye protection Hearing protection Respiratory protection (if dusty)
Riding Mower	Safety-toe boots Eye protection Hearing protection Respiratory protection (if dusty)
Tractor-Towed Mower	Safety-toe boots Eye protection Hearing protection Respiratory protection (if dusty) Gloves Head protection (if overhead hazard exists)

Table A4.1. (Continued)

Chain Saw	Safety-toe boots Eye protection Hearing protection Respiratory protection (if dusty) Gloves Head protection Leggings (if available)
Powered Auger Rototiller	Safety-toe boots Eye protection Hearing protection Gloves
Stump Cutter, Chipper	Safety-toe boots Eye protection Hearing protection Gloves Head protection
Lawn Roller	Safety-toe boots Gloves
Fertilizer Handling and Application	Safety-toe boots Eye protection Rubber gloves Respiratory protection
Stationary Woodworking Machinery	Eye protection Hearing protection Respiratory protection (if dusty)
Portable Power Tools	Eye protection Hearing protection Respiratory protection (if dusty)

Table A4.1. (Continued)

Powder-Actuated Tools	Eye protection Hearing protection Respiratory protection (if dusty)
General Carpentry, Painting, Plumbing, Sheet Metal, Welding, and Masonry	Safety-toe boots Eye protection Knee pad protection (if extended kneeling) Gloves
Roofing	Fall protection Eye and burn protection (if using asphalt, e.g., gloves, long sleeve shirts, aprons, etc.)
Soldering, Brazing, Welding	Safety-toe boots Eye protection Welder's gloves Respirator (if poorly ventilated spaces)
Spray Painting	Eye protection Respirator (if using dry tints) Gloves Coveralls
Paint Mixing	Eye protection Respiratory protection (if using dry tints) Gloves
Working in Sewers	Respiratory protection Gloves Rubber boots, knee and hip waders Head protection

Table A4.1. (Continued)

Metal-Working Machinery	Safety-toe boots Eye protection Gloves Head protection (if overhead crane system is in use)
Mixing Concrete or Mortar	Safety-toe boots Gloves Eye protection Respiratory protection
Placing Brick or Block, etc.	Safety-toe boots Gloves Eye protection
Cleaning Masonry	Eye protection Acid resistant gloves
General Refrigeration or Heating Work	Safety-toe boots Gloves
Exterior Electric Work or Overhead Distribution	Head protection Fall protection (safety harness/ lanyard) Electrician gloves Safety-toe boots Arc Flash Apparel (see UFC3-560-01)
General Interior Electric and Power Production Work or Barrier Maintenance	Safety-toe boots Gloves Respiratory protection Eye protection Arc Flash Apparel (see UFC3-560-01)
Battery Work (Liquid Electrolyte)	Safety-toe boots Acid resistant gloves and apron Eye and face protection

Table A4.1. (Continued)

General Water or Waste Work	Safety-toe boots Gloves Life vest
Water or Waste Laboratory	Eye protection Respiratory protection Chemical resistant gloves
General Materials Handling	Safety-toe boots Gloves Hard hat (overhead hazard)
Pest Management	Rubber boots (knee or hip) Coveralls Unlined neoprene gloves Non-vented goggles Respirators Hearing protection

Attachment 5

CIVIL ENGINEER SAFETY CHECKLISTS

Table A5.1. Heavy Equipment Operations Safety Checklist.

Item or Activity	<input checked="" type="checkbox"/>
Backhoes:	
Are the front bucket (if so equipped) and outriggers in fully-down positions before digs are attempted?	
Is the entire area where the digging arm may swing cleared of people and equipment? Is clearance for fixed obstructions assured?	
Is operation under energized lines permitted only when absolutely necessary? Are these operations approved by the commander?	
During travel to and from worksites, is the backhoe folded, secured, and centered? Is the front bucket raised only high enough to provide adequate ground clearance?	
Mobile Cranes:	
Are mobile cranes operated only by authorized and qualified persons possessing a valid Operator's Identification Card or persons in training under direct supervision of a qualified operator?	
During operation, is a person appointed to provide signals to the operator?	
Before leaving the crane unattended, are all shutdown procedures performed?	
Is a pre-operational inspection performed and are discrepancies reported to the supervisor?	
Are load weights determined before lifting?	
Are outriggers set before lifting, telescoping the boom, or turning a load within the ratings?	

Table A5.1. Continued

Are loads transported on cranes specifically designed for this purpose?	
Are personnel restricted from riding on loads or the hook?	
Are outriggers used, regardless of the load, when the ground is soft or otherwise unstable?	
When two or more cranes are used to lift one load, is one person designated as the responsible individual?	
Are required safety measures such as securing the empty hook, attaching warning flags (as necessary), etc., taken before the crane is moved to a new job site?	
Are all parts of the crane and load restricted within 10 feet of an energized power line? If this is not practical, is the line de-energized?	
Are additional clearances assured for work near lines greater than 50 kV?	
Is a permanent sign posted within the crane cab warning of electrical power line dangers and restrictions?	
Are operators aware of necessary precautions in the event of contact with power lines?	
Is an approved fire extinguisher kept in the crane cab?	
Dump Trucks:	
Are dump trucks operated within the load capabilities established by the manufacturer and consideration given to the specified weights of the material being carried?	
Are personnel restricted from the bed while it is being raised?	

Table A5.1. Continued

Graders, Loaders, and Bulldozers:	
Are operators familiar with manufacturer's operating instructions, including clearances and weight limitations, if applicable?	
Sweepers:	
Are sweepers operated on airfields equipped with headset radios in direct contact with control tower or escorted by a vehicle that is?	

Table A5.2. Pavement Safety Checklist.

Item or Activity	<input checked="" type="checkbox"/>
Concrete Saw:	
Is a water supply maintained during operation?	
Pavement Breaker (Jackhammer):	
Are proper lifting techniques used during equipment operation and transport?	
Concrete Mixer:	
Are mixers supported in stable positions prior to operation?	
Joint Seal Kettle-Melter:	
Is an approved fire extinguisher available near the kettle?	
Is the safe heating temperature specified by the manufacturer maintained during heating?	
Is material eased into the kettle to prevent splashing?	
Are open flames or other sources of ignition not permitted near material heated to its flashpoint?	

Table A5.3. Compressed Air, Pneumatic, and Portable Power Tools Safety Checklist.

Item or Activity	<input checked="" type="checkbox"/>
Compressed Air and Pneumatic Tools:	
Is compressed air never used to blow debris from personnel?	
Is the downstream pressure of compressed air used for cleaning purposes maintained below 30 psi and only used when effective chip guarding and eye protection are used?	
Are air supply lines marked or tagged to identify the maximum psi on the line?	
Portable Power Tools:	
Are electric power tools never operated in rain, sprinklers, or any kind of precipitation?	

Table A5.4. Carpentry and Structural Maintenance Safety Checklist.

Item or Activity	<input checked="" type="checkbox"/>
General:	
Are all woodworking machines turned off when left unattended?	
Are workers restricted from clearing or repairing equipment while it is operating?	
Are machines shut down, locked out, and tagged during maintenance?	
Are all machine guards in place and, if not, is the machine locked out and tagged?	

Table A5.4. (Continued)

Ventilation Systems:	
Are industrial ventilation systems installed, as required, and are they operational?	
Do industrial ventilation systems exhaust to an enclosed collection container?	
Storage and Handling of Lumber:	
When lumber is stored in tiers, is it stored properly?	
Is smoking prohibited in lumber storage areas?	
When stock cannot be safely handled by hand, is suitable material handling equipment available and used?	
Powder-Actuated Fastening Tools:	
Are only specific size powder charges used as required by manufacturer's instructions?	
Are powder-actuated tools prohibited from use for attaching material to soft construction materials?	
Are operators trained and issued a qualified operator's card by the manufacturer or PATMI?	
Is the tool loaded only when ready to make the required fasten?	
Are tools unloaded during transfer?	
Are tools cleaned, maintained, and checked prior to use according to manufacturer's instructions?	
Are tools stored unloaded and in a locked container?	
Are tools equipped with proper shields?	
Is use restricted in explosive or flammable atmospheres?	
Are operators familiar with procedures in the event of a misfire?	

Table A5.4. (Continued)

Are unfired powder loads disposed of properly?	
Are tool powder loads transported properly?	
Are tool powder loads stored according to instructions in AFMAN 91-201?	
Are warning signs posted in areas of tool use?	
Does the operator ensure no personnel are present on the opposite side of the wall, structure, or material prior to firing a fastener into it?	
Roofing Operations:	
Are scaffolds provided or fall protection equipment used as required?	
Is roofing material segregated and stored in stable conditions?	
Are tar kettles and pots located so they will not pose a fire hazard?	
Masonry:	
Are workers aware of potential hazards associated with the use of Portland Cement?	
Are personnel aware of the hazards and is required PPE used when cleaning and etching brick and concrete work?	
When using power mixers and trowels, are gears, pulleys, chains, or belts adequately guarded?	
When preparing footings, are locations of underground utilities identified prior to any excavations?	

Table A5.5. Protective Coating Maintenance Safety Checklist.

Item or Activity	<input checked="" type="checkbox"/>
General:	
Are flammable and combustible liquids used and stored according to instructions in AFOSHSTD 91-501?	
Are required control measures for exposures to pigments, extenders, and fillers instituted and enforced?	
Are required control measures for exposure to solvents instituted and enforced?	

Table A5.6. Plumbing Maintenance Safety Checklist.

Item or Activity	<input checked="" type="checkbox"/>
Torches and Furnaces:	
Are operators trained and familiar with operating instructions of torches and furnaces before being permitted to use them?	
Are torches and furnaces restricted from use where flammable or explosive environments may be present?	
Is the use of gasoline torches and furnace prohibited in small, unventilated spaces?	
Are appropriate fire extinguishers available as required?	
Soldering and Brazing:	
Are electric soldering irons grounded unless double insulated?	
Are soldering irons placed in suitable non-combustible receptacles when not in use?	
Industrial Waste Drains/Open Storm Drains:	
Are industrial waste manholes treated as confined spaces and appropriate safety measures taken prior to entry?	
Are proper pry bar tools, special lifting tools, and additional help used when lifting storm drain manhole covers as necessary?	

Table A5.6. (Continued)

Gas Systems:	
Where a gas leak is suspected, is the area properly vented and purged and do personnel entering the area utilize required PPE?	
Are tools used to repair leaks or perform maintenance on gas lines spark-free and is clothing static-free?	
Tunnels, Pits, and Sumps:	
Are atmospheric conditions tested prior to entry into tunnels, pits, and sumps?	
Are tunnels, pits, and sumps (which are known to be contaminated) tagged or identified for information of work crews?	
Is a second person available to provide emergency assistance for persons entering a subsurface?	
Compressed Air:	
Are lines completely drained of existing air prior to opening compressed air lines? Are new lines completely secured prior to air entry into the system?	
Is air used for cleaning restricted to 30 psi and below?	

Table A5.7. Metal Fabrication and Welding Safety Checklist.

Item or Activity	<input checked="" type="checkbox"/>
Inert Gas Brazing and Welding:	
Are workers instructed on the hazards of inert gas asphyxiation in confined spaces?	
Are chambers completely ventilated and cooled prior to entry?	
Is adequate ventilation or, as necessary, air-supplied respiratory protection available?	

Table A5.7. (Continued)

Electron Beam Welding:	
Are operating instructions for electron beam welding established and adhered to?	
Plasma Arc Cutting:	
Is required shielding in place and do walls, floors, ceilings, etc., have non-reflective surfaces?	
Are adequate controls (e.g., exhaust ventilation or approved respiratory protective devices) provided?	
Induction (Spot) Welding and Brazing:	
Do welders replace filter materials within induction coils and not attempt to adjust placement while the welding or brazing equipment is activated?	
Magnesium-Thorium Welding, Cutting, and Grinding:	
Prior to welding, cutting, or grinding operations on magnesium-thorium, is the Installation Radiation Safety Officer (IRSO) consulted? The IRSO in most instances is the base Bioenvironmental Engineer.	
Welding and Cutting Tanks, Cylinders, or Containers:	
Are all tanks, cylinders, or containers to be welded or cut, purged or made inert prior to the operation being conducted?	
Are pipelines to these containers disconnected prior to welding or cutting?	
Portable Gas Units:	
Are compressed gas cylinders equipped with pressure reducing regulators?	
Are cylinders stored in upright position with caps installed and secured with materials other than rope or other readily combustible material?	

Table A5.7. (Continued)

Are gaseous systems and containers color-coded?	
Are pressure hoses secured to prevent whipping?	
Are oxygen cylinders and fittings free of grease and oil?	
Are cylinders kept separate from external sources of heat?	
Are approved devices provided for flashback protection?	
Portable Electric Units:	
Are units de-energized before they are tested, repaired, or transported?	
Are motor generators and other electrical equipment grounded prior to use?	
Arc Welding:	
Are necessary cable splices performed only by qualified electricians and are splices prohibited within 10 feet of the electrode holder?	
When welders are working close together on one structure, are machines connected to minimize shock hazards according to AFOSHSTD 91-10?	
Resistance Welding:	
Are thermal protection switches in use on ignition tubes?	
Are controls safeguarded from inadvertent activation?	
Are multi-gun welding machines guarded at the point of operation?	
Are all external weld-initiating control circuits operated on required voltage and are interlocks available to prevent access by unauthorized individuals?	

Table A5.7. (Continued)

Welding in Confined Spaces:	
Are confined spaces where welding or cutting is performed adequately ventilated?	
Is an attendant positioned on the outside of a confined space entry point to ensure the safety of those in the confined space?	
Are gas cylinders and welding machines left outside confined spaces?	
Are confined spaces tested for oxygen content and combustible vapors prior to entry?	
Hazards Associated With Fluxes, Coverings, Filler Metals, and Base Metals:	
Are precautions identified and requirements met according to AFOSHSTD 91-10, when welding Fluorine compounds, Zinc, Lead, Beryllium, Cadmium, and Mercury materials?	

Table A5.8. Refrigeration/Air Conditioning Maintenance Safety Checklist.

Item or Activity	<input checked="" type="checkbox"/>
General:	
Are all belts, pulleys, and rotating shafts adequately guarded?	
Storage and Handling:	
Are compressed gas cylinders adequately stored and handled?	

Table A5.9. Interior and Exterior Electric Maintenance Safety Checklist.

Item or Activity	<input checked="" type="checkbox"/>
Do all personnel strictly adhere to AFI 32-1064, <i>Electrical Safe Practices</i>, any time lethal voltages are involved.	
Electric Motor Rewind Shops:	
Are capacitors disconnected for at least 5 minutes before circuit terminals are shorted by an approved method?	
Storage Batteries:	
Are open flames or spark-producing devices restricted in the vicinity of storage battery banks?	
Is a neutralizing solution available when work involves contact with electrolyte?	
When mixing acid and water, is the acid poured into the water and not vice-versa?	
Work on Energized Circuits:	
Is work on energized circuits performed only when absolutely necessary?	
Is approved protective equipment used when work on energized conductors or parts is performed?	
Work Near Energized Circuits:	
When air operated equipment is used around live parts, are the nozzles made of non-conducting material?	
Are appropriate warning tags used as a temporary means of warning employees of existing electrical hazards?	

Table A5.9. (Continued)

Exterior Electric:	
Are leather gloves and safety-toed shoes worn when removing or replacing manhole covers?	
Are confined space entry precautions used when entering manholes and vaults?	

Table A5.10. Electrical Power Production Safety Checklist.

Item or Activity	<input checked="" type="checkbox"/>
Do all personnel strictly adhere to AFI 32-1064, <i>Electrical Safe Practices</i>, any time lethal voltages are involved?	
Plant Operations:	
Are generators located in outside facilities housed in weatherproof protection and all moving parts and electrical connections adequately guarded or covered?	
Are all metal frames for electrical control panels, switches, meters, and other hazardous electrical devices grounded not to exceed 25 ohms?	
Are standard operating procedures developed and posted for normal and emergency operations for equipment controls?	
Are noise hazard and high voltage warning signs posted where appropriate?	
Plant Maintenance:	
Is jewelry removed prior to working on machinery?	

Table A5.10. (Continued)

Are appropriate safety clearance tags and interlocks used to prevent accidental or unintentional start up of equipment that is being worked on?	
Does all test equipment have current calibration?	
Are proper jacking procedures used?	
Plant Switchgear and Substation:	
When work is performed on energized circuits, is it approved by the CE Commander or designated representative?	
When performing approved work on energized circuits, are at least two fully qualified workers and required PPE available?	
When working adjacent to energized circuits exceeding 600 volts, are rubber blankets or other guards provided?	
Batteries:	
Are nickel-cadmium and unsealed lead-acid batteries stored separately?	
If required, are emergency eyewashes and showers provided?	
Vaults and Manholes:	
Are vaults and manholes considered confined space hazards until proven otherwise and if so, are confined space requirements followed?	
Air Compressors:	
Are adequate safety relief valves installed on air tanks?	
Are valves prohibited between air tanks and safety valves?	

Table A5.11. Water and Wastewater Treatment Safety Checklist.

Item or Activity	<input checked="" type="checkbox"/>
Nature of Hazards:	
Are chlorinator treatment rooms that are identified as potentially immediately dangerous to life and health (IDLH), equipped with a telephone or are other means of communication?	
Are chlorinator treatment rooms equipped with mechanical exhaust systems that are turned on prior to entry?	
Are written procedures developed for emergency conditions for chlorinator treatment rooms?	
Personal Sanitation:	
Are emergency eyewashes and showers provided when necessary?	
Treatment Plant:	
Are emergency OIs developed?	
At shredding and grinding stations, is power turned off, tagged, and locked out before servicing?	
Are guards and screens in place at shredding and grinding stations?	
Sedimentation Basin (Clarifier):	
Are approved life vests and lifelines located around the clarifier?	
Are guards provided around moving parts?	
Is the rotary distributor of the trickling filter anchored prior to inspection or servicing?	
Aeration Tanks:	
Are firm guardrails in place for work areas and walkways?	
Are approved life vests with lifelines located at appropriate points around aerator rails?	

Table A5.11. (Continued)

Stabilization Ponds:	
Are life vests available and worn when working on a boat or raft?	
Laboratories:	
Are laboratories clean and designed safely and are chemicals stored properly?	
Is electrical equipment properly grounded in laboratories?	
Is pipetting of chemicals by mouth restricted?	

Table A5.12. Aircraft Arresting Systems (AAS) Safety Checklist.

Item or Activity	<input checked="" type="checkbox"/>
General:	
Is good housekeeping maintained in all AAS operations and maintenance areas?	
Are flammable and combustible liquids stored, used, and handled according to instructions in AFOSHSTD 91-501?	
When using compressed air for cleaning is air pressure less than 30 psi and is required PPE used?	
Where necessary, are emergency eyewashes and showers provided?	
When working on active runways, is total communication maintained with the tower and operations?	
Runway Barriers:	
Are facilities housing the AAS evacuated to proper distances?	

Table A5.12. (Continued)

After engagement and upon returning to the AAS housing facility is required PPE designated and used?	
Is the minimum number of operators, according to applicable T.O.s available?	

Attachment 6

PROS AND CONS OF EXPEDIENT LATRINES

A6.1. Pail Latrines.

DESCRIPTION: Pail Latrines	
<ul style="list-style-type: none"> • Buckets are placed under box latrine seats. • Double trash bags or similar liner is recommended for ease of disposal and cleaning. • 4 seats with pails (e.g., 5-gallon). 	
PROS	CONS
<ul style="list-style-type: none"> • Can be constructed quickly. • Can last indefinitely. • Can be constructed in areas where conditions prevent digging (e.g., populated areas, rocky plateau desert). • Can be constructed in areas where trenches cave in (e.g., sandy dune desert). • Can be constructed in areas with high water table (e.g., desert marsh such as those near Basra, Iraq). 	<ul style="list-style-type: none"> • Labor intensive. Pails must be emptied and cleaned daily. • Must find proper disposal area immediately.
Technical Suitability For Desert Use: Good.	
Desert-Specific Limitations/Conditions: None.	
Notes and Other Factors:	

A6.2. Straddle Trench Latrines.

DESCRIPTION: Straddle Trench Latrines	
<ul style="list-style-type: none"> • Uncovered trenches without a seat above. • Boards may be placed on the ground along both sides of trench to provide better footing and prevent crumbling/cave in of sides. • Two trenches. Each trench is 1 foot wide x 2.5 feet deep x 4 feet long and can accommodate 2 people at a time. • Excreta must be covered with soil after each use since the trenches are open to filth flies, thereby reducing the serviceable volume. • Design capacity: 2 trenches (capacity for 4) per 100 males, 3 trenches (capacity for 6) per 100 females. • An interim measure, only expected to last 1-3 days while final facilities are being constructed are installed. 	
PROS	CONS
<ul style="list-style-type: none"> • Can be dug quickly 	<ul style="list-style-type: none"> • Don't last long (1-3 days) • Trenches open to filth flies—must cover excreta after each use • Covering excreta partially fills trench. • Difficult to use—no seats or support. • Sides may collapse in some sandy desert soils.
Technical Suitability For Desert Use: Good.	
Desert-Specific Limitations/Conditions: Side wall strength may be insufficient in some sandy desert soils.	
Notes and Other Factors:	

A6.3. Deep-Pit Latrines.

DESCRIPTION: Deep-Pit Latrines	
<ul style="list-style-type: none"> • A 6-foot deep trench with a 2-seat or 4-seat box on top. • The edges around the box and hole are sealed with soil, and seat lids seal when closed to keep filth flies out. 	
PROS	CONS
<ul style="list-style-type: none"> • The standard configurations would be expected to last roughly 33 to 35 days. 	<ul style="list-style-type: none"> • Deserts too rocky or too sandy may preclude its use. • Desert soil must be soft enough to dig and firm enough to hold the walls and edges without caving in.
Technical Suitability For Desert Use: Good.	
Desert-Specific Limitations/Conditions: Side wall strength may be insufficient in some sandy desert soils. In other locations, clayey soils can hinder or prevent percolation. If permitted, pit life can be extended by burning the contents of the deep-pit latrine weekly.	
Notes and Other Factors:	

A6.4. Bored-Hole Latrines.

DESCRIPTION: Bored-Hole Latrines	
<ul style="list-style-type: none"> • Made by boring a cylindrical hole 6 to 20 feet in the ground. • Half a drum (e.g., 55-gallon) with a hole cut in it and a seat on top of the half-drum is placed over the hole. 	
PROS	CONS
<ul style="list-style-type: none"> • Can be constructed quickly with a drill rig and cutting torch. • The standard configurations would be expected to last roughly 16 to 63 days. 	<ul style="list-style-type: none"> • Deserts too rocky or too sandy may preclude its use. • Desert soil must be soft enough to dig and firm enough to hold the walls and edges without caving in. • Bored-hole latrines may need side wall support. (e.g., from cylindrical drums) in sandy desert soils, or must be more shallow. • Requires engineering support to bore hole and cut drums.
<p>Technical Suitability For Desert Use: Ranges from very good to poor, depending on side wall strength.</p>	
<p>Desert-Specific Limitations/Conditions: Side wall strength may be insufficient in some sandy desert soils.</p>	
<p>Notes and Other Factors:</p>	

A6.5. Mound Latrines.

DESCRIPTION: Mound Latrines	
<ul style="list-style-type: none"> • A mound above grade with a trench in it and a 4-seat box over the pit. • Either a mound is constructed and a trench is dug in the mound, or soil is piled up in stages around supporting walls that will become the trench. • Trench is located 1 foot above groundwater or rock; depth is variable. 	
PROS	CONS
<ul style="list-style-type: none"> • May be suitable in rocky desert soil or mountainous deserts where the ground is too rocky to dig. • The standard configurations of a 4-seat mound latrine with a 6-foot deep pit would be expected to last roughly 35 days. 	<ul style="list-style-type: none"> • Requires engineering support to construct mound and trench. • Liquid wastes may escape through the side of the mound if the soil is too permeable.
<p>Technical Suitability For Desert Use: Very good in absorbing soils. Poor where liquid waste could break through the mound.</p>	
<p>Desert-Specific Limitations/Conditions: Leakage from side of the mound is possible with sandy desert soils.</p>	
<p>Notes and Other Factors:</p>	

A6.6. Burn-Out Latrines.

DESCRIPTION: Burn-Out Latrines	
<ul style="list-style-type: none"> • 55-gallon metal drum is cut in half and placed under a seat. Handles are welded onto the drum. • Plywood shelter to support toilet seat and provide privacy. 	
PROS	CONS
<ul style="list-style-type: none"> • Can be constructed quickly with the right equipment. • Can last indefinitely, requiring only the remaining ash to be buried. 	<ul style="list-style-type: none"> • Host nation and Final Governing Standards regarding open burning or air emissions may prohibit. • Requires engineering support to cut drums and weld handles. • Labor and fuel intensive. • Smoke from burning waste can announce presence. Detrimental if tactical security is a concern.
Technical Suitability For Desert Use: Very Good.	
Desert-Specific Limitations/Conditions: None.	
Notes and Other Factors:	

A6.7. Chemical, Portable or Self-Contained Vault Toilets.

DESCRIPTION: Chemical, Portable and Self-Contained Toilets	
<ul style="list-style-type: none"> • Self-contained portable or non-portable outbuildings with a holding tank under the seat. • May contain chemical additives that aid in the decomposition of the waste and odor control. 	
PROS	CONS
<ul style="list-style-type: none"> • Have been used successfully when serviced adequately and wastes disposed of properly. • Can be adapted for use as burn-out latrines if wastewater treatment facility or waste disposal support (e.g., sewage vacuum trucks) is unavailable. 	<ul style="list-style-type: none"> • Must be pumped out at weekly to break the filth fly reproductive cycle, or as frequently as daily depending upon usage. • Pumped out material must be disposed of properly. • A proper waste disposal area must be prepared within 1 week. • Length of use is limited by the disposal area.
Technical Suitability For Desert Use: Very Good.	
Desert-Specific Limitations/Conditions: None.	
Notes and Other Factors:	

Attachment 7

PROS AND CONS OF EXPEDIENT WASTEWATER DISPOSAL FACILITIES

Table A7.1. Evaporation Beds.

DESCRIPTION: Evaporation Beds	
<ul style="list-style-type: none"> • Intended for kitchen, wash, and bath wastewater. • Expedient evaporation beds are often small (8 feet x 10 feet x 6 inches) with rows or in 3 tiers where one pond flows into the next if space is limited. • 3 square feet/person/day for kitchen waste plus 2 square feet/person/day for wash and bath water • Beds are flooded to an average depth of 3 inches on successive days. Beds are rotated and water must evaporate and percolate within 4 days. Underlying soil is spaded and bed is reused. 	
PROS	CONS
<ul style="list-style-type: none"> • Simple to build 	<ul style="list-style-type: none"> • Labor intensive. • Time consuming to maintain. • Small capacity. • Space consuming.
<p>Technical Suitability For Desert Use: Good. Suitable for small units (generally 90 or less people).</p>	
<p>Desert-Specific Limitations/Conditions: Clayey soils may expand, become impermeable, and prevent sufficient percolation. Impermeable caliche may prevent sufficient percolation.</p>	
<p>Notes and Other Factors:</p>	

Table A7.2. Soakage Pits and Trenches.

DESCRIPTION: Soakage Pits and Trenches	
<ul style="list-style-type: none"> • Designed for liquids only. • Pit 4 feet x 4 feet filled with gravel, rubble, or shredded metal, e.g., aluminum cans. • Constructed as stand-alone urine soakage pits with urine tubes or pipes. • Should be constructed in conjunction with standard in-ground latrines, chemical toilets or burn-out latrines for solid human waste. • Soakage pits or trenches for shower and kitchen are built separately from urine soakage pits. Four trenches radiating from a central 1-foot deep pit are 6 feet long, 2 feet wide and increase in depth from 1 to 1-1/2 feet. Kitchen soakage pits or trenches also need grease traps to prevent percolation from being blocked. • No estimate of length of service for soakage pits and trenches is made in any field manuals, except the instruction to build a new one when the existing one stops working (standing water observed). 	
PROS	CONS
<ul style="list-style-type: none"> • Reduces traffic in latrines intended for solid human waste. • Reduces liquid in burn-out latrines, which reduces the amount of fuel required for burning out semi-solids. • Can last indefinitely if soil is permeable. 	<ul style="list-style-type: none"> • Must compete for gravel that can be in high demand for other uses. • Rubble or gravel may not be plentiful at the beginning of deployment when needed to build soakage pit. • May need to build new one on short notice, especially if soil is not permeable.
Technical Suitability For Desert Use: Good.	
Desert-Specific Limitations/Conditions: Clayey soils may expand, become impermeable, and prevent sufficient percolation. Impermeable caliche may prevent sufficient percolation.	

Table A7.3. Sewage Lagoons.

DESCRIPTION: Sewage Lagoons	
<ul style="list-style-type: none"> • Shallow lagoon or pond dug into ground. Excavated material is sometimes formed into earthen walls. Walls and bottom may require waterproof skin. • Wastewater is pumped from camp to lagoon. 	
PROS	CONS
<ul style="list-style-type: none"> • Lagoon proper can be constructed easily with mechanized equipment. • One option for sewage disposal prescribed in “The Sand Book.” 	<ul style="list-style-type: none"> • Must be located at least ½ mile from population center because of odor and filth fly/mosquito breeding. • Requires sewer collection system piping and possibly automatic lift stations. • Earthen walls can leak. • Not a recommended theater practice per FM 3-34.471.
Technical Suitability For Desert Use: Satisfactory to Poor.	
Desert-Specific Limitations/Conditions: Clayey soils may hold water. May act similar to an evaporation bed, except that the pest reproduction cycle is not broken by a drying period.	
Notes and Other Factors:	

Table A7.4. Leach Fields.

DESCRIPTION: Leach Fields	
<ul style="list-style-type: none"> • A gravity-fed subsurface drainage bed system, such as a tile or plastic pipe drain field consisting of narrow, shallow trenches through which effluent is discharged. • The effluent infiltrates the soil primarily through the sides of the trenches. • Provides physical, biological, and chemical treatment. • Settling system, such as septic tank or Imhoff tank, to remove sewage solids, at a minimum is implied as pretreatment. 	
PROS	CONS
<ul style="list-style-type: none"> • Underground system eliminates surface discharge and subsequently human contact or filth fly and mosquito breeding. • Can be close to human habitation. • Treatment and disposal work well where soil porosity is moderate. • Low maintenance. • Can last many years. 	<ul style="list-style-type: none"> • Requires a significant amount of space. • Slope should be less than 25%. • Can clog permanently if solids enter the leach field. • Requires moderately porous soil so that sewage will neither backup or pond on the surface nor percolate too rapidly to contaminate the ground water.
Technical Suitability For Desert Use: Excellent to Good.	
Desert-Specific Limitations/Conditions: None.	
Notes and Other Factors:	

Attachment 8

ELECTRICAL CURRENT CHARACTERISTICS IN SOUTHWEST ASIA

Table A8.1. Electrical Current Characteristics.

Country	Type of Current	Frequency	Number of Phases	Nominal Voltage	Number of Wires	Frequency Stability
Afghanistan	A.C.	50	1,3	220/380	2,4	Yes
Egypt	A.C.	50	1,3	220/380	2,4	Yes
Iran	A.C.	50	1,3	220/380	2,3,4	Yes
Iraq	A.C.	50	1,3	220/380	2,4	Yes
Israel	A.C.	50	1,3	220/380	2,4	Yes
Jordan	A.C.	50	1,3	220/380	2,3,4	Yes
Kuwait	A.C.	50	1,3	240/415	2,4	Yes
Lebanon	A.C.	50	1,3	110/190, 220/380	2,4	No
Libya	A.C.	50	1,3	220/380	2,4	Yes
Oman	A.C.	50	1,3	240/415	3,4	Yes
Pakistan	A.C.	50	1,3	230/400	2,3,4	No
Saudi Arabia	A.C.	60	1,3	127/220	2,3,4	Yes
Sudan	A.C.	50	1,3	240/415	2,4	Yes
Syria	A.C.	50	1,3	220/380	2,3,4	No
Turkey	A.C.	50	1,3	220/380/ 154	2,3,4	Yes
Yemen	A.C.	50	1,3	220/380	2,4	No

Attachment 9**CONVERSION TABLES****Table A9.1. U.S. to Metric Conversion Table.**

Length		
U.S. Units	Multiplied By	Metric Equivalent
Inches	2.5400	Centimeters
Inches	25.4001	Millimeters
Feet	0.3048	Meters
Feet per second	0.3050	Meters per second
Miles	1.6093	Kilometers
Area		
Pounds per square inch	0.0700	Kilogram per square centimeter
Square inches	6.4516	Square centimeter
Square feet	0.0929	Square meter
Cubic feet	0.0283	Cubic meter
Cubic inches	16.3900	Cubic centimeters
Volume		
Gallons	3.7854	Liters
Mass (Weight)		
Pounds	0.4536	Kilograms
Temperature		
Degrees (F) -32	0.5556	Degrees (C)
Angle		
Degrees (angular)	17.7778	Mils

Table A9.2. Metric to U.S. Conversion Table.

Length		
Metric Units	Multiplied By	U.S. Equivalent
Centimeters	0.39370	Inches
Millimeters	0.03937	Inches
Meters	3.28080	Feet
Meters per second	3.28100	Feet per second
Kilometers	0.62140	Miles
Area		
Kilogram per square centimeter	14.22300	Pounds per square inch
Square centimeter	0.15500	Square inches
Square meter	10.76400	Square feet
Cubic meter	35.31440	Cubic feet
Cubic centimeters	0.06102	Cubic inches
Volume		
Liters	0.26420	Gallons
Mass (Weight)		
Kilograms	2.20460	Pounds
Temperature		
Degrees (C) + 17.8	1.8000	Degrees (F)
Angle		
Mils	0.0562	Degrees (angular)

Table A9.3. Foreign Weights and Measures.

Denominations	Where Used	U.S. Equivalent
Almude	Portugal	4.422 gals.
Ardeb	Sudan	5.6188 bushels
Are	Metric	0.02471 acre
Arr't'l or li'ra	Portugal	1.0119 lbs.
Arroba	Argentine Republic	25.32 lbs.
Arroba	Brazil	32.38 lbs.
Arroba	Cuba	25.36 lbs.
Arroba	Paraguay	25.32 lbs.
Arroba	Venezuela	25.40 lbs
Arroba (liquid)	Cuba, Spain and Venezuela	4.263 gals.
Arshine	Russia	28 in.
Arshine (sq.)	Russia	5.44 ft.2
Artel	Morocco	1.12 lbs.
Baril	Argentine Republic	20.077 gals.
Baril	Mexico	20.0787 gals.
Barrel	Malta (customs)	11.2 gals.
Berkovets	Russia	361.128 lbs.
Bongkal	Fed. Malay States	832 grains
Bouw	Sumatra	7,096.5 meters2
Bu	Japan	0.12 inch
Bushel	British Empire	1.03205 U.S. bu.
Caffiso	Malta	5.40 gals.
Candy	India (Bombay)	569 lbs.
Candy	India (Madras)	500 lbs.
Cantar	Egypt	99.05 lbs.
Cantar	Morocco	112 lbs.
Cantar	Turkey	124.45 lbs.

Table A9.3. (Continued)

Cantaro	Malta	175 lbs.
Cast, Metric	Metric	3.086 grains
Catti	China	1.333 1/3 lbs.
Catti	Japan	1.32 lbs.
Catty	Java, Malacca	1.36 lbs.
Catty	Thailand	1.32 lbs.
Catty	Sumatra	2.12 lbs.
Centaro	Central America	4.2631 gals.
Centner	Brunswick	117.5 lbs.
Centner	Bremen	127.5 lbs.
Centner	Denmark, Norway	110.23 lbs.
Centner	Russia	113.44 lbs.
Centner	Sweden	93.7 lbs
Chetvert	Russia	5.957 bu.
Ch'ih	China	12.60 in.
Ch'ih (metric)	China	1 meter
Cho	Japan	2.451 acres
Comb	England	4.1282 bu.
Coyan	Thailand	2.645.5 lbs.
Cuadra	Argentine Republic	4.2 acres
Cuadra	Paraguay	94.70 yds.
Cuadra (sq.)	Paraguay	1.85 acres
Cuadra	Uruguay	1.82 acres
Cubic meter	Metric	35.3 cu. ft.
Cwt. (hund. weight)	British	112 lbs.
Dessiatine	Russia	2.6997 acres
Drachma (new)	Greece	15.43 gr., or 1 gram
Fanega (dry)	Ecuador, Salvador	1.5745 bu.
Fanega	Chile	2.75268 bu.
Fanega	Guatemala, Spain	1.53 bu.

Table A9.3. (Continued)

Fanega	Mexico	2.57716 bu.
Fanega (doublé)	Uruguay	7.776 bu.
Fanega (single)	Uruguay	3.888 bu.
Fanega	Venezuela	3.334 bu.
Fanega (liquid)	Spain	16 gals.
Feddan	Egypt	1.04 acres
Frall (rais's)	Spain	50 lbs.
Frasco	Argentine Republic	2.5098 liq.qts.
Frasco	Mexico	2.5 liq. qts.
Frasila	Zanzibar	35 lbs.
Fuder	Luxemburg	264.18 gals.
Funt	Russia	0.9028 lb.
Gallon	British Empire	1.20094 U.S. gals.
Garnice	Poland	1.0567 gal.
Gram	Metric	15.432 grains
Hectare	Metric	2.471 acres
Hectolitre: Dry	Metric	2.838 bu.
Hectolitre: Liquid	Metric	26.418 gals
Jarib	Iran	2.471 acres
Joch	Austria (Germany)	1.422 acres
Joch	Hungary	1.067 acres
Ken	Japan	5.97 feet
Kilogram (kilo)	Metric	2.2046 lbs.
Kilometre	Metric	0.62137 mile
Klafter	Austria (Germany)	2.074 yds.
Koku	Japan	5.119 bu.
Kwamme	Japan	8.2673 lbs.

Table A9.3. (Continued)

Last	Belgium (Netherlands)	85.135 bu.
Last	England	82.56 bu.
Last	Germany	2 metric tons (4,409 + lbs)
Last	Russia	112.29 bu.
Last	Scotland, Ireland	82.564 bu.
League (land)	Paraguay	4.633 acres
Li	China	1,890 ft
Libra (lb.)	Argentine Republic	1.0128 lbs.
Libra	Central America	1.014 lbs.
Libra	Chile	1.014 lbs.
Libra	Cuba	1.0143 lbs.
Libra	Mexico	1.01467 lbs.
Libra	Peru	1.0143 lbs.
Libra	Uruguay	1.0143 lbs.
Libra	Venezuela	1.0143 lbs.
Litre	Metric	1.0567 liq. qts.
Litre	Metric	0.90810 dry qts.
Livre (lb.)	Greece	1.1 lbs
Load, timber	England	50 cu. ft.
Lumber (std.)	Europe	165 cu. ft., or 1,980 ft.b.m
Manzana	Nicaragua	1.742 acres
Manzana	Costa Rica, Salvador	1.727 acres
Marc	Bolivia	0.507 lb.
Maund	India	82 2/7 lbs.
Metre	Metric	39.37 inches
Mil	Denmark	4.68 miles
Mil (geographic)	Denmark	4.61 miles
Milla	Nicaragua	1.1594 miles
Milla	Honduras	1.1493 miles
Mina (old)	Greece	2.202 lbs.
Morgen	Germany	0.63 acre

Table A9.3. (Continued)

Oke	Egypt	2.8052 lbs
Oke (Ocque)	Greece	2.82 lbs.
Oke	Turkey	2.828 lbs.
Pic	Egypt	22.82 inches
Picul	Borneo, Celebes	135.64 lbs.
Picul	China	133 1/3 lbs.
Picul	Java	136.16 lbs.
Picul	Philippines	139.44 lbs.
Pie	Argentine Republic	0.94708 ft.
Pie	Spain	0.91416 ft.
Pik	Turkey	27.9 inches
Pood	Russia	36.113 lbs.
Pund (lb)	Denmark	1.102 lbs.
Quart	British Empire	1.20094 liq. qt.
Quart	British Emp	1.03205 dry qt.
Quarter	Great Britain	8.256 bu.
Quintal	Argentine Republic	101.28 lbs.
Quintal	Brazil	120.54 lbs.
Quintal	Castle, Peru	101.43 lbs.
Quintal	Chile	101.41 lbs.
Quintal	Mexico	101.47 lbs.
Quintal	Metric	220.46 lbs.
Rottle	Israel	6.35 lbs.
Sack (flour)	England	280 lbs.
Sangene	Russia	7 feet
Salm	Malta	8.2 bu.
Se	Japan	0.02451 acre
Seer	India	22-35 lbs.

Table A9.3. (Continued)

Shaku	Japan	11.9303 inches
Sho	Japan	1.91 liq. qts.
Skalpund	Sweden	0.937 lbs.
Stone	British	14 lbs.
Sun	Japan	1.193 inches
Tael Kuping	China	575.64 grains (troy)
Tan	Japan	2.05 pecks
Tchvert	Russia	5.96 bu.
To	Japan	2.05 pecks
Ton	Space measure	40 cu ft.
Tonde cereals	Denmark	3.9480 bu.
Tonde Land	Denmark	1.36 acres
Tonne	France	2204.62 lbs.
Tsubo	Japan	35.58 ft.2
Tsun	China	1.26 inches
Tunna (wheat)	Sweden	4.5 bu.
Tunnland	Sweden	1.22 acres
Vara	Argentine Republic	34.0944 inches
Vara	Costa Rita, Salvador	32.913 inches
Vara	Guatemala	32.909 inches
Vara	Honduras	32.953 inches
Vara	Nicaragua	33.057 inches
Vara	Chile and Peru	32.913 inches
Vara	Cuba	33.386 inches
Vara	Mexico	32.992 inches
Vedro	Russia	2.707 gals.
Verst	Russia	0.663 mile
Vloka	Poland	41.50 acres
Wey	Scotland and Ireland	41.282 bu

Attachment 10

BEDDOWN/BARE BASE DEVELOPMENT CHECKLISTS

Table A10.1. Site Planning and Layout Checklist.

	Sight Planning and Layout Activities	<input checked="" type="checkbox"/>
1	Are basic planning source documents available?	
	a. AFPAM 10-219, Volume 5, Bare Base Conceptual Planning Guide	
	b. Base Support Plan (if published/ applicable)	
	c. Joint Support Plan (if published/ applicable)	
	d. AFPAM 10-219, Volume 6, Planning and Design of Contingency Air Bases	
	e. Base maps or IGI&S data (if available)	
2	Has Wing Intelligence been contacted to provide the latest threat estimate?	
3	Has Wing Operations been contacted to provide verification on numbers/types of aircraft and base population to be supported?	
4	Has an exploratory trip been made around the base to ascertain terrain features, land area available, locations of existing pavements, location of water source, locations of useable structures, etc?	
5	Has the Wing Weather function been contacted to obtain germane climatic factors?	
6	Has a decision been made concerning a dispersed versus a non-dispersed layout?	

Table A10.1. (Continued)

	Sight Planning and Layout Activities	<input checked="" type="checkbox"/>
7	Have areas unsuitable for facility layout been highlighted on the base layout maps?	
8	Have all facility groups (e.g. maintenance, supply, engineer, transportation, etc.) been sized based on typical quantities of facility assets and appropriate spacing distances?	
9	Have the facilities within each facility group been laid out with consideration given to utility system routings, i.e., reasonably straight runs and vehicle access ability?	
10	Have feasible locations for all facility groups been identified taking into account their functional relationship with the base mission and other base organizations?	
11	Has an allowance for future expansion been included in each facility group when appropriate?	
12	Does the layout of all facility groups meet the safety distance/quantity distance criteria pertaining to munitions, Cryogenics, and POL storage?	
13	Has a road network been planned between facility groups that permits easy access and egress to and from the flightline?	
14	Have utility plants been sited?	
15	Have areas for construction of evaporation beds and sewage lagoons been identified downwind of the main base area?	
16	Have areas for temporary disposal of waste and wastewater been identified pending completion of permanent lagoons and evaporation beds?	

Table A10.1. (Continued)

	Sight Planning and Layout Activities	<input checked="" type="checkbox"/>
17	Have site layout maps been made for survey crews who will mark locations of facility group areas and individual facilities?	
18	Have site layout crews been identified?	
19	Have stakes or similar marking devices been obtained?	
20	Have vehicles (if available) been identified for site layout crews?	
21	Have site layout crews been briefed on how to accomplish their tasks and the timeframe they have to work within?	
22	Do site layout crews have the surveying equipment necessary to layout the more complex requirements, e.g., the mobile aircraft arresting barrier?	
23	If other functional areas participated in site layout of their facilities and equipment; have the chosen locations been checked for suitability, e.g., drainage patterns, safety distance criteria, airfield clear zones, etc?	

Table A10.2. Electrical System Checklist.

	Electrical System Activities	<input checked="" type="checkbox"/>
1	Has a holding area for temporary storage of incoming electrical system components been established?	
2	Have mission essential facilities been identified and coordinated with the appropriate command elements?	
3	Have the locations of mission essential facilities been identified?	

Table A10.2. (Continued)

	Electrical System Activities	<input checked="" type="checkbox"/>
4	Has a requirement for sustained operations at the contingency location been confirmed?	
5	Has an initial estimate of the electrical loads of mission essential facilities been made to aid in sizing generators to the requirements?	
6	Has vehicle/equipment support for moving electrical equipment to site locations been arranged?	
7	Do all electrical installation crews have an individual capable of operating materials handling equipment?	
8	Have SDCs been placed at locations where MEP generators can serve multiple mission essential facilities?	
9	Have MEP generators been connected to mission essential facilities?	
10	Have TF-2 light carts been operationally checked and allocated to critical flightline functional areas?	
11	Have personnel been identified to perform routine maintenance and refueling operations on MEP generators?	
12	Have electrical feeder schedules been developed based on the layout of the various base facility groups?	
13	Have SDC circuits been sized to handle future air conditioning loads (if applicable)?	
14	Has a plan showing the layout of the electrical distribution system been developed?	
15	Have locations for power plants been determined?	
16	Have prime power generators (750kW) been positioned at power plant locations?	

Table A10.2. (Continued)

	Electrical System Activities	<input checked="" type="checkbox"/>
17	Have fuel bladders been installed at power plant locations?	
18	Have fuel bladders been properly bermed?	
19	Have control panels been correctly connected to the prime power generators?	
20	Have PDCs been placed and connected at power plants?	
21	Have adequate grounding systems been installed at the power plants?	
22	Have SDCs been allocated to and placed in the various facility groups in such a way that portions of the groups can be brought on line as facilities are erected?	
23	Have SDCs been placed in areas accessible to vehicles yet not adjacent to heavy traffic or personnel flow?	
24	Have SDCs been grounded?	
25	Have the cables connecting the facilities, panel boxes, SDCs, PDCs initially been installed along the surface of the ground?	
26	Have cables that cross roadways been adequately protected from damage by vehicle traffic?	
27	Have facilities been brought onto the base electrical grid as soon as reasonably possible once electrical connections have been completed?	
28	Have MEP generators serving mission essential facilities been placed in back up power mode once power plant electrical service was available?	
29	Have personnel been specifically designated to provide around-the-clock power plant operation?	

Table A10.2. (Continued)

	Electrical System Activities	<input checked="" type="checkbox"/>
30	Have RALS units been installed at locations requiring large-scale area lighting?	
31	If sustained operations are planned and the electrical system is fully functional in an above ground mode, have efforts been started to bury electrical cables?	
32	Have accurate records/drawings been made of the locations of buried electrical cables?	
33	Do power plant operators properly maintain plant operation records?	
34	Have arrangements been made for power plant refueling?	

Table A10.3. Water System Checklist.

	Water System Activities	<input checked="" type="checkbox"/>
1	Has a holding area for temporary storage of incoming water system components been established?	
2	Has the installation's source of water been identified and located?	
3	Has the water source been developed sufficiently to allow pumping?	
4	Has vehicle/equipment support for moving water system components to site locations been arranged?	
5	Have vehicles been identified for use in hauling water from source locations to treatment plants?	

Table A10.3. (Continued)

	Water System Activities	<input checked="" type="checkbox"/>
6	Have water trailers or bladders mounted on trailers been identified to support the water hauling requirement?	
7	Have raw water pumps been installed at water source locations?	
8	Have locations for water plants been determined?	
9	Has the distance from the water source to the nearest treatment plant been limited to two miles or less?	
10	Have ROWPUs been delivered to the water plant locations?	
11	Have arrangements been made to have electrical power support readily available at the water plant locations?	
12	Have personnel been assigned to set up ROWPUs and associated storage tanks and begin water production?	
13	Have personnel been assigned to continuously haul water from the water source location to the water plants?	
14	Have brine discharge lines from the ROWPUs been laid out to discharge brine back to the source, into a low-lying contained area, or temporary storage system?	
15	Has sufficient space been allowed around the water treatment plants to permit installation of additional water storage bladders at a later time?	
16	If demineralized water is required, has a 20,000-gallon water bladder been specifically identified for demineralized water storage?	
17	Have key facilities (hospital, kitchen, etc.) requiring potable water been identified?	

Table A10.3. (Continued)

	Water System Activities	<input checked="" type="checkbox"/>
18	Has the layout of aboveground flexible hose from the treatment plants to key facilities requiring potable water been started?	
19	Have hoses that cross roadways been adequately protected from vehicle traffic?	
20	Have fill points for both potable and non-potable water been set up?	
21	Has a reasonably level and clear path been made between the nearest water treatment plant and the water source?	
22	For long term installation, has a hardwall source line been installed between the water source and the nearest water treatment plant?	
23	Have installation personnel verified in the field the planned locations of the hardwall distribution system for feasibility and practicability?	
24	Do all utilities crews have an individual capable of operating trenching equipment or a backhoe?	
25	Have pipelines that cross roadways been adequately protected from damage by vehicle traffic?	
26	Have additional water storage bladders provided as part of the distribution system been installed at the water treatment plants?	
27	Have the storage bladders been installed so that approximately 60% of the storage capacity is dedicated to potable water?	

Table A10.3. (Continued)

	Water System Activities	<input checked="" type="checkbox"/>
28	Has a requirement for sustained operations at the contingency location been confirmed?	
29	If sustained operations are planned and the water system is fully functional in an aboveground mode, have efforts been started to install and bury a hardwall piping distribution system?	
30	Have ice machines and refrigeration boxes (if available) been installed at one of the water plants to supply general base needs?	
31	Have accurate “as-built” drawings of buried hardwall pipe locations been made?	
32	If/after installing in-ground hardwall piping, is the flexible hose initial distribution system serviced and stored properly in system shipping containers?	

Table A10.4. Waste System Checklist.

	Waste System Activities	<input checked="" type="checkbox"/>
1	Has a holding area for temporary storage of incoming waste system components been established?	
2	Have locations for construction of expedient latrines been identified?	
3	Have personnel been identified to construct expedient latrines at all required locations?	
4	Have the locations of BEAR field latrines been identified?	
5	Has the potential of tapping into off base sewage collection systems been investigated?	

Table A10.4. (Continued)

	Waste System Activities	<input checked="" type="checkbox"/>
6	Have locations downwind of the base been identified for stabilization lagoons and evaporation ponds?	
7	Have areas for temporary disposal of waste and wastewater been identified pending completion of permanent lagoons and evaporation beds?	
8	Have personnel been identified for servicing of expedient latrines?	
9	Are personnel available who are qualified to operate the wastewater disposal trailer?	
10	Has local contract support for waste disposal been investigated?	
11	If not connected to wastewater system, are graywater lines from showers and laundry been run to evaporation beds?	
12	Are grease traps installed in wastewater lines leading from the kitchen, when necessary?	
13	Have services personnel been instructed in grease trap use?	
14	Has a plan for the layout of the waste collection system been developed?	
15	Have installation personnel verified in the field the planned locations of the hardwall collection piping and lift stations for feasibility and practicability?	
16	Are lift stations located near a source of electrical power (not MEP generator)?	
17	Has a requirement for sustained operations at the contingency location been confirmed?	

Table A10.4. (Continued)

	Waste System Activities	<input checked="" type="checkbox"/>
18	Do utilities crews have personnel qualified to operate trenching equipment, back hoes and materials handling equipment?	
19	If sustained operations are planned and all required system components are on hand, have efforts been started to install the underground sewage collection system and construct stabilization lagoons/evaporation ponds?	
20	Have stabilization lagoons and evaporation ponds been sized for the anticipated base population and duration of deployment?	
21	Have accurate “as-built” drawings of pipeline locations been made?	
22	Have arrangements been made for continued servicing of latrines that are not connected to the collection system?	

Table A10.5. Facility Erection Checklist.

	Facility Erection Activities	<input checked="" type="checkbox"/>
1	Has a holding area for temporary storage of incoming facility assets been established?	
2	Have selected engineer personnel been designated to identify and segregate engineer-related BEAR assets as they arrive?	
3	Are some of the individuals selected to identify incoming assets qualified to operate materials handling equipment?	
4	Has a method of asset accountability been established?	

Table A10.5. (Continued)

	Facility Erection Activities	<input checked="" type="checkbox"/>
5	Has an allocation of facility assets been made to the various facility groups to be set up at the bare base?	
6	Has command level (wing/base) agreement been reached on the asset allocation?	
7	Has a site layout been made identifying locations of facility groups and representative types of buildings within the groups?	
8	Have the specific locations of all dome shelters, frame supported tension fabric shelters and aircraft hangers been identified? Is the site preparation task underway and sufficiently manned so as not to delay facility delivery and erection?	
9	Are facilities delivered to the erection sites or engineer holding area (as appropriate) when they arrive?	
10	Has the capability for engineer personnel to assist in the delivery of facilities to erection locations been established?	
11	Are facilities being delivered close to their final set up locations?	
12	Have engineer shop and cantonment facilities been set up fairly early in the beddown process?	
13	Have selected engineer personnel been designated to provide technical expertise to the base populace in erecting facility assets?	
14	Have instructions been given to the base personnel erecting their own facilities concerning facility orientation and meaning of layout stakes/markers?	

Table A10.5. (Continued)

	Facility Erection Activities	<input checked="" type="checkbox"/>
15	Are dome shelter, frame supported tension fabric shelter and aircraft hanger facility components being identified and set aside for RED HORSE or 49th MMG activities?	
16	Have engineer crews been designated for all Medium Shelter and general use shelter erection?	
17	Have engineer crews been identified to provide utility connections to facilities once facilities are erected and utility services are in place?	
18	Are shipping containers being collected and stored in the holding area once they are empty?	

Table A10.6. Pavement and Equipment Checklist.

	Pavement and Equipment Activities	<input checked="" type="checkbox"/>
1	Have contract options been investigated for obtaining and/or augmenting heavy equipment assets?	
2	Have heavy equipment assets been thoroughly checked for serviceability upon arrival?	
3	Has an airfield survey been made to identify emergency maintenance, repair and operations requirements?	
4	Have potential “show stopping” airfield pavement repairs been made?	
5	Has construction required to develop a water source been completed?	

Table A10.6. (Continued)

	Pavement and Equipment Activities	<input checked="" type="checkbox"/>
6	Has a road or accessway from the water source to the water treatment plants been established?	
7	Has site preparation for aircraft arresting barrier installation been accomplished?	
8	Have airfield pavement sweeping operations been instituted?	
9	Has site preparation for NAVAID installation been accomplished?	
10	Has site preparation for facility erection begun?	
11	Has a road network from the flightline been established?	
12	Has an engineer holding area (open storage) been established?	
13	Have roads or accessways to locations of each of the planned facility groups been graded?	
14	Have temporary munitions holding areas been established?	
15	Have berms been constructed around aircraft refueling bladders?	
16	Have aircraft parking expansion requirements been completed?	
17	Have specialized aircraft pavements (hot cargo pads, arm/dearm pads, etc.) been completed?	
18	Have critical obstacles in airfield clear zones been removed?	
19	Have critical base drainage conditions been corrected?	
20	Have serious FOD producing areas been corrected?	

Table A10.6. (Continued)

	Pavement and Equipment Activities	<input checked="" type="checkbox"/>
21	Have sources of supply for revetment fill materials and general horizontal construction been located?	
22	Have berms for POL storage areas and power plant fuel storage been completed?	
23	Has a sanitary landfill operation been established?	
24	Have perimeter clearing and base defense network expansion operations been started?	
25	Has aircraft revetment erection been started?	
26	Have hazardous waste control areas been identified and established?	
27	Has construction of stabilization lagoons and evaporation ponds been started?	
28	Has construction of personnel protective shelters been started?	
29	Has construction of facility revetments been started?	
30	Have permanent munitions storage berms been constructed?	
31	Has support for burying utility lines been provided?	
32	Have obstacles and barricades been fabricated and placed?	
33	Have dispersal locations been developed?	
34	Have roads been upgraded to withstand sustained vehicle traffic?	
35	Have airfield pavement expedient repairs been replaced with permanent repairs?	

Table A10.7. Fire Emergency Services (FES) Checklist.

	FES Activities	<input checked="" type="checkbox"/>
1	Has contact been made with local fire protection officials to determine host nation support possibilities?	
2	Have firefighters set up the tents that comprise the fire station?	
3	Has a fire alarm communications center (FACC) or Emergency Communication Center (ECC) (consolidated dispatch) been established?	
4	Have communications been established between the FACC and appropriate base agencies and command posts?	
5	Has vehicle availability been ascertained?	
6	Have vehicle shortfalls been identified and passed to higher headquarters for action?	
7	Has firefighting agent availability been determined?	
8	Have shortfalls in agent availability been identified?	
9	Have water sources for firefighting been identified and located?	
10	Have fire extinguishers contained in the BEAR packages been checked, serviced, and distributed?	
11	Has a dispersal plan for FES equipment and materials been developed?	
12	Have dispersal locations been prepared (hardened and camouflaged)?	
13	Have FES assets that cannot be moved been hardened and camouflaged?	

Table A10.7. (Continued)

	FES Activities	<input checked="" type="checkbox"/>
14	Have FES officials participated in initial base layout planning?	
15	Have fire reporting procedures been established and disseminated to the base population?	
16	Has auxiliary firefighting equipment, e.g., extinguishers, shovels, hoses, etc., been made available for use in tent city areas?	