

**INTERMEDIATE  
VOCATIONAL COURSE  
SECOND YEAR**

**CIVIL ENGINEERING  
DRAWING**

*FOR THE COURSE OF  
WATER SUPPLY AND  
SANITARY ENGINEERING*



**STATE INSTITUTE OF VOCATIONAL EDUCATION  
DIRECTOR OF INTERMEDIATE EDUCATION  
GOVT. OF ANDHRA PRADESH**

**2005**

Intermediate Vocational Course, 2<sup>nd</sup> Year : **CIVIL  
ENGINEERING DRAWING (For the Course of Water  
Supply and Sanitary Engineering)**  
Author : **Sri P. Venkateswara Rao,**

©  
**State Institute of Vocational Education  
Andhra Pradesh, Hyderabad.**

Printed and Published by  
the Telugu Akademi, Hyderabad on behalf of  
State Institute of Vocational Education  
Govt. of Andhra Pradesh, Hyderabad.

**First Edition : 2005**

**Copies :**

All rights whatsoever in this book are strictly reserved and no  
portion of it may be reproduced any process for any purpose  
without the written permission of the copyright owners.

**Price Rs:       /-**

---

**Text Printed at .....**  
**Andhra Pradesh.**

**AUTHOR & EDITOR**

**Puli Venkateshwara Rao, M.E. (STRUCT. ENGG.)**  
**Junior Lecturer in Vocational, WS & SE**  
**Govt. Junior College, Malkajgiri,**  
**Secunderabad.**

# IVC

SECOND YEAR

*WATER SUPPLY AND SANITARY ENGINEERING*

## CIVIL ENGINEERING DRAWING



STATE INSTITUTE OF VOCATIONAL EDUCATION  
DIRECTOR OF INTERMEDIATE EDUCATION  
GOVT. OF ANDHRAPRADESH

## CONTENTS

Chapter No.	Name of the chapter	No. of periods	Pg. No.
1.	Conventional Signs, Doors, Windows, Footings	25	1
2.	Building Drawing	60	12
3.	Detailed Drawings of Water Supply and Drainage Connections to Building	15	28
4.	Layout of Various Water Supply and Sanitary Fittings in Bath and W.C	10	33
5.	Overhead Tank	05	37
6.	Septic Tank, Manhole and Dispersion Trench	15	40
7.	Layout Sketch of Water Purification Plant	05	48
8.	Layout Sketch of Sewage Treatment Plant	05	51
9.	Tracing and Preparation of Ammonia Prints	20	54
TOTAL PERIODS		160	

### EXERCISE

## LIST OF PRACTICALS

<b>PRACTICAL NO.</b>	<b>NAME OF THE PRACTICAL</b>	<b>PAGE NO.</b>
1	ENGG. MATERIALS SYMBOLS	3
2	WATER SUPPLY AND SANITARY FIXTURES SYMBOLS	4
3	ELECTRICAL INSTALLATIONS SYMBOLS	5
4	FULLY PANELLED DOOR	9
5	FULLY PANELLED WINDOW	10
6	ISOLATED R.C.C. SQUARE FOOTING	10
7	CROSS SECTION OF LOAD BEARING WALL	11
8	SINGLE ROOM BUILDING	16
9	TWO ROOM BUILDING	19
10	RESIDENTIAL BUILDING - I	21
11	SINGLE BEDROOM HOUSE	23
12	RESIDENTIAL BUILDING - II	25
13	TWO STOREYED BUILDING	26
14	LAYOUT AND SECTION OF WATER SUPPLY AND DRAINAGE CONNECTIONS TO A BUILDING	32
15	LAYOUT OF WATER SUPPLY IN SINGLE STOREY BUILDING	34
16	LAYOUT OF DRAINAGE SYSTEM IN MULTI STOREYED BUILDING	36
16	OVERHEAD TANK	39
17	SEPTIC TANK FOR 10 USERS	43
18	SEPTIC TANK FOR 50 USERS	43
19	DISPERSION TRENCH	45
20	DROP MANHOLE	47
21	TYPICAL LAYOUT OF WATER TREATMENT WORKS	50
22	LAYOUT OF SEWAGE TREATMENT PLANT	53



## **CHAPTER 1**

### **CONVENTIONAL SIGNS, DOORS, WINDOWS, FOOTINGS**

#### **INTRODUCTION :**

Drawing is the language of engineers. An engineer must be well conversant with drawings. Drawings represent reduced shape of structure and the owner will be able to see what is going to happen. Drawings are prepared as per the requirements of owner. In case of public buildings, the functional aspects are studied and accordingly the drawings are prepared as per recommendations laid down in National Building Code (N.B.C) or as per Indian Standard specifications. Any modifications like additions or omissions can be suggested from a study of the drawings before actual construction of the structure is started. Drawings provide a language with specific data to Architects, Engineers and workmen at the site to construct the structure accordingly.

In case of public buildings or any other civil engineering works, it is essential to work out different items of construction with their quantities for estimating the total cost of construction project. For this purpose, drawings of different parts and different views are essential so that the approval of work from the sanctioning authority can be obtained. Further, the detailed drawings form an essential contract documents, when the work is handed over to a contractor. Hence it is necessary to prepare detailed drawings, which will inform the contractor, the exact information, which he needs during the construction of different items of work. Drawings, thus prepared should be carefully even after the completion of work. Thus, it becomes assesses the possibility of further vertical expansion by referring to the foundation details initially provided.

#### **REQUIREMENTS OF GOOD DRAWING:**

1. Drawing should be clear, simple and clean
2. Should agree with the actual measurements by the accurately drawn scaled measurements.



3. Exact information should be provided in order to carry out the work at site without scaling for missing measurements.
4. Only minimum notes to support the drawings should be indicated in the drawings.
5. Sufficient space should be provided between the views so as to mark the dimensions without crowding.













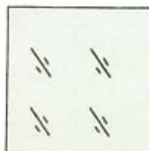





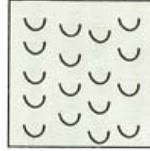



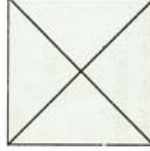

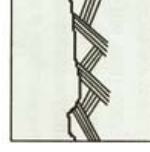



#### **1.0 CONVENTIONAL SIGNS AND SYMBOLS:**

Conventional signs are used to represent the particular item like stone masonry, brick masonry, concrete etc in the section of drawing. (i.e.,) when the materials are cut by any imaginary plane. Conventional symbols are provided to indicate doors, windows, their fixing, movement of shutters. When they are closed or opened, various water supply and sanitary fixtures like tap, wash basin, W.C., urinals, Kitchen sink, shower etc, symbols are used to indicate the position of electrical fittings like lamp, switch, power socket, fan etc. To indicate positions of furniture on drawing room, bedroom, suitable symbols are used.

The Bureau of Indian standards (B.I.S) has recommended the conventional signs and symbols for the following purposes.

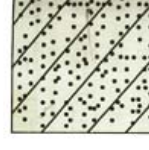
1. Avoid confusion and to understand the drawings
2. Save the time in making out various details in the drawing
3. Identify the various details of materials, Electrical fixtures, water-supply and sanitary fittings, Position of furniture's etc.
4. To prevent any dispute between contractor and owner in the actual construction of the structure.

The conventional signs for civil engg. materials as shown

	<b>BRICK</b>		<b>CONCRETE</b>		<b>CLAY TILE UNGLAZED</b>		<b>GLASS</b>
	<b>BRICK EXISTING</b>		<b>CONCRETE EXISTING</b>		<b>CERAMIC TILES</b>		<b>SHEET METAL</b>
	<b>STONE</b>		<b>CINDERS</b>		<b>PLY WOOD</b>		<b>STEEL AND CAST IRON</b>
	<b>STONE EXISTING</b>		<b>SAND</b>		<b>ROUGH WOOD</b>		<b>ALUMINIUM</b>
	<b>ASHLAR</b>		<b>GROUND LEVEL</b>		<b>WOOD ACROSS</b>		<b>WATER, OIL, PETROL</b>
	<b>RUBBLE STONE</b>		<b>EARTH</b>		<b>WOOD ALONG</b>		<b>FIBRE BOARD AND INSULATING BOARD</b>
	<b>PLASTER</b>		<b>ROCK</b>		<b>WOOD</b>		<b>STRUCTURAL SECTIONS</b>
	<b>PLASTER EXISTING</b>		<b>CLAY TILE GLAZED</b>		<b>GRAINS</b>		<b>STEEL</b>

**Practical 1. Engg. Materials symbols - diagrams**

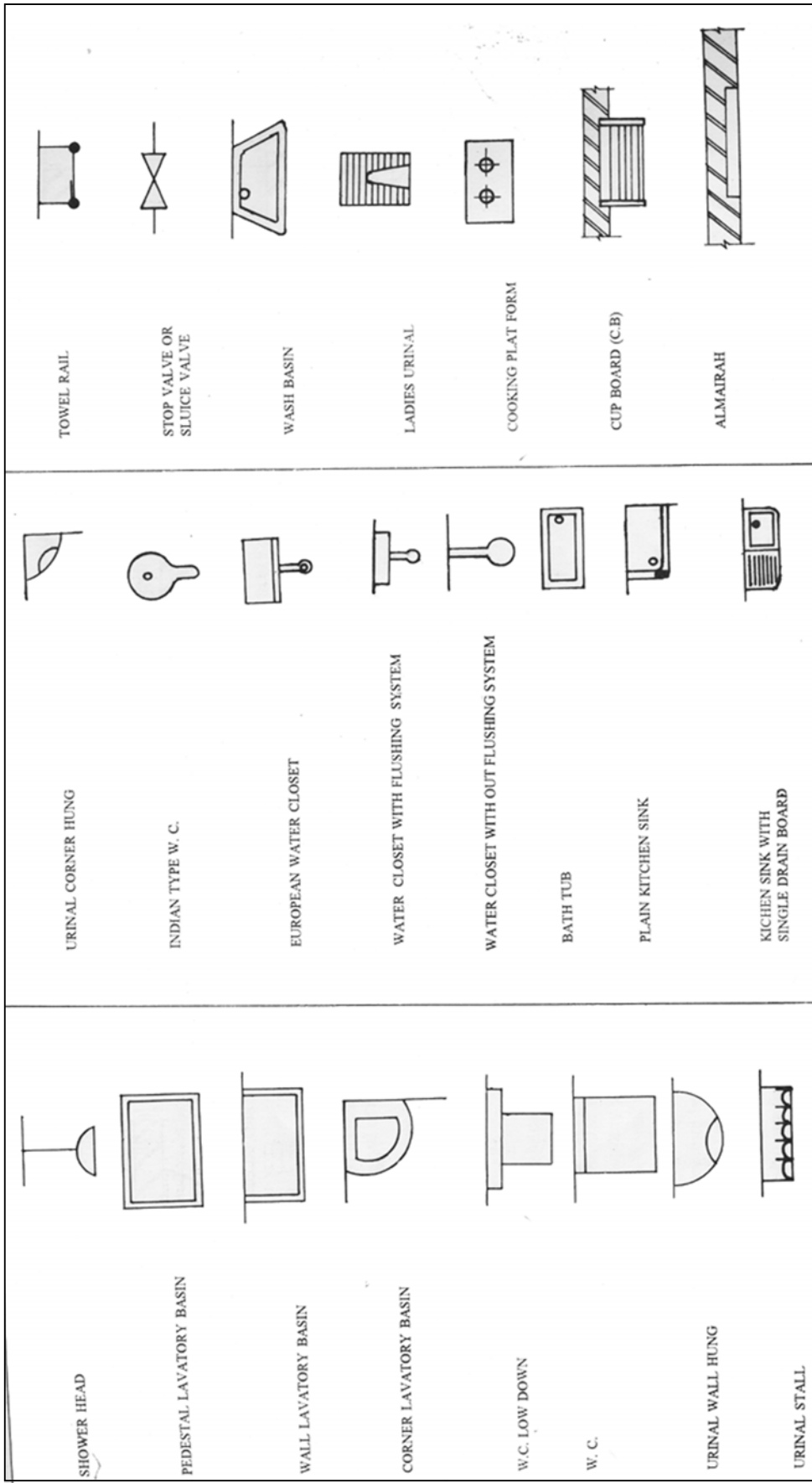

Practical 2. Water supply and Sanitary fixtures - diagrams

SYMBOLS FOR ELECTRICAL INSTALLATIONS						
LIGHT BRACKET		SOCKET - OUTLET 2 PIN 5 AMP		EXHAUST FAN		SOCKET OUT LET 3 PIN 15 AMP.
BATTERY LAMP HOLDER		SOCKET - OUTLET 3 PIN 5 AMP		COOKER CONTROL UNIT		
FLUORSCENT LIGHT (SINGLE) (TUBE LIGHT)		BELL PUSH		EARTH POINT		
FLUORSCENT LIGHT (DOUBLE) (TWO TUBE LIGHTS)		BELL		REFRIGERATOR		
MAIN POWER SWITCH		CEILING FAN		PUMP		
CHOKE				AUTOMATIC WASHING MACHINE		
ONE WAY SWITCH						
TWO-WAY SWITCH						

Practical 3. Electrical Installations – diagrams

## 1.2 DOORS:

Doors are the means to provide access to the rooms of a building. A door consists of a frame and one or two shutters or leaves. Accordingly they are called as single shuttered or double shuttered door.

Door frame consists of two vertical members called styles and two horizontal members one at top called top rail and one bottom rail or sill or threshold. Now-a-days the bottom rail is omitted and made to flush with floor level. The top rail is projected beyond the styles by about 150mm and these projections are known as horns. These are built into masonry for keeping in position. M.S. Clamps of flat iron about 300mm × 50mm × 6mm are fixed to the vertical styles on the outside known as "Hold Fasts" in the shape of letter 'Z'. These are embedded into the masonry wall to hold the frame in position. When bottom member (sill) is not provided, the vertical members (styles) should be inserted in the floor finish by about 40 mm to 50mm

Shutter for the door frame may be fully panelled or partly glazed and partially panelled with one or two leaves or shutters. In fully panelled shutter the no. of panels may be 3,4 or 6 as per the design and other practical considerations. In the case of door shutters, the horizontal members are called as rails (top, bottom, lock and frieze). All other rails fixed between the lock rail and top rail are called frieze rail. The continuous vertical members of door frame called as styles or stiles. These styles and rails jointed to each other at both ends by mortise and tenon joints. The bottom and lock rails are made wider than the top or frieze rails. The center of the lock rail shall be so placed that its center line is at a height of 850mm from the bottom of the shutter.

The joints between the panel and frame shall be tongued and grooved joints. Grooves are formed along the inner edges of the stiles and rails to receive the panel. The depth of groove is equal to the thickness of panel. As per IS1003; the minimum width and thickness of panel shall be 100mm and 15mm respectively. For double leaf shutter, when closed, one leaf overlaps the other vertically as a rebated joint. In order to keep the both shutters in the same plane, rebates 8 to 10mm wide and in depth equal to half thickness of a shutter for a square type are cut as for IS:6198.

### I.S.1003 RECOMMENDED SIZES FOR DOORS AND WINDOWS:

- |  |   |           |
|--|---|-----------|
| a) Vertical stile, top and frieze rail width | : | 150 ± 3mm |
| b) Lock rail width                           | : | 150 ± 3mm |
| c) Bottom rail width                         | : | 200 ± 3mm |
| d) Mounting width                            | : | 100 ± 3mm |

- e) Glazing bar :  $40 \pm 1\text{mm}$   
f) Thickness for all members :  $35 \pm 1$  or  $40 \pm 1\text{mm}$

As per A.P.D.S.S. (Andhra pradesh detailed standard specifications) doors and windows are indicated by following letters.

D = Door	W = Window
V = Ventilator	S = Single shutter
T = Double Shutter	P = Two Panels
R = Three Panels	Q = Four Panels

### FOOTINGS:

The portion of the building constructed above the ground level is super structure and below the ground level is substructure or foundation, which will distribute the structural load over the large area. In the case of load bearing walled structure, the size of wall is increased by means of footings of stone masonry or brick masonry and finally rest on concrete bed of required size.

Footings are the steps provided under the load bearing walls by equal increase on either side. The number of footings depends upon the depth of foundation. The increase in width provided on either side of wall face is known as off-set. The depth of the foundation is the vertical height below ground level upto the bottom of the concrete bed.

Individual masonry pillars are constructed with offsets on all four sides to provide number of footings. This entire masonry structure rests on concrete bed of required size, which distribute the load intensity on the sub-soil at low magnitude than the safe bearing capacity of subsoil. Such a foundations are known as isolated footing foundation.

Plinth is the portion of the structure between the surrounding ground level and the surface of the floor level immediately above the ground is termed as plinth. The level of the plinth is usually called as plinth level and the built up area at the floor level is known as plinth area. The plinth height in any case shall not be less than 450mm.

The depth of the foundation depends upon as per NBC and shall not be less than 500mm.

1. Bearing capacity
2. Shrinkage and swelling properties of soil
3. Depth of water-table
4. Depth of frost penetration

The width of the foundation depends upon the safe bearing capacity, load coming on the soil. The width of foundation  $B=2T+2f$  where 'f' offset provided.

Generally the concrete offset 'f' shall be 150mm. In case of brick masonry offset 1/4 th brick length (i.e., 50mm) and thickness shall be multiples of brick thickness (100mm, 200mm, 300mm, 400mm etc).

In case of stone masonry offset 'f' shall be 75 to 100mm and thickness may be 150 to 200mm.

**Thickness of concrete foundation:**

By thumb rule  $d = 5/6 T$  where 'T' Thickness of wall in super structure.

**Super structure:**

The portion of building above ground level is called super structure. This includes masonry walls, columns, steps, doors, windows, ventilators, lintels, sunshades (chajjas), staircase, roof, weather proof course, parapet wall etc.

**Lintels:**

Lintels are small beams, which are of reinforced cement concrete in present construction provided over small opening like door, window, almairahs etc. Generally 150mm thick and width equal to wall width are provided.

**Sunshade:**

Sunshade is sloping or horizontal R.C.C. cantilever slab provided over openings on external walls to provide protection from sun and rain.

**Balcony:**

Balcony is horizontal projection including a handrail or balustrade to serve as passage or sitting out place. As per IS:4912, the vertical height of handrail for balconies and verandahs shall be 1000mm.

**Portico:**

Portico or porch canopy is covered surface supported on pillars or otherwise for the purpose of pedestrian or vehicular approach. Generally the height of portico slab shall be 2.1m.

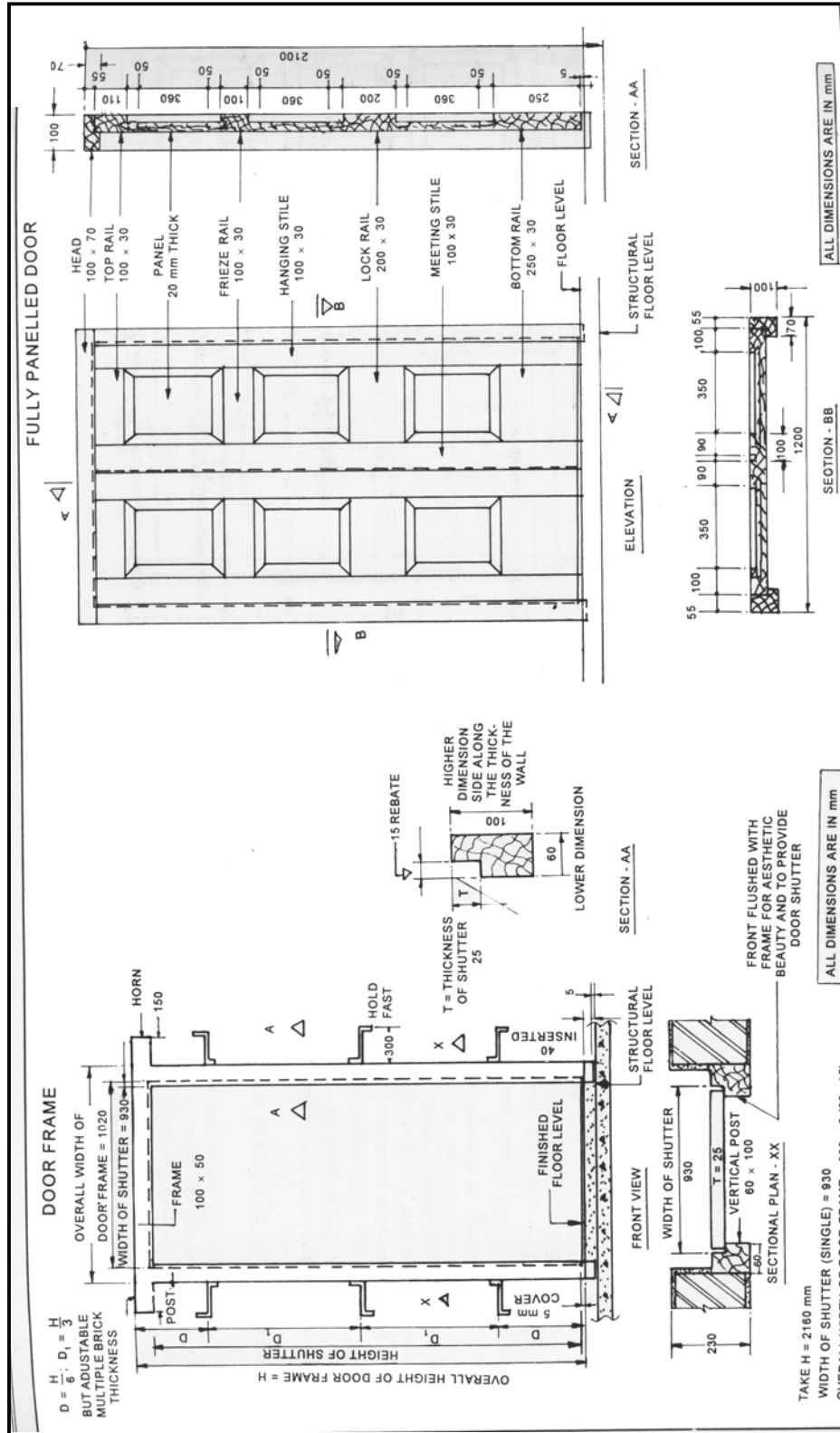

PRACTICAL 4 : Draw the following FULLY PANELLED DOOR



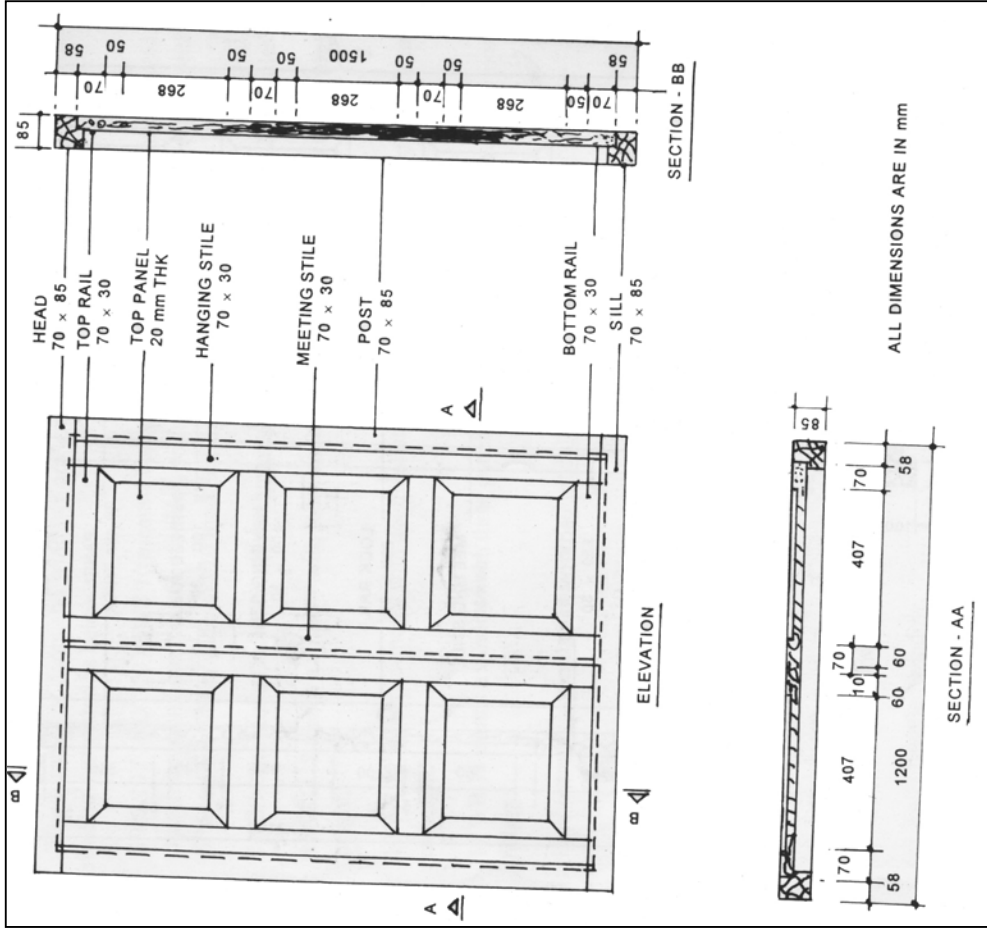

**PRACTICAL 5 - Fully Panelled Window**

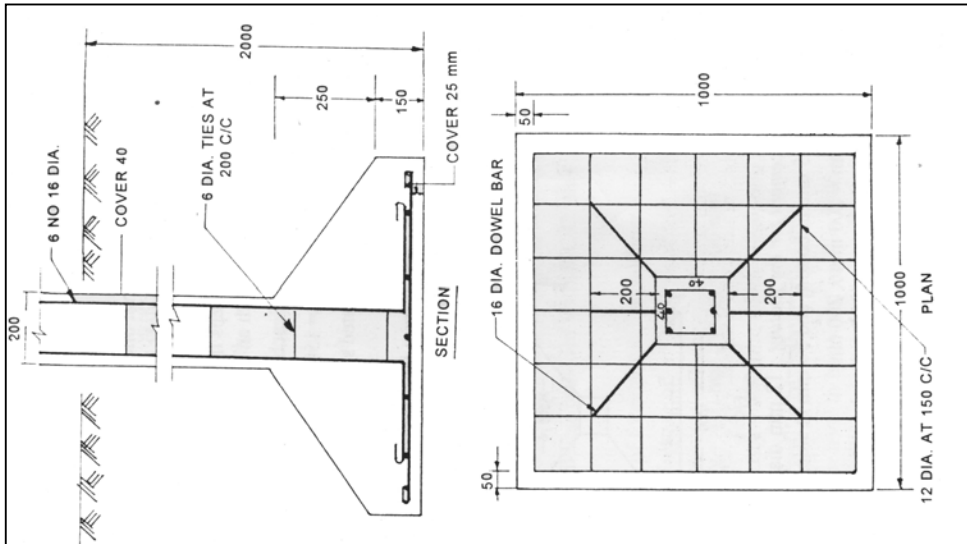

**PRACTICAL 6 - Isolated R.C.C. Square Footing**

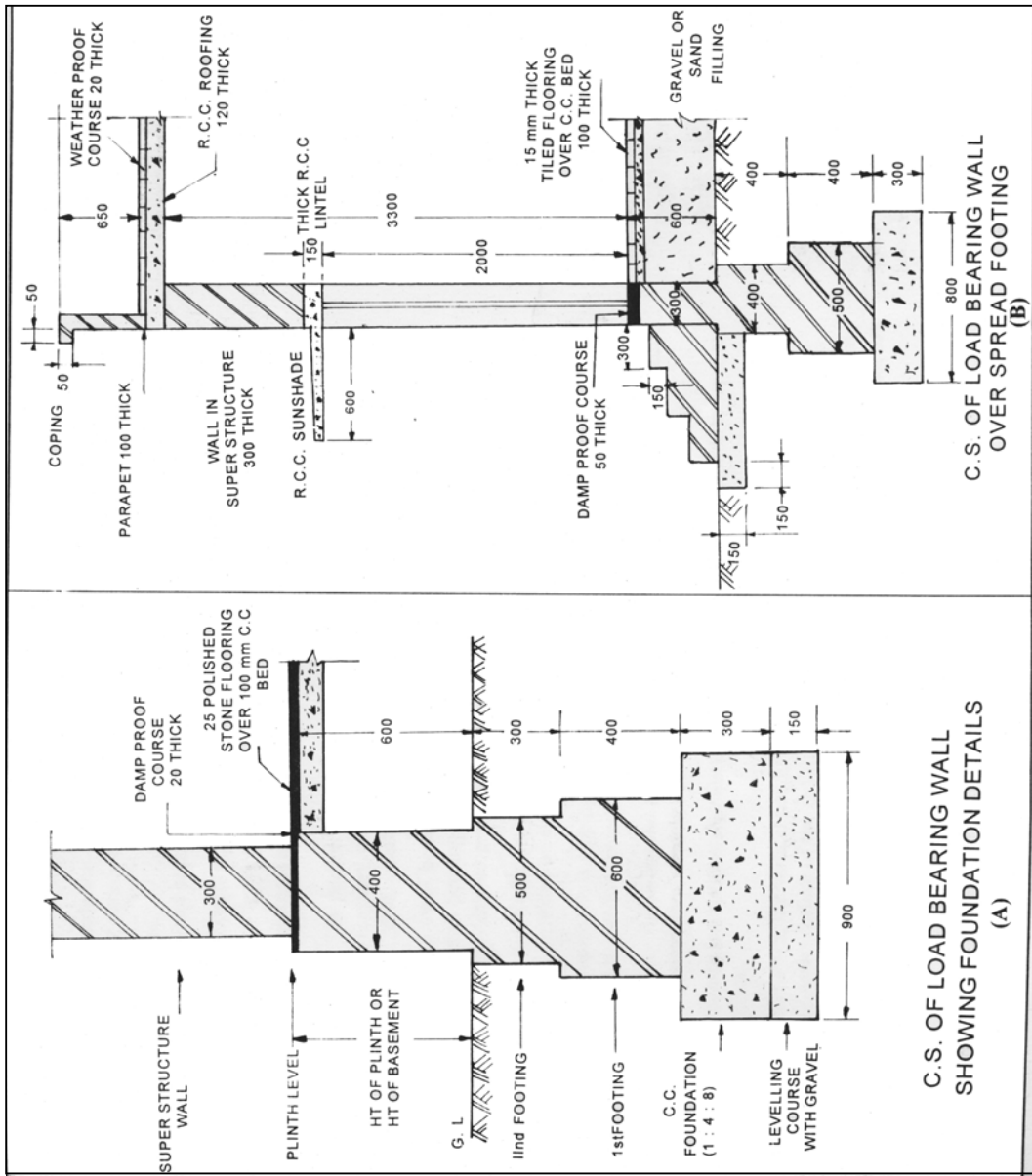

**PRACTICAL 7 - cross section of load bearing wall**

## CHAPTER 2

### BUILDING DRAWING

A building may be residential or public building. The plan, section along given vertical plane and elevation gives the details of building.

#### Plan:

Plan of building represents a horizontal section of building at given height seen from top. It is a general conventional to imagine that the building has been cut down by a horizontal plane at the sill level of the window and is seen from the top after removal of so cutpart. The plan shows the arrangement of rooms, varandah or corridor, position of door, and window and other openings along with their respective sizes. The dimension of the room indicated as Breath x Length

In the case of Varandah's, the given dimension upto the end of Varandah retaining wall and the position of beams, sunshades, portico, ventilators which are above sill level of window are shown with dotted or broken lines.

Line diagram is the sketch generally not drawn to particular scale also known as line sketch. The relative positions of all elements like rooms, doors, windows are clearly shown inside to inside. From the given specifications, the thickness of wall in super structure shall be taken to draw the fully dimensioned plan to a convenient scale.

#### Section :

Section is also known as vertical section and sectional elevation or cross section. It is imagined that a finished buildings is cut vertically along a line so that the building is separated into two portions along the imagined vertical plane right from top of the building to the lowest part of foundation. The view that can be seen while travelling along this imaginary vertical plane when looking towards left is drawn to the same scale as that adopted for the plan.

The line, which is drawn on the plan to indicate the section, is called sectional line and represented by A-B or X-X. The arrow heads shall be marked to indicate the way in which the sectional view is to be drawn. In some cases offset is given to indicate the necessary details, but the offset is only to shift the vertical plane from one position to another position as shown below.

The necessity of the section is to indicate all the vertical dimensions like, foundation details, basement, details of flooring, height of super structure, sizes of doors, windows, almairahs, cupboards, other

openings, thickness of roofing, width and depth of parapet wall, lintels, sunshades, portico and other details. All these details are required to calculate the quantities of items of work and to execute the process of construction.

**ELEVATION:**

Elevation or front view is the outward view of a completed building along any side of the building. When a building is seen by standing in front of it, the view that can be viewed is known as front elevation. Similarly backside view is called rear elevation or from any side of it which is known as side elevation.

**Development of views:**

(Method of obtaining plan section & elevation as shown in Fig No. 2.1 )

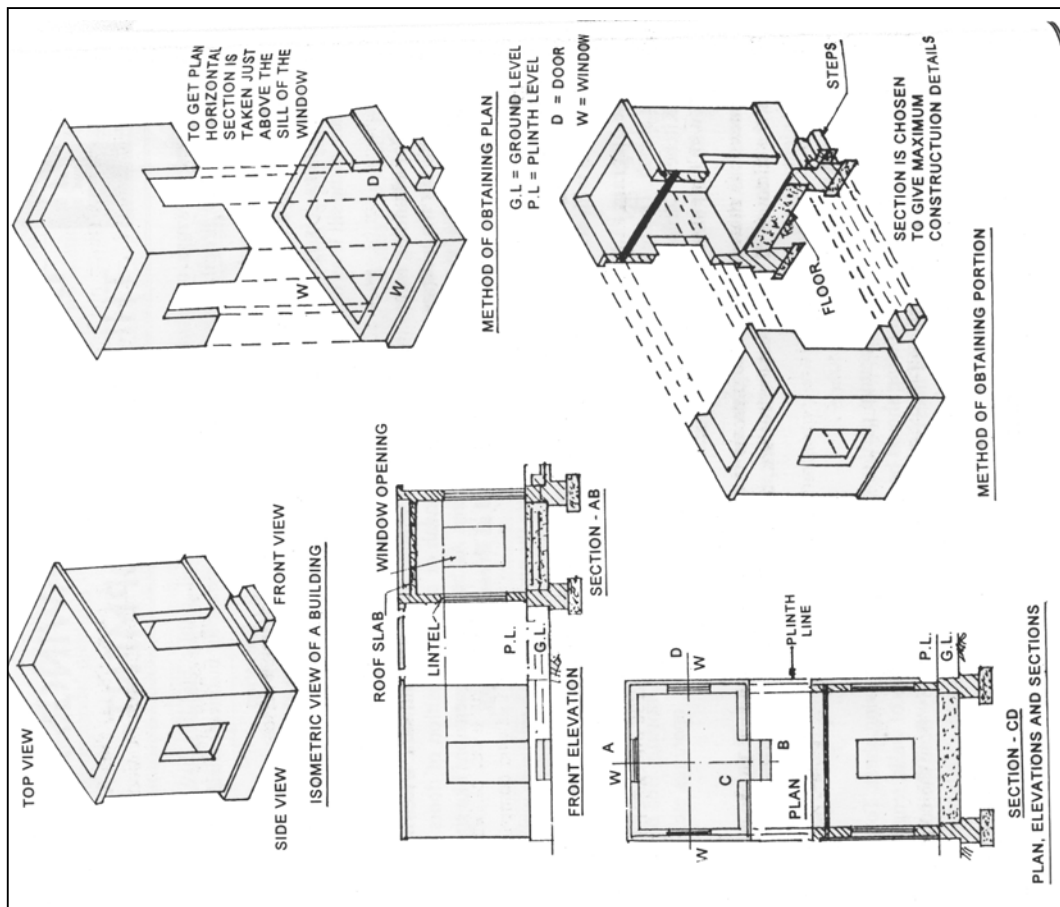

Fig No. 2.1

(i) **Development of plan:**

The plan should be drawn at the bottom portion on left side of drawing sheet. To start with, extreme left hand corner of the building should be taken and thickness of walls, length of walls along length wise (vertical lines) and breadth wise (horizontal lines) shall be drawn with a light pencil in order to complete in all respects by drawing cross-walls to show the position of doors, windows etc. Dimensions are shown in each room, width of wall etc and plan can obtained by accurate with sharp pencil lines.

(ii) **Development of section:**

The sectional view is drawn on the top right side of drawing sheet. The view shall be started from starting point of the section line and the horizontal dimensions along the section are represented in sequence in developing the sectional elevation

The section of walls from bottom to top, position of doors, windows that are viewed shall be drawn. From the given specifications, the foundation details, flooring details, roofing details are neatly drawn and such information is to be mentioned in the section. But the different materials used in the construction shall be indicated by drawing the respective conventional signs.

(iii) **Development of Elevation:**

The elevation is obtained by projecting the details from the plan vertically upwards and projecting details from the section horizontally towards left side. The intersection of these projections from plan and section help to draw the elevation. Hence the elevation shall be exactly above the top of the plan and is accomated in the top left side of the drawing sheet.

The first projection line shall be from plinth offset. The projections from sunshades, super structure walls and to end points for doors, windows shall be made both from plan and section to show the detailed drawing.

## PRACTICAL 8

The line diagram shows one room building. Draw (a) plan, section and front elevation to the scale of 1:50.

1. **Foundation:** All the walls are taken to depth of 1000mm below ground level and founded on C.C bed 800mm wide and 300mm thick. The brick masonry footing over C.C bed is 500mm wide with equal offsets of 150mm and depth is 700mm.
2. **Basement:** The height of basement is 450mm and width of wall is 400mm. Steps are provided both on front side and rear side over C.C bed 150mm thick with an offset of 150mm on all three sides. Tread and rise of steps are 300mm and 150mm.
3. **Flooring:** Flooring consists of 20mm thick C.M. 1:4 plaster over a bed of cement concrete (1:4:8) 100mm thick. The remaining part of basement is filled and compacted with sand.
4. **Superstructure & Roofing:** All the walls are taken to the height of 3300mm and 300mm thick.

The roof slab is provided with 120mm thick and projected by 200mm outer face of walls.

The roof slab is provided with weatherproof course 15mm thick.

5. **Sunshades:** Continuous sunshade is provided on front side of building. The thickness of wall end is 75mm and at the free end thickness is 50mm.

Isolated sunshades are provided over windows from R.C.C Lintels kept over such openings on other three sides.

In the all the above cases sunshades are extended 600mm from the face of wall.

6. **Lintels:** R.C.C lintels on all openings like doors, windows, and cupboards are 150mm thick having a bearing of 150mm on either side.

7. **Doors, Windows :**

D <sub>1</sub>	1No.	1000 x 2100mm	Flushed door
W <sub>1</sub>	3No.	1200 x 1500mm	glazed window

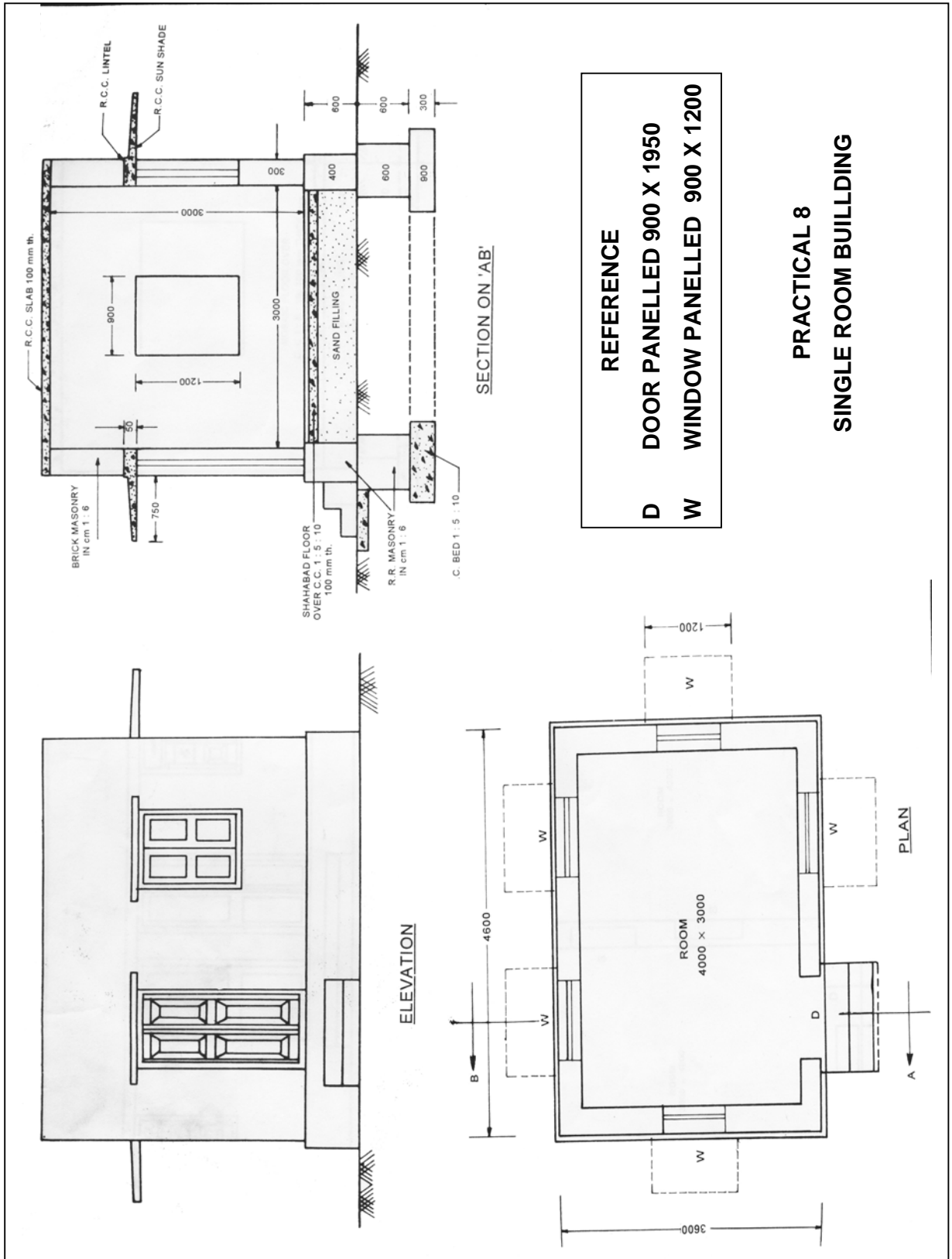

**REFERENCE**  
**D DOOR PANELLED 900 X 1950**  
**W WINDOW PANELLED 900 X 1200**

**PRACTICAL 8**  
**SINGLE ROOM BUILDING**

## PRACTICAL 9

The line diagram shows two rooms residential building. Draw (a) Plan and (b) section along A-A and (c) front elevation to the scale of 1:50.

1. **Foundation** : All the walls are taken to depth of 900mm below ground level and C.C bed 700mm wide and 300mm thick. Footing with brick masonry 400mm wide and 600mm depth.
2. **Basement** : The height of basement is 450mm and width of wall is 300mm. Steps are provided both on front side and rear side over a C.C bed of 150mm thick with an offset of 150mm on all three sides. Tread and rise of steps are 300mm and 150mm.
3. **Flooring** : Flooring consists of 20mm thick C.M. 1:4 over a bed of cement concrete (1:4:8) 100mm thick. The remaining part of the basement is filled and compacted with sand.
4. **Superstructure & Roofing**: All the walls are taken to a height of 3200mm and 200mm thick.

Roofing consists of R.C.C. slab roofing 120mm thick and projected by 200mm beyond the outer face of walls.

The roof slab is provided with weatherproof course 15mm thick.

5. **Sunshades**: Continuous sunshade is provided on front side of the building. The thickness of sunshade at the wall end is 75mm and at the free end thickness is 50mm.

Isolated sunshades are provided over windows and external doors extending the R.C.C Lintels kept over such openings on other three sides.

The projection of sunshades is extended 600mm from the face of wall.

6. **Lintels**: R.C.C lintels on all openings like doors, windows, and cupboards are 150mm thick having a bearing of 150mm on either side.
7. **Doors, Windows & Cupboards** :

D <sub>1</sub>	2No.	1000 x 2000mm	Fully Panelled Door
D <sub>2</sub>	1No.	900 x 1800mm	Fully Panelled Door
W	6No.	1000 x 1200mm	Fully Panelled Window
CB	1No.	1200 x 1500mm	Cupboard



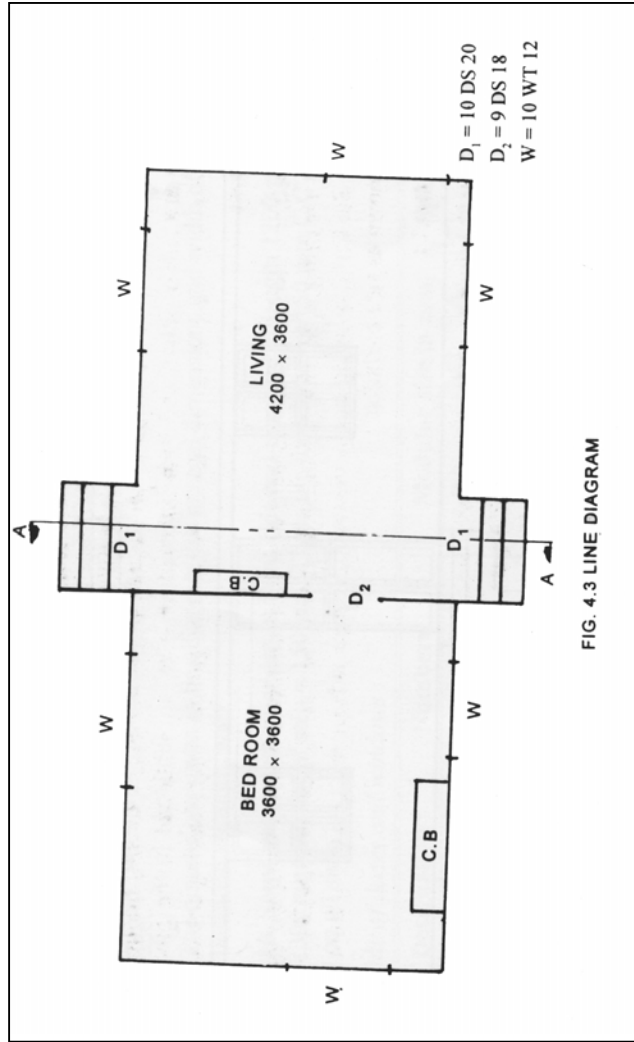
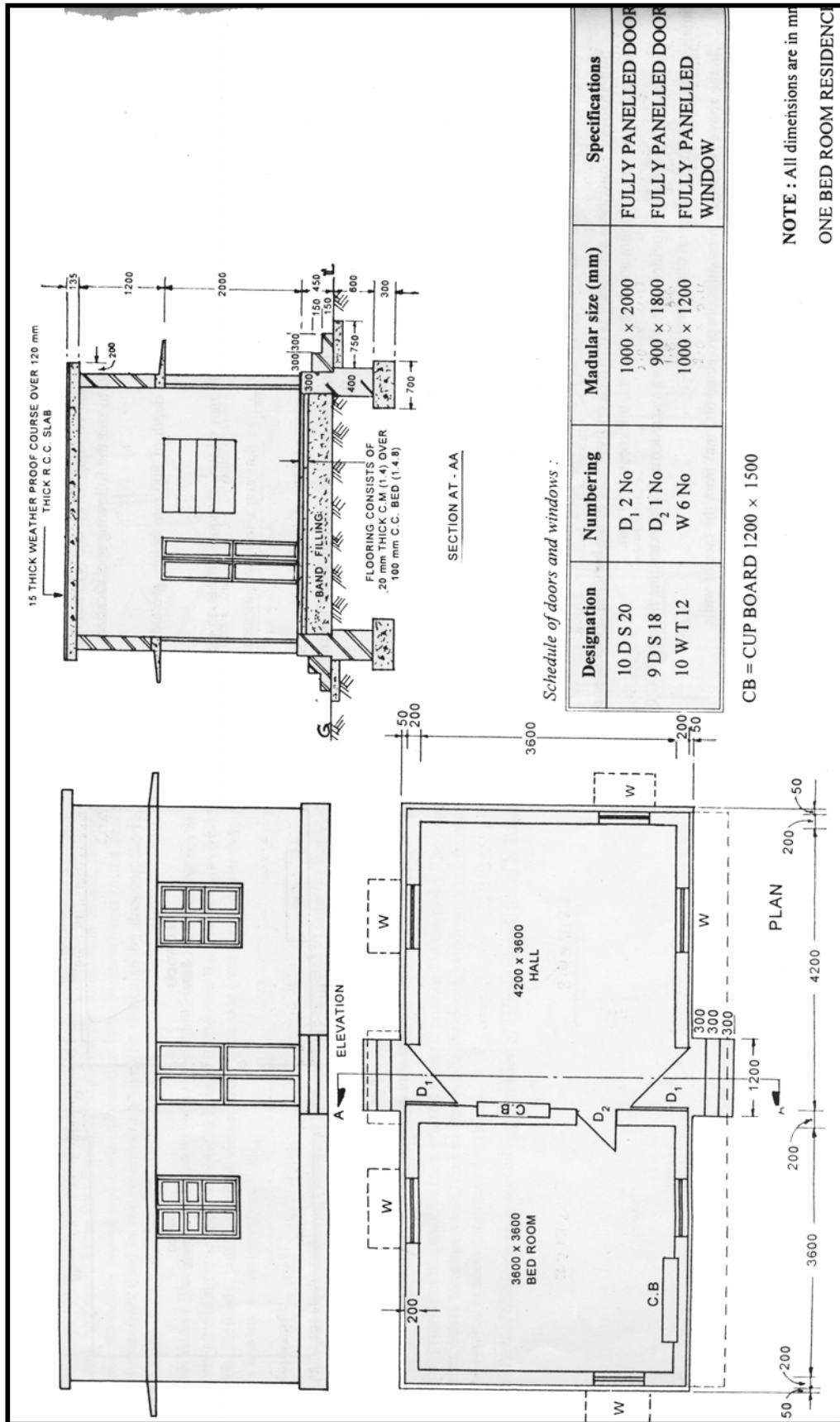

FIG. 4.3 LINE DIAGRAM

### PRACTICAL 9

### LINE DIAGRAM OF THE TWO ROOM BUILDING.



PRACTICAL 9 – TWO ROOM BUILDING

PRACTICAL 10

Draw Plan, Elevation and Section of the Residential Building as shown

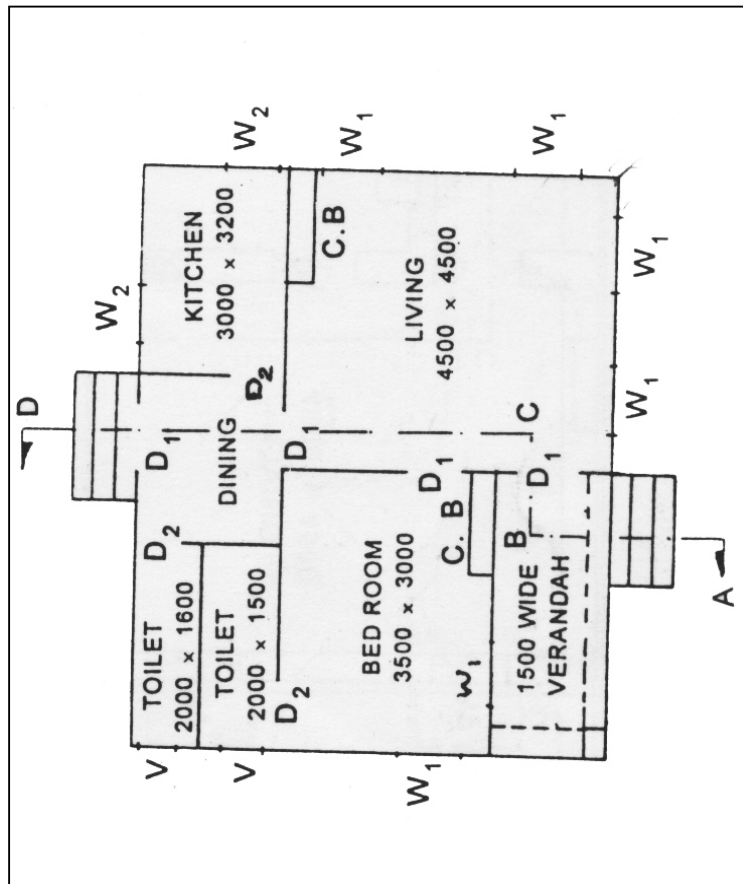

LINE DIAGRAM OF  
RESIDENTIAL BUILDING

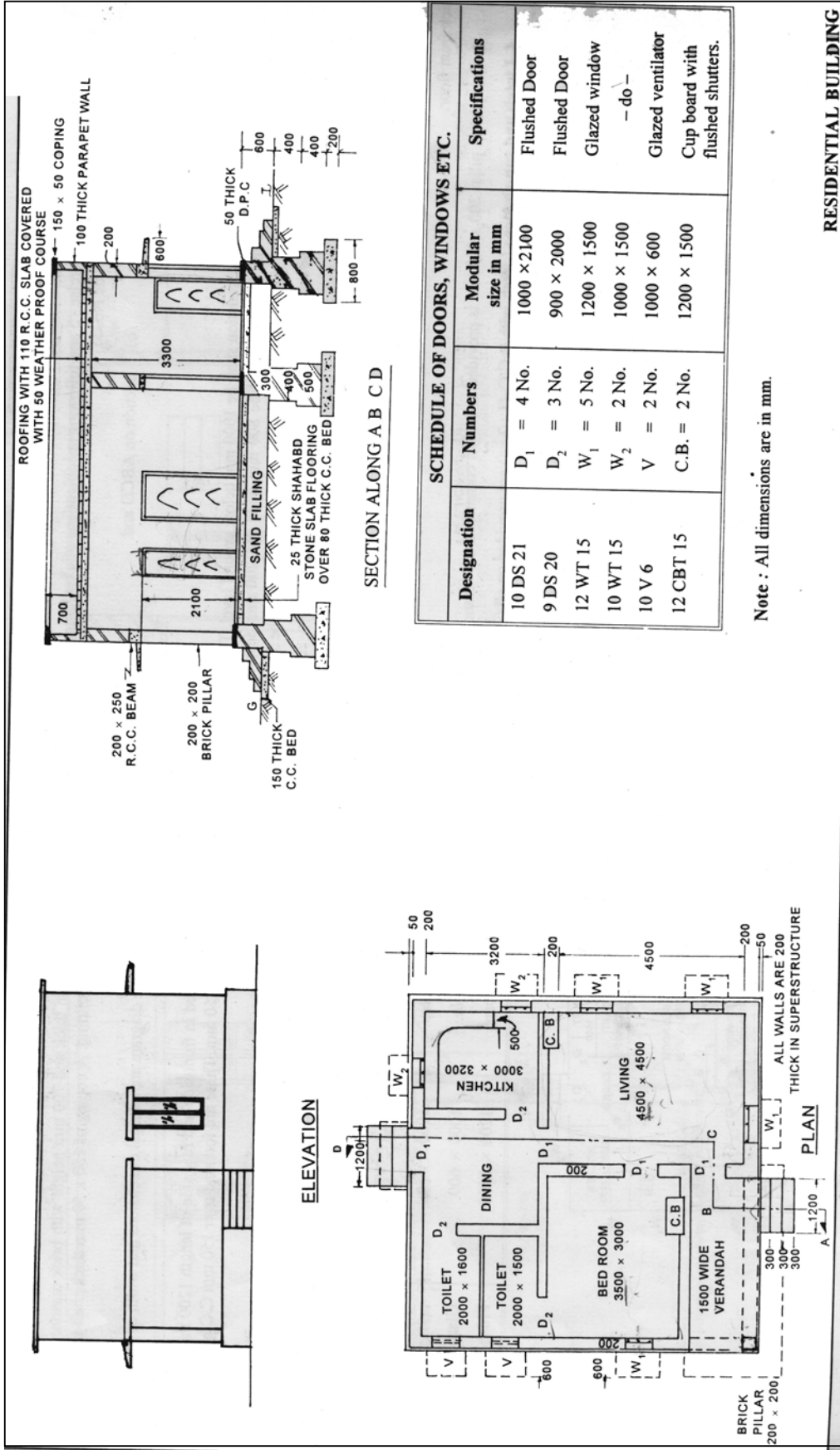

PRACTICAL 10 – RESIDENTIAL BUILDING

PRACTICAL 11

Draw Plan, Elevation and Section of the Single Bedroom House as shown

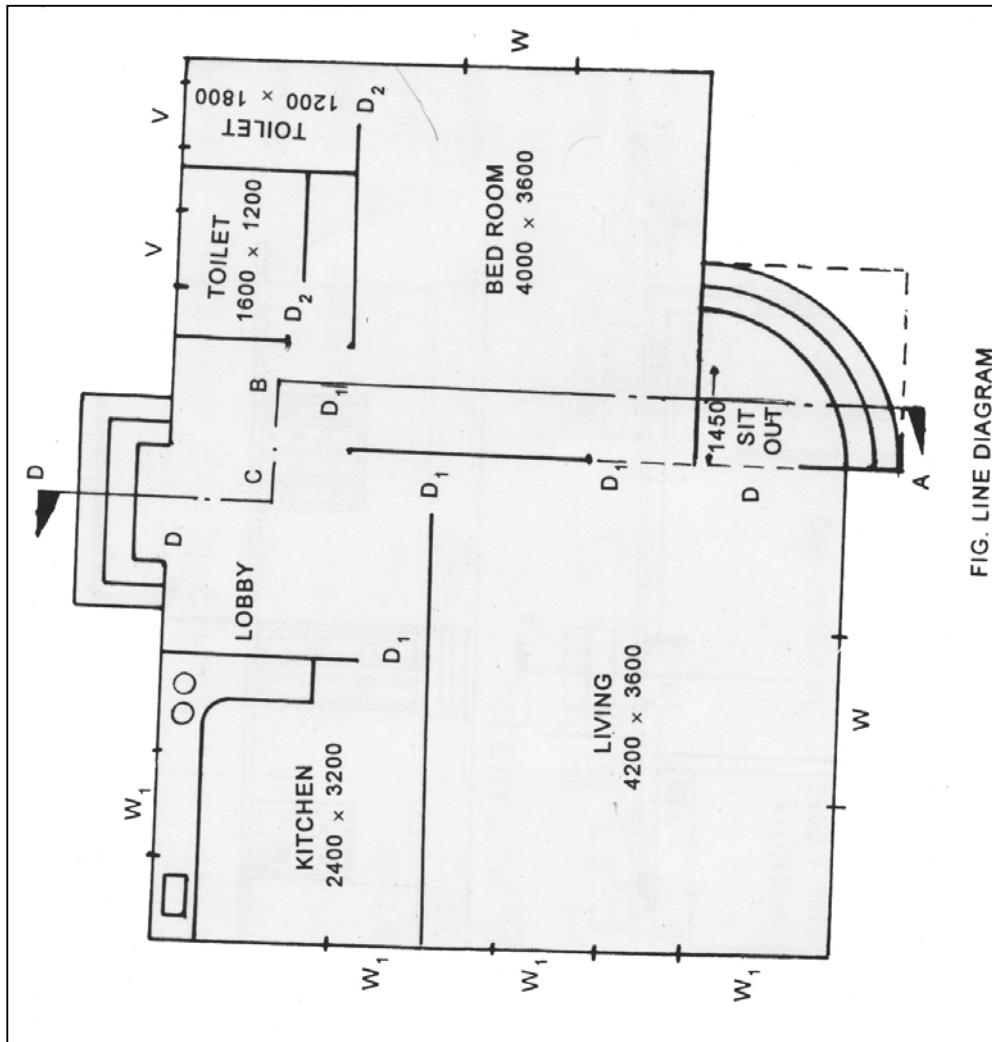
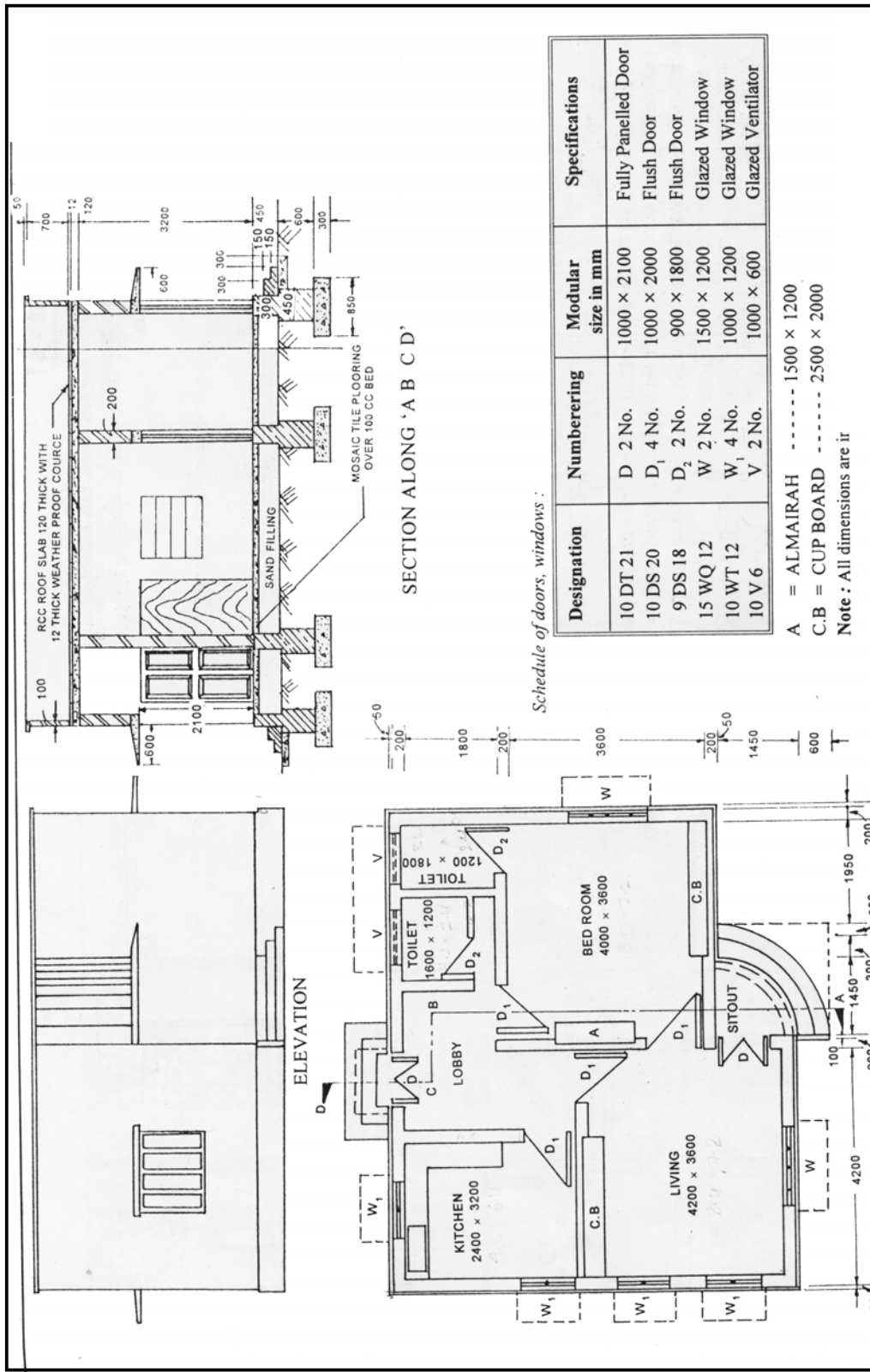

FIG. LINE DIAGRAM

PRACTICAL 11 – LINE DIAGRAM OF SINGLE BEDROOM HOUSE



**PRACTICAL 11 – SINGLE BEDROOM HOUSE**

**PRACTICAL 12**

**Draw Plan, Elevation and Section of the Residential Building as shown**

SCHEDULE OF DOORS, WINDOWS, VENTILATORS AND CUP BOARDS.

Designation	Numbering	Modular size in mm	Specifications
10 DT 21	D = 2 No	1000 x 2100	Fully panelled
10 DS 21	D <sub>1</sub> = 2 No	1000 x 2100	Flushed door
9 DS 18	D <sub>2</sub> = 3 No	900 x 1800	Flushed door
15 WQ 12	W <sub>1</sub> = 1 No	1500 x 1200	Glazed window
10 WT 12	W <sub>2</sub> = 7 No	1000 x 1200	Glazed window
15 CBT 18	C.B = 2 No	1500 x 1800	Flushed shutters
10 V 6	V = 3 No	1000 x 600	Glazed ventilator.

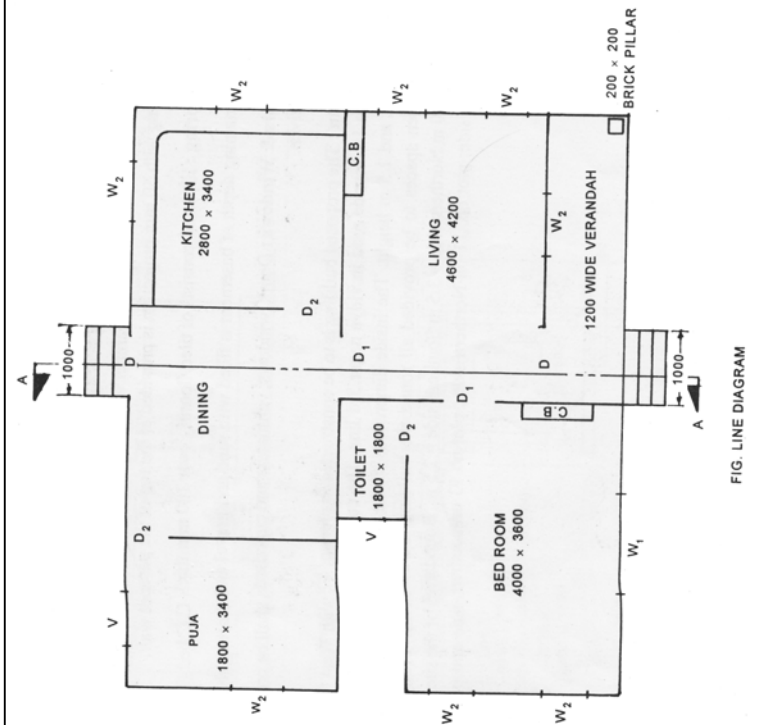
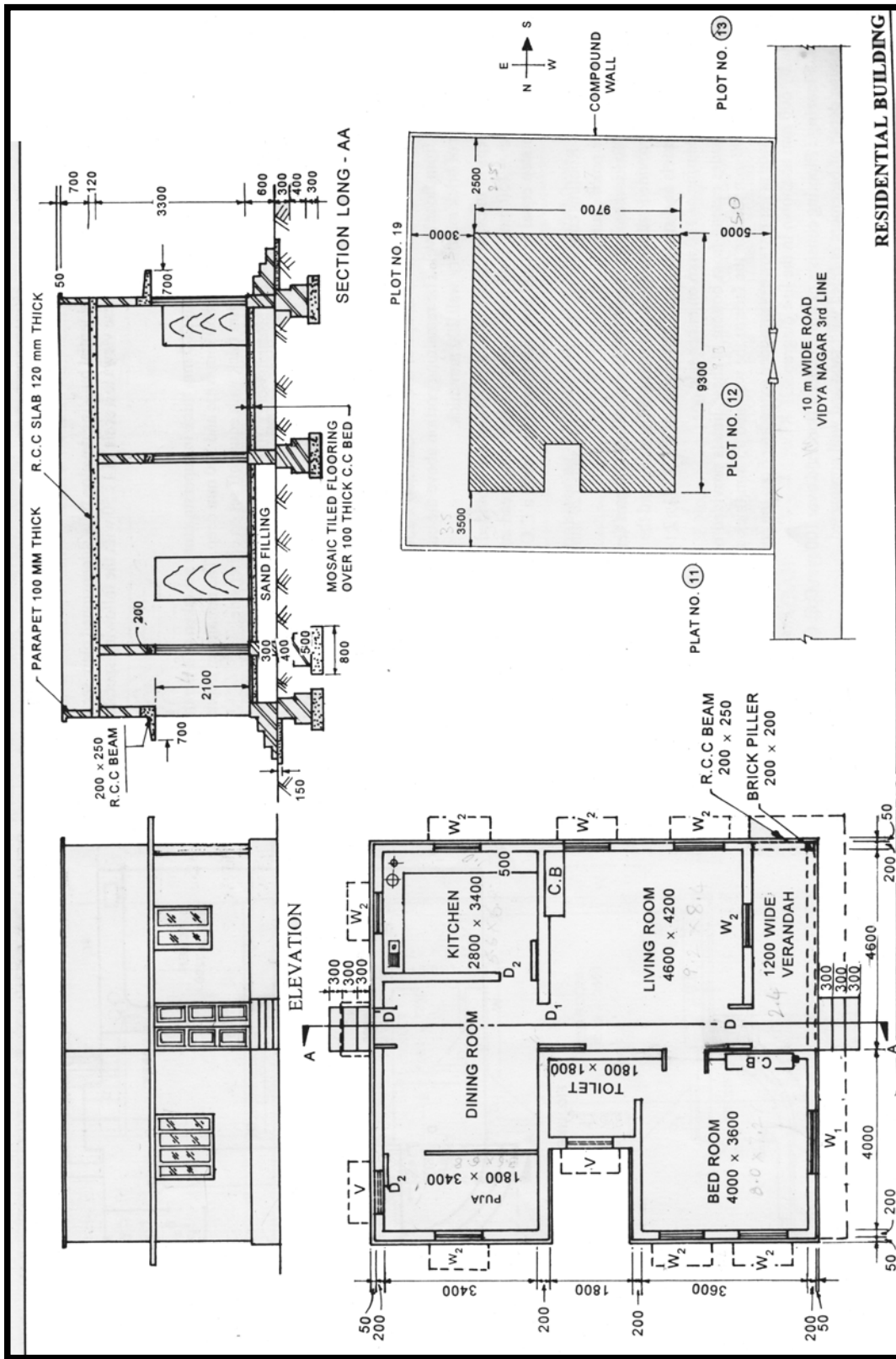

FIG. LINE DIAGRAM



PRACTICAL 13

Draw Plan, Elevation and Section of the Two Storeyed Building as shown



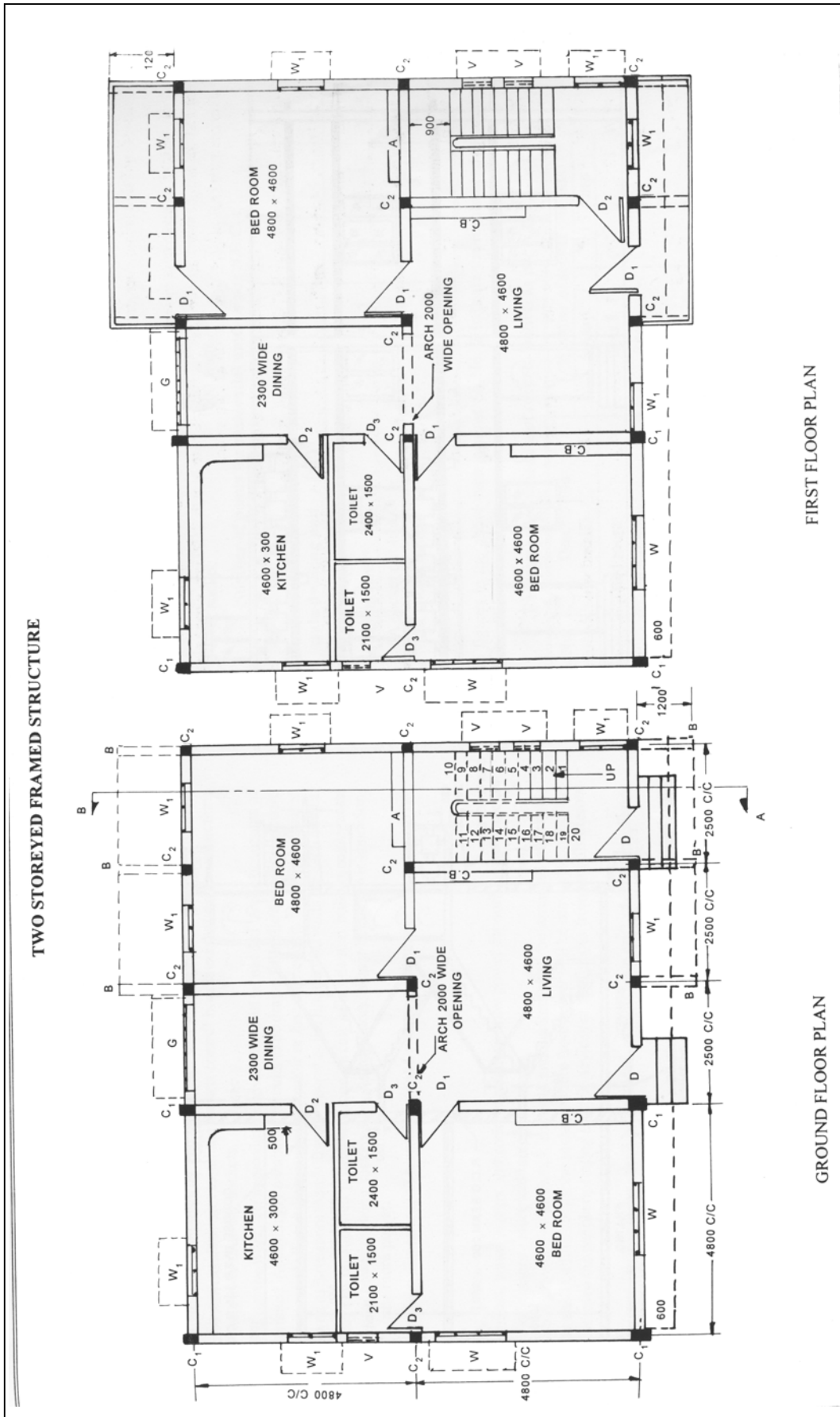

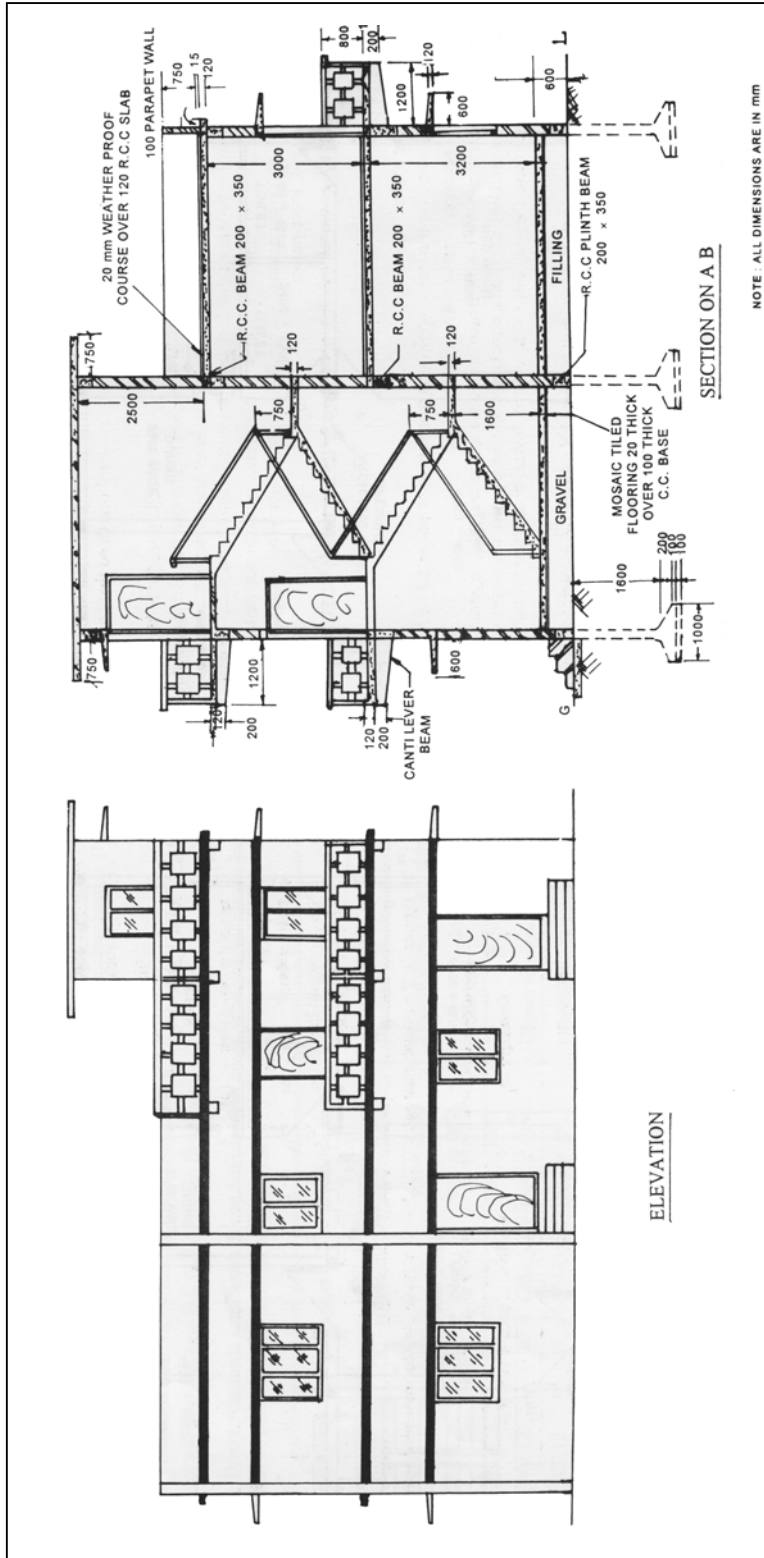

PRACTICAL 13- TWO STOREYED BUILDING

### CHAPTER 3

#### DETAILED DRAWINGS OF WATER SUPPLY AND DRAINAGE CONNECTIONS TO BUILDING

##### GENERAL :

For understanding of the principles and practices of water supply arrangements in building is essential for their correct installation, operation and efficient functioning. The definitions of the following terms should know.

1. **Residual head or available head:** It is the pressure head available at any particular point in the distribution system.
2. **Plumbing System:** It is the entire system of pipes fixtures, appliances etc for providing water supply and drainage to building.
3. **Water main or street main:** This is the water supply pipe for public or community use and maintained by local or administrative authority.
4. **Service pipe :** Any pipe used for conveying water from water main to any building or premises and it is subjected to water pressure from the water main is called service pipe.
5. **Communication pipe:** The part of the service pipe, extending from the water main upto and including the stop cock, which is under control of the authority is called communication pipe.
6. **Supply pipe:** The pipe which extends from the stop cock upto the ball cock or entrance of the storage tank if any and subjected to water pressure from the water main is called supply pipe and it is under the control of consumer.
7. **Distribution pipe:** it is the pipe connecting the storage tank to the various sanitary fixtures, taps etc for the purpose of distribution of water inside the building
8. Water supply fittings
  - (i) **Stop Cock:** Stop cock is a control valve fixed by the authority at the end of communication pipe. It is fixed in the street, close to the boundary wall in an accessible position in a suitable

masonry chamber. It controls the supply to the building from the water main

- (ii) **Ferrule:** Ferrule is a right angled sleeve made of brass or gun metal. It is jointed to an opening drilled in the water main to which it is screwed down with a plug and then connected to a goose neck or communication pipe. The Ferrule is usually made in a size varying from 10 to 50mm diameter
- (iii) **Goose neck:** It is flexible curved pipe about 75cm in length . It forms a flexible connections between the water main and service pipe to expansion and contraction of the service pipe and also due to small earth movements and vibrations

The general layout of water supply arrangements for a building is as shown in fig.

#### **DRAINAGE CONNECTIONS TO BUILDING:**

The wastewater coming from Kitchens, Bathrooms, water Closets, Urinals etc has to be properly drained in order to maintain healthy environment. If the waste water is not drained, it leads to stagnation in and around the building causing nuisance.

#### **Requirements of good drainage system in buildings:**

1. The foul matter should be quickly removed away from the sanitary fixtures
2. The drainage system should be able to prevent the entry of gases, vermin etc from the sewers into the buildings
3. The drainage pipes should be strong and durable
4. The pipes and joints should be air tight to prevent any leakage of waste water or gases
5. The network of pipes should have sufficient accessibility for inspection, cleaning and removing obstructions
6. The levels of building, sewer and other points of outlet should be fixed accurately
7. The pipes should be of non-absorbent material

8. The branch drains should be as short as possible
9. The drains should not pass near or under the trees to avoid the damage of pipes by the roots
10. As far as possible drains should not pass under building
11. The drains should be provided with proper ventilation to avoid air locks syphonage

The following pipes are used in drainage arrangements of a building

1. Soil pipe (SP): The soil pipes are those connected to water closets and through which liquid waste including human excreta flows.
2. Waste pipe (WP): The pipe carrying liquid waste from kitchens, bathrooms, wash basins etc which doesnot contain human excreta is called waste pipe.
3. Vent pipe (VP) : Ventilating pipe is one which enables the foul gases produced in pipes to escape into the atmosphere
4. Anti syphonage pipe: Antisyphonage pipe prevents the self or induced syphonage action. If synphonage takes place, the water seals of traps are sucked and give way for the entry of foul gases into the buiding through fittings, causing nuisance.

The following points should be considered in planning the layout of drainage connections to the various sanitary fittings

1. The layout should be simple and direct.
2. Designed slope should be maintained.
3. Concrete pads should be provided to support the pipes laid on the earthfull.
4. Only sanitary tees and quarter bends are used for a change of pipe from horizontal to vertical.
5. Manholes should be provided at all points of intersection of pipes.
6. All soil pipes, waste pipes and ventilating pipes may be conviently grouped in shafts or ducts for easy inspection or maintenance.
7. All surface pipes should have minimum clear distance of 5 cm from the wall.

8. The waste pipes should be separated from house drain by means of gully traps to prevent the entry of foul gases, vermin etc into the building.
9. Traps are required for very sanitary fixture and they should be as close to the fixtures as possible.

The typical layout of single storey building drainage system is shown in fig. 3.1.

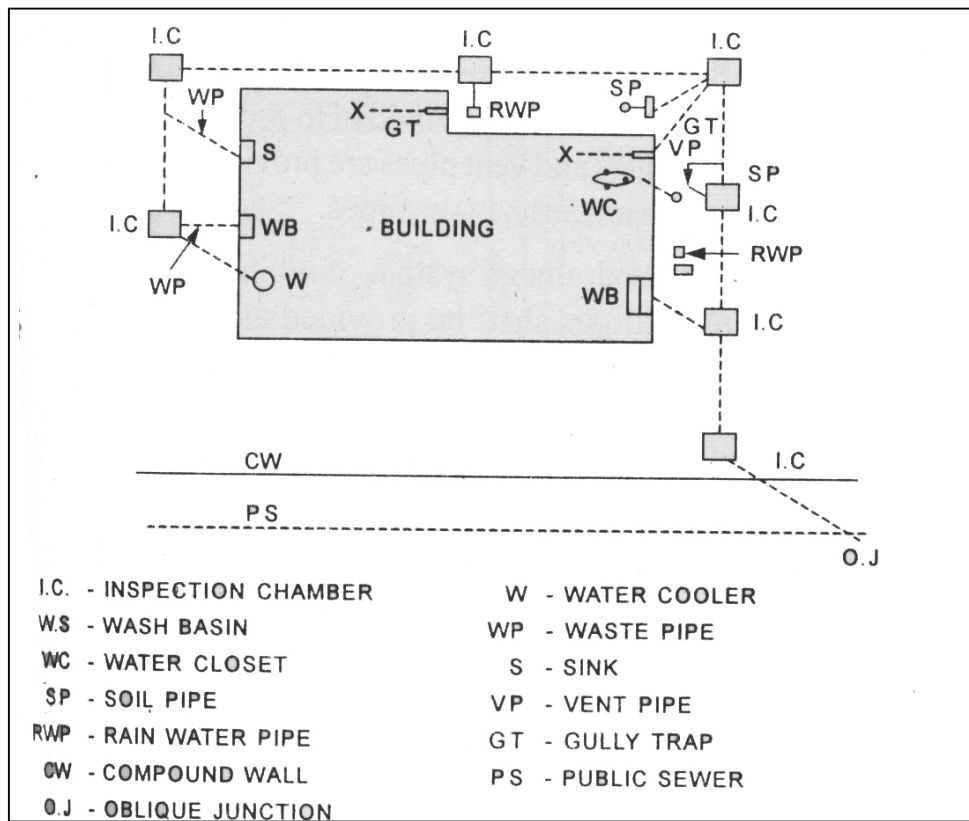

**Fig 3.1 Layout of Single Storey Building Drainage System**

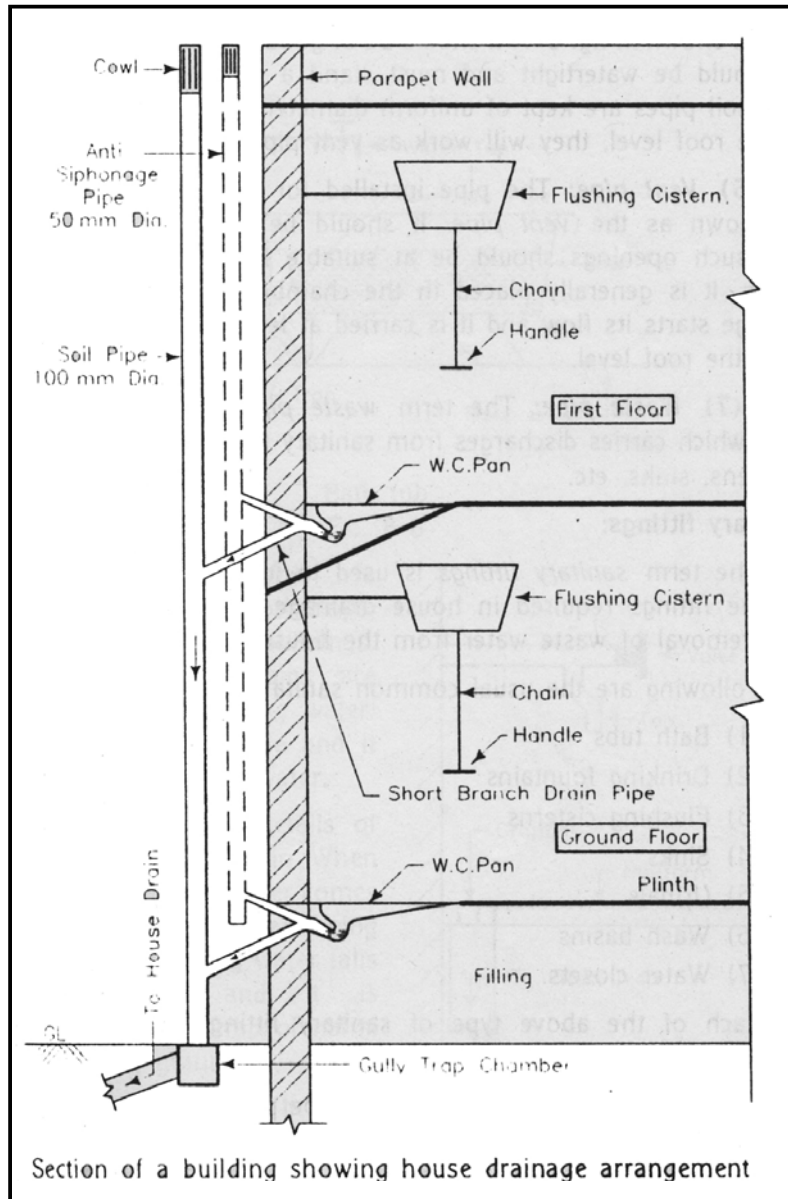

**PRACTICAL 14 - LAYOUT AND SECTION OF WATER SUPPLY AND DRAINAGE CONNECTIONS TO A BUILDING**

## CHAPTER 4

### LAYOUT OF VARIOUS WATER SUPPLY AND SANITARY FITTINGS IN BATH AND W.C

The different types of water supply pipes like communication pipes, supply pipes, distribution pipes, consumer's pipes and location of ferrules stop cocks and storage tanks are as shown in the Fig 4.1.

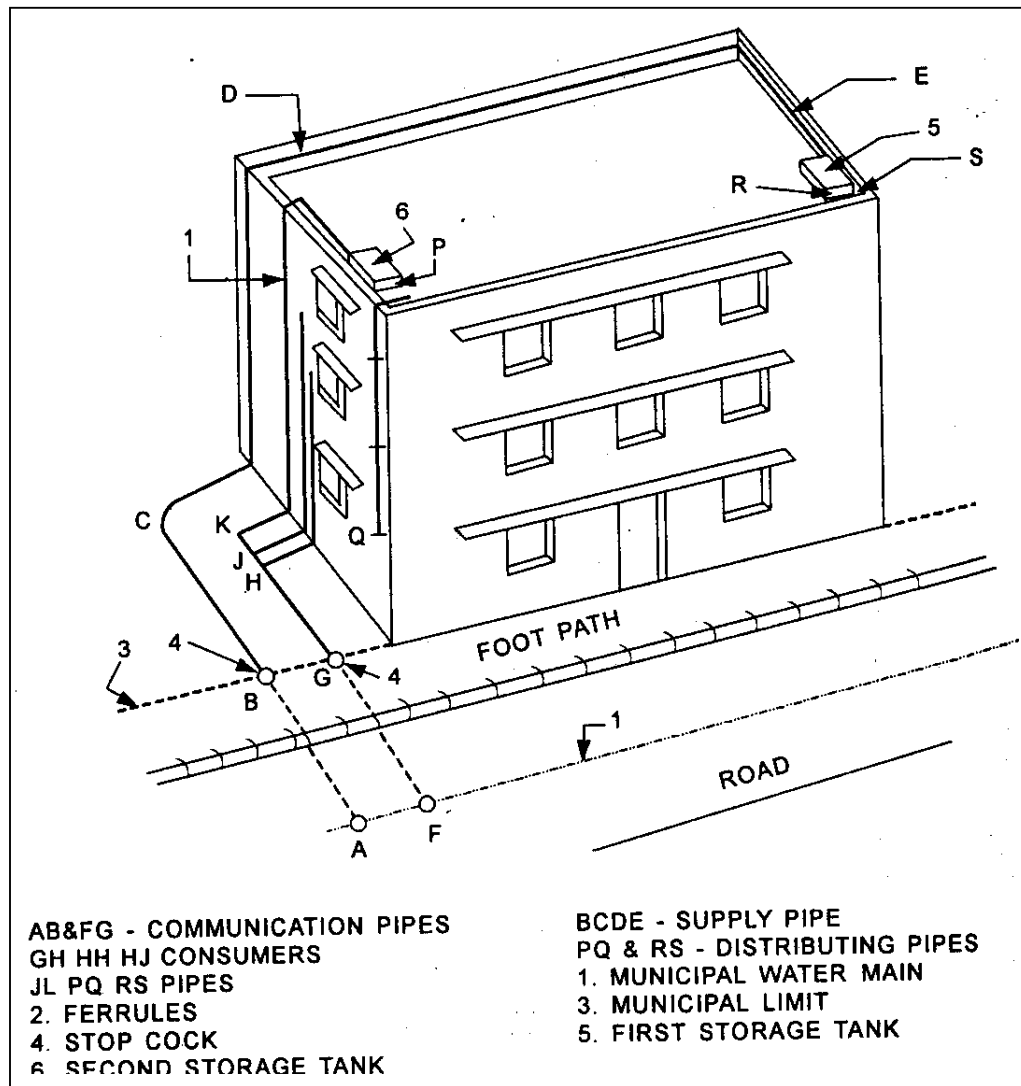

#### General layout of water supply arrangements single storey buildings:

The plan of layout of water supply arrangements is as shown in fig 4.2.



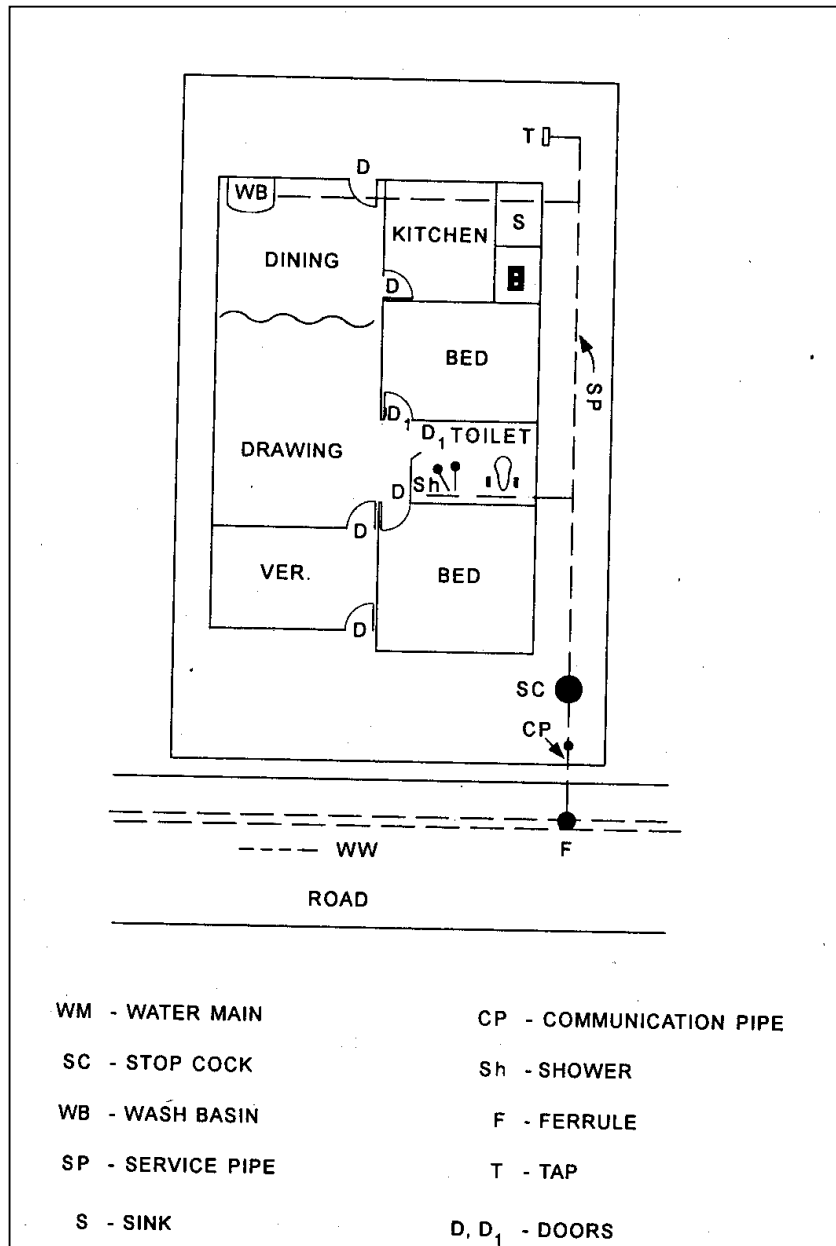

**PRACTICAL 15**

**Fig 4.2 Layout of Water Supply in Single Storey Building**

**General layout of water supply arrangement in multi storey buildings:**

The details of the layout of water supply arrangement in multi storeyed building is shown in fig 4.3

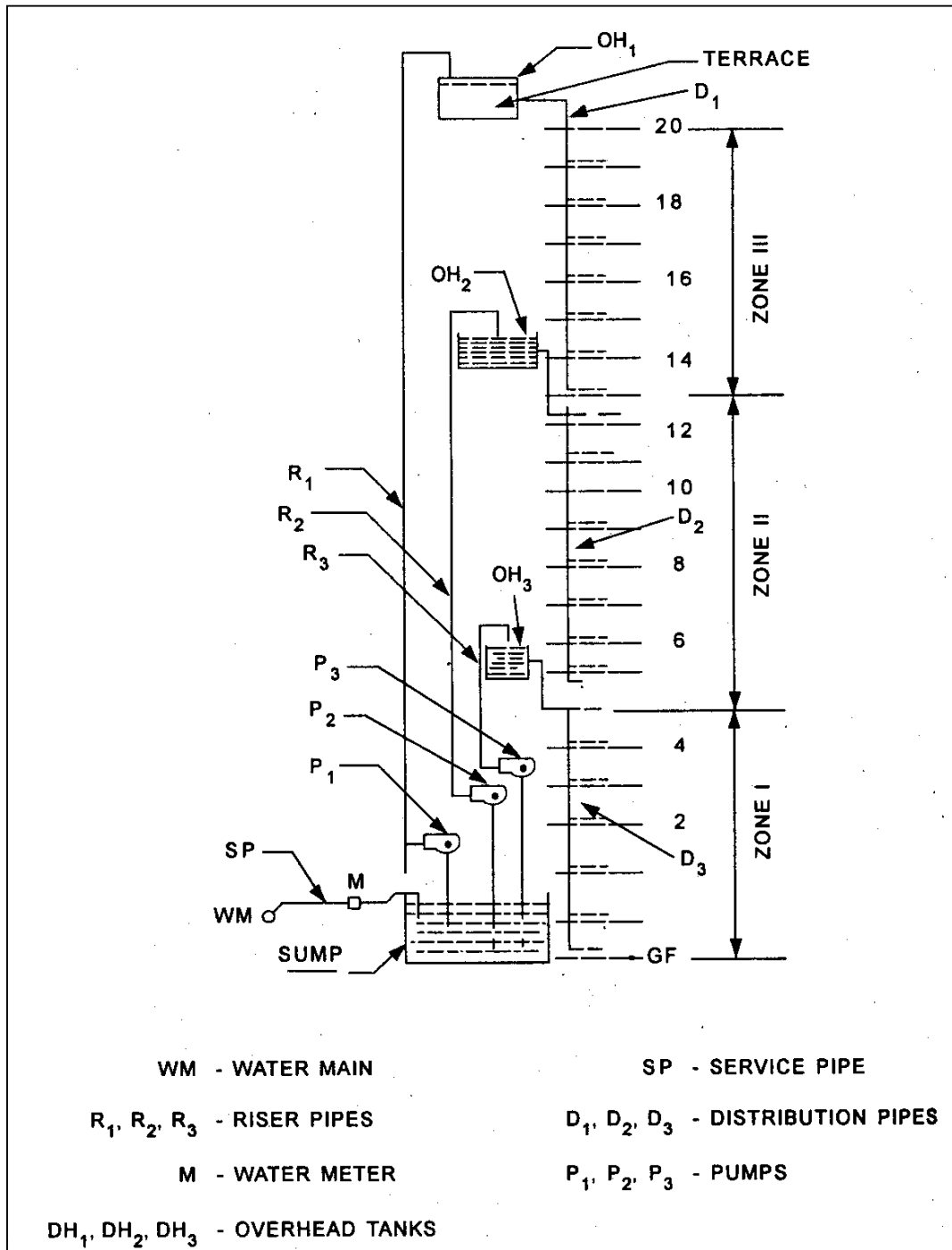

Fig 4.3 Water Supply Arrangements for a Multi Storeyed Building

**Sanitary Fittings:**

These are the receptacles, devices or appliances required for the efficient collection and removal of waste water from the building. The sanitary fittings used in the drainage system of buildings include traps, water closets,

flushing cisterns, urinals, inspection chambers, wash basins, sinks, bathtubs etc. The layout of the drainage in single storeyed building as shown in fig 3.1.

Fig 4.5 illustrates the drainage system of multi storeyed buildings. The drainage system in building shall be provided as per IS11721971 I.S. 1742-1972.

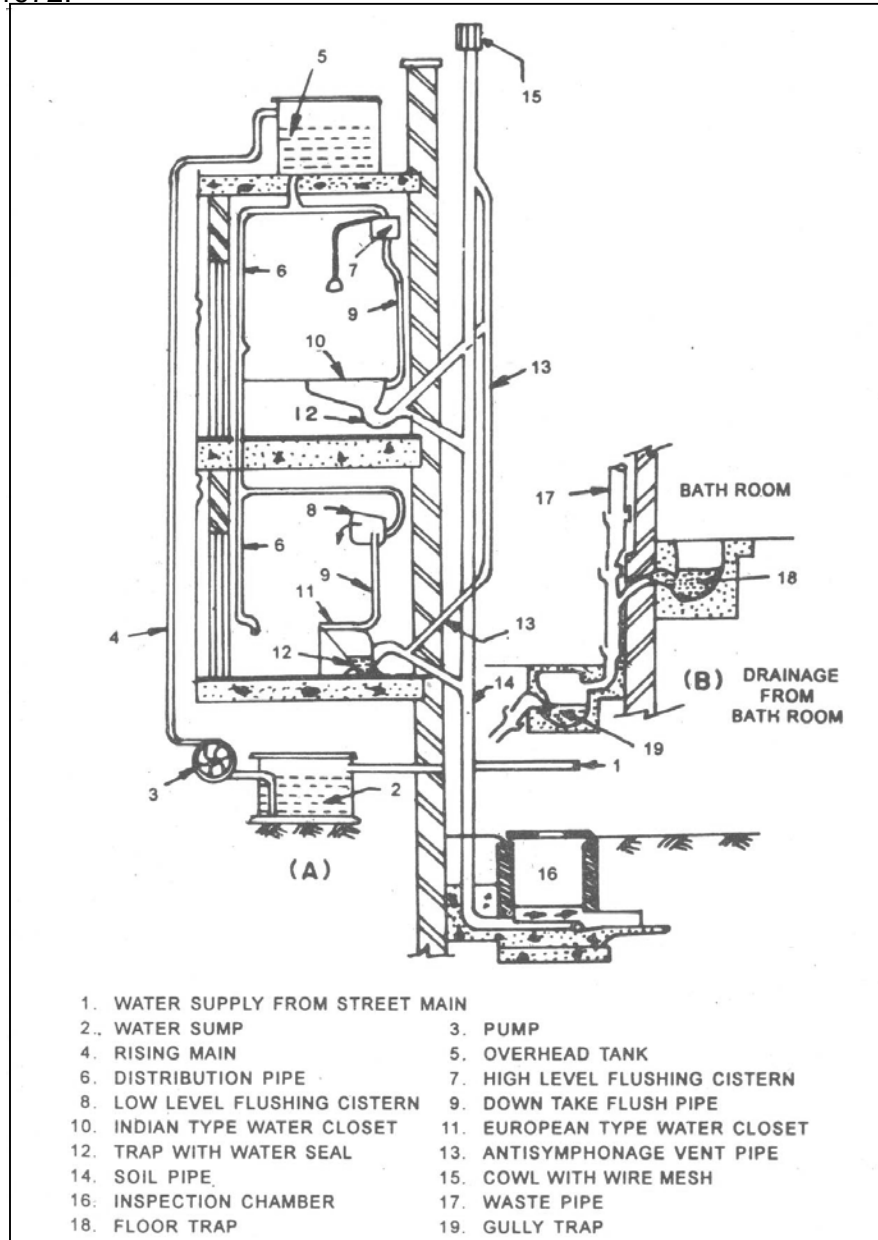

### PRACTICAL 16

Fig 4.5 Layout of Drainage System in Multistoreyed Building

## CHAPTER 5

### OVERHEAD TANK

Overhead tanks or elevated reservoirs are constructed at an elevation from ground level. They may be of any shape like rectangle, circular or elliptical. The R.C.C. overhead tank resting on R.C.C. columns having footings. The columns are connected by R.C.C. braces (beams) at 3.0m intervals. A R.C.C slab is cover is provided on top with manhole opening. Following accessories provided may be identified on the drawing.

- (i) Water level indicator to show the level of water in the tank.
- (ii) An automatic float to close the inlet valve when water reaches full tank level
- (iii) A ladder to go up the tank for cleaning programme
- (iv) Pipelines.

#### **PIPE LINES:**

The pipelines for an overhead tank consists of

- (i) **Inlet pipe** : Water enters the tank through the inlet pipe. A bell mouth is provided at the top of pipe and duct foot bend at bottom connecting horizontal and vertical pipes. A reflux valve is provided to prevent water from returning into the pipe.
- (ii) **Outlet pipe** : The water is drawn from the tank through the outlet pipe.
- (iii) **Overflow pipe**: Excess water is drained away through the overflow pipe.
- (iv) **Scour pipe**: The scour pipe is used for cleaning purpose.

**PRACTICAL 17**

1. Draw the sectional elevation and plan of an R.C.C tank given and show the pipelines details

1. Height of tank above G.L	...	9.0m
2. Size of tank	...	5 x 5m
3. Thickness of side walls and bottom slab	...	200mm
4. Size of columns	...	400 x 400mm
5. Size of beams	...	400 x 300mm
6. Spacing of beams	...	3000mm
7. Depth of R.C.C footing below G.L	...	1000mm
8. Size of footing base	...	1500 x 1500mm
9. Thickness of footing at column face	...	450mm
10. Thickness of footing at end	...	150mm

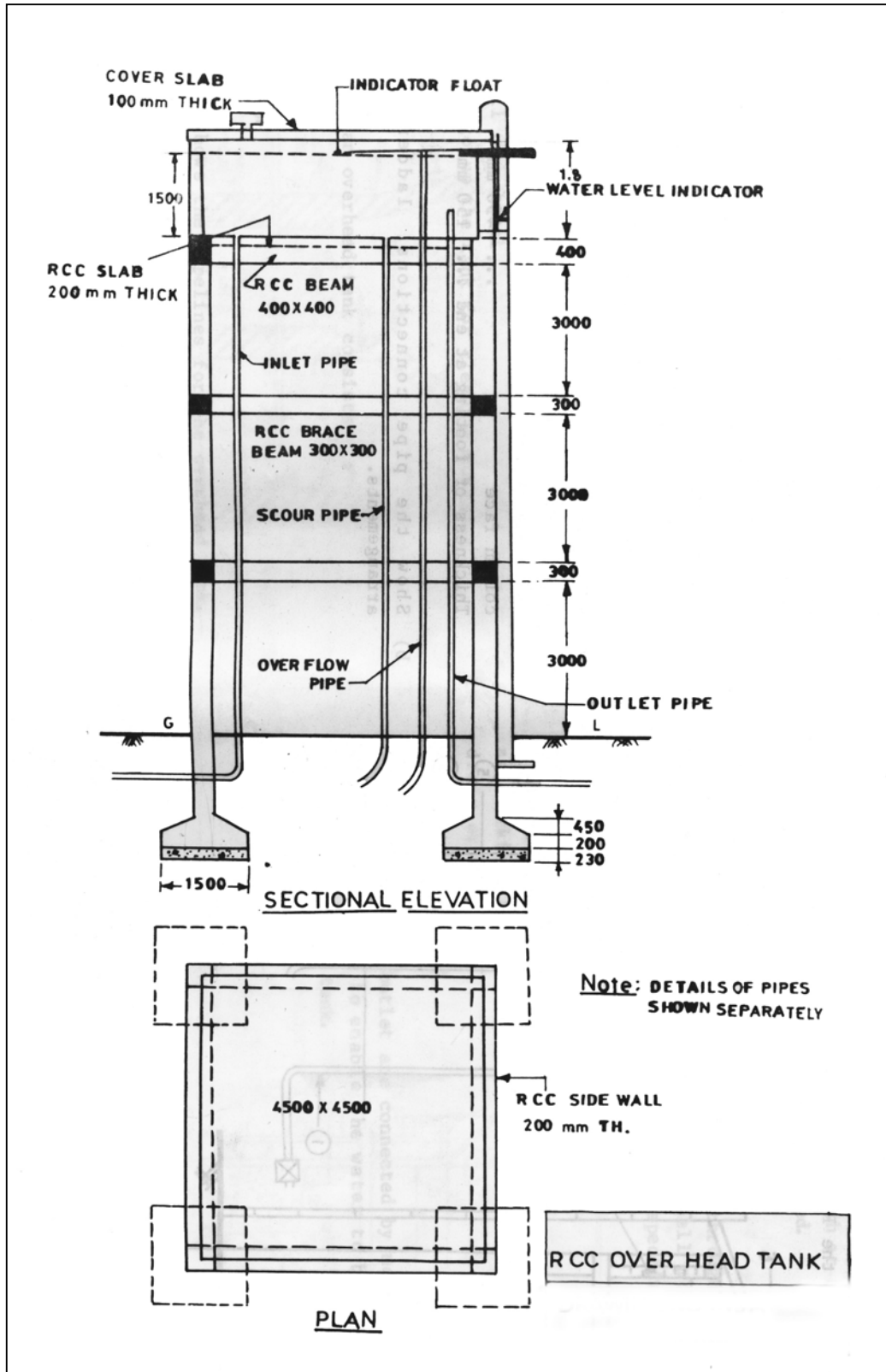

PRACTICAL 16 – OVERHEAD TANK

## CHAPTER 6

### SEPTIC TANK, MANHOLE AND DISPERSION TRENCH

#### SEPTIC TANK:

A septic tank is an underground chamber in which the excreta from lavatories is digested by anaerobic action. Normally the septic tank is designed for disposal of night soil from lavatories. The sullage water from washbasins, sinks etc are dispersed into a garden. The liquid discharge from the septic tank after digestion called the effluent, should be given secondary treatment.

#### LAYOUT OF A SEPTIC TANK:

The layout for a septic tank sewerage system should be simple and as direct as possible. The pipes should be laid in straight lines in both vertical and Horizontal planes as far as possible.

#### COMPONENTS OF SEPTIC TANK:

The septic tank consists of a rectangular or circular underground chamber built with brick masonry or stone masonry. It should be plastered inside and outside with 1:4 c.m. The floor should be constructed with of 1:10 towards the sludge outlet. The septic tank should have a minimum liquid capacity of 1000litres with a minimum width of 750mm and depth 1000mm. A minimum free board of 300mm should be provided. The following are the components of septic tank.

- (i) **Inlet** : for tanks of width less than 1200mm, the inlet is T-shaped dip-pipe of same diameter as the incoming drain. The pipe should be fixed inside the tank with top level extending above slum level and bottom limb extending about 300mm below top water level. For wider tanks, a baffle wall should be provided 150mm from the inlet of the tank, extending 150mm below the invert of the inlet pipes and 150mm above the top water level.
- (ii) **Outlet** : For narrow tanks, T-Pipe if 100mm dia is fixed inside the tank with the top limb rising above the slum level and the bottom extending to about 1/3 of the liquid depth. The invert of the pipe should be 50mm below the invert of the inlet pipe. For wider tanks, a weir outlet is provided extending the full width of the tank, A scum board is fixed 150mm from the weir and extending 150mm above and 1/3 of liquid depth below the top of water level. A deflector is provided at the base of the scum board to prevent particles from reaching the outlet weir.
- (iii) **Partitions** : Where the capacity of the septic tank exceeds 2000litres, the tank is divided into 2 chambers by partition. Suitable

openings are provided in the partition at 300mm below the tank water level.

- (iv) **Openings and cover:** Each compartment should be provided with a rectangular or circular openings with a cover of R.C.C or C.I. The cover should neatly fit the openings to prevent water entering through it.
- (v) **Ventilating pipe:** Every septic tank should be provided with a ventilating pipe of dia 50mm. The top of pipe should be provided with mosquito prof mesh.

The pipe should extend to a height of 2m when the tank is 20m away from the building and 2m above the top of building if located closer than 20m.

**SIZES OF SEPTIC TANKS:**

The sizes of septic tanks for 20 users for housing colonies (upto 300 persons) and for hotels and boarding schools are given in the tables as shown.

No. of Users (1)	Length (2) 'm'	Breadth (3) 'm'	Liquid depth Cleaning interval of	
			1 Year (4) 'm'	2 Years (5) 'm'
5	1.5	0.75	1.0	1.05
10	2.0	0.90	1.0	1.40
15	2.0	0.90	1.3	2.00
20	2.3	1.10	1.3	1.80

- A provision of 300mm should be made for free board
- The size of septic tanks are based in certain assumptions while choosing the size of septic tank.



**For Residential Colonies**

No. of Users (1)	Length (2) 'm'	Breadth (3) 'm'	Liquid depth Cleaning interval of	
			1 Year (4) 'm'	2 Years (5) 'm'
50	5.0	2.0	1.0	1.24
100	7.5	2.65	1.0	1.24
150	10.0	3.0	1.0	1.24
200	12.0	3.3	1.0	1.24
250	15.0	4.0	1.0	1.24

- For population over 100, the tank may be divided into Independent parallel chambers for ease maintenance and cleaning.

**RECOMMENDED SIZES OF SEPTIC TANK  
FOR HOTELS AND BOARDING SCHOOLS**

No. of Users (1)	Length (2) 'm'	Breadth (3) 'm'	Liquid depth for stated interval of sludge with drawal	
			Once in a Year (4) 'm'	Once in 2 Years (5) 'm'
50	5.0	1.6	1.3	1.4
100	5.7	2.1	1.4	1.7
150	7.7	2.4	1.4	1.7
200	8.9	2.7	1.4	1.7
300	10.7	3.3	1.4	1.7

**PRACTICAL 17**

Draw sectional plan, section along A-A of septic tank for a residential colony for 10 users.

**PRACTICAL 18**

Draw sectional plan, section of a septic tank for a residential colony for 50 users.

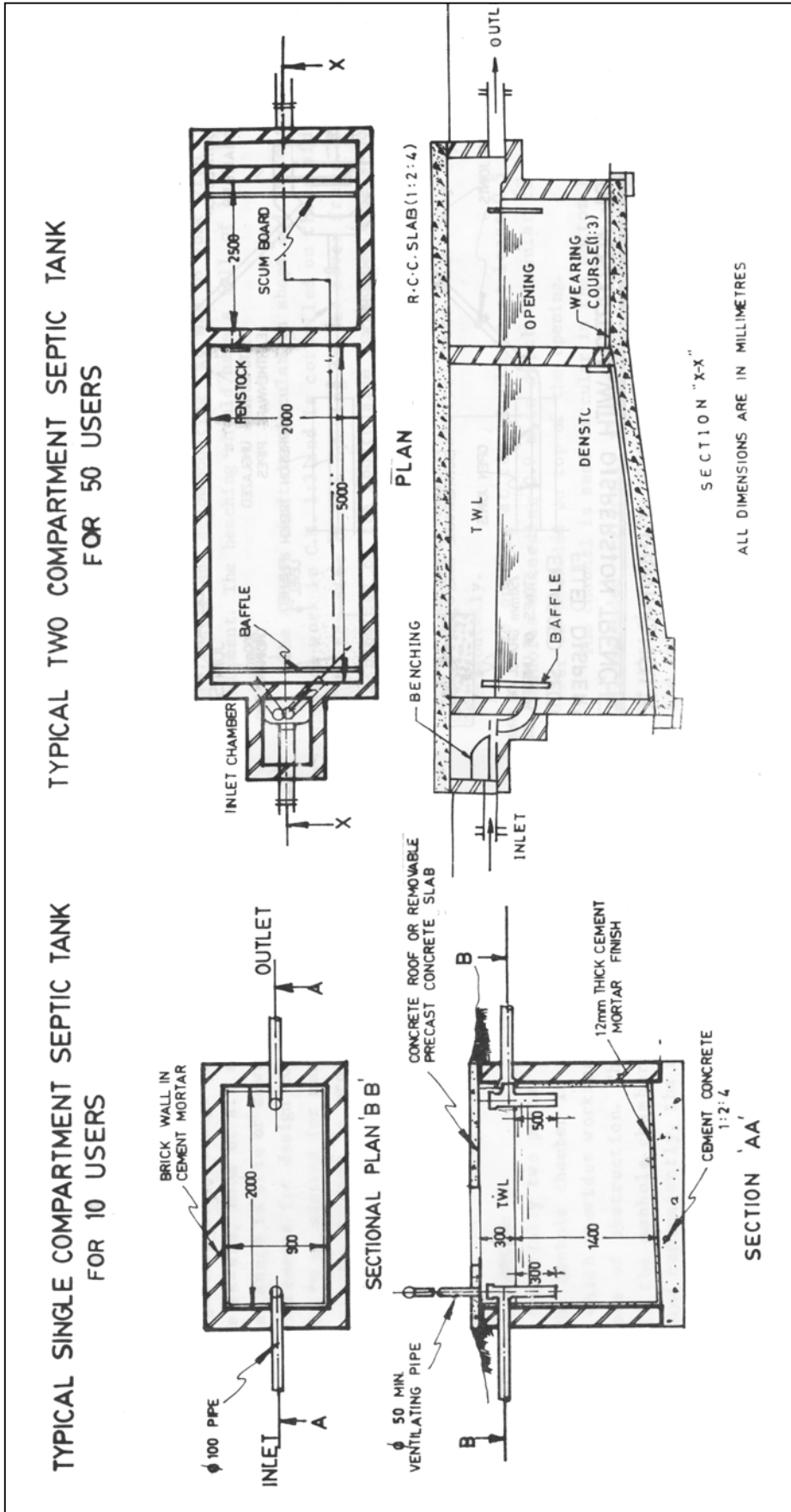

PRACTICAL 17 – SEPTIC TANK FOR 10 USERS

PRACTICAL 18 – SEPTIC TANK FOR 50 USERS

## 2. DISPERSION TRENCH:

The disposal of effluent of septic tank by soil absorption system is known as dispersion trench and is suitable when the soil is porous and is capable of absorbing the effluent.

The dispersion trench consists of a trench in which open jointed pipes are laid and surrounded by coarse aggregate media and overlaid by fine aggregates. The effluent gets dispersed through the open joints and is absorbed in the neighbouring soil. The dispersion trenches should be 0.5 to 1.0m deep and 0.3 to 1.0m wide excavated to a slight gradient and shall be provided with 150-250mm washed gravel or crushed stone open jointed pipes of 75-100mm dia made of unglazed earthen ware clay or concrete shall be placed inside the trench. The trench should be covered with about 300mm of ordinary soil to form a mound and turf grown on it. The finished top surface may be kept at least 150mm above ground level to prevent direct flooding of the trench during rains.

### PRACTICAL 19

Draw a soil absorption system with dispersion trench for a disposing off effluent from septic tank for the given data.

Dia of the pipe from the septic tank	:	100mm
Distribution chamber	:	0.9m x 1.0m
Dia of earthen pipe from distribution chamber	:	75mm
Length of the dispersion trench	:	2.0m
Distance between trenches	:	2.0m
Distance of straight trench from distribution chamber	:	3.0m
No. of dispersion trenches	:	3

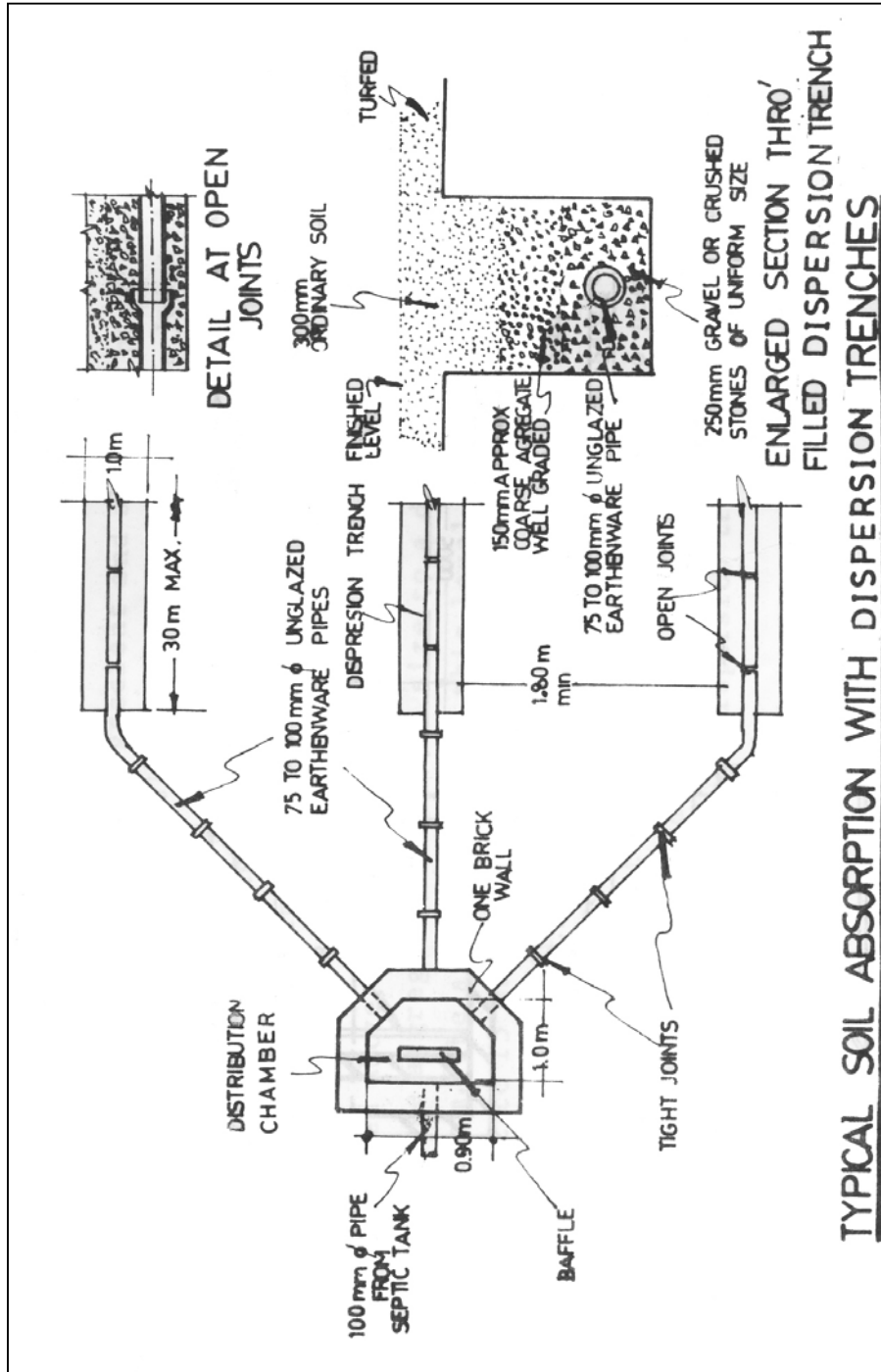

PRACTICAL 19 – DISPERSION TRENCH

### 3. MANHOLE:

A manhole is an opening by which a person can reach a drain, a sewer or other closed structure for the purpose of inspection, cleaning and other maintenance operations and the opening is provided with suitable cover at top. Manholes are provided at every change of alignment, every change of gradient, every junction of two or more sewers; head of all sewers or branches and wherever there is change in size of sewers. As per IS: 4111-1967 covers the requirements of design considerations, construction; safety measures to be adopted for manholes. At manholes the sewer is ended and an open channel is provided through which the sewage flows.

Manhole has two parts

1. Manhole chamber
2. Access shaft.

Manhole chamber provides working space for inspection, testing or clearance of obstruction. The access shaft is the vertical passage to the manhole chamber. In very large sewers where a man can stand conveniently; the manhole chamber may be avoided and the sewer is connected by access shaft

### PRACTICAL 20

Draw plan, section across XX and YY of the drop manhole of inner dia of chamber as 2.0m and depth of manhole as 6.0m. The dia of sewers may be assumed as 0.75 and 0.5m. Assume other data suitably.

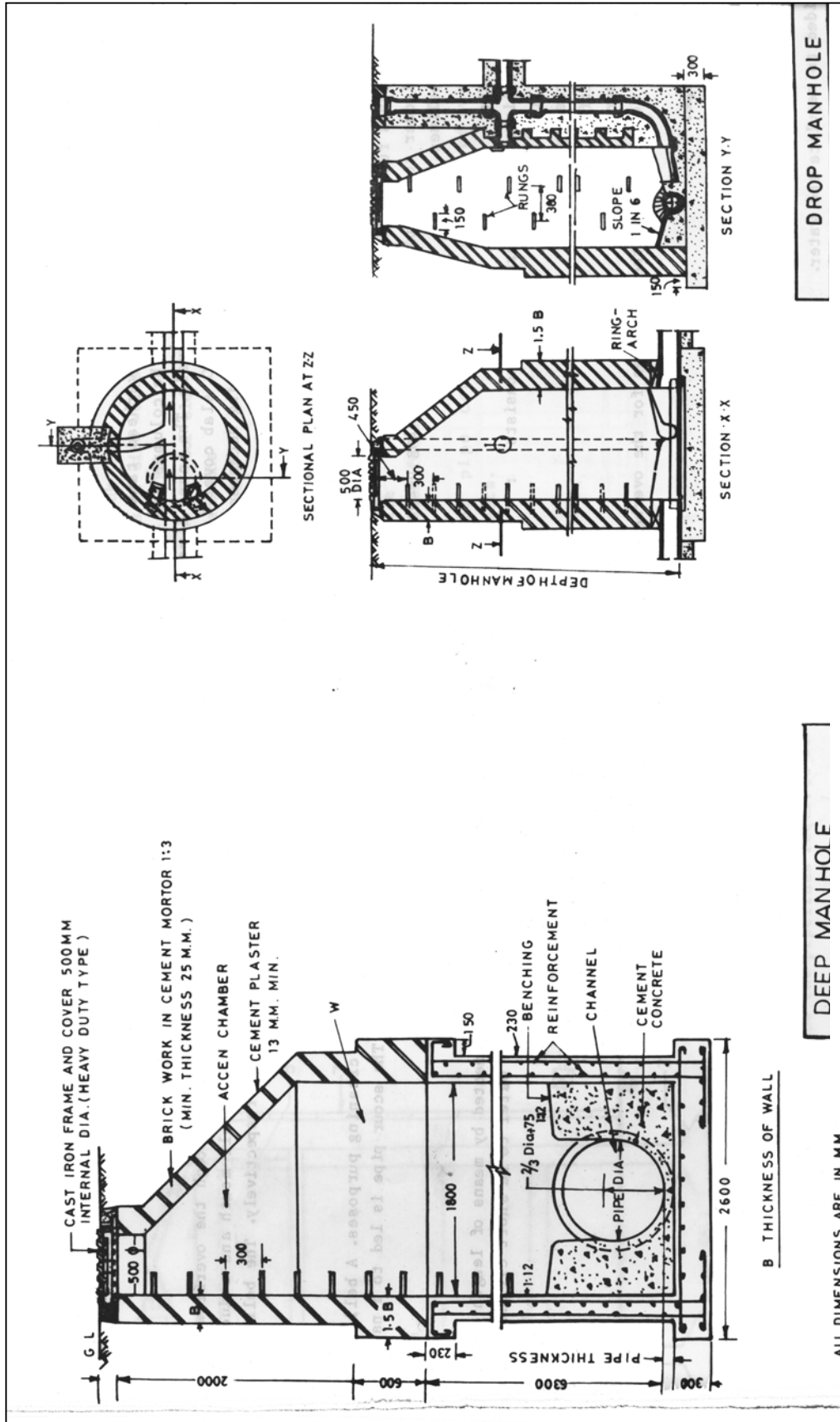

PRACTICAL 20 – DROP MANHOLE

## CHAPTER 7

### LAYOUT SKETCH OF WATER PURIFICATION PLANT

The water treatment plant should be located as near as town as possible preferably in the central place. The main advantage of locating the plant at such a place will be that the water will reach every consumer with more pressure and purity. If the city is situated on the bank of the river, the treatment plant should be located near the source, because in this case the length of rising mains will be small and muddy water need not be pumped which may cause quick wearing of the pipes.

One complete water treatment plant requires the following process starting from the source of water upto the distribution zone in order of sequence.

- (i) Intake structure including pumping plant
- (ii) Plain sedimentation
- (iii) Sedimentation with coagulation
- (iv) Filtration
- (v) Water softening plant
- (vi) Miscellaneous treatment plants
- (vii) Disinfection
- (viii) Clear water reservoir
- (ix) Pumps for pumping the water in service reservoirs (if elevated)
- (x) Elevated or underground service reservoir
- (xi) A well equipped laboratory should be provided the treatment plant, to check the quality of raw water and tested water. According to the variation in impurities, the treatment process should be changed. Laboratory tests can also increase the efficiency of plant

(I) Physical and Chemical Plant:

1. Total, Volatile and fixed solids
2. Hardness
3. PH Value, acidity and alkalinity
4. Chlorides
5. Nitrite, Nitrate, Albuminoid and free Ammonia
6. Active chlorine (Free and Combine)

(II) Biological Tests:

1. Presence of B.Coli group
2. Plate-count (for bathing and swimming pool waters)
3. Examination and enumeration of microscopic organism and amorphous matter.

**TREATMENT PROCESS:**

<b>Impurity</b>	<b>Process used for removal</b>
1. Floating matters leaves, dead animals etc	Screening
2. Suspended impurities as slit, clay, sand etc	Plain sedimentation
3. Fine suspended matter	Sedimentation with coagulation
4. Micro organism and colloidal matters	Filtration
5. Dissolved gases, tastes and odours	Aeration and chemical treatment
6. Softening	permutit method
7. pathogenic bacteria	disinfection

**PRACTICAL 21**

**Draw the typical layout of water treatment works.**



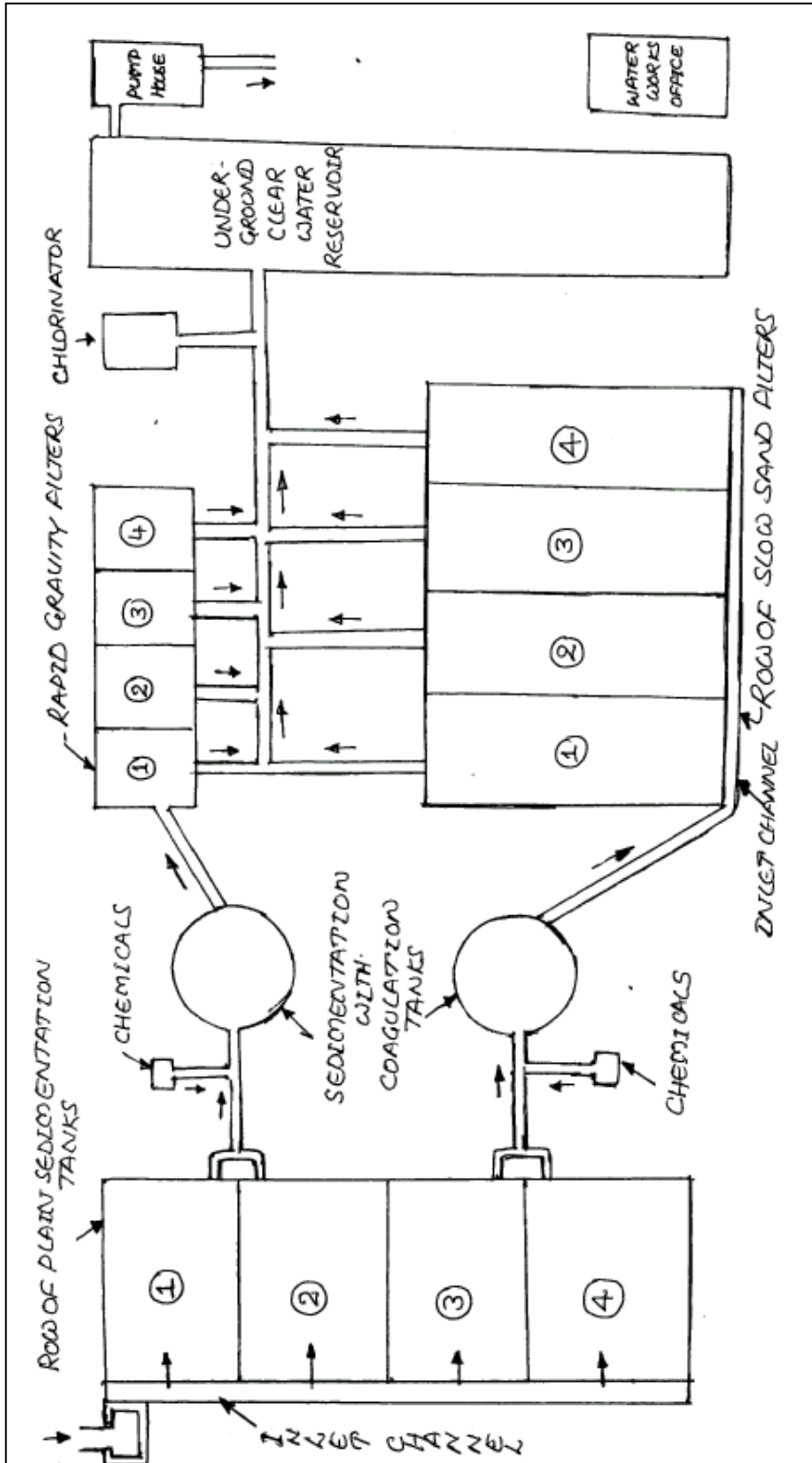

PRACTICAL 21 Typical Layout of water treatment works

## **CHAPTER 8**

### **LAYOUT SKETCH OF SEWAGE TREATMENT PLANT**

The sewage plant should be located as near to the point of disposal as possible. If sewage is disposed of finally in the river or natural stream, the treatment plant should be located on the river bank care should be taken while locating the site, that it should be on the down stream side of the city and sufficiently away from the water intake works. The treatment plant should be on the down stream side of the bathing ghats. If finally sewage is to be applied on land, the treatment plant should be located near the land at such a place from which the treated sewage can easily flow under gravitational forces towards the disposal points. The plant should not be much far away from the town to reduce the length of sewerline. On the otherhand, the site should not be so close to the town, that it may cause difficulties in the expansion of the town and pollute the general atmosphere by smell and fly nuisance.

- (i) All the units should be located in order of sequence, so that the sewage from one process should directly go into the next process
- (ii) If possible all the units of plant should be located at such elevation that sewage from unit to next flow under gravity only
- (iii) All the treatment units should be arranged in such away that minimum area is required, it will also ensure economy in its cost.
- (iv) Sufficient area should be occupied for future extension in the beginning.
- (v) Staff quarters and office should also provided near the treatment plant so that operator can watch the plant easily
- (vi) The site of treatment should be very neat and give very good appearance
- (vii) By-pass and overflow weirs should be provided to cut of operation any unit when required
- (viii) All the channels, conducts should be laid in such a way as to obtain flexibility, convenience and economy in the operation
- (ix) A well quipped laboratory should be provided at the treatment plant to check the quality of sewage before and after treatment according to the variations in the impurities, the treatment processes should be altered. The efficiency of the plant can be increased by the laboratory tests of sewage during various processes. By testing the sewage after the treatment it can be ascertained wheather it has reached the required standard at which it can be disposed off or not.

**TREATMENT PROCESS:**

<b>Impurity</b>	<b>Process used for removal</b>
1. Bulky floating and suspended matters	Racks and Screens
2. Oils and grease	floatation tanks (skimming tanks)
3. Heavy and coarse suspended matters	Gritchamber, detritus tanks and sedimentation tanks
4. Non-settable suspended and dissolved solids	Chemical flocculation (precipitation tanks)
5. Colloidal and dissolved organic matter	Biological growth
6. Pathogenic bacteria	Disinfections

**PRACTICAL 22**

**Draw the typical layout of sewage treatment plant**

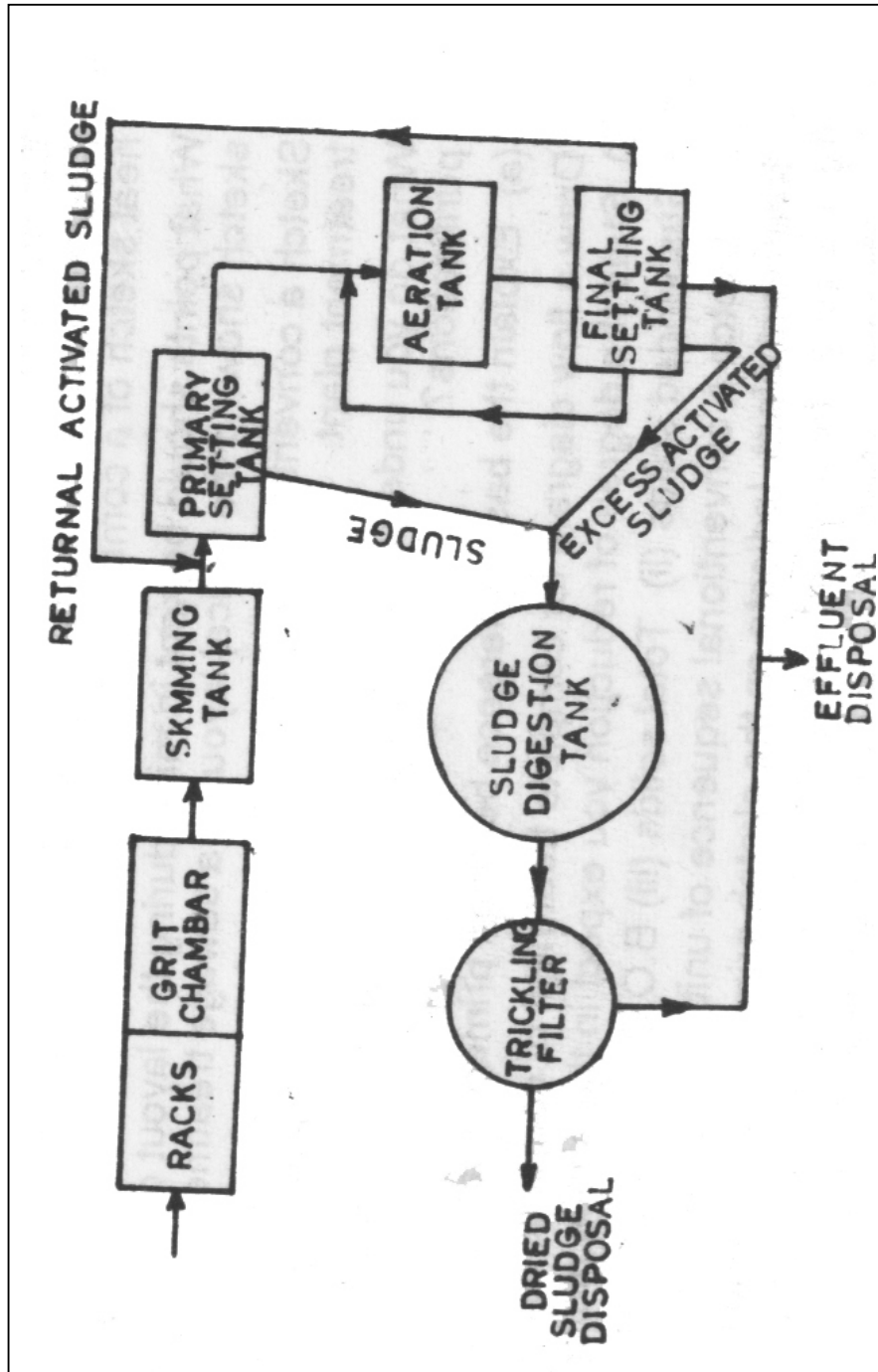

PRACTICAL 22 - LAYOUT OF SEWAGE TREATMENT PLANT

## **CHAPTER 9**

### **TRACING AND PREPARATION OF AMMONIA PRINTS**

#### **GENERAL:**

Before starting construction work of buildings or other engineering work at site, the detailed drawing of the project is prepared. The sets of these drawings are required in the office of approving authority, design office, architect office field engineers for construction. Also if some loan is taken for the construction of the building, its one set is required by the loan giving authority / agency. As such we require 5 or 6 sets of detailed drawings drawn by draughtsmen, it will be costly and we require lot of labour and time. So for saving labour and time, the detailed drawings are prepared on tracing paper or tracing cloth. After these drawings are approved by the competent authority, its prints are taken out..

Now a days, most of the engineering drawings are prepared on the tracing paper taking great care and blue prints or Ammonia prints can be prepared from these drawings

#### **DRAWING ON TRACING PAPER/TRACING CLOTH:**

Tracing papers of reputed brands are used for preparing drawings now a days. In drawing offices architectural offices and other engineering drawing offices, these drawings are prepared on the tracing papers which saves time and these drawings are used directly for taking out the ammonia prints. While preparing the drawings on tracing papers, all the line work is usually done in penal but the lettering and heading etc can be done either in pencil or in ink. These prepared drawings are carefully protected for keeping them as record. These should be kept in cabinets meant for keeping the record of engineering drawings

When permanent record of drawings is required to be kept for years as in case of land registration papers etc; tracing cloth is used for preparation of drawings. Drawings on tracing cloth are drawn in good water proof blank ink. Tracing cloth is a transparent cloth like tracing paper, drawings prepared on tracing cloth take more time and Ammonia or blue prints are taken out from the drawings directly. While keeping the

record of drawings on tracing cloth, these should be placed either in cabinets or rolled and never be folded.

### **TRACING:**

In the drawing offices various types of drawing are prepared sometimes many sets of the same drawing are required . As the prints can not be taken out from the drawing sheets. So it is required to prepare tracings of drawings on tracing paper or tracing cloth. For doing tracing work from the drawing sheets; the tracing table is used. Tracing table is a wooden table box which has a glass top. At the bottom of box some electric bulbs or fluorescent tubes are fixed for providing light to the box top. The drawings whose tracing is required to be prepared is placed at the top of glass. The tracing paper/cloth is placed on the drawing and tubes or bulbs are lighted. The drawing becomes visible at the top of the glass and thus the tracing are drawn in pencil or ink as per requirement

After computing the tracing of the drawing it is carefully compared and corrections if any are incorporated in the tracing. The blueprint or ammonia prints are then prepared from these tracings.

### **AMMONIA OR AZO PRINTS:**

Readymade sensitized paper for Ammonia prints is available in the market. Ammonia prints taken in two varieties

- (i) Ammonia print with red violet lines on white ground
- (ii) Ammonia print with steel blue lines on white ground

The expose for ammonia or azo prints is done in a pressure frame for 1 to 2 minutes and developed in a chamber containing liquid ammonia . No water is required for ammonia prints

Now a days Ammonia prints are prepared in electrically operated ammonia printing machine. A simple type of Ammonia printing machine has a row of 1 to 15 fluorescent tubes, which are used for exposing purpose. It has a motor over which series of belts are operated. The tracing and ammonia paper are fed into the machine, which automatically move along with belts which are operated by the motor in a controlled speed. The drawing is thus exposed by means of fluorescent

tubes. The exposed paper is then developed in a chamber containing liquid Ammonia. The ammonia chamber may be attached to the printing machine or it may be attached to the printing machine or it may be in the form of separate box. But it is usually a separate wooden or steel sheet vertical box. It has a hinged door at top or side and an ammonia chamber at bottom to keep the ammonia. The prints are fed into the chamber and after sometime, these are taken out as finished prints

It is necessary to note that the sensitised paper should be kept and stored in a dark and cool place and it is better to keep it in light proof tin case because exposure to light spoils the paper. The Ammonia paper should also be kept away from the Ammonia fume.

**EXERCISE**

1. Draw the conventional signs for the following

- |          |          |             |
|----------|----------|-------------|
| 1. Brick | 2. Stone | 3. Concrete |
| 4. Wood  | 5. Sand  | 6. Glass    |
| 7. Water | 8. Metal |             |

2. Draw the symbols for the sanitary installations

- |                     |                    |
|---------------------|--------------------|
| 1. Shower head      | 2. Indian type W.C |
| 3. Bath tub         | 4. Washbasin       |
| 5. Cooking platform | 6. Kitchen sink    |

3. Draw the electrical symbols for the following

- |                   |                |
|-------------------|----------------|
| 1. One way switch | 2. Bell        |
| 3. Ceiling Fan    | 4. Pump        |
| 5. Exhaust fan    | 6. Earth Point |

4. Draw the cross section of load bearing wall foundation details to a scale of 1:20 to the following specifications

- |  |               |
|--|---------------|
| 1. Depth of foundation   | = 1250mm      |
| 2. Bottom most levelling course with gravel / sand   | = 150mm thick |
| 3. Width of C.C. foundation 1:4:8<br>900mm; depth  | = 300mm       |
| 4. Width of first footing in brick masonry<br>1:4 C.M. 600mm & depth   | = 500mm       |
| 5. Width of second footing in brick masonry<br>1:4C.M. 500mm & depth   | = 300mm       |
| 6. Width of basement 400mm and depth   | = 600mm       |
| 7. Width of wall in super structure in brick masonry 1:6   | = 300mm       |
| 8. Thickness of damp proof coarse  | = 20mm        |
| <b>9. Flooring</b> – with 25mm thick polished stone slabs 300 x 300mm over 100mm thick C.C. (1:4:8) bed. The remaining depth is filled with crushed stone or gravel or sand. |               |

5. Draw the cross section of Isolated square R.C.C. column footing to the scale to 1:20.

1. Size of footing – 1200mm x 1200mm
2. Shape of footing – trapezoidal with vertical depth of 150mm each side tapers from 200 to 1200mm



3. Steel reinforcement for the footing : 12mm dia rods at 150mm c/c parallel to each side with a clear cover 25mm at bottom and 50mm at sides.
  4. Size of columns – 200mm x 200mm
  5. Steel reinforcement for columns : 6 No.'s of 16mm dia rods
  6. Lateral ties for columns: 6mm dia rods at 150mm c/c
  7. Covers – Side cover to longitudinal reinforcement is 40mm. Anchorage for longitudinal reinforcement all the 6 bars of 16mm dia are taken down and extended in horizontal direction to a length of 200mm beyond the face of the column and tied to the reinforcement of the footing in the form of dowel bars.
6. Draw a suitable scale the elevation, section and plan of the following door,
1. Fully paneled door 1200 x 2100mm
  2. Panelled window 1200 x 1500mm
  3. Glass window 1200 x 1200mm
7. Draw the plan and sectional elevation of the following square and rectangular footings as shown in Figure.

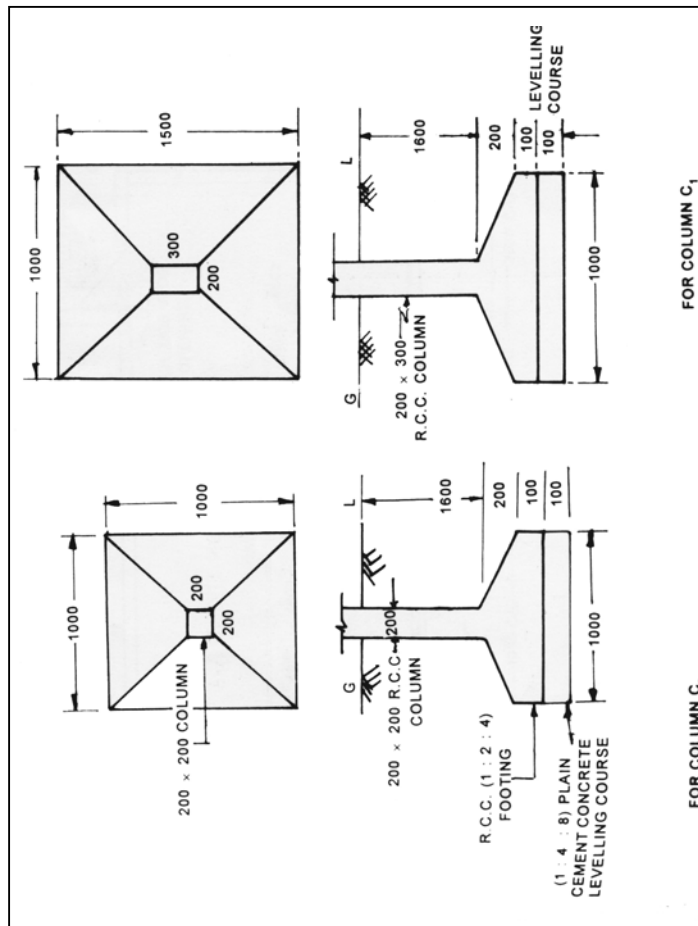

8. Sketch the cross section of a single compartment septic tank for 10 users given length – 2.0m, width – 0.9m and depth – 1.0m. Show on it the inlet and outlet pipes and ventilating pipe.
9. Draw plan and section of drop manhole assuming that dia of chamber as 1.0m and depth of manhole as 5.5m. The diameter of the sewer may be assumed as 0.75 and 0.5m.
10. Sketch the overhead tank and show the pipe lines required together with the sluice valves.
11. Sketch the cross section of brick masonry wall with the following data.
  - Depth of foundation : 1.2m
  - Width & Depth of C.C bed : 900mm and 300mm
  - Width & Depth of first footing : 600mm and 500mm with equal offsets
  - Width & Depth of second footing : 500mm and 400mm
  - Wall in Basement : 600mm depth and 300mm width
  - Height of roof : 3.3m
  - Roofing : 1200mm thick R.C.C slab finished with 20mm thick proof
  - Thickness of bed block : C.C bed block 250mm
  - Parapet : 100mm thick and 700mm depth provided with coping 50mm thick and projecting 50mm.
  - Sunshade : 75mm thick at fixed end and 50mm thick at free end projecting 700mm from the face of the wall from the lintel.
  - Flooring : 200mm thick shahabad stones slab over 100mm thick C.C bed (1:4:8) bed. The remaining depth of basement is filled with sand.
12. Sketch the two-leaf fully paneled door showing front elevation with all components 1.1m x 2.1m.

13. Sketch the glazed window 1.2m x 1.2m showing all the components.
14. Draw the cross section of lead bearing wall foundation details to a scale of 1:20 with the following specification.

Depth of foundation : 1150mm.

Bottom most levelling course with gravel sand :150mm thick.

Width of C.C foundation (1:4:8) : 900 mm depth = 300mm.

Width of first footing brick masonry in c.m. (1:4) =

600mm,depth = 400mm.

Width of second footing brick masonry in c.m. (1:4) =

500mm,depth = 300mm.

Width of wall in basement brick masonry in c.m. (1:4) =

400mm,depth = 600mm.

Width of wall in superstructure brick masonry in c.m. (1:6) =

= 300mm.

Thickness of damp proof course = 20 mm.

Flooring = with 25mm thick polished stone.

Slabs 300 x 300mm over 100mm thick 1:4:8 C.C bed.

The remaining depth is filled with crushed stone or gravel or sand.