

OnSpecTM Library Shield is a modular system of protective barriers that can be easily field modified and adjusted to accommodate a variety of configurations without the use of tools. Parts can be used to create shields that go down to the work surface or adjusted to leave a 6" opening at the bottom edge.

All parts are made of sturdy 3/16" Acrylic with polished edges and eased radiused corners.

Components:

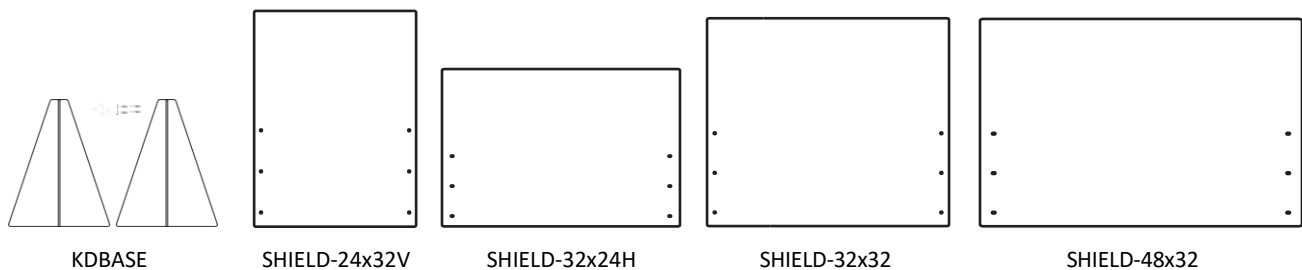

HARDWARE (4 sets)

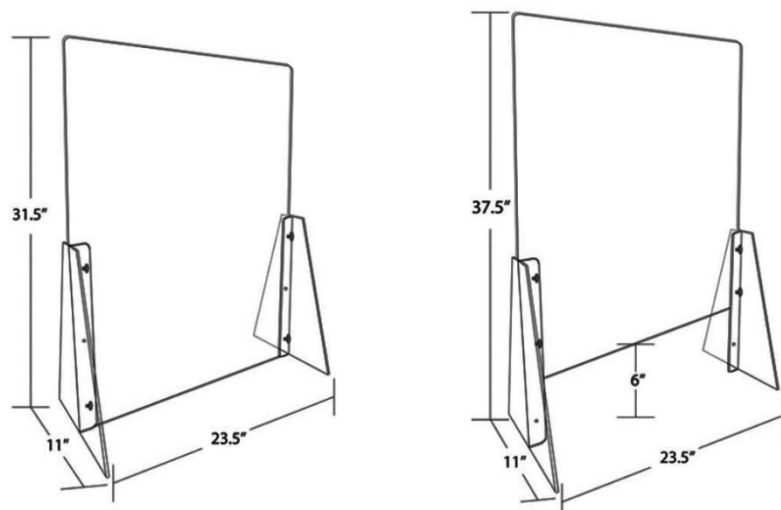

OnSpec Library Displays

www.onspecdisplays.com

Division of Design Manufacturing LLC

www.designmfg.com

1700 Northridge, Walker MI 49544

OnSpec™ Library Shield kits



Library Displays

www.library-shield.com

Each version can be assembled with either of two face shield heights - bottom edge flush against the counter surface or 6" above the counter surface. All use (2) KDBASE components with included hardware.

Prices shown are packed and cartoned for shipment F.O.B. Walker, MI 49544

Custom or modified sizes are available if specific measurements are required. Please contact us for pricing.

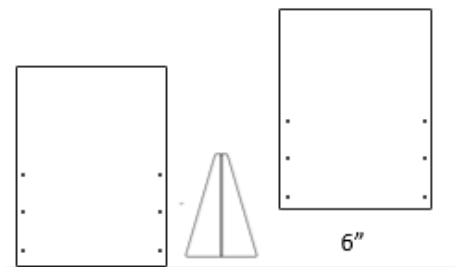

KDSHIELD-2432V \$ 75

- 1 - 23.5" x 31.5" - 3/16 Acrylic Shield
- 2 - 11"x16" x 2" base components with height adjustment openings
- 4 - 3/4" Hex bolt with wing nuts for assembly

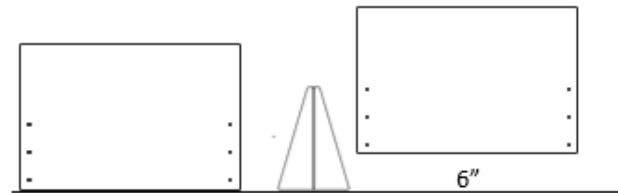

KDSHIELD-3224H \$ 75

- 1 - 31.5" x 23.5" - 3/16 Acrylic Shield
- 2 - 11"x16" x 2" base components with height adjustment openings
- 4 - 3/4" Hex bolt with wing nuts for assembly

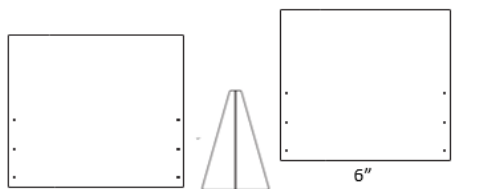

KDSHIELD-3232 \$ 98

- 1 - 31.5" x 31.5" - 3/16 Acrylic Shield
- 2 - 11"x16" x 2" base components with height adjustment openings
- 4 - 3/4" Hex bolt with wing nuts for assembly

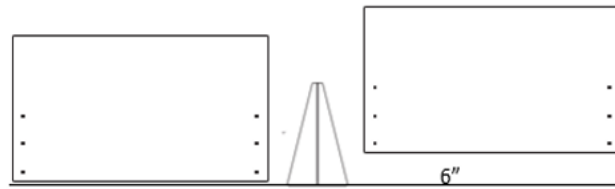

KDSHIELD-4832H \$ 125

- 1 - 47.5" x 31.5" - 3/16 Acrylic Shield
- 2 - 11"x16" x 2" base components with height adjustment openings
- 4 - 3/4" Hex bolt with wing nuts for assembly

OnSpec Library Displays

www.onspecdisplays.com

Division of Design Manufacturing LLC

www.designmfg.com

1700 Northridge, Walker MI 49544