

Cosentino Product Guide

COSENTINO®

SILESTONE® DEKTON® SENSÁ

Cosentino Product Guide

COSENTINO®

SILESTONE® DEKTON® SENSA

Content

| | |
|--|----|
| Cosentino | |
| Mission | 06 |
| Vision | 09 |
| Silestone® Quartz Surfaces | 11 |
| News | 12 |
| Et. series | 12 |
| Advantages | 16 |
| 25 year warranty | 16 |
| N-Boost | 17 |
| Formats | 18 |
| Thicknesses | 18 |
| Finishes | 19 |
| Edges | 21 |
| Applications | 26 |
| Kitchens Countertops | 26 |
| Integrity Sinks | 30 |
| Bathrooms Countertops | 32 |
| Cladding | 33 |
| Flooring | 33 |
| Washbasins | 34 |
| Shower Trays | 35 |
| Colourchart | 36 |
| Colour groups | 39 |
| Dekton® Ultracompact Surfaces | 40 |
| News | 42 |
| New Stonika Series | 42 |
| New Dekton Slim | 44 |
| Advantages | 48 |
| 25 year warranty | 48 |
| Formats | 48 |
| Thicknesses | 48 |
| Applications | 50 |
| Kitchen countertops | 50 |
| Outdoor Kitchen countertops | 53 |
| Bathroom countertops | 54 |
| Cladding | 54 |
| Façades | 56 |
| Flooring Solutions | 58 |
| Aura Bookmatch | 59 |
| Colourchart | 60 |
| Colour groups | 62 |
| Sensa by Cosentino® Protected Natural Stone | 64 |
| Advantages | 66 |
| Colourchart | 72 |
| Prexury | 74 |
| Colourchart | 77 |
| International Distribution | 78 |

Mission

To be a leading company that, together with our clients, responsibly imagines and anticipates high value, innovative surfaces for the world of architecture and design.

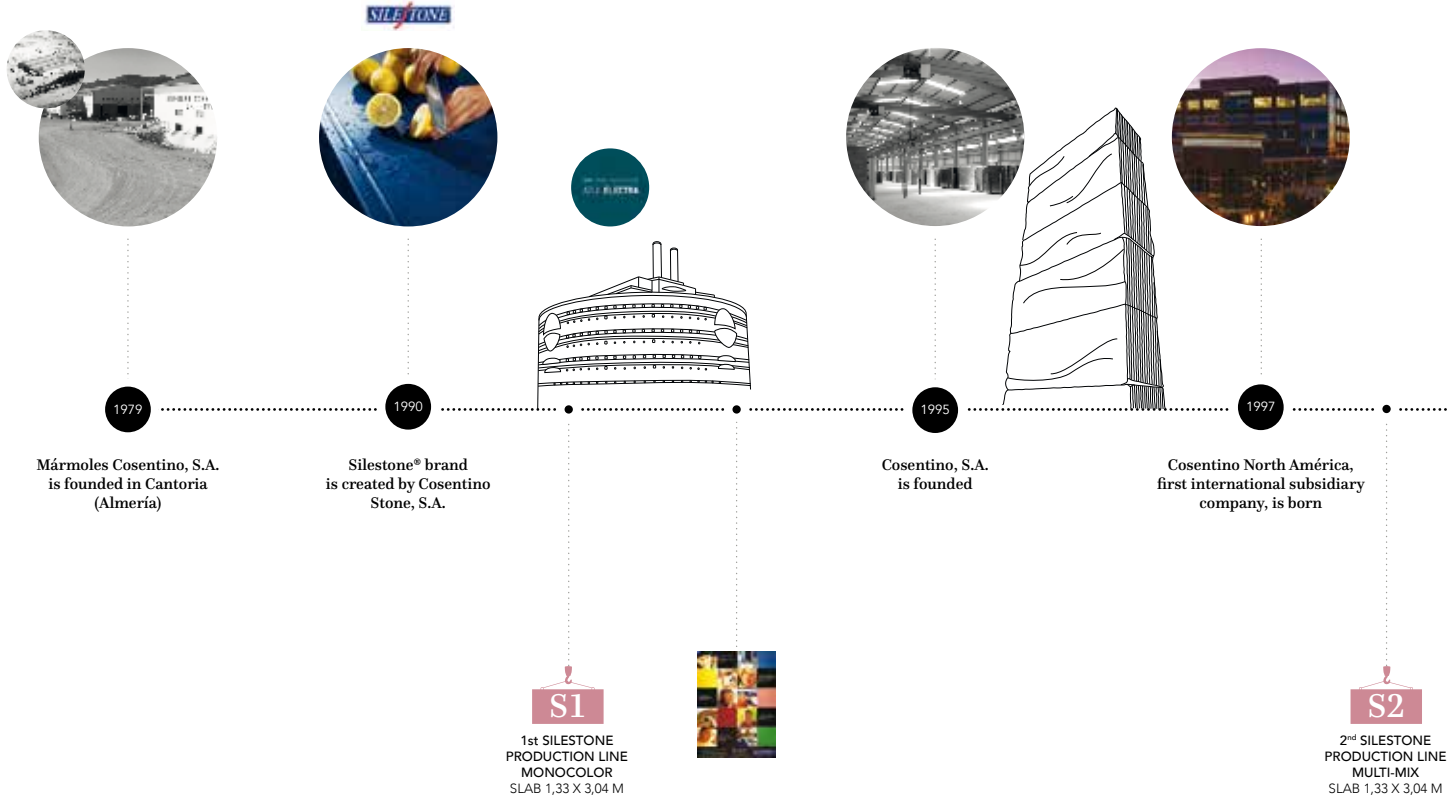



1999

Cosentino Northwest Europe, second international subsidiary company, is born



2000

Cosentino is set up in Brasil. Latam, its subsidiary company, is born

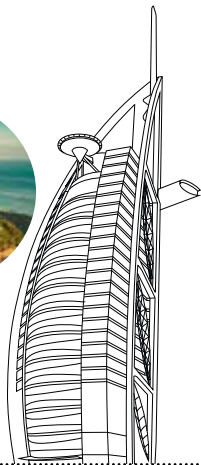

2001

Cosentino U.K. is born



2004

Latina de Vitória (Brasil), the seed of granite Business, is born



Time Magazine Visions of Tomorrow





New main headquarters Opening in Cantoria (Almería)

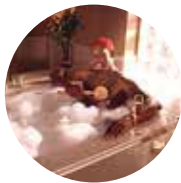

Silestone becomes the first Spanish advertiser at the Super Bowl Show



2005



Dekton factory is built. Cosentino reaches its 50th Center.

2010



Cosentino wins Cannes Gold Lion thanks to the spot "Por encima de todo"

2011



Dekton's World Premiere in Construmat Trade Show (Barcelona)

2012

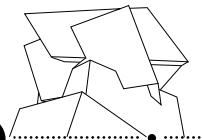

1st DEKTON PRODUCTION LINE

S8
8th SILESTONE PRODUCTION LINE
PENTACOLOR
JUMBO SLAB 1,33 X 3,04 M



Silestone Antibacterial



Goya Toledo Silestone Be Unique



Fernando Alonso Silestone Platinum Series



Andrés Velencoso, Paz Vega Silestone Be Unique



Fernando Alonso Silestone Authentic Life

Vision

To be the global leader in the surfaces market via our brands, offering innovative architectural solutions that provide design, value and inspiration to our clients' lives.



European Business Award
The Import/Export Award



2013

Prince Felipe inaugurates
Dekton's factory

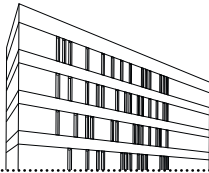

2015

Cosentino is set up in Sudafrica
with presence in the 5 continents



2016

Cosentino wins the National
Innovation Award by
Internationalization

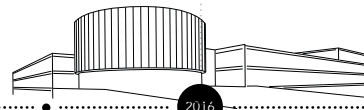

2017

Cindy Crawford becomes a
Silestone ambassador



Rafa Nadal
Dekton
Unlimited



2nd DEKTON
PRODUCTION LINE



Cindy
Crawford
Silestone
Tops on Top



○ Silestone Et. Noir



 **SILESTONE®**
by COSENTINO

SILESTONE®

Quartz Surfaces

Silestone® presents extreme durability in kitchen and bathroom and other spaces where traffic and daily use is high. Enjoy the endless colour possibilities.

The advantages of Silestone® are numerous. Silestone® is low maintenance and has a high resistance to stains and scratches, as well as a low liquid absorption rate. Silestone's nearly indestructible surface is stain, scorch and scratch resistant. With a very low absorption index and a minimal number of joints, Silestone® is perfect for spaces where liquid exists. Silestone® is resistant and continues to be enjoyed over time, going beyond the surface.

It is manufactured in more than 80 colours, 3 textures (polished, suede and volcano) and various formats, making it highly versatile. Colours range from muted tones that are generally associated with natural stone to vibrant colours that are not found in nature. Silestone's colour uniformity and consistency allows for an unlimited number of edge details including but not limited to: bevel, ogee, bullnose and waterfall. It is also malleable enough to be used in large pieces without requiring joints. Silestone® is the perfect choice for kitchen, bathroom, flooring, cladding and unlimited applications.

New

Reinventing Eternity

NEW Et.
COLLECTION

The New Et. Collection delivers an interesting addition following the current trend of marble and elegant neutral spaces.

Vibrant tones, reinventions of the classics, are now materialized in golden and elegant grays hues. 5 new proposals with a wide chromatic range that are born with the aim of giving versatility, luminosity, and personality to both cold and warm spaces. Discover them all.

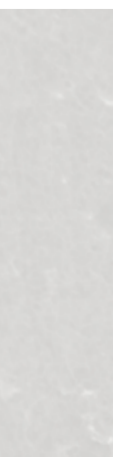
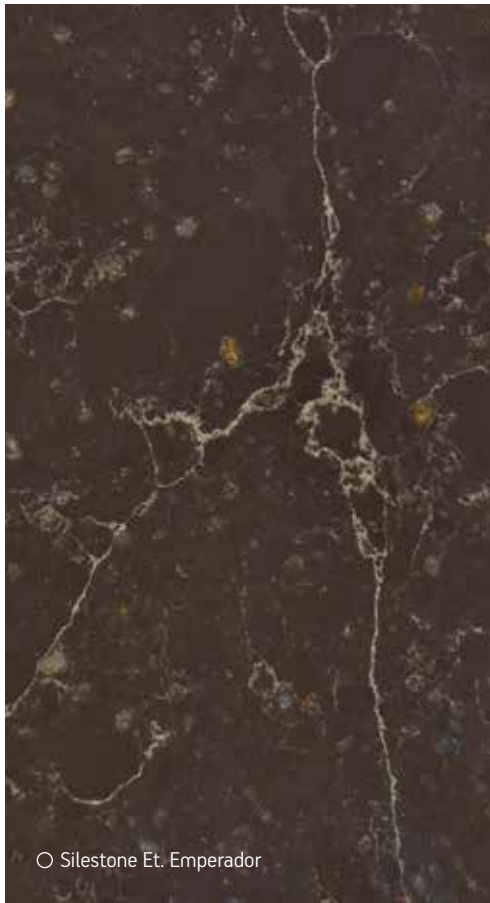



○ Silestone Et. Classic Calacatta



○ Silestone Et. Bianco Calacatta



○ Silestone Et. Marfil



○ Silestone Et. Desert Silver





○ Silestone Charcoal Soapstone



○ Silestone Et. Marfil



○ Silestone Et. Emperador

SILESTONE®

Benefits

Silestone® is Natural Quartz created to provide colour and texture for bath and kitchen surfaces. Thanks to its physical and chemical properties, a result of years of investigation, it guarantees maximum hygiene and safety.



Resistance to Stains

Silestone® is a virtually non-porous surface which is highly resistant to stains from coffee, wine, lemon juice, oil, vinegar, make-up and many other daily-use products.

Resistant to Acid and Scratching

Quartz is one of the hardest minerals that exists. This makes our products very durable, with a high level of resistance to external damage.

Resistant to Impacts

Silestone® high level of resistance to impacts allows very hard objects (pots, trays, etc.) to be handled with total ease.

*Check availability on Silestone® colours with N-Boost

SILESTONE®

N-Boost

Technology On Top



Easy Cleaning



**Repels any type
of Liquid**

Cleaning has never been easier thanks to this superior stain resistance.



**More Intense
Colors**

Thanks to **N-BOOST** technology, colours are more authentic and intense.

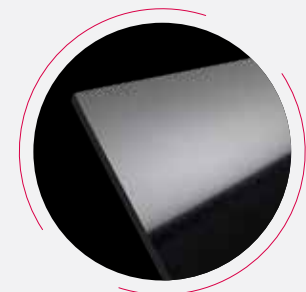

**Surface Shinier
than Ever**

Silestone® now shines more than ever. **N-BOOST** creates a more even surface, causing light to reflect off it more intensely.

SILESTONE®

Formats

Silestone® is available in slabs up to 325x159cm and in floor tiles of 30x30cm, 40x40cm, 60x60cm, 60x30cm and 60x40cm.

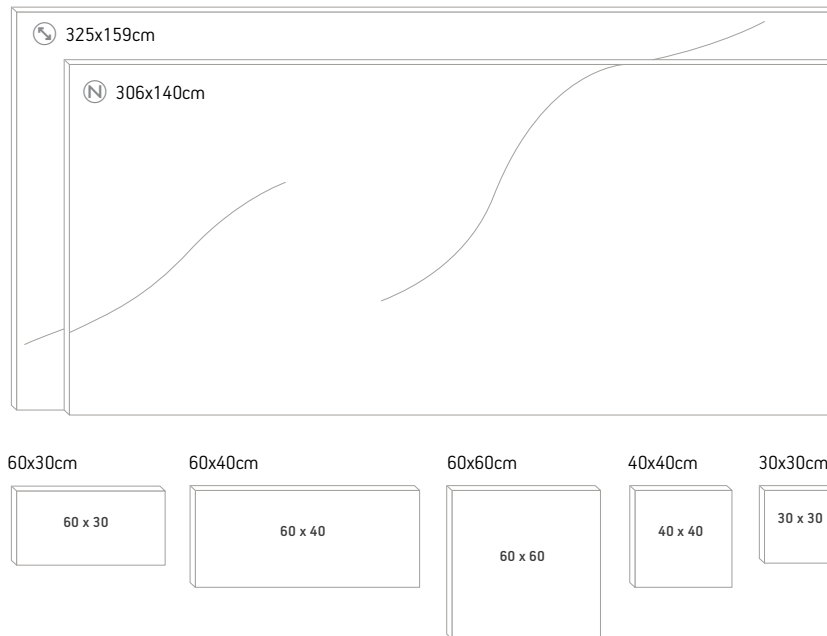

SILESTONE®

Thicknesses

Silestone® slabs are sold in thicknesses of 1.2, 2 and 3cm. Different pieces can also be combined to create thicker edges.

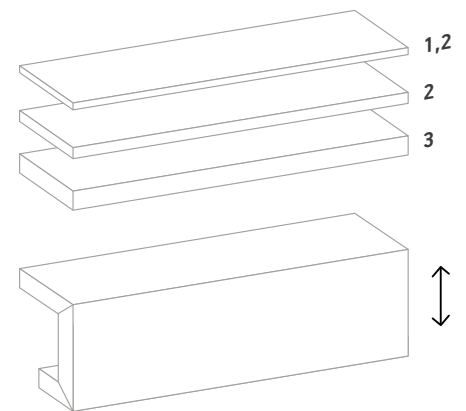

*Measurements given in centimetres

Jumbo Size

Cosentino® is one of the few manufacturers to offer quartz slabs in Jumbo format (maximum 325x159cm). This format allows the creation of large surfaces with a minimum number of joints. It allows versatility of design and greater hygiene. It allows the manufacture of large islands in just one piece. This way, we optimize the use of the slab and reduce wastage.

SILESTONE®

Textures

With the aim of being adapted to your style, Silestone offers you different textures to any of your chosen applications. Polish, Suede or Volcano are three possibilities that make your imagination fly and have your worktop, flooring or walling with the texture that you have always wanted.



Suede

The Suede or matt finish, recently improved by Silestone® offers a flat, non-rugged feel that provides a unique look and feel on account of its beauty and elegance.



Volcano

Volcano is a rustic texture, rough to the touch while also being smooth. It is the result of research into how to create a rugged surface that is both attractive and pleasant to the touch for use in kitchens and bathrooms.



Polished

All the colours of Silestone® and ECO Line Colour Series are available in this texture that is smooth to the touch as well as having a consistent, intense, and uniform colour.

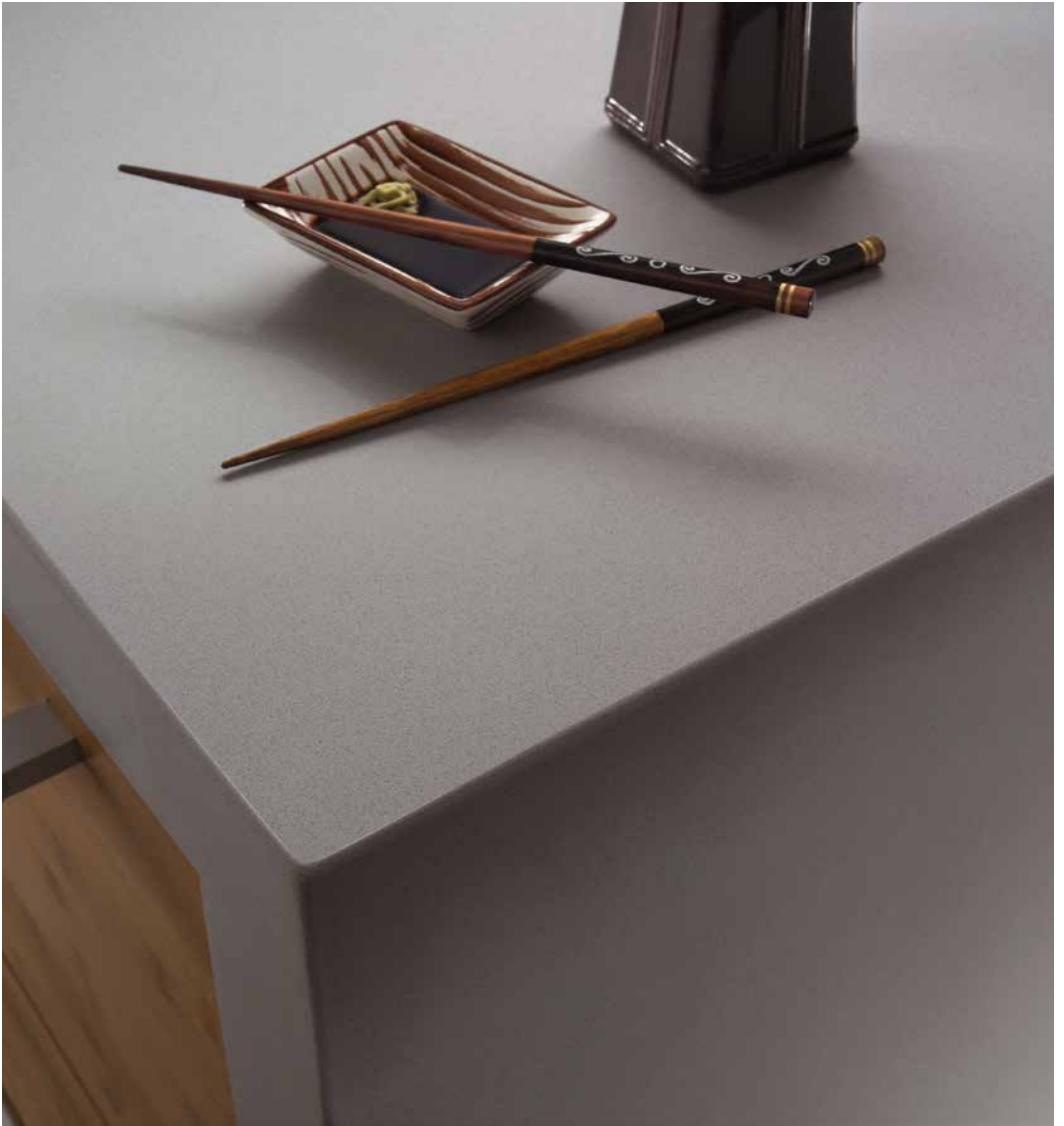

○ Silestone Kensho

SILESTONE®

Edges

Customised cutting and polishing processes can be used for Silestone®, creating edges of all types. This section details some of the most popular ones requested by our customers, but the combinations are limitless.

Edges 2 cm



Bullnose



Demi Bullnose

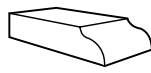

Ogee

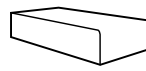

Basic / Eased

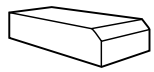

Bevel Xmm



Top Roundover



Shark Nose



Shark Nose

Edges 3 Cm



Bullnose



Demi-Bullnose

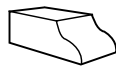

Ogee

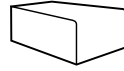

Basic / Eased

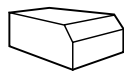

Bevel Xmm

Edges 4 cm

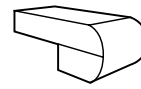

Bullnose

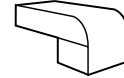

Demi Bullnose

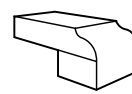

Ogee

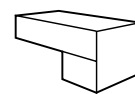

Basic / Eased

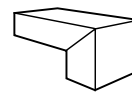

Mitered

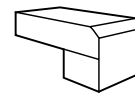

Bevel Xmm

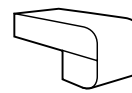

Waterfall

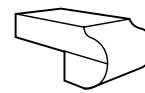

Ogee Bullnose

Other Edges

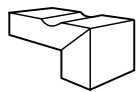

Edge 45° + Mitred bevelled edge 45%

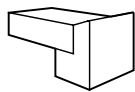

45% Bevelled edge

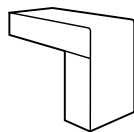

Polished straight edge + Non-bevelled planed section

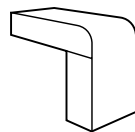

1/4 Bullnose and Non-bevelled planed section

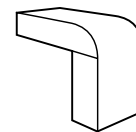

1/2 Bullnose and non-bevelled planed section



SILESTONE®

TOPS ON TOP

Cindy Crawford on Silestone Et. Calacatta Gold









SILESTONE®

Applications

Thanks to its remarkable characteristics, Silestone® is the ideal surface choice for unlimited applications.

Kitchen Countertops

Silestone® is the only quartz surface with a 25 year warranty. It also offers a wide range of colours and textures to transform your kitchen into a unique space. Silestone® can be used in a variety of applications, including countertops, flooring, cladding and backsplashes or even furniture.



“The Kitchen is the heart of the Home”

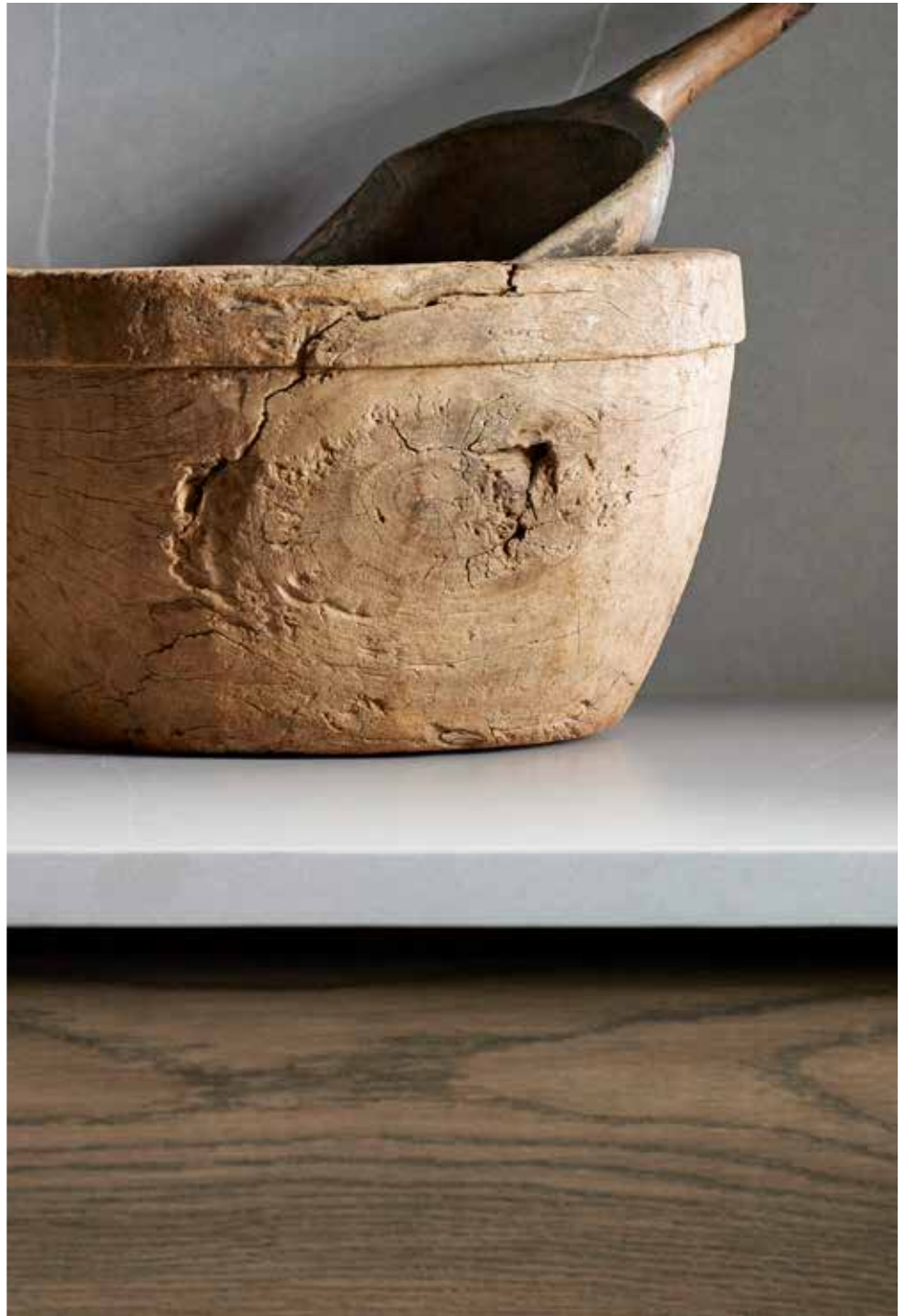





Integrity Sinks

No pieces, no creases, no limits. Integrity wants your kitchen to be whole; a place where there is no start or finish. Integrity gives you the sensation of unity, of perfect integration with the rest of the elements of your worktop.

NEW *Integrity Q*

For Geometry lovers

Measuring 41 x 51 x 17.5 cm and with an almost square shape, the Q model from the Integrity by Silestone® kitchen sink range is the perfect choice for those who love geometry. The new form is even more attractive due to the small, tight curves in its corners.

A key aspect is its monolithic design: a single 3D element manufactured from one piece of Silestone®, which brings a feeling of unity and harmony to the other architectural elements.

Like all the Integrity sinks, the Q model guarantees better hygiene and cleanliness in one of the most important areas of the kitchen; since the sink is the place where most foods are washed before cooking.



○ Silestone Integrity Q - Et. Calacatta Gold

Integrity **ONE**

In one single piece

ONE is the model which embodies Integrity's concept. A single kitchen sink in one piece. Measuring 41x51x15.5 cm, ONE, with its rounded shapes, is the perfect choice for those who love curved shapes.

Integrity **DUE**

Straighter shape

DUE, which is available in three sizes: DUE S: 37x34x15.5cm, ideal for double sinks, DUE L: 37x51x15.5cm, ideal for a main or only sink, and DUE XL: 43.5x67x21cm, with its larger size. Perfect for those who see style and beauty in the sobriety of the straight lines.

Integrity Q



41x51x17.5cm



Integrity ONE



41x51x15,5cm

Integrity DUE



DUE S: 37x34x15.5cm
DUE L: 37x51x15.5cm
DUE XL: 43.5x67x21cm

Integrity TOP



37x51x15,5cm

Bathroom Countertops

Bathroom Collection by Cosentino is an unique concept in the architectural sector based on the use of single materiales that offer superior performance and remarkable beauty. Silestone® is a surface made with quartz available in more than 70 exclusive colours.

Silestone® possesses the ideal characteristics for bathroom countertops. With a low absorption level and virtually no joints, the bathroom surface will remain unchanged after its daily use.





Bathroom Cladding

Bathrooms are personal spaces where one should feel relaxed and refreshed. There's no reason these areas should be drab or feature less design!

Silestone® reinvents the traditional design of the bathroom space with custom-made large format panels. It can be installed vertically as wall cladding or horizontally as flooring. This customization eliminates joints and creates visual continuity.

Bathroom Flooring

Bathrooms are a high traffic area and the durability and resistance of Silestone® reduces wear on bathroom floors. Its minimal maintenance requirements and low porosity make it the ideal product for rooms in which water and other personal hygiene products are used. Environments with damp conditions or changes in temperature require flooring that offers outstanding performance. Silestone® not only meets these requirements, it exceeds them with the added benefit of attractive design.



Bathroom Washbasins

Silestone® Sinks are built with a unique and innovative design for flexibility and elegance.

Armony



Marie



Balance



Simplicity



Equilibrium



Symmetry



Elegance



Silence



Exclusive



Reflection



Bathroom Shower Trays

The Silestone® shower tray collection is based on an exclusive design that offers flexibility and safety. Your shower tray can be adapted to your space.

Freccia



Bubbles



Doppio



Kador



Kador Suite



Exelis



SILESTONE®

Colourchart

More than 60 colours in different textures. Find your favorite.

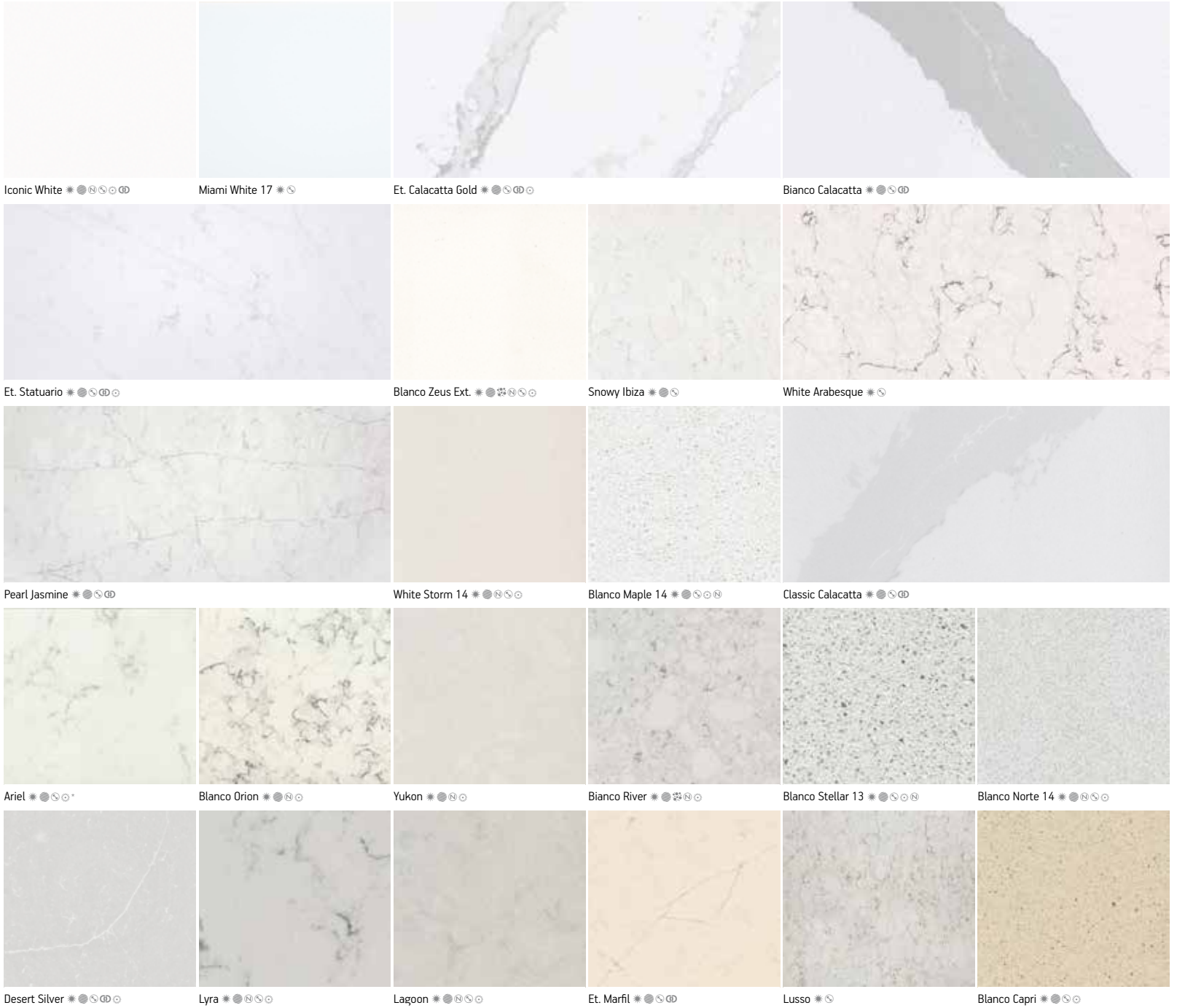

- ☀ POLISHED
- 🌀 SUEDE
- 🌋 VOLCANO
- Ⓝ REGULAR SIZE

- 🌀 JUMBO SIZE
- ♻ RECYCLED MATERIALS
- Ⓜ N-BOOST
- ☀ INTEGRITY SINK



Tigris Sand * 🌋 Ⓝ

Crema Stellar * Ⓝ

Blanco City * Ⓝ Ⓝ

Color Clay Colours * 🌋 Ⓝ Ⓝ

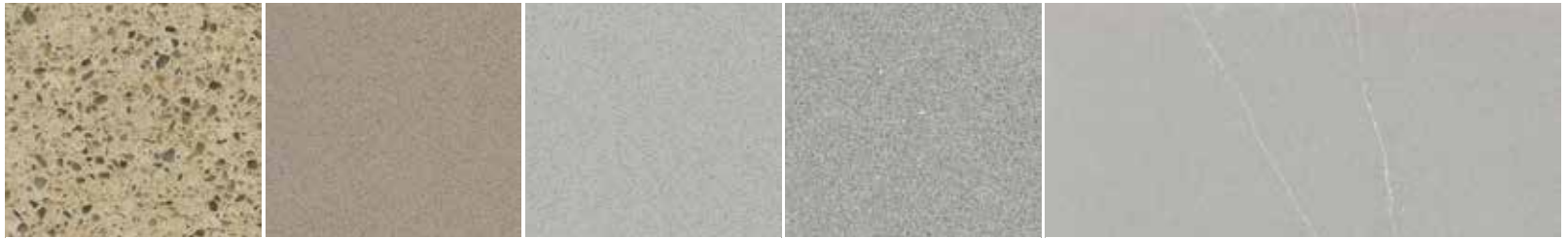

Bamboo 08 * 🌋

Rougui * 🌋 Ⓝ Ⓝ

Niebla * 🌋 Ⓝ Ⓝ

Aluminio Nube * 🌋 Ⓝ Ⓝ

Et. Serena * 🌋 Ⓝ Ⓝ

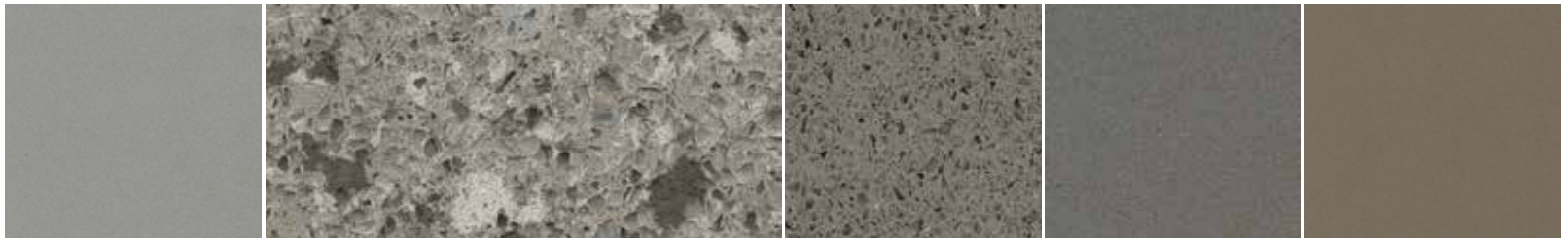

Kensho * 🌋 🌋 Ⓝ Ⓝ

Alpina White 08 * 🌋 Ⓝ

Stellar Grey * Ⓝ

Gris Expo * 🌋 🌋 Ⓝ Ⓝ Ⓝ

Unsuí * 🌋 Ⓝ Ⓝ

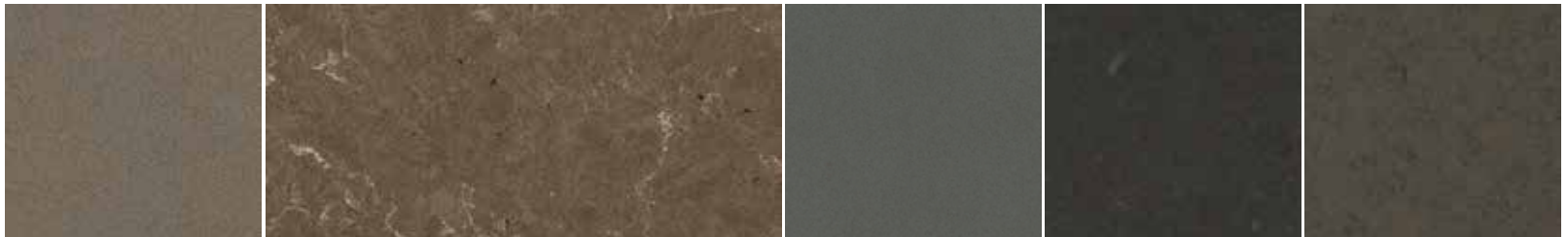

Noka * 🌋 Ⓝ Ⓝ Ⓝ

Ironbark * 🌋 Ⓝ Ⓝ

Cemento Spa * 🌋 🌋 Ⓝ Ⓝ Ⓝ

Merope * 🌋 Ⓝ Ⓝ

Amazon * 🌋 🌋 Ⓝ Ⓝ

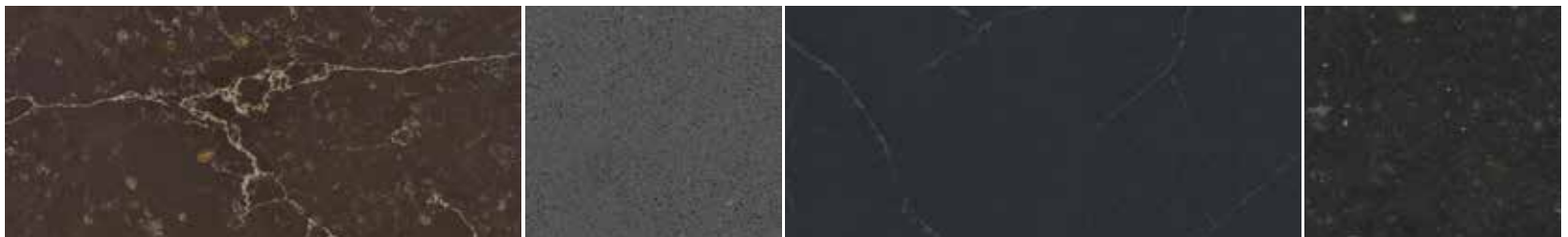

Et. Emperador * 🌋 Ⓝ Ⓝ

Marengo * 🌋 Ⓝ Ⓝ Ⓝ

Charcoal Soapstone * 🌋 Ⓝ Ⓝ Ⓝ Ⓝ

Arden Blue * 🌋 🌋 Ⓝ Ⓝ

SILESTONE®

Colourchart

More than 60 colours in different textures. Find your favorite.

☀ POLISHED

🌀 SUEDE

🌋 VOLCANO

Ⓝ REGULAR SIZE

🌀 JUMBO SIZE

♻ RECYCLED MATERIALS

Ⓝ N-BOOST

☀ INTEGRITY SINK



Negro Tebas 18 ☀🌀ⓃⓃⓃ

Negro Stellar ☀🌀ⓃⓃⓃ

Iconic Black ☀🌀ⓃⓃ

Et. Marquina ☀🌀ⓃⓃ

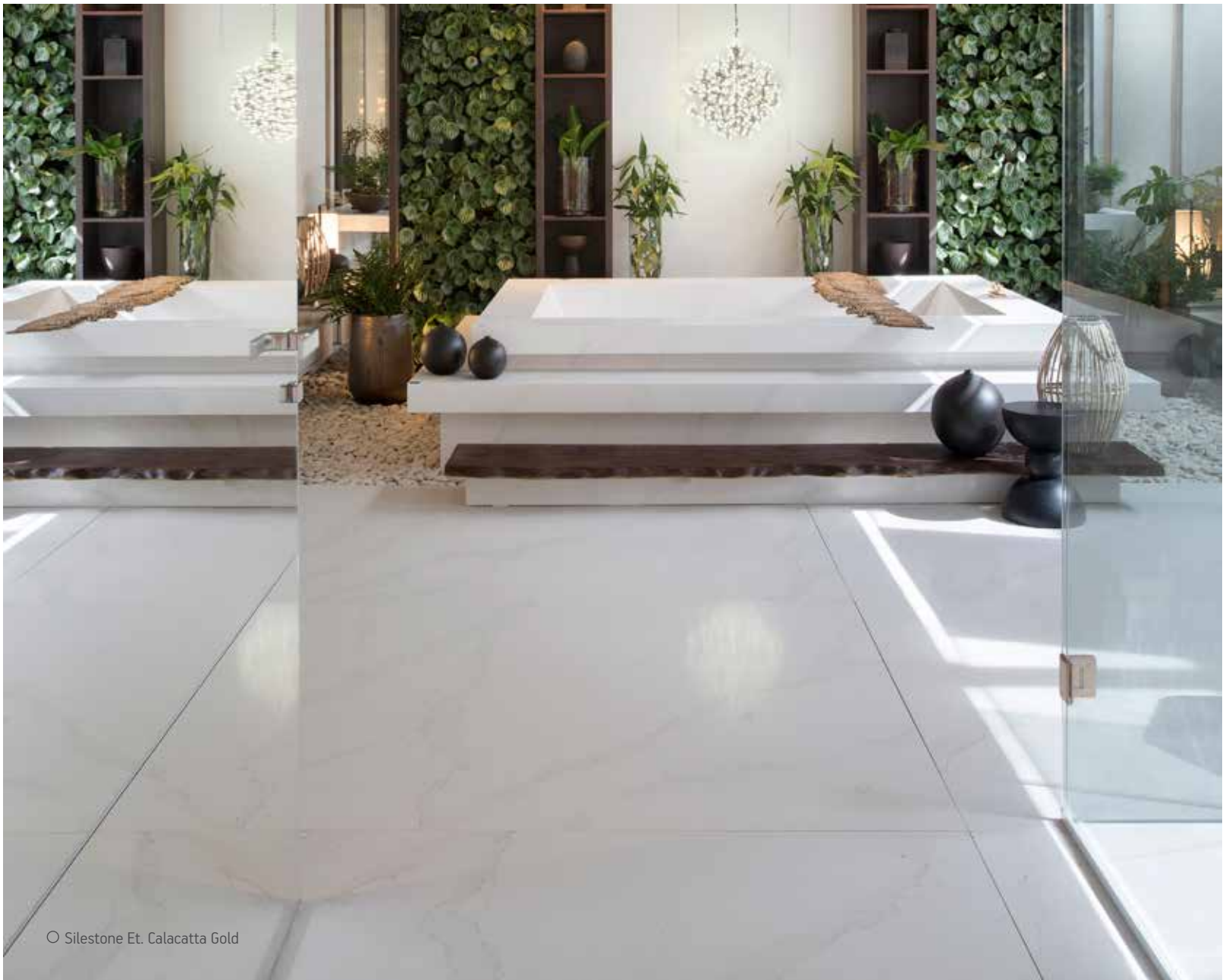

○ Silestone Et. Calacatta Gold

SILESTONE®

Colour Group

Silestone® ✨ Polished

| GROUP 1 | GROUP 2 | GROUP 3 | GROUP 3.5 | GROUP 4 | GROUP 5 | GROUP 6 |
|---|--|---|--|--|---|--|
| BLANCO CITY GRIS EXPO MARENGO  NOKA ROUGUI | ARDEN BLUE BLANCO NORTE 14 CEMENTO SPA COLAR CLAY COLOURS IRONBARK MIAMI WHITE 17 NEGRO TEBAS 18  NIEBLA | ALUMINIO NUBE BLANCO CAPRI BLANCO MAPLE 14 DESERT SILVER  WHITE STORM 14 | ALPINA WHITE 08 AMAZON BIANCO RIVERS BLANCO STELLAR 13 CREMA STELLAR LUSSO NEGRO STELLAR  STELLAR GREY  TIGRIS SAND YUKON | BAMBOO 08 BLANCO ZEUS ICONIC BLACK  KENSHO LAGOON LYRA MEROPE SNOWY IBIZA UNSU WHITE ARABESQUE | ARIEL BLANCO ORION CHARCOAL SOAPSTONE  ET. EMPERADOR  ET. MARFIL  ET. MARQUINA  ET. SERENA  ICONIC WHITE  PEARL JASMINE  | BIANCO CALACATTA  CLASSIC CALACATTA  ET. CALACATTA GOLD  ET. STATUARIO  |

Silestone® Suede

| GROUP 1 | GROUP 2 | GROUP 3 | GROUP 3.5 | GROUP 4 | GROUP 5 | GROUP 6 |
|---|--|---|---|---|---|--|
| BLANCO CITY GRIS EXPO MARENGO  NOKA ROUGUI | ARDEN BLUE BLANCO NORTE 14 CEMENTO SPA COLAR CLAY COLOURS IRONBARK NEGRO TEBAS 18  NIEBLA | ALUMINIO NUBE BLANCO CAPRI BLANCO MAPLE 14 DESERT SILVER  WHITE STORM 14 | ALPINA WHITE 08 AMAZON BIANCO RIVERS BLANCO STELLAR 13 TIGRIS SAND YUKON | BLANCO ZEUS KENSHO LAGOON LYRA MEROPE SNOWY IBIZA UNSU WHITE ARABESQUE | ARIEL BLANCO ORION CHARCOAL SOAPSTONE  ET. EMPERADOR  ET. MARFIL  ET. MARQUINA  ET. SERENA  ICONIC WHITE  PEARL JASMINE  | BIANCO CALACATTA  CLASSIC CALACATTA  ET. CALACATTA GOLD  ET. STATUARIO  |

Silestone® Volcano

| GROUP 1 | GROUP 2 | GROUP 3.5 | GROUP 4 |
|-----------|---------------------------|--|-----------------------|
| GRIS EXPO | ARDEN BLUE CEMENTO SPA | AMAZON BIANCO RIVERS TIGRIS SAND | BLANCO ZEUS KENSHO |



DEKTON®

Ultracompact Surfaces

Dekton® is a sophisticated mixture of the prime materials used to manufacture glass, modern porcelain, and quartz surfaces, employing an exclusive technological process called Sinterized Particle Technology, which involves an accelerated version of the metamorphic changes that natural stone undergoes when exposed to high pressure and temperature over thousands of years.

Dekton® uses a 25,000-tonne press that turns the panel into a large-format highly resistant ultracompact surface.

Thanks to the manufacturing technology Dekton® employs, you can get colours and textures of varying features, including highly pure and chromatically homogeneous solids, materials with very natural veins and movements, or more daring ranges of colours for any table or furniture.





DEKTON®

Product News

*Dekton is always
reinventing itself*

New

When Dekton becomes Nature.

NEW XGLOSS
STONIKA COLLECTION

Dekton's Industrial series was created to pay tribute to the beautiful imperfections of the metals and stone in all their different stages of ageing.

Organic processes that are reflected in the richness and complexity of oxidation and the authentic beauty of maturing stone. Dekton's unparalleled technology gives us the tools to explore and design outside the box and the result is a series of colours that celebrates these incredible materials.

Manufactured for living.





1. Taga 2. Bergen 3. Korso 4. Arga

NEW
DEKTON® SLIM
designed by COSENTINO®



Tiny Thickness → ← **Huge Format & Performance**

Bathroom Cladding

Furniture Cladding

Kitchen Cladding

Easy Installation



Fewer Joints
Greater Hygiene



Cut to size
Limitless customisation



Surfaces measuring
3,200 x 1,440 mm



Same stain and scratch
resistance as other
Dekton formats



Easy Installation

New

Dekton Slim 4 mm

Dekton® Slim is the new, large format surface with an ultrathin 4-mm thickness that offers unlimited design options and incredible ease of installation and transport.



Bathroom Cladding

Maximum resistance, minimal joints

Ideal for bathrooms, Dekton® Slim offers cladding that is ultra-resistant to humidity and stains. A high-performing product that does not require any more maintenance beyond a damp cloth.

Its large format measuring 3,200 mm x 1,440 mm covers large surfaces, avoiding a large number of joints and in turn, dirt.



Kitchen Cladding

Reduced thickness, infinite possibilities

The ultra-thin Dekton® Slim surface, with a thickness of 4 mm, is ideal for the cladding of kitchen walls and cupboards, resulting in a harmonious blend with countertops of different thicknesses.

Dekton® Slim is scratch-, fire- and stain-resistant, just like its other formats.



Furniture Cladding

Furniture with beautiful and highly resistant surfaces

Dekton® Slim creates furniture with unprecedented performance: tables that are resistant to everything and doors that neither scratch nor stain. The design possibilities are endless since it is cut to measure and easy to install.

New

Four reasons to choose Dekton Slim in your bathroom.

Maximum resistance against humidity with the minimal joints in the lightest Dekton® format.

LARGE FORMAT AND MINIMA JOINTS

Its large format measuring 3,200 mm x 1,440 mm covers large surfaces, avoiding a large number of joints and in turn, dirt.

01

02

EASY INSTALLATION

Thanks to its light format with an array of possibilities, everything just got a lot simpler. Its reduced thickness means it can be cut quickly and adjustments can be made on-site with tools for ceramic tiles.

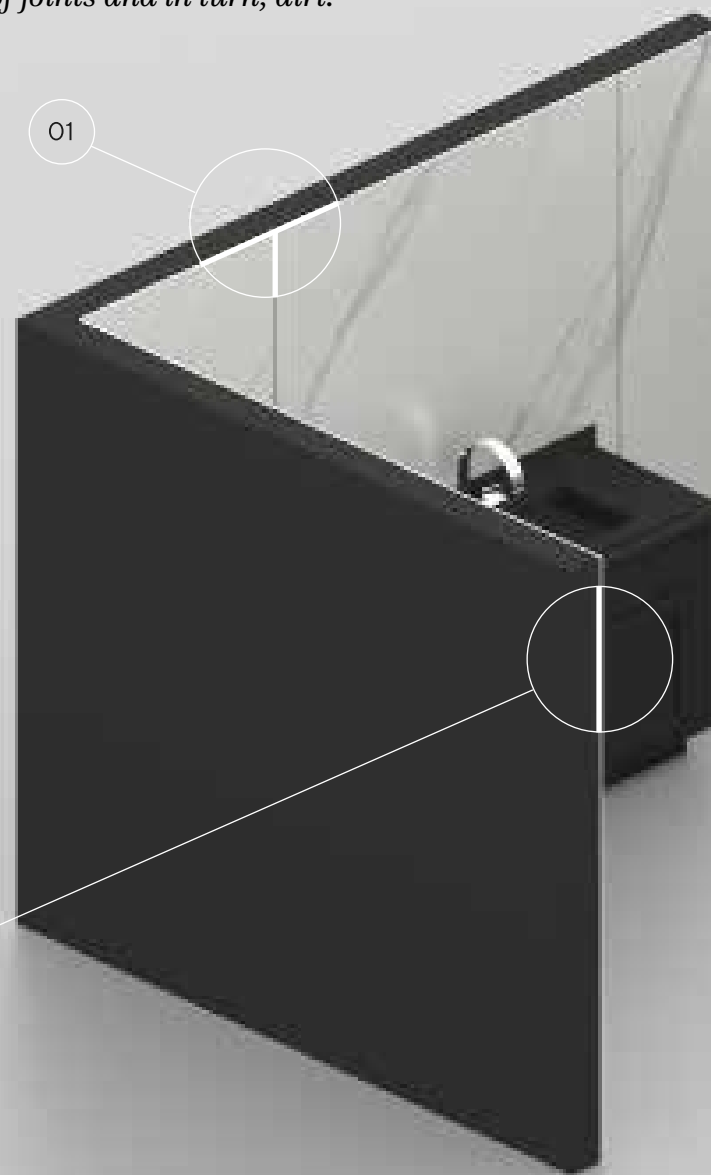

**MAXIMUM RESISTANCE
AGAINST HUMIDITY WITH
THE MINIMAL JOINTS IN
THE LIGHTEST DEKTON®
FORMAT.**



03

**LIMITLESS
DESIGN**

Dekton® Slim is very simple to install and can be cut with great ease. It is the ideal surface to personalise your furniture with innovative designs.

DEKTON®

Benefits

Large format surface
with the best market advantages.
Discover them.



Its Resists Everything

Extremely resistant to scratching, virtually zero porosity and highly resistant to aggressive chemical products.

Relentless in Heat

Extreme resistance to high temperatures, cookware fresh off the hotplate and UV rays.

Unlimited Inspiration

Design your modern kitchen with eye-catching colours and unique textures. Large format for new compositional solutions.

Worktop to be Enjoyed

Easy maintenance, no traces of fingerprints or marks and maximum durability. Your Dekton worktop is guaranteed for 25 years.

Infinite Possibilities

Thanks to the size (up to 3200x1440mm)* and the lightness of Dekton® (from 8 mm thick), the design possibilities for your kitchen, bathroom, façade, walls or high transit floors are growing exponentially.

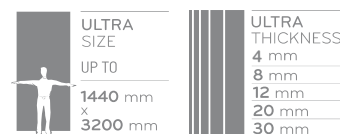

**Dekton®
Benefits**



Highly UV
Resistant



Scratch
Resistant



Resistant
to Stains



Maximum
Resistance to
Fire and Heat



Resistant to
Freezing and
Thawing



Resistant to
Abrasion



Superior Mechanical
Resistance



Low Water
Absorption



Dimensional
Stability



Fireproof
Material



High Resistance
to Hydrolysis



**Dekton® X-Gloss
Benefits**



Crystalline
Shine



Water
Repellent

* Check availability of 3cm thickness.

DEKTON®

Applications

Dekton® offers multiple applications for both indoors and outdoors. Facades, countertops, heavily trafficked floors, etc...

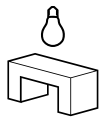

Kitchen worktops

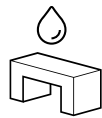

Bathroom worktops

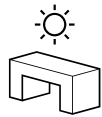

Outdoor worktops

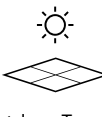

Outdoor Terrace
Floor Coverings

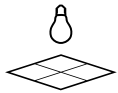

Indoor floors

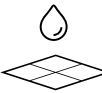

Bathroom and Pool
Floor Coverings



Outdoor Terrace
Floor Coverings



Bathroom Walls

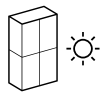

Exterior Walls

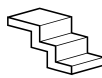

Stairs

Kitchen Countertops

Dekton® is a long-term product for those looking to turn their kitchen into a unique space.



Firstly, because it allows you to have installation in one piece with fewer cuts and joints, no limits just the appeal of a completely uniform surface, which fits seamlessly into very different design styles.

Dekton® combines the qualities desired by the chef in all of us. It is a clean surface that is nice to touch and resistant to the daily grind that takes place in a kitchen over years of use. An ultra-sophisticated material for busy everyday life, capable of creating spaces that make the

preparing of food, day after day, a pleasant experience that precedes the pleasure of sharing a meal with friends or family. It represents beauty and solidity with easy, fuss-free cleaning. The structural density of Dekton® is a breakthrough in engineering, but what really matters is that we do not have to worry about scratches, stains or traces of heat. A simple wipe with a cloth and presto, because the kitchen should be enjoyed with no restrictions, this is the Dekton® way of thinking.





Outdoor Kitchen Covering

Cook with the Sky as a Roof

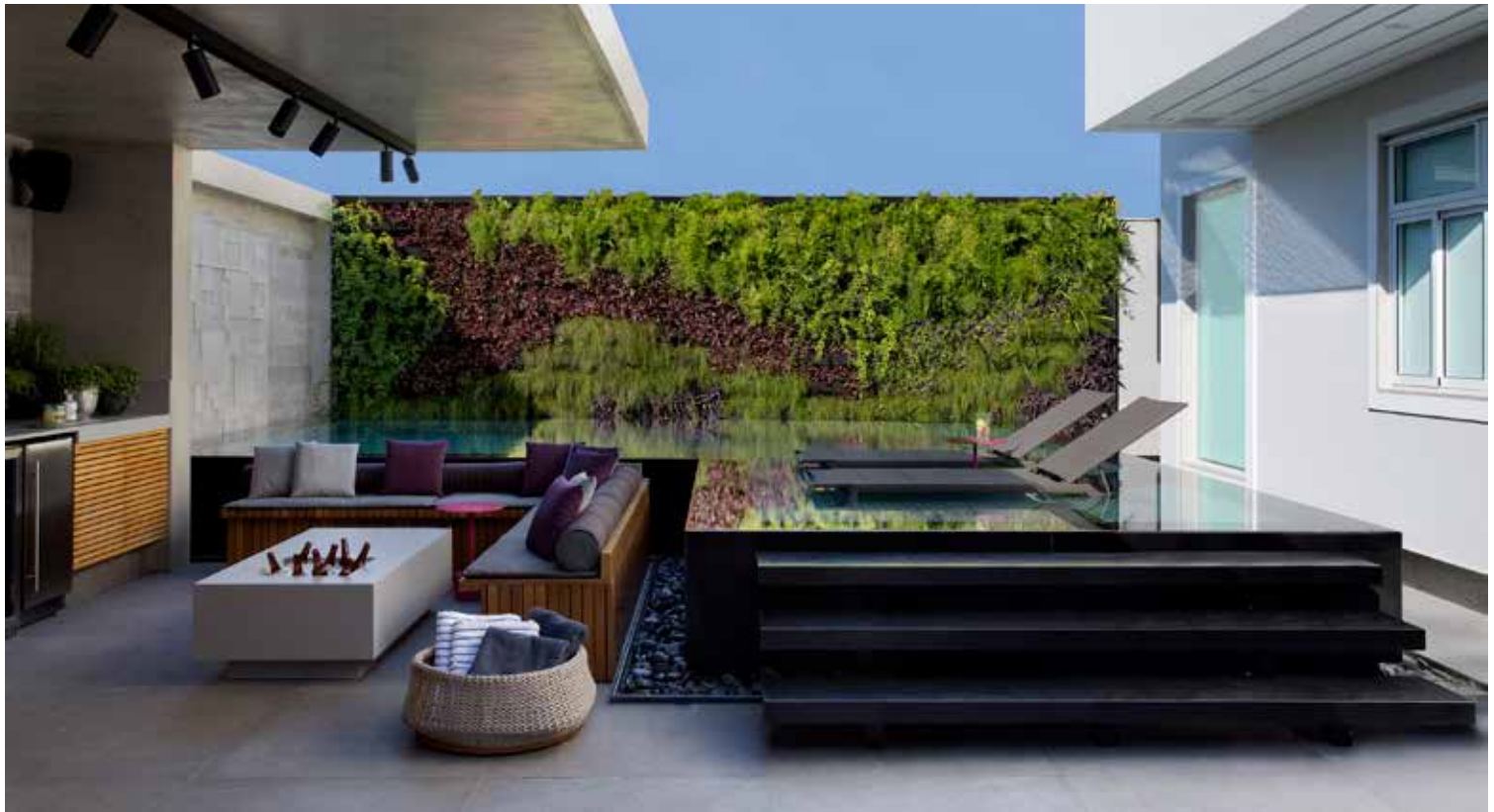

Cooking is definitely a pleasurable experience and doing it outdoors, usually results in a small social event. Everyday celebrations that we can enjoy with company around a grill. Dekton®, due to its ultra-compact structure, is particularly suitable for installations for outdoor kitchens and barbecues.

Dekton® provides strength and style to these spaces, it gives them an undeniable personality and unlimited practicality. Stains, bumps, utensils at high temperature... Dekton® will resist the demanding use over time while maintaining its unchanging beauty.

It is not affected by ice, sun, sleet, or wind either. When bad weather arrives, Dekton® simply needs an effortless, fuss-free cleaning so that it can showcase its best again.

Bathroom Worktops and Wall Covering

The bathroom is the space in the home, where hygiene and harmony need to express themselves in the best possible way. A peaceful environment devoted to personal care and hygiene - a space to relax and unwind free of any worries.

Dekton[®], thanks to its low porosity, is completely waterproof against liquids.

Water glides smoothly over the surface without ever penetrating. This, along with unchanging beauty, results in extremely easy cleaning.

Their textures and colours are an endless source of inspiration for the design of water-related areas, we're talking about Dekton[®], its possibilities are endless.

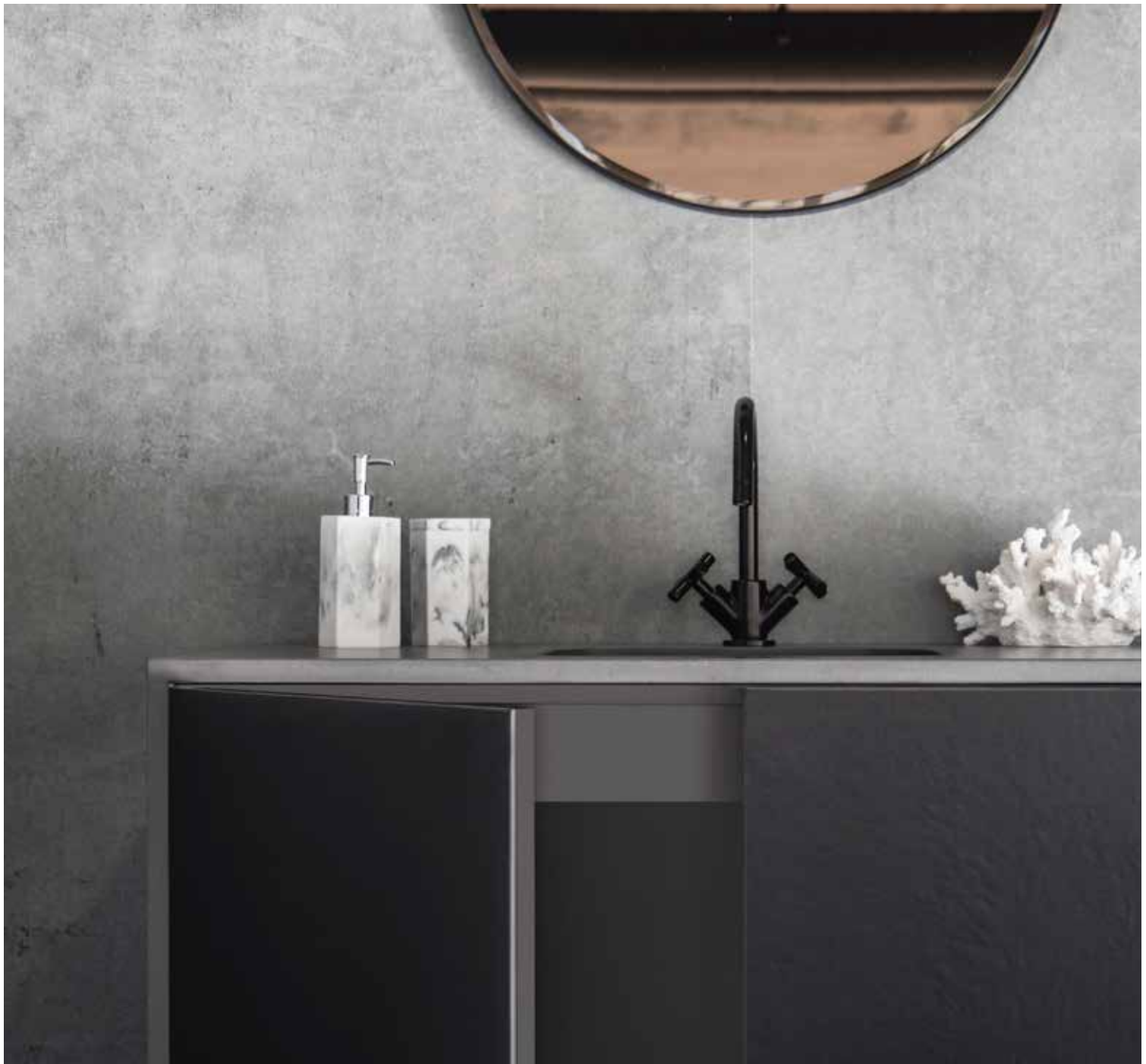



Façades

Dekton® is available in large format panels with minimum thickness, rewriting the rules of what is possible with Ultracompact Surfacing materials. Dekton® panels measure 320cm x 144cm with a thickness range of 4mm to 30mm. Aside from the advantage of its size capabilities, Dekton® is highly resilient and can be installed as part of ventilated rainscreen system, or, due to its remarkable durability

and low moisture absorption, installed as a direct adhere façade, similar to dimensional stones like granite.

Dekton® is the architect's choice when unlimited surface and space designs are required, where color and texture flow freely in all directions inside and out, expressing itself in all of its fullness and versatility.

*High Performance
All Purpose Façades
Designing Without Limits*

Large Format Panels:

320cm x 144cm

Recommended façade thickness:

8mm, 12mm, and 20mm.

Flexural strength.

Excellent dimensional stability.

Resistance to freezing and thawing.

Unmatched Color stability.





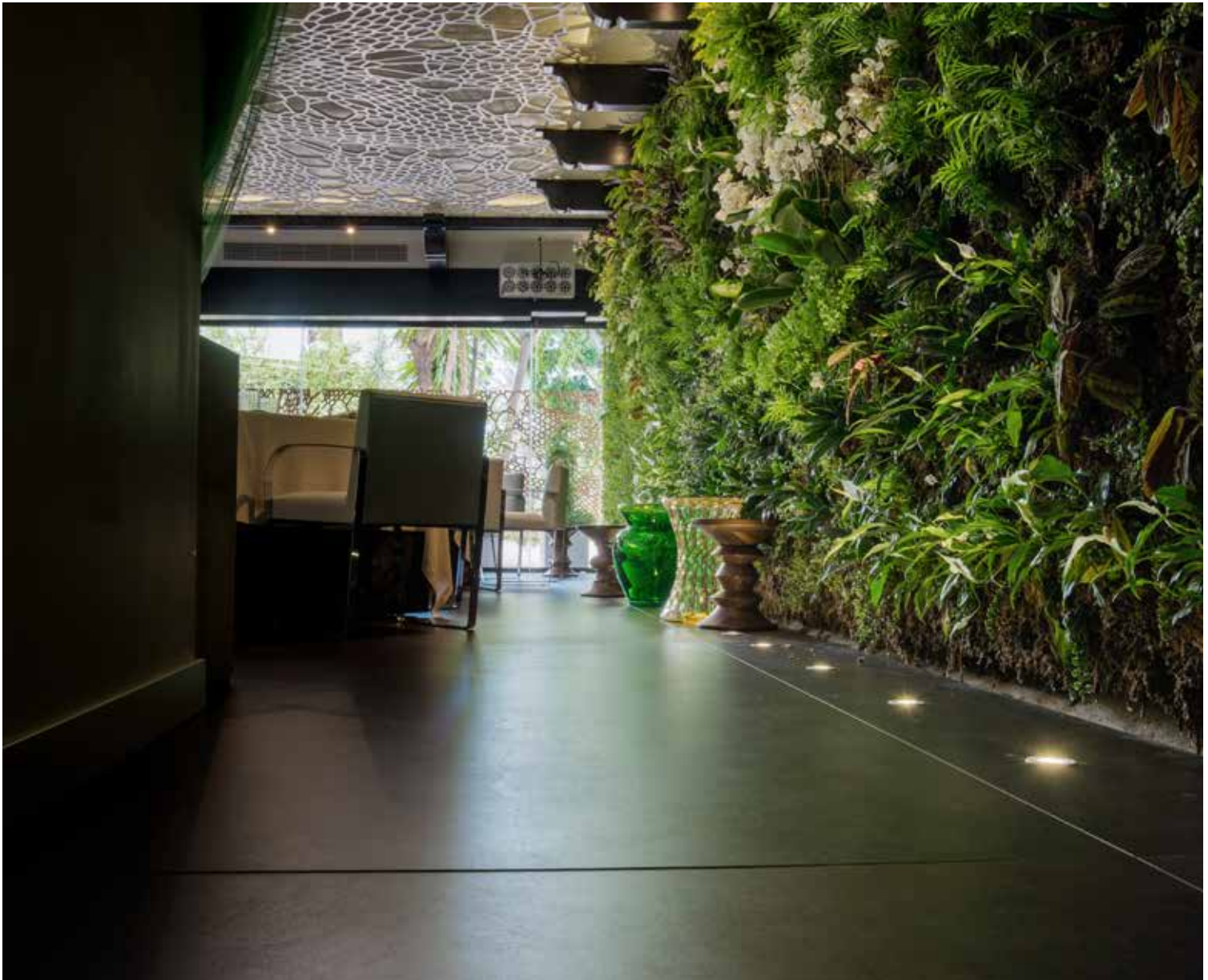

Flooring Solutions

Dekton's superior technical characteristics offer excellent resistance to scratches and abrasion and therefore can be used in high traffic areas. Dekton's unique resistance to UV rays allows for color stability and exceptional performance in outdoor spaces. Due to its ability to resist heat, frost and thawing, the product can be used outdoors in all weather conditions. This powerful combination allows for the ability to design without limits.

Dekton is a blend of raw materials, that undergo a unique technological process known as Particle

Sintering Technology, which is an accelerated version of the metamorphic changes that occur when natural stone is exposed to high pressure and temperature for thousands of years. The Dekton press is 25,000 tons, the largest press in the world, which makes the stone into an ultra-compact surface of an unprecedented size and thickness, ensuring extreme performance. This level of compaction contributes significantly to the low porosity of the material, making it a long lasting product that requires minimal maintenance.

Aura Bookmatch

With Aura we have evolved from a single slab design to an endless symmetrical pattern. With 8 unique designs, we can reproduce matching compositions that allow continuous vein matching from slab to slab.

THERE ARE 2 POSSIBLE WAYS TO ORDER AURA:

Regular Aura slabs.

You will receive a random pattern and the slabs are available in our warehouse.

Book and Vein matched Aura slabs.

These slabs are available on demand and will be inventoried at our HUB facilities. Vein and book matched materials will be charged at an additional 20% fee.

Aura is matched vertically and horizontally; we have a system with letters and numbers so you can select the pattern that better fits your needs. Notice that you can choose different combinations depending on the amount of vein you like in your design. You may also choose from vertical or horizontal matching as well as traditional mirror bookmatching effect or vein matching.



DEKTON®

Colourchart

Discover the color that fits your idea or project.



Antislip treatment is only recommended for barefoot areas, such as pools or Spas.
This treatment can produce a slight variation in the colour tone.

-  ULTRA TEXTURE
-  ULTRA MATE
-  VELVET TEXTURE
-  XGLOSS

















-  ECO DEKTON
-  THICKNESS 3CM
-  Dekton Slim 4mm
-  DEKTON GRIP
The anti-slip solution



















DEKTON®





Colour Group

DEKTON® COLLECTION

| | Group 0 | Group I | Group II | Group III | Group IV |
|-----------------------|--|---|---|---|---|
| SOLID COLLECTION | | SIRIUS  | DOMOOS  GALEMA  KORUS  VENTUS  | ZENITH  | |
| NATURAL COLLECTION | GADA  SIROCCO  VEGHA  | BROMO  DANAE  EDORA  FOSSIL  NAYLA  SASEA  | KELYA  KIRA  KOVIK  VERA  | AURA 15  ENTZO  KAIROS  OPERA  PORTUM  | AURA 15 BOOKMATCH  |
| TECH COLLECTION | BLANC CONCRETE  | KEON  KERANIUM  | STRATO  | | |
| WILD COLLECTION | ALDEM  | | MAKAI  | | |
| INDUSTRIAL COLLECTION | | MILAR  | KRETA  LAOS  LUNAR  NILIUM  ORIX  RADIUM  SOKE  TRILIUM  | | |

DEKTON® XGLOSS

| | Group 0 | Group II | Group III | Group IV |
|--------------------|---|---|---|---|
| SOLID COLLECTION | | | BLAZE  LUMINA  SPLENDOR  | HALO  SPECTRA  |
| NATURAL COLLECTION | | | FIORD  GLACIER  TUNDRA  | NATURA 18  |
| BASIQ COLLECTION | QATAR  | MANHATTAN  VIENNA  | | |
| STONIKA COLLECTION | | | KORSO  ARGA  BERGEN  TAGA  | |

-  ULTRA TEXTURE
-  ULTRA MATE
-  VELVET TEXTURE
-  XGLOSS
-  ECO DEKTON
-  THICKNESS 3CM
-  Dekton Slim 4mm
-  DEKTON GRIP
The anti-slip solution

Redefining Surfaces.
Redefining Limits.

 **DEKTON**[®]
designed by COSENTINO

Dekton Ultracompact breaks down architectural boundaries and reimagines spaces to become **infinite**.

We have redefined concepts to create a revolutionary and versatile material with a **unique** design, format and resistance



A product designed by COSENTINO

Wall/flooring colour Dekton Industrial Soke^{NEW}
Modules colour Dekton Stonika Bergen^{NEW}

Find out more about the 25 years transferable Dekton warranty,
look out inspiration and find resources at [cosentino.com](https://www.cosentino.com)





SENSA BY COSENTINO®

Protected Natural Stone

Sensa is a maintenance free premium Natural Stone brought to you by Cosentino, a world leader in the natural stone industry.

Sensa is treated with a revolutionary stain protection treatment called SenGuard, and comes with a 15 year transferable stain warranty.



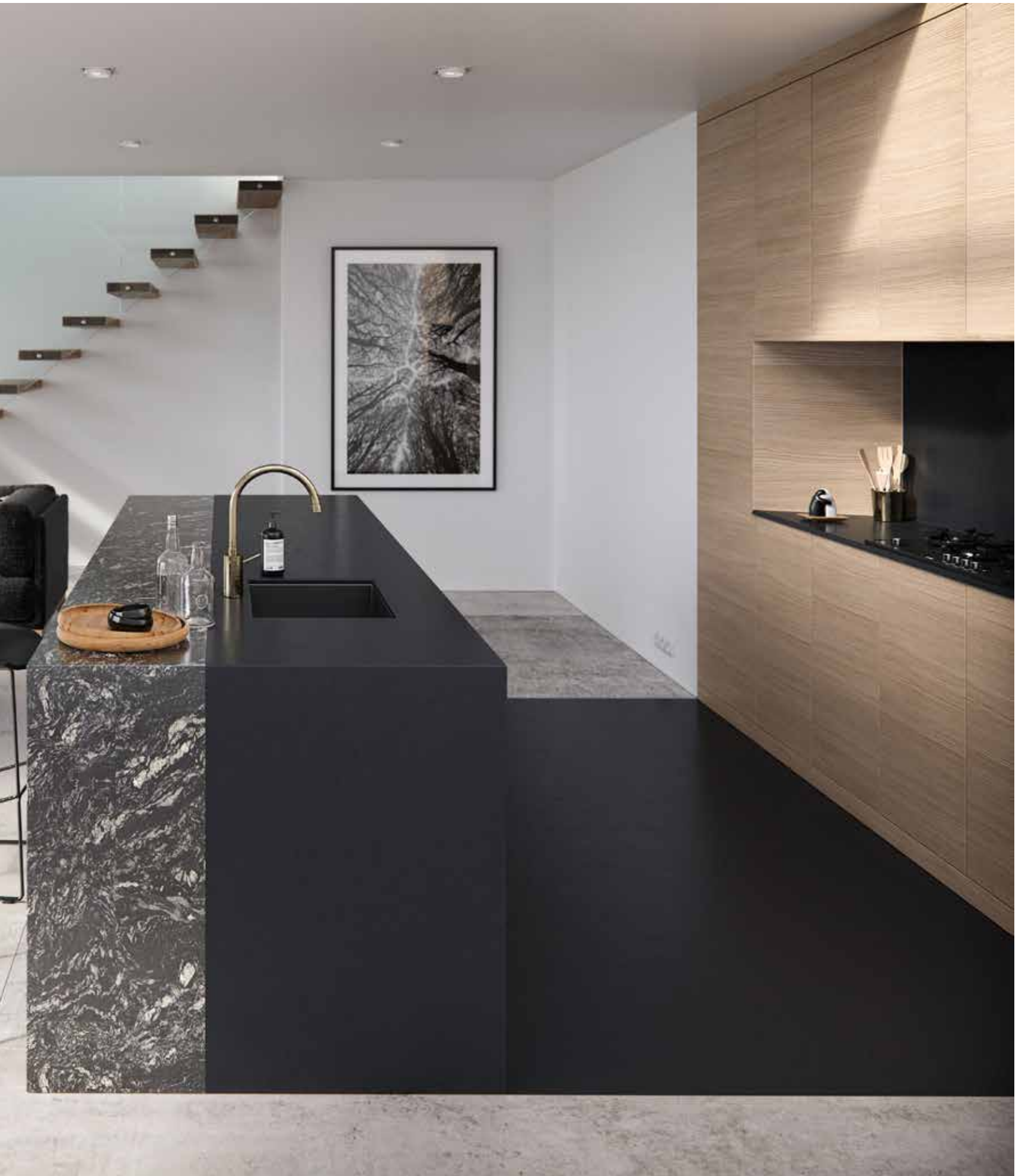

SENSA BY COSENTINO®

Benefits

Sensa® Protected Natural Stone with SenGuard™ Adds Elegant Style To Your Kitchen with Long-Term Stain Protection.



100% Stain protection with SenGuard technology.



Does not require sealers or specialized cleaners.



Maintenance-free Premium Natural Stone.



UV resistant



15-year Transferable Warranty.



Withstands Temperatures of up to 5720 F (150°C).



SENSA BY COSENTINO®

SenGuard Protection

SenGuard is a proprietary stone treatment that is used to protect SenSa granite from staining. SenGuard is not a sealer and bonds to the granite surface different than sealers.

The SenGuard treatment, unlike common sealers, allows the stone to breathe by anchoring to the stone lattice while preserving the stone's natural, beautiful colour for years to come.

- No sealing required.
- Enters stone lattice and chemically bonds, allowing stone to breathe.
- No special cleaners required. Common household cleaners do not affect the SenGuard protection.
- SenGuard remains bonded to stone.
- Proprietary treatment applied in state-of-the-art controlled environment facility.



SENSA
by COSENTINO®



REGULAR

Unique Exclusive Design

Works of art that have required millennia to finish are now are part of the finest collection in the world.

Cosentino's experts selected these natural stone paintings one by one to bring them from the other end of the globe to the most elegant, personal and exclusive museum: your home.

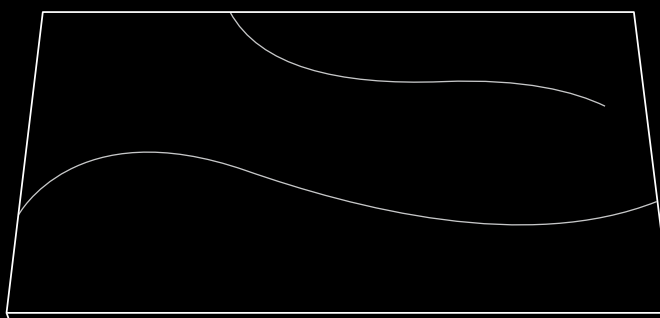
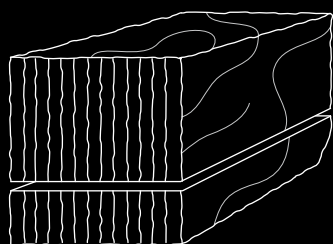
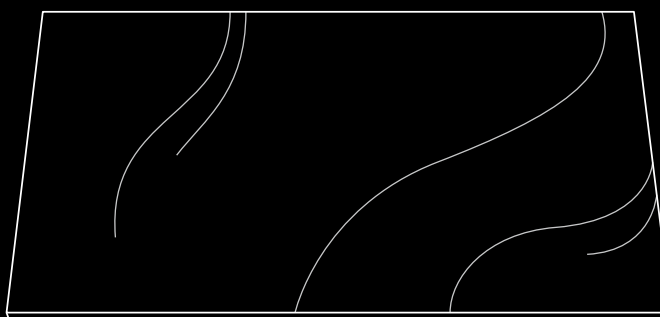
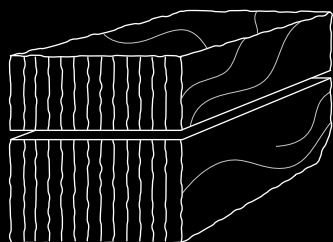
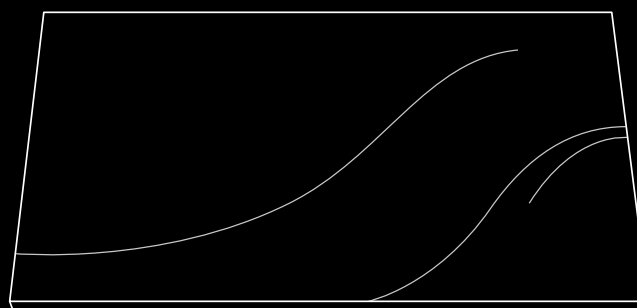
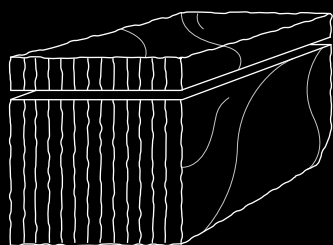

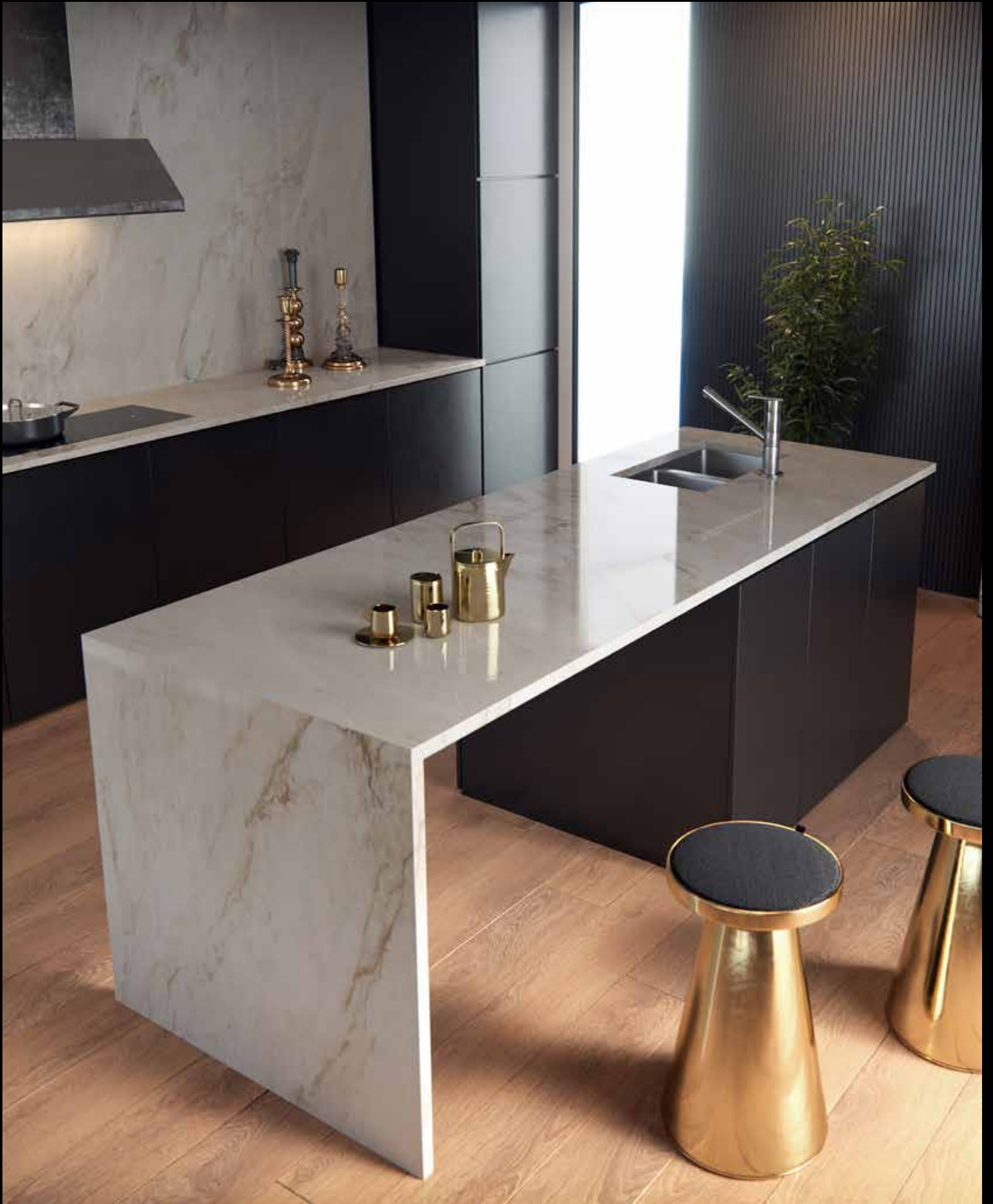





SENSA BY COSENTINO®

Colourchart

*Natural colors brought
directly from nature.*



Colonial White ✎



Taj Mahal ✎



White Macaubas ✎



Glacial Blue ✎



Ice Blue ✎

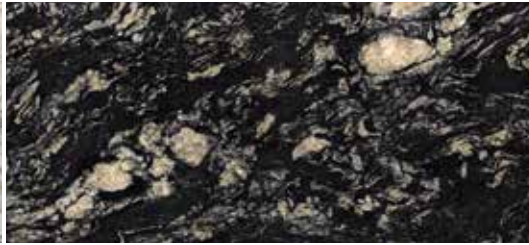

Indian Black ✎

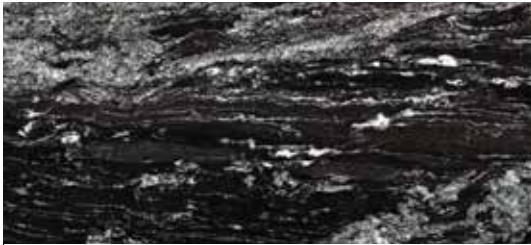

Black Beauty ●

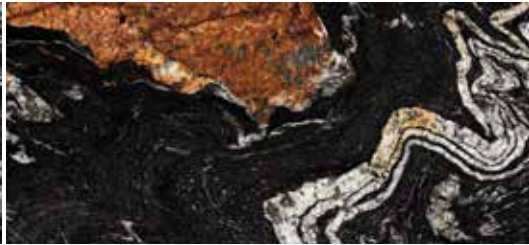

Orinoco ✎

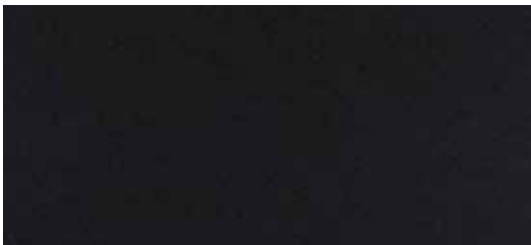

Moak Black ●

- ✎ PULIDO
- SUEDE
- CARESSE







PREXURY
by COSENTINO®

PREXURY BY COSENTINO®

Precious Surfaces

Prexury by Cosentino® is a range of extremely beautiful surfaces for kitchens and baths with an air of subtle elegance.

The luminous range of Prexury by Cosentino® brings together high purity quartz, semiprecious stones and fossilised materials processed using handcraft techniques.





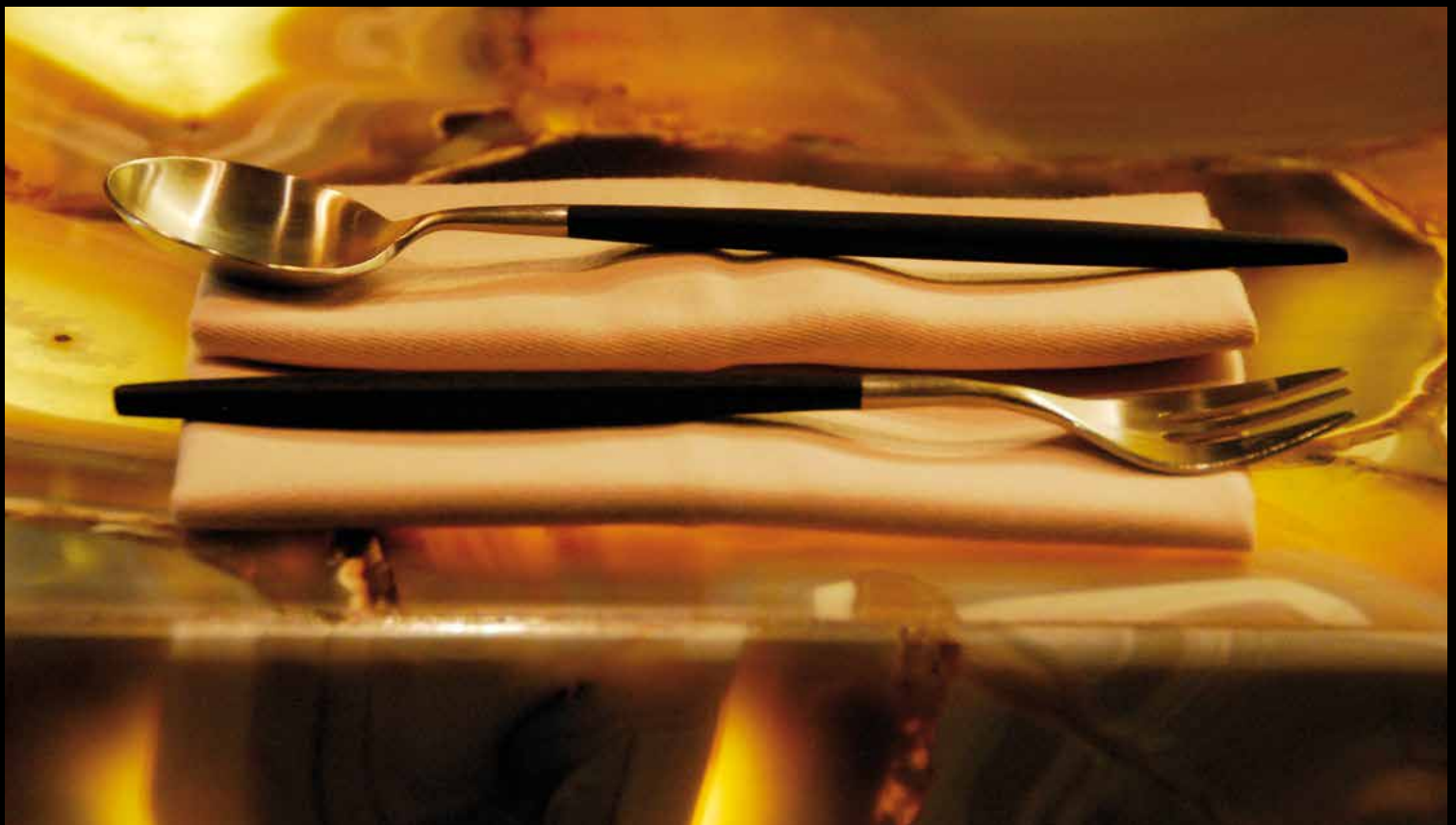

PREXURY BY COSENTINO®

Colourchart

Precious surfaces

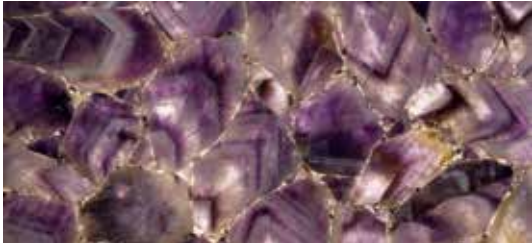

Amethyst *

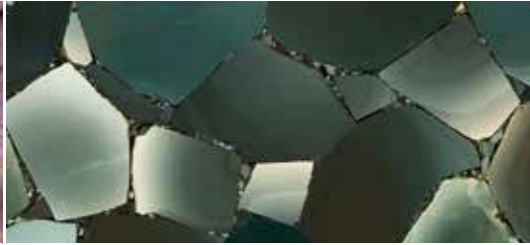

Angel Jasper *



Classic Quartz *

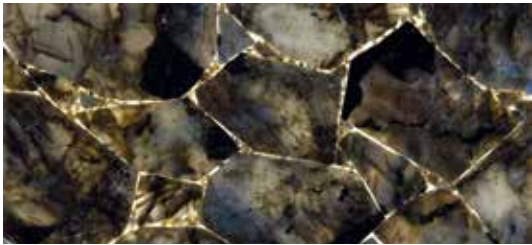

Labradorite *



Retro Petrified Wood *



Red Jasper *



Petrified Wood *



Retro Tiger Iron *



Smokey Quartz *



Wild Agate *



Rose Quartz *



A Big Family Around the World

USA

Cosentino ANAHEIM
 Cosentino ATLANTA
 Cosentino AUSTIN
 Cosentino BOSTON
 Cosentino CHARLOTTE
 Cosentino CHICAGO
 Cosentino CINCINNATI
 Cosentino DALLAS
 Cosentino DENVER
 Cosentino DETROIT
 Cosentino FORT LAUDERDALE
 Cosentino HAWAII
 Cosentino HOUSTON
 Cosentino KANSAS CITY
 Cosentino LONG ISLAND
 Cosentino LOS ANGELES
 Cosentino MILWAUKEE
 Cosentino MINNEAPOLIS
 Cosentino NEW JERSEY
 Cosentino NEW ORLEANS
 Cosentino NASHVILLE
 Cosentino ORLANDO
 Cosentino PHILADELPHIA
 Cosentino PHOENIX
 Cosentino PITTSBURG
 Cosentino PORTLAND
 Cosentino RALEIGH
 Cosentino ROCHESTER
 Cosentino SACRAMENTO
 Cosentino SAINT LOUIS
 Cosentino SAN DIEGO
 Cosentino SAN FRANCISCO
 Cosentino SALT LAKE CITY*
 Cosentino SEATTLE
 Cosentino SPOKANE
 Cosentino TAMPA
 Cosentino VIRGINIA
 Cosentino WASHINGTON DC
 Cosentino WESTCHESTER
 Cosentino CITY LOS ANGELES*

Cosentino CITY MANHATTAN
 Cosentino CITY MIAMI
 Cosentino CITY SAN FRANCISCO
 Cosentino HUB HOUSTON
 Cosentino HUB NORFOLK

CANADA

Cosentino CALGARY
 Cosentino VANCOUVER
 Cosentino TORONTO
 Cosentino QUEBEC
 Cosentino CITY TORONTO
 Cosentino CITY MONTREAL

MEXICO

Cosentino MEXICO DF

PUERTO RICO

Cosentino LO PUERTO RICO

ESPAÑA

Cosentino A CORUÑA
 Cosentino ALMERÍA
 Cosentino BILBAO
 Cosentino BARCELONA
 Cosentino CASTELLÓN
 Cosentino GIRONA
 Cosentino GRANADA
 Cosentino MÉRIDA
 Cosentino MADRID
 Cosentino MURCIA
 Cosentino SAN SEBASTIAN
 Cosentino SANTANDER
 Cosentino SEVILLA
 Cosentino TOLEDO
 Cosentino VALENCIA
 Cosentino VALLADOLID
 Cosentino VIGO
 Cosentino ZARAGOZA
 Cosentino CITY MADRID

PORTUGAL

Cosentino LISBOA
 Cosentino PORTO

BRASIL

Cosentino FORTALEZA
 Cosentino GOIÂNIA
 Cosentino LATINA VITORIA
 Cosentino RECIFE
 Cosentino SAO PAULO
 Cosentino SANTA CATARINA

UK

Cosentino BELFAST*
 Cosentino DARLINGTON
 Cosentino EAST LONDON
 Cosentino GLOUCESTER
 Cosentino HOOK
 Cosentino MANCHESTER
 Cosentino NEWMARKET*
 Cosentino SCOTLAND
 Cosentino CITY LONDON

IRELAND

Cosentino DUBLIN

DENMARK

Cosentino DENMARK

FINLAND

Cosentino HELSINKI

GERMANY

Cosentino BERLIN
 Cosentino DÜSSELDORF
 Cosentino MUNCHEN
 Cosentino STUTTGART

POLAND

Cosentino WARSAW

ITALY

Cosentino CATTOLICA
 Cosentino MILANO
 Cosentino ROMA*
 Cosentino TORINO*
 Cosentino VENEZIA
 Cosentino CITY MILANO

FRANCE

Cosentino LYON
 Cosentino MARSEILLE*
 Cosentino PARIS
 Cosentino RENNES
 Cosentino STRASBOURG*
 Cosentino TOULOUSE

AUSTRIA

Cosentino VIENA

BELGIUM

Cosentino BELGIUM

NORWAY

Cosentino OSLO

SWEDEN

Cosentino GÖTEBORG
 Cosentino STOCKHOLM*

SWITZERLAND

Cosentino ZURICH

NETHERLANDS

Cosentino THE NETHERLANDS

ISRAEL

Cosentino CAESAREA
 Cosentino TEL AVIV

TURQUIA

Cosentino ANKARA
 Cosentino ESTAMBUL
 Cosentino IZMIR

SINGAPORE

Cosentino SINGAPORE
 Cosentino CITY SINGAPORE

NEW ZEALAND

Cosentino AUCKLAND

JAPAN

Cosentino LO TOKIO

AUSTRALIA

Cosentino BRISBANE
 Cosentino ADELAIDE
 Cosentino MELBOURNE SOUTH
 Cosentino MELBOURNE NORTH
 Cosentino PERTH
 Cosentino SIDNEY
 Cosentino CITY SYDNEY
 Cosentino HUB SYDNEY

SOUTH AFRICA

Cosentino JOHANNESBURG
 Cosentino LO CAPE TOWN

UAE

Cosentino CITY DUBAI
 Cosentino LO DUBAI

www.cosentino.com

A product designed by **COSENTINO**

COSENTINO UK- CENTRAL OFFICES

Unit 10 Bartley Point/ Osborn Way/ Hook
Hampshire RG27 9GX/ HQ: info.uk@cosentino.com

 [cosentinouk.ie](https://www.facebook.com/cosentinouk)  [@CosentinoUK](https://twitter.com/CosentinoUK)

STONEMAN'S FINEST PRODUCTS