

9W INGROUND UPLIGHT

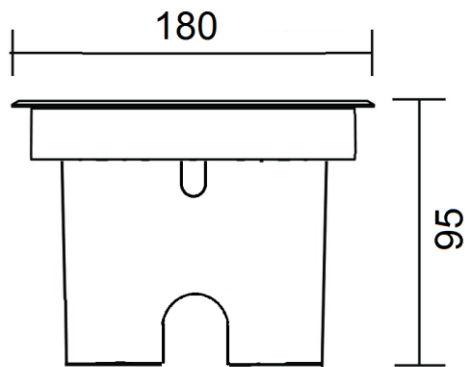

Part No	: EG-IGUP-9W
Material	: Aluminium body with Stainless Steel Trim and Tempered glass diffuser
Wattage (W)	: 9W
Input Voltage (V)	: AC85 – 265V / 12V AC/DC
Frequency (Hz)	: 50/60Hz
Luminous Efficacy (Lm/W)	: 100 Lm/W
CCT (°K)	: 3000K/4000K/6000K/R/G/B/RGB
Beam Angle	: 30°/45°/60°
Lifetime (Hr)	: 50,000

