



**2018 - UP GL1800  
Gold Wing &  
Gold Wing Tour**

**Trike Kit  
Installation  
Instructions**

**Revised 7/13/2022**

**California Sidecar Parts & Technical Support  
434.263.6500**



## **Table of Contents:**

<b>Warnings and Considerations</b>	<b>4</b>
<b>Disassembly of Motorcycle</b>	<b>6</b>
<b>Modification of Motorcycle Frame</b>	<b>23</b>
<b>Frame Mount Installation</b>	<b>25</b>
<b>Rear Suspension Unit Installation</b>	<b>30</b>
<b>ABS Sensor Installation</b>	<b>34</b>
<b>Park Brake Caliper Adjustment</b>	<b>34</b>
<b>Gravel Pan Installation</b>	<b>36</b>
<b>Brake Line Installation</b>	<b>37</b>
<b>Brake Bleeding Procedure</b>	<b>37</b>
<b>Shock Spring Preloader Installation</b>	<b>38</b>
<b>Suspension Setup</b>	<b>39</b>
<b>Exhaust Installation</b>	<b>41</b>
<b>Reverse Light Module Installation</b>	<b>43</b>
<b>Body Installation</b>	<b>46</b>
<b>Top Trunk Installation</b>	<b>47</b>
<b>Trike Body Alignment</b>	<b>48</b>
<b>Securing of the Trike Body</b>	<b>52</b>
<b>Wiring the Trike</b>	<b>53</b>
<b>Final Reassembly of the Motorcycle</b>	<b>54</b>
<b>Wiring Schematics</b>	<b>55-56</b>

## Warnings and considerations:

1. **Disclaimer** - These instructions assume a level of understanding of motorcycle repair and maintenance beyond that of a “beginner” and/or “novice” and California Sidecar cannot be liable for an installer’s failure to understand or follow these instructions as written. Likewise, California Sidecar cannot be responsible if any of the steps are omitted or shortcuts are taken, or parts other than those supplied by California Sidecar, are used in installing this trike kit.
2. **“WARNINGS”** are all printed in bold type and capitalized. They mean to use extreme care in a given step so as not to damage the part, motorcycle, and/or yourself.
3. **Always** wear safety glasses when using hand and/or power tools.
4. When working in and around the fuel system, **always** work in a well-ventilated area, free from sparks and open flames.
5. All directional references to the “right side” and the “left side” are as you were seated on the motorcycle.
6. All directional references to “forward” mean to the front of the motorcycle while “back” means the rear of the motorcycle unless otherwise stated.

## **Recommended Lubricants:**

- 1. 80W-90 GL5 petroleum only, no synthetics.**
- 2. Fluorinated grease for splines**
- 3. Thread locking compound (Loctite 242 minimum).**
- 4. High temperature Silicone sealant.**

## **Torque values of fasteners:**

- 1. 3/8-16 Fasteners 35 FT-LBS**
- 2. 1/2-20 x 3 HHCS shock 45 FT-LBS**

**HHCS = Hex Head Cap Screw**

**SHCS = Socket Head Cap Screw**

**BHSCS = Button Head Socket Cap Screw**

**FHSCS = Flat Head Socket Cap Screw**

## Disassembly of Motorcycle:

### Gold Wing & Gold Wing Tour Models:



1. Place the motorcycle on the center stand.
2. Gold Wing models use a flat jack under the center stand area.
3. Set the shock preload to zero.
4. Remove both Fog Light covers.
5. Remove both Engine Covers
6. Secure bike to lift as shown, 1 on the center stand **RED STRAP** and 1 on each front crash bar **BLUE STRAP**.



- 7. Remove side panels and 2 Round Grommets.**
- 8. Remove 2 SHCS from the seat then remove seat.**



- 9. Remove 1 SHCS and 1 HHCS and 2 push pins on each side for the foot rest under covers.**
- 10. Remove four HHCS and the passenger floorboards.**
- 11. Remove six BHSCS and the swing arm pivot bolt covers.**



- 12. Remove the Side Stand Switch.**
- 13. Remove the Side Stand.**
- 14. Unplug the Side Stand Switch from underneath.**
- 15. Cut the wire 3 inches from the plug, strip the wires and solder them together, heat shrink and plug it back into the bike.**
- 16. Remove both rear crash bar covers.**
- 17. Remove and Save the upper SHCS and both Exhaust heat shields.**
- 18. Remove and Save the Rubber Protectors from the mufflers 1 on each side.**
- 19. Remove the 4 bolts from the passenger seat handles, release the helmet holder cable, Remove and Save the spring from the cable.**

**Gold Wing Models skip ahead to page 12:**

**Gold Wing Tour Models go to the next page:**





### **2018 – 2020 Models:**

- 20. Remove 6 long screws, 2 short screws from the side and 1 plug from the Passenger Back rest pad.**
- 21. Remove 2 screws from the black Tour box front cover.**



- 22. Remove 3 push clips and 5 screws from each tour box side.**
- 23. Remove tour box side panel by pulling out on the rear of the panel, then pushing it forward.**
- 24. Remove 4 screws and 1 plug and the rear cover.**

## **2021 & Newer Models**

- 25. Remove the 3 upper screws, front push clip and 3 lower push clips on floor of tour box for each inside panel.**
- 26. Remove side panels by pulling the panel straight rearward.**
- 27. Remove the 2 screws and 1 plug and the rear panel.**



## **All Models**

- 28. Remove the 4 screws and the right saddlebag latch assembly.**
- 29. Now remove the AM/FM antenna and the Tour Box release cable from saddle bag.**
- 30. Unplug the Tour Box wiring 2 plugs.**
- 31. Remove 4 bolts and the Tour Box.**
- 32. Remove the key cover.**
- 33. Remove the rear fender 2 SHCS and 1 plug.**
- 34. Remove the center lock holder 2 push pins and 2 SHCS.**
- 35. Remove the 4 screws and the left saddlebag latch assembly.**
- 36. Remove the BT and GPS antennas, the saddlebag release cable and USB connector (if equipped) from right saddlebag.**
- 37. Disconnect the Battery Negative cable.**



**38. Remove Saddlebags, 3 SHCS inside, 1 HHCS outside, a wire plug on top of fender and 2 plugs once pulled away from the stay.**

**Gold Wing Tour Models skip ahead to page 15:**

**Gold Wing Models continue on next page:**

## Gold Wing Models only:



After performing steps 1 - 18 from above the bike will appear as it is below.





- 39. Remove the Cap, the key cover, 2 bolts and 2 pins.**
- 40. Remove the Cap mount 4 bolts and spacers.**
- 41. Remove the 4 screws and the right saddlebag latch assembly.**
- 42. Remove the AM/FM antenna.**
- 43. Remove the 4 screws and the left saddlebag latch assembly.**
- 44. Remove the BT and GPS antennas also the right saddlebag release cable.**
- 45. Remove 2 Clips and 2 SHCS and the rear fender.**
- 46. Remove the center cowl cover**
- 47. Remove 2 Clips and 2 SHCS and the center cowl.**



**48. Remove Saddlebags, 3 SHCS inside, 1 HHCS outside, a wire plug on top of fender and 2 plugs once pulled away from the stay.**

## **Gold Wing & Gold Wing Tour Models:**

**49. Once the Saddlebags are removed, Verify that you have removed the BT, GPS and AM/FM antennas also the Heated seat controller and both Saddlebag Switch Covers for reinstallation.**



- 50. Remove and discard mufflers.**
- 51. Unplug radio; remove rear wheel, crash bars and saddlebag stay.**
- 52. SAVE the 2 longer rear crash guard bolts.**
- 53. Remove Radio from the stay and save all hardware and spacers for reinstallation.**
- 54. Remove the AM/FM Antenna ground wire.**
- 55. Remove caliper and ABS sensor along with all attaching bolts and clamps from the brake line and ABS sensor wire. Save the ABS sensor bolt.**
- 56. Remove the DCT park brake caliper if equipped.**

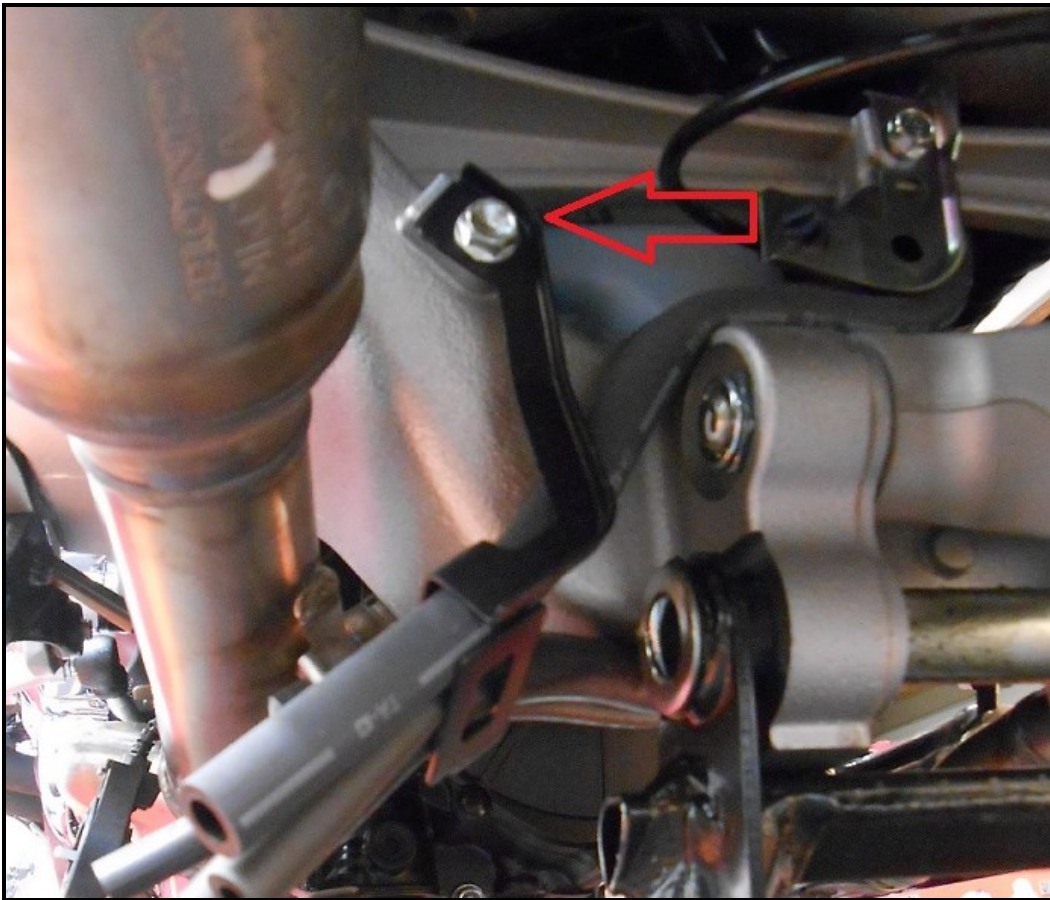

57. Remove and Save the hose holder and bolt **RED ARROW** for shock bolt access.

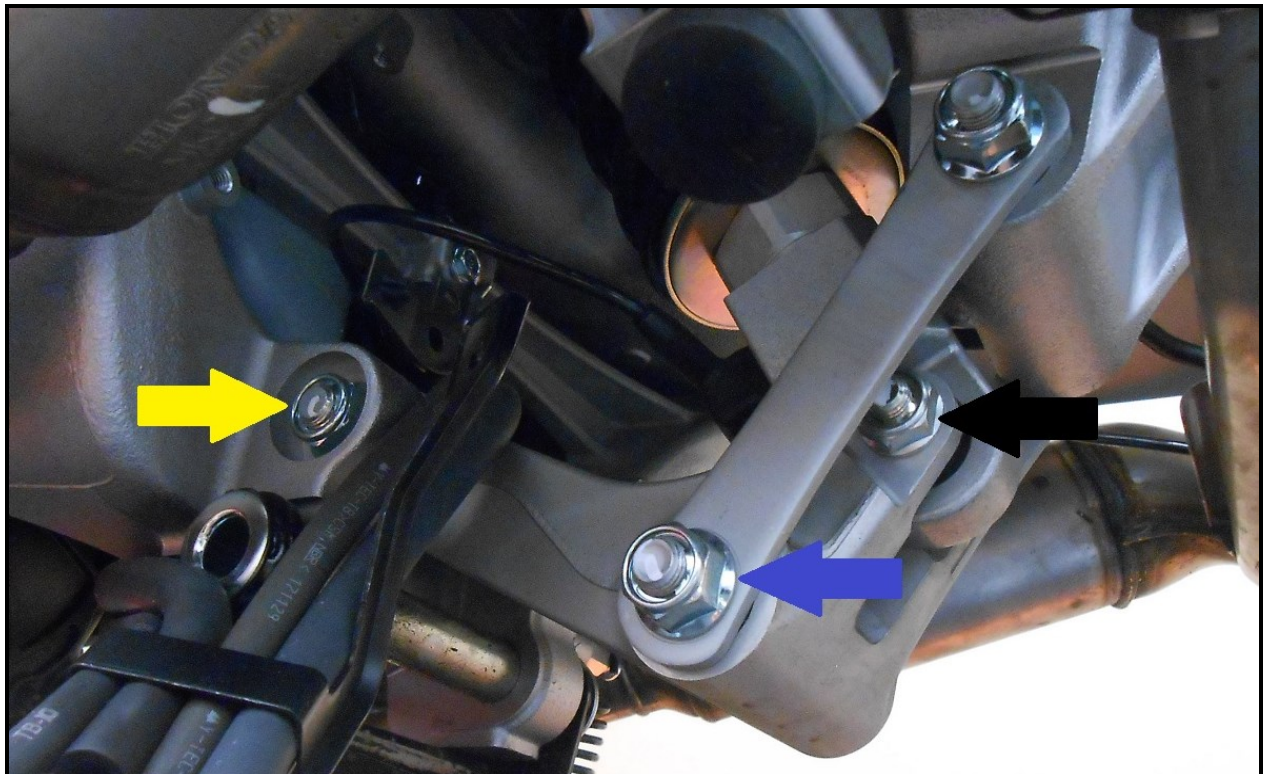



58. Remove the lower linkage arm bolt **BLUE ARROW**.
59. Remove the lower shock bolt **BLACK ARROW**.
60. Remove the forward linkage arm bolt and nut. Saving for reinstalling. **YELLOW ARROW**.
61. Unplug the shock wire.

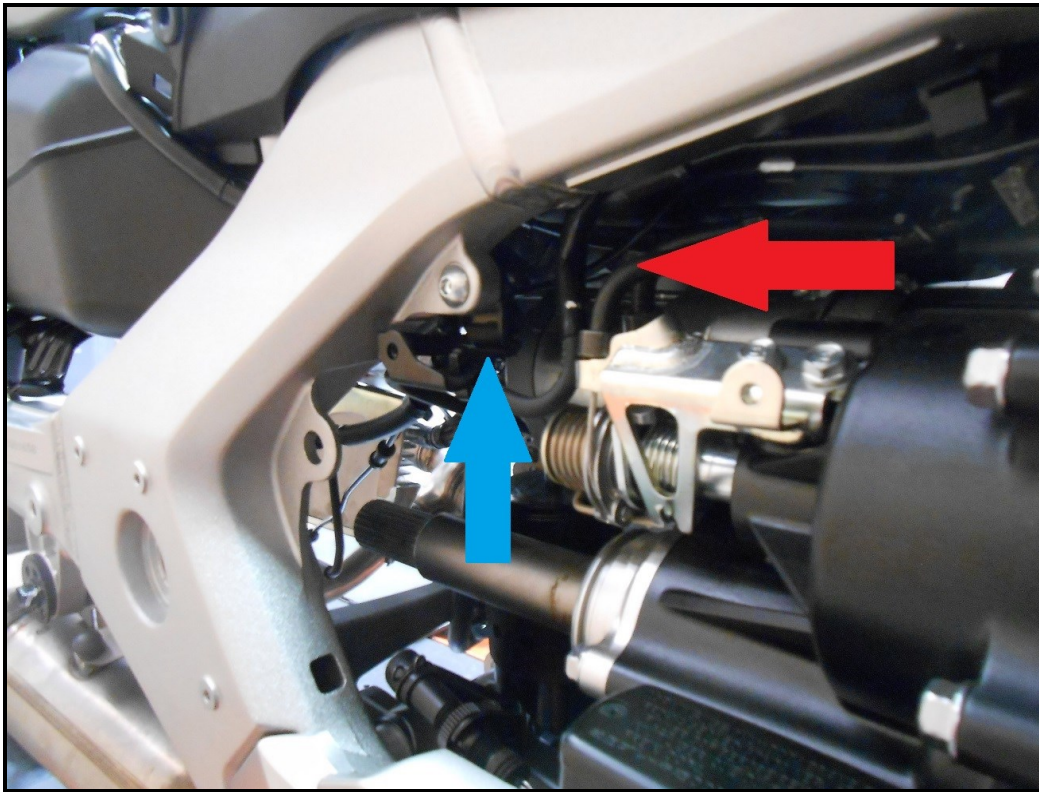

62. Remove the Right engine cover 2 SHCS.
63. Remove the upper shock mount bolt. **RED ARROW**
64. Remove the fuel tank right rear mount bolt and plastic bracket, then pry up on the tank to remove the upper shock mount from the frame. It will pull out rearward.
65. Remove the fuel tank mount bolt in order to reroute the preloader line.
66. Reinstall both fuel tank bolts.
67. Rear brake Line removal. **BLUE ARROW**
68. Break the line loose, remove the HHCS from the block, last remove the SHCS from the mount.
69. Unthread the line and leave it with the swingarm.
70. **DO NOT LOOSEN** the preloader line for any reason.
71. **Make sure the Battery is Disconnected.**
72. Remove the upper shock clevis.
73. Cut the spring with your cutoff wheel.
74. Loosen the 2MM set screw then slide the preloader down in order to remove the retaining ring from the shock body.

**75. Slide the preloader off of the shock. Discard the shock, spring, rubber boot and the white plastic spring seat.**

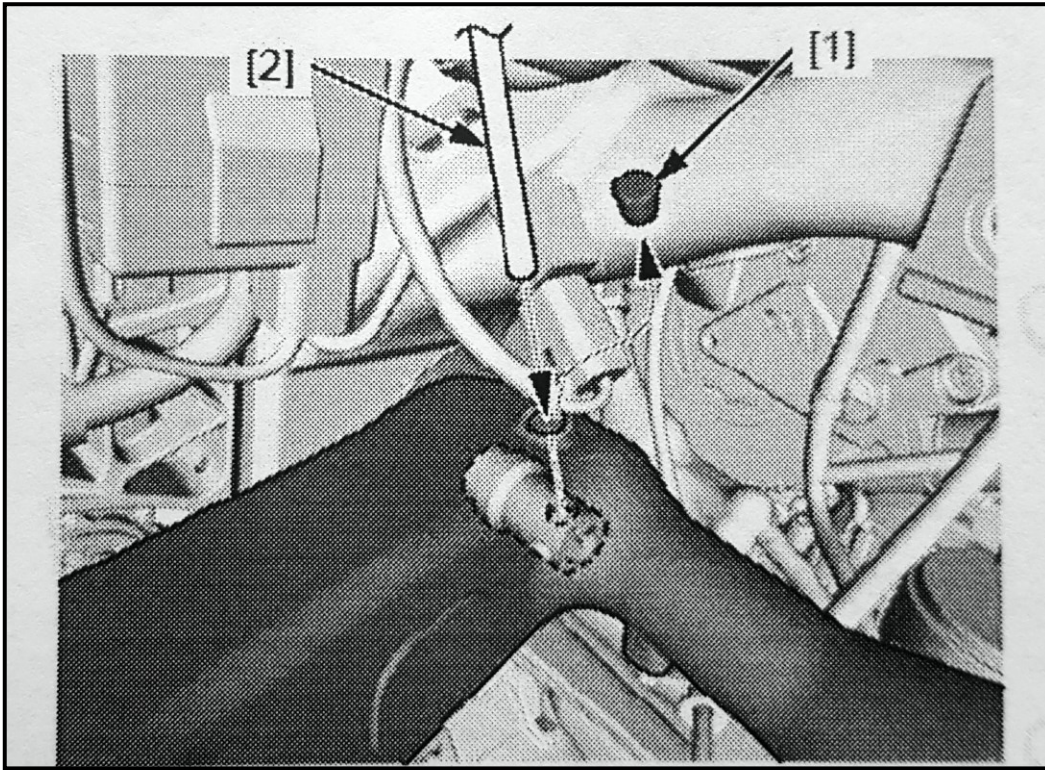

**(Image from  
2018 Honda  
Service Manual)**

**76. Remove the rubber plug [1], then insert a muffer bolt as [2],**

**77. Loosen and remove the left pivot bolt**

**78. Remove right pivot bolt.**

**DCT model skip to step 80. Manual shift continue below.**

**79. Remove the battery, battery box and the reverse resistor.**

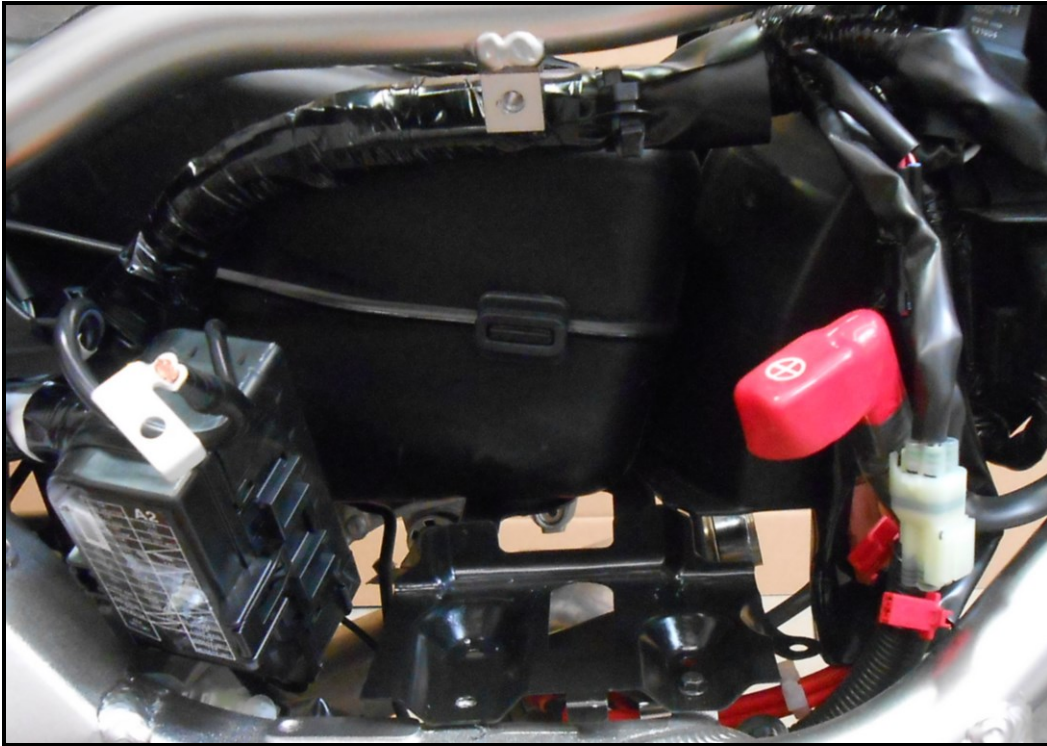

**80. Remove both the mount and the shield saving the HHCS.**



- 81. Remove Swing arm, Drive shaft and Differential as an assembly.**
- 82. Save the Driveshaft Boot.**
- 83. Pulling Swing arm rearward route the ABS Sensor, Perloader line up through the Swing arm.**



**Before**



**After**

**84. Remove the key fob receiver and route the harness forward as shown.**

## Modification of Motorcycle Frame:

Skip to step 3 if installing the Auxiliary Fuel Tank.

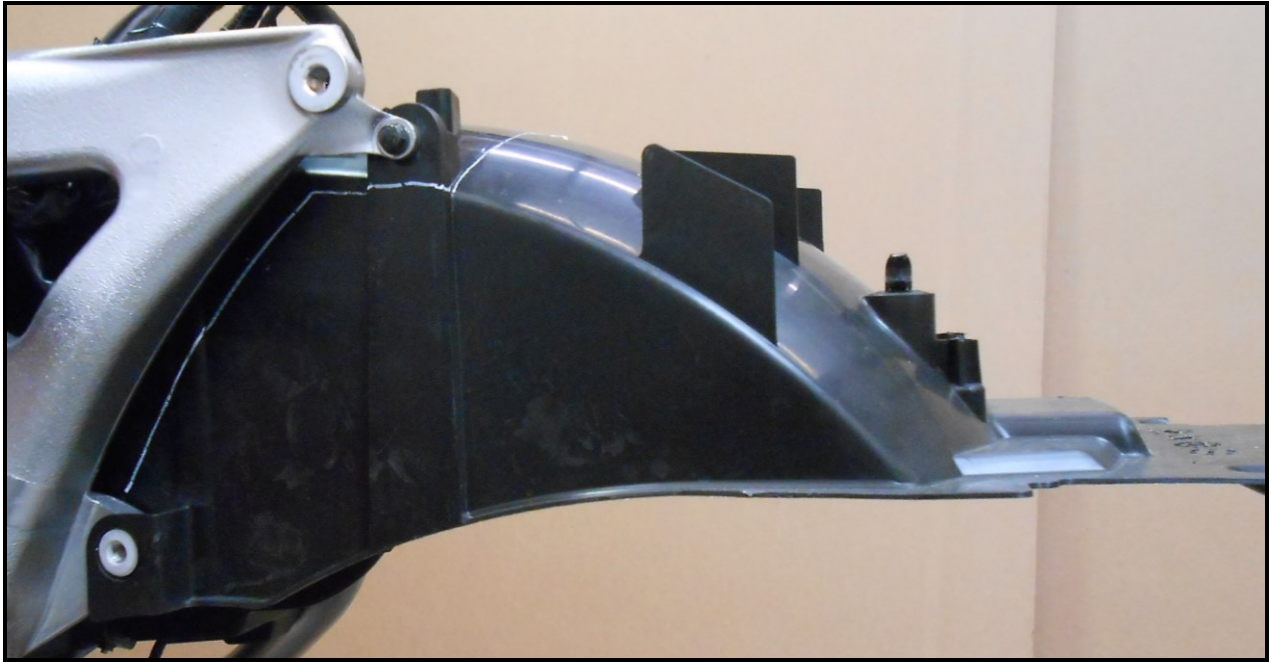

1. Mark inner fender as shown.

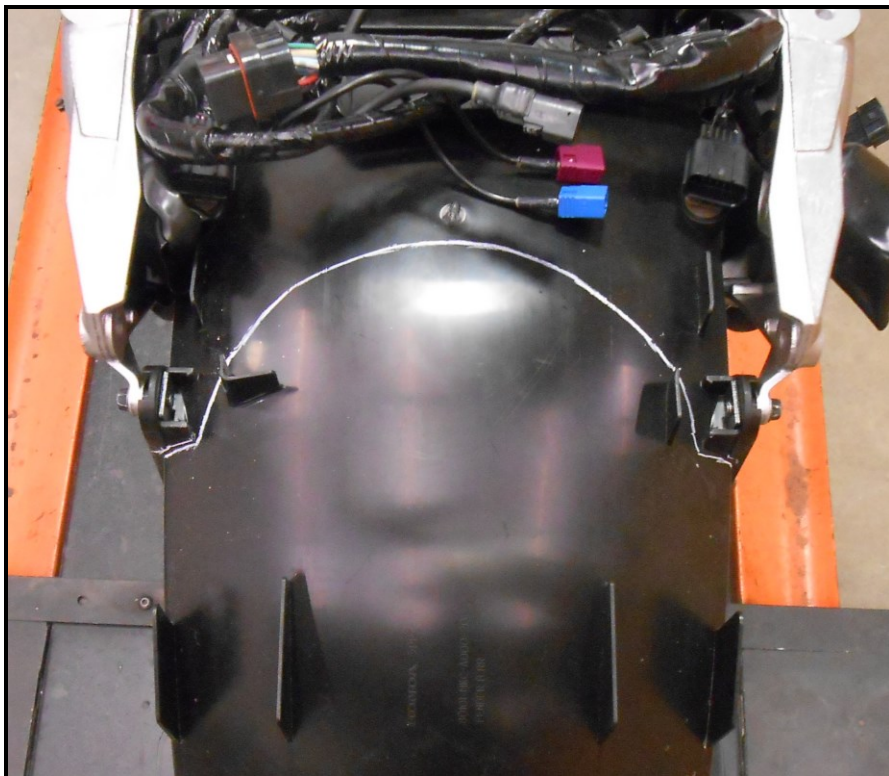

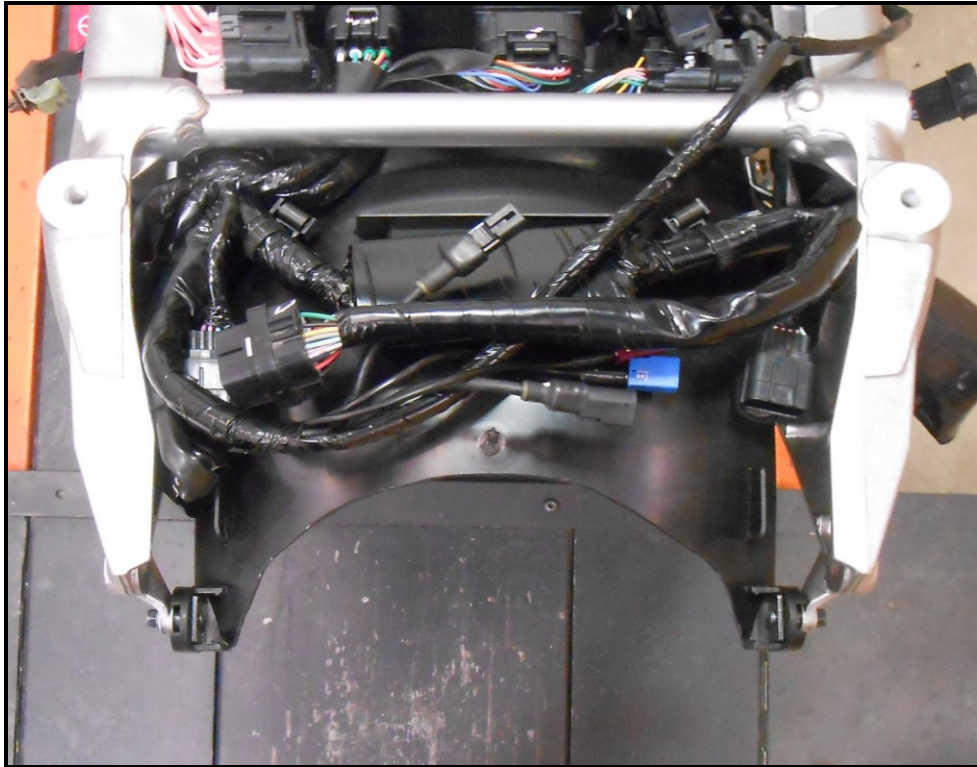

2. Cut inner rear fender as shown.

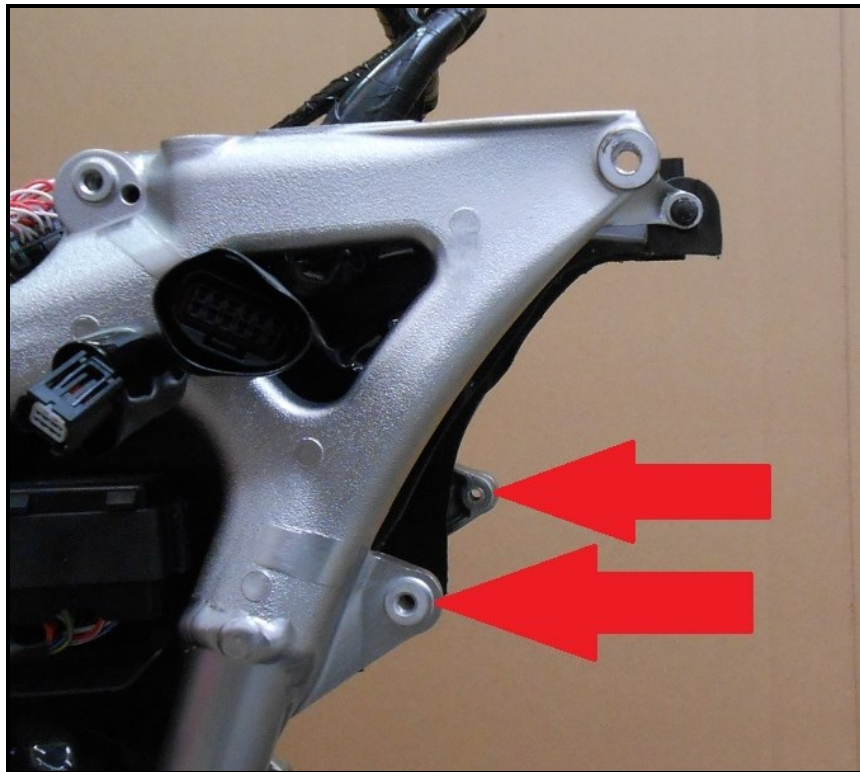

3. Drill out threaded holes marked with **RED ARROWS** 21/64.



**\*Kits with Auxiliary Fuel Tanks, begin installation here before beginning reassembly. Refer to separate instructions provided.**

## **Frame Mount Installation:**

1. Install new CSC rear Brake Line. Secure line and ABS Sensor wire to its mount with a zip tie.
2. Install the Right side CSC Pivot bolt. Torque 80 FT-LBS.
3. Install the OEM Driveshaft boot on the Right Frame Mount.
4. Position the Right Frame Mount over the CSC Pivot bolt.
5. Install the 3/8 X 1 1/2 SHCS through the Pivot bolt and thread it into the Frame Mount. Use thread locking agent but leave loose.
6. Cut the 2 zip ties that hold the cable to the bottom of the battery box, remove the clips in order to install the Left Frame Mount.

## **Manual Transmission Models Only:**

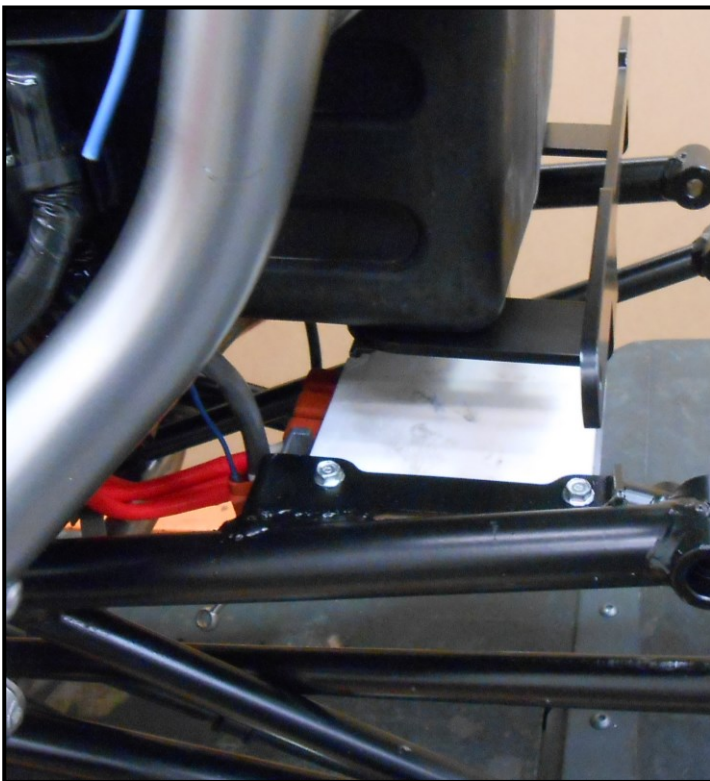

7. Install the Reverse Resistor onto the Left Frame Mount reusing 2 OEM HHCS, with the wires forward.
8. Install the **BLUE** wire with eyelet onto the stud of the Reverse Resistor.
9. Route the **BLUE** wire straight up onto the top of the rear fender area.

## **ALL Models:**

- 10.** Insert the Left Pivot bolt through the frame and thread it into the Left Frame Mount. Use thread locking agent but leave loose.
- 11.** Make sure that the wire harness is between the Motorcycle Frame and the CSC Left Frame Mount.
- 12.** Install the V-Mount into the forward linkage arm position reusing the OEM bolt and nut. Leave loose.
- 13.** Leave the Perloader Line and CSC Brake Line to the outside of the Right frame.
- 14.** Route the ABS Sensor wire and DCT Park Brake cable on the inside of the Left Frame Mount. Brake Line to the outside of the Right Frame Mount.
- 15.** Arrows represent Zip ties. 2 up front are only on the ABS wire, 2 on the Frame Mount are holding the OEM wire harness, DCT Cable and the ABS wire.



**16. Install the Driveshaft after you grease the splines.**

**DCT Park Brake Caliper if equipped:**

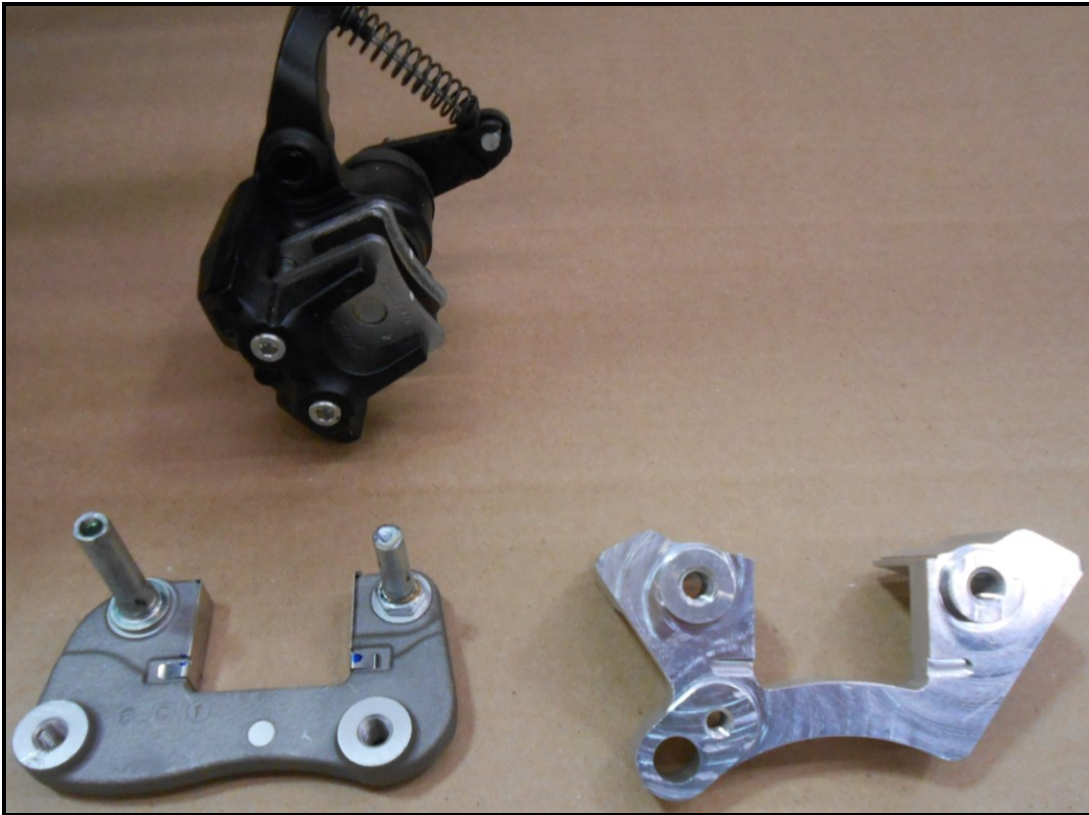

**1. Remove the OEM caliper mount from the caliper, it just slides off.**



2. Remove the slide pins and the brake pad retainers.

**Note which one goes where.**

3. Install the slide pins and retainers onto the CSC Park Brake Caliper Mount.

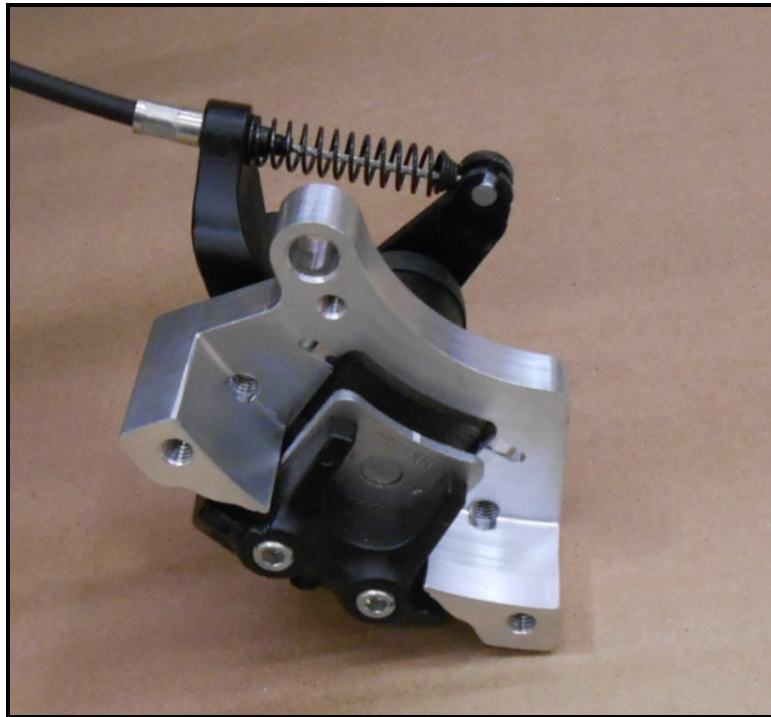

**4. Slide OEM caliper onto the CSC Park Brake Caliper Mount.**



**5. Shown with ABS Sensor installed. Not necessary at this time.**

## Rear Suspension Unit Installation:

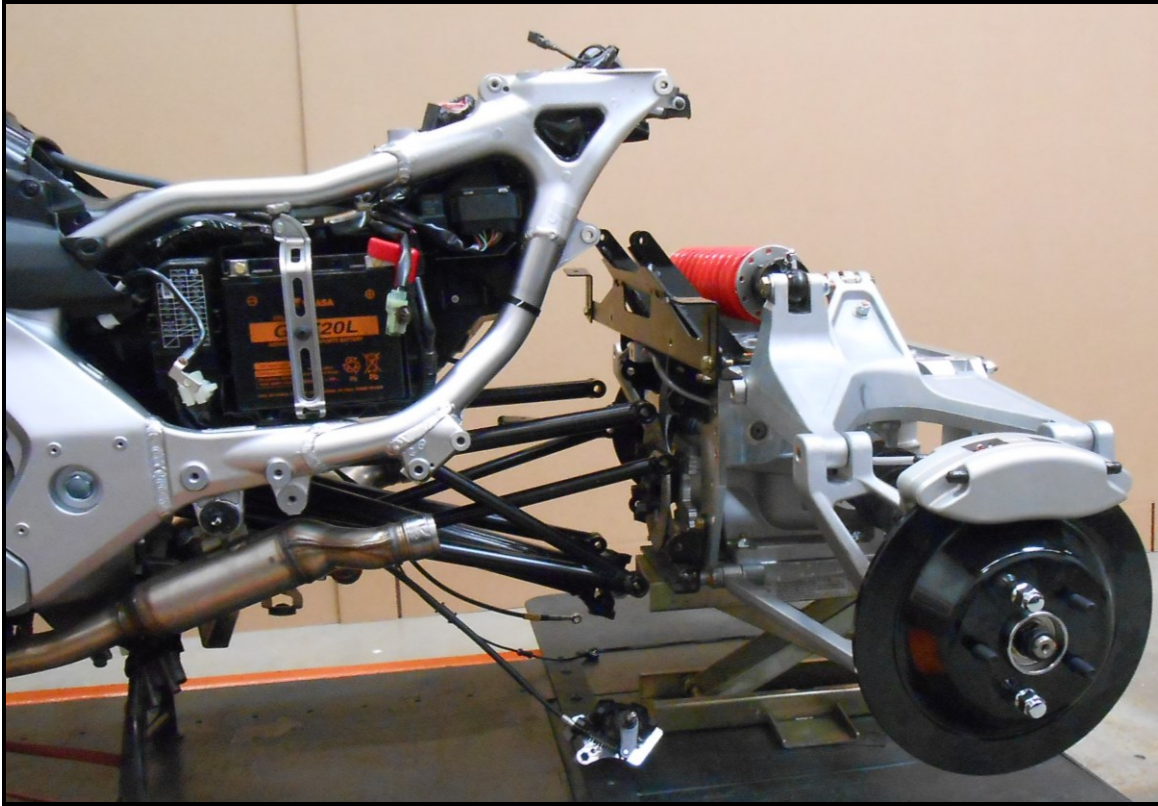

- 1. Position trike kit behind prepared motorcycle.**
- 2. If auxiliary tank is installed, install brake line now. Refer to Brake Line Installation.**
- 3. Raise Suspension to align the Intermediate Mount and the drilled frame tabs.**
- 4. Slide rear suspension unit forward and install two 5/16 X 1 1/2 HHCS with flat washers through the Intermediate Mount and the Motorcycle frame tab. Install flat washers and nyloc nuts, leave loose.**

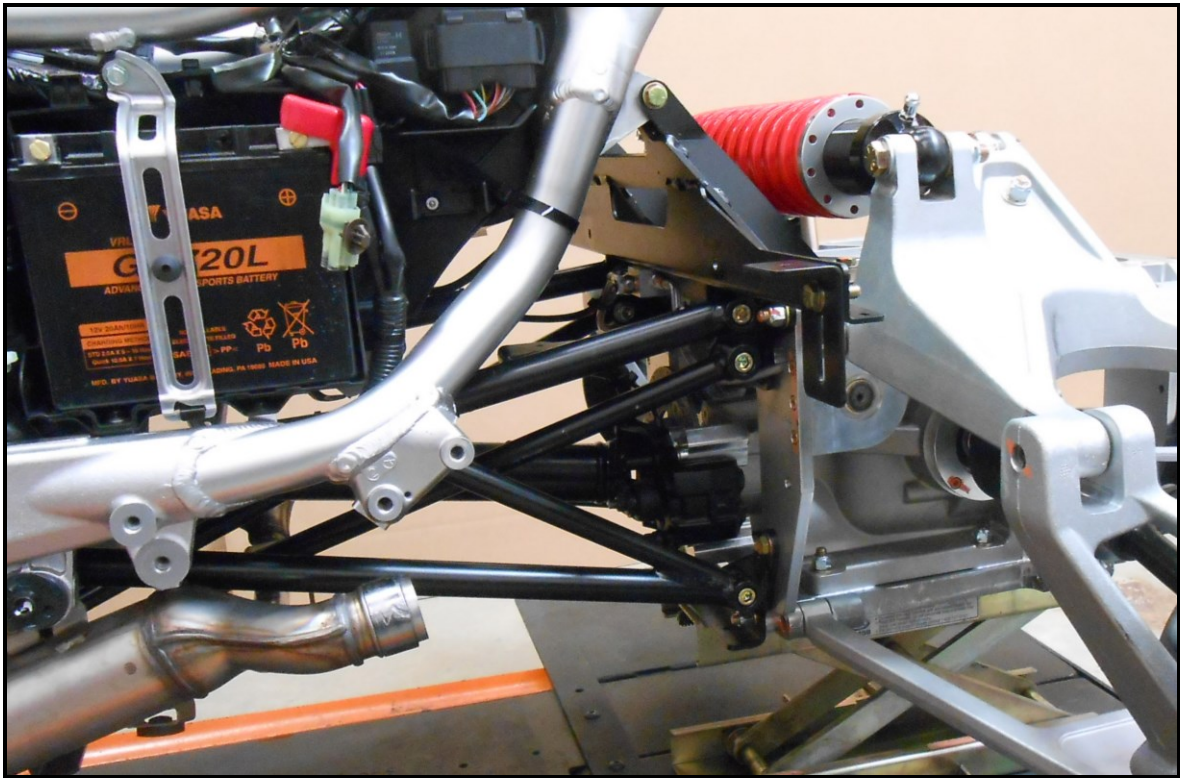

5. Install two 3/8 X 1 3/4 SHCS into the Lower holes of the Left and Right Frame Mounts.
6. Next install two more SHCS into the V Mount holes.
7. Now install the last two SHCS into the Upper holes in the Left and Right Frame Mounts.
8. Use flat washers and nyloc nuts on all 6 SHCS.

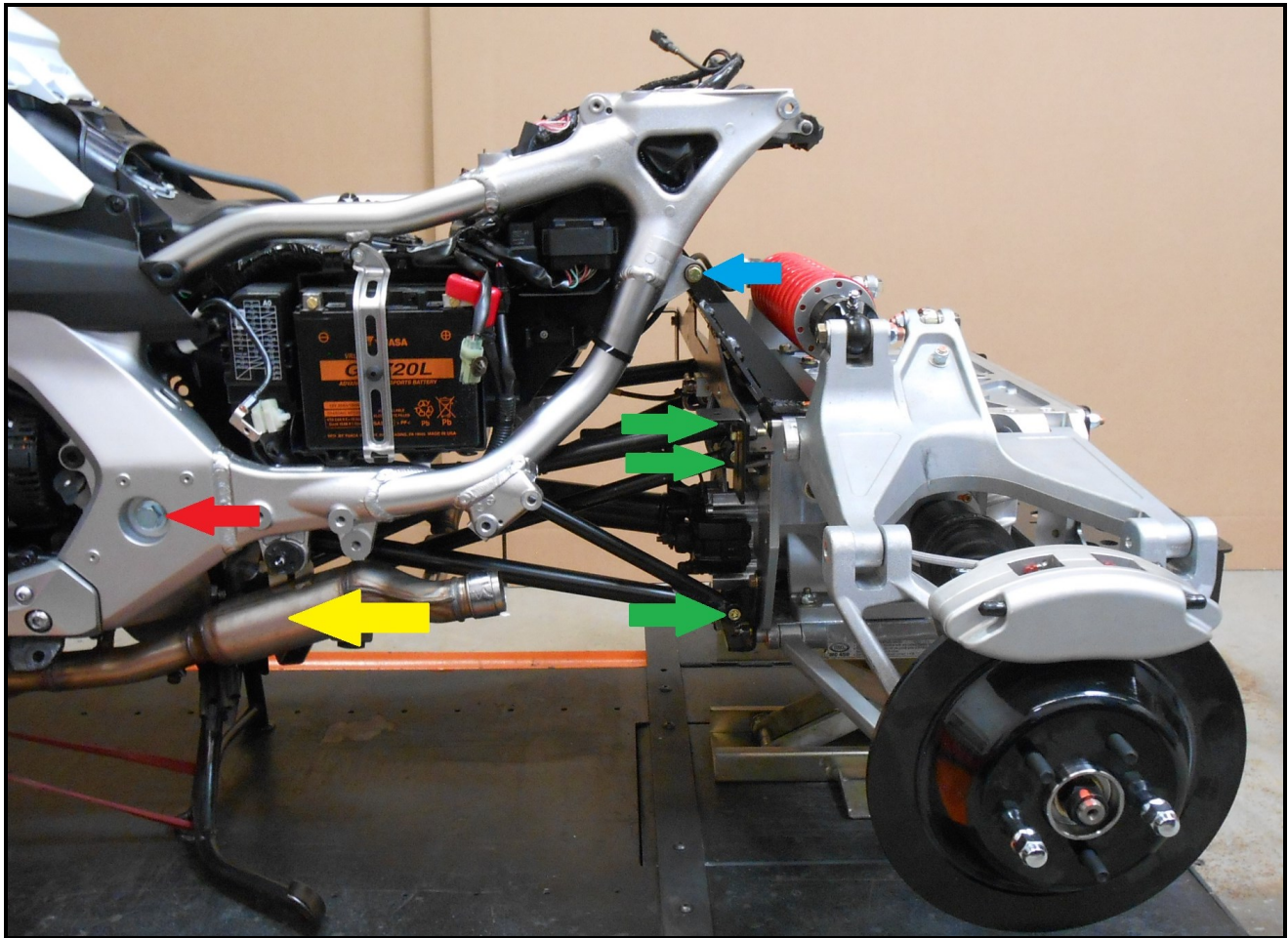

9. Tighten fasteners in this order.

- a. **RED** Left bolt Pivot 80 FT.LBS. Right SHCS 20 FT.LBS.
- b. **BLUE** Intermediate Mount HHCS 18 FT.LBS.
- c. **GREEN** Frame Mount SHCS 30 FT.LBS.
- d. **YELLOW** OEM Linkage Arm SHCS.
- e. Remove the Center Stand at this time.
- f. If installing GFX, preform steps 1-5 of the GFX instructions.
- g. Reinstall the Hose Holder and OEM Bolt. **YELLOW ARROW** area.



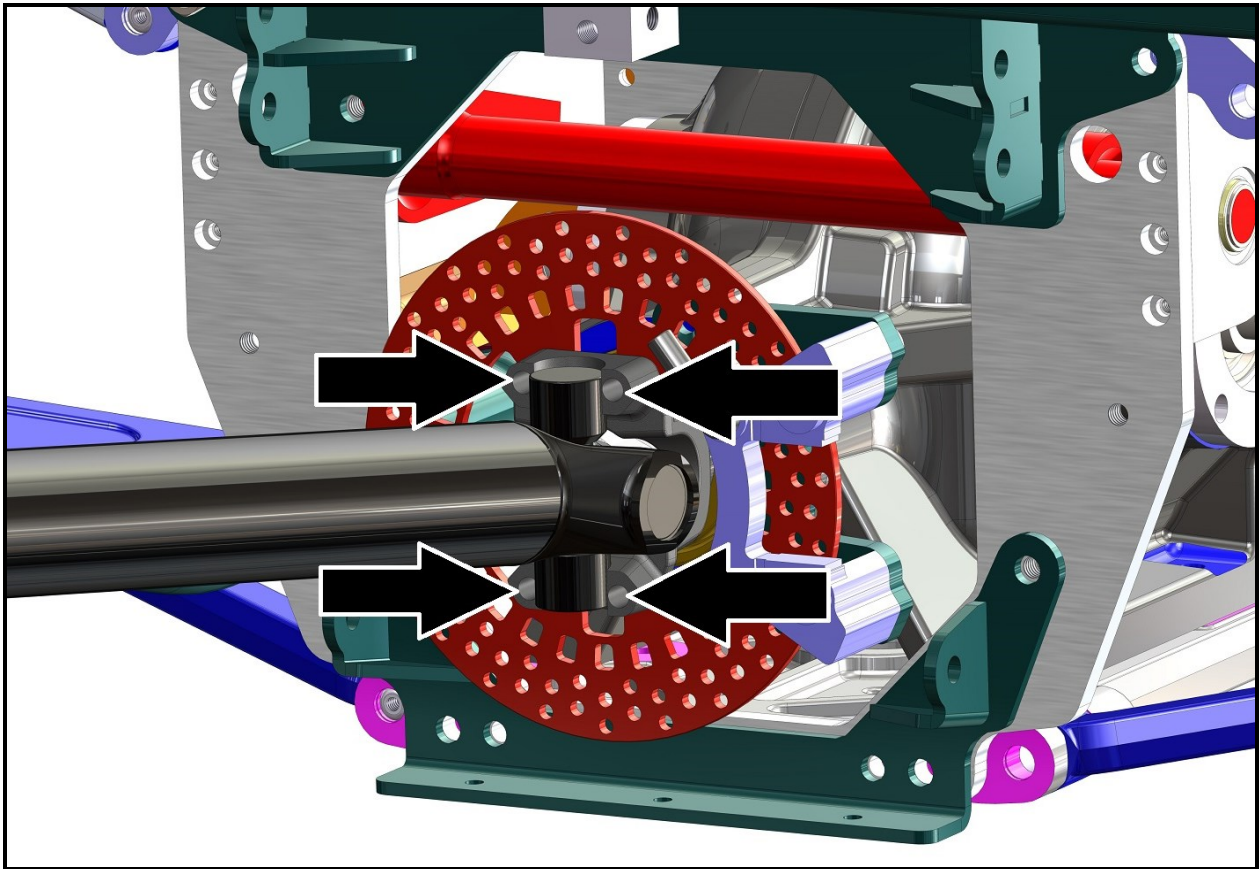

Park Brake Rotor / ABS sensor wheel shown in **RED**

10. Align Drive Shaft into the rear yoke.
11. Install the U-bolts going through the yoke then into the rotor and secure with provided lock washers and nuts. **BLACK ARROWS.**
12. Loosen the four 3/8 HHCS from underneath the lower tray that secure the differential.
13. Slide the rear differential and driveshaft assembly all the way forward onto the transmission output shaft.  
**DO NOT FORCE IT FORWARD.**
14. Confirm that the driveshaft is forward and fully seated on the transmission output shaft.
15. Tighten the four 3/8 HHCS and nyloc nuts that secure the differential to the lower suspension tray.
16. Check that the differential is full with **exactly one quart** of specified gear oil. See Maintenance Schedule, p. 5. **DO NOT OVERFILL.**

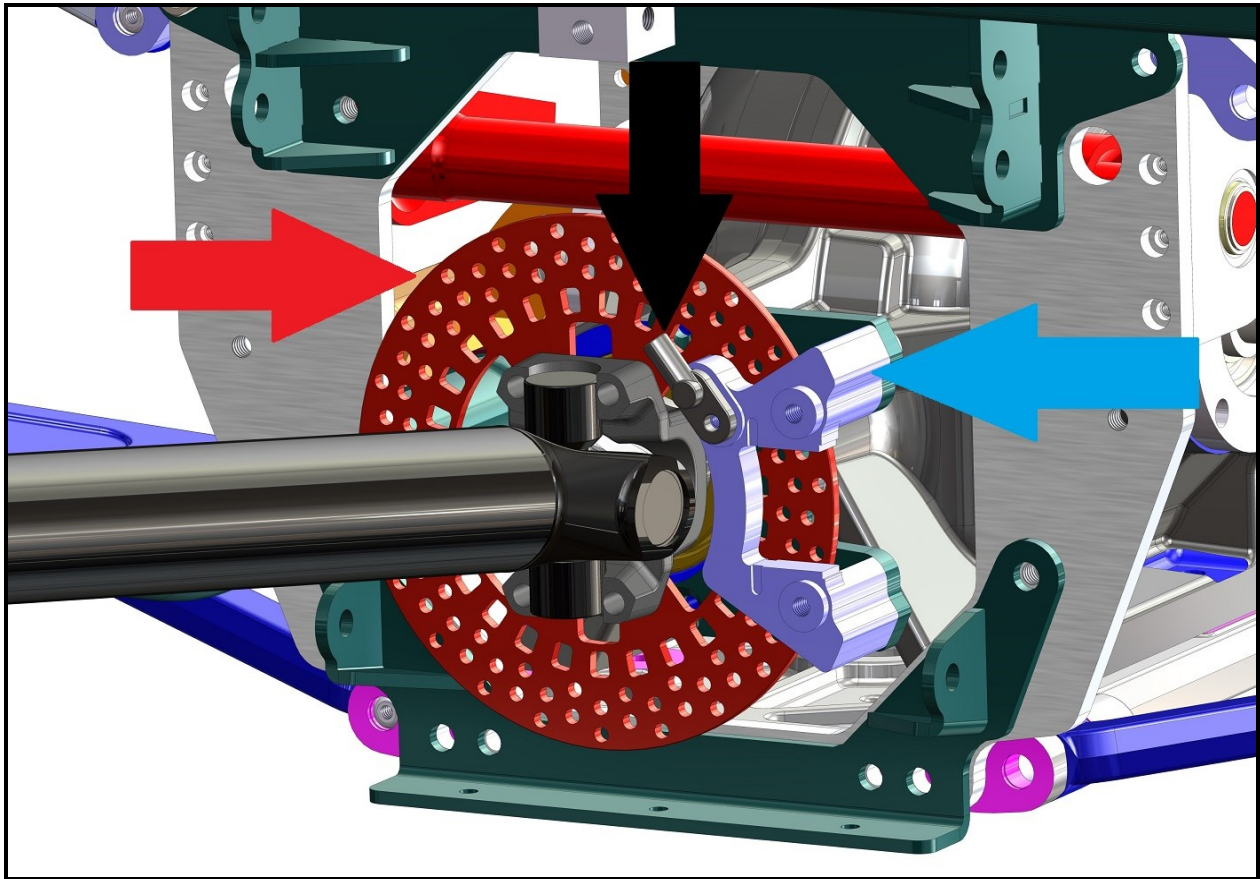

## **A.B.S. Sensor Installation & Park Brake Caliper Adjustment:**

1. Install the rear wheel speed sensor to the ABS sensor mount on the differential reusing the OEM bolt. **BLACK ARROW**.
2. Measure the AIR GAP for the ABS Sensor. 1.0 MM or 0.04 inches **RED ARROW** Rotor to **BLACK ARROW** ABS Sensor.

### **DCT models and Manual Models with optional DCT Park Brake:**

3. Install the Park Brake Caliper to the mount with 2 HHCS and Flat Washers. Use Thread Locking Agent. **BLUE ARROW**.
4. Adjusting the Park Brake Caliper.
5. You want 3 to barely 4 clicks at the handle.
6. Loosen the jam nut and turn the center threaded shaft. Once adjusted tighten the jam nut.
7. Secure the ABS sensor wire to the DCT caliper cable and Frame Mount with zip ties.

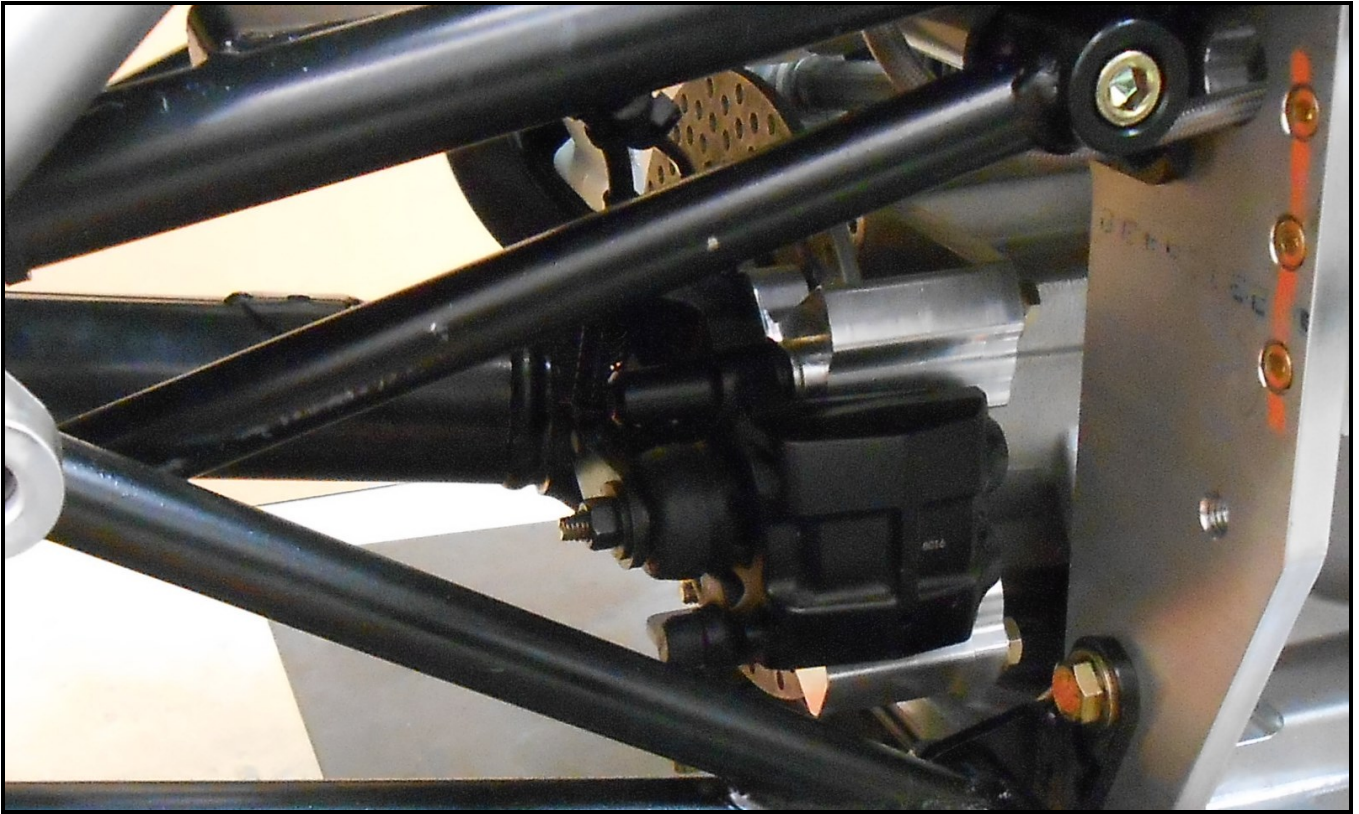

**Park Brake Caliper shown in place:**

## Gravel Pan Installation:

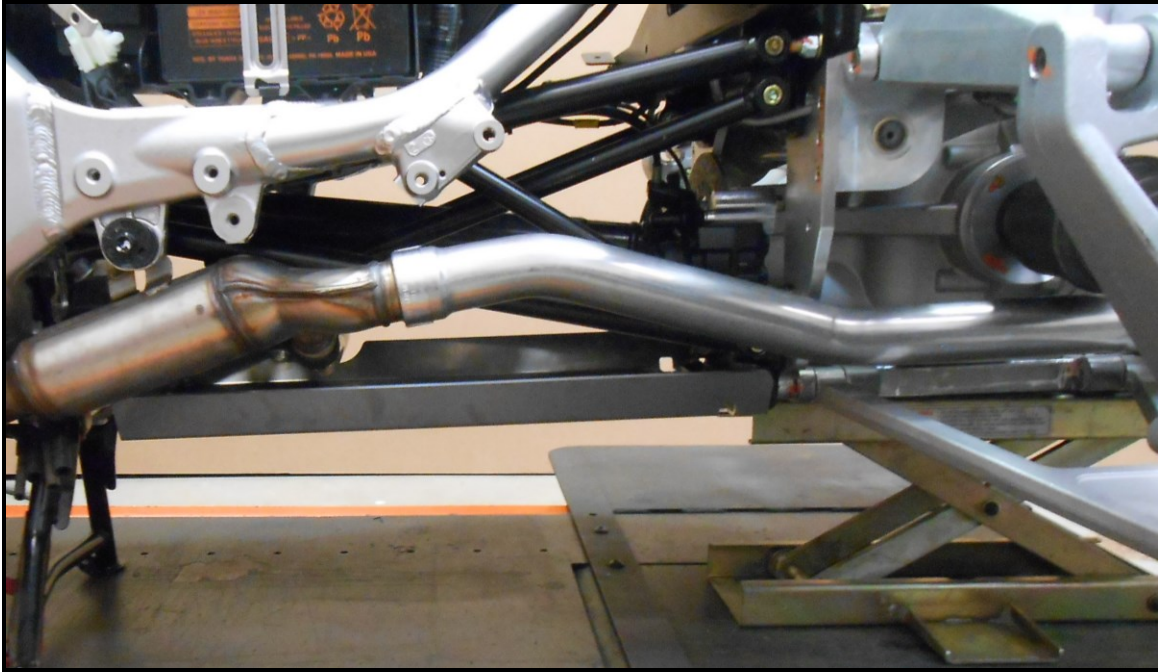

1. Install the Gravel Pan with slots to the front.
2. Insert 6 HHCS and flat washers up through the Gravel Pan and secure with 6 Nyloc Nuts.

## Brake Line Installation:

1. Install the new CSC brake line onto the distribution block, use new banjo bolt and crush washers provided.

## Brake Bleeding Procedure:

1. Fill reservoir with new DOT4 brake fluid.
2. Using a vacuum bleeder, be sure to **Thoroughly** flush the brake system of **all** old fluid while following this procedure **carefully**.

This is the same bleeding procedure that is in the Honda service manual for the 2018 GL1800 Goldwing.

- a. Prebleed the rear calipers first. Vacuum bleed all 4 bleeders on both calipers until fluid appears.
- b. Front Wheel: Left & Right front lower bleed valves.
- c. Rear caliper bleed valves outside first then inside on each side.



3. Allow the bike to set for a minimum of 20 minutes.
4. Hand bleed the system using steps b. and c. only until all air is removed from the lines.
5. Allow the bike to set again for a minimum of 20 minutes and recheck.
6. If there is excessive pedal travel on the first pump, repeat steps b. and c.

## Shock Spring Preloader Installation:

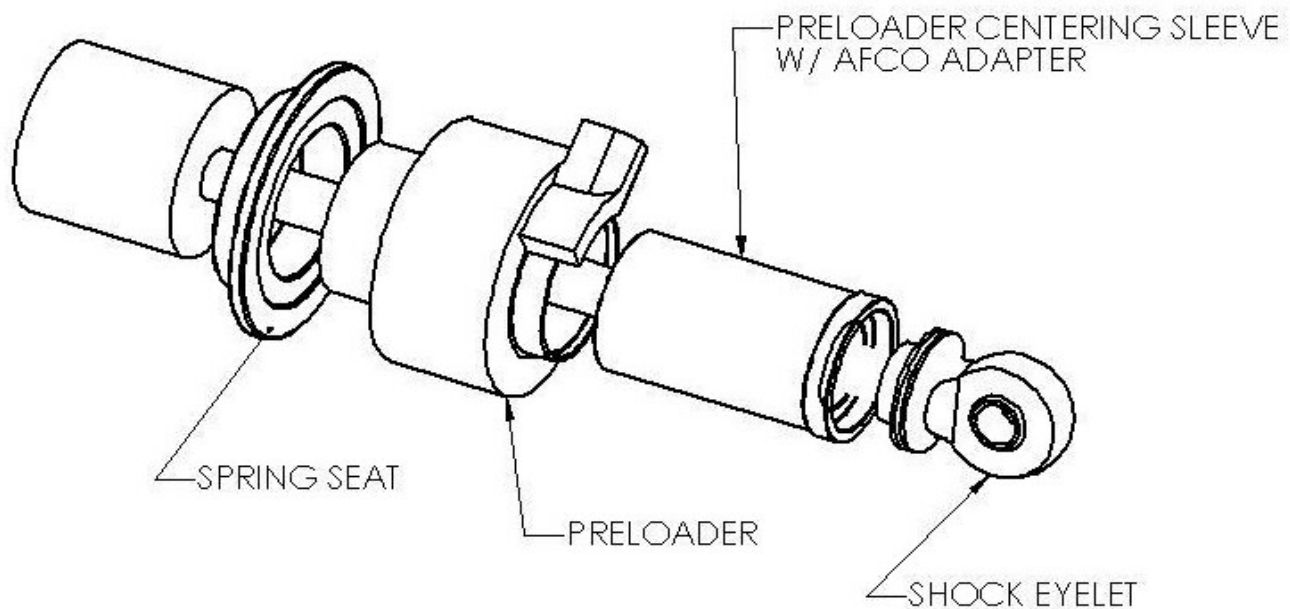

1. Loosen the jam nut on the shock shaft.
2. Remove the 1/2-20 x 3 HHCS, 1/2-20 nyloc nut, and 1/2 washel.
3. Remove the shock eyelet, jam nut, and shock preloader centering sleeve.
4. Install the preloader centering sleeve through the top of the preloader by leaving the flange on the preloader centering sleeve towards the top as it is slid in from the top.
5. Slide the assembled preloader and preloader centering sleeve onto the shock shaft with the top facing the right.
6. Ensure that the spring seat engages the preloader on the larger diameter.
7. **Reinstall the jam nut and shock eye using thread locking agent.** Be sure they are **FULLY** threaded on shock shaft.
8. Replace the 1/2-20 x 3 HHCS and 1/2 washer and a new 1/2-20 nyloc nut. Torque to specification.
9. **TIGHTEN the shock eye jam nut.**
10. Position the preloader banjo bolt towards the front on the trike kit.

## Suspension Setup:

Use this chart to select the correct spring preload. Rotate the adjuster nut on the shock until the spring is set to the desired length. Now tighten the set screw on the adjuster nut or tighten the lock nut on the fully adjustable shock.

**Load:** Typical weight the customer adds to the stock trike. This includes riders, luggage, and weight of a trailer tongue. When in doubt assume a higher weight than actual.

**Length:** Suggested length the spring should be adjusted to with the suspension completely unloaded and the preloader set to zero.

<b>ENCORE</b>								
<b>SHOCK with RED SPRING</b>								
	LOAD	LENGTH		LOAD	LENGTH		LOAD	LENGTH
<b>250 LB/IN SPRING</b>	100	13 1/16	<b>300 LB/IN SPRING</b>	100	13 1/4	<b>350 LB/IN SPRING</b>	100	13 7/16
	200	12 7/8		200	13 1/16		200	13 1/4
	300	12 5/8		300	12 7/8		300	13 1/8
	400	12 5/16		400	12 5/8		400	12 15/16
	500	12 1/8		500	12 7/16		500	12 3/4
			600	12 1/4		600	12 5/8	
						700	12 1/2	
						800	12 3/8	

1. Align the preloader so that the banjo bolt is pointing up.
2. Tighten the setscrew on the preloader against the preloader centering sleeve and on the spring locking nut.

These lengths are only estimates. If you would like to confirm a correct setting, load the completed trike to the customers typical riding situation and measure from the ground to the middle of the lower suspension plate. The center hole should be 5.75" – 6.25" from the ground.

**Attention:** This is the only suspension adjustment needed. All other settings are factory set and should not be tampered with. There is no need to remove trike from the lift to check camber, toe, or the drop links.

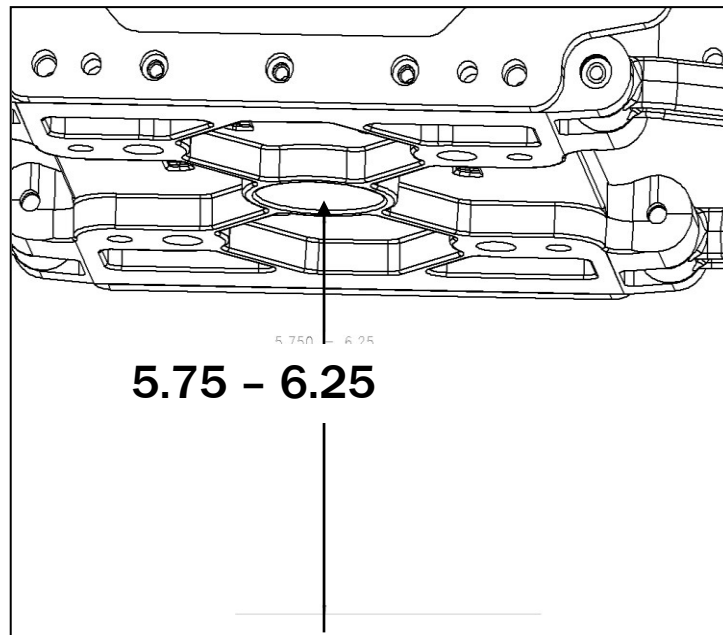



## Exhaust Installation:

1. Install NEW Honda exhaust Gaskets.

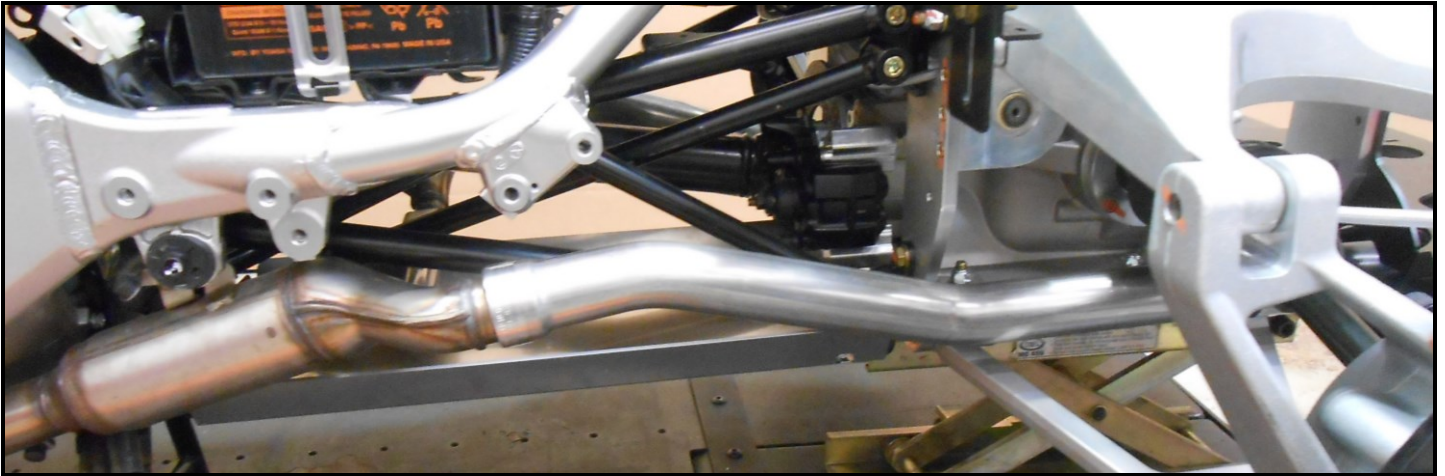

2. Install left and right tailpipes with supplied clamps 63's

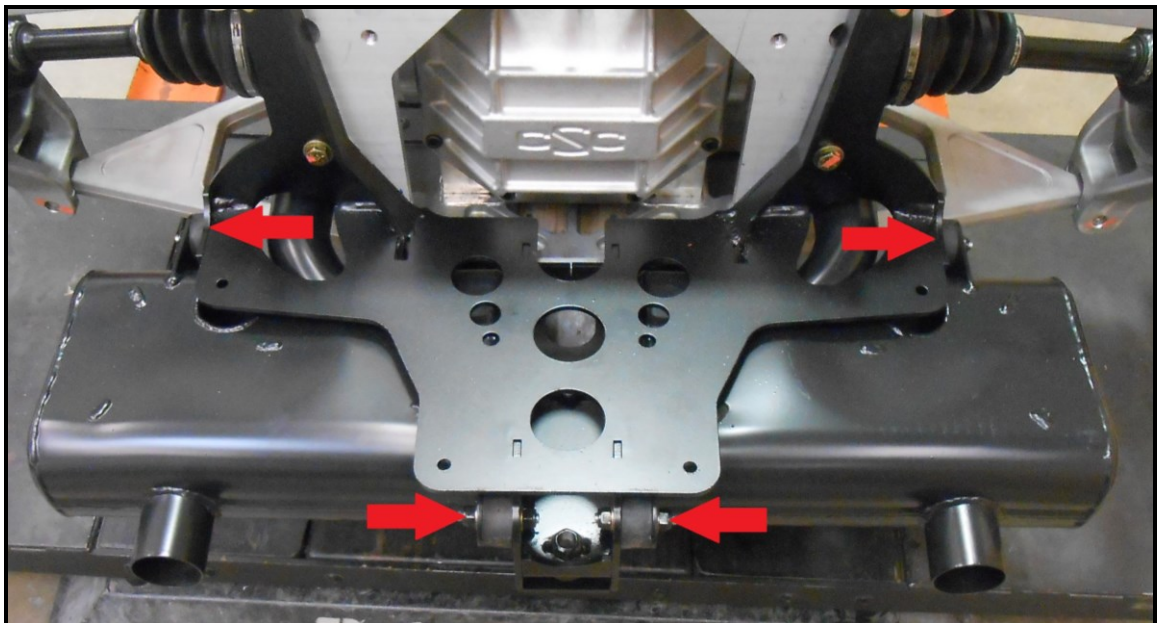

3. Install the 6 rubber sandwich mounts with flat washers and nyloc nuts to the Body Frame. Refer to **RED ARROWS**.
4. Install Mufflers as shown with nyloc nuts and flat washers and 2 more clamps 63's.
5. Tighten the 4 clamps and 12 Nyloc nuts.
6. Loosely install the Encore exhaust tips with 2 more clamps 63's.

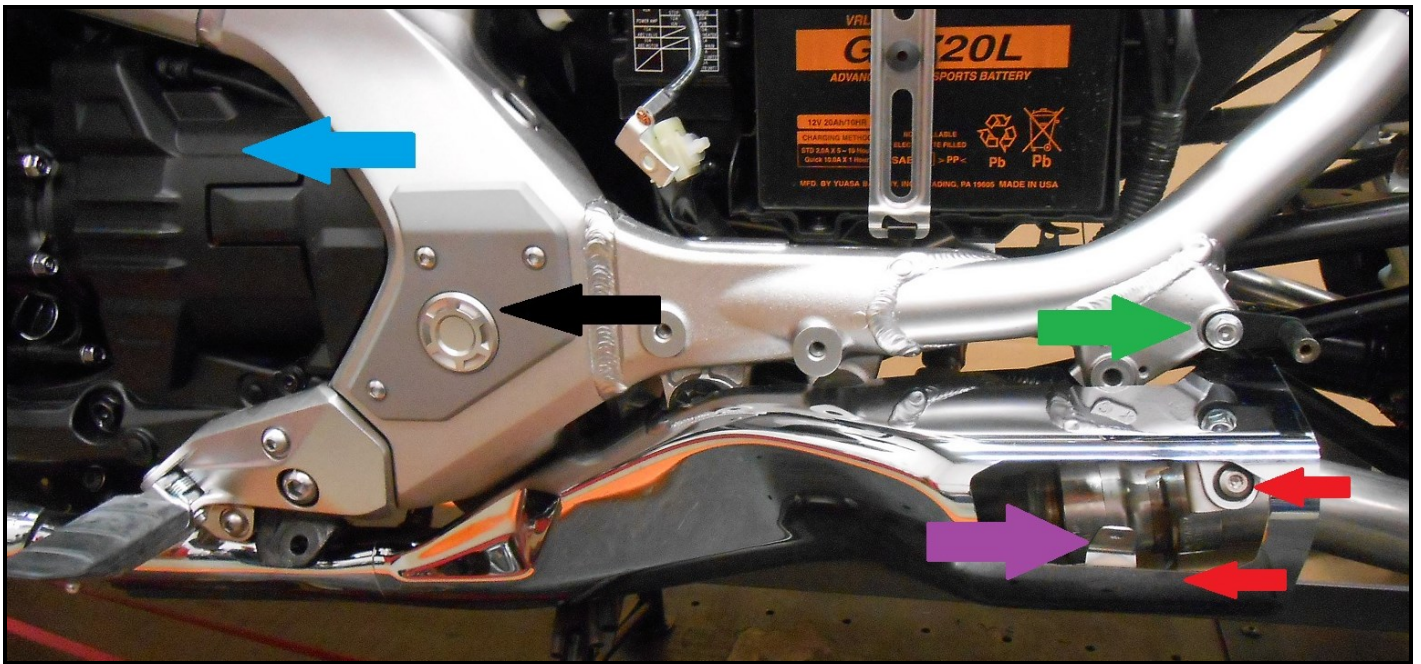

7. Install the OEM Heat Shields onto the front tabs.
8. Secure the CSC mount to the Heat Shield with 1 OEM Rubber Protector, OEM SHCS and CSC Nyloc nut. **RED ARROWS.**
9. Secure the mount to the tailpipe with 1 clamp 61.
10. Bend the unused tab up for body clearance. **PURPLE ARROW.**
11. Reinstall the L & R Pivot Bolt covers. **BLACK ARROW.**
12. Reinstall the L & R Engine covers. **BLUE ARROW.**
13. Install the CSC mounts for the Passenger Floorboard covers. **GREEN ARROW.** Reuse the Rear Crash Guard bolts saved and 2 CSC Nyloc nuts. Align the bracket so that it is straight back.

Here at CSC we pause on the trike installation, put on the rear wheels, then jack up the front and do the Power Trak. Once we have taken all OEM parts off for the Power Trak, we pause again and do the TPMS/DCT Module wiring and the DCT Reverse Light Module.

**See Separate Power Trak Instructions. All models.**

**See Separate TPMS/DCT Instructions. DCT transmission models only.**

**See Separate TPMS only Instructions. Manual Transmission models only.**

**Above instructions are located at [californiasidecar.com](http://californiasidecar.com)**

**Reverse Light Wiring DCT Transmission Models Only:  
Manual Transmission Models skip to page 47:**



1. Install the module just behind the OEM fuel tank on the Left side.
2. Locate the 2 pin plug from the body and connect it to the module.
3. Install the Ground eyelet with the AM/FM Antenna ground eyelet previously installed.
4. Connect the **BLUE** wire to the **BLUE** wire on the Adaptor harness.



5. Lift the shelter as seen in the TPMS/DCT Module instructions.
6. Locate the TCM. Shown below.

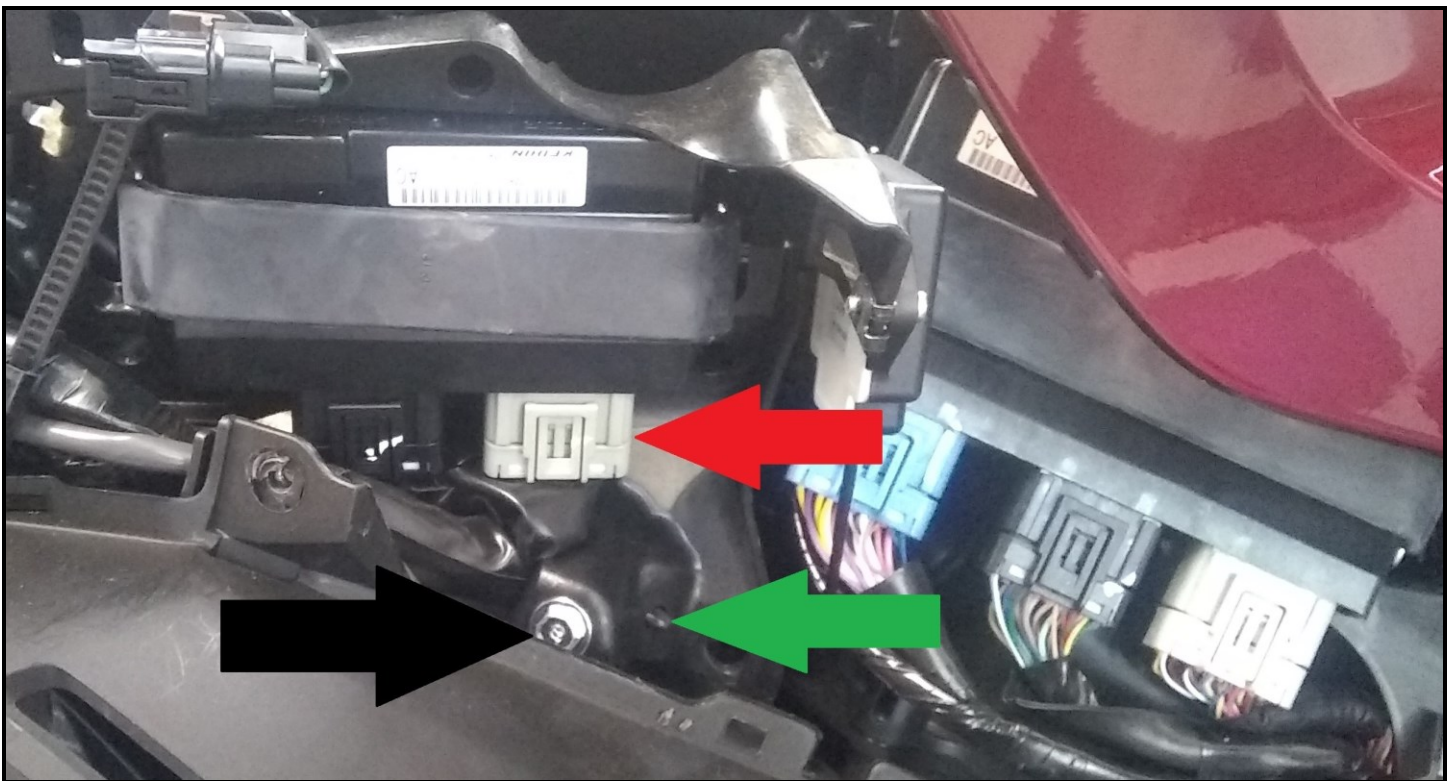

7. Remove bolt, Black Arrow
8. Remove the zip tie holder and cut and discard zip tie. Green Arrow.

9. Undo rubber strap and release the TCM.
10. Unplug the grey connector. **Red** Arrow. Move the harness below where the bolt was all pull out on the harness. This should give you enough slack to work on the harness.
11. Locate the **Blue** wire. **Blue** Arrow.

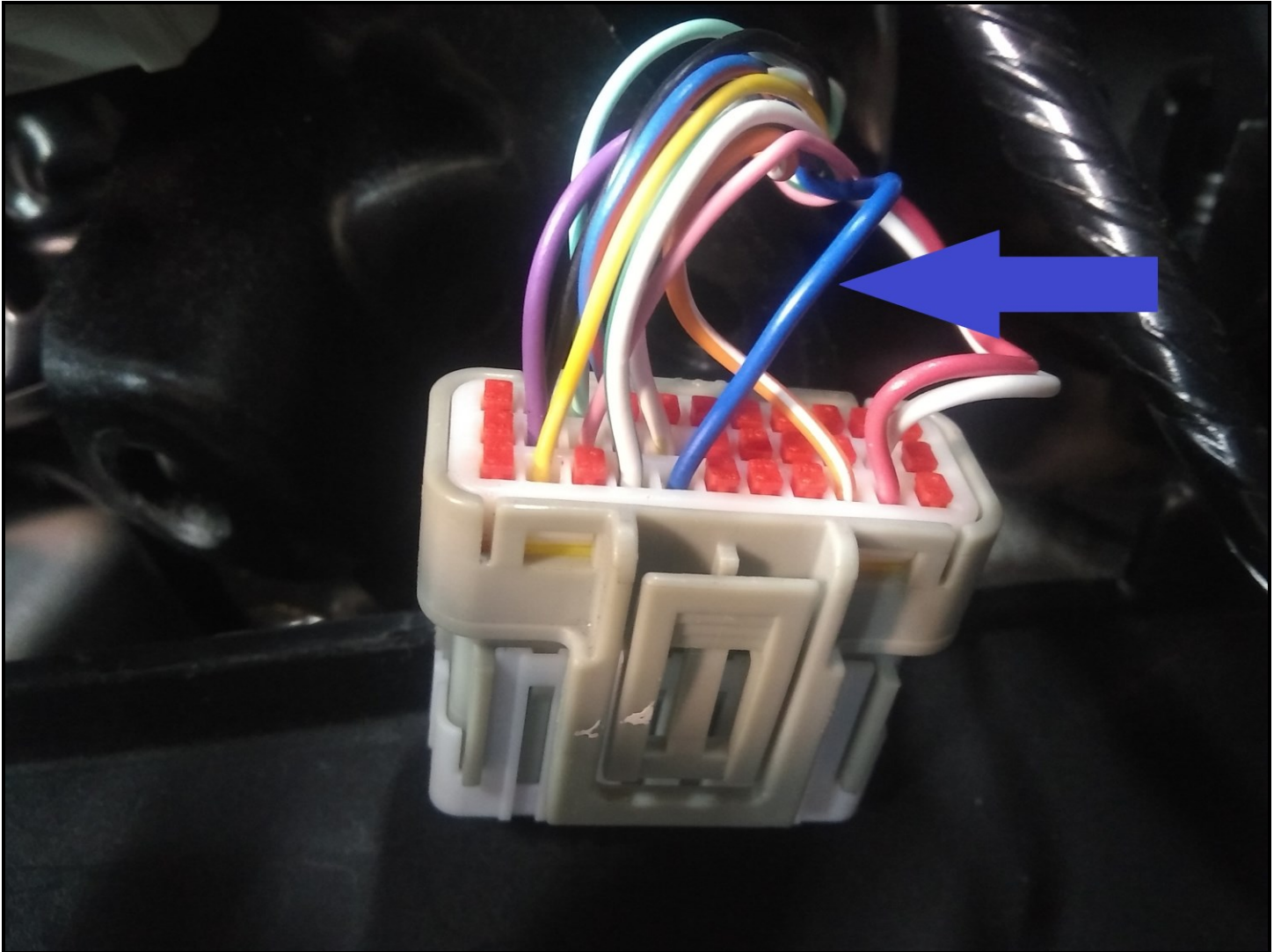

12. Route the Grey wire forward to the TCM and connect it to the **Blue** wire.
13. Tape up the wire and the harness.
14. Secure wire and harness with zip ties as needed.
15. Install the TPMS/DCT Module now using separate instructions.
16. Replace all OEM parts removed from before.

## Body Installation:

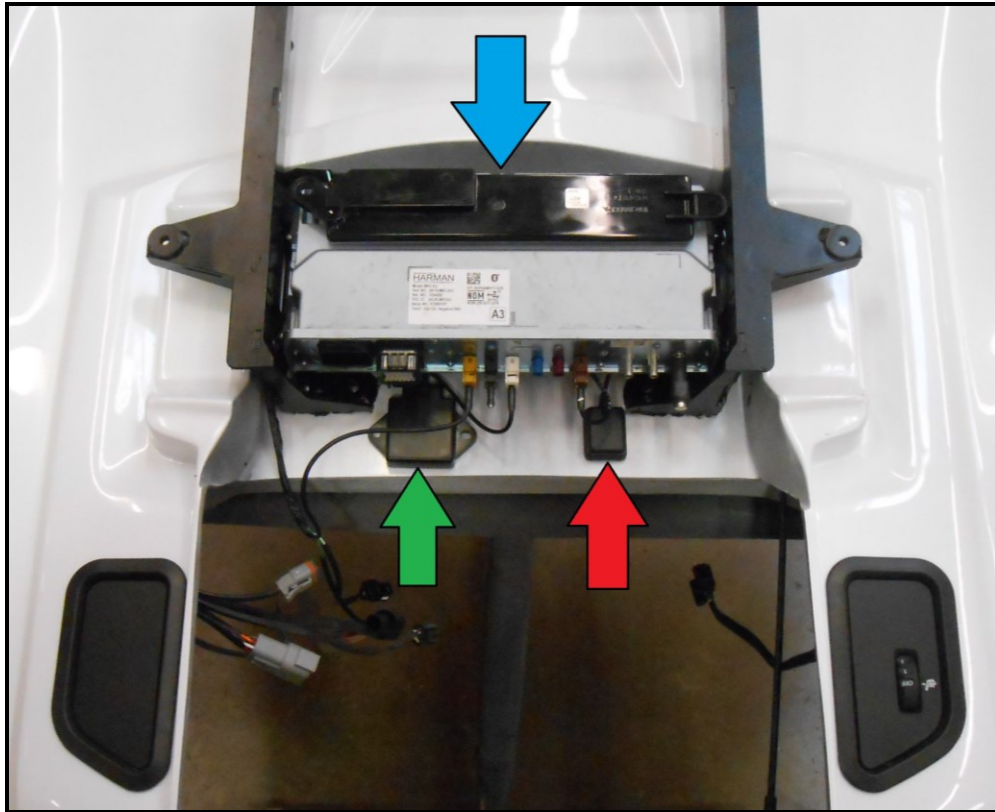

1. Remove the Tour Box/Radio Mount from Trike Body.
2. Install the Radio onto the Mount using OEM Hardware.
3. Use Silicone to seal all 6 holes.
4. Reinstall the Mount onto the body as it was removed.  
Note: The Flat Washer is at the Right Rear of Mount.
5. Secure the mount with the previously removed hardware.
6. Secure the AM/FM Antenna **BLUE ARROW** to the radio
7. Secure the GPS **RED** and BT **GREEN** Antennas to the body.
8. Use 2 sided tape for all 3 Antennas.
9. Install the Controls from the Saddlebags into the trike body and their covers.
10. Lower the body onto the trike with the front of the body pointing slightly downward until it comes to rest onto the upper tray and body frame.

## Top Trunk Installation:



1. If motorcycle was equipped with a USB connector in saddlebag, install it in tour box before placing on trike body. For 2018-2020 trikes a 1in hole must be drilled in tour box. For 2021-Curent trikes there is a rubber plug that must be removed to install USB connector.
2. Lower the top trunk into place. Be aware of the wire harness and the release cable.
3. Make sure the OEM aluminum spacers are still in place.
4. Reconnect all the top trunk connectors and Radio connectors.
5. Install the AM/FM Antenna ground with OEM bolt as shown. File the paint off of the frame. **RED ARROW.**

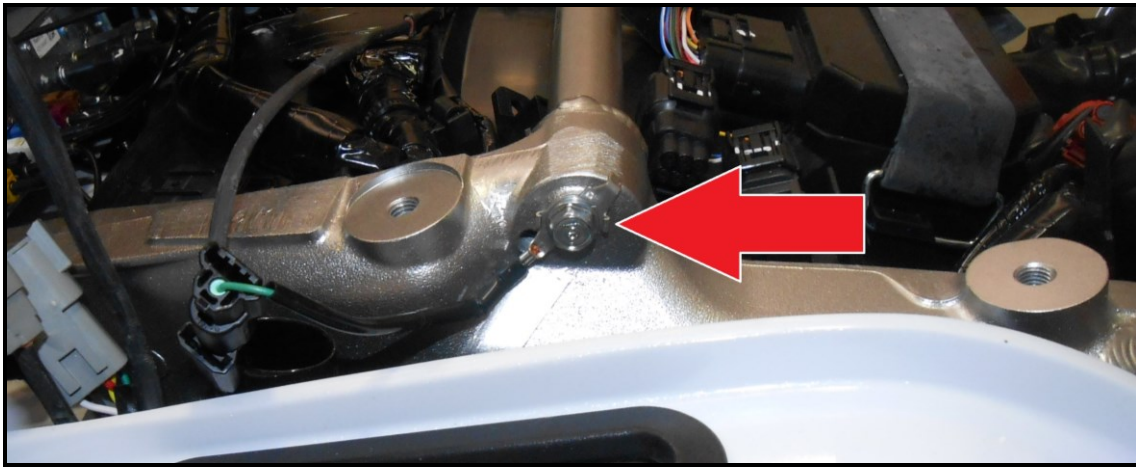

6. Route the release cable from the trunk forward to be under the seat area.
7. Install OEM Fasteners and washers into the top trunk.
8. Reinstall the rear cover using 4 screws and 1 plug.
9. Reinstall the right and left Tour Box sides with 3 push clips and 5 screws in each Tour Box side.  
Note : the longer push clip goes in the front hole.
10. Reinstall 2 screws and the Black Tour Box front cover.
11. Reinstall the Passenger Back rest pad with 6 long and 2 short screws and 1 plug.

### **Trike Body Alignment:**





1. Install Passenger Floorboards with OEM hardware.
2. Install Passenger Floorboard covers with 2 OEM bolts in front and 1 flange bolt into the CSC mount in the rear.
3. Install Passenger Seat Handles now. It may be necessary to grind the inner lip of the body, so the handles fit nice.

**Having the handles installed will help insure left to right alignment in the front of the body.**

4. Grind the OEM Side covers as shown.

**RED** marks show area to be removed.



Remove entire vertical surface trying not to touch or Scratch the flat part as this surface will be seen.



**AFTER. Make sure to round all corners and remove the lower rear Grommet peg.**



**5. Install a Side cover Grommet on the top peg.**



6. Install Side covers onto body.

7. The trike body can move left, right, forward, backward, up, down, and angled. Shimming with the provided 1/4 and 1/8 rubber washers may be required to get the trike body into alignment.

8. Initial trike body fitting:

a) First raise the front of the body to obtain Clearance on the Heat Shields using the 90° body support brackets.

b) Align the rear side covers into the 2 grommets on the bike.

c) Make sure the 90° body support brackets are square to the body's inner liner.

**For the next two steps you can measure or install the rear wheels and us them for alignment. At the Factory we align with the wheels on.**

9. Center the trike body left to right using a square and measuring off of the wheels also looking at the exhaust tips.

10. Adjust the body so the wheel is centered in the wheel opening. It should be the same measurement for the front of the opening and the rear.

**11.** Now that you have balanced centering the wheels, exhaust tips, and got the side cover fitting good. Move on to Securing the body.

## **Securing the Trike Body:**

**Note:** A small section of trike body carpet has not been glued at the location of the trike body frame mounting tabs to allow removal of the bolts used in shipping, and installation of the trike body mounting hardware. The predrilled bolt holes may need to be enlarged or relocated for trike body attachment to the trike body frame mounting tabs. If relocation is necessary, the Preexisting holes will need to be **sealed** with silicone sealant.

- 1.** Using a 5/16 twist drill, drill up through the holes in the body frame into the rear of the trike body.
- 2.** Use Silicone sealant around the new and preexisting holes.
- 3.** Insert two 5/16-18 x 1- 1/4 HHCS, two 5/16 fender washers through the holes drilled, Secure with 2 Flanged Nyloc nuts and tighten.
- 4.** Confirm that the body alignment is still good.
- 5.** Using a 5/16 twist drill, drill up through the 90° brackets into the trike body.
- 6.** Insert two 5/16-18 x 1- 1/4 HHCS, two 5/16 fender washers through the holes drilled, Secure with 2 more Flanged Nyloc nuts.

## Wiring the Trike:

1. Route the Battery Harness towards the battery area.
2. Route the red wire with the fuse holder to the (+) POSITIVE side of the battery.
3. Route the white wire in the trike body wiring harness to the (-) NEGATIVE side of the battery.
4. Plug in the wire harness adaptor into the body and to the Left and Right Saddlebag plugs and the small 2 pin plug.
5. The Left CSC plug has a Yellow wire in it.
6. The Right CSC plug has a Green wire in it.

## Manual Models:

1. Connect the **BLUE** wire with an eyelet from the Reverse Resistor to the **BLUE** wire in the Adaptor Harness.

## **Final Reassembly of the Motorcycle:**

- 1. Install the spring from the OEM Helmet Holder cable onto the CSC cable.**
- 2. Affix the CSC cable onto the seat handle, and then install both handles.**
- 3. Install the CSC filling panel.**

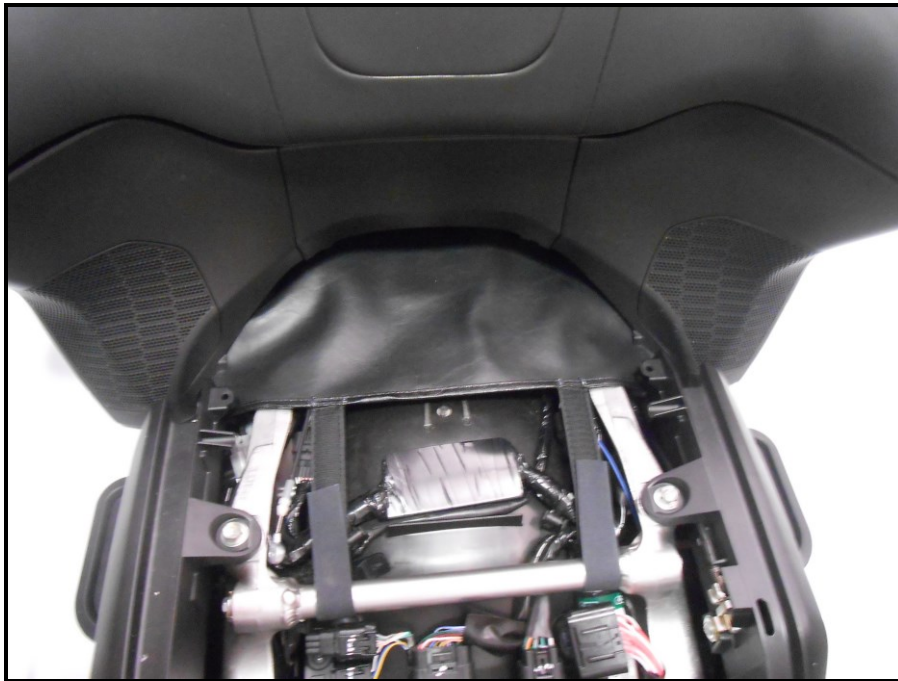

- 4. Reinstall the wheel and tires. Torque to 80 Ft. - LBS.**
- 5. Recommended tire pressure**
  - 15" & 16" wheels – 28 psi**
  - 17" wheels – 25 psi**
- 6. While installing seat be care of the white ears that stick down on either side close to the body. These ears MOST go inside the body.**
- 7. Replace the seat with 2 OEM SHCS. Plug in if equipped.**
- 8. Test all Lights and Enjoy the Test Ride.**

**From all of us at California Sidecar.  
Enjoy the ride.**

8 7 6 5 4 3 2

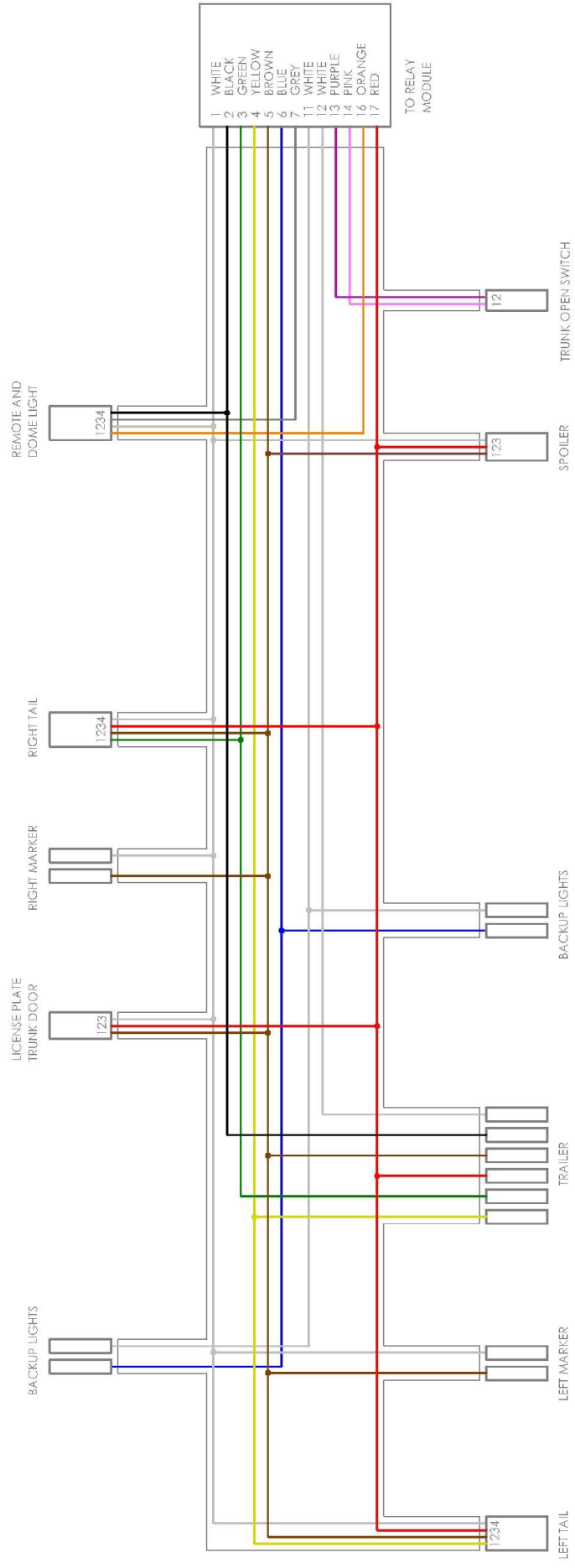

- WIRE COLORS:**  
 BLACK: 12V CONSTANT  
 BROWN: 12V SWITCHED WITH RUNNING LIGHT  
 RED: BRAKE  
 GREEN: RIGHT TURN  
 YELLOW: LEFT TURN  
 BLUE: BACKUP  
 ORANGE: REMOTE SWITCHED POWER  
 GREY: TRUNK LATCH OPEN LIGHT  
 WHITE: GROUND  
 PINK: TRUNK OPEN SWITCH  
 PURPLE: TRUNK OPEN SWITCH

<b>California Side Car inc.</b> 100 MOTORCYCLE LN, ARRINGTON, VA 22922	
TITLE	TRIKE WIRE HARNESS INSIDE BODY
SIZE	PART NUMBER
B	ELC-21117
SCALE	VENDOR DRAW NUMBER
1:1	N/A
REV	SHEET
A	3 OF 3

THIS DOCUMENT CONTAINS COPYRIGHTED MATERIAL AND IS THE PROPERTY OF CALIFORNIA SIDE CAR CO. INC. OR ITS SUBSIDIARIES. UNAUTHORIZED USE, DISCLOSURE, REPRODUCTION, OR DISTRIBUTION OF THIS DOCUMENT IS PROHIBITED AND MAY RESULT IN LIABILITY UNDER APPLICABLE LAWS.



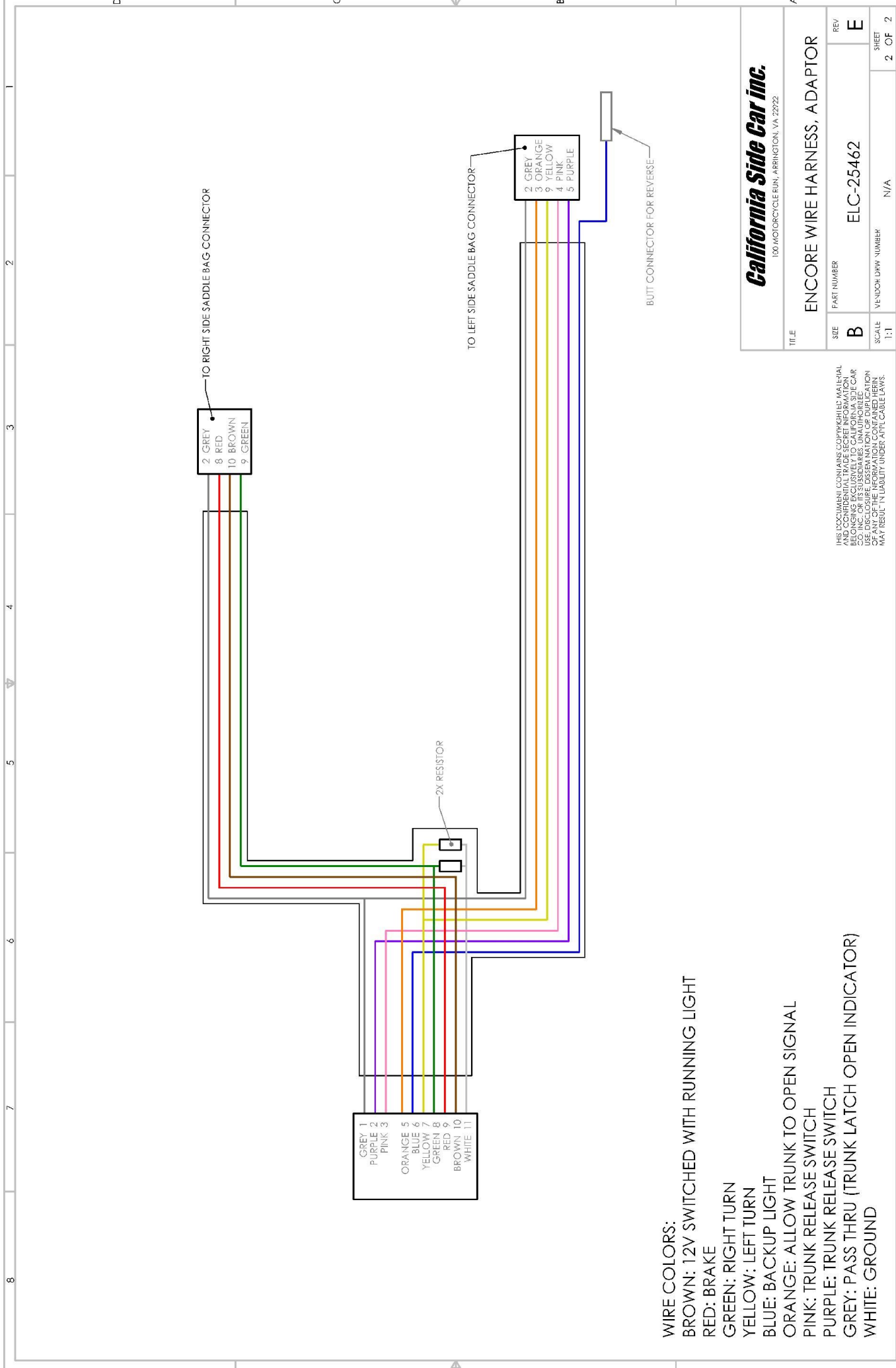

- WIRE COLORS:**
- BROWN: 12V SWITCHED WITH RUNNING LIGHT
  - RED: BRAKE
  - GREEN: RIGHT TURN
  - YELLOW: LEFT TURN
  - BLUE: BACKUP LIGHT
  - ORANGE: ALLOW TRUNK TO OPEN SIGNAL
  - PINK: TRUNK RELEASE SWITCH
  - PURPLE: TRUNK RELEASE SWITCH
  - GREY: PASS THRU (TRUNK LATCH OPEN INDICATOR)
  - WHITE: GROUND

**California Side Car inc.**  
 100 MOTORCYCLE RUN, ARRINGTON, VA 22722

TITLE		ENCORE WIRE HARNESS, ADAPTOR	
SIZE	PART NUMBER	REV/	REV/
B	ELC-25462	E	E
SCALE	VENDOR PART NUMBER	SHEET	2 OF 2
1:1	N/A		

THIS DOCUMENT CONTAINS COPYRIGHTED MATERIAL  
 WHICH IS THE PROPERTY OF CALIFORNIA SIDE CAR  
 CO., INC. OR ITS SUBSIDIARIES. UNAUTHORIZED  
 REPRODUCTION OR TRANSMISSION OF ANY  
 PART OF THE INFORMATION CONTAINED HEREIN  
 MAY RESULT IN LIABILITY UNDER APPLICABLE LAWS.