

Air Core Oil Pressure Gauge Upgrade Box Installation Guide (0-80PSI)

Rev. 1.8 © 2015, 2016, 2018, 2019, 2020 Accutach Co.

www.accutach.com

Thank you for purchasing the Accutach Co. Air Core 0-80 Oil Pressure Gauge Upgrade Box. It is designed to turn your stock oil pressure gauge from an idiot light in gauge form into a real oil pressure gauge. Units shipped from 2018 (Marked "R1") have an in-line connector to allow easier installation and easy future cluster removal and replacement.



WARNINGS and DISCLAIMERS:

Box dimensions:

1.57" x 1.57" x 0.78"

You use this product at your own risk. Accutach Company is not responsible for personal injury or property damage resulting from the use of this product.

This unit is designed to work with any air core oil pressure gauge that is controlled by a microprocessor in the instrument cluster. This installation guide is written with a 1999-2004 Mustang or F150 in mind, but it can be used with any cluster that uses a microprocessor controlled 4-pin air core gauge. Installation into a Mustang/F150 cluster, and possibly other clusters, is reversible in case you ever want to take your cluster back to stock operation.

You should disconnect the battery prior to doing the installation of this unit into your vehicle. FYI, this unit draws approximately 200mA during operation.

We strongly recommend making wire connections with solder & shrink tubing, although properly made crimp splices can also be reliable. We do not recommend using "Scotch Lock" style connections for our products. Do not use the "twist & tape" or wire nut methods of connecting wires.

Before you begin:

Before you begin, it is a good idea to check all of the indicator or illumination lights in your cluster. Since you will be removing the cluster, it will be easy to replace any bad lights with the instrument cluster out of the car.

You will need to identify a switched battery voltage power supply wire to splice into for power for the Oil Pressure Gauge Upgrade Box and you will need a good chassis ground to ground the unit. In a 99-04 Mustang, the heavy Pink wire with a Black stripe (GY/YE in the F150) provides instrument cluster power in Run, while the heavy White wire with a Light Blue stripe next to it (RD/LG in the F150) provides power in Start and Run. But any switched battery power source can be used. Note that the smaller WH/LB wire is the right turn signal wire, not power.

You will also need to locate a suitable place to install the unit inside of the vehicle's cabin, most likely in a cavity behind the instrument cluster. It is not intended for use in the engine compartment or anywhere outside of the vehicle. If you wish to create a custom mounting bracket out of ABS plastic you can cement it to the ABS box with standard ABS cement from a hardware store.

You will need to buy an Autometer 2241 80 PSI oil pressure sensor (not included), and a connector to attach a wire to the sensor. Users report that a 90 degree street elbow fitting makes sensor installation in the stock location easy. You will also need a length of 22 ga. or larger wire that will reach from the oil pressure sensor through the firewall and to the location where you will mount your Oil Pressure Gauge Upgrade Box. If you are willing to cut and splice your OEM harness, if you replace the OEM oil pressure sensor with the Autometer sensor, you can cut and splice the OEM oil pressure sensor wire (White/Red) to the Gauge Upgrade box's input wire. You will not need the connector or 22 ga. wire if you use the OEM wire. F150s also have an oil pressure idiot light that can be driven by the alarm output of the Upgrade Unit.

Mustang Installation

The following pages show how to install the Gauge Upgrade Unit in a 99-04 Mustang cluster. If you are installing it in a 99-04 F150 or equivalent, please read this section first. There is an F150 installation section right after this one that tells you the key differences to aid in the installation in a truck.

Unhook your car's battery. Remove your instrument cluster. There are a number of videos on YouTube that show how to remove clusters in 99-04 Mustangs and F150s.

Disconnect the stock oil pressure signal wire from the 6 PSI oil pressure sensor switch on your engine and replace the sensor with an Autometer 2242 0-100 PSI oil pressure sensor (not supplied.) Solder and shrink tube the oil pressure sensor connector to the length of wire, and connect it to the oil pressure sensor. Run the wire up through the firewall into the area of the instrument cluster. If you prefer your oil pressure sensor at a different location than the OEM sensor location, you can do that as well.

Place the cluster face down on a clean work surface. Remove the 6 Torx T-15 screws that retain the back cover of the cluster. Here is a photo of the cluster with the back cover removed:

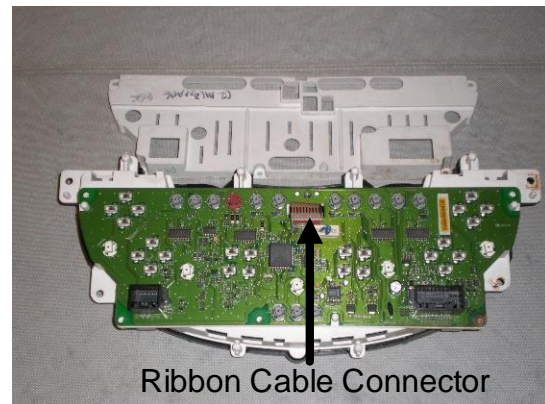
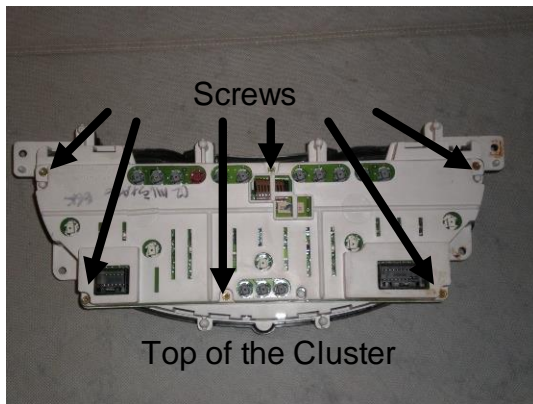

Unplug the ribbon cable connector and remove the Printed Circuit Board (PCB) from the back of the cluster. Locate the male pins on the back of the oil pressure gauge (bottom left gauge when viewed from the back of the cluster.)

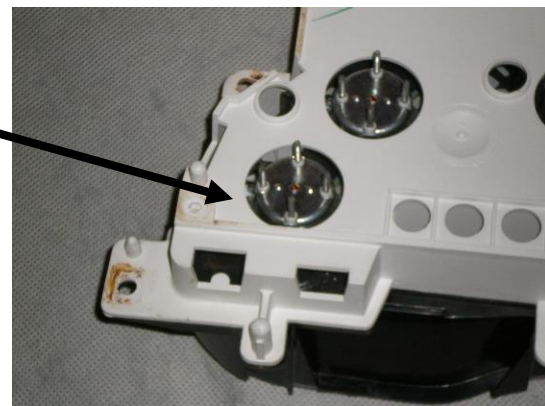

Your new Accutach Co. Oil Pressure Gauge Upgrade Box has 4 wires that must be connected to the pins of the oil pressure gauge. Those pins must be isolated from the electronics on the cluster PCB. If both the PCB electronics and the Upgrade Box are connected to the gauge together, then the upgrade will not work, and the cluster and Upgrade Box may be damaged or destroyed.

In order to allow the Upgrade circuit wires to safely connect to the gauge pins, you will need to bend the female gauge pins away from the male gauge pins, and enlarge the PCB pin holes so the insulation will not be scraped off of the Upgrade Box female pins at the ends of the wires.

FYI, the cluster can be returned to stock operation by removing the Upgrade Box, and bending the female gauge pins on the PCB back to their original position.

Here is a photo of the unbent female gauge pins on the PCB. You need to bend each wiper away from the pin hole so the stock OEM female pins will not wipe the insulation off of the Upgrade Box pins.

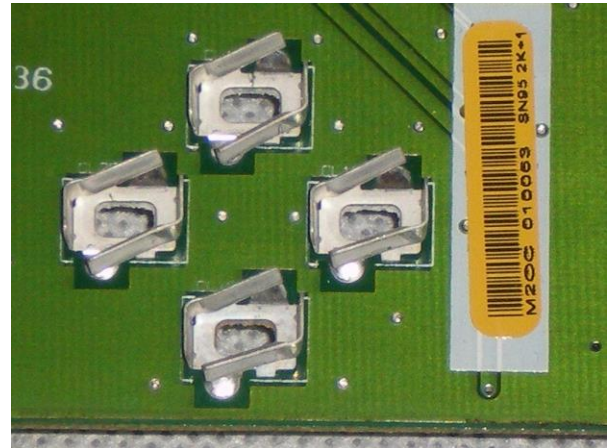
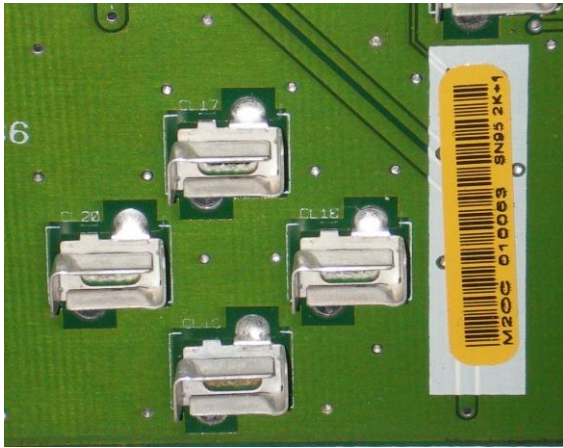

Once the pins have been bent away from the holes, enlarge the holes by carefully enlarging them until a 3/16" drill bit will pass through them. If you drill the holes out, drill from the PCB side with no components, but drilling can tear up the female connector base. Some people run a 3/16" drill bit backwards in a drill press. I recommend a small cone shaped burr in a Dremel tool to widen the holes until the drill bit will fit through the hole. See the burr photo on page 6.

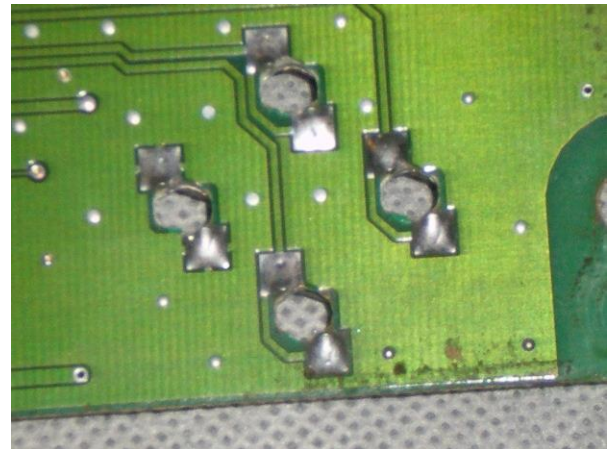
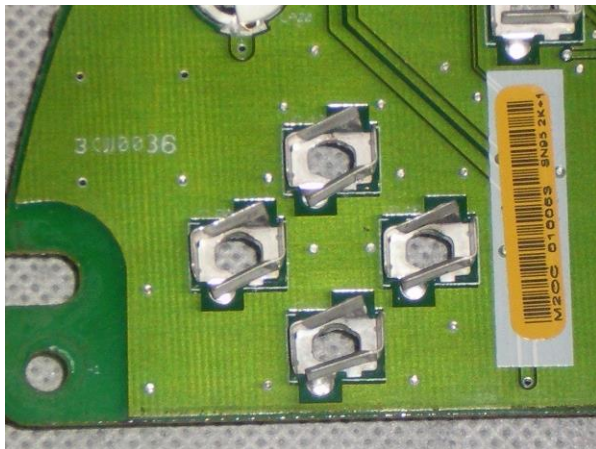

This allows the upgrade box circuit to be completely isolated from the PCB circuits. Reinstall the PCB on the back of the cluster and make sure there is enough space between each pin and its surrounding PCB to avoid scraping the insulating shrink tubing off of the upgrade unit's female pins when you plug them in. If the gap is too small, widen the hole a little more. Now it is time to thread the orange, gray, white and purple wires through the rear cluster cover. Thread the wires through the hole behind the illumination bulb nearest the oil pressure gauge.

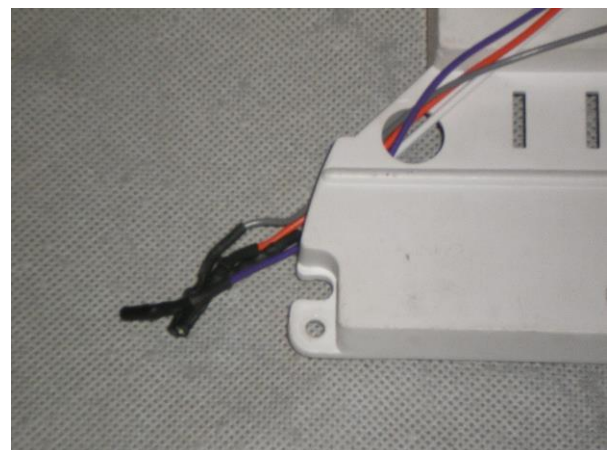
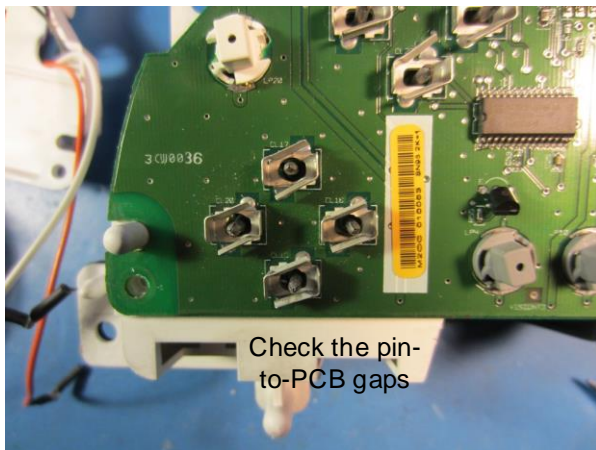

Carefully plug the gray wire all the way down onto the top oil pressure gauge pin. Make sure you do not scrape the insulating shrink tubing off of the female pin on the side of the PCB hole. Plug the white wire all the way down onto the right pin, plug the purple wire onto the left pin and plug the orange wire onto the bottom pin. Replace the rear cluster cover. The Upgrade Unit pins may prevent the rear cover from fully seating against the back of the cluster, but this will not be a problem in the vehicle.

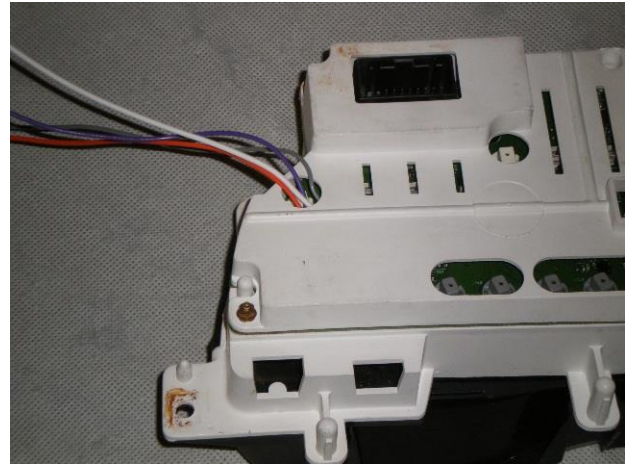
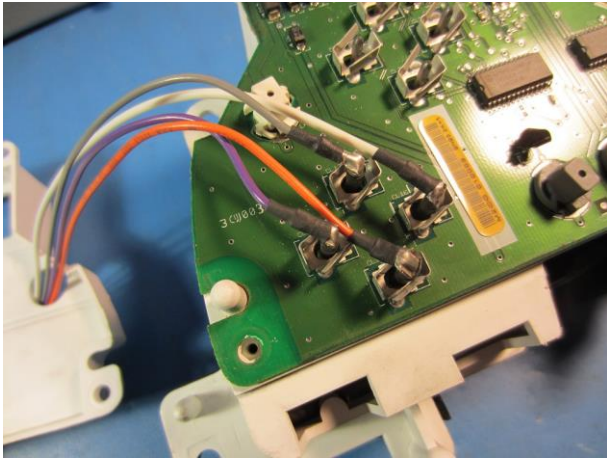

Move the cluster with the Upgrade Box now attached to the cockpit of the car. For your convenience, you can disconnect the Upgrade Unit's gauge wire connector to make the upgrade unit installation easier. Connect the Upgrade Unit's red wire to the switched power of your choice and connect the black wire to your good chassis ground. Connect the blue wire to the wire you ran from the oil pressure sensor on the engine or to the White/Red OEM oil pressure signal wire from the sensor if you are using the OEM wire.

If you want to add a low oil pressure idiot light to a Mustang or any other car that does not have one, you can connect one side of an automotive relay to switched power and the other to the Upgrade Unit's yellow wire. Connect your idiot light to the Normally Closed terminal of the relay.

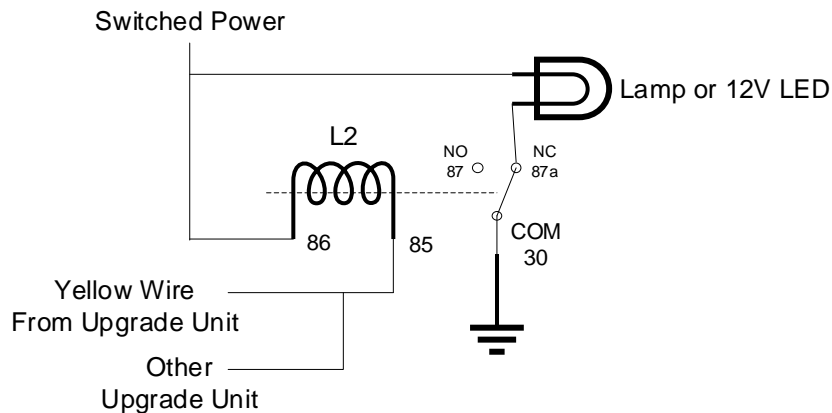

The Accutach Co. Oil Pressure Gauge Upgrade Unit's yellow wire can also be wired to the Accutach Co. Temperature Gauge Upgrade Unit's yellow wire if you want to use just one idiot light and relay for both functions. F150s have a temperature/oil pressure idiot light in the cluster. Please see the next section for F150 wiring instructions.

Mount the box behind the cluster so there is room to reinstall the cluster, reconnect the Upgrade Unit's gauge wire connector and reinstall the cluster. Some people zip tie the box to one of the cluster connector cables. Reconnect the battery. Go to Page 7 for the testing procedure.

F150 Installation

Please read the Mustang installation section before you read this section. This section only details the differences between Mustang and F150 installation.

Do not take the plastic front cover off of the cluster, but if you do, be sure not to lose the little coupler that connects the odometer reset rod to its switch on the PCB. Also, don't lose the rod itself.

The oil pressure gauge in the Mustang is in the lower right-hand corner of the cluster, so it is in the lower left-hand corner of the cluster when the cluster is viewed from the rear. In the F150, the oil pressure gauge is in the upper left of the cluster so it is in the upper right of the cluster when the cluster is viewed from the rear. Make sure you spread the female pins and ream out the holes on the PCB for the oil pressure gauge, not a different gauge. Plug the PCB onto the back of the cluster. Make sure there is clearance for the Upgrade Unit's female pins and shrink tubing between the male pins and PCB. Plug the Gray wire onto the upper right pin. Plug the Orange wire onto the lower left pin. Plug the Purple wire onto the upper left pin and plug the White wire onto the lower right pin.

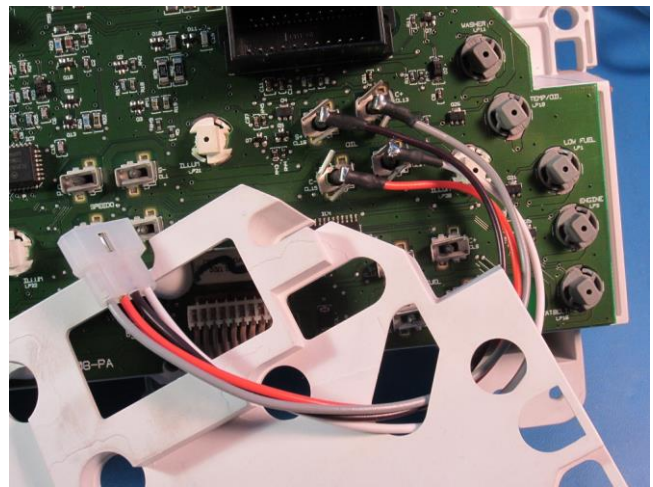

The F150 instrument cluster Hot in Start & Run power is the RD/LG wire and the Hot in Run power is the GY/YE wire.

The Upgrade Unit is designed to activate the idiot light when the oil pressure falls to 6 PSI or below. In an F150, if you cut the OEM oil pressure wire, you can ground the White/Red OEM wire that goes to the instrument cluster to disable the oil pressure input to the OEM OP/Temp idiot light. If you want to retain the OEM idiot light function, run the yellow wire from the upgrade unit to the White/Red OEM wire that goes to the instrument cluster. This causes the Upgrade Unit to emulate the stock oil pressure switch that drives the idiot light. If you are also using an Accutach Co. Temperature gauge upgrade, you can wire both yellow wires to the White/Red OEM wire so either alarm can set the F150 idiot light.

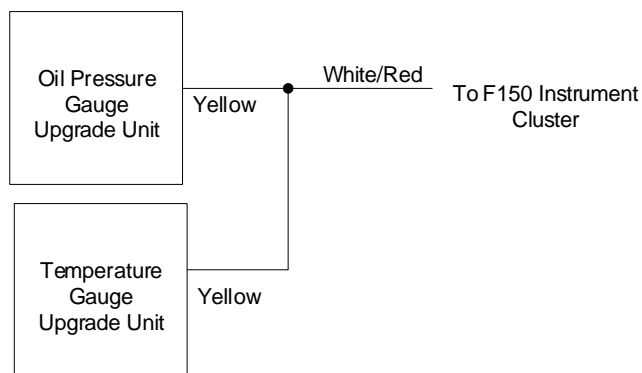

If you did not replace the F150 OEM oil pressure switch with the Autometer sensor, you can simply leave the yellow wire from the upgrade unit unhooked and the OEM switch will drive the idiot light.

Replace the back cover.

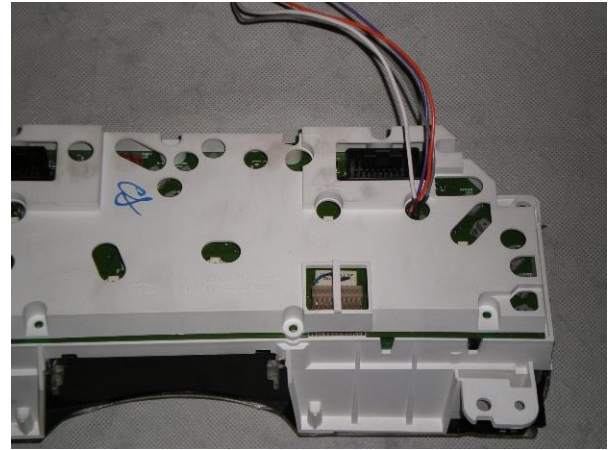

Replace the screws on the back of the cluster. Cut the white/red oil pressure signal wire near the cluster connector and splice the Upgrade Unit blue wire to the side of the white/red OP signal wire that goes to the sensor. Splice the Upgrade Unit yellow wire to the side of the white/red OP signal wire that goes to the cluster. Connect the red wire to switched power and the black wire to ground. Reinstall the cluster. Replace the OEM oil pressure switch with the Autometer 2241 sensor, and reconnect the battery.

Recommended Dremel Tool Burr

I have found that the cone shaped Dremel Tool burr shown below does a very good job of reaming out the PCB and female connector holes to make room for the Upgrade unit wires:



Testing your Upgrade Box

Your Upgrade Box performs a self test sweep of the gauge from low to high and back to low whenever power is first supplied. If the needle does not sweep the gauge from low to high and back low again when you turn the key on, there is a problem with the upgrade. In that case, please see the troubleshooting section below.

Operation

When power is applied to the Upgrade Box, after the initial full sweep of the needle, the angle of the needle represents the oil pressure. The L mark represents 0 PSI of pressure and the H mark represents 80 PSI. The oil pressure gauge has a 90 degree range. Every 11 degrees of clockwise needle deflection represents a 10 PSI increase in oil pressure. Black Cat Customs has indicated that they can make custom gauge faces.

Troubleshooting

If the needle fails to sweep when power is first applied, check your power and ground to ensure the Upgrade Unit is getting power. If the unit is getting power, then double check that you have the correct colored wires connected to the correct gauge pins. Make sure there are no shorts between the Upgrade Box pins and the PCB pins.

If the needle does not sweep from the low and high marks, the needle may not be set on the gauge shaft at the correct angle. To determine this, disconnect the oil pressure sensor wire from the oil pressure sensor. Turn the key on and the needle should point directly at the L mark. If it doesn't, you will need to calibrate the needle on the shaft.

Remove the instrument cluster bezel as if you were going to remove the cluster again. Then remove the clear cluster cover from the cluster. With an F150, don't lose the odometer reset rod or coupler. This will expose the needles and gauge faces. Use a common dinner fork, and a clean, lint-free cloth under it, carefully pry the needle off the shaft. With the oil pressure sensor wire still unhooked, turn the key on and press the needle back onto the shaft with the needle pointing at the L mark. Don't press it on too far or it will bind on the gauge face and not move properly. Once you have the needle on the shaft at the correct angle, replace the clear cluster cover and the bezel. Connect the oil pressure wire to the oil pressure sensor and the calibration is done.

Installation in vehicles other than 99-04 Mustangs or F150s

Vehicles other than Mustangs also use air core gauges in microprocessor controlled instrument clusters. If you can isolate the oil pressure gauge from the cluster PCB, you can connect the wires to the gauge and use the upgrade circuit in that vehicle. But the pin configurations may not be the same. You must figure out which pins are the top, bottom, right and left pins.

Using a 9 volt battery and two clip leads, try putting 9 volts on different pin pairs until you find a pair that drive the needle to the halfway point on the gauge face. Once you have found that pair, label the positive pin "Left" and label the negative pin "Right". Then move the clip leads to the other wire pair. If the needle moves clockwise, label the positive pin "Bottom" and the negative pin "Top". If the needle moves counter-clockwise, label the positive pin "Top" and the negative pin "Bottom". You may need to splice different pins to the wires for air core gauges with different types of pins. After that, install the Upgrade Box following the instructions for the Mustang.

Enjoy your upgraded oil pressure gauge. If you have any questions or issues, please contact Accutach Co. for support. See www.accutach.com for contact information.