



Features

- Efficacy with 133lm/w, designed to replace 250W and 400W HID while consumes 140W and 200W only
- Optional integrated lens of either 90 or 120degree; or aluminum reflectors of 90degrees
- Hook or Conduit pendant way for different applications
- PIR sensor can be offered for maximizing energy savings
- Superior colour rendition index compared to HPS
- Operating temperature is -40°C to 55°C (-40°F to 131°F)
- Resistant to shock and vibration
- UL/cUL listed and DLC qualified.



PERFORMANCE DATA

			4000K(70CRI)		5000K(70CRI)	
SYSTEM WATTS	LENS	VOLTAGE	LUMENS	LPW	LUMENS	LPW
140W	90 Degree Aluminum Reflector	120-277VAC/347-480V	17500lm	125lm/W	17500lm	125lm/W
140W	90 Degree Lens	120-277VAC/347-480V	18800lm	134lm/W	18900lm	135lm/W
140W	120 Degree Lens	120-277VAC/347-480V	19500lm	139lm/W	20000lm	143lm/W
140W	PC Reflector	120-277VAC/347-480V	17000lm	121lm/W	17000lm	121lm/W
200W	90 Degree Aluminum Reflector	120-277VAC/347/480V	23000lm	115lm/W	24000lm	120lm/W
200W	90 Degree Lens	120-277VAC/347/480V	26000lm	130lm/W	26000lm	130lm/W
200W	120 Degree Lens	120-277VAC/347/480V	26500lm	133lm/W	26700lm	134lm/W
200W	PC Reflector	120-277VAC/347/480V	23500lm	117lm/W	23500lm	117lm/W

ELECTRICAL DATA

Number Of Drivers	Driver Current (mA)	Nominal Power (W)	INPUT VOLTAGE (V)	CURRENT (Amps)
2	3500	140	120	1.17
		140	208	0.67
		140	240	0.58
		140	277	0.51
2	3700	140	347	0.40
		140	480	0.29
2	5000	200	120	1.67
		200	208	0.96
		200	240	0.83
		200	277	0.72
2	4760	200	347	0.58
		200	480	0.42

DIMENSION

unit: inch/mm

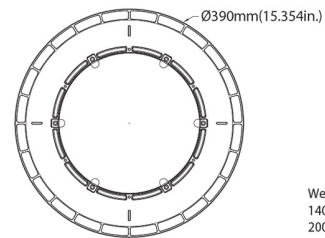
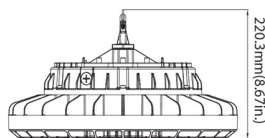
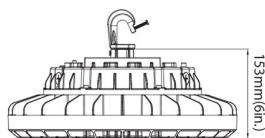

Weight
140W: 12.56lb
200W: 13.58lb

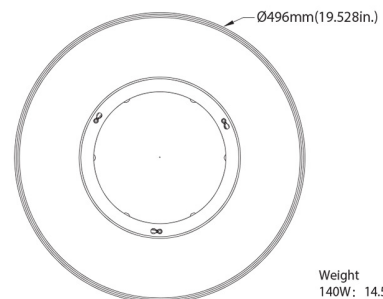
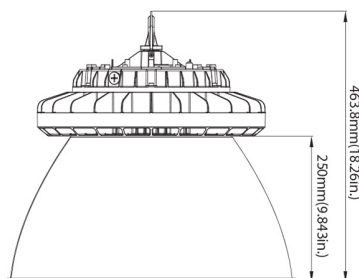
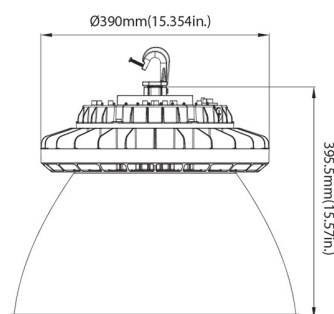

Weight
140W: 14.55lb
200W: 15.57lb

PHOTOMETRICS

90 Degree Aluminum Reflector
Luminous Intensity Distribution Curve

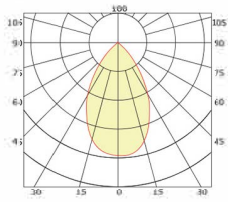

120 Degree lens
Luminous Intensity Distribution Curve

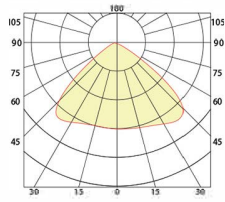

90 Degree lens
Luminous Intensity Distribution Curve

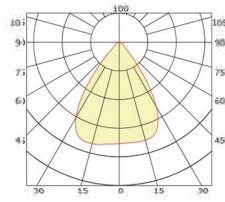

Conical Bottom Lens
Luminous Intensity Distribution Curve

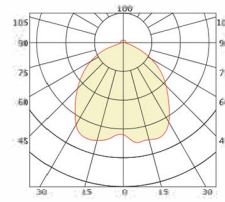

Prismatic Drop Lens /
Smooth flat lens
Luminous Intensity Distribution Curve

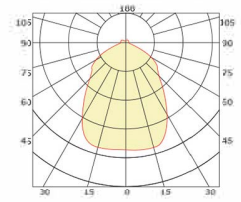

ORDERING GUIDE

Fixture Type	Wattage	Voltage	CCT	Beam Angle	Finish	Sensor (Option)	Internal Code
<input type="text"/>	<input type="text"/>	<input type="text"/>	<input type="text"/>	<input type="text"/>	<input type="text"/>	<input type="text"/>	<input type="text"/>
HB01 High Bay	140 140W 200 200W	27V 120-277V 48V 347/480V 347-480V	40K 4000K 50K 5000K	90A 90 Degree Aluminum Reflector 120A 120 Degree Aluminum Reflector 90 90 Degree Lens 120 120 Degree Lens	D Dark Bronze B Black W White	M With Sensor Blank Without Sensor	Blank Alphanumeric