

## Adhesive Dispensing Ltd Product Catalogue

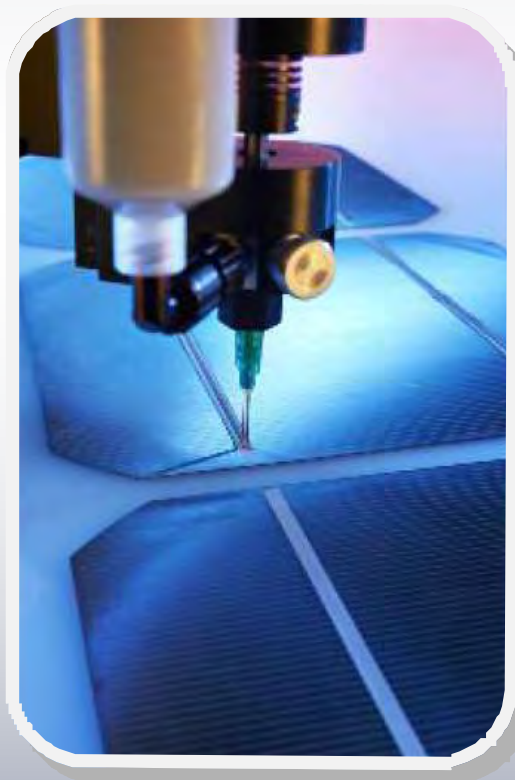

## Fluid dispensing systems

Precision dispensing systems, components and consumables, metering valves, bench top robots, fume extraction, accessories and adhesives.

Solutions customers stick with ...

HP series hand plungers offer a cost effective and simple solution for dispensing low volumes of fluids and pastes. Use with industry standard syringe barrels and our 700 series components. The design reduces hand fatigue often associated with hypodermic syringes. Reusable product.

### Hand Plungers

Size	Plunger only	Plunger with kit
3cc	TS703HP	TS703HP-KIT
5cc	TS705HP	TS705HP-KIT
10cc	TS710HP	TS710HP-KIT
30cc	TS730HP	TS730HP-KIT



#### Typical Applications:

Solder paste, RTV silicone, grease, gel, inks, glues, epoxies

Manual SyringeGuns have a 7:1 leverage to make it easier for applying pastes and gels. The ergonomic design reduces hand fatigue when used often. Use with industry standard barrels and our 700 series components. Supplied as gun only or with full packs of barrels, pistons, caps and tips.

### Syringe Guns

Size	Gun only	Gun with kit
10cc	TS710SG	TS710SG-KIT
30cc	TS730SG	TS730SG-KIT
55cc	TS755SG	TS755SG-KIT



#### Typical Applications:

Solder paste, RTV silicone, UV cure, PVA, gels, epoxies...

The AD16 series are manual hand operated guns for dispensing of gels, pastes, glues and other fluids. Metal threaded retainers with secure attachment to handle and trigger. This gun is compatible with industry standard plastic cartridges as well as 310ml silicone and sealant caulk tubes.

### Cartridge Guns

Size	Part Code
2.5oz	AD16-25
6oz	AD16-60
8oz	AD16-80
310ml	AD16-110
12oz	AD16-120



#### Typical Applications:

Sealants, RTV silicone, epoxies, glues, gels, adhesives...

The TS16 series are manual hand operated guns for dispensing gels, pastes, glues and other materials. Aluminium slotted bayonet retainers with secure attachment to handle and trigger. This gun is compatible with industry standard plastic cartridges from 2.5oz to 12oz sizes.

### Cartridge Guns

Size	Part Code
2.5oz	TS16-25
6oz	TS16-60
8oz	TS16-80
12oz	TS16-120



**Typical Applications:**

Sealants, RTV silicone, epoxies, glues, gels, adhesives...

The 850 series are manual hand operated guns for dispensing of gels, pastes, glues and other materials. Metal threaded retainers with secure attachment to handle and trigger. This gun is compatible with industry standard plastic cartridges from 2.5oz to 32oz sizes. Lightweight product.

### Cartridge Guns

Size	Part Code
2.5oz	221824
6oz	221830
8oz	221832
10oz	230273
12oz	221836
20oz	230274
32oz	234054



**Typical Applications:**

Sealants, RTV silicone, epoxies, glues, gels, adhesives...

The 950 series are manual hand operated guns for dispensing of gels, pastes, glues and other materials. Metal bayonet retainers with secure attachment to handle and trigger. This gun is compatible with industry standard plastic cartridges in sizes 2.5oz to 12oz. Lightweight product.

### Cartridge Guns

Size	Part Code
2.5oz	920255
6oz	950065
8oz	950085
12oz	950125



**Typical Applications:**

Sealants, RTV silicone, epoxies, glues, gels, adhesives...

The 100A series are pneumatic guns for dispensing of gels, pastes, glues and other materials. Metal threaded retainers. For industry cartridges as well as 310ml (1/10 gallon) sealant tubes. Features an adjustable air regulator and a hook ring for counter-balance. Order air hose separately.

### Cartridge Guns

Size	Part Code
2.5oz	100A-25
6oz	100A-60
8oz	100A-80
310ml	100A-110
12oz	100A-120

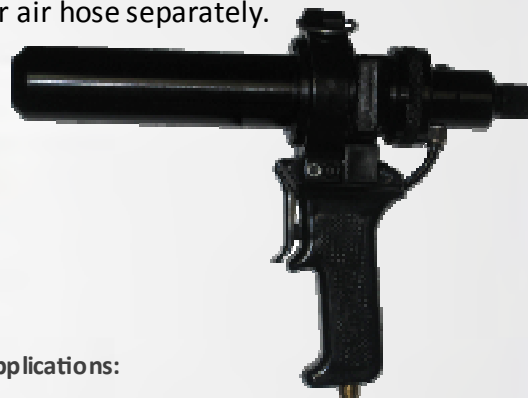

#### Typical Applications:

Sealants, RTV silicone, epoxies, pastes, gels, adhesives...

TSI series pneumatic hand operated cartridge gun dispensers for dispensing of gels, pastes, glues and other materials. Aluminium slotted bayonet retainers. All sizes are interchangeable. For use with industry cartridges in sizes 2.5oz to 12oz. Order air hose separately.

### Cartridge Guns

Size	Part Code
2.5oz	TS950-25-HA
6oz	TS950-60-HA
8oz	TS950-80-HA
12oz	TS950-120-HA



#### Typical Applications:

Sealants, RTV silicone, epoxies, pastes, gels, adhesives...

The 250-A series pneumatic hand operated cartridge guns for pastes, gels, RTVs, grease, silicone and sealants. Metal interchangeable bayonet retainers. For all standard cartridges in sizes 2.5oz to 12oz. Very lightweight guns. Order air hose separately.

### Cartridge Guns

Size	Part Code
2.5oz	250255
6oz	250065
8oz	250085
12oz	250125



#### Typical Applications:

Sealants, RTV silicone, epoxies, pastes, gels, adhesives...

250-B pneumatic cartridge guns for pastes, gels, RTVs, grease, silicone and sealants. Aluminium bayonet retainers. All sizes are interchangeable. For industry standard cartridges 2.5oz to 12oz. These guns have no trigger handle and use a lever to operate the air flow. Order air hose separately.

### Cartridge Guns

Size	Part Code
2.5oz	250250B
6oz	250060B
8oz	250080B
12oz	250120B

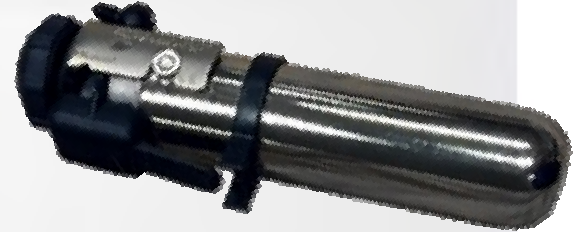

#### Typical Applications:

Sealants, RTV silicone, epoxies, pastes, gels, adhesives...

350-A pneumatic hand operated cartridge guns for dispensing of gels, pastes, glues and other materials. Metal interchangeable bayonet retainers. Adjustable flow regulator on handle. Cartridge sizes 2.5oz to 12oz. Order air hose separately.

### Cartridge Guns

Size	Part Code
2.5oz	350255
6oz	350065
8oz	350085
12oz	350125



#### Typical Applications:

Sealants, RTV silicone, epoxies, pastes, gels, adhesives...

Pneumatic hand operated cartridge gun dispensers for pastes, gels, RTVs, grease, silicone and sealants. Metal threaded retainers. For 20oz or 32oz size cartridges. Large capacity lightweight applicators. Order air hose separately.

### Cartridge Guns

Size	Part Code
20oz	231218
32oz	233688



#### Typical Applications:

Sealants, RTV silicone, epoxies, pastes, gels, solder pastes, adhesives...





G series pneumatic hand operated cartridge gun dispensers for dispensing of gels, pastes, glues and other materials. Metal bayonet retainers. All sizes are interchangeable. Trigger includes attached 10 ft. long airline hose. For use with all industry cartridges in sizes 2.5oz to 20oz.

### Cartridge Guns

Size	Part Code
2.5oz	G110-25
6oz	G110-60
10oz	G110
12oz	G110-120
20oz	G110-20



#### Typical Applications:

Sealants, RTV silicone, epoxies, pastes, gels, adhesives...

Rod driven pneumatic guns for 310ml (10oz) and 12oz sized cartridges. Forward and reverse mode. Adjustable air regulator. Hook ring for counter balance. For high viscosity materials where a rod is better suited for forcing out material under high pressure. Order air hose separately.

### Cartridge Guns

Size	Part Code
10oz	100A-110
12oz	100A-120



#### Typical Applications:

Sealants, RTV silicone, epoxies, pastes, gels, adhesives...

Pneumatic hand operated cartridge gun dispensers for silicones, RTVs and sealants. Aluminium & plastic threaded retainers. For use with 10oz, 1/10 gallon size (310ml) sealant tubes. Built-in air regulators. With a rapid air exhaust. Order air hose separately.

### Cartridge Guns

Size	Part Code
10oz	C-110CXO
10oz	100A-110



#### Typical Applications:

Sealants, RTV silicone, polyurethane, mastics, resins...



AD600 battery operated mastic sealant gun for 310ml and 600ml size cartridges. Adjustable speed regulator, residue indicator & reverse action. For sealants, RTVs, greases, pastes, gels. Battery charges in around 30 - 60 minutes & will dispense up to 50 to 75 cartridges from a single charge.

### Battery Caulk Guns

Size	Part Code
310ml/ 600ml	AD600-110



**Typical Applications:**

Sealants, RTV silicone, epoxies, pastes, gels, adhesives...

ADB300 battery operated mastic sealant gun for 310ml cartridges. Forward and reverse action. For sealants, RTVs, greases, pastes, gels. Battery charges in around 3 hours & will dispense up to 50 to 75 cartridges from a single charge. Very cost effective cordless applicator.

### Battery Caulk Guns

Size	Part Code
310ml	ADB300



**Typical Applications:**

Sealants, RTV silicone, epoxies, pastes, gels, adhesives...

ABM series manual hand guns for dual component cartridges. Easy load of the cartridge with lever to pull back plunger. Lightweight yet robust hand guns. For 50ml/ 75ml type epoxy cartridges. All guns for standard square top cartridges. Use ABM25-M10R for round/oval style 10:1 cartridges only.

### Manual Dual Guns

Ratio	Part Code
1:1	ABM-25M1
2:1	ABM-25M2
4:1	ABM-25M4
10:1	ABM-25M10
10:1	ABM-25M10R



**Typical Applications:**

Epoxies, silicones, polyurethanes, potting compounds...



Manual hand guns for larger dual component epoxy type cartridges. Easy load of the cartridge with lever to pull back plunger. Versatile robust manual hand guns. Cartridge loads in the side.

### Manual Dual Guns

Ratios	Size	Part Code
1:1, 2:1, 4:1, 10:1	200ml	BG200-1
1:1, 2:1	300ml	BG300-1
10:1	300ml	BG300-10
4:1, 10:1 Coaxial	380ml	BG380-1
1:1, 2:1, 4:1, 10:1	400ml	BG400-1
1:1, 2:1	600ml	BG3600-1



**Typical Applications:**

Epoxies, silicones, polyurethanes, potting compounds...

Mixpac manual hand guns for dual component cartridges. Easy load of the cartridge with button to pull back plunger. Lightweight yet robust hand guns. Cartridge loads in the top.

### Manual Dual Guns

Ratios	Size	Part Code
1:1, 2:1	200ml	DM200-01
4:1	200ml	DM200-04
10:1	200ml	DM200-10
1:1, 2:1	400ml	DM400-01
4:1	400ml	DM400-04
10:1	400ml	DM400-10



**Typical Applications:**

Epoxies, silicones, polyurethanes, potting compounds...

Pneumatic rod driven gun for 50ml size 1:1 ratio dual cartridges. Easy load of the cartridge with adjustable regulator. Lightweight guns for standard cartridges. Order air hose separately.

### Pneumatic Dual Guns

Size	Ratio	Part Code
50ml	1:1	ADCBA-25D



**Typical Applications:**

Epoxies, silicones, polyurethanes, potting compounds...



Pneumatic rod driven gun for 50ml 1:1, 2:1, 4:1 & 10:1 ratio dual cartridges. Easy load of the cartridge with adjustable regulator knob to set flow rates. Lightweight guns for standard cartridges. Order air hose separately.

### Pneumatic Dual Guns

Size	Ratios	Part Code
50ml	1:1, 2:1, 4:1, 10:1	EDS408M



**Typical Applications:**

Epoxies, silicones, polyurethanes, potting compounds...

Pneumatic rod driven guns for two-part epoxy & resin type cartridges. Easy load of cartridge with adjustable air regulators. Heavy duty robust guns for twin cartridges. Guns that show all mix ratios are supplied with disc kits enabling quick switch over between cartridges types. Order air hose separately.

### Pneumatic Dual Guns

Ratios	Size	Part Code
1:1, 2:1	200ml	CG200-1
1:1, 2:1, 4:1, 10:1	200ml	CG200-3
1:1, 2:1	300ml	CG300-1
1:1, 2:1, 4:1, 10:1	400ml	CG400-2
1:1, 2:1	400ml	CG400-1
1:1, 2:1	600ml	CG600-1



**Typical Applications:**

Epoxies, silicones, polyurethanes, potting compounds...

Pneumatic rod driven light guns for dual component epoxy cartridges. With adjustable air regulators. Very lightweight guns for twin cartridges. Order air hose separately.

### Pneumatic Dual Guns

Ratios	Size	Part Code
1:1, 2:1	200ml	DP200-70-01
4:1	200ml	DP200-70-04
10:1	200ml	DP200-70-10
1:1, 2:1	400ml	DP400-85-01
4:1	400ml	DP400-85-04
10:1	400ml	DP400-85-10



**Typical Applications:**

Epoxies, silicones, polyurethanes, potting compounds...

Foot operated non-timed pneumatic dispenser with adjustable 0-100 psi regulator and gauge. For pastes, gels, adhesives, silicones, solder pastes, etc. Standard unit for pastes or with vacuum suck back version for stringy glues. Supplied with 30cc syringe kit and tip kit.

Pneumatic Dispenser

Part Code	Type
TS924	Standard Dispenser
TS924V	Version with Vacuum



Typical Applications:

Epoxies, silicones, pastes, adhesives, gels, glues, sealants...

Entry level timed liquid dispenser with adjustable vacuum suck-back and 0.01 – 30 second shot timer. With syringe barrel kit and tip selection. Foot pedal control. 0-100 psi output pressure. For all fluids. Make repeat timed deposits or controlled beads.

Pneumatic Dispenser

Part Code	Type
ADL100	220V AC
ADL100E	110V AC



Typical Applications:

Solder paste, adhesives, epoxies, UV cure, silicones, glues...

Dual voltage timed liquid dispenser with adjustable vacuum suck-back and 0.01 – 31 second shot timer. With syringe barrel kit and tip selection. Foot pedal control. 0-100 psi output pressure. For all fluids. Make repeat timed deposits or controlled beads.

Pneumatic Dispenser

Part Code	Type
TS9150	110 - 220V AC



Typical Applications:

Solder paste, adhesives, epoxies, UV cure, silicones, glues...

Small-shot timed liquid dispenser with adjustable vacuum suck-back and 0.01 – 1.0 second adjustable timer. With syringe barrel kit and tip selection. Foot pedal control. 0-100 psi output pressure. For all fluids. Make repeat timed deposits or controlled beads.

Pneumatic Dispenser

Part Code	Type
ADL810	220V AC
ADL810E	110V AC



Typical Applications:

Solder paste, adhesives, epoxies, UV cure, silicones, glues...

Bench top pneumatic dispensing system with vacuum suck-back for repeat shots or controlled beads of most fluids, gels and pastes. With foot pedal, finger switch, syringe kit and tip kit. 0-100 psi air regulator & gauge. LED display. Teach timer mode for fast setup. 0.001 to 99.99 second adjustable timer.

### Pneumatic Dispenser

Part Code	Type
1000T	220V AC
1000TE	110V AC



#### Typical Applications:

Solder paste, adhesives, epoxies, UV cure, silicones, glues...

Digital timed dispenser with LED display. 0.001 - 99.99 second timer. Vacuum suck back. Teach mode. Features a self-repeating timer mode for automatic repeat pulsing without having to press the foot pedal. For a measured deposit of liquid to be dispensed each time at set intervals automatically.

### Pneumatic Dispenser

Part Code	Type
2000T	220V AC
2000TE	110V AC



#### Typical Applications:

Solder paste, adhesives, epoxies, UV cure, silicones, glues...

Compact bench pneumatic dispenser with LCD display, vacuum suck-back, shot counter. TS250 for 0-100 psi general material use. TS255 with low pressure 0-15 psi for just watery fluids. Dots or controlled beads. 0.02 – 60 sec/ timer. Rear I/O port to accept 5-24 V DC signal from PLC.

### Pneumatic Dispenser

Part Code	Type
TS250	0-100 PSI
TS255	0-15 PSI



#### Typical Applications:

UV cure, Cyanoacrylates, solvents, anaerobics, glues, gels..

Digital dispensing system with timer memory storage (up to 10), teach function for quick setup, shot counter, dual air outlet, vacuum suck back. TS350 for 0-100 psi general use and TS355 0-15 psi for watery liquids. Adjustable timer 0.008 to 60 seconds. Rear I/O port to accept 5-24 V DC signal from PLC.

### Pneumatic Dispenser

Part Code	Type
TS350	0-100 PSI
TS355	0-15 PSI



#### Typical Applications:

Solder paste, adhesives, epoxies, UV cure, silicones, glues

Electric peristaltic pump system for making repeat deposits or continuous flow of most low viscosity fluids including Cyanoacrylate adhesives and solvents. Does not require any air supply. Comes with a kit of tubes and dispense nozzles. Forward/reverse modes. LED display. Electric finger switch.

### Electric Dispenser

Part Code	Type
DISP5600	220V AC
DISP5600E	110V AC



#### Typical Applications:

Cyanoacrylates, solvents, UV cure, primers, activators.

Automate a dispensing application using a benchtop robot. High speed systems for applying an adhesive, paste, epoxy, silicone or lubricant. Dots, lines, arcs & circles. Benchtop systems with high resolution and accuracy. 3 or 4 axis versions. Supplied with full accessories and training. Internal memory to store up to 255 programs. Industry leading desktop dispensing robots.

### Desktop Robots

Size	Axis	Code
200 x 200 x 50mm	3	J2203N
200 x 200 x 50mm	4	J2204N
300 x 320 x 100mm	3	J2303N
300 x 320 x 100mm	4	J2304N
400 x 400 x 100mm	3	J2403N
400 x 400 x 100mm	4	J2404N
510 x 510 x 150mm	3	J2503N
510 x 510 x 150mm	4	J2504N



#### Typical Applications:

Solder paste, adhesives, epoxies, UV cure, silicones, glues...

The AD200DY is a versatile system to be used as a desktop or gantry robot. Make form-in-place gaskets, adhesives, potting, coating, filling. With control module, teach pendant & gantry. Work area 200 x 200mm - resolution of 0.001mm. The teach pendant supports industry standard software to store up to 100 programs (400,000 points).

### Gantry Robots

Size	Axis	Type	Code
200 x 200 x 50mm	3	220V	AD200DY
200 x 200 x 50mm	3	110V	AD200YE
		AC	



#### Typical Applications:

Solder paste, adhesives, epoxies, UV cure, silicones, glues...



Bench top dispenser for adhesives, fluids & gels to circular products under 152mm dia. This rotary table applies a circular pattern on areas that are difficult to access. The tilting Z-axis allows dispensing on an angle. Fully adjustable rotation speed, circle diameter & dispense time. Dispense from barrels, mounted on the Z-axis. The Z-axis tilt is easily adjusted.

### Rotary table

Part Code	Type
ADL-300	220V AC
ADL-310	110V AC

Z Travel: 50mm  
 Speed: 300 RPM  
 Max Pressure: 100psi  
 310 x 215 x 85mm



**Typical Applications:**

UV cure, Cyanoacrylates, solvents, anaerobics, glues, gels..

Hand operated valve for applying low to medium viscosity fluids as cyanoacrylates, solvents, UV cure, anaerobic, primer & activators. Maintenance free replaceable tubes. Takes a direct feed of fluid from a syringe, cartridge or pressure pot.

### Manual Pinch Valve

Part Code	Wetted Parts
TS1201	Polyethylene

Length: 127mm  
 Width: 34mm  
 Max Pressure: 60psi  
 Viscosity: 1-45k cps

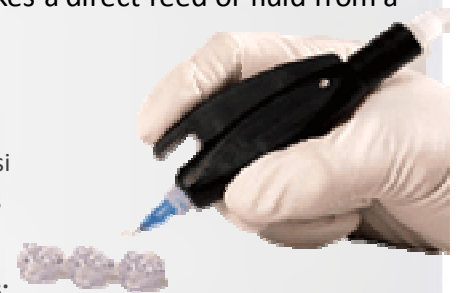

**Typical Applications:**

UV cure, Cyanoacrylates, solvents, anaerobics, glues, inks..

Hand operated diaphragm valves for the application of low to medium viscosity fluids such as cyanoacrylates, solvents, inks, UV cure, anaerobic, primers and activators. Takes a direct feed of fluid from a syringe, cartridge or pressure pot. UHMW/ Teflon for Cyanoacrylates, Delrin for UV cure.

### Manual Lever Valve

Part Code	Wetted Parts
TS5623HU	UHMW
TS5623HD	Delrin
TS5623HT	Teflon

Length: 88mm  
 Width: 27mm  
 Max Pressure: 70psi  
 Viscosity: 1-50k cps



**Typical Applications:**

UV cure, Cyanoacrylates, solvents, anaerobics, glues, gels..

Hand operated diaphragm disc valve for the application of low to medium viscosity fluids such as cyanoacrylates, solvents, inks, UV cure, anaerobic, primers and activators. Takes a direct feed of fluid from a syringe, cartridge or pressure pot.

### Manual Lever Valve

Part Code	Wetted Parts
ADL-200CAM	Teflon

Length: 159mm  
 Width: 45mm  
 Max Pressure: 50psi  
 Viscosity: 1-5k cps



**Typical Applications:**

UV cure, Cyanoacrylates, solvents, anaerobics, glues, gels..

Hand held needle valve for precise beads applications of low to medium viscosity fluids. The hand lever opens the needle allowing fluids to flow; when it is released the needle closes. Doesn't require the use of a time/pressure dispenser. Direct fluid feed from pressure pot, cartridge reservoir or syringe.

### Manual Lever Valve

Part Code	Wetted Parts
ADL2030	Steel, Aluminium

Length: 150mm  
 Width: 18mm  
 Max Pressure: 60psi  
 Viscosity: 1-30k cps

#### Typical Applications:

UV cure, primers, solvents, inks, lubricants, resins..



Pneumatic operated pinch tube valve. Operates from a dispenser/ controller for timed deposits or beads of most low to medium viscosity fluids. For cyanoacrylates, UV cure, anaerobic, glue, epoxy, solvents and activators.

### Pinch Tube Valve

Part Code	Wetted Parts
TS1212	Polyethylene

Length: 83mm  
 Width: 40mm  
 Max Pressure: 60psi  
 Viscosity: 1-45k cps

#### Typical Applications:

Cyanoacrylates, UV cure, anaerobics, two-part adhesives, solvents, glues...

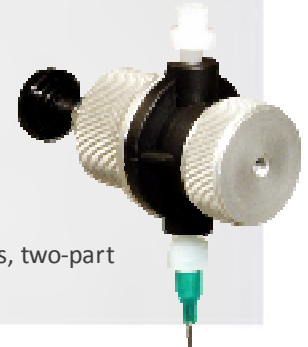

Pneumatic operated diaphragm valves for use with most low to medium viscosity fluids. Use UHMW and Teflon for Cyanoacrylates, solvents, primers, inks. Use Delrin for UV cure and anaerobic. Use stainless steel for lacquer's. Low maintenance design.

### Diaphragm Valves

Part Code	Wetted Parts
TS5620HU	UHMW
TS5621HD	Delrin
TS5622VU	UHMW
AD5622VT	Teflon
TS5622VT	Teflon
TS5622VD	Delrin
TS5622-DVD	Stainless Steel

Length: 88mm  
 Width: 27mm  
 Weight: 118g  
 Max Pressure: 70psi  
 Viscosity: 1-50k cps

#### Typical Applications:

To dispense a wide range of shot sizes of low viscosity fluids such as cyanoacrylates, anaerobics, liquid fluxes, solvents, UV-cure adhesives, resins and lacquers.

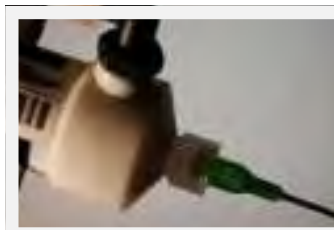

Needle valves for rapid micro dots of UV cure adhesives, inks and lubricants. Needle shut off point is close to the tip eliminating dead space and prevent drips. Stroke control for fine-tuning flow. Use these valves with any air operated dispenser and with any pressure pot feed system.

## Needle Valves

Part Code	Body Type
TS5420	Aluminium
TS5420SS	Stainless Steel
CV629	Aluminium

Length: 112mm  
 Width: 28mm  
 Weight: 227g  
 Max Pressure: 300psi  
 Viscosity: 1-100k cps

### Typical Applications:

Microdots of low viscosity fluids such as: solvents, inks, oils, activators, primers; the microdots of UV adhesive used in medical device manufacturing.



Air operated spool valves for use with medium to high viscosity materials such as silicones, sealants, RTVs, pastes, gels and glues. TS5322 for materials 5,000 to 1 million cps, max fluid pressure 500psi. TS941 for 5,000 to 3 million cps and max fluid pressure of 2500psi. Use with TS500R controller.

## Spool Valves

Ratios	Body Type	Inlet
TS5322	Aluminium	1/8"
TS5322D	Delrin	1/8"
TS941	Stainless Steel	3/8"
TS941A	Stainless Steel	1/4"
AD725D	Stainless Steel	1/8"
AD730D	Aluminium	1/8"

TS5322/ TS941  
 Length: 102mm/ 119mm  
 Width: 25mm/ 38mm  
 Weight: 141g/ 726g  
 Max Pressure: 500/ 2500psi  
 Viscosity: 5-1000k/ 5-3000k cps

### Typical Applications:

Suitable for moisture sensitive adhesive when utilizing supplied oiler. Can be used in a wide range of applications such as flux paste, grease, RTV Silicone, UV cure gel, solder mask, gasketing.



Motor driven auger valve provides volumetric dispense rates of pastes, epoxies, gels. etc. for highest levels of repeatability. Replaceable feed paths for zero cleanup and no maintenance. Changes in material viscosity, curing or temperature will not affect shot size. Supplied with 6, 8 and 16 pitch feed-paths. For viscous materials 30,000 cps to 1.3million cps. Minimum shot size of 0.00003cc. Reverse function eliminates oozing or drips. Use with TS500R controller.

## Auger Valves

Part Code	Wetted Parts
TS5000DMP	Acetal, Delrin

### Typical Applications:

Solder paste, die attach, surface mount adhesive, chip encapsulation, dam writing, two-part epoxy, UV adhesive.

Length: 149mm  
 Width: 90mm  
 Weight: 350g  
 Max Fluid Pressure: 30psi  
 Min Shot Size: 0.00003cc  
 Repeatability: ±0.20%



Fine mist spray valves for oils, inks, primers, activators, glues and lubricants. Round pattern nozzles in 3 sizes or oval fan type in 3 sizes. Suitable for marking, bonding, priming and coating. Adjustable stroke feature for flow control. Minimal overspray. Use with TS500R controller.

Spray Valves

Part Code	Type	Nozzle ID
TS5520	Round	0.046"
TS5540-014R	Round	0.014"
TS5540-028R	Round	0.028"
TS5540-046R	Round	0.046"
TS5540-014F	Fan	0.014"
TS5540-028R	Fan	0.028"
TS5540-046R	Fan	0.046"

TS5520/ TS5540  
 Length: 107mm  
 Width: 28mm  
 Weight: 136g/ 336g  
 Max Pressure: 100psi  
 Viscosity: 1-1k cps/ 1-5k cps

**Typical Applications:**

To spray fine mist of low viscosity fluids such as: conformal coating, solvent, oil, water based glues, etc.



Precision high pressure needle dispensing valve with stainless steel body. Double acting, requires air pressure pulse to open and air pressure pulse to close. Use with controller **VCE1195N**. Adjustable flow control. Highly accurate dispense valve.

Double Acting Valves

Part Code	Wetted Parts
ADH3030	Type 304 Stainless Steel

Length: 145mm  
 Width: 30mm  
 Weight: 408g  
 Max Pressure: 500psi  
 Viscosity: 1-100k cps

**Typical Applications:**

Applications such as flux paste, grease, RTV Silicone, UV cure gel, solder mask, single epoxy, grease..



Precision high pressure needle dispensing valve with aluminium body. Single acting, requires just air pressure pulse to open and it spring closes. Use with controller **TS500R**. Adjustable flow control. Highly accurate and compact dispense valve.

Double Air Valves

Part Code	Wetted Parts
ADH3030	Type 304 Stainless Steel

Length: 100mm  
 Width: 25mm  
 Weight: 215g  
 Max Pressure: 200psi  
 Viscosity: 1-50k cps

**Typical Applications:**

Applications such as water based glues, grease, inks, paints, primers, activators, grease..

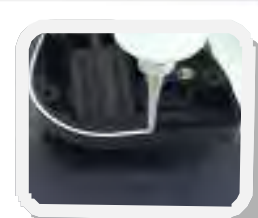
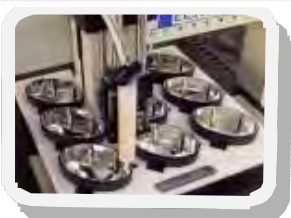



Stainless steel double air activated dispense valve for mixing two part materials such as epoxies, silicones and polyurethanes. Part A and Part B are fed under pressure to the valve, it delivers them into the static mixer nozzle where they are mixed. This valve mixes ratios 3:1 or under. Adjustable.

### Epoxy Mixing Valve

Part Code	Wetted Parts
AD324D	304 Stainless Steel

Min Shot: 0.01ml  
 Length: 115mm  
 Width: 35mm  
 Weight: 418g

#### Typical Applications:

Rapid dots or controlled beads of 2-part materials less than 3:1 mix ratio such as epoxies, silicones and PU's.



Stainless steel double air activated dispense valve for mixing two part materials such as epoxies, silicones and polyurethanes. Part A and Part B are fed under pressure to the valve, it delivers them into the static mixer nozzle where they are mixed. This valve mixes ratios 2:1 or under. Adjustable.

### Epoxy Mixing Valve

Part Code	Wetted Parts
AD1919	304 Stainless Steel

Min Shot: 0.01ml  
 Length: 160mm  
 Width: 40mm  
 Weight: 235g

#### Typical Applications:

Rapid dots or controlled beads of 2-part materials less than 2:1 mix ratio such as epoxies, silicones and PU's.

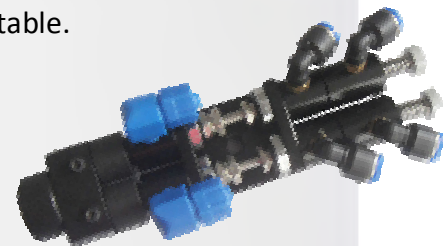

Stainless steel double air activated dispense valve for medium viscosity pastes and gels. Adjustable flow control stroke. A reliable double acting valve, requires air pulse to open and air pulse to close. Use the dispensing controller part **VCE1195N**. Stainless steel wetted parts. 1/4" threaded inlet.

### Paste Dispensing Valve

Part Code	Wetted Parts
AD3075	304 Stainless Steel

Min Shot: 0.01ml  
 Length: 160mm  
 Width: 40mm  
 Weight: 235g

#### Typical Applications:

Fast repeat dots of pastes, gels and liquids. Up to 600 shots per minute.

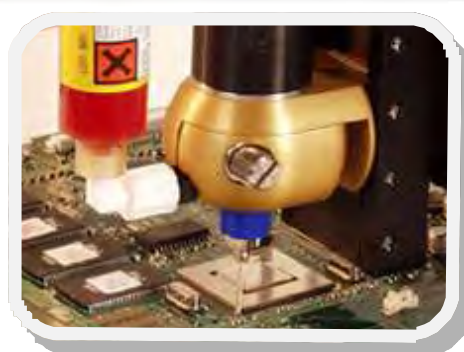

Digital controller for cycling valves by footswitch or via PLC with the I/O port. TS500R controls all pneumatic valves, spray valves and rotary auger types. 0.008 - 60 second timer. Built in timer memory. Low air pressure alarm. Digital LCD display. Variable power 110-220V AC.

### Valve Controller

Part Code	Type
TS500R	Universal Valve Controller

Width: 254mm  
 Depth: 191mm  
 Height: 102mm  
 Weight: 2.6kg  
 Timing: 0.008-60 second  
 Tolerances: +/- 0.001%



The VC1195N is a 4-way valve controller that can be used to control one or two valves simultaneously. The controller is suitable for all valves identified as requiring or optionally accepting a 4-way controller. Double-acting valves where air is used to open and then air to close the piston.

### Valve Controller

Part Code	Type
VCE1195N	220V AC
VC1195A	110V AC

Width: 266mm  
 Depth: 210mm  
 Height: 70mm  
 Weight: 1.9kg  
 Timing: 0.01-30 second  
 Tolerances: +/- 0.001%



Digital controller for cycling valves by footswitch or via PLC with the I/O port. 3000T controls all pneumatic valves such as pinch tube, diaphragm, needle and spool. 0.001 - 99.99 second timer. Built in timer memory. Highly accurate timer. Operates by footswitch control.

### Valve Controller

Part Code	Type
3000T	220V AC
3000TE	110V AC

Width: 281mm  
 Depth: 210mm  
 Height: 70mm  
 Weight: 2.5kg  
 Timing: 0.001-99 second  
 Tolerances: +/- 0.001%



Pressure pots for use with many low to medium viscosity fluids and adhesives. Supplied with fluid lines and fittings for feeding the liquid to dispense valves. Adjustable air regulators to set flow rates. LS versions have electric low fluid level sensors. All tanks are CE certified. Use low pressure version for watery liquids such as Cyanoacrylates and solvents.

### Pressure Pots

Code	Size	Pressure	Material
TS1215	0.5 Litre	0-60 PSI	Aluminium
TS2220	2.0 Litre	0-75 PSI	Stainless
TS2215	2.0 Litre	0-15 PSI	Stainless
TS2250	5.0 Litre	0-75 PSI	Stainless
TS2215	5.0 Litre	0-15 PSI	Stainless
TS1258	5.0 Litre	0-100 PSI	Aluminium
TS1262	7.6 Litre	0-60 PSI	Stainless
TS1263	11.5 Litre	0-60 PSI	Stainless
TS1265	19 Litre	0-60 PSI	Stainless
TS21LS	10 Litre	0-75 PSI	Level sensor



CE certified  
Adjustable regulators  
Fluid lines included  
Low pressure for CAs  
Low maintenance

#### Typical Materials:

To feed glues, paints, primers, activators, adhesives, oils, solvents, lubricants and more.

Pressure feed systems for liquids, gels and pastes from industry standard plastic cartridges and silicone tubes. Dispense direct using nozzles or as a fluid feed to dispense valves. Includes metal body sleeve, air cap and airline hose with quick connect fitting. Regulators available to control air pressure into cap.

### Cartridge Reservoirs

Part Code	Size	Material
AD-6OZ	6oz (177ml)	Steel
AD-8OZ	8oz (237ml)	Steel
AD-10OZ	10oz (310ml)	Steel
AD-12OZ	12oz (355ml)	Steel
TS918-25CS	2.5oz (75ml)	Aluminium
TS918-60CS	6oz (177ml)	Aluminium
TS918-80CS	8oz (237ml)	Aluminium
TS918-120CS	12oz (355ml)	Aluminium

Ideal for pastes and gels  
Includes air hose & connector  
Supplied complete  
Regulators available  
Aluminium version are slotted  
Industrial grade parts



#### Typical Materials:

To feed silicones, RTVs, gels, pastes, epoxies, glues, inks, primers, sealants, glues, solder pastes and more.

### Filter Regulator

Part Code	Type
TSD800-6FR	0-100 PSI Gauge



Use a filter regulator with any cartridge reservoir system. Allows the pressure to be adjusted to suit the material being dispensed. Regulators can be used with our standard air feed tubing and push-fit fittings.

Pressure feed systems for liquids, gels and pastes from industry standard plastic cartridges and silicone tubes. Dispense direct using nozzles or as a fluid feed to dispense valves. Select the metal body sleeve, air cap and airline hose with quick connect fitting. Kits to make up a fluid reservoir feed system.

**Cartridge Reservoirs**

Part Code	Size	Type
918-030-000	2.5oz (75ml)	Retainer
918-031-000	6oz (177ml)	Retainer
918-034-000	8oz (237ml)	Retainer
918-032-000	12oz (355ml)	Retainer
110-2	10oz (310ml)	Retainer
101-20R	20oz (600ml)	Retainer
918-001-004	2.5,6,8,12oz	Air Cap
918-030-036	10, 20oz	Air Cap
101-20A	20oz	Adapter
918-000-002	All Sizes	Air Hose
534	All Sizes	Connector
918-001-007	2.5,6,8,12oz	Cap Gasket
533	All Sizes	Connector



**Typical Materials:**

To feed silicones, RTVs, gels, pastes, epoxies, glues, inks, primers, sealants, glues, solder pastes and more.

Benchtop stands, brackets, rods, clamps and fittings for use with cartridge retainers syringe barrels and dispense valves. Build a system to allow for hands free dispensing. Or to mount a valve within a production cell or assembly line. All systems start with the base stand.

**Stands & Brackets**

Part Code	Description
918-033-000	Base Stand & Upright Rod
918-000-012	Rod Clamp Assembly
918-000-011	Syringe Bracket Assembly
918-000-013	TS941/TS941 Valve Bracket
918-110-004	310ml Bracket
918-000-039	20oz Bracket
918-000-009	Mounting Rod 6" Long
918-000-007	Cartridge Mounting Bracket
918-000-016	Spool Valve Bracket
918-000-048	Valve Mounting Bracket
1212-000-008	Valve Mounting Rod
918-000-002	Production Master Air Hose

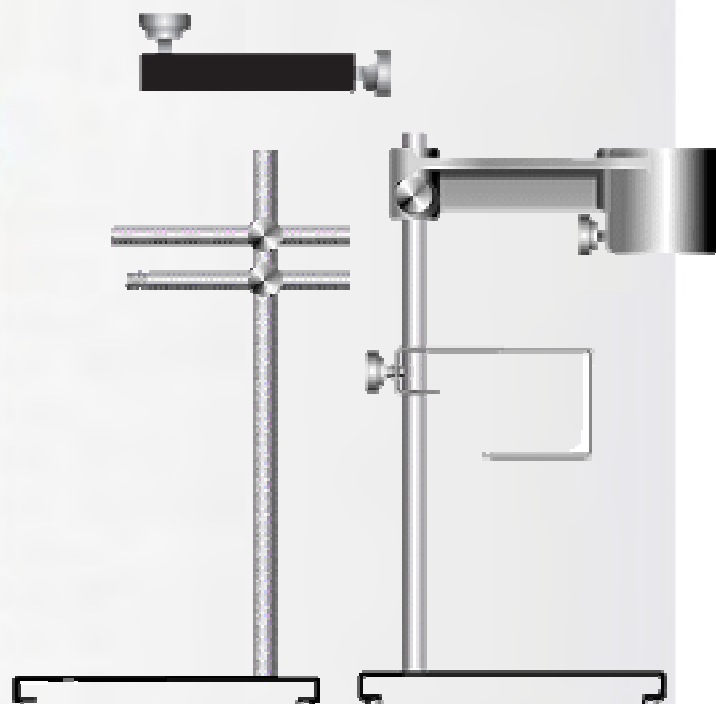

Bench stands provide a convenient way to hold a syringe barrel on a work top. SH300 is a 2-piece product. TS100 is a single metal part. Both stands hold all sized barrels from 3cc to 55cc.

### Manual Lever Valve

Part Code	Type
SH300	Metal all size barrels
TS100	Metal all size barrels



Bench stands provide a convenient way to hold a syringe barrel on a work top. SH300 is a 2-piece product. TS100 is a single metal part. Both stands hold all sized barrels from 3cc to 55cc.

### Syringe Barrel Racks

Code	Type
SYR19B	Metal All Size Barrels
SR03-90W	Plastic 3cc Size x 90
SR05-60W	Plastic 5cc Size x 60
SR10-40W	Plastic 10cc Size x 40
SR30-24W	Plastic 30/55cc Size x 24

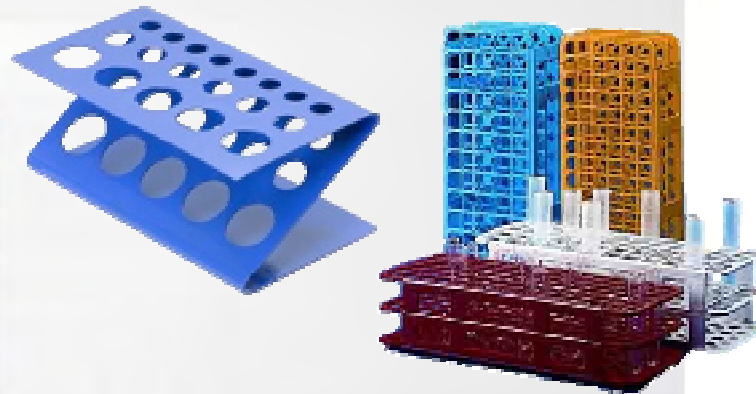

Vacuum pick & place pencils for hand placement of small components. Connect to regulated air supply or use TS350 bench dispenser. Soft silicone suction cups will not scratch or damage sensitive surfaces, equipment or parts. Can be used in temperatures from -55° C to 230° C.

### Vacuum Pickup Tools

Part Code	Description
TS8120	Manual Vacuum Pickup Tool
VPPE511-LF	Electric Vacuum Pickup Tool
VPP803-LF	Manual Vacuum Pickup Tool
TS1208	ESD Safe Vacuum Pickup Tool
VACKIT	Mixed Kit of Vac Rubber Cups
560046-NH	Pen for VPPE511-LF
560046	Pen for VPP803-LF



Pneumatic systems for efficient transfer of materials from cartridge reservoirs to syringe barrels. The filling process is to the bottom end of the barrel which reduces air entrapment and eliminates mess. This range includes an adjustable stand to hold the cartridges which is placed on the workbench. Systems include the cartridge retainer, air cap, airline hose, cartridge, plunger, filling adapter and syringe kit.

Barrel Loaders

Part Code	Size	Type
TS918-25	2.5oz	Retainer, stand, switch
TS918-60	6oz	Retainer, stand, switch
TS918-80	8oz	Retainer, stand, switch
560548-M	10oz	Retainer, stand, switch
TS918-120	12oz	Retainer, stand, switch
TS918-20	20oz	Retainer, stand, switch
TS918-32	32oz	Retainer, stand, switch



Automatic systems for efficient transfer of materials from cartridge reservoirs to syringe barrels. The filling process is to the bottom end of the barrel which reduces air entrapment and eliminates mess. This range includes an adjustable stand to hold the cartridges which is placed on the workbench with a digital timed dispenser so that each deposit set can be the same. Ideal for repeat syringe filling.

Barrel Loaders

Part Code	Size	Type
1000-25D	2.5oz	Dispenser, fill station
1000-6D	6oz	Dispenser, fill station
1000-8D	8oz	Dispenser, fill station
1000-10D	10oz	Dispenser, fill station
1000-12D	12oz	Dispenser, fill station
1000-20D	20oz	Dispenser, fill station



Manual pail pump to extract material from large pails. Suitable only for 5-gallon straight walled pails containing fluids such as grease, paste, silicone and other such materials. The hand lever pumps the fluid to bottom fill 2.5oz, 6oz, 8oz, 12oz, 20oz and 32oz size cartridges & syringe barrels in sizes 3cc to 55cc. An internal follower plate ensures that most material is used.

Barrel Loaders

Part Code	Size	Type
560092B	5 Gallon	Manual Pail Pump



High-density industrial grade syringe barrels. Silicone-free and chloride free plastics. Luer lock leak free tip attachment. Safe for use to 100 psi with all air powered dispensers and syringe guns. 5 sizes and 3 colours. Use black for UV cure adhesives. Supplied in sealed packs of 50, 500 or 1000.

### Barrels Only

Size	Natural	Black	Amber
3cc	903-N	903-B	903-D
5cc	905-N	905-B	905-D
10cc	910-N	910-B	910-D
30cc	930-N	930-B	930-D
55cc	955-N	955-B	955-D

Safe to 100psi  
Silicone Free  
Chlorine Free  
Zero Draft



### Typical Applications:

Safe to use with sealants, silicones, adhesives, glues, pastes, solvents, epoxies, RTVs, UV, fluxes & more.

Syringe pistons for industrial barrels. Silicone-free and industrial safe to 100 psi. Use white for general purpose applications, blue for easy flow, red for thick stringy thick gels. A piston will ensure no material is left in the barrel and prevent suck back of liquids. Supplied in sealed packs of 50, 500 or 1000.

### Pistons Only

Size	White	Red	Blue
3cc	903-WW	903-SWR	7030007BL
5cc	905-WW	905-SWR	7050007BL
10cc	910-WW	910-SWR	7100007BL
30/55cc	930-WW	930-SWR	7300007BL

Safe to 100psi  
Silicone Free  
Chlorine Free  
Zero Draft



### Typical Applications:

Safe to use with sealants, silicones, adhesives, glues, pastes, solvents, epoxies, RTVs, UV, fluxes & more.

The same number of barrels and pistons are contained in each box. Part codes are for barrel colour and piston colour. Clear, black or amber barrels packed with white, red or blue pistons.

### Barrels & Piston Kits

Size	CLR/WHT	CLR/RED	CLR/BL	BLK/WHT	BLK/RED	BLK/BL	AMB/WH	AM/BRD	ABM/BL
3cc	903-NW	903-NWR	903-NEF	903-BW	903-BWR	903-BEF	903-DW	903-DWR	903-BEF
5cc	905-NW	905-NWR	905-NEF	905-BW	905-BWR	905-BEF	905-DW	905-DWR	905-BEF
10cc	910-NW	910-NWR	910-NEF	910-BW	910-BWR	910-BEF	910-DW	910-DWR	910-BEF
30cc	930-NW	930-NWR	930-NEF	930-BW	930-BWR	930-BEF	930-DW	930-DWR	930-BEF
55cc	955-NW	955-NWR	955-NEF	955-BW	955-BWR	955-BEF	955-DW	955-DWR	955-BEF



Syringe barrel end caps provide an airtight seal to flange end of a barrel. For storing when filled or when in transit. End caps seal the barrel top. Supplied in sealed packs of 50, 500 or 1000.

### Barrel End Cap Seals

Size	Orange	Blue	Green
3cc	903-ECO	703000CB	8001034
5cc	905-ECO	705000CB	8001035
10cc	910-ECO	710000CB	8001036
30/55cc	930-ECO	730000CB	8001037



Tip caps provide a leak free seal to the end of all luer lock and luer slip syringe barrels. Available in orange, clear, green, blue and black. Featuring a double helix female luer lock thread. Silicone-free plastics. Also for use with any male luer lock fitting or for sealing the end of any dispensing valve.

### Round Tip Cap Seals

Colour	Part Code
Orange	800-ORTC
Black	800-BLTC
Green	AD900-GNTC
Clear	900-WHTC
Blue	AD900-BTC



Tip caps provide a leak free seal to the end of all luer lock and luer slip syringe barrels. Available in orange, clear, white and black. Featuring a double helix female luer lock thread. Silicone-free plastics. Also for use with any male luer lock fitting or for sealing the end of any dispensing valve.

### Straight Tip Cap Seals

Colour	Part Code
Orange	7015LLPK
Black	7015LLBPK
White	7015LLWPK
Clear	7015LLCPK





Plastic tip covers push over the tip to provide a safe seal. Suitable for all tips up to 2" long. Silicone free plastics. Red tip covers seal the ends of 14, 16 and 18 gauge tapered tips. Supplied in sealed packs of 50 or 1000.

## Tip Shields

Part Code	Type
7016TC	Clear Plastic Tip Shield
7016TTC	Red Rubber Tip Seal

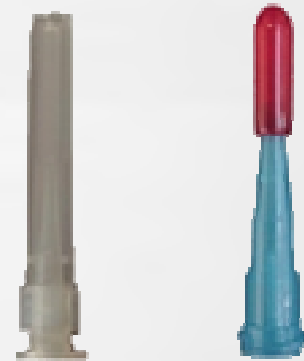

Provides the air link between a pneumatic dispenser and syringe barrel. One piece moulded head with O-ring. Clear flexible air hose with dispenser quick connect fitting. 6mm OD tubing or 4mm OD tubing. Safe for use to 100 psi. Silicone free plastic parts.

## Barrel Adapters

Size	3 ft. 6mm	6 ft. 6mm	3 ft. 4mm	6 ft. 4mm
3cc	70303RHB	70306RHB	70303RHB4	70306RHB4
5cc	70503RHB	70506RHB	70503RHB4	70506RHB4
10cc	71003RHB	71006RHB	71003RHB4	71006RHB4
30/55cc	73003RHB	73006RHB	73003RHB4	73006RHB4



Provides the air link between a pneumatic dispenser and syringe barrel. One piece moulded head with O-ring. Clear flexible air hose with dispenser quick connect fitting. 6mm OD tubing or 4mm OD tubing. Safe for use to 100 psi. Silicone free plastic parts.

## Barrel Adapter Spares

Size	Part Code	Material
3cc	703R	EPR O-Ring
5cc	705R	EPR O-Ring
10cc	710R	EPR O-Ring
30/55cc	730R	EPR O-Ring
3cc	703RV	Viton O-Ring
5cc	905RV	Viton O-Ring
10cc	910RV	Viton O-Ring
30/55cc	930RV	Viton O-Ring
All	533Y	Male Connector
All	1400	Steel Crimp



Rubber O-rings for syringe barrel adapter assemblies. EPR rubber standard or Viton rubber for solvents. Supplied in sealed packs of 10.

### Barrel Adapter O-Rings

Size	EPR	Viton
3cc	P3015EPK	P3019VPK
5cc	P3016EPK	P3020VPK
10cc	P3017EPK	P3021VPK
30/55cc	P3018EPK	P3022VPK

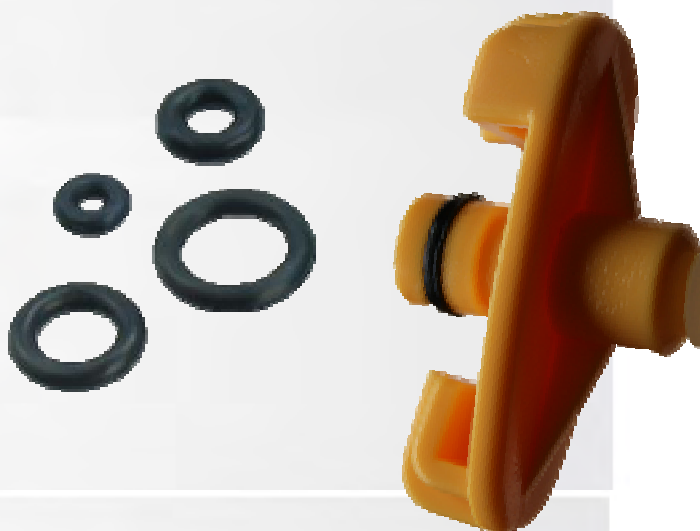

Inline filter trap used in barrel adapter assembly to prevent liquid suck back into dispenser from the barrel. Supplied with clamps and luer fittings. For 6mm OD air tube and 4mm OD.

### Barrel Adapter Traps

Part Code	Type
1400-FTR	6mm In-Line Filter Trap
881-000-000	4mm In-Line Filter Trap

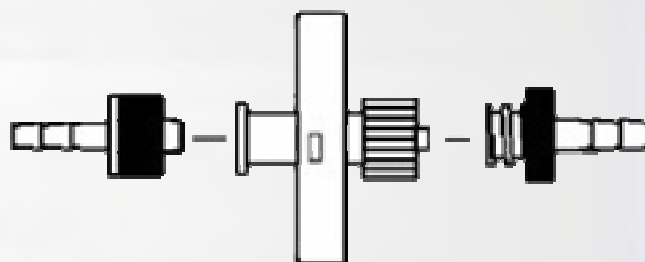

Cleanroom filter muffler fitting. Filters air output to 0.5 microns. Fits into rear air exhaust port on most dispensers. Eliminates contamination and noise.

### Dispenser Muffler

Part Code	Description
560024	Dispenser Filter Muffler

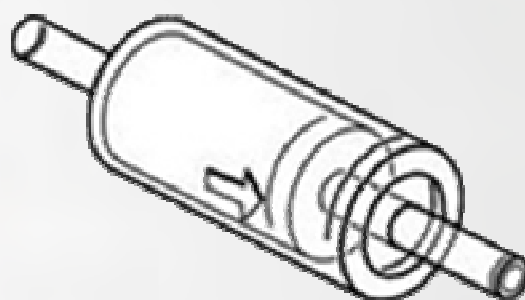

Plastic tube crimps for use with 6mm and 4mm OD adapter air feed tubing. Use with adapter assemblies when handling low viscosity fluids. Locks air pipe & creates a vacuum to barrel when changing tips.

### Dispenser Muffler

Part Code	Description
5606034	Dispenser Filter Muffler



Unmarked 400 series manual hand syringe assemblies in clear high-density polypropylene with black rubber pistons & plastic push rods. Barrels are unmarked with luer lock twist-on tip attachment. Full assemblies. Luer lock twist-on tip attachment. Luer slip push-on for 1cc size only.

### Unmarked Syringes

Part Code	Size	Type
MS401L-1	1cc	Luer Slip Assembly
MS403LL-1	3cc	Luer Lock Assembly
MS406LL-1	6cc	Luer Lock Assembly
MS410LL-1	10cc	Luer Lock Assembly
MS435LL-1	35cc	Luer Lock Assembly
MS460LL-1	60cc	Luer Lock Assembly



### Typical Applications:

Safe to use with sealants, silicones, adhesives, glues, pastes, epoxies, RTVs, thread lockers, fluxes & more.

Unmarked 400 series manual hand syringe assemblies in clear high-density polypropylene with black rubber pistons & plastic push rods. Barrels are unmarked with luer lock twist-on tip attachment. Individual parts. Luer lock twist-on tip attachment. Luer slip push-on for 1cc size only.

### Syringe Components

Size	Syringe Barrel	Plunger Rod	Rubber Piston	Plastic Piston
1cc	401L-1	401L-4	401L-2	n/a
3cc	403LL-1	403L-4	403L-2	403L-7
6cc	406LL-1	406L-4	406L-2	406L-7
10cc	410LL-1	410L-4	410L-2	410L-7
35cc	435LL-1	435L-4	435L-2	435L-7
60cc	460LL-1	460L-4	460L-2	n/a



Graduated syringes for use with adhesives, gels and pastes. Luer lock twist on or luer slip push on tip attachment. All syringes are supplied pre-assembled in sealed packs.

### Graduated Syringes

Size	Luer Lock	Luer Slip
1ml	n/a	MS401L-1G
3ml	MS403LL-G	MS403L-1G
5ml	MS405LL-1G	MS403L-1G
10ml	MS410LL-1G	MS410L-1G
20ml	MS420LL-1G	MS420L-1G
30ml	MS430LL-1G	MS430L-1G
50/60ml	MS450LL-1G	MS450L-1G

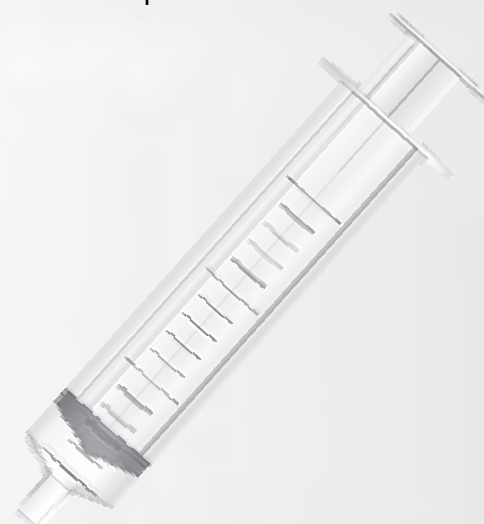

The new manual syringe assemblies provide simple and quick dispensing solutions without the need for compressed air. Barrels and plungers are moulded from polypropylene resin and are compatible with a wide range of dispensing fluids. Pistons are made from thermoplastic rubber and can be supplied dry or with medical grade silicone lubrication to ease insertion. Can be used with black or amber barrels.

### Manual Barrels

Size	Barrel	Piston	Plunger
3cc	7030LL1NPK	7030002MPK	7030004PPK
5cc	7030LL1NPK	7050002MPK	7050004PPK
10cc	7100LL1NPK	7100002MPK	7100004PPK
30cc	7300LL1NPK	7300002MPK	7300004PPK

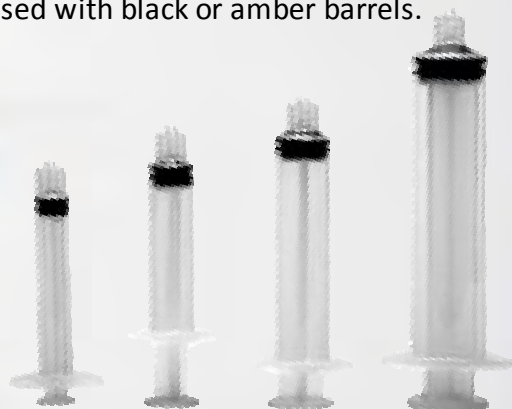

Dispensing bottles with luer-lok caps to accept all standard precision tips. Simple twist-on and twist-off tip attachment. Flexible plastic bottles to apply liquids and gels. These products are supplied in sealed packs and can be used with adhesives and other assembly fluids. Use a tip cap to seal off the bottle cap.

### Luer Lock Bottles

Size	Bottle & Cap	Bottle only	Cap only
1/2oz	AD50BC	n/a	n/a
3/4oz	AD75BC	AD75B	AD75C
1oz	AD1BC	n/a	n/a
2oz	AD2BC	AD2B	AD2C
4oz	AD4BC	AD4B	AD4C
8oz	AD8BC	AD8B	AD8C



Liquid is placed into the bottle body, a spring loaded cap is attached. When the nib is pressed against a surface, liquid flows. Lift nib from surface to instantly stop flow. Use with most watery liquids including fluxes, primers, activators, etc.

### Spring Nib Bottles

Size	Material	Bottle & Cap	Cap only
2oz	Clear Plastic	FV-0300	n/a
2oz	ESD Aluminium	FV-0400	n/a
4oz	Clear Plastic	FV-0500	FV-0500-CAP



Liquid is placed into the pen body, a spring loaded cap is attached. When the nib is pressed against a surface, liquid flows. Lift nib from surface to instantly stop flow. Use with watery liquids such as primers.

### Spring Nib Pens

Size	Material	Pen & Cap
10ml	Plastic Body	FV-0100
10ml	ESD Aluminium	FV-0200
10ml	Aluminium	FPA-10
45ml	Plastic Body	FV-0600



These replacement acrylic or polyester nibs are used with the spring loaded pens and bottles. They push into the cap assembly. Supplied in sealed packs.

### Spring Nib Spares

Part Code	Material	Style
381-8425-AC	Acrylic	Chisel
381-8425-AB	Acrylic	Bullet
381-8425-AP	Acrylic	Point
381-8425-PC	Polyester	Chisel
381-600-PB	Polyester	Blunt (FV-0600)

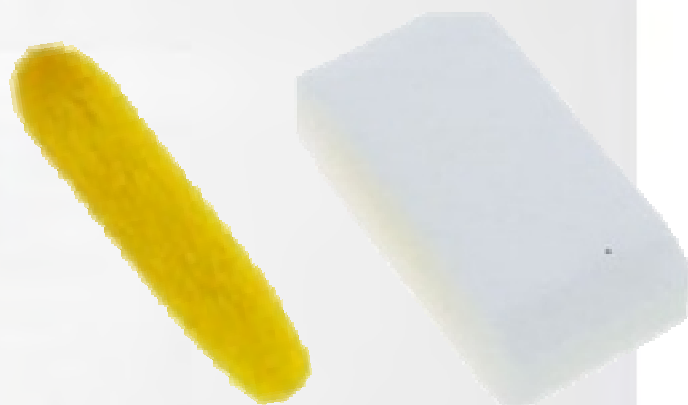

Touch-Pump Bottles provide an economic, clean & safe method of conveniently presenting a small reservoir of solvent, cleaner or alcohol. Fluid-ready for dipping a brush or wipe for an assembly, production or laboratory purpose. Ideal for PCB soldering operations & clean rooms. Prevents wasteful evaporation & contamination. Stainless steel lid & pump components for long life.

### Touch Pump Bottles

Part Code	Size	Type
5606026	100ml	Bottle Assembly
5606027	200ml	Bottle Assembly
5701272	1/4" Wide Soft	Brush
5701274	1/4" Wide Hard	Brush
5701273	3/8" Wide Soft	Brush



Disposable plastic cartridges are available in 2.5, 6, 8, 10, 12, 20 and 32 oz. (approximate metric value 75, 177, 237, 310 355, 591, 960cc). Available in high-density natural polyethylene (HDPE) which is more rigid plastic and low density polyethylene (LDPE) which is a softer grade plastic. All sizes are fitted with a 1/4" NPT (6mm) female thread dispensing orifice.

Industrial Cartridges

Size	Natural	Black	Green	Material
2.5oz	TS25C	n/a	TS25C-GREEN	HDPE
2.5oz	TS25C-LD	n/a	n/a	LDPE
6oz	TS60C	TS60C-BLACK	TS60C-GREEN	HDPE
6oz	TS60C-LD	n/a	n/a	LDPE
8oz	TS80C	n/a	n/a	HDPE
8oz	TS80C-LD	n/a	n/a	LDPE
10oz	TS110C	TS110C-BLACK	n/a	HDPE
10oz	TS110C-LD	n/a	n/a	LDPE
12oz	TS120C	TS120C-BLACK	TS120C-GREEN	HDPE
12oz	TS120C-LD	n/a	n/a	LDPE
20oz	TS20C	TS20C-BLACK	n/a	HDPE
32oz	TS32C	n/a	n/a	HDPE

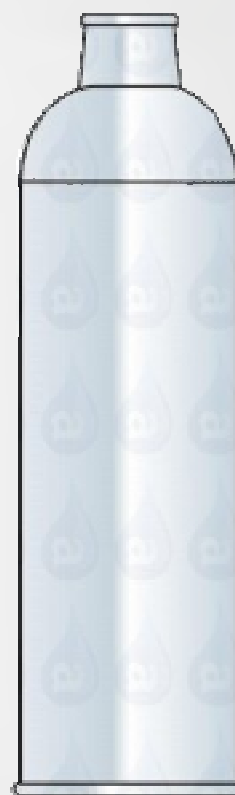

Cartridge plungers ensure that the pressure is evenly spread across the fluid surface to provide consistent dispensing. Wiping edges prevent dripping and eliminate material waste by wiping the cartridge walls clean, as fluid is dispensed. The plunger is inserted into the cartridge once filled (or pre-inserted when bottom filling) and it moves down the inner walls under pressure.

Cartridge Plungers

Part	Colour	For Cartridge Sizes	Material
TS1P	Blue	2.5, 6, 8, 12oz	LDPE
TS1PB	Black	2.5, 6, 8, 12oz	LDPE
TS1WP	Natural	2.5, 6, 8, 12oz	LDPE
TS1WP-RIB	Natural	2.5, 6, 8, 12oz	LDPE
TS3WP-MD	Natural	2.5, 6, 8, 12oz	MDPE
TS2PW	White	10oz (310ml)	LDPE
TS2P-BLACK	Black	10oz (310ml)	LDPE
TS20P	White	20/32oz	MDPE
TS20P-LD	Natural	20/32oz	LDPE

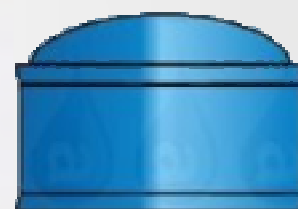

Disposable plastic cartridge kits are in sizes 2.5, 6, 8, 10, 12, 20 and 32 oz. (approximate metric value 75, 177, 237, 310 355, 591, 960cc). In high-density natural polyethylene (HDPE) which is more rigid plastic and low density polyethylene (LDPE) which is a softer grade plastic. These kits include the same number of cartridges and plungers in the same box.

## Cartridge Plunger Kits

Size	Part Code	Cartridge	Plunger	Colours
2.5oz	TS25CKIT	TS25C	TS1WP	Natural/ Natural
2.5oz	TS25CKITL	TS25C-LD	TS1WP	Natural/ Natural
6oz	TS60CKIT	TS60C	TS1WP	Natural/ Natural
6oz	TS60CKITL	TS60C-LD	TS1WP	Natural/ Natural
8oz	TS80CKIT	TS80C	TS1WP	Natural/ Natural
8oz	TS80CKITL	TS80C-LD	TS1WP	Natural/ Natural
10oz	TS110CKIT	TS110C	TS2P	Natural/ White
10oz	TS110CKITB	TS110C-BLACK	TS2P-BLACK	Black/ Black
12oz	TS120CKIT	TS120C	TS1WP	Natural/ Natural
12oz	TS120CKITL	TS120C-LD	TS1WP	Natural/ Natural
20oz	TS20CKIT	TS20C	TS20P	Natural/ White
32oz	TS23CKIT	TS32C	TS20P	Natural/ White

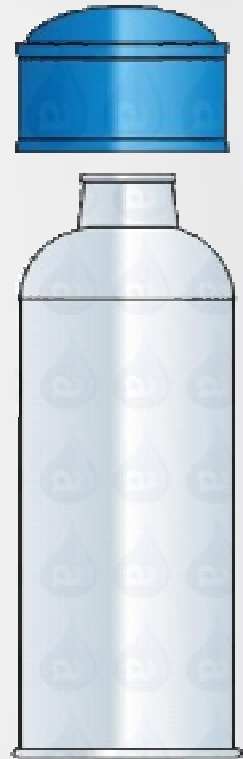

Polyethylene end caps for sealing the flange (top) of cartridges and tip caps for a 1/4" NPT thread sealed nozzle end. Provides air tight seal preventing any leaks and ensures fluids can be stored inside the cartridge. Caps are silicone and chloride free to prevent contamination of any materials.

## Cartridge Caps

Part	Colour	Type	For Cartridge Sizes	Material
TS2C	Red	End Cap	2.5, 6, 8, 12oz	LDPE
TS4C	Red	End Cap	10oz (310ml)	LDPE
TS6C	Red	End Cap	20/32oz	LDPE
TS3P	Red	Tip Cap	2.5, 6, 8, 10, 12, 20, 32oz	MDPE
TS4P	Red	Tip Cap	2.5, 6, 8, 10, 12, 20, 32oz	MDPE
TS5P	Red	Tip Cap	2.5, 6, 8, 10, 12, 20, 32oz	MDPE
TS6P-RED	Red	Tip Cap	2.5, 6, 8, 10, 12, 20, 32oz	MDPE
TS6P-BLACK	Black	Tip Cap	2.5, 6, 8, 10, 12, 20, 32oz	MDPE
TS9X	Red	Tip Cap	2.5, 6, 8, 10, 12, 20, 32oz	MDPE

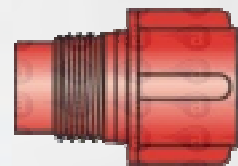

Silicone Free  
Components

Industrial  
Grade Safe

Nozzles for dispensing from cartridges and dispense valves. Products are silicone free and safe for use to 100 psi with a 1/4" NPT thread. Natural polyethylene materials. Ribbon nozzles spread the material as it is dispensed to varying widths. Fillet lap nozzles apply to edges and seams. Roller nozzles spread flat.

## Industrial Nozzles

Part	Type	Orifice	Length	Material
TS216	Straight	1.6mm/ 0.063"	63.5mm/ 2.5"	MDPE
TS218	Straight	3.18mm/ 0.125"	63.5mm/ 2.5"	MDPE
TS218-LD	Straight	3.18mm/ 0.125"	63.5mm/ 2.5"	LDPE
TS416	Straight	1.6mm/ 0.063"	101.6mm/ 4"	MDPE
TS416-LD	Straight	1.6mm/ 0.063"	101.6mm/ 4"	LDPE
TS418	Straight	3.18mm/ 0.125"	101.6mm/ 4"	MDPE
TS432	Straight	0.79mm/ 0.031"	101.6mm/ 4"	MDPE
TS432-LD	Straight	0.79mm/ 0.031"	101.6mm/ 4"	LDPE
TS490	Straight	2.39mm/ 0.094"	101.6mm/ 4"	MDPE
TS616	Straight	1.6mm/ 0.063"	152.4mm/ 6"	MDPE
TS618	Straight	3.18mm/ 0.125"	152.4mm/ 6"	MDPE
TS1050	Ribbon	12.7 x 1.52mm	101.6mm/ 4"	MDPE
TS1050-45	Ribbon	12.7 x 1.52mm	101.6mm/ 4"	MDPE
TS1075	Ribbon	19.05 x 3.30mm	101.6mm/ 4"	MDPE
TS1100	Ribbon	25.4 x 3.30mm	101.6mm/ 4"	MDPE
TS1175	Ribbon	44.45 x 3.30mm	101.6mm/ 4"	MDPE
TS3106	Fillet Lap R	8.89 x 2.79mm	101.6mm/ 4"	MDPE
TS3206	Fillet Lap L	8.89 x 2.79mm	101.6mm/ 4"	MDPE
232693	Roller	25.0mm Wide	101.6mm/ 4"	Nylon
232692	Roller	50.0mm Wide	101.6mm/ 4"	Nylon



Adapters are used with cartridges and all feature a 1/4" NPT thread for leak free attachment. TSD931-15 is used to attach syringes for barrel filling. Part TSD931-7 and TSD931-14 are tip adapters, allowing the use of standard luer lock needle and tapered tips to be used. Part TSD918-3 is an elbow that threads on-to the cartridge allowing all other fittings with 1/4" NPT thread to be used.

## Cartridge Adapters

Part Code	Material	Colour	Use
TSD931-15	Nylon/ Celcon	Black	Syringe filling
10ml	Polypro	White	Tip adapter
10ml	Polypro	Black	Tip adapter
45ml	Polypro	Clear	Syringe filling





APPLICATIONS	DISPENSING TIPS							
	Tapered	Stainless Steel	Teflon Lined	Flexible	Crimped	Teflon	Aluminium	Brush
Very Low Viscosity Fluids	X	●	●	●	●	●	●	●
Particle-Filled Pastes	●	●	▲	X	●	X	●	X
Microdot Deposits	X	●	▲	●	●	●	▲	X
Fluid Is Reactive to Metal	●	X	●	●	X	●	X	X
Depositing in Recesses	▲	●	●	▲	●	●	●	X
Spreading/Smearing	●	▲	●	▲	▲	●	●	●
Fast-Curing Glues	●	▲	●	●	▲	▲	▲	X
Beading, Striping	●	●	●	▲	●	▲	●	▲
Easily Scratched Substrates	●	▲	●	●	▲	●	▲	●

FLUIDS	DISPENSING TIPS							
	Tapered	Stainless Steel	Teflon Lined	Flexible	Crimped	Teflon	Aluminium	Brush
Adhesives	●	●	●	●	●	●	●	●
Anaerobics	●	▲	●	▲	▲	▲	▲	▲
Conformal Coatings	●	▲	▲	X	●	X	▲	X
Cyanoacrylates	●	▲	●	●	▲	●	X	X
Gel Cyanoacrylates	●	▲	●	▲	▲	●	X	X
Epoxies	●	●	●	X	●	X	●	X
Greases	●	●	●	X	●	X	●	●
Light-Cure Adhesives	X	▲	X	X	●	X	●	X
Oils	▲	●	●	▲	▲	▲	●	●
Paints	▲	●	●	X	▲	X	●	●
Sealants	●	▲	▲	X	▲	X	▲	X
Silver Epoxy	X	▲	X	X	▲	X	▲	X
Solder Paste/Braze Pastes	●	●	▲	X	●	X	●	X
Solder Masks	●	●	▲	X	●	▲	●	▲
Solvents	X	●	●	●	●	●	●	●
UV-Cure Adhesives	●	▲	▲	X	●	▲	▲	X

Smooth flow tapered tips are used with high viscosity materials as the smooth flow design allows materials to flow with less resistance. In 7 gauge sizes from 14 to 27. Length 1.25" (31.75mm). For many fluids including solder pastes, fluxes, gels, epoxies, grease, compounds, adhesives, silicones, sealants, UV cure, etc. Double helix luer lock secure connection to syringes, bottles or valves. 50, 500 or 1000 packs.

### Tapered Tips

Part Code	Gauge	Colour	Inner Diameter	Max Pressure
TTN14	14	Olive	1.600mm/ 0.063"	100 PSI
TTN16	16	Grey	1.222mm/ 0.048"	100 PSI
TTN18	18	Green	0.838mm. 0.033"	100 PSI
TTN20	20	Pink	0.610mm/ 0.024"	100 PSI
TTN22	22	Blue	0.406mm/ 0.016"	100 PSI
TTN25	25	Red	0.254mm/ 0.010"	100 PSI
TTN27	27	Clear	0.203mm/ 0.008"	100 PSI
TTN27E	27	Orange	0.203mm/ 0.008"	100 PSI



The TE needle series consist of a stainless-steel shaft with a double helix polypropylene hub. This premier line of dispensing needles is burr-free, and electro-polished shaft for unobstructed and consistent material flow. They are silicone and chloride free. For most viscosity fluids and adhesives and safe for use to 100 psi. Supplied in packs of 50, 500 or 1000 tips.

### General Purpose Tips

Gauge	0.25"	0.50"	1.0"	1.5"	ID`	OD	Colour
14	TE714025	TE714050	TE714100	TE714150	1.55mm	1.83mm	Olive
15	TE715025	TE715050	TE715100	TE715150	1.37mm	1.65mm	Amber
16	TE716025	TE716050	TE716100	TE716150	1.19mm	1.45mm	Grey
18	TE718025	TE718050	TE718100	TE718150	0.84mm	1.27mm	Green
20	TE720025	TE720050	TE720100	TE720150	0.61mm	0.91mm	Pink
21	TE721025	TE721050	TE721100	TE721150	0.51mm	0.81mm	Purple
22	TE722025	TE722050	TE722100	TE722150	0.41mm	0.71mm	Blue
23	TE723025	TE723050	TE723100	TE723150	0.33mm	0.64mm	Orange
25	TE725025	TE725050	TE725100	TE725150	0.25mm	0.51mm	Red
27	TE727025	TE727050	TE727100	TE727150	0.20mm	0.41mm	Clear
30	TE730025	TE730050	TE730100	n/a	0.15mm	0.30mm	Lavender
32	TE732025	TE732050	n/a	n/a	0.10mm	0.23mm	Yellow
34	TE734025	n/a	n/a	n/a	0.08mm	0.21mm	Lime



Silicone Free  
Components

Industrial  
Grade Safe

The TE needle series consist of a stainless-steel shaft with a double helix polypropylene hub. This premier line of dispensing needles is burr-free, and electro-polished shaft for unobstructed and consistent material flow. They are silicone and chloride free. For most viscosity fluids and adhesives and safe for use to 100 psi. These tips are 0.5" long and with 45° or 90° precision bends. 50, 500 or 1000 packs.

**Angled Tips**

Gauge	45° Bend	90° Bend	Inner Diameter	Colour
14	TE71405045	TE71405090	1.600mm/ 0.063"	Olive
15	TE71505045	TE71505090	1.370mm/ 0.054"	Amber
18	TE71805045	TE71805090	0.840mm. 0.033"	Green
20	TE72005045	TE72005090	0.610mm/ 0.024"	Pink
21	TE72105045	TE72105090	0.508mm/ 0.020"	Purple
22	TE72205045	TE72205090	0.406mm/ 0.016"	Blue
23	TE72305045	TE72305090	0.330mm/ 0.013"	Orange
25	TE72505045	TE72505090	0.254mm/ 0.010"	Red
27	TE72705045	TE72705090	0.203mm/ 0.008"	Clear
30	TE73005045	TE73005090	0.152mm/ 0.006"	Lavender



Moulded high-density polypropylene colour coded crimped hub to a burr free stainless steel tube. Suitable for all liquids including glues, pastes and gels. Especially useful for dispensing solvent based adhesives as the Aluminium crimp on the needle will not be attacked by solvents. 50, 500 or 1000 packs.

**Crimped Hub Tips**

Gauge	0.5" Long	1.0" Long	Inner Diameter	Colour
14	TES14050	TES14100	1.55mm/ 0.061"	Olive
15	TES15050	TES15100	1.37mm/ 0.054"	Grey
18	TES18050	TES18100	0.84mm/ 0.033"	Green
19	TS19-1/2	TS19-1	0.71mm/ 0.028"	Brown
20	TES20050	TES20100	0.61mm/ 0.024"	Pink
21	TES21050	TES21100	0.51mm/ 0.020"	Purple
22	TES22050	TES22100	0.41mm/ 0.016"	Blue
23	TES23050	TES23100	0.33mm/ 0.013"	Orange
25	TES25050	TES25100	0.25mm/ 0.010"	Red
26	TS26-1/2	TS26-1	0.24mm. 0.010"	Beige
27	TES27050	TES27100	0.20mm/ 0.008"	Clear
30	TS30-1/2	n/a	0.15mm/ 0.006"	Lavender



Flexible tube dispense tips. Ideal for use with adhesives, inks, primers, glues, Cyanoacrylates, paints and many more. 0.50", 1.0" or 1.5" length tubes. Polypro hub material to polypro flexible tubes. Colour coded luer lock hubs. Soft tubing is also ideal for sensitive substrates. Packs of 50, 500 or 1000.

### Polypro Tips

Gauge	0.5" Long	1.0" Long	1.5" Long	ID	Colour
14	3114PPS	3114PP-1	3114PP	1.60mm	Olive
15	3115PPS	3115PP-1	3115PP	1.37mm	Amber
18	3118PPS	3118PP-1	3118PP	0.84mm	Green
20	3120PPS	3120PP-1	3120PP	0.58mm	Pink
22	3122PPS	3122PP-1	3122PP	0.43mm	Blue
25	3125PPS	3125PP-1	3125PP	0.35mm	Red



Flexible tube dispense tips. Ideal for use with adhesives, inks, primers, glues, Cyanoacrylates, paints and many more. 1.5" length tubes. Polypro hub material to colour coded flexible tubes. Packs of 50.

### TSP Polypro Tips

Gauge	ID	Colour	Length
14	1.60mm	White	38.1mm
15	1.37mm	Grey	38.1mm
16	1.19mm	Brown	38.1mm
18	0.84mm	Pink	38.1mm
20	0.58mm	Yellow	38.1mm
22	0.48mm	Black	38.1mm
25	0.36mm	Red	38.1mm



Teflon lined tips for dispensing Cyanoacrylate adhesives. PTFE Teflon tube resists clogging. 0.50" or 1.0" long. Polypro hub material to stainless steel tube with Teflon crimped insert. Double helix threaded luer lock colour coded hub. Boxes of 50, 500 or 1000.

### Teflon Lined Tips

Gauge	0.5" Long	1.0" Long	ID	Colour
21	5121TLCS	5121TLC	0.51mm	Grey
25	5125TLCS	5125TLC	0.30mm	Pink
27	5127TLCS	5127TLC	0.15mm	Red



Teflon tips for dispensing Cyanoacrylate adhesives where the Teflon tube resists clogging. 0.50" or 2.0" long. Polypropylene hub material to the semi-flexible Teflon tubing. Double helix threaded luer lock colour coded hub. Teflon tube is translucent. Premium tips for clog free dispensing applications. Supplied in packs of 50 or 1000.

Teflon Tips					
Gauge	0.5"	2.0"	ID	Colour	
14	TF14-1/2	TF14-2	1.676mm	Olive	
16	TF16-1/2	TF16-2	1.346mm	Purple	
18	TF18-1/2	TF18-2	1.067mm	Pink	
20	TF20-1/2	TF20-2	0.864mm	Yellow	
22	TF22-1/2	TF22-2	0.711mm	Black	
23	TF23-1/2	n/a	0.660mm	Blue	
24	TF24-1/2	n/a	0.559mm	Red	
30	TF30-1/2	TF30-2	0.305mm	Lavender	

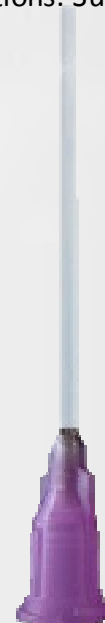

Precision Aluminium hub dispense tips. Ideal for use with adhesives and aggressive solvent based liquids or chemicals. Aluminium hub fixed to stainless steel tube. Standard luer lock hubs. High quality tips for use with liquids that would otherwise affect a plastic tip. All tips are silver colour. Packs of 50, 500 or 1000.

Aluminium Tips					
Gauge	0.5"	1.0"	1.5"	2.0"	ID
14	TS14-1/2M	TS14-1M	n/a	TS14-2M	1.600mm
15	TS15-1/2M	TS15-1M	TS15-15M	TS15-2M	1.371mm
16	n/a	TS16-1M	TS16-15M	n/a	0.838mm

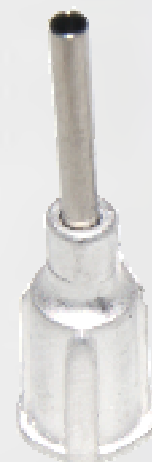

Metal Tapered Tips		
Part Code	ID	OD
AD001	0.10mm	0.20mm
AD015	0.15mm	0.25mm
AD002	0.20mm	0.40mm
AD025	0.25mm	0.45mm
AD003	0.30mm	0.50mm
AD004	0.40mm	0.60mm
AD005	0.50mm	0.70mm
AD006	0.60mm	0.80mm

All metal tapered dispense tips for accurate placement of viscous materials. Luer lock design. 18.25mm long. Nickel plated brass to 303 stainless steel. Sold each.



All metal needle dispense tips for accurate placement of most materials. Luer lock design. Nickel plated brass to 304 stainless steel. Ideal for automated dispensing applications. Boxes of 10 tips.

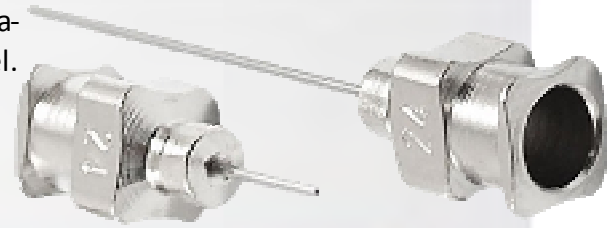

### All Metal Tips

GA	0.25"	0.50"	1.0"	1.5"	2.0"	ID mm	OD mm
11	TS11SS-1/4	TS11SS-1/2	TS11SS-1	TS11SS-15	TS11SS-2	2.30	2.95
12	TS12SS-1/4	TS12SS-1/2	TS12SS-1	TS12SS-15	TS12SS-2	2.18	2.77
13	TS13SS-1/4	TS13SS-1/2	TS13SS-1	TS13SS-15	TS13SS-2	1.94	2.40
14	TS14SS-1/4	TS14SS-1/2	TS14SS-1	TS14SS-15	TS14SS-2	1.64	2.10
15	TS15SS-1/4	TS15SS-1/2	TS15SS-1	TS15SS-15	TS15SS-2	1.38	1.84
16	TS16SS-1/4	TS16SS-1/2	TS16SS-1	TS16SS-15	TS16SS-2	1.20	1.65
17	TS17SS-1/4	TS16SS-1/2	TS16SS-1	TS16SS-15	TS16SS-2	1.09	1.50
18	TS18SS-1/4	TS18SS-1/2	TS18SS-1	TS18SS-15	TS18SS-2	0.91	1.25
19	TS19SS-1/4	TS19SS-1/2	TS19SS-1	TS19SS-15	TS19SS-2	0.70	1.10
20	TS20SS-1/4	TS20SS-1/2	TS20SS-1	TS20SS-15	TS20SS-2	0.60	0.90
21	TS21SS-1/4	TS21SS-1/2	TS21SS-1	TS21SS-15	TS21SS-2	0.51	0.81
22	TS22SS-1/4	TS22SS-1/2	TS22SS-1	TS22SS-15	TS22SS-2	0.40	0.71
23	TS23SS-1/4	TS23SS-1/2	TS23SS-1	TS23SS-15	TS23SS-2	0.34	0.63
24	TS24SS-1/4	TS24SS-1/2	TS24SS-1	TS24SS-15	TS24SS-2	0.31	0.56
25	TS25SS-1/4	TS25SS-1/2	TS25SS-1	TS25SS-15	TS25SS-2	0.26	0.51
26	TS26SS-1/2	TS26SS-1/2	TS26SS-1	TS26SS-15	TS26SS-2	0.25	0.46
27	TS27SS-1/4	TS27SS-1/2	TS27SS-1	TS27SS-15	TS27SS-2	0.21	0.41
29	TS29SS-1/4	TS29SS-1/2	TS29SS-1	TS29SS-15	TS29SS-2	0.18	0.34
30	TS30SS-1/4	TS30SS-1/2	TS30SS-1	TS30SS-15	TS30SS-2	0.15	0.30

All metal needle dispense tips for accurate placement of most materials. Dual tip outlet design. Luer lock design. Nickel plated brass to 304 stainless steel. Ideal for automated dispensing applications. These tips are supplied in boxes of 12.

### Dual Metal Tips

Part Code	Gauge	ID mm	OD mm	Length
ADT18050	18	0.91	1.25	12.5mm/ 0.50"
ADT20050	20	0.60	0.90	12.5mm/ 0.50"
ADT22050	21	0.51	0.81	12.5mm/ 0.50"
ADT22050	22	0.40	0.71	12.5mm/ 0.50"
ADT23050	23	0.34	0.63	12.5mm/ 0.50"
ADT25050	25	0.26	0.51	12.5mm/ 0.50"
ADT27050	27	0.21	0.41	12.5mm/ 0.50"



Use these double helix brush tips for “spread” applications such as glues and other materials such as grease, primers, activators, paints, etc. Brush part is made of nylon for hard bristle and sable for soft bristle. Many other widths and types are available, please visit our website for information.

## Brush Tips

Gauge	Brush Width	Soft	Hard	ID
14	6mm Round	AD-1009-14BTS	AD-1009-14BT	1.60mm
15	6mm Round	AD-1009-15BTS	AD-1009-15BT	1.37mm
16	6mm Round	AD-1009-16BTS	AD-1009-16BT	1.22mm
18	6mm Round	AD-1009-18BTS	AD-1009-18BT	0.89mm
20	6mm Round	AD-1009-20BTS	AD-1009-20BT	0.61mm
21	6mm Round	AD-1009-21BTS	AD-1009-21BT	0.51mm
22	6mm Round	AD-1009-22BTS	AD-1009-22BT	0.41mm
23	6mm Round	AD-1009-23BTS	AD-1009-23BT	0.33mm
25	6mm Round	AD-1009-25BTS	AD-1009-25BT	0.25mm
27	6mm Round	AD-1009-27BTS	AD-1009-27BT	0.20mm



Assortment of different tip kits excellent for evaluation and testing purposes. Available in presentation boxes or in smaller kits. Ideal for use with glues, grease, paints, inks, gels, primers, sealants and more. Select the type of tip kit to suit the applications or testing.

## Tip Kits

Part Code	Quantity	Contains
DCK600	145 Pcs	General Purpose, Angled. Tapered, Polypro, Caps
DCK700	145 Pcs	General Purpose, Angled. Tapered, Teflon, Caps
TN00DKIT	145 Pcs	General Purpose, Angled. Tapered, Caps
DCK500	144 Pcs	General Purpose, Angled. Tapered, Barrels, Caps
DSKIT1	82 Pcs	General Purpose, Tapered, Barrels, Adapters, Caps
SA7721	50 Pcs	Tapered Tip Selection
SA7524	50 Pcs	General Purpose Tip Selection
SA7529	18 Pcs	Angled 45°
SA7530	18 Pcs	Angled 90°
SA7539	40 Pcs	Polypro Tip Selection



**Industrial  
Grade Safe**

**Silicone Free  
Components**

Industry standard small cartridge with bayonet twist-on attachment of mixer nozzle. In 50ml and 75ml sizes with 1:1, 2:1, 4:1 and 10:1 mix ratios. Pistons are vented to allow easy insertion to eliminate air entrapment. Supplied in complete sets including pistons and tip cap seal. These cartridges are for use with "MA", "MAQ" and "MAHQ" mix nozzles where they twist-on. Use with applicator guns.

## 50ml A Series System

Part Code	Ratio	Capacity	Material	Piston Style
451000	1:1	50ml	PP White	Self Venting
452013	2:1	50ml	PP White	Self Venting
454000	4:1	42ml	PP White	Self Venting
454010	10:1	37ml	PP White	Self Venting



High density bayonet static mixer nozzles for use with A Series twin 50ml cartridges. Stepped at the outlet end for controlled dispensing direct or by using our luer lock tip adapters for higher precision. These mixer nozzles are suitable for most two-component materials. They are constructed of high grade polypropylene. All products are industrial grade and silicone free plastics.

## Bayonet Mix Nozzles

Part Code	Ratios	ID	No.	Length	Elements	Volume
MA3.0-07S	1:1/2:1	3mm	7	34mm	White	0.24ml
MA3.0-13S	1:1/2:1	3mm	13	51mm	White	0.30ml
MA3.0-17S	1:1/2:1	3mm	17	62mm	White	0.40ml
MA4.0-13S	1:1/2:1	4mm	13	66mm	White	0.60ml
MA4.0-17S	1:1/2:1	4mm	17	82mm	White	0.80ml
MA5.4-07S	1:1/2:1	5.4mm	7	56mm	White	0.80ml
MA5.4-13S	1:1/2:1	5.4mm	13	85mm	White	1.40ml
MA5.4-17S	1:1/2:1	5.4mm	17	104mm	White	1.70ml
MA5.4-21S	1:1/2:1	5.4mm	21	124mm	White	2.01ml
MA6.3-12S	1:1/2:1	6.3mm	12	97mm	White	2.10ml
MA6.3-17S	1:1/2:1	6.3mm	17	128mm	White	2.90ml
MA6.3-21S	1:1/2:1	6.3mm	21	153mm	White	3.60ml
MAQ05-16L	1:1/2:1	5.3mm	16	83mm	Green	1.30ml
MAQ05-24L	1:1/2:1	5.3mm	24	115mm	Green	1.90ml
MAHX04-17T	4:1/10:1	4.0mm	17	82mm	Orange	0.80ml
MAHX05-17T	4:1/10:1	5.0mm	17	104mm	Orange	1.50ml
MAQ05-16L	4:1/10:1	5.3mm	16	83mm	Green	1.30ml
MAQ05-24L	4:1/10:1	5.3mm	24	115mm	Green	1.90ml





# Dual Cartridges & Static Mixer Nozzles

The B system small capacity cartridges offer advantages over the original A system by utilizing separated outlet ports to that prevent cross-contamination and allow for efficient resealing of the cartridge. A wide range of dispensing ratios available. The range is further complimented with options for the piston sealing arrangement and materials. Use with manual and pneumatic applicator guns.

## 50ml B Series System

Part Code	Ratio	Capacity	Material	Piston Style
AB050-01-10-01	1:1	50ml	PP White	Self Venting
AB050-02-10-01	2:1	50ml	PP White	Self Venting
AB050-04-10-01	4:1	42ml	PP White	Self Venting
AB050-10-10-01	10:1	37ml	PP White	Self Venting



The B system small capacity cartridges offer advantages over the original A system by utilizing separated outlet ports to that prevent cross-contamination and allow for efficient resealing of the cartridge. A wide range of dispensing ratios available. The range is further complimented with options for the piston sealing arrangement and materials. Use with manual and pneumatic applicator guns.

## 50ml Dual Mix Nozzles

Part Code	Ratios	ID	No.	Length	Elements	Volume
MBH03-12S	1:1/2:1	3.2mm	12	64mm	White	0.49ml
MBH03-16S	1:1/2:1	3.2mm	16	76mm	White	0.59ml
MBH04-16S	1:1/2:1	4.2mm	16	96mm	White	1.04ml
MBH05-16T	1:1/2:1	5.4mm	16	112mm	White	1.91ml
MBH05-20T	1:1/2:1	5.4mm	20	133mm	White	2.29ml
MBH06-16T	1:1/2:1	6.5mm	16	131mm	White	3.14ml
MBH06-20T	1:1/2:1	6.5mm	20	157mm	White	3.76ml
MBHX03-16S	4:1/10:1	3.2mm	16	77mm	Orange	0.60ml
MBHX04-16S	4:1/10:1	4.2mm	16	96mm	Orange	1.05ml
MBHX05-16T	4:1/10:1	5.4mm	16	111mm	Orange	1.91ml
MBHX05-20T	4:1/10:1	5.4mm	20	133mm	Orange	2.07ml
MBHX06-16T	4:1/10:1	6.5mm	16	131mm	Orange	3.04ml
MBHX06-20T	4:1/10:1	6.5mm	20	157mm	Orange	3.79ml
MBQ05-16L	1:1/2:1	5.3mm	16	91mm	Green	1.88ml
MBQ05-24L	1:1/2:1	5.3mm	24	122mm	Green	2.60ml
MBQX05-16L	4:1/10:1	5.3mm	16	91mm	Orange	1.72ml
MBQX05-24L	4:1/10:1	5.3mm	24	122mm	Orange	2.37ml



Industrial Grade Safe

Silicone Free Components

The C system industrial cartridge is a long established proven design with a range of dispensing ratios available. The complete range of static mixing nozzles are listed below the cartridges, all featuring a bell mouth nose interface that is fixed in leak free using the cartridge locking cap. Cartridge sizes of 200ml and 400ml in 4 mix ratios. Mix nozzles white element for 1:1/2:1 and orange for 4:1/10:1.

## C System Cartridges

Part Code	Ratio	Capacity	Material	Piston Style
422026	1:1	200ml	PP White	Self Venting
422001	2:1	200ml	PP White	Self Venting
422401	4:1	200ml	PP White	Self Venting
422033	10:1	200ml	PP White	Self Venting
400011	1:1	400ml	PP White	Self Venting
400021	2:1	400ml	PP White	Self Venting
400041	4:1	400ml	PP White	Self Venting
400101	10:1	400ml	PP White	Self Venting

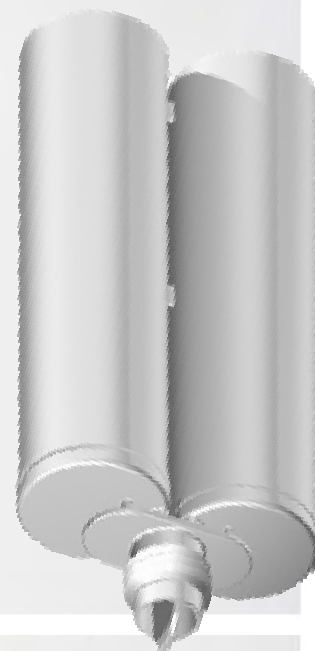

## C System Mixers

Part Code	Ratios	ID	No.	Length	Elements	Volume
MC03-08	1:1/2:1	3.0mm	8	38mm	White	0.19ml
MC05-18	1:1/2:1	5.0mm	18	122mm	White	2.10ml
MC05-24	1:1/2:1	5.0mm	24	150mm	White	2.30ml
MC06-18	1:1/2:1	6.0mm	18	150mm	White	3.60ml
MC06-24	1:1/2:1	6.0mm	24	187mm	White	4.20ml
MC06-32	1:1/2:1	6.0mm	32	234mm	White	5.00ml
MC08-18	1:1/2:1	8.0mm	18	178mm	White	6.70ml
MC08-24	1:1/2:1	8.0mm	24	225mm	White	8.50ml
MC08-32	1:1/2:1	8.0mm	32	287mm	White	10.9ml
MC10-18	1:1/2:1	10.0mm	18	215mm	White	12.3ml
MC10-24	1:1/2:1	10.0mm	24	277mm	White	14.6ml
MC10-32	1:1/2:1	10.0mm	32	352mm	White	17.7ml
MC13-12	1:1/2:1	13.0mm	12	170mm	White	14.7ml
MC13-24	1:1/2:1	13.0mm	24	294mm	White	27.3ml
MC13-32	1:1/2:1	13.0mm	32	379mm	White	35.7ml
MCHX08-18	4:1/10:1	8.0mm	18	183mm	Orange	6.40ml
MCHX08-24	4:1/10:1	8.0mm	24	231mm	Orange	9.30ml
MCHX10-12	4:1/10:1	10.0mm	12	157mm	Orange	9.60ml
MCHX10-18	4:1/10:1	10.0mm	18	216mm	Orange	11.9ml
MCHX10-24	4:1/10:1	10.0mm	24	276mm	Orange	16.2ml
MCHX13-12	4:1/10:1	13.0mm	12	192mm	Orange	11.6ml
MCHX15-12	4:1/10:1	15.0mm	12	196mm	Orange	27.0ml



Bell Mouth Quadro Static mixers For 1:1, 2:1, ratio C System cartridges. Please note these can also be used with 4:1 and 10:1 ratio cartridges. Green mix elements.

C System Mixers

Part Code	Ratios	ID	No.	Length	Volume
MCQ05-24L	1:1/2:1/4:1/10:1	5.3mm	24	127mm	3.46ml
MCQ07-24T	1:1/2:1/4:1/10:1	7.5mm	24	130mm	6.19ml
MCQ08-24T	1:1/2:1/4:1/10:1	8.7mm	24	147mm	8.44ml
MCQ08-32T	1:1/2:1/4:1/10:1	8.7mm	32	186mm	10.37ml
MCQ10-24T	1:1/2:1/4:1/10:1	10.7mm	24	172mm	14.04ml
MCQ10-32T	1:1/2:1/4:1/10:1	10.7mm	32	220mm	18.45ml



Mixer helix with screw connection for C System cartridges. For 1:1, 2:1, ratio C System cartridges. Please note these can also be used with 4:1 and 10:1 ratio cartridges.

C System Mixers

Part Code	Ratios	ID	No.	Length	Volume
MGH08-06S	1:1/2:1/4:1/10:1	8.0mm	6	109mm	3.68ml
MGH1008-12	1:1/2:1/4:1/10:1	8.0mm	12	217mm	10.3ml
MGH1008-18	1:1/2:1/4:1/10:1	8.0mm	18	217mm	9.99ml



Screw connection Quadro Static mixers For 1:1, 2:1, ratio C System cartridges. Please note these can also be used with 4:1 and 10:1 ratio cartridges. Green mix elements. Parts with "T" have a stepped tip outlet. Parts with "D" have a straight tip.

C System Mixers

Part Code	Ratios	ID	No.	Length	Volume
MGQ08-18T	1:1/2:1/4:1/10:1	8.7mm	18	129mm	6.70ml
MGQ08-20D	1:1/2:1/4:1/10:1	8.7mm	20	142mm	7.57ml
MGQ08-20T	1:1/2:1/4:1/10:1	8.7mm	20	142mm	7.34ml
MGQ08-24D	1:1/2:1/4:1/10:1	8.7mm	24	161mm	8.61ml
MGQ08-24T	1:1/2:1/4:1/10:1	8.7mm	24	161mm	8.76ml
MQG10-16D	1:1/2:1/4:1/10:1	10.7mm	16	158mm	12.69ml
MGQ10-19D	1:1/2:1/4:1/10:1	10.7mm	19	158mm	12.15ml
MGQ10-24D	1:1/2:1/4:1/10:1	10.7mm	24	187mm	14.49ml

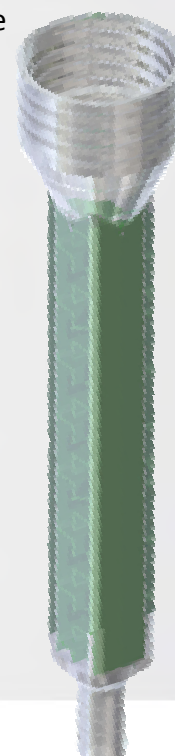

The F system industrial cartridge is the latest technology for 200ml and 400ml side by side dispensing. Available in four different dispensing ratios from 1:1 through to 10:1. Using port outlet technology, cross contamination is kept to a minimum allowing for simple and reliable re-sealing of part used product. The complete range of static mixing nozzles are listed below the cartridges, all featuring matching port profiles. Please note that due to the unique design of the F system, use only compatible mix nozzles.

## F System Cartridges

Part Code	Ratio	Capacity	Material	Piston Style
AF200-01-10-01	1:1	210ml	PP White	Self Venting
AF200-02-10-01	2:1	215ml	PP White	Self Venting
AF200-04-10-01	4:1	225ml	PP White	Self Venting
AF200-10-10-01	10:1	250ml	PP White	Self Venting
AF400-01-10-01	1:1	395ml	PP White	Self Venting
AF400-02-10-01	2:1	400ml	PP White	Self Venting
AF400-04-10-01	4:1	415ml	PP White	Self Venting
AF400-10-10-01	10:1	490ml	PP White	Self Venting



Mixer helix with dual hole connection for F System cartridges. For 1, 2:1, 4:1 and 10:1 ratio F System cartridges. All nozzles have a stepped tip. White mixers for 1:1/2:1 ratio, orange for 4:1/10:1 ratio.

## F System Mixers

Part Code	Ratios	ID	No.	Length	Elements	Volume
MFH06-18T	1:1/2:1	6.0mm	18	156mm	White	4.36ml
MFH06-24T	1:1/2:1	6.0mm	24	194mm	White	5.40ml
MFH06-32T	1:1/2:1	6.0mm	32	245mm	White	6.65ml
MFH08-18T	1:1/2:1	8.0mm	18	187mm	White	7.40ml
MFH08-24T	1:1/2:1	8.0mm	24	234mm	White	9.30ml
MFH08-32T	1:1/2:1	8.0mm	32	297mm	White	11.85ml
MFH10-18T	1:1/2:1	10.0mm	18	224mm	White	13.09ml
MFH10-24T	1:1/2:1	10.0mm	24	283mm	White	16.89ml
MFH10-32T	1:1/2:1	10.0mm	32	362mm	White	21.94ml
MFHX06-18T	4:1/10:1	6.0mm	18	156mm	Orange	4.16ml
MFHX06-24T	4:1/10:1	6.0mm	24	194mm	Orange	5.20ml
MFHX06-32T	4:1/10:1	6.0mm	32	245mm	Orange	6.56ml
MFHX08-18T	4:1/10:1	8.0mm	18	187mm	Orange	7.28ml
MFHX08-24T	4:1/10:1	8.0mm	24	234mm	Orange	9.14ml
MFHX08-32T	4:1/10:1	8.0mm	32	296mm	Orange	11.55ml
MFHX10-18T	4:1/10:1	10.0mm	18	224mm	Orange	12.96ml
MFHX10-24T	4:1/10:1	10.0mm	24	283mm	Orange	16.70ml
MFHX10-32T	4:1/10:1	10.0mm	32	363mm	Orange	21.22ml



Mixer helix with dual hole connection for F System cartridges. For 1, 2:1, 4:1 and 10:1 ratio F System cartridges. White top mixers for 1:1/2:1 ratio, orange top for 4:1/10:1 ratio. Quadro square bodied mixer nozzles. All mixers have green elements. Parts with "T" have a stepped tip outlet. Parts with "L" have a luer tip.

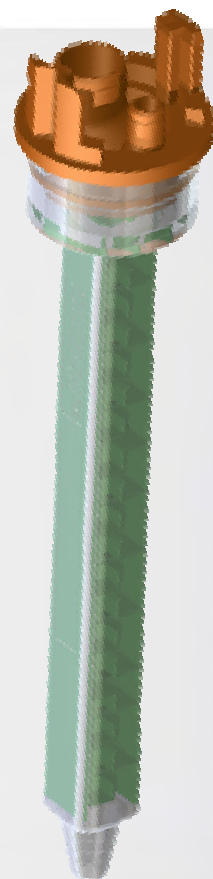

### F System Mixers

Part Code	Ratios	ID	No.	Length	Colour	Volume
MFQ05-16L	1:1/2:1	5.3mm	16	100mm	White	2.9ml
MFQ05-24L	1:1/2:1	5.3mm	24	132mm	White	3.52ml
MFQ07-24T	1:1/2:1	7.5mm	24	137mm	White	6.11ml
MFQ08-24T	1:1/2:1	8.7mm	24	155mm	White	8.69ml
MFQ10-24T	1:1/2:1	10.7mm	24	181mm	White	14.75ml
MFQX05-16L	4:1/10:1	5.3mm	16	101mm	Orange	3.07ml
MFQX05-24L	4:1/10:1	5.3mm	24	132mm	Orange	3.69ml
MFQX07-24T	4:1/10:1	7.5mm	24	137mm	Orange	6.28ml
MFQX08-24T	4:1/10:1	8.7mm	24	155mm	Orange	8.86ml
MFQX10-24T	4:1/10:1	10.7mm	24	181mm	Orange	14.92ml

The K system syringes are ideal for one shot dispensing of fully mixed product. They are supplied with or without integral plungers. The plungers eliminate the need for a separate dispensing gun and can be re-used. Small double mixers for resins and epoxies, etc.

### K System Syringes

Part Code	Ratio	Size	Material	Type
116436	1:1	2.5ml	PP White	Syringe, piston, cap, no plunger
116437	1:1	2.5ml	PP White	Syringe, piston, cap, no plunger
103128	1:1	2.5ml	PP White	Plunger rod only
301634	1:1	3.0ml	PP Clear	Syringe, plunger, mixer nozzle kit
116438	1:1	5.0ml	PP White	Syringe, piston, cap, no plunger
116439	1:1	5.0ml	PP White	Syringe, piston, cap, no plunger
113403	1:1	5.0ml	PP White	Plunger rod only
116440	1:1	10ml	PP White	Syringe, piston, cap, no plunger
116441	1:1	10ml	PP White	Syringe, piston, cap, no plunger
113401	1:1	10ml	PP White	Plunger rod only
116442	10:1	10ml	PP White	Syringe, piston, cap, no plunger
116435	10:1	10ml	PP White	Syringe, piston, cap, no plunger
116571	10:1	10ml	PP White	Syringe, piston, cap, no plunger
113371	10:1	10ml	PP White	Plunger rod only



The K system syringes are ideal for one shot dispensing of fully mixed product. They are supplied with or without integral plungers. The plungers eliminate the need for a separate dispensing gun and can be re-used. The mixer nozzles attach to the locking cap. White elements for 1:1/2:1 ratio and orange elements for 4:1/10:1 mix ratios. Use these mixers with K system dual syringes only.

## K System Mixers

Part Code	Ratios	ID	No.	Length	Colour	Volume
MKH02-08D	1:1/2:1	2.5mm	8	33.4mm	White	0.14ml
MKH02-08S	1:1/2:1	2.5mm	8	39.7mm	White	0.19ml
MKH02-12D	1:1/2:1	2.5mm	12	46.2mm	White	0.23ml
MKH02-12S	1:1/2:1	2.5mm	12	49.7mm	White	0.23ml
MKH02-16S	1:1/2:1	2.5mm	16	59.7mm	White	0.27ml
MKH03-12D	1:1/2:1	3.2mm	12	56.0mm	White	0.39ml
MKH03-12S	1:1/2:1	3.2mm	12	61.0mm	White	0.39ml
MKH03-16S	1:1/2:1	3.2mm	16	74.0mm	White	0.49ml
MKHX02-08D	4:1/10:1	2.5mm	8	36.2mm	Orange	0.14ml
MKHX02-08S	4:1/10:1	2.5mm	8	39.7mm	Orange	0.19ml
MKHX02-12D	4:1/10:1	2.5mm	12	46.2mm	Orange	0.23ml
MKHX02-12S	4:1/10:1	2.5mm	12	49.7mm	Orange	0.23ml
MKHX02-16S	4:1/10:1	2.5mm	16	59.7mm	Orange	0.27ml
MKHX03-12D	4:1/10:1	3.2mm	12	56.0mm	Orange	0.39ml
MKHX03-12S	4:1/10:1	3.2mm	12	61.0mm	Orange	0.39ml
MKHX03-16S	4:1/10:1	3.2mm	16	74.0mm	Orange	0.49ml



Industrial grade Cyanoacrylate adhesives for bonding rubber, plastics, metal, fabric, card, etc. Instant bond. Single part adhesives. Supplied with TDS/ MSDS. Long shelf life with batch codes. 50g or 500g.

## Cyanoacrylate Glues

Code	Base	Colour	Viscosity	Max Gap	Temp Range	Fix Time
GB06	Ethyl	Clear	20 cps	0.101mm	-50 to 90°C	5 secs
GB01	Ethyl	Clear	120cps	0.127mm	-50 to 90°C	8 secs
GB16	Ethyl	Clear	1500 cps	0.25mm	-50 to 90°C	20 secs
GB44	Ethyl	Clear	50k cps	0.25mm	-50 to 90°C	90 secs
GB80	Ethyl	Black	300 cps	0.100mm	-55 to 82°C	90 secs
GB95	Ethyl	Clear	50 cps	0.100mm	-50 to 90°C	7 secs
GB05	Ethyl	Clear	50 cps	0.100mm	-50 to 90°C	5 secs
GB02	Ethyl	Clear	50 cps	0.101mm	-50 to 90°C	8 secs
GB15	Ethyl	Clear	50 cps	0.101mm	-50 to 90°C	20 secs
DB50	n/a	n/a	1 cps	n/a	n/a	n/a
SA01	n/a	n/a	1 cps	n/a	n/a	n/a



Industrial anaerobic sealants and adhesives are single component materials that cure by the presence of metal and the absence of air. When both conditions are met anaerobic adhesives form a tough, durable polymer providing total contact between the two surfaces, resulting in a vibration and leak-proof assembly. In 50ml or 250ml bottles.

### Anaerobic Glues

Code	Strength	Colour	Viscosity	Max Gap	Temp Range	Fix Time
A02	Low	Purple	1200cps	0.18mm	-60 to 150°C	<25 min
A03	Medium	Blue	2500cps	0.38mm	-50 to 150°C	<10 min
A04	High	Red	2000cps	0.18mm	-60 to 150°C	<30 min
A05	Low	Green	500cps	0.18mm	-60 to 150°C	<30 min
A07	High	Red	7000cps	0.25mm	-60 to 150°C	<60 min
A08	Medium	Blue	2000cps	0.18mm	-60 to 150°C	<10 min
A11	High	Green	7000cps	0.30mm	-60 to 150°C	<15 min
A14	Medium	Yellow	1500cps	0.20mm	-60 to 150°C	<15 min
A18	High	Green	2100cps	0.21mm	-60 to 150°C	<60 min



Industrial UV curing adhesives are single component and cure upon exposure to ultra violet light. These UV resins form high strength, crystal clear and environmentally resistant bonds to glass, metal and a variety of plastics. ISO 9001 International Quality Standard. In 20ml, 50ml, 250ml or 1 litre bottles.

### UV Cure Glues

Code	Description	Colour	Viscosity	Shore	Temp Range
UV01	Plastic to Glass	Clear	500cps	60D	-40 to 120°C
040111	Glass to Metal	Clear	6000cps	72D	-40 to 120°C
UV3088	Glass to Plastic	Clear	2000cps	75D	-40 to 120°C
040116	Glass to Plastic	Clear	2000cps	75D	-40 to 120°C
UV4006	Plastic to Plastic	Clear	500cps	60D	-40 to 120°C
120908HS	Plastic to Metal	Clear	750cps	68D	-40 to 120°C
0810-2000	Plastic Doming	Clear	1750cps	65D	-40 to 120°C
BB2	Plastics/ Glass	Clear	1750cps	60D	-40 to 120°C
BB3	Plastics/ Glass	Clear	50cps	60D	-40 to 120°C

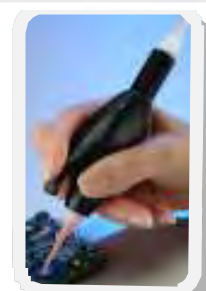

High performance PU adhesives are versatile and easy to use, solvent free they provide excellent adhesion. These can be used to bond or repair a wide range of materials. Supplied in easy to use dispensing cartridges. ISO 9001 International Quality Standard.

## PU Adhesives

Code	Description	Colour	Viscosity	Cure	Ratio
EP2001	Plastic Repair PU Rigid	Black	50k cps	1 min	1:1
EP2005	Plastic Repair PU Semi	Black	60k cps	1 min	1:1
EP2001-5	Plastic Repair PU Rigid	Black	50k cps	5 min	1:1
EP4001	Metal to Metal PU Weld	Black	50k cps	20 min	1:1
EP4002	Metal to Metal PU Weld	Black	50k cps	60 min	1:1
EP5001	Boat body repair PU	White	50k cps	10 min	1:1
EP6001	Caravan repair PU	White	50k cps	10 min	1:1
EP8001	Concrete repair 50ml	Grey	50k cps	30 min	1:1
EP8001-15	Concrete repair 180ml	Grey	50k cps	30 min	1:1
EP9001	General repair PU 50ml	Grey	50k cps	1 min	1:1
EP9001-15	General repair PU 180ml	Grey	50k cps	1 min	1:1
EP8-50	Flexible PU resin	Clear	5k cps	30 min	1:1
EP6-40	Flexible PU resin	Clear	3k cps	20 min	1:1
EP7-50	Semi Flexible PU resin	Clear	3k cps	15 min	1:1
EP9-50	Rigid PU resin	Clear	5k cps	30 min	1:1



High performance epoxy adhesives are versatile and easy to use, solvent free they provide excellent adhesion. These can be used to bond or repair a wide range of materials. Supplied in easy to use dispensing packages. ISO 9001 International Quality Standard.

## Epoxy Resins

Code	Description	Colour	Cure	Size
EP4	Multi purpose epoxy resin	Clear	5 min	28g
EP5	Fast set steel toughened	Grey	5 min	28g
EP3	Aqua putty stick repair stick	Green	5 min	56g
EP1	Multi purpose fast set putty	Grey	5 min	56g
EP2	Steel putty stick repair stick	Grey	5 min	56g
6000-50	Crystal clear acrylic resin	Clear	90 sec	50ml
894PE	Black potting compound	Black	60 min	50ml



Industrial  
Grade Safe

Silicone Free  
Components

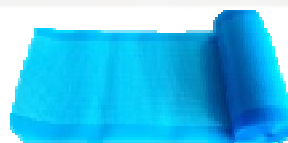



Adhesive Dispensing Ltd  
Unit 501, MK Business Centre  
Foxhunter Drive, Linford Wood  
Milton Keynes, Bucks, MK14 6GD, UK

Tel. +44 (0) 1908 686660  
Fax. +44 (0) 1908 686836  
[sales@adhesivedispensing.co.uk](mailto:sales@adhesivedispensing.co.uk)  
[www.adhesivedispensing.co.uk](http://www.adhesivedispensing.co.uk)