



**Adhesive Dispensing Ltd**

Solutions customers stick with...

## Precision Dispensing Solutions Catalogue

Adhesive dispensing systems, components and consumables, metering valves, bench top robots, sealant guns, fume extraction, accessories and adhesives.

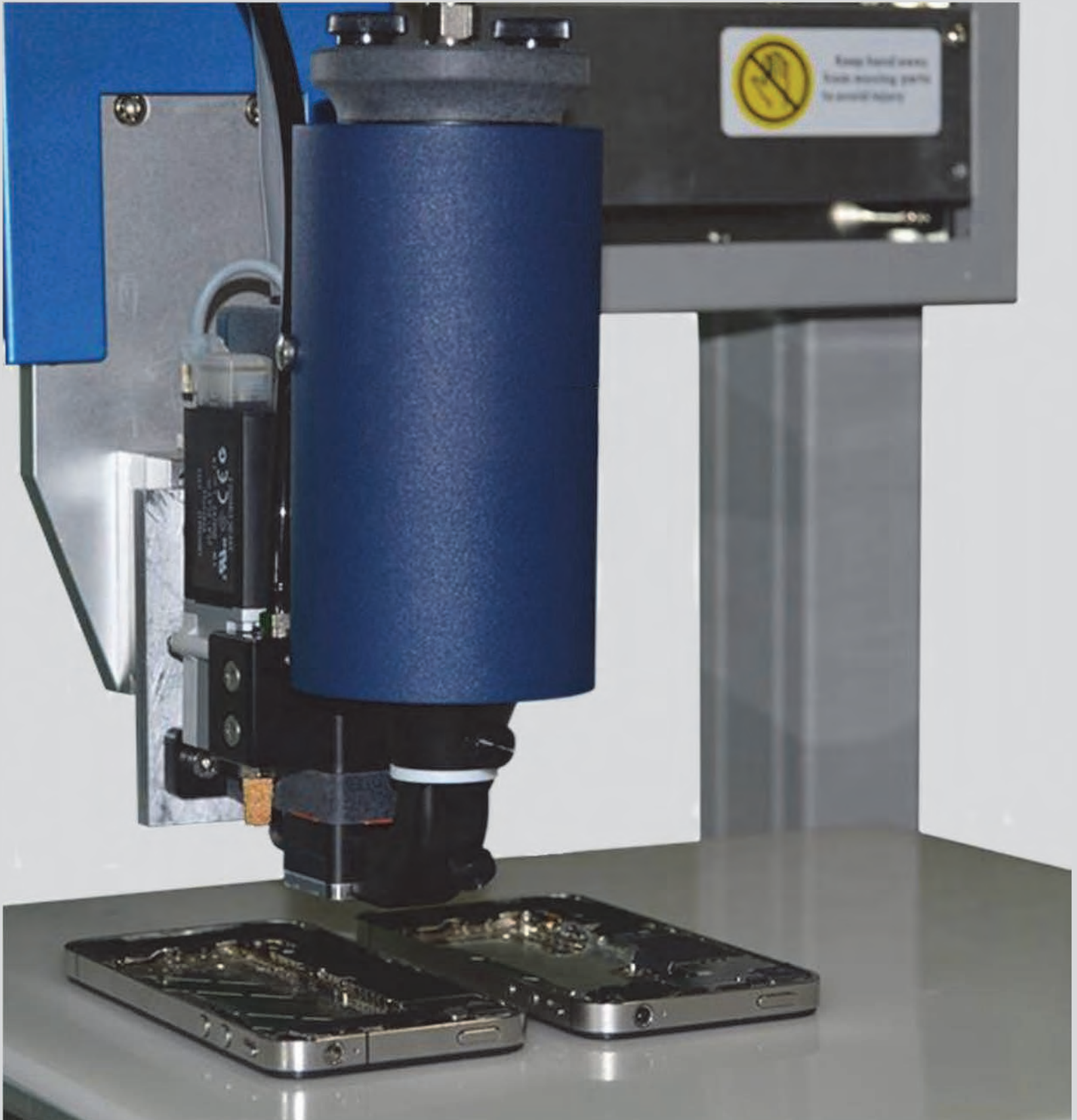

[adhesivedispensing.com](http://adhesivedispensing.com)

## About Us

We are a company drawing from over 30 years of industry experience in fluid dispensing applications, and material repackaging. With a strong believe that the highest quality products, innovative features, competitive pricing, on-time deliveries and customer support are the essential factors that create the successful partnership with our clients. We offer leading edge dispensing systems and industrial dispensing components developed to meet the application demands of our customers while maximising the total cost savings.

Our products range from a selection of bench-top air-powered dispensers to precision moulded disposable components, applicator guns, metering valves, rotary tables and XYZ robots. Adhesive Dispensing Limited meets our customers needs, from supporting low-volume applications, prototype assembly, field based work, automated production cells or high volume assembly lines. We also work with many universities and schools.

Helping customers in aerospace, electronics, automotive, medical device, engineering and general assembly. We offer customers the technology and support to increase both efficiency, reduce costs and add value for their applications. We also have expertise in providing syringes and barrels contract repackaged with a customers specified adhesive, grease or paste as well as a wide range of performance adhesives. Supplied ready-to-use.

We hold substantial stocks of dispensing products for next day delivery, we are ISO9001:2015 quality certified and all products are CE approved. We have our industrial warehouse and offices based in Milton Keynes close to all main roads. We welcome visitors by pre-appointment to discuss projects or test equipment. Or please contact us to have a sales engineer visit your site with product samples and provide an equipment demonstration. We look forward to working with you.

Please contact our Product Specialists if you would like a specific quotation or for technical support.

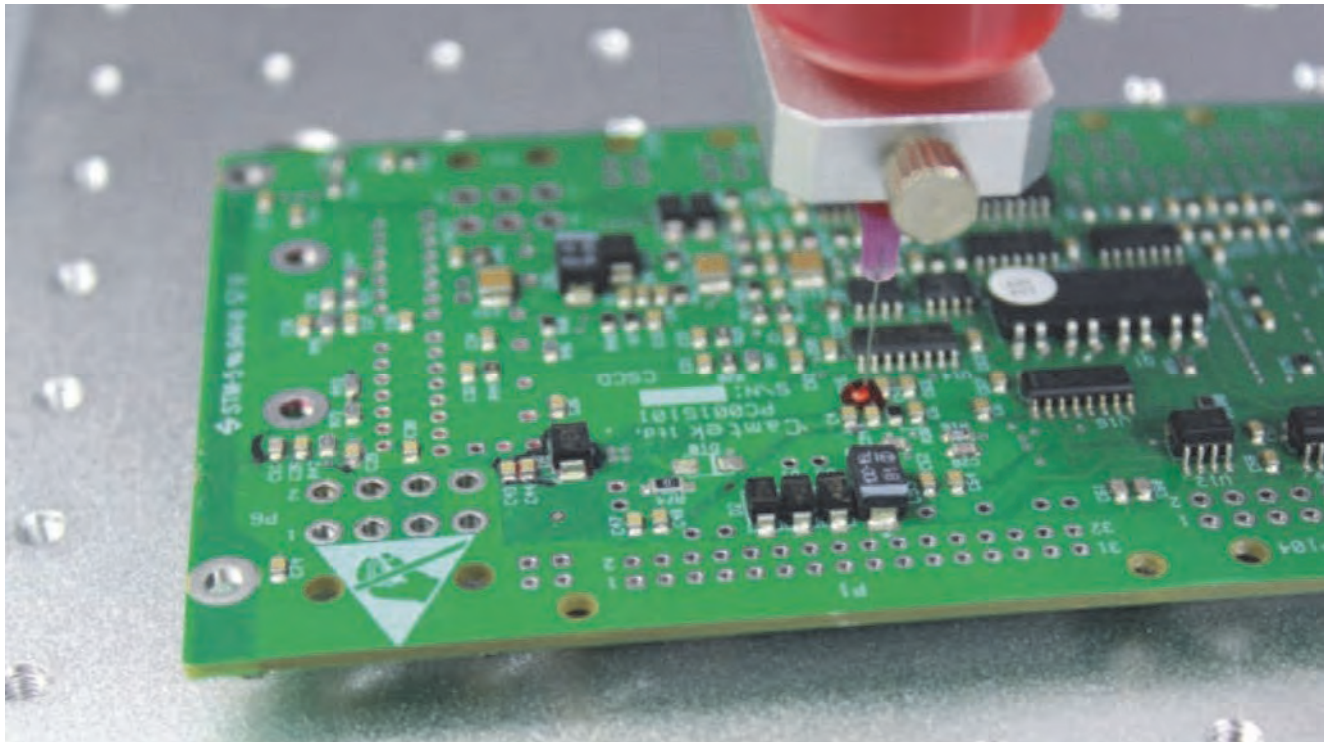

### Ordering Process

Our simple order process allows us to pack and despatch many products typically within 48 hours. After placing your order an email confirmation is sent to you. Our products are conveniently despatched via couriers (UK, Europe and Worldwide). Once goods despatch, an email is sent confirming shipment and the tracking code.

### One-Year (12 months) Warranty

With our commitment to deliver an extraordinary service and high calibre products, we guarantee to the original purchaser that your order is received free from defects in material or workmanship for a period of one year from the original purchase date. This warranty applies to the product in normal use and is subject to all product usage documentation. Should you need to return a faulty ADL product, please contact us for a Return Merchandise Authorisation (RMA) before sending back.



# Contents

## One Component Dispensing

Manual 3cc, 5cc, 10cc, 30cc, 55cc Syringe Guns, Syringe Plunger Rods	4, 5
Pneumatic Analog Timed Shot Dispensers, Pneumatic Non Timed Footvalve Dispensers	5
Pneumatic Analog Timed Shot Dispensers, Pneumatic Digital Timed Shot Dispensers, Digital Rotary Table Dispenser	6
Timed Shot Dispensing Tutorial	8
Benchtop Dispensing Robots, Smart Robot Software, Robot Brackets, Accessories	9, 10, 11, 12
700 Series Syringe Barrels, Pistons, Adapter Assemblies, Manual Plungers, End Caps, Tip Caps	13, 14
ADV Series Rounded Syringe Barrels, Pistons, Caps, Adapter Assemblies	15
400 Series Syringe Barrels, Pistons, Plunger Rods, Adapter Assemblies	16
Large Size Air Barrels, Pistons, Caps, Manual Syringes	17
Luer Lock Dispensing Tip Guide, Luer Lock Dispensing Tips	18, 19, 20, 21, 22, 23
Air Free Peristaltic Pump Dispensers. PTFE Teflon Tubing. Replacement Wand	61
Vacuum Pick and Place Machines. Rubber Vac Cups	61
Luer Lock Dispensing Bottles. Touch Pump Solvent Bottles. Brushes. Spring Pens and Bottles	62
Manual 2.5oz, 6oz, 8oz, 10oz, 12oz, 20oz, 24oz, 29oz, 32oz, 310ml, 400ml, 600ml Single Cartridge Guns	24, 25, 26, 27, 28, 29
Pneumatic 2.5oz, 6oz, 8oz, 10oz, 12oz, 20oz, 32oz, 310ml, 400ml, 600ml Single Cartridge Guns, Airline Hoses	30, 31, 32, 33
Pneumatic 2.5oz, 6oz, 8oz, 12oz Single Cartridge Guns, Gun Retainer Sleeves	34
Battery Rechargeable 2.5oz, 6oz, 8oz, 10oz, 12oz, 20oz, 32oz Single Cartridge Guns	35
Cartridge Retainer Systems, Air Caps, Accessories	36
Cartridge Reservoirs, Cartridge Plungers, Flange Caps, Cartridge Kits	37
Plastic Nozzles, Metal Nozzles, Cartridge Tip Adapters, Sealant Adapters	38
Cartridge Retainer Bench Stands, Syringe Filling Stations, Pail Pumps	39
Aerospace Smoothing Tools, Scrapers, Spatulas	42, 43
Manual Hand Lever Dispensing Pen Valves	63
Manual Hand Lever Dispensing Pinch Tube Valves. Replacement Punch Tubes. Air Operated Pinch Valve	64
Air Operated Diaphragm Valves	65
Air Operated Needle Valves	66
Air Operated Spool Valves	67
Motor Driven Auger Valves. PC Pump Valve	68
Spray Valves. Spray Valve Smart Controller	69, 70
TS9000 Jet Valve and Controller	72
TS9800 Piezo Jet Valve, TS980 Jet Valve Controller	73
TS9300HM Hot Melt Jet Valve and Controller	74
TS9200D Jet Valve and Controller	75
TS550R, TS560R, TS570R, TS580R Smart Valve Controllers	76, 77
Pressure Pot Tanks, Cartridge Reservoir Feed Systems	78, 79
Fluid Line Tubes, Feed Tubing, Stainless Steel Tubing	80
Plastic and Metal Fittings. Stopcock Fittings	81, 82, 83, 84
Fume Extraction, Fume Recirculatory Systems, Fumed Ducted Systems, Chemical Ducted Storage	85, 86
Cyanoacrylate Adhesives, UV Cure Adhesives, Threadlock Adhesives, Epoxy Resins, Polyurethanes	87, 88, 89

## Two Component Dispensing

Techkit 2.5oz, 6oz, 8oz, 10oz, 20oz Dual Cartridges and Accessories	40
Techkit, Semkit Electric Cartridge Mixing Machines, Pneumatic Cartridge Mixing Machines, Mixer Drill Fitting	41
Manual 50ml, 150ml, 300ml Dual Cartridge Guns	44
Manual 200ml, 300ml, 400ml Dual Cartridge Guns	45
Manual 300ml, 400ml, 600ml, 750ml, 825ml, 1200ml Dual Cartridge Guns	46
Manual 200ml, 400ml, 450ml, 600ml Dual Cartridge Guns, 330ml, 380ml Coaxial Dual Guns	47
Manual 150ml, 200ml, 330ml, 380ml, 385ml, 400ml, 585ml Dual Cartridge Guns	48
Pneumatic 50ml, 75ml, 150ml, 200ml Dual Cartridge Guns	49
Pneumatic 200ml, 250ml, 300ml, 400ml, 600ml Dual Cartridge Guns	50
Pneumatic 365ml, 385ml, 400ml, 585ml, 600ml, 825ml, 1200ml, 1500ml Dual Cartridge Guns	51
Battery Rechargeable 50ml, 350ml, 365ml, 380ml, 400ml, 450ml, 585ml, 600ml Dual Cartridge Guns	52
Dual Cartridges and Piston Sets 25ml, 50ml, 75ml. Bayonet Static Mixer Nozzles A-System	53
Dual Cartridges and Piston Sets, 25ml, 50ml, 75ml, Cap Static Mixer Nozzles B-System	54
Dual Syringes and Piston Sets, 2.5ml, 3ml, 5ml, 10ml. Cap Static Mixer Nozzles K-System	55
Dual Syringes and Piston Sets, 200ml, 400ml, 600ml. Bell Mouth Static Mixer Nozzles C-System	55
Static Mixer Nozzles Bell Mouth MCQ Series, Screw Thread MGQ Series, Screw Thread MGH Series	55
Dual Cartridges and Piston Sets, 200ml, 400ml. Cap Static Mixer Nozzles F-System	56
Static Mixer Nozzles Cap Style MFQ Series. Nozzle Converter Fittings	57
Dual Cartridges and Piston Sets, 235ml, 350ml, 600ml, 825ml, 1500ml J-System. MCH Bell Mouth Static Mixers	57
Static Mixer Nozzles Machine Type, MS-Series, ME Series, MEF Series, MEFX Series	58
Rotary Mixer Nozzles Machine Type, MRS Series. Metal Machine Mixer Nozzle Shrouds	59
Metal Machine Mixer Nozzle Shrouds. Pneumatic 2K Dispenser Retainer ADV Series	59, 60
Mixer Nozzle Luer Lock Tip Adapters. Cartridge Lock Nut Fitting	60
Air Operated Dual Component Dispensing Valves and Controllers	71



## Syringe barrel dispensers



### Reusable Syringe Barrel Hand Plunger Rods

Where an application requires hand operated dispensing, the TS Series Rods provide improved control, cleaner and easier operation. Unlike hypodermic syringes with tight fitting rubber pistons, the TS plunger rods use the same plastic pistons and barrels as used on our air-powered dispensers for very little effort to apply thick fluids. And the unique design means instant cut-off when pressure is released. No drips or ooze. Available as rod or with barrel, piston and assorted tip kits.

**Material:** Polypro, Nylon  
**Colour:** Black/ Grey  
**Barrel Sizes:** 3cc, 5cc, 10cc, 30cc  
**Length:** 90mm to 125mm  
**Weight:** 0.02kg



Size	Plunger	With Kit
3cc	TS703HP	TS703HP-KIT
5cc	TS705HP	TS705HP-KIT
10cc	TS710HP	TS710HP-KIT
30cc	TS730HP	TS730HP-KIT

### Reusable Aluminium Hand Plunger Rods

A simple reusable aluminium plunger rod for use with most syringe barrels. The rod is placed into the top of the barrel and used to push against the wiper piston. Easy use, easy to clean single piece product. Useful device for low volume applications, repair work or field work.

**Material:** Aluminium  
**Colour:** Blue  
**Barrel Sizes:** 3cc, 5cc, 10cc, 30cc  
**Length:** 95mm to 130mm  
**Weight:** 0.025kg



Size	Plunger	With Kit
3cc	ADQHP3	ADQHP3-KIT
5cc	ADQHP5	ADQHP5-KIT
10cc	ADQHP10	ADQHP10-KIT
30cc	ADQHP30	ADQHP30-KIT

### TS Series Syringe Guns

Manual hand lever dispensers for the controlled deposits of epoxies, gels, silicones, sealants, RTV's, greases, pastes and adhesives. Guns are robust enough for regular use yet portable and are suited for low volume assembly work, repair work or field work. Available as the applicator only or with component kits. Use with all standard barrels.

**Material:** Glass Filled Nylon  
**Thrust:** 1.2kN Max.  
**Barrel Sizes:** 10cc, 30cc, 55cc  
**Length:** 235mm to 295mm  
**Weight:** 0.15kg  
**Force Ratio:** 7:1



Size	Gun	With Kit
10cc	TS710SG	TS710SG-KIT
30cc	TS730SG	TS730SG-KIT
55cc	TS755SG	TS755SG-KIT

### Adjustable Shot Syringe Gun

These guns have an adjustable pin allowing the user to change the distance the rod moves to adjust the shot size. A metal rod with rubber end and O-ring seal. Barrels twist onto the flange fitting for a secure attachment. Easy rod retraction for barrel changing.

**Material:** Polypro, Nylon  
**Thrust:** 1.20kN Max.  
**Barrel Sizes:** 30cc Only  
**Length:** 215mm  
**Weight:** 0.14kg  
**Force Ratio:** 7:1



Size	Gun	With Kit
30cc	DG30	DG30-KIT

### 10cc Syringe Hand Applicator

Manual micro-dot applicator for 10cc sized syringe barrels. Allows a fixed deposit size by adjusting the micro-screw. When the lever is pressed, the rod moves a fixed distance. Available as applicator only or with full component kit. Can be used with liquids including UV cure adhesives.



**Material:** Aluminium  
**Colour:** Black  
**Sizes:** 10cc Only  
**Length:** 195mm  
**Weight:** 0.100kg

Size	Plunger	With Kit
10cc	HLD-10	HLD-10-KIT

### TSI Series Syringe Guns

Blue colour body syringe guns from Techcon Systems Inc. Same specification as red version.



**Material:** Glass Filled Nylon  
**Thrust:** 1.2kN Max.  
**Sizes:** 10cc, 30cc, 55cc  
**Length:** 235mm to 295mm  
**Weight:** 0.15kg  
**Force :** 7:1

Size	Gun	With Kit
10cc	TS710SG-TSI	TS710SG-TSI-KIT
30cc	TS730SG-TSI	TS730SG-TSI-KIT
55cc	TS755SG-TSI	TS755SG-TSI-KIT

### Syringe Gun Spares

Replacement plunger rods for the TS and TSI series syringe guns. And rubber O-rings for both guns supplied in packs of (10).



**Material:** EPR O-Ring  
**Colour:** Black  
**Mfg.:** Techcon  
**Pack:** 10

**Material:** Nylon (Rod)  
**Colour:** Grey  
**Mfg.:** ADL  
**Pack:** 1

Size	Rod	O-ring
10cc	71000ROD	P3017EPK
30cc	73000ROD	P3018EPK
55cc	75000ROD	P3018EPK

### AD Series Syringe Guns

Hand applicators for applying glues and gels. This version is designed for low to medium viscosity materials. The barrel is slotted to the top and a hinge secures in place. A lever at the back of the gun allows the rod to be pulled back when changing barrels. Gun only or with kit.

**Material:** Polyethylene  
**Thrust:** 1.2kN Max.  
**Barrel Sizes:** 30cc, 55cc  
**Length:** 275mm to 295mm  
**Weight:** 0.12kg  
**Force Ratio:** 7:1



Size	Gun	With Kit
30cc	AD730MSG	AD730MSG-KIT
55cc	AD755MSG	AD755MSG-KIT

### MPD100 Syringe Gun

Manual syringe applicator gun for 50 and 80ml sized cartridge barrels. Slot-in barrel design for secure attachment. Easy trigger device for long use. Lever to pull rod back when replacing barrels. Gun only or supplied with full barrel and tip kit.

**Material:** Glass Filled Nylon  
**Thrust:** 2.5kN Max.  
**Barrel Sizes:** 50, 80ml  
**Length:** 222mm  
**Weight:** 0.2kg  
**Force Ratio:** 16:1



Size	Gun	With Kit
50ml/80ml	MPD100	MPD100-KIT

### MPD32 Syringe Gun

Manual syringe applicator gun for 30cc barrels only. Slot-in barrel design for secure attachment. Easy trigger device for long use. Lever to pull rod back when replacing barrels. Gun only or with kit.

**Material:** Glass Filled Nylon  
**Thrust:** 2.5kN Max.  
**Barrel Sizes:** 30cc Only  
**Length:** 210mm  
**Weight:** 0.2kg  
**Force Ratio:** 16:1



Size	Gun	With Kit
30cc	MPD32	MPD32-KIT

### MD30 Syringe Gun

Gun with an adjustable pin allowing to adjust the shot size. A metal rod with rubber end and O-ring seal. Barrels twist onto the flange fitting for secure attachment. Gun only or with kit.

**Material:** Steel, Nylon  
**Thrust:** 1.2kN  
**Barrel Sizes:** 30cc Only  
**Length:** 215mm  
**Weight:** 0.3kg  
**Thrust Ratio:** 7:1



Size	Gun	With Kit
30cc	MD30	MD30-KIT

### MGB30 Syringe Gun

Gun with an adjustable pin allowing to adjust the shot size. A nylon rod with flat end and O-ring seal. Barrels twist onto the flange fitting for secure attachment. Gun only or with kit.

**Material:** Nylon  
**Thrust:** 1.20kN Max.  
**Barrel Sizes:** 30cc Only  
**Length:** 215mm  
**Weight:** 0.13kg  
**Force Ratio:** 7:1



Size	Gun	With Kit
30cc	MGB30	MGB30-KIT

### MSG30 Syringe Gun

Gun with an adjustable pin allowing to adjust the shot size. A metal rod with metal end and O-ring seal. Barrels twist onto the flange fitting for secure attachment. Gun only or with kit.

**Material:** Steel/ Aluminium  
**Thrust:** 1.2kN  
**Barrel Sizes:** 30cc Only  
**Length:** 225mm  
**Weight:** 0.4kg  
**Thrust Ratio:** 7:1



Size	Gun	With Kit
30cc	MSG30	MSG30-KIT

### Timed Shot Analog Pneumatic Benchtop Dispenser

Electro-pneumatic timed shot benchtop dispenser for making repeat deposits of watery liquids to thick pastes. With an adjustable timer, steady mode and vacuum suck-back to prevent drips. Supplied with a choice size of syringe barrels, precision tips and accessories. Includes foot pedal and electric finger switch. Analog adjustable timer knob.



**Pressure In:** 70-100 PSI  
**Pressure Out:** 0-100 PSI  
**Dimensions:** 225x192x63mm  
**Weight:** 1.47kg  
**Timer:** 0.01-18 Second  
**Voltage:** 220V AC

Type	Part Code
Timed Shot, Vacuum	ADL100

### Floor Mounted Pneumatic Only Dispenser

Pneumatic foot valve dispensers used with syringe barrels and cartridge reservoirs. Non-timed, simple machines that run from any compressed air source. Adjustable air regulators to dispense low to high viscosity materials. "V" version has vacuum suck-back to prevent drips.

**Pressure In:** 70-100 PSI  
**Pressure Out:** 0-100 PSI  
**Dimensions:** 200x127x127mm  
**Weight:** 1.82kg  
**Timer:** None  
**Voltage:** None



Type	Part Code
Non-Timed	TS924
Non-Timed, With Vacuum	TS924V
Non-Timed	AD924
Non-Timed, With Vacuum	AD924V

## Syringe barrel dispensers

### Timed Shot Analog Pneumatic Benchtop Dispenser

Timed shot pneumatic dispenser. 0-100 PSI for dispensing watery liquids to thick pastes. Vacuum suck-back to prevent drips. Rotary time knob. Footswitch and finger switch supplied.

**Pressure In:** 70-100 PSI  
**Pressure Out:** 0-100 PSI  
**Dimensions:** 195x216x60mm  
**Weight:** 2.50kg  
**Timer:** 0.01-1 Second  
**Voltage:** 220V AC



Type	Part Code
Timed Shot, Vacuum	ADL810

### Timed Shot Analog Pneumatic Benchtop Dispenser

Timed shot pneumatic dispenser. 0-100 PSI for dispensing watery liquids to thick pastes. Vacuum suck-back to prevent drips. Rotary time knob. Footswitch and finger switch supplied. Dual voltage version.

**Pressure In:** 70-100 PSI  
**Pressure Out:** 0-100 PSI  
**Dimensions:** 210x241x70mm  
**Weight:** 2.10kg  
**Timer:** 0.01-31 Second  
**Voltage:** 110 to 220V AC



Type	Part Code
Timed Shot, Vacuum	TS9150

### Timed Shot Digital Pneumatic Benchtop Dispenser

Timed shot pneumatic dispenser. 0-100 PSI for dispensing watery liquids to thick pastes. Vacuum suck-back to prevent drips. Digital timer LED display, teach mode. Footswitch and finger switch supplied.

**Pressure In:** 70-100 PSI  
**Pressure Out:** 0-100 PSI  
**Dimensions:** 246x145x65mm  
**Weight:** 2.90kg  
**Timer:** 0.001-99 Second  
**Voltage:** 220V AC



Type	Part Code
Timed Shot, Vacuum	1000T
110V AC Version	1000TE

### Timed Shot Digital Pneumatic Benchtop Dispenser

Timed shot pneumatic dispenser. 0-100 PSI for dispensing fluids and pastes, 0-15 PSI for watery liquids. Vacuum suck-back to prevent drips. Digital timer LCD display, shot counter, I/O port. Footswitch supplied.

**Pressure In:** 70-100 PSI  
**Pressure Out:** 0-100 PSI  
**Dimensions:** 195x216x60mm  
**Weight:** 2.50kg  
**Timer:** 0.01-1 Second  
**Voltage:** 220V AC



Type	Part Code
0-100 PSI Standard	TS250
0-15 PSI Low Pressure	TS255

### Timed Shot Advanced Digital Benchtop Dispenser

Timed shot pneumatic dispenser. 0-100 PSI for dispensing fluids and pastes, 0-15 PSI for watery liquids. Vacuum suck-back to prevent drips. Digital timer LCD display, shot counter, I/O port, timer memory store, teach mode, dual air outlet. Footswitch supplied.

**Pressure In:** 70-100 PSI  
**Pressure Out:** 0-100 or 0-15 PSI  
**Dimensions:** 152x165x178mm  
**Weight:** 1.2kg  
**Timer:** 0.008-60 Second  
**Voltage:** 110 to 220V AC



Type	Part Code
0-100 PSI Standard	TS350
0-15 PSI Low Pressure	TS355

### Timed Shot Advanced Digital Benchtop Dispenser

Timed shot pneumatic dispenser. 0-100 PSI for dispensing all fluids and pastes. Vacuum suck-back to prevent drips. Digital timer LED display, shot counter, timer memory store, teach mode, self auto cycle mode without constant activation. Footswitch and finger supplied.

**Pressure In:** 70-100 PSI  
**Pressure Out:** 0-100  
**Dimensions:** 220x210x67  
**Weight:** 1.59kg  
**Timer:** 0.01-99.99 Second  
**Voltage:** 110 to 220V AC



Type	Part Code
Timed Shot, Vacuum	AD1001

### Timed Shot Advanced Digital Benchtop Dispenser

Timed shot pneumatic dispenser. 0-100 PSI for dispensing all fluids and pastes. Vacuum suck-back to prevent drips. Digital timer LED display, shot counter, timer memory store, teach mode, self auto cycle mode without constant activation. Footswitch and finger supplied.

**Pressure In:** 70-100 PSI  
**Pressure Out:** 0-100 PSI  
**Dimensions:** 246x145x65mm  
**Weight:** 2.90kg  
**Timer:** 0.001-99 Second  
**Voltage:** 220V AC

Type	Part Code
Timed Shot, Vacuum	2000T



### Timed Shot Advanced Digital Benchtop Dispenser

Z-axis benchtop rotary table for applying liquids and pastes in a circular pattern as parts rotate below on a spindle. Adjustable speed clockwise/anti-clockwise rotation, auto index head down/up, vacuum suck-back, timed deposit control. Foot pedal or panel switch control. For parts up to 300mm diameter. Digital LCD display and adjustable air regulator.

**Pressure In:** 70-100 PSI  
**Pressure Out:** 0-100 PSI  
**Dimensions:** 315x410x545mm  
**Weight:** 4.10kg  
**Timer:** 0.01-99 Second  
**Voltage:** 220V AC

Type	Part Code
Rotary, Vacuum, Digital	ADL-300





### Dispenser Air Filters

Use a 5-micron air filter on the feed into the dispenser to protect, reduce moisture and small contaminants. Standard filter or with a regulator and gauge. 1/4" Thread.



Type	Part Code
Standard Filter	TSD800-6EL
With Regulator	TSD800-6FR

### Syringe Barrel Stand Assembly

Syringe barrel bench stand for all barrel size for hands free dispensing. The barrel is locked at the luer outlet end and can be adjusted for height and angle.



Type	Part Code
Stand	560021

### Syringe Barrel Stand Assembly

Syringe barrel bench stand for 30cc and 55cc barrels for hands free dispensing. The barrel is held in place by the body and can be adjusted for height and angle.



Type	Part Code
Stand	AD4000-30CC

### Dispense Valve Stand Assemblies

Valve bench stands for hands free dispensing. Can be adjusted for height and angle. Supplied with metal base, upright rod, clamp. For a range of dispensing valve types.

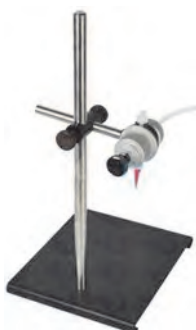

For Valves	Part Code
Pinch	TS918-1212
Diaphragm	TS918-5622
Needle	TS918-5420
Spool	TS918-941A
Spray	TS918-5540
Auger	TS918-5000

### Cartridge Retainer Stand

Cartridge retainer stand for hands free dispensing. Adjustable for height and angle. Use with 2.5oz, 6oz, 8oz and 12oz size aluminium cartridge retainers.



Type	Part Code
Stand	AD4000-GSOC

### Dispenser Electric Finger Switches

Used as an alternative to the foot switch on a dispenser. For the full range of dispensers.



For Dispenser	Barrel Sizes	Part Code
TS250/ TS350	All	DX9010
TS250/ TS350	30cc, 55cc	AD9012
1000T, ADL810	All	ADL9050
TS9150, ADL100	All	ADL9060
1000T, ADL810	30cc, 55cc	AD9010
TS9150, ADL100	30cc, 55cc	AD9065

### Dispenser Barrel Stands

All dispensers are shipped with a basic barrel stand that can also be ordered separately. Fits 3cc, 5cc, 10cc, 30cc, 55cc size barrels.



Type	Part Code
Metal/Plastic	SH300
Metal Only	TS100

### Syringe Barrel Storage Racks

Filled syringe barrels can be stored in these bench racks.



Type	Part Code
3cc, 5cc, 10cc, 30cc, 55cc	SYR19B
3cc Plastic Rack	SR03-90W
5cc Plastic Rack	SR05-60W
10cc Plastic Rack	SR10-40W
30cc/55cc Plastic Rack	SR30-24W

### Cartridge Retainer with Stand Assembly

Cartridge retainer bench stand for hands free dispensing. Can be adjusted for height and angle. Supplied with metal retainer, cap and air hose. For Techcon and Semco cartridges.



Size	Part Code
2.5 oz	TS918-2
6 oz	TS918-6
8 oz	TS918-8
10 oz	TS918-10
12 oz	TS918-12
20 oz	TS918-20

### Syringe Barrel Storage Racks

General purpose bench stand for hands free dispensing. Can be adjusted for height and angle. Supplied with metal base, rod, and clamp. Use for syringe barrels, cartridges, valves. Low cost solution.



Type	Part Code
Stand	STD0140

### Production Master Stand and Brackets

Benchtop stands, brackets, rods, clamps and fittings for use with cartridge retainers syringe barrels and dispense valves.

Part Code	Description
918-033-000	Base Stand & Upright Rod Assembly
918-000-012	Rod Clamp Assembly
918-000-011	Syringe Bracket Assembly
918-000-013	TS941/TS941 Valve Bracket
918-110-004	310ml (10oz) Cartridge Bracket
918-000-039	20oz/ 32oz Cartridge Bracket
918-000-007	2.5, 6, 8, 12oz Cartridge Bracket
918-000-016	Spool Valve Bracket
918-000-048	Valve Mounting Bracket
1212-000-006	Valve Rod 4" Long Stainless Steel
918-000-009	Mounting Rod 6" Long Stainless Steel
918-000-002	Production Master Air Hose 5 ft. Long



Timed Pressure Dispensing

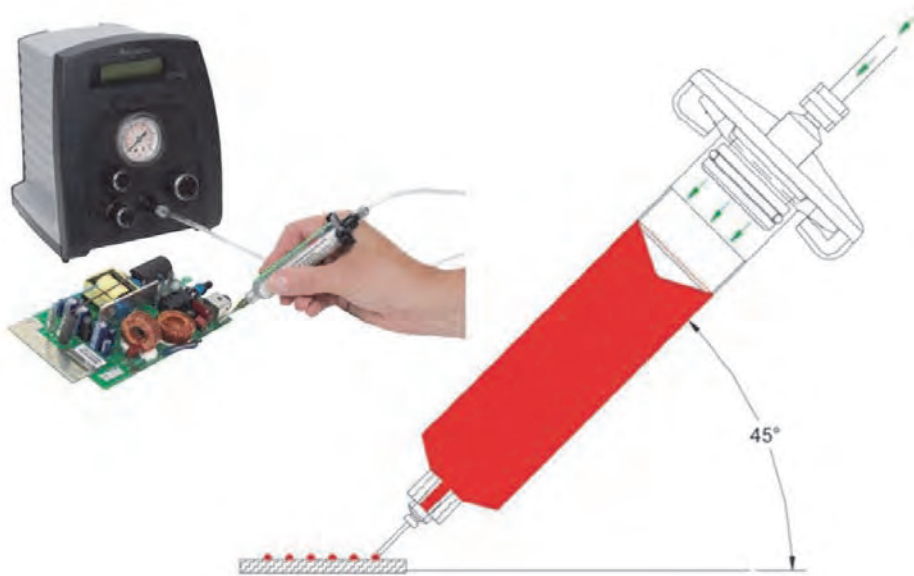

Time pressure dispensing is the most common dispensing method used today for applying dots and beads of liquids and pastes. Its popularity stems from the need for process control and the fact that it is possible to dispense from disposable containers without the need for cleaning or fluid contamination.

Our time-pressure dispensers deliver a measured amount of air pressure, for a measured amount of time, to a pre-filled syringe barrel. This controlled shot of air pressure forces material out of the delivery end of the barrel, through a dispensing tip and out to the application surface.

A vacuum suck-back prevents watery liquids from dripping and thicker materials from oozing. So a fast and consistent deposit without guesswork.

**Basic Dispensing Guidelines**

- Small Shot Size = small dispensing tip, low fluid pressure, short dispense time
- Large Shot Size = larger dispensing tip, higher fluid pressure, longer dispense time
- Low Viscosity Fluid = small dispensing tip, low pressure, time as required
- High Viscosity Fluid = larger dispensing tip (tapered dispensing tip recommended), high pressure, time as required
- Position syringe barrel at 45° angle
- Position the dispensing tip close to the work surface then activate the dispense cycle and keep the syringe barrel in the same position until the cycle is completed
- If vacuum “suck-back” is needed, use only enough vacuum to draw back fluid into the dispense tip. Excessive vacuum could draw air into the fluid and also could draw fluid into the dispenser.

Viscosity Chart	
Material	Viscosity (Centipoise)
Water	1
Milk	3
Castor Oil	1000
Maple Syrup	5000
Honey	10000
Chocolate Syrup	25000
Ketchup	50000
Sour Cream	100000
Peanut Butter	250000
Shortening	1200000

Shot Size Chart			
Dot Diameter	Dot Volume	Dot Size (actual)	
0.010" (0.25mm)	0.0000043 cc	•	
0.020" (0.51mm)	0.00003 cc	•	
0.030" (0.76mm)	0.0001 cc	•	
0.040" (1.02mm)	0.0003 cc	•	
0.050" (1.27mm)	0.0005 cc	•	
0.060" (1.52mm)	0.0009 cc	•	
0.070" (1.78mm)	0.0015 cc	•	
0.080" (2.03mm)	0.0022 cc	•	
0.090" (2.29mm)	0.0031 cc	•	
0.100" (2.54mm)	0.0043 cc	•	



**Factors Affecting Dispensing**

- Pressure: Increasing fluid pressure will increase dot size and vice versa
- Time: Increasing dispense time will increase dot size and vice versa
- Dispensing Tip Size: Larger inside diameter (orifice) needle results in bigger dot size

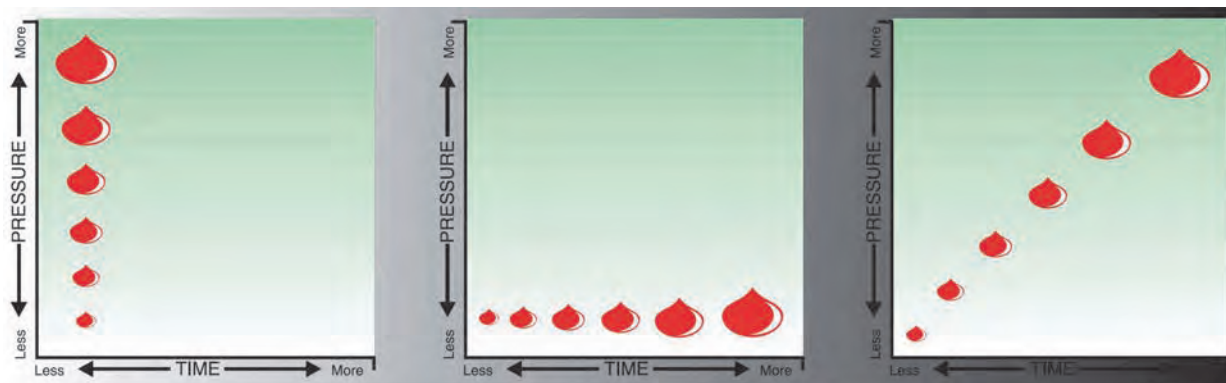



**TSR Series 3 Axis XYZ Robotic Dispensers**

TSR bench-top dispensing robots are easy to program, simple to operate and compatible with all valve types and controllers. These versatile dispensing platforms deliver consistent, high performance dispensing results at an affordable price.

Designed and configured specifically for fluid dispensing applications, Techcon robots provide total control over fluid placement, from beads, arcs and circles to repeated timed dots. Programming is simple via teach pendant.

From a general assembly manufacturer looking to automate an existing dispensing application to an engineer designing a production process from scratch, TSR dispensing robots offers unsurpassed value in automated precision fluid dispensing.

**First choose the Dispensing Robot series from the available 3 platforms:**

<b>TSR2201</b>	200mm x 200mm working area
<b>TSR2301</b>	300mm x 300mm working area
<b>TSR2401</b>	400mm x 400mm working area

**Then choose the Smart features which are available as add-on kits:**

<b>TSR-STVHKIT</b>	Software, Touch Screen, Vision, Height Sensor Kit
<b>TSR-STVKIT</b>	Software, Touch Screen, Vision Kit
<b>TSR-STHKIT</b>	Software, Touch Screen, Height Sensor Kit
<b>TSR-SVKIT</b>	Software, Vision Kit
<b>TSR-SHKIT</b>	Software, Height Sensor Kit
<b>TSR-SKIT</b>	Software Kit

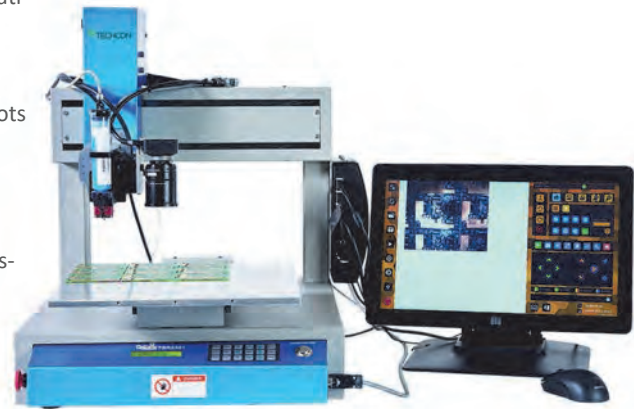

**Accessories (Light Beam safety cover for each model is available):**

Part Code	Type
TSR2200-SC	Safety cover for TSR2201
TSR2300-SC	Safety cover for TSR2301
TSR2400-SC	Safety cover for TSR2401

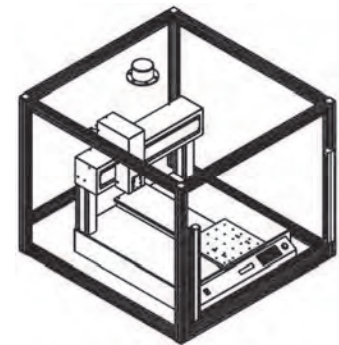

The TSR2000 series smart dispensing robot is designed specifically for precise fluid dispensing applications and it is compatible with all valve types and controllers. The user-friendly smart PC-based software makes the robot easy to program and simple to operate. Smart features include intuitive software with touch screen programming capability and CAD/DXF file import. The vision system allows the robot to automatically correct part misalignment and shorten programming time via its pattern recognition feature. The laser height sensor allows the robot to automatically adjust Z height to compensate for both surface height changes and part variation.

**Smart Dispensing Robot Benefits:**

- **Simple to program**, Quicker learning curve; more visual
- **Precise and accurate** dispensing; Improved product quality
- **Increased productivity**; less production line downtime
- **Plug and play**, easy integration into existing production line
- **Reduced** production, material, and ownership costs

**Key Features:**
**Friendly User Interface**

- PC Based Software
- Touch Screen Programming
- CAD/ DFX File Conversion

**Smart Vision**

- CMOS Colour Camera
- Automatic Alignment
- Pattern Recognition

**Laser Height Sensor**

- Pinpoint accuracy with laser height sensing
- Detects variations on the surface of a product with auto adjustment
- Prevents uneven deposits and tip or workpiece damage

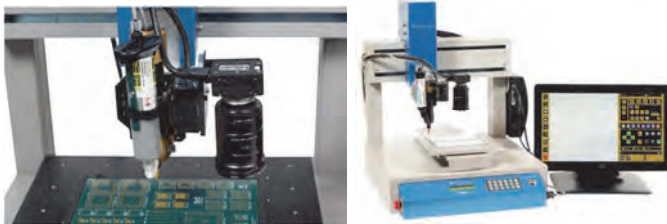

		TSR2201	TSR2301	TSR2401
<b>Power Supply</b>		100V-240V AC	100V-240V AC	100V-240V AC
<b>Power Consumption</b>		80W	80W	80W
<b>Moving Range</b>	X Axis	200mm	300mm	400mm
	Y Axis	200mm	300mm	400mm
	Z Axis	100mm	100mm	100mm
<b>Speed Range</b>	X, Y Axis	0.1-600mm/sec	0.1-600mm/sec	0.1-600mm/sec
	Z axis	0.1-200mm/sec	0.1-200mm/sec	0.1-200mm/sec
<b>Repeatability</b>	X, Y, Z Axis	0.02mm	0.02mm	0.02mm
<b>Resolution</b>	X, Y, Z Axis	0.01mm	0.01mm	0.01mm
<b>Loading Weight</b>	Base	5kg	7kg	7kg
	Head	4kg	4kg	4kg
<b>Working Ambient</b>	Temp.	0-40°C	0-40°C	0-40°C
<b>Relative Humidity</b>		20% - 90%	20% - 90%	20% - 90%
<b>Dimensions</b>	W x D x H	303 x 377 x 521mm	418 x 513 x 521mm	518 x 613 x 521mm
<b>General Purpose I/O</b>	Optional 16	4 Input/ 4 Output	4 Input/ 4 Output	4 Input/ 4 Output



## AD Series 3 and 4 Axis XYZ Robot Dispensers

AD robots are cost effective machines available in 3 axis or 4 axis versions. Supplied as robots ready to program via LCD teach pendants. Programs can be saved to memory for editing and transfer via USB. Proven robots offering high speeds, high accuracy and strong reliability over time. Heavy work load of 10kg and tool load of 6kg. In a range of working area sizes from 200mm to 600mm. 110V version is available on request.



**Repeatability:** +/- 0.02mm/ Axis  
**Resolution:** 0.01mm/ Axis  
**Data Memory:** 999 Programs  
 4,000 points / program  
**Drive Sys. / Stepping motor:** 3-phase  
**Motion Control:** PTP & CP  
**Teaching Method:** Teach Pendant  
**I/O signals:** 4 inputs / 4 outputs  
**External Interface:** RS232  
**Power Supply:** AC 220V  
**Weight:** 35kg to 55kg

Size	Part Code
300 x 300 x 100mm Robot 3 Axis	AD300N
400 x 400 x 100mm Robot 3 Axis	AD400N
500 x 500 x 100mm Robot 3 Axis	AD500N
600 x 600 x 100mm Robot 3 Axis	AD600N
300 x 300 x 100mm Robot 4 Axis	AD300R
300 x 300 x 100mm Robot 4 Axis	AD400R
300 x 300 x 100mm Robot 4 Axis	AD500R
300 x 300 x 100mm Robot 4 Axis	AD600R

## AD Series 3 Axis Right Angle XYZ Robot Dispensers

AD series of cantilever open access style robots. A robust aluminum structure prevents flexing and vibration while maintaining functionality, providing a precision multiple axis robot ideal for conveyor fed applications. Many projects also require all moving axes to be above the workstation, this range provides that capability. Resolution is 1 micron. The range will accept a tool weight of up to 6kg. 110V on request.



**Max. Speed:** 500 mm/sec  
**Repeatability:** +/- 0.02mm Axis  
**Resolution:** 0.01mm/ Axis  
**Data Memory:** 100 Programs  
**Drive System:** Ball Screw  
**Motion Control:** PTP & CP  
**Teaching Method:** Pendant  
**I/O signals:** 8 input / 8 output  
**External Interface:** RS232  
**Power Supply:** AC 220V  
**Maximum Load:** 8kg

Size	Part Code
300 x 300 x 150mm Robot 3 Axis	AD9330X
400 x 300 x 150mm Robot 3 Axis	AD9403X
400 x 400 x 150mm Robot 3 Axis	AD9440X
500 x 300 x 150mm Robot 3 Axis	AD9530X

## ADD Series Cantilever Style 3 Axis XYZ Robot Dispensers

AD series of gantry style robots. Suitable for applications involving larger products placed under the overhead 3 axis gantry or for conveyors or production lines fed underneath. Rugged aluminium frame prevents flexing and vibration. Supplied with an LCD teach pendant to create, edit and store programs whether that is rapid dotting, controlled beads, gaskets or potting. Memory stick port for backup.



**Max. Speed:** 500 mm/sec  
**Repeatability:** +/- 0.02mm Axis  
**Resolution:** 0.01mm/ Axis  
**Data Memory:** 100 Programs  
**Drive System:** Ball Screw  
**Motion Control:** PTP & CP  
**Teaching Method:** Pendant  
**I/O signals:** 8 input / 8 output  
**External Interface:** RS232  
**Power Supply:** AC 220V  
**Maximum Load:** 6kg

Size	Part Code
400mm x 300mm x 100mm 3 Axis	ADD4331D
400mm x 400mm x 100mm 3 Axis	ADD4441D
500mm x 300mm x 100mm 3 Axis	ADD5331D
500mm x 400mm x 100mm 3 Axis	ADD4441D
600mm x 300mm x 100mm 3 Axis	ADD6331D
600mm x 400mm x 100mm 3 Axis	ADD6441D

## Janome 3 and 4 Axis XYZ Robot Dispensers

Janome JR3000 series robots offer the highest levels of precision and accuracy. Available in 3 axis or 4 axis in work area sizes of 200mm to 620mm. Supplied as standard with teach pendant but options for software programming with file import are available. The 4 axis version offers head rotation for applications to the inside of the outside of parts that would not be possible with standard 3 axis.



**Max. Speed:** 900 mm/sec  
**Repeatability:** +/- 0.01mm Axis  
**Resolution:** 0.01mm/ Axis  
**Data Memory:** 100 Programs  
**Drive System:** Ball Screw  
**Motion Control:** PTP & CP  
**Teaching Method:** Pendant  
**I/O signals:** 8 input / 8 output  
**External Interface:** RS232  
**Power Supply:** AC 110/220V  
**Maximum Load:** 8kg

Size	Part Code
200mm x 200mm x 50mm Robot 3 Axis	JR3203
300mm x 320mm x 100mm Robot 3 Axis	JR3303
400mm x 400mm x 150mm Robot 3 Axis	JR3403
510mm x 510mm x 150mm Robot 3 Axis	JR3503
510mm x 620mm x 150mm Robot 3 Axis	JR3603
200mm x 200mm x 50mm Robot 4 Axis	JR3204
300mm x 320mm x 100mm Robot 4 Axis	JR3304
400mm x 400mm x 150mm Robot 4 Axis	JR3404
510mm x 510mm x 150mm Robot 4 Axis	JR3504
510mm x 620mm x 150mm Robot 4 Axis	JR3604
Optional Windows Based Software Disc	JRC-Points2



**ADD Series 3 Axis Dual Base XYZ Robot Dispensers**

Dual station benchtop dispensing robots for versatility. Dual independent 3 axis beds move with the gantry head above allowing for applications to dispense on two parts using the same program. Easy to operate LCD teach pendant for creating, editing and saving up to 999 programs. High speed systems with high accuracy and reliability. The Z height for each robot is 100mm.



Size	Part Code
400mm x 300mm x 100mm 3 Axis	ADD4331D
400mm x 400mm x 100mm 3 Axis	ADD4441D
500mm x 300mm x 100mm 3 Axis	ADD5331D
500mm x 400mm x 100mm 3 Axis	ADD4441D
600mm x 300mm x 100mm 3 Axis	ADD6331D
600mm x 400mm x 100mm 3 Axis	ADD6441D
700mm x 300mm x 100mm 3 Axis	ADD7331D
700mm x 400mm x 100mm 3 Axis	ADD7441D

Max. Speed X&Y / Z: 400 / 350 (mm/sec)  
 Repeatability: +/- 0.02mm/ Axis  
 Resolution: 0.01mm/ Axis  
 Data Memory: 999 Programs/ 4000 points  
 Drive Sys. / Stepping motor: 3-phase  
 Motion Control: PTP & CP  
 Teaching Method: Teach Pendant  
 I/O signals: 4 inputs / 4 outputs  
 External Interface: RS232  
 Power Supply: AC 220V  
 Weight: 35kg to 55kg

**AD9000 Series 3 Axis Gantry Conveyor Robot Dispensers**

Conveyor gantry robots allowing for a direct conveyor feed underneath the head for making controlled deposits of adhesives, solder paste, silicones, sealants, UV cure, epoxies and much more. Robust aluminium frame for complete stability. Supplied with teach pendant for the easy creation of programs.

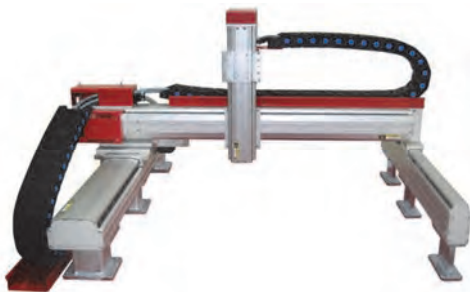

Size	Part Code
300mm x 300mm x 100mm 3 Axis	AD9300
400mm x 400mm x 100mm 3 Axis	AD9400
500mm x 500mm x 100mm 3 Axis	AD9500
600mm x 600mm x 100mm 3 Axis	AD9600
600mm x 800mm x 100mm 3 Axis	AD9680

Max. Speed X&Y/Z: 500 /320mm/sec  
 Repeatability: +/- 0.01mm/ Axis  
 Resolution: 0.01mm/ Axis  
 Data Memory: 100 Programs/ 4000 points  
 Drive System / Servo motor: 3-phase  
 Motion Control: PTP & CP  
 Teaching Method: Teach Pendant  
 I/O signals: 8 inputs / 8 outputs  
 External Interface: RS232  
 Power Supply: AC 110V/ 220V  
 Maximum Load: 8kg

**AD Series 4 Axis SCARA Robot Dispensers**

SCARA robots can be used for conveyor and assembly cell applications to dispense most materials. In 400mm and 600mm arm lengths, these high speed robots are versatile and accurate.

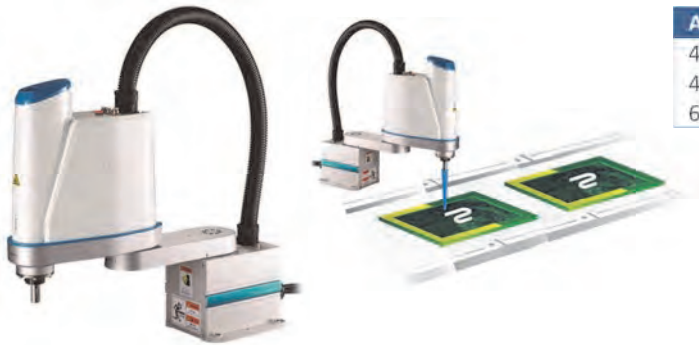

Arm Length	Part Code
400mm	ADS40L3SS1
400mm	ADS40L3S01
600mm	ADS60L3SS1

Max. Speed: 4710mm/sec  
 Repeatability: +/- 0.01mm/ Axis  
 Resolution: 0.01mm/ Axis  
 Data Memory: 100 Programs/ 4000 points  
 Drive System / Servo motor: 3-phase  
 Motion Control: PTP & CP  
 External Interface: 15 Pin D-Sub  
 Power Supply: AC 110V/ 220V  
 Maximum Load: 3kg  
 Weight: 20kg

**AD7000N/S Series 3 Axis XYZ Robot Dispensers**

Cost effective, high precision range of standard 3 axis dispensing robots for making rapid dots, lines, arcs, circles and potting of most glues, gels, adhesives, sealants and assembly fluids. Rigid frames ensure consistent results. Easy to use teach pendants.



Size	Part Code
200 x 200 x 50mm (Stepping)	AD7200N
300 x 300 x 100mm (Stepping)	AD7300N
400 x 400 x 100mm (Stepping)	AD7400N
500 x 500 x 100mm (Stepping)	AD7500N
600 x 500 x 100mm (Stepping)	AD7600N
300 x 300 x 100mm (Servo)	AD7300S
400 x 400 x 100mm (Servo)	AD7400S

Speed: 500 to 800mm/second  
 Repeatability: +/- 0.01mm/ Axis  
 Resolution: 0.01mm/ Axis  
 Data Memory: 999 Programs  
 Drive Sys. Servo Motor  
 Motion Control: PTP & CP  
 Teaching Method: Teach Pendant  
 I/O signals: 8 inputs / 8 outputs  
 External Interface: RS232  
 Power Supply: AC 110/ 220V  
 Weight: 35kg to 55kg

## AD7000V Series Smart 3 Axis XYZ Robot Dispensers

The AD7000V series use German high definition digital CCD camera technology for automatic accurate tip alignment. With an optional laser height detection system, precise weight measurement system. For variance in substrate height, the Z axis will be automatically corrected with the deposit size intelligently controlled and detected for consistency. Ideal for SMT applications, solder pastes, surface mount adhesives, etc.



**Max. Speed:** 500mm/sec  
**Repeatability:** +/- 0.01mm/ Axis  
**Resolution:** 0.01mm/ Axis  
**Data Memory:** 100 Programs/ 4000 points  
**Drive System / Servo motor:** 3-phase  
**Transmission:** Precision Ball Screw  
**Control Method:** PTP/ CP  
**I/O:** 8 Inputs/ 8 Outputs  
**Power Supply:** AC 110V/ 220V  
**Maximum Load:** 11kg  
**Weight:** 20kg

Size	Part Code
300mm x 300mm x 100mm 3 Axis	AD7300V
400mm x 400mm x 100mm 3 Axis	AD7400V

## AD7000N/W Series Two Component 3 Axis XYZ Robot Dispensers

A dispensing robot for two-part resins, epoxies, silicones, polyurethanes, potting compounds, etc. Designed for use with 50ml 1:1, 2:1, 4:1 and 10:1 ratio dual cartridges and with 400ml 1:1 and 2:1 ratio cartridges. Using a volumetric method of applying the materials for the very best results and accuracy. Glue deposits repeatability of +/- 0.2ml.



**Max. Speed:** 400mm/sec  
**Repeatability:** +/- 0.01mm/ Axis  
**Resolution:** 0.01mm/ Axis  
**Data Memory:** 100 Programs/ 4000 points  
**Drive System / Servo motor:** 3-phase  
**Transmission:** Precision Ball Screw  
**Control Method:** PTP/ CP  
**I/O:** 8 Inputs/ 8 Outputs  
**Power Supply:** AC 110V/ 220V  
**Maximum Load:** 10kg  
**Weight:** 22kg

Size	Part Code
300mm x 300mm x 100mm 3 Axis	AD7300N-W
400mm x 400mm x 100mm 3 Axis	AD7400N-W

## AD7300HM Series Hotmelt Glue 3 Axis XYZ Robot Dispensers

Heated reservoir for dispensing hotmelt glues from 30cc barrels. Common for electronic product applications such as mobile phones, tablets and other devices. Double heating element to ensure consistency. Suitable for all types of PUR hotmelt glues. The syringe barrel heating temperature runs to 180 C maximum. This robot uses a teach pendant for programming.



**Max. Speed:** 800mm/sec  
**Repeatability:** +/- 0.01mm/ Axis  
**Resolution:** 0.01mm/ Axis  
**Data Memory:** 100 Programs/ 4000 points  
**Drive System :** Micro Stepping Motor  
**Control Method:** PTP/ CP  
**I/O:** 8 Inputs/ 8 Outputs  
**Power Supply:** AC 110V/ 220V  
**Maximum Load:** 11kg  
**Weight:** 22kg

Size	Part Code
300mm x 300mm x 100mm 3 Axis	AD7300HM
400mm x 400mm x 100mm 3 Axis	AD7400HM
500mm x 500mm x 100mm 3 Axis	AD7500HM



## Robot Accessories



Size	Part Code
Aluminium, base plate, 200mm/300mm	TSR-2000-28
Aluminium, base plate, 400mm	TSR-2000-29
Cartridge mount bracket, 10oz	TSR-CABRACKET-10
Cartridge mount bracket, 2.5, 6, 8, 12oz	TSR-CABRACKET-6
Dual valve bracket for time/pressure	TSR-DVBRACKET
Robot mount bracket for TS5000DMP	5000-000-005
Spool valve mount bracket	TSR-SVBRACKET
TS5322 valve mount bracket	TSR-CABRACKET-10M



### 700 Series Dispensing Air Barrels Only

High-density industrial grade syringe barrels. Certified silicone-free and chloride free polypropylene. Luer lock leak free tip attachment. Safe for use to 100 psi with all air powered dispensers and syringe guns. In 5 sizes and 3 colours. Use black or amber colour for UV cure adhesives. Supplied in sealed packs of 50, 500 or 1000.



Size	Natural	Black	Amber
3cc	903-N	903-B	903-D
5cc	905-N	905-B	905-D
10cc	910-N	910-B	910-D
30cc	930-N	930-B	930-D
55cc	955-N	955-B	955-D

**Typical Applications:** Safe to use with sealants, silicones, adhesives, glues, pastes, solvents, epoxies, RTVs, UV, fluxes and much more.

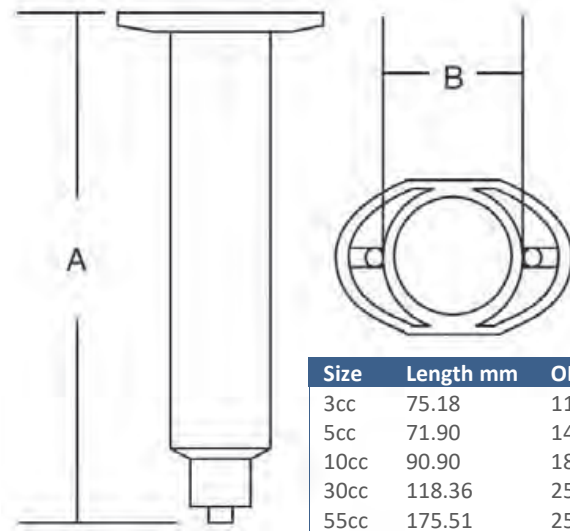

Size	Length mm	OD mm
3cc	75.18	11.56
5cc	71.90	14.99
10cc	90.90	18.29
30cc	118.36	25.65
55cc	175.51	25.65

### 700 Series Air Barrel and Piston Kits

The same number of 700 series barrels and stopper pistons are contained in each box. Part codes are for barrel colour and piston colour. Clear, black or amber barrels packed with white, red, blue or black pistons. Supplied in sealed packs of 50, 500 or 1000.

#### Clear Barrel With Piston Kit



Size	White PE Piston	Red Flat Piston	Blue Easy Piston	Black Rubber Piston
3cc	903-NW	903-NWR	903-NEF	903-NRP
5cc	905-NW	905-NWR	905-NEF	905-NRP
10cc	910-NW	910-NWR	910-NEF	910-NRP
30cc	930-NW	930-NWR	930-NEF	930-NRP
55cc	955-NW	955-NWR	955-NEF	955-NRP

#### Amber Barrel With Piston Kit



Size	White PE Piston	Red Flat Piston	Blue Easy Piston	Black Rubber Piston
3cc	903-DW	903-DWR	903-DEF	903-DRP
5cc	905-DW	905-DWR	905-DEF	905-DRP
10cc	910-DW	910-DWR	910-DEF	910-DRP
30cc	930-DW	930-DWR	930-DEF	930-DRP
55cc	955-DW	955-DWR	955-DEF	955-DRP

#### Black Barrel With Piston Kit



Size	White PE Piston	Red Flat Piston	Blue Easy Piston	Black Rubber Piston
3cc	903-BW	903-BWR	903-BEF	903-BRP
5cc	905-BW	905-BWR	905-BEF	905-BRP
10cc	910-BW	910-BWR	910-BEF	910-BRP
30cc	930-BW	930-BWR	930-BEF	930-BRP
55cc	955-BW	955-BWR	955-BEF	955-BRP

### 700 Series Dispensing Pistons

Syringe pistons for industrial barrels. Silicone-free and industrial safe to 100 psi. Use white for general purpose applications, blue for easy flow, red for thick stringy thick glues and rubber for very heavy paste. A piston will ensure no material is left in the barrel and provide a barrier against air. Supplied in sealed packs of 50, 500 or 1000.



Size	White PE	Red Flat Wall	Blue Easy	Black Rubber
3cc	903-WW	903-SWR	7030007BL	903-RP
5cc	905-WW	905-SWR	7050007BL	905-RP
10cc	910-WW	910-SWR	7100007BL	910-RP
30/55cc	930-WW	930-SWR	7300007BL	930-RP

White PE pistons are recommended for low to medium viscosity materials. Blue easy flow pistons are for medium viscosity materials as well as Cyanoacrylates. Red flat walled pistons are for stringy, thick, gloopy glues. Black rubber pistons for non reactive pastes, gels and particle filled materials such as braze pastes.

700 Series Barrel Complete Adapter Assemblies

The connecting air link from the pneumatic dispenser to the syringe barrel. Available in 5 sizes, 2 tube lengths and 2 tube diameters. High pressure design that includes a rubber O-ring. Yellow head version or black head version.



Yellow Head

Black Head

Size	3ft 6mm	6ft 6mm	3ft 4mm	6ft 4mm
3cc	70303RHB	70306RHB	70303RHB4	70306RHB4
5cc	70503RHB	70506RHB	70503RHB4	70506RHB4
10cc	71003RHB	71006RHB	71003RHB4	71006RHB4
30/55cc	73003RHB	73006RHB	73003RHB4	73006RHB4

Size	3ft 6mm	6ft 6mm	3ft 4mm	6ft 4mm
3cc	70303BHB	70306BHB	70303RHBT	70306RHBT
5cc	70503BHB	70506BHB	70503RHBT	70506RHBT
10cc	71003BHB	71006BHB	71003RHBT	71006RHBT
30/55cc	73003BHB	73006BHB	73003RHBT	73006RHBT

Adapter Head Only			Inline Filter Traps		Adapter Quick Connects			Metal Tube Crimps	
Available in yellow or black colour. Barbed. Includes rubber O-ring.			Fit in the middle of adapter hose to protect dispenser.		Fittings to attach to most air powered dispensers.			Steel crimps to secure adapter air tube to the adapter head bars.	
Size	Yellow	Black	Type	Part	Size	Yellow	Black	Size	Part
3cc	703R	70300RHR	Blue Straight	1500-FLT	Fits All	533Y	533	Fits All	1400
5cc	705R	70500RHR	Round Disc	881-000-000					
10cc	710R	71000RHR	White Straight	1400-FLT					
30/55cc	730R	73000RHR							

700 Series Manual Plunger Rods and Pistons

Convert the 700 series syringe barrels into manual assemblies using the plunger rod and rubber pistons. Works with 3cc, 5cc, 10cc and 30cc 700 series syringe barrels.



Part Code	Description
7030004PPK	700 Series Manual Plunger, 3cc
7030002MPK	700 Series Piston Rubber, 3cc
7030002M-LUBK	700 Series Piston Rubber Lubricated, 3cc
7050004PPK	700 Series Manual Plunger, 5cc
7050002MPK	700 Series Piston Rubber, 5cc
7050002M-LUBK	700 Series Piston Rubber Lubricated, 5cc
7100004PPK	700 Series Manual Plunger, 10cc
7100002MPK	700 Series Piston Rubber, 10cc
7100002M-LUBK	700 Series Piston Rubber Lubricated, 10cc
7300004PPK	700 Series Manual Plunger, 30cc
7300002MPK	700 Series Piston Rubber, 30cc
7300002M-LUBK	700 Series Piston Rubber Lubricated, 30cc



700 Series Cap Seals

Snap-on polyethylene soft material. Caps are reusable. Easy removal. Seals barrel top.

High density polypro luer lock. Caps are reusable. Easy removal. Seals barrel tip.

Soft polyethylene luer lock. Caps are reusable. Easy removal. Seals barrel tip.

High density polyethylene luer lock. Caps are reusable. Easy removal. Seals barrel tip.



Size	Orange	Blue	Colour	Part Code	Colour	Part Code	Colour	Part Code
3cc	AD903-ECO	703000CBPK	Orange	AD900-ORTC	Orange	AD400-ORTC	Orange	800-ORTC
5cc	AD905-ECO	705000CBPK	Black	AD900-BLTC	Black	AD900-BLACK	Black	800-BLTC
10cc	AD910-ECO	710000CBPK	White	AD900-WHTC	Green	AD900-GNTC	Clear	900-WHTC
30cc/55cc	AD930-ECO	730000CBPK	Blue	AD700-BLPK	Blue	AD900-BTC		
			Clear	AD900-CLTC				



### ADV Series Syringe Barrel Rounded Components

Premium grade industrial grade syringe barrels with a radius outlet design to improve material flow and barrel filling. Certified silicone-free and chloride free polypropylene. Luer lock leak free tip attachment. Safe for use to 100 psi with all air powered dispensers and syringe guns. In 5 sizes and 2 colours. Use amber colour for UV cure adhesives. Supplied in sealed packs of 50, 500 or 1000.



Size	Natural	Amber
3cc	ADV803BN	ADV803BA
5cc	ADV805BN	ADV805BA
10cc	ADV810BN	ADV810BA
30cc	ADV830BN	ADV830BA
55cc	ADV855BN	ADV855BA

**Typical Applications:** Safe to use with sealants, silicones, adhesives, glues, pastes, solvents, epoxies, RTVs, UV, fluxes and much more. For use with air-powered dispensers and manual syringe guns.

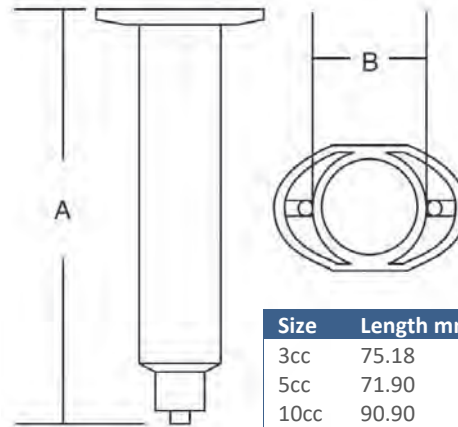

Size	Length mm	OD mm
3cc	75.18	11.56
5cc	71.90	14.99
10cc	90.90	18.29
30cc	118.36	25.65
55cc	175.51	25.65

### ADV Series Wiper Air Piston Only

Premium grade wiper pistons in opaque white colour suitable for use with all viscosity materials. Provides a barrier against air when used on a pneumatic dispenser and ensures material does not leak past. Supplied in sealed packs of 50, 500 or 1000.



Size	Part
3cc	ADV803WW
5cc	ADV805WW
10cc	ADV810WW
30cc/55cc	ADV830WW

### ADV Series End Cap and Tip Cap Seals

Unique snap-on design for leakproof barrel sealing. Twist on tip caps.



Size	Part
3cc	ADV803-EC
5cc	ADV805-EC
10cc	ADV810-EC
30/55cc	ADV830-EC

Type	Part
Round	AD900-BTC
Straight	AD700-BLPK

### ADV Series Dispensing Air Barrels and Piston Kits

Clear barrels for normal fluids, amber for UV-cure fluids (blocks UV wavelengths from 280-390nm). Each box contains an equal number of barrels and pistons.

Size	Qty	Clear	Amber
3cc	(50)	ADV803BN-NKIT	ADV803BA-DKIT
5cc	(50)	ADV805BN-NKIT	ADV805BA-DKIT
10cc	(50)	ADV810BN-NKIT	ADV810BA-DKIT
30cc	(50)	ADV830BN-NKIT	ADV830BA-DKIT
55cc	(50)	ADV855BN-NKIT	ADV855BA-DKIT



### ADV Series Syringe Barrel Adapter Assemblies

The connecting air link from the pneumatic dispenser to the syringe barrel. Available in 5 sizes, 2 tube lengths and 2 tube diameters. High pressure design that includes a rubber O-ring. Yellow head version or black head version.



#### Yellow Head

Size	3ft 6mm	6ft 6mm	3ft 4mm	6ft 4mm
3cc	70303RHB	70306RHB	70303RHB4	70306RHB4
5cc	70503RHB	70506RHB	70503RHB4	70506RHB4
10cc	71003RHB	71006RHB	71003RHB4	71006RHB4
30/55cc	73003RHB	73006RHB	73003RHB4	73006RHB4

#### Black Head

Size	3ft 6mm	6ft 6mm	3ft 4mm	6ft 4mm
3cc	70303BHB	70306BHB	70303RHBT	70306RHBT
5cc	70503BHB	70506BHB	70503RHBT	70506RHBT
10cc	71003BHB	71006BHB	71003RHBT	71006RHBT
30/55cc	73003BHB	73006BHB	73003RHBT	73006RHBT

### ADV Series Dispensing Air Barrels, Piston and Cap Kits

Clear barrels for normal fluids, amber for UV-cure fluids (blocks UV wavelengths from 280-390nm). Each box contains an equal number of barrels, pistons, end caps and tip caps.

Size	Qty	Clear	Amber
3cc	(50)	ADV803BN-NKITX	ADV803BA-DKITX
5cc	(50)	ADV805BN-NKITX	ADV805BA-DKITX
10cc	(50)	ADV810BN-NKITX	ADV810BA-DKITX
30cc	(50)	ADV830BN-NKITX	ADV830BA-DKITX
55cc	(50)	ADV855BN-NKITX	ADV855BA-DKITX



Use syringe barrel components with air-powered dispensers, manual syringe guns, manual plunger rods.

400 Series Dispensing Components

The 400 series disposable syringes and components are available in a variety of sizes and styles to meet a wide range of dispensing projects. Barrels are molded from polypropylene and have a luer lock tip attachment. Plunger rods are polyethylene. Rubber pistons are available not lubricated as standard or select the lubricated versions (medical grade silicone-oil). Plastic pistons are ideal for use with solvents and reactive adhesives.

400 Series Syringe Barrels



Part Code	Description	Size	Length mm	OD mm
F401L-1	400 Series Barrel, 1cc Luer Slip	1cc	65.27	7.62
403LL-1	400 Series Barrel, 3cc Luer Lock	3cc	74.67	10.92
406LL-1	400 Series Barrel, 6cc Luer Lock	6cc	77.47	14.73
AD910-N	400 Series Barrel, 10cc Luer Lock	10cc	90.17	18.03
435LL-1	400 Series Barrel, 35cc Luer Lock	35cc	116.33	26.16
460LL-1	400 Series Barrel, 60cc Luer Lock	60cc	159.94	29.72

400 Series Piston Stoppers

Piston stoppers are available for use with plunger rods as a manual assembly or the air-powered type for use with an adapter assembly with a dispenser. Use rubber for general use and polyethylene for solvents and Cyanoacrylates.



Part Code	Description
401L-2	400 Series Piston, 1cc Rubber. Manual, Air-Powered
401L-2-LUB	400 Series Piston, 1cc Rubber Lubricated, Manual, Air-Powered
403L-2	400 Series Piston, 3cc Rubber, Manual, Air-Powered
403L-2-LUB	400 Series Piston, 3cc Rubber Lubricated, Manual, Air-Powered
403L-7	400 Series Piston, 3cc Polyethylene Black, Manual
403L-9	400 Series Piston, 3cc Polyethylene White, Air-Powered
406L-2	400 Series Piston, 6cc Rubber, Manual
406L-2-LUB	400 Series Piston, 6cc Rubber Lubricated, Manual
406L-8	400 Series Piston, 6cc Rubber, Air Powered
406L-8-LUB	400 Series Piston, 6cc Rubber Lubricated, Air Powered
406L-7	400 Series Piston, 6cc Polyethylene Black, Manual
406L-9	400 Series Piston, 6cc Polyethylene White, Air-Powered
410L-2	400 Series Piston, 10cc Rubber, Manual, Air-Powered
410L-2-LUB	400 Series Piston, 10cc Rubber Lubricated, Manual, Air-Powered
410L-8	400 Series Piston, 10cc Rubber, Air Powered
410L-8-LUB	400 Series Piston, 10cc Rubber Lubricated, Air Powered
410L-7	400 Series Piston, 10cc Polyethylene Black, Manual
AD910-WW	400 Series Piston, 10cc Polyethylene White, Air-Powered
435L-2	400 Series Piston, 35cc Rubber, Manual, Air-Powered
435L-2-LUB	400 Series Piston, 35cc Rubber Lubricated, Manual, Air-Powered
435L-8	400 Series Piston, 35cc Rubber, Air Powered
435L-7	400 Series Piston, 10cc Polyethylene Black, Manual
435L-9	400 Series Piston, 35cc Polyethylene White, Air-Powered
460L-9	400 Series Piston, 60cc Polyethylene White, Air-Powered

400 Series Manual Plunger Rods

Use these rods with any piston stopper marked manual. And select the barrel size to match.



Part Code	Description
401L-4	400 Series Plunger, 1cc Polyethylene
403L-4	400 Series Plunger, 3cc Polyethylene
406L-4	400 Series Plunger, 6cc Polyethylene
410L-4	400 Series Plunger, 10cc Polyethylene
435L-4	400 Series Plunger, 35cc Polyethylene
460L-4	400 Series Plunger, 60cc Polyethylene

400 Series Manual Syringe Assemblies

Full syringe assemblies with barrel, piston, rod.

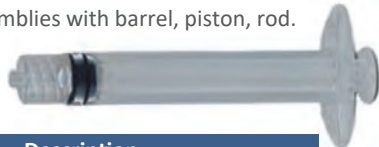

Part Code	Description
MS401L-1	1cc Syringe, Rubber Piston
MS403LL-1	3cc Syringe, Rubber Piston
MS403LL-1P	3cc Syringe, Plastic Piston
MS406LL-1	6cc Syringe, Rubber Piston
MS406LL-1P	10cc Syringe, Plastic Piston
MS410LL-1	10cc Syringe, Rubber Piston
MS430LL-1	30cc Syringe, Rubber Piston
MS460LL-1	60cc Syringe, Rubber Piston

400 Series Syringe Barrel Adapter Assemblies

Adapter provides safe attachment between air hose and barrel reservoir. Assembly includes 5/32" OD flexible polyurethane tubing, EPR O-ring, male quick-connect.

Part Code	Description
900-250-3	400 Series Adapter Assembly, 1cc. 3 ft Long Airline Hose
900-250-6	400 Series Adapter Assembly, 1cc. 6 ft Long Airline Hose
900-350-3	400 Series Adapter Assembly, 3cc. 3 ft Long Airline Hose
900-350-6	400 Series Adapter Assembly, 3cc. 6 ft Long Airline Hose
900-550-3	400 Series Adapter Assembly, 6cc. 3 ft Long Airline Hose
900-550-6	400 Series Adapter Assembly, 6cc. 6 ft Long Airline Hose
71003RHB4	400 Series Adapter Assembly, 10cc. 3 ft Long Airline Hose
71006RHB4	400 Series Adapter Assembly, 10cc. 6 ft Long Airline Hose
900-950-3	400 Series Adapter Assembly, 35cc. 3 ft Long Airline Hose
900-950-6	400 Series Adapter Assembly, 35cc. 6 ft Long Airline Hose
900-1150-3	400 Series Adapter Assembly, 60cc. 3 ft Long Airline Hose
900-1150-6	400 Series Adapter Assembly, 60cc. 6 ft Long Airline Hose



Tip Cap Seal	Part Code
Orange	AD900-ORTC
Black	AD900-BLTC
White	AD900-WHTC
Blue	AD700-BLPK



### AD Series Big Barrel Assemblies for Dispensers

XL series syringe barrel components are used with pneumatic dispensers. Available in sizes 100cc, 200cc, 300cc, 400cc and 500cc. Includes a 3ft long air hose and threaded air cap. Use these products for larger volume air-powered dispensing of most fluids. Each kit includes a barrel, wiper piston, air cap, gasket, air fitting, hose, dispenser connector.

Part Code	Description
AD100XL	AD Assembly, 100cc
AD200XL	AD Assembly, 200cc
AD300XL	AD Assembly, 300cc
AD400XL	AD Assembly, 400cc
AD500XL	AD Assembly, 500cc



### AD Series Big Barrel Only

The barrel body is available to order separately as the air cap can be re-used.

Part Code	Description
AD100XLB	AD Barrel, 100cc
AD200XLB	AD Barrel, 200cc
AD300XLB	AD Barrel, 300cc
AD400XLB	AD Barrel, 400cc
AD500XLB	AD Barrel, 500cc



### AD Series Big Piston Only

The wiper piston is available to order separately as the air cap can be re-used.

Part Code	Description
AD100XLP	AD Piston, 100cc
AD200XLP	AD Piston, 200cc
AD300XLP	AD Piston, 300cc
AD400XLP	AD Piston, 400cc
AD500XLP	AD Piston, 500cc



### AD Series Big Barrel Air Cap Only

The air cap is reusable and is supplied with a rubber gasket.

Part Code	Description
AD100XLC	AD Cap, 100cc
AD200XLC	AD Cap, 200cc
AD300XLC	AD Cap, 300cc
AD400XLC	AD Cap, 400cc
AD500XLC	AD Cap, 500cc

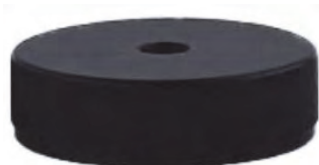

### AD Series Big Barrel Air Hose

Replacement air hose from big barrel to dispenser.

Part Code	Description
AD918-000-002S	Air Hose, 3ft
AD918-000-006S	Air Hose, 6ft



### Unmarked Manual Syringe Assemblies Rubber Pistons

Manual syringe assemblies unmarked bodies. With a luer lock or luer slip tip attachment. Assembly includes the main barrel, plunger rod and the rubber piston.

Size	Unmarked Luer Lock	Unmarked Luer Slip
1cc	n/a	MS401L-1
3cc	MS403LL-1	MS403L-1
5cc	MS405LL-1	MS405L-1
10cc	MS410LL-1	MS410L-1
20cc	MS420LL-1	MS420L-1
30cc	MS430LL-1	MS430L-1
50cc	MS450LL-1	MS450L-1
60cc	MS460LL-1	MS460L-1



### Unmarked Manual Syringe Assemblies Plastic Pistons

Manual syringe assemblies unmarked bodies. Luer lock tip attachment. Assembly includes the main barrel, plunger rod and the plastic piston. Ideal for solvent based glues and reactive adhesives.

Size	Unmarked Luer Lock
3cc	MS403LL-1
6cc	MS405LL-1
10cc	MS410LL-1

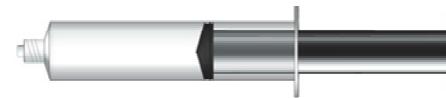

### Graduated Manual Syringe Assemblies

Manual syringe assemblies graduated bodies. With a luer lock or luer slip tip attachment. Assembly includes the main barrel, plunger rod and the piston.

Size	Graduated Luer Lock	Graduated Luer Slip
1ml	n/a	MS401L-1G
3ml	MS403LL-1G	MS403L-1G
5ml	MS405LL-1G	MS405L-1G
10ml	MS410LL-1G	MS410L-1G
20ml	MS420LL-1G	MS420L-1G
30ml	MS430LL-1G	MS430L-1G
50ml	MS450LL-1G	MS450L-1G
60ml	MS460LL-1G	MS460L-1G
100ml	MS4100LL-1G	MS4100L-1G



### Graduated Emerald Manual Syringe Assemblies

Manual syringe assemblies with graduated bodies. Luer slip push on tip attachment. Assembly includes the main barrel, plunger rod and the piston. Emerald syringes use 30% less materials in their construction.

Size	Graduated Luer Slip
2ml	MS402L-1G-EM
5ml	MS405L-1G-EM
10ml	MS410L-1G-EM



### Graduated 2-Piece Manual Syringe Assemblies

Manual syringe assemblies with graduated bodies. Luer slip push on tip attachment. 2-piece does not use rubber plunger for solvent glue use.

Size	Graduated Luer Slip 2 Piece
2ml	MS403L-2G
5ml	MS405L-2G
10ml	MS410L-2G
20ml	MS420L-2G



Precision Dispense Tips

Performance dispensing tips for use with syringe barrels, dispense bottles, metering valves and XYZ robots. Our tips are industrial grade safe for use to 100 psi fluid pressures and are certified silicone-free materials. Luer lock secure attachment for leak free precision dispensing.

Our extensive range of dispensing tips are suitable for use on luer lock and luer slip syringe barrels, luer fittings, metering valves and luer bottles. All tips feature the same female luer lock hub for safe connection. Tips can be used for dispensing most fluids, adhesives, pastes, solvents or chemicals.

Standard tips are colour coded that indicates the outlet size and feature a polypropylene hub to stainless steel tubes in a wide range of lengths. All metal precision tips are custom built-to-order and available in most gauge sizes and any length. Smooth flow tapered tips are designed to dispense higher viscosity gels and pastes. Aluminium hub and crimped hub tips are recommended for use with aggressive solvents and chemicals.

Polypropylene tube tips are soft and will not scratch sensitive surfaces. Teflon and Teflon lined tips are designed for Cyanoacrylate adhesives. Brush tips are used for spreading and coating applications. Metal tapered tips are used on high precision robots. And tip kits contain an assorted for users to evaluate and test.

We supply our tips in boxes of 50 or in bulk value packs of 500 or 1000. All boxes and packs are labelled and include batch codes.

APPLICATIONS	DISPENSING TIPS							
	Tapered	Stainless Steel	Teflon Lined	Flexible	Crimped	Teflon	Aluminium	Brush
Very Low Viscosity Fluids	X	●	●	●	●	●	●	●
Particle-Filled Pastes	●	●	▲	X	●	X	●	X
Microdot Deposits	X	●	▲	●	●	●	▲	X
Fluid Is Reactive to Metal	●	X	●	●	X	●	X	X
Depositing in Recesses	▲	●	●	▲	●	●	●	X
Spreading/Smearing	●	▲	●	▲	▲	●	●	●
Fast-Curing Glues	●	▲	●	●	▲	▲	▲	X
Beading, Striping	●	●	●	▲	●	▲	●	▲
Easily Scratched Substrates	●	▲	●	●	▲	●	▲	●

FLUIDS	DISPENSING TIPS							
	Tapered	Stainless Steel	Teflon Lined	Flexible	Crimped	Teflon	Aluminium	Brush
Adhesives	●	●	●	●	●	●	●	●
Anaerobics	●	▲	●	▲	▲	▲	▲	▲
Conformal Coatings	●	▲	▲	X	●	X	▲	X
Cyanoacrylates	●	▲	●	●	▲	●	X	X
Gel Cyanoacrylates	●	▲	●	▲	▲	●	X	X
Epoxies	●	●	●	X	●	X	●	X
Greases	●	●	●	X	●	X	●	●
Light-Cure Adhesives	X	▲	X	X	●	X	●	X
Oils	▲	●	●	▲	▲	▲	●	●
Paints	▲	●	●	X	▲	X	●	●
Sealants	●	▲	▲	X	▲	X	▲	X
Silver Epoxy	X	▲	X	X	▲	X	▲	X
Solder Paste/Braze Pastes	●	●	▲	X	●	X	●	X
Solder Masks	●	●	▲	X	●	▲	●	▲
Solvents	X	●	●	●	●	●	●	●
UV-Cure Adhesives	●	▲	▲	X	●	▲	▲	X

**General Purpose Standard Precision Tips**

The TE needle series consist of a stainless-steel shaft with a double helix polypro hub. Tips are burr-free, and electro-polished shaft for unobstructed and consistent material flow. Silicone and chloride free. For most viscosity fluids and adhesives and safe for use to 100 psi.

Gauge	0.25"	0.50"	1.0"	1.5"	2.0"	ID	OD	Colour
12	AD712025	AD712050	AD713100	AD713150	AD712200	2.26mm	2.77mm	Blue
13	AD713025	AD713050	AD713100	AD713150	AD713200	1.78mm	2.54mm	Red
14	TE714025	TE714050	TE714100	TE714150	TE714200	1.55mm	1.83mm	Olive
15	TE715025	TE715050	TE715100	TE715150	TE715200	1.37mm	1.65mm	Amber
16	TE716025	TE716050	TE716100	TE716150	TE716200	1.19mm	1.45mm	Grey
17	TE717025	TE717050	TE717100	TE717150	n/a	1.04mm	1.40mm	Brown
18	TE718025	TE718050	TE718100	TE718150	TE718200	0.84mm	1.27mm	Green
19	TE719025	TE719050	TE719100	TE719150	n/a	0.70mm	1.05mm	Black
20	TE720025	TE720050	TE720100	TE720150	TE720200	0.61mm	0.91mm	Pink
21	TE721025	TE721050	TE721100	TE721150	TE721200	0.51mm	0.81mm	Purple
22	TE722025	TE722050	TE722100	TE722150	TE723200	0.41mm	0.71mm	Blue
23	TE723025	TE723050	TE723100	TE723150	TE723200	0.33mm	0.64mm	Orange
25	TE725025	TE725050	TE725100	TE725150	TE725200	0.25mm	0.51mm	Red
26	TE726025	TE726050	TE726100	TE726150	n/a	0.24mm	0.45mm	Peach
27	TE727025	TE727050	TE727100	TE727150	n/a	0.20mm	0.41mm	Clear
30	TE730025	TE730050	TE730100	n/a	n/a	0.15mm	0.30mm	Lavender
32	TE732025	TE732050	n/a	n/a	n/a	0.10mm	0.23mm	Yellow
34	TE734025	n/a	n/a	n/a	n/a	0.08mm	0.21mm	Lime

**Bent Angled Precision Tips**

Dispensing tips in tube lengths of 0.5", 1.0" or 1.5" and with 30°, 45°, 60° or 90° precision bends. Stainless steel tube to polypro luer lock hub.

Gauge	45° - 0.5"	45° - 1"	45° - 1.5"	90° - 0.5"	90° - 1"	90° - 1.5"	ID	OD	Colour
14	TE71405045	TE71410045	TE71415045	TE71405090	TE71410090	TE71415090	1.55mm	1.83mm	Olive
15	TE71505045	TE71510045	TE71515045	TE71505090	TE71510090	TE71515090	1.37mm	1.65mm	Amber
16	TE71605045	TE71610045	TE71615045	TE71605090	TE71610090	TE71615090	1.19mm	1.45mm	Grey
17	TE71705045	TE71710045	TE71715045	TE71705090	TE71710090	TE71715090	1.04mm	1.40mm	Brown
18	TE71805045	TE71810045	TE71815045	TE71805090	TE71810090	TE71815090	0.84mm	1.27mm	Green
19	TE71905045	TE71910045	TE71915045	TE71905090	TE71910090	TE71915090	0.70mm	1.05mm	Black
20	TE72005045	TE72010045	TE72015045	TE72005090	TE72010090	TE72015090	0.61mm	0.91mm	Pink
21	TE72105045	TE72110045	TE72115045	TE72105090	TE72110090	TE72115090	0.51mm	0.81mm	Purple
22	TE72205045	TE72210045	TE72215045	TE72205090	TE72210090	TE72215090	0.41mm	0.71mm	Blue
23	TE72305045	TE72310045	TE72315045	TE72305090	TE72310090	TE72315090	0.33mm	0.64mm	Orange
24	TE72405045	TE72410045	TE72415045	TE72405090	TE72410090	TE72415090	0.30mm	0.56mm	Lt. Red
25	TE72505045	TE72510045	TE72515045	TE72505090	TE72510090	TE72515090	0.25mm	0.51mm	Red
27	TE72705045	TE72710045	TE72715045	TE72705090	TE72710090	TE72715090	0.20mm	0.41mm	Clear
28	TE72805045	TE72810045	TE72815045	TE72805090	TE72810090	TE72815090	0.18mm	0.35mm	White
30	TE73005045	TE73010045	TE73015045	TE73005090	TE73010090	TE73015090	0.15mm	0.30mm	Lavender
32	TE73205045	TE73210045	TE73215045	TE73205090	TE73210090	TE73215090	0.10mm	0.23mm	Yellow
34	TE73405045	TE73410045	TE73415045	TE73405090	TE73410090	TE73415090	0.08mm	0.21mm	Lime



Gauge	30° - 0.5"	30° - 1"	30° - 1.5"	60° - 0.5"	60° - 1"	60° - 1.5"	ID	OD	Colour
14	TE71405030	TE71410030	TE71415030	TE71405060	TE71410060	TE71415060	1.55mm	1.83mm	Olive
15	TE71505030	TE71510030	TE71515030	TE71505060	TE71510060	TE71515060	1.37mm	1.65mm	Amber
16	TE71605030	TE71610030	TE71615030	TE71605060	TE71610060	TE71615060	1.19mm	1.45mm	Grey
17	TE71705030	TE71710030	TE71715030	TE71705060	TE71710060	TE71715060	1.04mm	1.40mm	Brown
18	TE71805030	TE71810030	TE71815030	TE71805060	TE71810060	TE71815060	0.84mm	1.27mm	Green
19	TE71905030	TE71910030	TE71915030	TE71905060	TE71910060	TE71915060	0.70mm	1.05mm	Black
20	TE72005030	TE72010030	TE72015030	TE72005060	TE72010060	TE72015060	0.61mm	0.91mm	Pink
21	TE72105030	TE72110030	TE72115030	TE72105060	TE72110060	TE72115060	0.51mm	0.81mm	Purple
22	TE72205030	TE72210030	TE72215030	TE72205060	TE72210060	TE72215060	0.41mm	0.71mm	Blue
23	TE72305030	TE72310030	TE72315030	TE72305060	TE72310060	TE72315060	0.33mm	0.64mm	Orange
24	TE72405030	TE72410030	TE72415030	TE72405060	TE72410060	TE72415060	0.30mm	0.56mm	Lt. Red
25	TE72505030	TE72510030	TE72515030	TE72505060	TE72510060	TE72515060	0.25mm	0.51mm	Red
27	TE72705030	TE72710030	TE72715030	TE72705060	TE72710060	TE72715060	0.20mm	0.41mm	Clear
28	TE72805030	TE72810030	TE72815030	TE72805060	TE72810060	TE72815060	0.18mm	0.35mm	White
30	TE73005030	TE73010030	TE73015030	TE73005060	TE73010060	TE73015060	0.15mm	0.30mm	Lavender
32	TE73205030	TE73210030	TE73215030	TE73205060	TE73210060	TE73215060	0.10mm	0.23mm	Yellow
34	TE73405030	TE73410030	TE73415030	TE73405060	TE73410060	TE73415060	0.08mm	0.21mm	Lime





## Smooth Flowing Tapered Tips

Smooth flowing tapered tips are used with higher viscosity materials as the design allows materials to flow with less resistance. Total tip length 1.25" (31.75mm). Double helix luer lock secure connection to syringes, bottles, fittings or metering valves.

### TTN Series Smooth Flowing Tapered Tips

TT-RIGID series smooth flowing tapered tips are stiff polyethylene tinted colour.

Part Code	Gauge	Colour	ID
TTN14	14	Olive	1.60mm/ 0.063"
TTN16	16	Grey	1.22mm/ 0.048"
TTN18	18	Green	0.84mm. 0.033"
TTN20	20	Pink	0.61mm/ 0.024"
TTN22	22	Blue	0.41mm/ 0.016"
TTN25	25	Red	0.25mm/ 0.010"
TTN26	26	Orange	0.23mm/ 0.008"
TTN27	27	Clear	0.20mm/ 0.008"
TTN30	30	Lavender	0.15mm/ 0.006"
TTN32	32	Yellow	0.10mm/ 0.004"



### ADTT Series Smooth Flowing Tapered Tips

ADTT series smooth flowing tapered tips are stiff polyethylene opaque colour.

Part Code	Gauge	Colour	ID
AD14TTN	14	Olive	1.60mm/ 0.063"
AD16TTN	16	Grey	1.22mm/ 0.048"
AD18TTN	18	Green	0.84mm. 0.033"
AD20TTN	20	Pink	0.61mm/ 0.024"
AD22TTN	22	Blue	0.41mm/ 0.016"
AD25TTN	25	Red	0.25mm/ 0.010"
AD26TTN	26	Orange	0.23mm/ 0.008"
AD27TTN	27	Clear	0.20mm/ 0.008"
AD30TTN	30	Lavender	0.15mm/ 0.006"
AD32TTN	32	Yellow	0.10mm/ 0.004"



### TT-DHUV Series Smooth Flowing Tapered Tips

TT-DHUV series smooth flowing tapered tips are soft polyethylene tinted colour.

Part Code	Gauge	Colour	ID
TT14-DHUV-PK	14	Olive	1.60mm/ 0.063"
TT16-DHUV-PK	16	Grey	1.22mm/ 0.048"
TT18-DHUV-PK	18	Green	0.84mm. 0.033"
TT20-DHUV-PK	20	Pink	0.61mm/ 0.024"
TT22-DHUV-PK	22	Blue	0.41mm/ 0.016"
TT25-DHUV-PK	25	Red	0.25mm/ 0.010"
TT27-DHUV-PK	27	Clear	0.20mm/ 0.008"



### TT-RIGID Series Smooth Flowing Tapered Tips

TT-RIGID series smooth flowing tapered tips are stiff polyethylene opaque colour.

Part Code	Gauge	Colour	ID
TT14-RIGID-PK	14	Olive	1.60mm/ 0.063"
TT16-RIGID-PK	16	Grey	1.22mm/ 0.048"
TT18-RIGID-PK	18	Green	0.84mm. 0.033"
TT20-RIGID-PK	20	Pink	0.61mm/ 0.024"
TT22-RIGID-PK	22	Blue	0.41mm/ 0.016"
TT25-RIGID-PK	25	Red	0.25mm/ 0.010"
TT27-RIGID-PK	27	White	0.20mm/ 0.008"



## Flexible Tube Polypro Tips

Flexible tube tips for adhesives, inks, primers, glues, Cyanoacrylates, paints and many more. Polypro hub material to polypro flexible tubes. Colour coded luer lock hubs. Soft tubing is also ideal for sensitive substrates.

Gauge	0.5" Long	1.0" Long	1.5" Long	2.0" Long	3.0" Long	ID	Colour
14	3114PPS	3114PP-1	3114PP	3114PP-2	3114PP-3	1.60mm	Olive
15	3115PPS	3115PP-1	3115PP	3115PP-2	3115PP-3	1.37mm	Amber
18	3118PPS	3118PP-1	3118PP	3118PP-2	3118PP-3	0.84mm	Green
20	3120PPS	3120PP-1	3120PP	3120PP-2	3120PP-3	0.58mm	Pink
22	3122PPS	3122PP-1	3122PP	3122PP-2	3122PP-3	0.43mm	Blue
25	3125PPS	3125PP-1	3125PP	3125PP-2	3125PP-3	0.35mm	Red



### Flexible Tube Polypro Tips

Flexible tube tips for adhesives, inks, primers, glues, Cyanoacrylates, paints and many more. 1.5" length tubes. Polypro hub to colour coded flexible tubes.

Gauge	ID	Colour	Length
14	1.60mm	White	38.1mm
15	1.37mm	Grey	38.1mm
16	1.19mm	Brown	38.1mm
18	0.84mm	Pink	38.1mm
20	0.58mm	Yellow	38.1mm
22	0.48mm	Black	38.1mm
25	0.36mm	Red	38.1mm



### Aluminium Hub Precision Tips

Aluminium hub to stainless steel dispense tips. Dispense adhesives and aggressive solvent based liquids or chemicals. Luer lock hubs.



Gauge	0.5"	1.0"	1.5"	2.0"	ID
14	TS14-1/2M	TS14-1M	TS14-15M	TS14-2M	1.60mm
15	TS15-1/2M	TS15-1M	TS15-15M	TS15-2M	1.37mm
16	TS16-1/2M	TS16-1M	TS16-15M	n/a	1.19mm
17	TS17-1/2M	TS17-1M	TS17-15M	n/a	1.04mm
18	TS18-1/2M	n/a	n/a	n/a	0.84mm
20	TS20-1/2M	n/a	n/a	n/a	0.71mm

Flexible polypro tube tips can be cut to custom length to suit the application.

### Flexible Tube PTFE Teflon Tips

For dispensing Cyanoacrylate adhesives where the Teflon tube resists clogging. Double helix polypro luer lock colour coded hub. Teflon tube is translucent. Premium tips for clog free dispensing applications.

Gauge	0.5"	2.0"	ID	Colour
14	TF14-1/2	TF14-2	1.676mm	Olive
16	TF16-1/2	TF16-2	1.346mm	Purple
18	TF18-1/2	TF18-2	1.067mm	Pink
20	TF20-1/2	TF20-2	0.864mm	Yellow
22	TF22-1/2	TF22-2	0.711mm	Black
23	TF23-1/2	n/a	0.660mm	Blue
24	TF24-1/2	n/a	0.559mm	Red
30	TF30-1/2	TF30-2	0.305mm	Lavender



### Precision Stainless Steel Tapered Tips

Metal tapered dispense tips for accurate placement of assembly fluid materials. Luer lock design. 18.25mm long. Nickel plated brass to 303 stainless steel body.

Part Code	ID	OD
AD001	0.10mm	0.20mm
AD015	0.15mm	0.25mm
AD002	0.20mm	0.40mm
AD025	0.25mm	0.45mm
AD003	0.30mm	0.50mm
AD004	0.40mm	0.60mm
AD005	0.50mm	0.70mm
AD006	0.60mm	0.80mm



### Teflon Lined Crimped Tips

Teflon lined tips for dispensing Cyanoacrylate adhesives. PTFE Teflon tube resists clogging. Polypro hub material to stainless steel tube with Teflon crimped insert.



Gauge	0.5" Long	1.0" Long	ID	Colour
21	5121TLCS	5121TLC	0.51mm	Grey
25	5125TLCS	5125TLC	0.30mm	Pink
27	5127TLCS	5127TLC	0.15mm	Red

### Precision Stainless Steel Twin Needle Tips

All metal needle tips for accurate placement of most materials. Dual tip outlet design. Luer lock design. Nickel plated brass to 304 stainless steel. Ideal for automated dispensing applications. Supplied in boxes of 12.

Part Code	Gauge	ID	OD	Length
TS15TSS	15	1.38mm	1.84mm	12.7mm
TS16TSS	16	1.20mm	1.63mm	12.7mm
TS18TSS	18	0.91mm	1.25mm	12.7mm
TS20TSS	20	0.60mm	0.90mm	12.7mm
TS21TSS	21	0.51mm	0.81mm	12.7mm
TS22TSS	22	0.40mm	0.71mm	12.7mm
TS23TSS	23	0.34mm	0.63mm	12.7mm
TS25TSS	25	0.26mm	0.51mm	12.7mm
TS27TSS	27	0.21mm	0.41mm	12.7mm
TS30TSS	30	0.15mm	0.30mm	12.7mm



### Metal High Precision Tips

All metal needle dispense tips for accurate placement of most materials. Luer lock design. Nickel plated brass to 304 stainless steel. Ideal for automated dispensing applications. Options for tube lengths. Boxes of 10 tips.

GA	0.25"	0.50"	1.0"	1.5"	2.0"	ID mm	OD mm
8	TS8SS-1/4	TS8SS-1/2	TS8SS-1	TS8SS-15	TS8SS-2	3.28	4.01
9	TS9SS-1/4	TS9SS-1/2	TS9SS-1	TS9SS-15	TS9SS-2	2.87	3.69
10	TS10SS-1/4	TS10SS-1/2	TS10SS-1	TS10SS-15	TS10SS-2	2.50	3.30
11	TS11SS-1/4	TS11SS-1/2	TS11SS-1	TS11SS-15	TS11SS-2	2.30	2.95
12	TS12SS-1/4	TS12SS-1/2	TS12SS-1	TS12SS-15	TS12SS-2	2.18	2.77
13	TS13SS-1/4	TS13SS-1/2	TS13SS-1	TS13SS-15	TS13SS-2	1.94	2.40
14	TS14SS-1/4	TS14SS-1/2	TS14SS-1	TS14SS-15	TS14SS-2	1.64	2.10
15	TS15SS-1/4	TS15SS-1/2	TS15SS-1	TS15SS-15	TS15SS-2	1.38	1.84
16	TS16SS-1/4	TS16SS-1/2	TS16SS-1	TS16SS-15	TS16SS-2	1.20	1.65
17	TS17SS-1/4	TS16SS-1/2	TS16SS-1	TS16SS-15	TS16SS-2	1.09	1.50
18	TS18SS-1/4	TS18SS-1/2	TS18SS-1	TS18SS-15	TS18SS-2	0.91	1.25
19	TS19SS-1/4	TS19SS-1/2	TS19SS-1	TS19SS-15	TS19SS-2	0.70	1.10
20	TS20SS-1/4	TS20SS-1/2	TS20SS-1	TS20SS-15	TS20SS-2	0.60	0.90
21	TS21SS-1/4	TS21SS-1/2	TS21SS-1	TS21SS-15	TS21SS-2	0.51	0.81
22	TS22SS-1/4	TS22SS-1/2	TS22SS-1	TS22SS-15	TS22SS-2	0.40	0.71
23	TS23SS-1/4	TS23SS-1/2	TS23SS-1	TS23SS-15	TS23SS-2	0.34	0.63
24	TS24SS-1/4	TS24SS-1/2	TS24SS-1	TS24SS-15	TS24SS-2	0.31	0.56
25	TS25SS-1/4	TS25SS-1/2	TS25SS-1	TS25SS-15	TS25SS-2	0.26	0.51
26	TS26SS-1/2	TS26SS-1/2	TS26SS-1	TS26SS-15	TS26SS-2	0.25	0.46
27	TS27SS-1/4	TS27SS-1/2	TS27SS-1	TS27SS-15	TS27SS-2	0.21	0.41
29	TS29SS-1/4	TS29SS-1/2	TS29SS-1	TS29SS-15	TS29SS-2	0.18	0.34
30	TS30SS-1/4	TS30SS-1/2	TS30SS-1	TS30SS-15	TS30SS-2	0.15	0.30

All metal dispensing tips are made to order. We hold stocks of common tube lengths and gauge sizes but can make these tips to any custom tube length.



### Triple Tube Tips

Triple tube all metal tips. Tube length 12.7mm. Luer lock hub.

Part Code	Gauge	ID	OD
TS18TSS	18	0.91mm	1.25mm
TS19TSS	19	0.70mm	1.10mm
TS20TSS	20	0.60mm	0.90mm
TS21TSS	21	0.51mm	0.81mm
TS22TSS	22	0.40mm	0.71mm
TS23TSS	23	0.34mm	0.63mm
TS25TSS	25	0.26mm	0.51mm
TS27TSS	27	0.21mm	0.41mm
TS30TSS	30	0.15mm	0.30mm

## Luer lock dispensing tips

### Micron-S Smooth Flowing Metal Tapered Tips

High precision metal tips with plastic outer sleeve. Luer lock attach to barrels or valves. Stainless steel inner. \* Have a PTFE coating.

Part Code	GA	Colour	ID mm	OD
5901001	18	Pink	1.041	1.254
5901002	19	Tan	0.864	1.067
5901003	20	Green	0.686	0.889
5901004	21	Blue	0.609	0.813
5901005	23	Purple	0.564	0.635
5901006	25	White	0.437	0.508
5901007	27	Red	0.335	0.406
5901008	30	Black	0.233	0.305
5901012 *	18	Pink	1.041	1.254
5901013 *	19	Tan	0.864	1.067
5901014 *	20	Green	0.686	0.889
5901016 *	23	Purple	0.564	0.635



### MT Series Smooth Flowing Metal Tapered Tips

High precision metal tips with plastic outer sleeve. Luer lock attach to barrels or valves. Stainless steel inner with EN coating.



Part Code	Gauge	Colour	ID mm	OD
MT18-PBN	18	Pink	1.041	1.254
MT19-PBN	19	Orange	0.864	1.067
MT20-PBN	20	Green	0.686	0.889
MT21-PBN	21	Blue	0.609	0.813
MT23-PBN	23	Purple	0.564	0.635
MT25-PBN	25	White	0.437	0.508
MT27-PBN	27	Red	0.335	0.406
MT30-PBN	30	Black	0.233	0.305

### SE Series Precision Dispensing Tips

The SE needle series consist of a stainless-steel shaft with a luer lock polypro hub. 0.50" or 1.0" tube length.



Gauge	Colour	ID mm	OD	0.5"	1.0"
14	Olive	1.55	1.83	SE414050PK	SE414100PK
15	Amber	1.37	1.65	SE415050PK	SE415100PK
16	Grey	1.19	1.45	SE416060PK	SE416100PK
18	Green	0.84	1.27	SE418050PK	SE418100PK
19	Brown	0.70	1.05	SE419050PK	SE419100PK
20	Pink	0.61	0.91	SE420050PK	SE420100PK
21	Purple	0.51	0.81	SE421050PK	SE421100PK
22	Blue	0.41	0.71	SE422050PK	SE422100PK
23	Orange	0.33	0.64	SE423050PK	SE423100PK
25	Red	0.25	0.51	SE425050PK	SE425100PK
27	Clear	0.20	0.41	SE427050PK	SE427100PK

### Flat End Precision Tips

Precision tips with a flat end to provide a thin, flat deposit. Polypro hub to stainless steel tube.



Gauge	0.50"	ID	OD	Colour
14	TE714050VL	1.55mm	1.83mm	Olive
15	TE715050VL	1.37mm	1.65mm	Amber
16	TE716050VL	1.19mm	1.45mm	Grey
18	TE718050VL	0.84mm	1.27mm	Green

### Dispensing Tip Kits

Tip kits contain assorted ranges of tips in a wide variety of gauge sizes.



### Crimped Hub Precision Tips

Tips suitable for dispensing aggressive solvent based adhesives.



GA	0.5" Long	1.0" Long	ID	OD	Colour
18	TS18-1/2	TS18-1	0.84mm	1.27mm	Pink
19	TS19-1/2	TS19-1	0.71mm	1.14mm	Brown
20	TS20-1/2	TS20-1	0.61mm	0.91mm	Yellow
21	TS21-1/2	TS21-1	0.51mm	0.81mm	Green
22	TS22-1/2	TS22-1	0.41mm	0.71mm	Black
23	TS23-1/2	TS23-1	0.33mm	0.64mm	Blue
25	TS25-1/2	n/a	0.25mm	0.51mm	Blue
26	TS26-1/2	TS26-1	0.24mm	0.50mm	Beige
30	TS30-1/2	n/a	0.15mm	0.30mm	Lavender

GA	0.5" Long	1.0" Long	ID	OD	Colour
14	TES14050	TES14100	1.55mm	1.83mm	Olive
15	TES15050	TES15100	1.37mm	1.65mm	Grey
18	TES18050	TES18100	0.84mm	1.27mm	Green
20	TES20050	TES20100	0.61mm	0.91mm	Pink
21	TES21050	TES21100	0.51mm	0.81mm	Purple
22	TES22050	TES22100	0.41mm	0.71mm	Blue
23	TES23050	TES23100	0.33mm	0.64mm	Orange
25	TES25050	TES25100	0.25mm	0.51mm	Red
27	TES27050	TES27100	0.20mm	0.41mm	Clear

Part	Type
DCK600	145 pcs, Tapered, General Purpose, Teflon Lined, Bent
DCK700	145 pcs, Tapered, General Purpose, Polypro
TN00DKIT	145 pcs, Tapered, General Purpose, Bent
SA7721	50 pcs, Tapered
SA7517	50 pcs, TS Crimped 0.5" Long
SA7518	50 pcs, TS Crimped 1.0" Long
SA7529	18 pcs, Bent 45 Degree, 0.50" Long
SA7530	18 pcs, Bent 90 Degree, 0.50" Long
SA7205	50 pcs, Polypro, Teflon Tube, Teflon Lined
SA7524	50 pcs, General Purpose, 0.50" Long
SA7549	40 pcs, Polypro 0.50", 1.0", 1.5" Long

### Tip Shield Covers

Rubber and plastic covers that push over the end of the tip to provide an air tight seal.



Length	Part Code
42mm	7016TC
66mm	7016TC-66



Gauge	Part Code
12	TTC-12
14	7016TTC
16	TTC-16
18	TTC-18
19	TTC-19
20	TTC-20
22	TTC-22
25	TTC-25



**Brush Dispensing Tips**

Use these double helix brush tips for spread applications such as glues and other materials such as grease, primers, activators, paints, etc. Brush part is made of nylon for hard bristle and sable for soft bristle. Many other widths and types are available, please visit our website for information.

GA	Brush Width	Soft Bristle	Hard Bristle	ID mm	Colour
14	4mm Round	AD-1005-14BTS	AD-1005-14BT	1.60	Olive
14	4mm Pointed	AD-1013-14BTS	AD-1013-14BT	1.60	Olive
14	5mm Round	AD-1006-14BTS	AD-1006-14BT	1.60	Olive
14	5mm Flat	AD-1007-14BTS	AD-1007-14BT	1.60	Olive
14	6mm Flat	AD-1008-14BTS	AD-1008-14BT	1.60	Olive
14	6mm Round	AD-1009-14BTS	AD-1009-14BT	1.60	Olive
14	7mm Flat	AD-1010-14BTS	AD-1010-14BT	1.60	Olive
14	10mm Flat	AD-1011-14BTS	AD-1011-14BT	1.60	Olive
14	11mm Flat	AD-1012-14BTS	AD-1012-14BT	1.60	Olive
14	14mm Flat	AD-1020-14BTS	AD-1020-14BT	1.60	Olive
15	4mm Round	AD-1005-15BTS	AD-1005-15BT	1.37	Amber
15	4mm Pointed	AD-1013-15BTS	AD-1013-15BT	1.37	Amber
15	5mm Round	AD-1006-15BTS	AD-1006-15BT	1.37	Amber
15	5mm Flat	AD-1007-15BTS	AD-1007-15BT	1.37	Amber
15	6mm Flat	AD-1008-15BTS	AD-1008-15BT	1.37	Amber
15	6mm Round	AD-1009-15BTS	AD-1009-15BT	1.37	Amber
15	7mm Flat	AD-1010-15BTS	AD-1010-15BT	1.37	Amber
15	10mm Flat	AD-1011-15BTS	AD-1011-15BT	1.37	Amber
15	11mm Flat	AD-1012-15BTS	AD-1012-15BT	1.37	Amber
15	14mm Flat	AD-1020-15BTS	AD-1020-15BT	1.37	Amber
18	3mm Round	AD-1003-18BTS	AD-1003-18BT	0.84	Green
18	4mm Round	AD-1005-18BTS	AD-1005-18BT	0.84	Green
18	4mm Pointed	AD-1013-18BTS	AD-1013-18BT	0.84	Green
18	5mm Round	AD-1006-18BTS	AD-1006-18BT	0.84	Green
18	5mm Flat	AD-1007-18BTS	AD-1007-18BT	0.84	Green
18	6mm Flat	AD-1008-18BTS	AD-1008-18BT	0.84	Green
18	6mm Round	AD-1009-18BTS	AD-1009-18BT	0.84	Green
18	7mm Flat	AD-1010-18BTS	AD-1010-18BT	0.84	Green
18	10mm Flat	AD-1011-18BTS	AD-1011-18BT	0.84	Green
18	11mm Flat	AD-1012-18BTS	AD-1012-18BT	0.84	Green
18	14mm Flat	AD-1020-18BTS	AD-1020-18BT	0.84	Green
20	2mm Round	AD-1001-20BTS	AD-1001-20BT	0.60	Pink
20	3mm Round	AD-1003-20BTS	AD-1003-20BT	0.60	Pink
20	4mm Round	AD-1005-20BTS	AD-1005-20BT	0.60	Pink
20	4mm Pointed	AD-1013-20BTS	AD-1013-20BT	0.60	Pink
20	5mm Round	AD-1006-20BTS	AD-1006-20BT	0.60	Pink
20	5mm Flat	AD-1007-20BTS	AD-1007-20BT	0.60	Pink
20	6mm Flat	AD-1008-20BTS	AD-1008-20BT	0.60	Pink
20	6mm Round	AD-1009-20BTS	AD-1009-20BT	0.60	Pink
20	7mm Flat	AD-1010-20BTS	AD-1010-20BT	0.60	Pink
20	10mm Flat	AD-1011-20BTS	AD-1011-20BT	0.60	Pink
20	11mm Flat	AD-1012-20BTS	AD-1012-20BT	0.60	Pink
20	14mm Flat	AD-1020-20BTS	AD-1020-20BT	0.60	Pink
21	2mm Round	AD-1001-21BTS	AD-1001-21BT	0.51	Purple
21	3mm Round	AD-1003-21BTS	AD-1003-21BT	0.51	Purple
21	4mm Round	AD-1005-21BTS	AD-1005-21BT	0.51	Purple
21	4mm Pointed	AD-1013-21BTS	AD-1013-21BT	0.51	Purple
21	5mm Round	AD-1006-21BTS	AD-1006-21BT	0.51	Purple
21	5mm Flat	AD-1007-21BTS	AD-1007-21BT	0.51	Purple
21	6mm Flat	AD-1008-21BTS	AD-1008-21BT	0.51	Purple
21	6mm Round	AD-1009-21BTS	AD-1009-21BT	0.51	Purple
21	7mm Flat	AD-1010-21BTS	AD-1010-21BT	0.51	Purple
21	10mm Flat	AD-1011-21BTS	AD-1011-21BT	0.51	Purple
21	11mm Flat	AD-1012-21BTS	AD-1012-21BT	0.51	Purple
21	14mm Flat	AD-1020-21BTS	AD-1020-21BT	0.51	Purple
22	2mm Round	AD-1001-22BTS	AD-1001-22BT	0.41	Blue
22	3mm Round	AD-1003-22BTS	AD-1003-22BT	0.41	Blue
22	4mm Round	AD-1005-22BTS	AD-1005-22BT	0.41	Blue
22	4mm Pointed	AD-1013-22BTS	AD-1013-22BT	0.41	Blue
22	5mm Round	AD-1006-22BTS	AD-1006-22BT	0.41	Blue
22	5mm Flat	AD-1007-22BTS	AD-1007-22BT	0.41	Blue
22	6mm Flat	AD-1008-22BTS	AD-1008-22BT	0.41	Blue
22	6mm Round	AD-1009-22BTS	AD-1009-22BT	0.41	Blue
22	7mm Flat	AD-1010-22BTS	AD-1010-22BT	0.41	Blue
22	10mm Flat	AD-1011-22BTS	AD-1011-22BT	0.41	Blue
22	11mm Flat	AD-1012-22BTS	AD-1012-22BT	0.41	Blue
22	14mm Flat	AD-1020-22BTS	AD-1020-22BT	0.41	Blue



GA	Brush Width	Soft Bristle	Hard Bristle	ID mm	Colour
23	2mm Round	AD-1001-23BTS	AD-1001-23BT	0.33	Orange
23	3mm Round	AD-1003-23BTS	AD-1003-23BT	0.33	Orange
23	4mm Round	AD-1005-23BTS	AD-1005-23BT	0.33	Orange
23	4mm Pointed	AD-1013-23BTS	AD-1013-23BT	0.33	Orange
23	5mm Round	AD-1006-23BTS	AD-1006-23BT	0.33	Orange
23	5mm Flat	AD-1007-23BTS	AD-1007-23BT	0.33	Orange
23	6mm Flat	AD-1008-23BTS	AD-1008-23BT	0.33	Orange
23	6mm Round	AD-1009-23BTS	AD-1009-23BT	0.33	Orange
23	7mm Flat	AD-1010-23BTS	AD-1010-23BT	0.33	Orange
23	10mm Flat	AD-1011-23BTS	AD-1011-23BT	0.33	Orange
23	11mm Flat	AD-1012-23BTS	AD-1012-23BT	0.33	Orange
23	14mm Flat	AD-1020-23BTS	AD-1020-23BT	0.33	Orange
25	2mm Round	AD-1001-25BTS	AD-1001-25BT	0.25	Red
25	3mm Round	AD-1003-25BTS	AD-1003-25BT	0.25	Red
25	4mm Round	AD-1005-25BTS	AD-1005-25BT	0.25	Red
25	4mm Pointed	AD-1013-25BTS	AD-1013-25BT	0.25	Red
25	5mm Round	AD-1006-25BTS	AD-1006-25BT	0.25	Red
25	5mm Flat	AD-1007-25BTS	AD-1007-25BT	0.25	Red
25	6mm Flat	AD-1008-25BTS	AD-1008-25BT	0.25	Red
25	6mm Round	AD-1009-25BTS	AD-1009-25BT	0.25	Red
25	7mm Flat	AD-1010-25BTS	AD-1010-25BT	0.25	Red
25	10mm Flat	AD-1011-25BTS	AD-1011-25BT	0.25	Red
25	11mm Flat	AD-1012-25BTS	AD-1012-25BT	0.25	Red
25	14mm Flat	AD-1020-25BTS	AD-1020-25BT	0.25	Red
27	2mm Round	AD-1001-27BTS	AD-1001-27BT	0.21	Clear
27	3mm Round	AD-1003-27BTS	AD-1003-27BT	0.21	Clear
27	3.5mm Round	AD-1004-27BTS	AD-1004-27BT	0.21	Clear
27	4mm Round	AD-1005-27BTS	AD-1005-27BT	0.21	Clear
27	4mm Pointed	AD-1013-27BTS	AD-1013-27BT	0.21	Clear
27	5mm Round	AD-1006-27BTS	AD-1006-27BT	0.21	Clear
27	5mm Flat	AD-1007-27BTS	AD-1007-27BT	0.21	Clear
27	6mm Flat	AD-1008-27BTS	AD-1008-27BT	0.21	Clear
27	6mm Round	AD-1009-27BTS	AD-1009-27BT	0.21	Clear
27	7mm Flat	AD-1010-27BTS	AD-1010-27BT	0.21	Clear
27	10mm Flat	AD-1011-27BTS	AD-1011-27BT	0.21	Clear
27	11mm Flat	AD-1012-27BTS	AD-1012-27BT	0.21	Clear
27	14mm Flat	AD-1020-27BTS	AD-1020-27BT	0.21	Clear
30	2mm Round	AD-1001-30BTS	AD-1001-30BT	0.15	Lavender
30	3mm Round	AD-1003-30BTS	AD-1003-30BT	0.15	Lavender
30	4mm Round	AD-1005-30BTS	AD-1005-30BT	0.15	Lavender
30	5mm Round	AD-1006-30BTS	AD-1006-30BT	0.15	Lavender
30	6mm Round	AD-1009-30BTS	AD-1009-30BT	0.15	Lavender
All	2mm-14mm	BT-SOKIT	BT-STKIT	All	100 pcs

## Single component cartridge dispensing



### Manual Single Component Cartridge Applicator Guns for Techcon and Semco Cartridges

High quality cartridge gun applicators for controlled dispensing of assembly fluids and pastes. To handle sealants, RTVs, silicones, adhesives, gels, potting compounds and many other materials in disposable cartridges or Techkit, Semkit cartridges for multi-component materials. With retainers to fit standard 2.5, 6, 8, 10, 12, 20 and 32 ounce Techcon and Semco cartridges, Techkits and Semkits as well as sachets.

#### 850 Series Manual Guns

The 850 series guns have lightweight threaded metal retainer sleeves.



Size	Part Code
2.5oz	221824
6oz	221830
8oz	221832
10oz	230273
12oz	221836
20oz	230274
32oz	234054

**Material:** Steel, Aluminium  
**Colour:** Silver  
**Length:** 115mm to 355mm  
**Thrust:** 2.5kN  
**Cartridge Size:** 2.5oz, 6oz, 8oz, 10oz, 12oz, 20oz, 32oz  
**Length:** 325mm to 550mm  
**Weight:** 0.75kg to 1.25kg  
**Force Ratio:** 22:1 High

Use with Techcon, Semco cartridges, Techkits, Semkits

#### 900 Series Manual Guns

The 900 series guns have lightweight bayonet metal retainer sleeves.



Use with Techcon, Semco cartridges, Techkits, Semkits

**Material:** Steel, Nylon  
**Thrust:** 2.5kN  
**Colour:** Black/Silver  
**Cartridge Size:** 2.5, 6, 8, 12oz  
**Weight:** 0.50kg  
**Frame Length:** 230mm  
**Force Ratio:** 18:1 Medium

Size	Part Code
2.5oz	951N
6oz	952N
8oz	963N
12oz	954N

#### AD16 Series Manual Guns

The AD16 series guns have lightweight threaded metal retainer sleeves.



Use with Techcon, Semco cartridges, Techkits, Semkits

**Material:** Steel, Aluminium  
**Length:** 115mm to 325mm  
**Cartridge Size:** 2.5, 6, 8, 10, 12oz  
**Thrust:** 2.5kN  
**Colour:** Black  
**Weight:** 0.85kg to 0.95kg  
**Force Ratio:** 18:1 Medium

Size	Part Code
2.5oz	AD16-25
6oz	AD16-60
8oz	AD16-80
10oz	AD16-110
12oz	AD16-120

#### TS16 Series Manual Guns

The TS16 series guns have lightweight bayonet metal retainer sleeves.



Use with Techcon, Semco cartridges, Techkits, Semkits

**Material:** Steel, Aluminium  
**Length:** 115mm to 325mm  
**Cartridge Size:** 2.5, 6, 8, 12oz  
**Thrust:** 2.5kN  
**Colour:** Black  
**Weight:** 0.85kg to 0.95kg  
**Force Ratio:** 18:1 Medium

Size	Part Code
2.5oz	TS16-25
6oz	TS16-60
8oz	TS16-80
12oz	TS16-120

#### FMG Series Manual Guns

The TS16 series guns have lightweight thread nylon retainer sleeves.



Use with Techcon, Semco cartridges, Techkits, Semkits

**Material:** Steel, Nylon  
**Length:** 115mm to 325mm  
**Cartridge Size:** 2.5, 6, 8, 12oz  
**Thrust:** 2.2kN  
**Colour:** Black  
**Weight:** 0.85kg to 0.95kg  
**Force Ratio:** 18:1 Medium

Size	Part Code
2.5oz	FMG-25
6oz	FMG-60
8oz	FMG-80
12oz	FMG-120

#### AD16-20R Large Size Manual Cartridge Gun

Manual gun for use with 20 ounce Techcon and Semco cartridges and with Techkit/ Semkit dual component mixer cartridges. Gun includes the trigger, retainer sleeve and adapter. All precision machined metal.



**Material:** Steel, Aluminium  
**Length:** 325mm  
**Cartridge Size:** 20 oz  
**Thrust:** 2.5kN  
**Colour:** Black  
**Weight:** 1.75kg  
**Force Ratio:** 18:1 Medium

Size	Part Code
20oz	AD16-20R

Use with Techcon, Semco cartridges, Techkits, Semkits

## Single component manual cartridge dispensing

### 310ml Cartridge Gun

One component, manual, hand applicator for cartridges.

Material: Steel, Nylon  
 Thrust: 2.5kN  
 Colour: Black/ Red  
 Cartridge Size: 10oz (310ml)  
 Weight: 0.60kg  
 Frame Length: 230mm  
 Force Ratio: 18:1 Medium



Size	Part Code
310ml	H40PS

Use with 310ml cartridges only.

### 310ml Cartridge & 400ml Sachet Gun

One component, manual, hand applicator for cartridges/sachets.

Material: Steel, Nylon  
 Thrust: 2.5kN  
 Cartridge Size: 310ml/400ml  
 Weight: 0.70kg  
 Frame Length: 229mm  
 Thrust Ratio: 18:1 Medium



Size	Part Code
310ml/400ml	H3PSA-ADL

Use with 310ml cartridges and 400ml sachets.

### 310ml / 400ml Cartridge Gun

One component, manual, hand applicator for cartridges.

Weight: 1.3kg  
 Barrel Length: 257mm  
 Max Thrust: 2.5kN  
 Material: Aluminium/ Steel  
 Cartridge Size: 310ml  
 Sachet Size: 400ml  
 Force Ratio: 18:1 Medium



Size	Part Code
310ml/400ml	H3P-ADL

Use with 310ml and 400ml cartridges.

### 310ml / 400ml Cartridge & 400ml / 600ml Sachet Gun

One component, manual, hand applicator for cartridges/sachets.

Material: Nylon, Aluminium  
 Thrust: 5kN  
 Cartridge Size: 310ml, 400ml, 600ml  
 Weight: 1.29kg  
 Frame Length: 373mm  
 Force Ratio: 26:1 High



Size	Part Code
310ml/400ml	H2PSA-ADL

Use with 310ml and 400ml cartridges and 400ml and 600ml sachets.

### 310ml / 400ml Cartridge & 400ml / 600ml Sachet Gun

One component, manual, hand applicator for cartridges/sachets.

Weight: 1.35kg  
 Barrel Length: 372mm  
 Max Thrust: 2.5kN  
 Material: Aluminium/ Steel  
 Cartridge Size: 310ml/400ml  
 Sachet Size: 400ml/600ml  
 Force Ratio: 18:1 Medium



Size	Part Code
310ml/400ml/600ml	H2P-ADL

Use with 310ml and 400ml cartridges and 400ml and 600ml sachets.

### 310ml Cartridge Gun

One component, manual, hand applicator for cartridges.

Material: Nylon  
 Thrust: 2.5kN  
 Cartridge Size: 310ml  
 Weight: 0.60kg  
 Frame Length: 230mm  
 Thrust Ratio: 18:1 Medium



Size	Part Code
310ml	H40PSOE-ADL

Use with 310ml cartridges only.

### 310ml Cartridge & 400ml Sachet Gun

One component, manual, hand applicator for cartridges/sachets.

Weight: 0.7kg  
 Barrel Length: 255mm  
 Max Thrust: 2.5kN  
 Material: Nylon/ Steel  
 Cartridge Size: 310ml/400ml  
 Force Ratio: 18:1 Medium



Size	Part Code
310ml/400ml	H3PS-ADL

Use with 310ml cartridges and 400ml sachets.

### 310ml Cartridge Gun

One component, manual, hand applicator for cartridges.

Material: Nylon  
 Thrust: 2.5kN  
 Cartridge Size: 310ml  
 Weight: 0.77kg  
 Frame Length: 243mm  
 Thrust Ratio: 12:1 Low



Size	Part Code
310ml	H14RS-ADL

Use with 310ml cartridges only.

### 310ml / 400ml Cartridge & 400ml / 600ml Sachet Gun

One component, manual, hand applicator for cartridges/sachets.

Weight: 0.80kg  
 Frame Length: 345mm  
 Max Thrust: 2.5kN  
 Material: Nylon/ Steel  
 Cartridge Size: 310ml/400ml/600ml  
 Force Ratio: 18:1 Medium



Size	Part Code
310ml/400ml/600ml	H2PS-ADL

Use with 310ml and 400ml cartridges and 400ml and 600ml sachets.

### 310ml Cartridge Gun

One component, manual, hand applicator for cartridges.

Material: Steel/ Nylon  
 Thrust: 2.5kN  
 Cartridge Size: 310ml  
 Weight: 0.95kg  
 Frame Length: 256mm  
 Thrust Ratio: 18:1 Medium



Size	Part Code
310ml	H45-ADL

Use with 310ml cartridges only.



## Single component manual cartridge dispensing

### 310ml Cartridge Gun

One component, manual, hand applicator for cartridges.

**Material:** Nylon  
**Thrust:** 1.25kN  
**Cartridge Size:** 310ml  
**Weight:** 0.55kg  
**Frame Length:** 225mm  
**Force Ratio:** 12:1 Low



Use with 310ml cartridges only.

Size	Part Code
310ml	H1X-ADL

### 310ml Cartridge Gun

Powerful one component, manual, hand applicator for cartridges.

**Material:** Nylon  
**Thrust:** 5kN  
**Cartridge Size:** 310ml  
**Weight:** 0.80kg  
**Frame Length:** 250mm  
**Force Ratio:** 26:1 High



Use with 310ml cartridges only.

Size	Part Code
310ml	H245-ADL

### 310ml / 400ml Cartridge & 400ml / 600ml Sachet Gun

One component, manual, hand applicator for cartridges/sachets.

**Material:** Steel, Nylon  
**Thrust:** 2.5kN  
**Cartridge Size:** 310ml/400ml/600ml  
**Weight:** 0.91kg  
**Frame Length:** 344mm  
**Thrust Ratio:** 18:1 Medium



Use with 310ml and 400ml cartridges and 400ml and 600ml sachets.

Size	Part Code
310ml/400ml/600ml	H212P-ADL

### 310ml Cartridge Gun

One component, manual, hand applicator for cartridges.

**Material:** Steel/ Nylon  
**Thrust:** 1.2kN  
**Cartridge Size:** 310ml Only  
**Weight:** 0.32kg  
**Frame Length:** 234mm  
**Force Ratio:** 7:1 Very Low



Use with 310ml cartridges only.

Size	Part Code
310ml	EASIFLOW-HD-LITE

### 310ml / 400ml Cartridge Gun

One component, manual, hand applicator for cartridges.

**Material:** Steel, Nylon  
**Thrust:** 1.5kN  
**Cartridge Size:** 310ml/400ml  
**Weight:** 0.67kg  
**Frame Length:** 271mm  
**Thrust Ratio:** 10:1 Low



Use with 310ml and 400ml cartridges.

Size	Part Code
310ml/ 400ml	MIDIFLOW

### 310ml / 400ml Cartridge Gun

One component, manual, hand applicator for cartridges.

**Material:** Steel/ Nylon  
**Thrust:** 1.2kN  
**Cartridge Size:** 310ml/ 400ml  
**Weight:** 0.54kg  
**Frame Length:** 268mm  
**Force Ratio:** 7:1



Use with 310ml and 400ml cartridges.

Size	Part Code
310ml/400ml	EASIFLOW HD

### 310ml / 400ml Cartridge & 400ml / 600ml Sachet Gun

One component, manual, hand applicator for cartridges/sachets.

**Material:** Glass Fiber Nylon  
**Thrust:** 1.5kN  
**Cartridge Size:** 310ml/ 400ml/ 600ml  
**Weight:** 0.58kg  
**Frame Length:** 377mm  
**Force Ratio:** 10:1 Low



Use with 310ml and 400ml cartridges and 310ml, 400ml and 600ml sachets.

Size	Part Code
310ml/400ml/600ml	MFC-600-ADL

### 310ml/400ml Cartridge & 400ml/600ml Sachet Gun

One component, manual, hand applicator for cartridges/sachets.

**Material:** Aluminium  
**Thrust:** 2.5kN  
**Cartridge Size:** 310ml, 400ml, 600ml  
**Weight:** 1.1kg  
**Frame Length:** 256mm  
**Force Ratio:** 12:1 Low to Medium



Use with 310ml and 400ml cartridges and 310ml, 400ml and 600ml sachets.

Size	Part Code
310ml/400ml/600ml	PF-Combi-ADL

### 310ml / 400ml Cartridge Gun

One component, manual, hand applicator for cartridges.

**Material:** Aluminium  
**Thrust:** 2.5kN  
**Cartridge Size:** 310ml/ 400ml  
**Weight:** 0.79kg  
**Frame Length:** 274mm  
**Force Ratio:** 12:1 Low to Medium



Use with 310ml and 400ml cartridges.

Size	Part Code
310ml/ 400ml	PF-400-ADL

### 310ml/400ml Cartridge & 400ml/600ml Sachet Gun

One component, manual, hand applicator for cartridges.

**Material:** Coated Steel  
**Thrust:** 3.5kN  
**Cartridge Size:** 310ml/ 400ml  
**Weight:** 0.80 to 0.90kg  
**Frame Length:** 233 to 271mm  
**Force Ratio:** 18:1 Medium



Use with 310ml and 400ml cartridges.

Size	Part Code
310ml	PF-310-ADL
400ml	PF-400-ADL

## Single component manual cartridge dispensing

### 310ml/400ml Cartridge & 310ml/400ml/600ml Sachet Gun

One component, manual, hand applicator for cartridges/sachets.

**Material:** Aluminium/ Steel  
**Thrust:** 3.5kN  
**Cartridge Size:** 310ml/ 400ml/ 600ml  
**Weight:** 0.90 to 1.1kg  
**Frame Length:** 274 to 382mm  
**Force Ratio:** 18:1 Medium

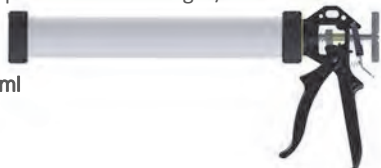

Use with 310ml and 400ml cartridges and 310ml, 400ml and 600ml sachets.

Size	Part Code
310ml	PFHPC-310-ADL
400ml	PFHPC-400-ADL
600ml	PFHPC-600-ADL

### 310ml Cartridge Gun

One component, manual, hand applicator for cartridges.

**Material:** Aluminium  
**Thrust:** 4.5kN  
**Cartridge Size:** 310ml  
**Weight:** 0.90kg  
**Frame Length:** 243mm  
**Force Ratio:** 25:1 High



Use with 310ml cartridges only.

Size	Part Code
310ml	UF-310-ADL

### 310ml/400ml Cartridge & 310ml/400ml/600ml Sachet Gun

One component, manual, hand applicator for cartridges/sachets.

**Material:** Aluminium  
**Thrust:** 4.5kN  
**Cartridge Size:** 310ml/ 400ml/ 600ml  
**Weight:** 1.0 to 1.2kg  
**Frame Length:** 342 to 482mm  
**Force Ratio:** 25:1 High



Use with 310ml and 400ml cartridges and 310ml, 400ml and 600ml sachets.

Size	Part Code
310ml	UFC-310-ADL
400ml/600ml	UFC-600-ADL

### 310ml Cartridge Gun

One component, manual, hand applicator for cartridges.

**Material:** Nylon  
**Thrust:** 4.0kN  
**Cartridge Size:** 310ml  
**Weight:** 1.42kg  
**Frame Length:** 245mm  
**Force Ratio:** 22:1 High



Use with 310ml cartridges only.

Size	Part Code
310ml	AD290NB

### 310ml Cartridge Gun

One component, manual, hand applicator for cartridges.

**Material:** Steel  
**Thrust:** 0.5kN  
**Cartridge Size:** 310ml  
**Weight:** 0.6kg  
**Frame Length:** 233mm  
**Force Ratio:** 3:1 Very Low



Use with 310ml cartridges only.

Size	Part Code
310ml	AD012-DCNB

### 310ml Cartridge Gun

One component, manual, hand applicator for cartridges.

**Material:** Steel  
**Thrust:** 1.5kN  
**Cartridge Size:** 310ml  
**Weight:** 0.70kg  
**Frame Length:** 233mm  
**Force Ratio:** 10:1 Medium



Use with 310ml cartridges only.

Size	Part Code
310ml	AD101NB

### 310ml Cartridge Gun

One component, manual, hand applicator for cartridges.

**Material:** Steel  
**Thrust:** 1.5kN  
**Cartridge Size:** 310ml  
**Weight:** 0.73kg  
**Frame Length:** 245mm  
**Force Ratio:** 10:1 Medium



Use with 310ml cartridges only.

Size	Part Code
310ml	AD102D-NB

### 310ml Cartridge Gun

One component, manual, hand applicator for cartridges.

**Material:** Steel  
**Thrust:** 1.2kN  
**Cartridge Size:** 310ml  
**Weight:** 0.72kg  
**Frame Length:** 245mm  
**Force Ratio:** 7:1 Low



Use with 310ml cartridges only.

Size	Part Code
310ml	AD114D-NB

### 310ml Cartridge Gun

One component, manual, hand applicator for cartridges.

**Material:** Steel  
**Thrust:** 1.5kN  
**Cartridge Size:** 310ml  
**Weight:** 0.70kg  
**Frame Length:** 245mm  
**Force Ratio:** 10:1 Medium



Use with 310ml cartridges only.

Size	Part Code
310ml	AD111NB

### 310ml Cartridge Gun

One component, manual, hand applicator for cartridges.

**Material:** Steel  
**Thrust:** 1.5kN  
**Cartridge Size:** 310ml  
**Weight:** 0.70kg  
**Frame Length:** 245mm  
**Force Ratio:** 10:1 Medium



Use with 310ml cartridges only.

Size	Part Code
310ml	AD112DNB



## Single component manual cartridge dispensing

### 310ml Cartridge Gun

One component, manual, hand applicator for cartridges.

Material: Steel  
 Thrust: 1.0kN  
 Cartridge Size: 310ml  
 Weight: 0.63kg  
 Frame Length: 245mm  
 Force Ratio: 6:1 Low



Use with 310ml cartridges only.

Size	Part Code
310ml	AD189D-NB

### 310ml Cartridge Gun

Powerful one component, manual, hand applicator for cartridges.

Material: Steel/Nylon  
 Thrust: 1.5kN  
 Cartridge Size: 310ml  
 Weight: 0.62kg  
 Frame Length: 245mm  
 Force Ratio: 10:1 Medium



Use with 310ml cartridges only.

Size	Part Code
310ml	AD211-HTS-NB

### 310ml Cartridge Gun

One component, manual, hand applicator for cartridges.

Material: Steel/ Nylon  
 Thrust: 1.5kN  
 Cartridge Size: 310ml  
 Weight: 0.68kg  
 Frame Length: 245mm  
 Force Ratio: 10:1 Medium



Use with 310ml cartridges only.

Size	Part Code
310ml	AD212HTD-NB

### 310ml Cartridge Gun

One component, manual, hand applicator for cartridges.

Material: Nylon  
 Thrust: 1.5kN  
 Cartridge Size: 310ml  
 Weight: 0.41kg  
 Frame Length: 245mm  
 Force Ratio: 10:1 Medium



Use with 310ml cartridges only.

Size	Part Code
310ml	ULITE-NB

### 310ml Cartridge Gun

One component, manual, hand applicator for cartridges.

Material: Steel  
 Thrust: 3.5kN  
 Cartridge Size: 310ml  
 Weight: 0.98kg  
 Frame Length: 245mm  
 Force Ratio: 18:1 High



Use with 310ml cartridges only.

Size	Part Code
310ml	AD250NB

### 310ml Cartridge Gun

One component, manual, hand applicator for cartridges.

Material: Steel  
 Thrust: 2.5kN  
 Cartridge Size: 310ml  
 Weight: 0.98kg  
 Frame Length: 245mm  
 Force Ratio: 12:1 Medium



Use with 310ml cartridges only.

Size	Part Code
310ml	AD150NB

### 310ml Cartridge Gun

One component, manual, hand applicator for cartridges.

Material: Steel, Nylon  
 Thrust: 1.5kN  
 Cartridge Size: 310ml  
 Weight: 0.68kg  
 Frame Length: 245mm  
 Force Ratio: 10:1 Medium



Use with 310ml cartridges only.

Size	Part Code
310ml	AD288-HTRNB

### 310ml Cartridge Gun

One component, manual, hand applicator for cartridges.

Material: Steel  
 Thrust: 2.5kN  
 Cartridge Size: 310ml  
 Weight: 0.92kg  
 Frame Length: 245mm  
 Force Ratio: 12:1 Medium



Use with 310ml cartridges only.

Size	Part Code
310ml	AD301NB

### 310ml Cartridge Gun

One component, manual, hand applicator for cartridges.

Material: Steel, Nylon  
 Thrust: 4.6kN  
 Cartridge Size: 310ml  
 Weight: 0.92kg  
 Frame Length: 245mm  
 Force Ratio: 26:1 High



Use with 310ml cartridges only.

Size	Part Code
310ml	AD301XSP-NB

### 310ml Cartridge Gun

One component, manual, hand applicator for cartridges.

Material: Steel  
 Thrust: 1.0kN  
 Cartridge Size: 310ml  
 Weight: 0.68kg  
 Frame Length: 245mm  
 Force Ratio: 6:1 Low



Use with 310ml cartridges only.

Size	Part Code
310ml	AD188NB



## Single component manual cartridge dispensing

### 400ml Cartridge Gun

One component, manual, hand applicator for cartridges.

Material: Steel  
 Thrust: 2.5kN  
 Cartridge Size: 400ml  
 Weight: 0.90kg  
 Frame Length: 245mm  
 Force Ratio: 12:1 Medium



Use with 310ml cartridges only.

Size	Part Code
310ml	AD400NB

### 310ml Cartridge Gun

One component, manual, hand applicator for cartridges.

Material: Steel  
 Thrust: 4.6kN  
 Cartridge Size: 310ml  
 Weight: 1.13kg  
 Frame Length: 245mm  
 Force Ratio: 26:1 High



Use with 310ml cartridges only.

Size	Part Code
310ml	AD373XSP-NB

### Bulk Sachet Dispensing Gun

One component, manual, hand applicator for bulk sachets.

Material: Aluminium/ Steel  
 Thrust: 2.5kN  
 Sachet Size: 2000,3000,4000ml  
 Weight: 3.1 to 4.5kg  
 Frame Length: 529 to 935mm  
 Force Ratio: 12:1 Medium

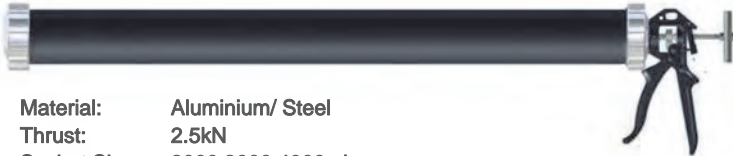

Size	Part Code
2000ml	PF-2000-ADL
3000ml	PF-3000-ADL
4000ml	PF-4000-ADL

### 1000ml Bulk Cartridge Gun

One component, manual, hand applicator for cartridges.

Material: Aluminium  
 Thrust: 2.5kN  
 Cartridge Size: 1000ml (33.8oz)  
 Weight: 1.12kg  
 Frame Length: 256mm  
 Force Ratio: 12:1 Medium



Use with 1000ml cartridges only.

Size	Part Code
1000ml	PF-1000S-ADL

### 800ml Bulk Sealant Gun

One component, manual, hand applicator for bulk sealant tubes.

Material: Aluminium  
 Thrust: 2.5kN  
 Cartridge Size: 800ml  
 Weight: 1.42kg  
 Frame Length: 300mm  
 Force Ratio: 12:1 Medium



Use with 800ml sealant tubes.

Size	Part Code
800ml	UP-Bulk-ADL

### 29oz Bulk Cartridge Gun

One component, manual, hand applicator for large cartridges.

Material: Steel  
 Thrust: 1.5kN  
 Cartridge Size: 29oz  
 Weight: 1.2kg  
 Frame Length: 482mm  
 Force Ratio: 10:1 Medium



Use with 29oz cartridges only.

Size	Part Code
29oz	AD105D-NB

### 29oz Bulk Cartridge Gun

One component, manual, hand applicator for large cartridges.

Material: Steel  
 Thrust: 3.5kN  
 Cartridge Size: 29oz  
 Weight: 1.36kg  
 Frame Length: 482mm  
 Force Ratio: 18:1 High



Use with 29oz cartridges only.

Size	Part Code
29oz	AD255-NB

### 29oz Cartridge Gun

One component, manual, hand applicator for large cartridges.

Material: Steel  
 Thrust: 1.0kN  
 Cartridge Size: 29oz  
 Weight: 1.13kg  
 Frame Length: 482mm  
 Force Ratio: 6:1 Low



Use with 29oz cartridges only.

Size	Part Code
29oz	AD215-NB

### 29oz Bulk Cartridge Gun

One component, manual, hand applicator for large cartridges.

Material: Steel  
 Thrust: 1.0kN  
 Cartridge Size: 29oz  
 Weight: 1.18kg  
 Frame Length: 482mm  
 Force Ratio: 6:1 Low



Use with 29oz cartridges only.

Size	Part Code
29oz	AD217D-NB

### 24oz Bulk Cartridge Gun

One component, manual, hand applicator for bulk cartridges.

Material: Aluminium  
 Thrust: 1.2kN  
 Cartridge Size: 24oz  
 Weight: 0.80kg  
 Frame Length: 482mm  
 Force Ratio: 7:1 Low



Size	Part Code
10oz, 24oz	AD224-LITE

## Air Powered Single Component Cartridge Applicator Guns for Techcon and Semco Cartridges

Pneumatic cartridge gun applicators for controlled dispensing of assembly fluids and pastes. For sealants, RTVs, silicones, adhesives, gels, and many other materials in disposable cartridges or Techkit, Semkit cartridges for multi-component materials. With retainers to fit standard 2.5, 6, 8, 10, 12, 20 and 32 ounce Techcon and Semco cartridges, Techkits and Semkits as well as sachets. Low, medium or high viscosity material versions.

### 100A Series Cartridge Guns

One component, air drive, applicator for cartridges. Threaded sleeve. With adjustable regulator for flow control. Hook ring.

**Material:** Steel  
**Pressure:** 100 PSI Max.  
**Thrust:** 1.45kN Medium  
**Cartridge Size:** 2.5, 6, 8, 10, 12oz  
**Weight:** 1.95kg



Use with Techcon, Semco cartridges, Techkits, Semkits

Size	Part Code
2.5oz	100A-25
6oz	100A-60
8oz	100A-80
10oz	100A-110
12oz	100A-120

### TS950 Series Cartridge Guns

One component, air drive, applicator for cartridges. Bayonet slotted sleeve to view plunger level. Removable trigger.

**Material:** Aluminium  
**Pressure:** 100 PSI Max.  
**Thrust:** 1.45kN Medium  
**Cartridge Size:** 2.5, 6, 8, 12oz  
**Weight:** 1.25kg



Use with Techcon, Semco cartridges, Techkits, Semkits

Size	Part Code
2.5oz	TS950-25-HA
6oz	TS950-60-HA
8oz	TS950-80-HA
12oz	TS950-120-HA

### 250A Series Cartridge Guns

One component, air drive, applicator for cartridges. Bayonet sleeve. The choice of aerospace manufacturers.

**Material:** Steel, Nylon  
**Pressure:** 100 PSI Max.  
**Thrust:** 1.45kN Medium  
**Cartridge Size:** 2.5, 6, 8, 12oz  
**Weight:** 1.25kg



Use with Techcon, Semco cartridges, Techkits, Semkits

Size	Part Code
2.5oz	250255
6oz	250065
8oz	250085
12oz	250125

### 250B Series Cartridge Guns

One component, air drive, applicator for cartridges. Bayonet sleeve. No trigger reduces gun size for ease of access.

**Material:** Steel, Nylon  
**Pressure:** 100 PSI Max.  
**Thrust:** 1.45kN Medium  
**Cartridge Size:** 2.5, 6, 8, 12oz  
**Weight:** 1.15kg



Use with Techcon, Semco cartridges, Techkits, Semkits

Size	Part Code
2.5oz	250250B
6oz	250060B
8oz	250080B
12oz	250120B

### 110A Series Rod Driven Cartridge Guns

One component, rod driven, applicator for cartridges. Threaded sleeve. With adjustable regulator for flow control. Hook ring. Powerful gun.

**Material:** Steel  
**Pressure:** 100 PSI  
**Thrust:** 4.45kN High  
**Cartridge Sizes:** 6, 8, 10oz  
**Weight:** 2.75kg



Use with Techcon, Semco cartridges, Techkits, Semkits

Size	Part Code
6oz	110A-60
8oz	110A-80
10oz	110A-110

### AD110-20 Large Size Cartridge Gun

Direct air drive gun for use with 20 ounce Techcon and Semco cartridges and with Techkit/ Semkit dual component mixer cartridges. Gun includes the trigger, retainer sleeve and adapter. All precision machined metal.

**Material:** Steel  
**Pressure:** 100 PSI Max.  
**Thrust:** 2.5kN Medium  
**Cartridge Size:** 20oz Only  
**Weight:** 2.75kg



Use with Techcon, Semco cartridges, Techkits, Semkits

Size	Part Code
20oz	AD110-20

### TS2560 Multi Size Cartridge Guns

One component, air drive, applicator for cartridges. Adjustable sleeve. The same gun can be used with

**Material:** Nylon, Steel  
**Pressure:** 100 PSI Max.  
**Thrust:** 1.45kN Medium  
**Cartridge Size:** 2.5, 6, 8, 12oz  
**Weight:** 0.95kg

Type	Part Code
Piston Grip	TS2560-HG
Palm Grip	TS5560-PG

Use with Techcon, Semco cartridges, Techkits, Semkits



### FLG Series Lever Cartridge Guns

One component, air drive, applicator for cartridges. Nylon sleeve.

**Material:** Nylon  
**Pressure:** 100 PSI Max.  
**Thrust:** 1.45kN Medium  
**Cartridge Size:** 2.5, 6, 8, 12oz  
**Weight:** 0.95kg

Size	Part Code
2.5oz	FLG-25
6oz	FLG-60
8oz	FLG-80
12oz	FLG-120

Use with Techcon, Semco cartridges, Techkits, Semkits



### 350 Series Cartridge Guns

One component, air drive, applicator for cartridges. Bayonet sleeve. With adjustable regulator for flow control.

**Material:** Steel, Nylon  
**Pressure:** 100 PSI Max.  
**Thrust:** 1.45kN Medium  
**Cartridge Size:** 2.5, 6, 8, 12oz  
**Weight:** 1.25kg



Size	Part Code
2.5oz	250255
6oz	250065
8oz	250085
12oz	250125

Use with Techcon, Semco cartridges, Techkits, Semkits

### 310ml Cartridge Sealant Gun

One component, air drive, applicator for 310ml sealant cartridges. With adjustable regulator for flow rate control.

**Material:** Nylon, Aluminium  
**Pressure:** 100 PSI Max.  
**Thrust:** 1.45kN Medium  
**Cartridge Size:** 310ml Only  
**Weight:** 0.60kg



Size	Part Code
310ml	C-110CXO

Use with 310ml cartridges only.

### 310ml /400ml Cartridge Sealant Guns

One component, air drive, applicators for 310ml and 400ml sealant cartridges. With adjustable regulator for flow rate control. Airflow 2.

**Material:** Nylon, Aluminium  
**Pressure:** 100 PSI Max.  
**Thrust:** 1.2kN Medium  
**Cartridge Size:** 310ml, 400ml  
**Weight:** 0.75kg



Size	Part Code
310ml	AF310C2
400ml	AF400C2

### 310ml Cartridge Sealant Gun

One component, air drive, applicator for 310ml sealant cartridges. With adjustable regulator for flow rate control.

**Material:** Nylon, Steel  
**Pressure:** 100 PSI Max.  
**Thrust:** 1.30kN Low  
**Cartridge Sizes:** 310ml  
**Weight:** 0.88kg



Size	Part Code
310ml	TS16X

Use with 310ml cartridges only.

### 310ml/400ml Cartridge & 310ml/400ml/600ml Sachet Gun

One component, air drive, applicators for sealant cartridges and sachet tubes. With adjustable regulator for flow rate control. Airflow 1.

**Material:** Nylon, Aluminium  
**Pressure:** 100 PSI Max.  
**Thrust:** 1.45kN Medium  
**Sizes:** 310, 400, 600ml  
**Weight:** 1.5kg



Size	Part Code
310ml	AF310C1
400ml	AF400C1
600ml	AF600C1

### 310ml/400ml/600ml Sachet Guns

One component, manual, hand applicator for sachet sausages. Airflow 1

**Material:** Nylon, Aluminium  
**Pressure:** 100 PSI Max.  
**Thrust:** 1.45kN Medium  
**Cartridge Sizes:** 310, 400, 600ml  
**Weight:** 0.95kg



Size	Part Code
310ml	AF310S1
400ml	AF400S1
600ml	AF600S1

### 310ml/400ml/600ml Sachet Guns

One component, manual, hand applicator for sachet sausages. Airflow 2

**Material:** Nylon, Aluminium  
**Pressure:** 100 PSI Max.  
**Thrust:** 1.45kN Medium  
**Cartridge Size:** 310, 400, 600ml  
**Weight:** 1.1kg

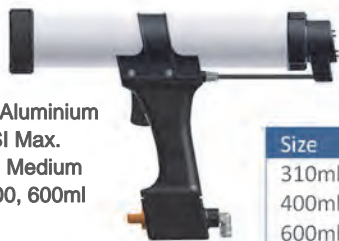

Size	Part Code
310ml	AF310S2
400ml	AF400S2
600ml	AF600S2

### 310ml/400ml/600ml Sachet Guns

One component, manual, hand applicator for sachet sausages. Airflow 3.

**Material:** Nylon, Aluminium  
**Pressure:** 100 PSI Max.  
**Thrust:** 1.50kN Medium  
**Cartridge Sizes:** 310, 400, 600ml  
**Weight:** 0.90kg



Size	Part Code
310ml	AF310S3
400ml	AF400S3
600ml	AF600S3

### 310ml/400ml Cartridge & 310ml/400ml/600ml Sachet Gun

One component, air drive, applicators for sealant cartridges and sachet tubes. With adjustable regulator for flow rate control. Airflow 2.

**Material:** Nylon, Aluminium  
**Pressure:** 100 PSI Max.  
**Thrust:** 1.45kN Medium  
**Cartridge Sizes:** 310, 400, 600ml  
**Weight:** 1.43kg



Size	Part Code
310ml	AF210C1
400ml	AF200C1
600ml	AF200C1

### 310ml /400ml Cartridge Sealant Guns

One component, air drive, applicators for 310ml and 400ml sealant cartridges. With adjustable regulator for flow rate control. Airflow 3.

Size	Part Code
310ml	AF310C3
400ml	AF400C3

**Material:** Nylon, Aluminium  
**Pressure:** 100 PSI Max.  
**Thrust:** 1.45kN Medium  
**Cartridge Sizes:** 310ml, 400ml  
**Weight:** 0.60kg





## Single component pneumatic cartridge dispensing



### 400ml Cartridge & 400ml Sachet Gun

One component, air drive, applicators for 400ml cartridges and 400ml sachet tubes. With adjustable regulator for flow rate control. Airflow 3.



**Material:** Nylon, Aluminium  
**Pressure:** 100 PSI Max.  
**Thrust:** 1.50kN Medium  
**Cartridge Size:** 400ml  
**Weight:** 1.25kg

Size	Part Code
400ml	AFC400-3

### 310ml Cartridge & 310ml/400ml/600ml Sachet Gun

One component, air drive, applicators for cartridges and sachet tubes. With adjustable regulator for flow rate control. Airflow 3.



**Material:** Nylon, Aluminium  
**Pressure:** 100 PSI Max.  
**Thrust:** 1.50kN Medium  
**Cartridge Size:** 310, 400, 600ml  
**Weight:** 1.0kg

Size	Part Code
310/400/600ml	AFCC-3

### 310ml/400ml Cartridge & 310ml/400ml/600ml Sachet Gun

One component, air drive, applicators for 400ml cartridges and 400ml sachet tubes. With adjustable regulator for flow rate control. Airflow HP



**Material:** Nylon, Aluminium  
**Pressure:** 100 PSI Max.  
**Thrust:** 1.45kN Medium  
**Cartridge Size:** 310, 400, 600ml  
**Weight:** 1.43kg

Size	Part Code
310ml	AFC310C3
400ml	AFC400C3
600ml	AFC600C3

### 310ml Cartridge Spray Bead Applicator Gun

Gun for bead and spray applications. Change between bead and spray with one easy twist. Built in silencer. For 310ml size cartridges. Jetflow 3 HP.



**Material:** Nylon, Aluminium  
**Pressure:** 100 PSI Max.  
**Thrust:** 1.45kN Medium  
**Cartridge Size:** 310ml  
**Weight:** 1.22kg

Size	Part Code
310ml	JFC310-3

### 310ml/400ml/600ml Sachet Spray Bead Applicator Gun

Gun for bead & spray applications. Change between bead and spray with one easy twist. Built in silencer. For sachets. Jetflow 3.



**Material:** Nylon, Aluminium  
**Pressure:** 100 PSI Max.  
**Thrust:** 1.45kN Medium  
**Cartridge Size:** 310ml, 400ml  
**Weight:** 1.47kg

Size	Part Code
310ml	JFS310-3
400/ 600ml	JFS400-3

### 310ml Cartridge & 310ml/400ml/600ml Sachet Spray Gun

Gun for bead & spray applications. Change between bead and spray with one easy twist. Built in silencer. For cartridges/ sachets. Jetflow 3 Combi.



**Material:** Nylon, Aluminium  
**Pressure:** 100 PSI Max.  
**Thrust:** 1.45kN  
**Cartridge Size:** 310, 400, 600ml  
**Weight:** 1.83kg

Size	Code
310, 400, 600ml	JFC-3

### 800ml Bulk Cartridge Gun

Gun for grouting and pointing of low viscosity materials. Easy change between bead and spray with one easy twist. For masonry repairs or other high volume applications. Ultrapoint Air.



**Material:** Nylon, Steel  
**Pressure:** 100 PSI Max.  
**Thrust:** 1.45kN Low  
**Cartridge Size:** 800ml  
**Weight:** 1.0kg

Size	Part Code
800ml	UP-Air-800

### 2000ml/3000ml/4000ml Bulk Cartridge Guns

Professional pneumatic applicator guns for use with 2000ml, 3000ml and 4000ml bulk materials. With an adjustable air regulator to set flow rate. High output. Airflow 1 Bulk.



**Material:** Nylon, Steel  
**Pressure:** 100 PSI Max.  
**Thrust:** 3.4kN High  
**Cartridge Size:** 1000,3000,4000ml  
**Weight:** 1.6kg

Size	Part Code
2000ml	AF2000B1
3000ml	AF3000B1
4000ml	AF4000B1

### 400ml Cartridge & 600ml Sachet Gun

A lightweight pneumatic applicator gun for use with 400ml and 600ml sachets. Adjustable regulator dial on the handle. With a reinforced nylon handle. For low to medium viscosity materials.



**Material:** Nylon, Steel  
**Pressure:** 100 PSI Max.  
**Thrust:** 1.60kN Medium  
**Cartridge Size:** 400, 600ml  
**Weight:** 0.98kg

Size	Part Code
310/400ml	TS22XP

### 300ml and 600ml Sachet Applicator Gun

Powerful pneumatic sealant gun with adjustable air regulator. For 10oz (300ml) and 20oz (600ml) sausage sachet packs. Air dump valve stops flow immediately. Use with sealants, adhesives, PUs, resins.

**Material:** Steel  
**Pressure:** 100 PSI Max.  
**Thrust:** 1.45kN  
**Cartridge Size:** 10oz, 20oz  
**Weight:** 1.85kg



Size	Part Code
300/600ml	AD710AL-20

### 32oz Pneumatic Cartridge Dispensing Gun

Powerful pneumatic sealant gun with adjustable air regulator. For 1/4 gallon, 32oz cartridges. An air dump valve stops flow immediately. Use with sealants, adhesives, PUs, resins.

**Material:** Steel  
**Pressure:** 100 PSI  
**Thrust:** 1.45kN Medium  
**Cartridge Size:** 32oz  
**Weight:** 2.15kg



Size	Part Code
32oz	AD710AL-30

### 32oz Sachet Sealant Gun

Rod driven gun for 1/4 gallon, 32oz cartridges. Provides more power for higher viscosity materials. Adjustable air regulator sets the flow rate. Reverse button to retract rod.

**Material:** Steel  
**Pressure:** 100 PSI Max.  
**Thrust:** 4.50kN High  
**Cartridge Size:** 32oz  
**Weight:** 2.45kg



Size	Part Code
32oz	AD725AL-30

### 400ml/600ml Sachet Sealant Gun

A steel body pneumatic applicator gun for 400ml and 600ml sachets and bulk. Easy operated lever. For low to medium viscosity materials.

**Material:** Steel, Aluminium  
**Pressure:** 100 PSI Max.  
**Thrust:** 1.60kN Medium  
**Cartridge Sizes:** 400, 600ml  
**Weight:** 1.68kg



Size	Part Code
400/600ml	T20

### 20oz/ 24oz Sachet Sealant Gun

A steel body pneumatic applicator gun for 10oz, 20oz and 24oz sachet bulk materials. Easy operated lever. For low to medium viscosity materials.

**Material:** Steel  
**Pressure:** 100 PSI Max.  
**Thrust:** 1.45kN Medium  
**Cartridge Size:** 10, 20, 24oz  
**Weight:** 2.26kg



Size	Part Code
10, 20, 32oz	AD724

### 32oz Sachet Sealant Gun

A steel body pneumatic applicator gun for 32oz sachet bulk materials. For low to medium viscosity materials.

**Material:** Steel  
**Pressure:** 100 PSI Max.  
**Thrust:** 1.45kN Medium  
**Cartridge Size:** 32oz  
**Weight:** 2.32kg



Size	Part Code
32oz	AD732

### 5oz Pneumatic Tube Dispensing Gun

A pneumatic squeeze tube applicator gun. For squeeze tubes up to 5 ounce in size. Includes airline hose.

**Material:** Nylon  
**Pressure:** 60 PSI Max.  
**Thrust:** 0.75kN Low  
**Cartridge Size:** 5oz  
**Weight:** 0.95kg



Use with squeeze tubes only.

Size	Part Code
5oz	TS910

### Industrial Airline Hose Assemblies for Pneumatic Guns

Industrial airline hoses for use with pneumatic applicator guns. High pressure safe to 100 PSI. Flexible and fully reinforced for safe use in any assembly environment. Contact us with the thread size of the gun being used if support is required.

Type	Part Code
1/4" Thread, 10ft Long to 1/4" Connect	1000-12
1/4" Thread, 30ft Long to 1/4" Connect	AD1000-30
1/4" Thread, 30ft Long Coiled to 1/4" Connect	AD1000-30C
1/4" Thread, 10m Long to 1/4" Connect	AD1000-10M
1/4" Thread, 15m Long to 1/4" Connect	AD1000-15M
1/4" Thread, 60ft Long to 1/4" Connect	AD1000-60
B-Nut Fitting, 5ft Long to FTP Connect	231876
B-Nut Fitting, 10ft Long to FTP Connect	232649
B-Nut Fitting, 5ft Long to Hansen Connect	280000
B-Nut Fitting, 10ft Long to Hansen Connect	280001
B-Nut Fitting, 5ft Long to Schrader Connect	280006
B-Nut Fitting, 10ft Long to Schrader Connect	280007
B-Nut Fitting, 5ft Long to ARO Connect	280012
B-Nut Fitting, 10ft Long to ARO Connect	280013

Use a regulator to set flow run for pneumatic applicator guns that do not feature this level of control. And use an air filter to ensure moisture and particles are kept away from the applicator gun and materials.

Type	Part Code
Air Filter Regulator, 100 PSI, 1/4" Thread	TSD800-6FR
Air Filter Only, 100 PSI, 1/4" Thread	TSD800-6EL



## Single component cartridge gun retainer sleeves

### 100A Series/ AD16 Series Retainers

Retainer sleeves for the 100A series pneumatic and AD16 series manual hand applicator guns. Threaded attachment to gun trigger handle. Anodised steel.

**Material:** Steel (Anodised)  
**Pressure:** 100 PSI Max.  
**Cartridge Size:** 2.5, 6, 8, 10, 12, 20oz  
**Attachment:** Threaded

Size	Part Code
2.5 Ounce	AD25-R
6 Ounce	AD60-R
8 Ounce	AD80-R
10 Ounce	AD100-R
12 Ounce	AD120-R
20 Ounce	AD20-R



For 100A/ AD16 Guns

### TS950 Series/ TS16 Series Retainers

Retainer sleeves for the TS950 series pneumatic and TS16 series manual hand applicator guns. Bayonet attachment to gun trigger handle. Slotted or non-slotted versions. Anodized aluminium.

**Material:** Aluminium  
**Pressure:** 100 PSI Max.  
**Cartridge Size:** 2.5, 6, 8, 12oz  
**Attachment:** Bayonet

Size	Slotted	Non-Slotted
2.5 Ounce	918-030-000	918-044-000
6 Ounce	918-031-000	918-045-000
8 Ounce	918-034-000	918-046-000
12 Ounce	918-032-000	918-047-000



For TS950/ TS16 Guns

### 850 Series Retainers

Retainer sleeves for the 850 series manual hand applicator cartridge guns. Threaded attachment to gun trigger handle. Lightweight steel parts.

**Material:** Steel  
**Pressure:** 100 PSI Max.  
**Cartridge Size:** 2.5, 6, 8, 12oz  
**Attachment:** Threaded

Size	Part Code
2.5 Ounce	226819
6 Ounce	226820
8 Ounce	226821
12 Ounce	226822
20 Ounce	229740
32 Ounce	233620



For 850 Series Guns

### G-Series Series Retainers

Retainer sleeves for G-110 series manual hand applicator cartridge guns. Bayonet attachment to gun trigger handle. Anodised steel parts.

**Material:** Steel (Anodised)  
**Pressure:** 65 PSI Max.  
**Cartridge Size:** 2.5, 6, 12oz  
**Attachment:** Bayonet

Size	Part Code
2.5 Ounce	101-25R
6 Ounce	101-60R
12 Ounce	101-120R



For G110 Series Guns

### TS2560 Series Retainers

Lightweight plastic adjustable retainer sleeve for use with the TS2560 series pneumatic guns. And the threaded plastic gun adapter that accepts the retainer sleeve.

**Material:** Nylon  
**Pressure:** 100 PSI Max.  
**Cartridge Size:** 2.5, 6, 8, 10, 12oz  
**Attachment:** Threaded/ Bayonet

Type	Part Code
Retainer	TS2560-2040
Adapter	TS2560-2041



For TS2560 Guns

### 250A/ 250B Series/ 350 Series Retainers

Retainer sleeves for the 250A and 250B series pneumatic cartridge guns. Bayonet attachment to gun trigger handle. Zinc plated parts.

**Material:** Steel  
**Pressure:** 100 PSI Max.  
**Cartridge Size:** 2.5, 6, 8, 12oz  
**Attachment:** Bayonet

Size	Part Code
2.5 Ounce	220256
6 Ounce	220928
8 Ounce	220956
12 Ounce	220923



For 250A/ 250B/ 350 Guns

### 550 Series Retainers

Retainer sleeves for the 550 series pneumatic cartridge guns. Threaded attachment to gun trigger handle. Anodized steel parts.

**Material:** Steel  
**Pressure:** 100 PSI Max.  
**Cartridge Size:** 10oz, 20oz, 32oz  
**Attachment:** Threaded

Size	Part Code
10 Ounce	231903
20 Ounce	229752
32 Ounce	233695



For 550 Series Guns

### 100A Series 20 Ounce Retainer Adapter Kit

Retainer sleeve and adapter fitting part for the 100A series pneumatic cartridge guns. Threaded attachment to gun trigger handle and bayonet fitting to retainer. Anodized steel parts. Converts 100A gun to 20oz size.

**Material:** Steel  
**Pressure:** 100 PSI Max.  
**Cartridge Size:** 20oz  
**Attachment:** Threaded/ Bayonet

Type	Part Code
Retainer	AD101-20R
Adapter	AD101-20A

For 100A Series Guns





## Single component battery cartridge dispensing

### 310ml / 400ml Cartridge Sealant Gun

Medium duty lightweight battery operated applicators for 310ml/400ml cartridges. Variable speed for flow rate. Open frame easy load. 30 min. charge time. 8mm/s max. speed. With 10.8v Li-Ion battery, charger, user guide. For low to medium viscosity materials. Easipower gun.

**Material:** Nylon, Steel  
**Power:** 10.8v  
**Thrust:** 2.0kN  
**Cartridge Size:** 310, 400ml  
**Weight:** 1.63kg



For 310ml/ 400ml cartridges

Size	Part Code
310ml	EP310Plus
400ml	EP400Plus

### 310ml/400ml Cartridge & 400ml/600ml Sachet Gun

Medium duty battery gun for 310ml/400ml cartridges/sachets, 600ml sachets. Variable speed for full rate. Closed retainer sleeve. 25 min. charge time. 10mm/sec. max. speed. With 10.8v Li-Ion battery, charger, user guide. For low to medium viscosity materials. MK gun.

**Material:** Nylon, Steel  
**Power:** 10.8v  
**Thrust:** 2.50kN  
**Sizes:** 310, 400, 600ml  
**Weight:** 2.50kg



For 310ml/ 400ml cartridges & 400ml/ 600ml sachets

Size	Part Code
310/ 400/ 600ml	AD612Z

### 310ml/400ml Cartridge & 400ml/600ml Sachet Gun

Medium duty battery gun for 310ml/400ml cartridges/sachets, 600ml sachets. Variable speed control for flow rate. Closed retainer sleeve. 30 min. charge time. 8mm/sec. max. speed. With 10.8v Li-Ion battery, charger, user guide. For low to medium viscosity. Easipower + gun.

**Material:** Nylon, Steel  
**Power:** 10.8v  
**Thrust:** 2.50kN  
**Sizes:** 310, 400, 600ml  
**Weight:** 1.65kg



For 310ml/ 400ml cartridges & 400ml/ 600ml sachets

Size	Part Code
310ml	EPP-310
310/ 400ml	EPP-400
310/ 400/ 600ml	EPP-600

### Techcon and Semco Cartridge Gun

Medium duty battery gun for Techcon/Semco cartridges, Techkits, Semkits. Variable speed for flow. 25 min. charge. 10mm/s max. speed. With 10.8v Li-Ion battery, charger, user guide. For low to medium materials.

**Material:** Nylon, Steel  
**Power:** 10.8v  
**Thrust:** 2.5kN  
**Cartridge Size:** 2.5, 6, 8, 10, 12, 20oz  
**Weight:** 2.5kg



Use with Techcon, Semco cartridges, Techkits, Semkits

Size	Part Code
2.5oz	AD600-25
6oz	AD600-60
8oz	AD600-80
10oz	AD600-110
12oz	AD600-120
20oz	AD600-20

### 310ml/400ml Cartridge & 400ml/600ml Sachet Gun

Heavy duty battery gun for 310ml/ 400ml cartridges. Variable speed for flow. Open frame easy load. 30 min. charge time. 8mm/s max. speed. With 18v Li-Ion battery, charger, user guide. For medium to high viscosity. Electraflow + gun.

**Material:** Nylon, Steel  
**Power:** 18v  
**Thrust:** 3.5kN  
**Cartridge Size:** 310, 400ml  
**Weight:** 2.35kg



For 310ml/ 400ml cartridges

Size	Part Code
310ml	EF310Plus
400ml	EF400Plus

### Techcon and Semco Cartridge Gun

Medium duty battery gun for 20oz Techcon/Semco cartridges, Techkits and Semkits. Variable speed for flow. 30 min. charge. 8mm/s max. speed. With 10.8v Li-Ion battery, charger, user guide. For low to medium viscosity materials.

**Material:** Nylon, Steel  
**Power:** 10.8v  
**Thrust:** 2.5kN  
**Cartridge Size:** 20oz  
**Weight:** 1.9kg



Use with Techcon, Semco cartridges, Techkits, Semkits

Size	Part Code
20oz	ADV-20B

### 310ml/400ml Cartridge & 400ml/600ml Sachet Gun

Heavy duty battery gun for 400ml cartridges/sachets, 600ml sachets. Variable speed for flow rate. Closed retainer sleeve. 30 min. charge time. 8mm/s max. speed. With 18v Li-Ion battery, charger, user guide. For medium to high viscosities. Electraflow + Combi gun.

**Material:** Nylon, Steel  
**Power:** 18v  
**Thrust:** 3.50kN  
**Sizes:** 310, 400, 600ml  
**Weight:** 2.25kg



For 310ml/ 400ml cartridges & 400ml/ 600ml sachets

Size	Part Code
310ml	EFC-310
310/ 400ml	EFC-400
310/ 400/ 600ml	EFC-600

### Techcon and Semco Cartridge Gun

Heavy duty battery gun for 20oz Techcon/Semco cartridges, Techkits and Semkits. Variable speed for flow. 30 min. charge. 8mm/s max. speed. With 18v Li-Ion battery, charger, user guide. Medium to high viscosity materials.

**Material:** Nylon, Steel  
**Power:** 18v  
**Thrust:** 3.5kN  
**Cartridge Size:** 20oz  
**Weight:** 2.4kg



Use with Techcon, Semco cartridges, Techkits, Semkits

Size	Part Code
20oz	ADV-20BH

Batteries	Part Code
For AD Guns 10.8v 1.5 Amp	KR600B
For ADV-20B Gun 18.8v 1.5 Amp	B600S
For ADV-20BH Gun 18v 1.5 Amp	AD7E1601
For ADV-20BH Gun 18v 3 Amp	AD7E1603



## Single component cartridge complete retainers feed systems



### AD Series Cartridge Retainer Assemblies

Pressure feed systems for liquids, gels and pastes from industry standard cartridges. Dispense direct using nozzles or as a fluid feed to metering valves. Includes metal body sleeve, air cap and airline hose with quick connect fitting. Regulators available to control air pressure into cap.

Part Code	Size	Material
AD-6OZ	6oz (177ml)	Steel
AD-8OZ	8oz (237ml)	Steel
AD-10OZ	10oz (310ml)	Steel
ADL-1211M	10oz (310ml)	Steel
AD-12OZ	12oz (355ml)	Steel



### TS918 Series Cartridge Retainer Assemblies

Retainer system include lightweight aluminium body with nylon air cap. Bayonet attachment. Either slotted retainers showing plunger level or solid non-slotted type.

Part Code	Size	Type
TS918-25CS	2.5oz (75ml)	Slotted
TS918-25NS	2.5oz (75ml)	Non-Slotted
TS918-60CS	6oz (177ml)	Slotted
TS918-60NS	6oz (177ml)	Non-Slotted
TS918-80CS	8oz (237ml)	Slotted
TS918-80NS	8oz (237ml)	Non-Slotted
TS918-120CS	12oz (355ml)	Slotted
TS918-120NS	12oz (355ml)	Non-Slotted



### Nylon Cartridge Retainer Assemblies

Lightweight nylon retainer sleeves and air caps and accessories.



Part Code	Size	Type
5801379-KIT	2.5oz (75ml)	Cartridge Retainer Assembly & Hose
5801380-KIT	6oz (177ml)	Cartridge Retainer Assembly & Hose
5801381-KIT	8oz (237ml)	Cartridge Retainer Assembly & Hose
5801382-KIT	12oz (355ml)	Cartridge Retainer Assembly & Hose
5801376	2.5,6,8,12oz	Air Cap
5801376-SEAL	2.5,6,8,12oz	Cap Rubber Gasket
5801379	2.5oz (75ml)	Retainer Body Sleeve
5801380	6oz (177ml)	Retainer Body Sleeve
5801381	8oz (237ml)	Retainer Body Sleeve
5801382	12oz (355ml)	Retainer Body Sleeve
5601357	All Sizes	Airline Hose 5 ft.

### Aluminium Cartridge Retainer Assemblies

High quality aluminium retainer sleeves and air caps and accessories.

Part Code	Size	Type
CR300	10oz (310ml)	Cartridge Retainer Assembly & Hose
CR300-SEAL	10oz (310ml)	Air Cap
560549U	10oz (310ml)	Cartridge Retainer Bench Stand
562146	10oz (310ml)	Airline Hose 6 ft.



### Production Master Retainer Assemblies

Order retainer parts and accessories individually. These are the 918 type



Part Code	Size	Type
918-030-000	2.5oz (75ml)	Retainer Body Sleeve
918-031-000	6oz (177ml)	Retainer Body Sleeve
918-034-000	8oz (237ml)	Retainer Body Sleeve
918-032-000	12oz (355ml)	Retainer Body Sleeve
110-2	10oz (310ml)	Retainer Body Sleeve
101-20R	20oz (600ml)	Retainer Body Sleeve
918-001-004	2.5,6,8,12oz	Air Cap
5601377	2.5,6,8,12oz	Air Cap With Regulator
918-030-036	10, 20oz	Air Cap
101-20A	20oz	Retainer to Air Cap Adapter
918-000-002	All Sizes	Airline Hose 5 ft.
534	All Sizes	Air Cap Hose Connector
533	All Sizes	Air Cap Hose Connector
918-001-007	2.5,6,8,12oz	Cap Rubber Gasket
101-20G	20oz	Cap Rubber Gasket

### Nylon Production Master Retainer Assemblies



Part Code	Size	Type
5801379	2.5oz (75ml)	Retainer Body Sleeve
5801380	6oz (177ml)	Retainer Body Sleeve
5801381	8oz (237ml)	Retainer Body Sleeve
5801382	12oz (355ml)	Retainer Body Sleeve
5801376	2.5,6,8,12oz	Air Cap
5801377	2.5,6,8,12oz	Air Cap With Regulator
918-000-002	All Sizes	Airline Hose 5 ft.
534	All Sizes	Air Cap Hose Connector
533	All Sizes	Air Cap Hose Connector
1801376-SEAL	2.5,6,8,12oz	Cap Rubber Gasket

### Cartridge Reservoirs

Disposable cartridges are available in sizes 2.5, 6, 8, 10, 12, 20, 32 oz. (approximate metric value 75, 177, 237, 310 355, 591, 960cc). In high-density natural polyethylene (HDPE) which is more rigid plastic and low density polyethylene (LDPE) which is a softer grade. All sizes are fitted with a 1/4" NPT (6mm) female thread. Use with guns/ retainers.



Size	Natural	Black	Green	Material
2.5oz	TS25C	n/a	TS25C-GREEN	HDPE
2.5oz	TS25C-LD	TS25C-LD-BL	n/a	LDPE
6oz	TS60C	TS60C-BLACK	TS60C-GREEN	HDPE
6oz	TS60C-LD	n/a	n/a	LDPE
8oz	TS80C	TS80C-BLACK	n/a	HDPE
8oz	TS80C-LD	n/a	n/a	LDPE
10oz	TS110C	TS110C-BLACK	n/a	HDPE
10oz	TS110C-LD	n/a	n/a	LDPE
12oz	TS120C	TS120C-BLACK	TS120C-GREEN	HDPE
12oz	TS120C-LD	n/a	n/a	LDPE
20oz	TS20C	TS20C-BLACK	n/a	HDPE
32oz	TS32C	n/a	n/a	HDPE

### Cartridge Wiper Plungers

Cartridge plungers ensure that the pressure is evenly spread across the fluid surface to provide consistent dispensing. Wiping edges prevent dripping and eliminate material waste by wiping the cartridge walls clean, as fluid is dispensed. The plunger is inserted into the cartridge once filled (or pre-inserted when bottom filling) and it moves down the inner walls under pressure.



Part	Colour	For Cartridge	Material
TS1P-SR	Blue	2.5, 6, 8, 12oz	LDPE
TS1PB-SR	Black	2.5, 6, 8, 12oz	LDPE
TS1WP	Natural	2.5, 6, 8, 12oz	LDPE
TS1WP-BL	Black	2.5, 6, 8, 12oz	LDPE
TS3WP-MD	Natural	2.5, 6, 8, 12oz	MDPE
TS2PW	White	10oz (310ml)	LDPE
TS2P-BLACK	Black	10oz (310ml)	LDPE
TS20P	White	20/32oz	MDPE
TS20P-LD	Natural	20/32oz	LDPE

### Cartridge Cap Seals

Cartridge tips cap seals feature a 1/4" NPT thread for secure leak free attachment. End flange caps push onto the top of the cartridge.

Part	Colour	For Cartridge
TS3P	Red	Tip Cap All Sizes
TS6P	Red	Tip Cap All Sizes
AD6P-RED	Red	Tip Cap All Sizes
AD6P-BLUE	Blue	Tip Cap All Sizes
TS6P-BLACK	Black	Tip Cap All Sizes
TS2C	Red	End Cap 2.5, 6, 8, 12oz
TS4C	Red	End Cap 10oz (310ml)
TS6C	Red	End Cap 20/32oz



### Cartridge Plunger Kits

Cartridge reservoirs and plungers supplied as kits. The same number of cartridges with plungers. Supplied as separate parts or with plungers pre-inserted ready for filling. Separate parts or \* pre-plunged.



Size	Part Code	Cartridge	Plunger	Colours
2.5oz	TS25CKIT	TS25C	TS1WP	Natural/ Natural
2.5oz	TS25CKITL	TS25C-LD	TS1WP	Natural/ Natural
2.5oz	TS25CP	TS25C	TS1P	Natural/ Blue
2.5oz	TS25CPB	TS25C	TS1PB	Natural/ Black
2.5oz	TS25CPB-LD *	TS25C-LD	TS1PB	Natural/ Black
2.5oz	TS25CP-LD	TS25C-LD	TS1PB	Natural/ Black
2.5oz	TS25CP-LD-BL *	TS25C-LD	TS1P	Natural/ Blue
2.5oz	TS25C-LD-GR	TS25C-GR	TS1PB	Green/ Black
2.5oz	TS25CWP	TS25C	TS1WP	Natural/ Natural
2.5oz	TS25CWP-LD	TS25C-LD	TS1WP	Natural/ Natural
2.5oz	TS25CWP-LDBL *	TS25C-BLD	TS1WP	Black/ Natural
6oz	TS60CKIT	TS60C	TS1WP	Natural/ Natural
6oz	TS60CKITL	TS60C-LD	TS1WP	Natural/ Natural
6oz	TS60CP	TS60C	TS1P	Natural/ Blue
6oz	TS60CPB	TS60C	TS1PB	Natural/ Black
6oz	TS60CPB-LD *	TS60C-LD	TS1PB	Natural/ Black
6oz	TS60CP-LD	TS60C-LD	TS1P	Natural/ Blue
6oz	TS60C-RIB-LD *	TS60C-LD	TS1WPR	Natural/ Natural
6oz	TS60CWP	TS60C	TS1WP	Natural/ Natural
6oz	TS60CWP-LD	TS60C-LD	TS1WP	Natural/ Natural
8oz	TS80CKIT	TS80C	TS1WP	Natural/ Natural
8oz	TS80CKITL	TS80C-LD	TS1WP	Natural/ Natural
8oz	TS80CP *	TS80C	TS1P	Natural/ Blue
8oz	TS80CWP	TS80C	TS1WP	Natural/ Natural
10oz	TS110CKIT	TS110C	TS2PW	Natural/ White
10oz	TS110CKITB	TS110C-BL	TS2P-BL	Black/ Black
10oz	TS110CP *	TS110C	TS2PW	Natural/ White
10oz	TS110CPW	TS110C	TS2PW	Natural/ Natural
12oz	TS120CKIT	TS120C	TS1WP	Natural/ Natural
12oz	TS120CKITL	TS120C-LD	TS1WP	Natural/ Natural
12oz	TS120CP	TS120C	TS1P	Natural/ Blue
12oz	TS120CPB	TS120C	TS1PB	Natural/ Black
12oz	TS120CPB-LD *	TS120C-LD	TS1PB	Natural/ Black
12oz	TS120CWP *	TS120C	TS1WP	Natural/ Natural
20oz	TS20CKIT	TS20C	TS20PLD	Natural/ White
20oz	TS20CKIT-BL	TS20C-BL	TS2P	Black/ White
20oz	TS20CKIT-BL-LD	TS20C-BL	TS20PLD	Black/ Natural
20oz	TS20CP *	TS20C	TS20P	Natural/ White
32oz	TS32CKIT	TS32C	TS20PLD	Natural/ White
32oz	TS32CP *	TS32C	TS20PLD	Natural/ White



## Single component cartridge nozzles



### AD Series Cartridge Retainer Assemblies

Nozzles for dispensing from cartridges and dispense valves. Products are silicone free and safe for use to 100 psi with a 1/4" NPT thread. Natural polyethylene materials. Ribbon nozzles spread the material as it is dispensed to varying widths. Fillet lap nozzles apply to edges and seams. Roller nozzles spread flat.



Part	Design	Orifice	Length	Type
TS216	Straight	1.6mm/ 0.063"	63.5mm/ 2.5"	MDPE
TS218	Straight	3.18mm/ 0.125"	63.5mm/ 2.5"	MDPE
TS218-LD	Straight	3.18mm/ 0.125"	63.5mm/ 2.5"	LDPE
TS416	Straight	1.6mm/ 0.063"	101.6mm/ 4"	MDPE
TS416-LD	Straight	1.6mm/ 0.063"	101.6mm/ 4"	LDPE
TS416-B30/1	Bent	1.6mm/ 0.063"	101.6mm/ 4"	HDPE
TS418	Straight	3.18mm/ 0.125"	101.6mm/ 4"	MDPE
TS432	Straight	0.79mm/ 0.031"	101.6mm/ 4"	MDPE
TS432-LD	Straight	0.79mm/ 0.031"	101.6mm/ 4"	LDPE
TS490	Straight	2.39mm/ 0.094"	101.6mm/ 4"	LDPE
TS616	Straight	1.6mm/ 0.063"	152.4mm/ 6"	MDPE
TS618	Straight	3.18mm/ 0.125"	152.4mm/ 6"	MDPE
TS1050	Ribbon	12.7 x 1.52mm	101.6mm/ 4"	MDPE
TS1050-45	Ribbon	12.7 x 1.52mm	101.6mm/ 4"	MDPE
TS1075	Ribbon	19.05 x 3.30mm	101.6mm/ 4"	MDPE
TS1100	Ribbon	25.4 x 3.30mm	101.6mm/ 4"	MDPE
TS1175	Ribbon	44.45 x 3.30mm	101.6mm/ 4"	MDPE
TS3106	Fillet R	8.89 x 2.79mm	101.6mm/ 4"	MDPE
TS3206	Fillet L	8.89 x 2.79mm	101.6mm/ 4"	MDPE
232693	Roller	25.0mm Wide	101.6mm/ 4"	Nylon
232692	Roller	50.0mm Wide	101.6mm/ 4"	Nylon

### Cartridge Tip Adapter Fittings

Adapters are used with cartridges and all feature a 1/4" NPT thread for leak free attachment. Syringe filler adapters thread to the cartridge and allow a syringe barrel attachment. Tip adapters thread to the cartridge to allow use of luer lock tips.



Part Code	Material	Colour	Type
TSD931-15	Celcon	Black	Syringe filling adapter
AD931-15M	Brass	Silver	Syringe filling adapter
TSD931-7	Polypropylene	White	Tip adapter fitting
AD931-7M	Brass	Silver	Tip adapter fitting
AD931-7SS	Stainless Steel	Silver	Tip adapter fitting
TSD931-14	Polypropylene	Black	Tip adapter fitting
TSD931-7C	Polypropylene	Clear	Tip adapter fitting
TSD918-3	Polypropylene	Clear	Elbow transfer fitting

### Metal Cartridge Nozzles

Cartridge and valve nozzles attach with a 1/4 Inch NPT thread for leak free dispensing under high fluid pressures. Metal nozzles offer precision application of fluids and pastes. Range of tube diameters and lengths. Maximum fluid pressure 100 psi.



Part	Gauge	ID/ OD	Length
AD7SS-1/2	7	3.81mm/ 4.45mm	0.5" - 12.70mm
AD7SS-1	7	3.81mm/ 4.45mm	1.0" - 25.40mm
AD7SS-1.5	7	3.81mm/ 4.45mm	1.5" - 38.10mm
AD7SS-2	7	3.81mm/ 4.45mm	2.0" - 50.80mm
AD8SS-1/2	8	3.28mm/ 4.04mm	0.5" - 12.70mm
AD8SS-1	8	3.28mm/ 4.04mm	1.0" - 25.40mm
AD8SS-1.5	8	3.28mm/ 4.04mm	1.5" - 38.10mm
AD8SS-2	8	3.28mm/ 4.04mm	2.0" - 50.80mm
AD10SS-1/2	10	2.69mm/ 3.40mm	0.5" - 12.70mm
AD10SS-1	10	2.69mm/ 3.40mm	1.0" - 25.40mm
AD10SS-1.5	10	2.69mm/ 3.40mm	1.5" - 38.10mm
AD10SS-2	10	2.69mm/ 3.40mm	2.0" - 50.80mm
AD12SS-1/2	12	2.18mm/ 2.77mm	0.5" - 12.70mm
AD12SS-1	12	2.18mm/ 2.77mm	1.0" - 25.40mm
AD12SS-1.5	12	2.18mm/ 2.77mm	1.5" - 38.10mm
AD12SS-2	12	2.18mm/ 2.77mm	2.0" - 50.80mm
AD14SS-1/2	14	1.64mm/ 2.10mm	0.5" - 12.70mm
AD14SS-1	14	1.64mm/ 2.10mm	1.0" - 25.40mm
AD14SS-1.4	14	1.64mm/ 2.10mm	1.5" - 38.10mm
AD14SS-2	14	1.64mm/ 2.10mm	2.0" - 50.80mm
AD16SS-1/2	16	1.20mm/ 1.65mm	0.5" - 12.70mm
AD16SS-1	16	1.20mm/ 1.65mm	1.0" - 25.40mm
AD16SS-1.5	16	1.20mm/ 1.65mm	1.5" - 38.10mm
AD16SS-2	16	1.20mm/ 1.65mm	2.0" - 50.80mm

### Sealant Tube Adapter Fittings

These adapters convert 310ml caulking tube, sealant cartridges to accept nozzles and fittings. They thread over the cartridge end to provide a 1/4" attachment.



Part Code	Material	Type
TSD931-296	Acetal	310ml tube adapter straight
TSD931-296SS	Stainless Steel	310ml tube adapter straight
229306	Acetal	310ml tube adapter round

**Cartridge to Syringe Filling Stations**

Pneumatic systems for efficient transfer of materials from cartridge reservoirs to syringe barrels. The filling process is to the bottom end of the barrel which reduces air entrapment and eliminates mess. This range includes an adjustable stand to hold the cartridges which is placed on the workbench. Systems include the cartridge retainer, air cap, airline hose, cartridge, plunger, filling adapter and syringe kit.



Part Code	Size	Type
TS918-25	2.5oz	Retainer, stand, switch
TS918-60	6oz	Retainer, stand, switch
TS918-80	8oz	Retainer, stand, switch
560548-M	10oz	Retainer, stand, switch
TS918-120	12oz	Retainer, stand, switch
TS918-20	20oz	Retainer, stand, switch
TS918-32	32oz	Retainer, stand, switch

**Timed Cartridge to Syringe Filling Stations**

Automatic systems for efficient transfer of materials from cartridge reservoirs to syringe barrels. The filling process is to the bottom end of the barrel which reduces air entrapment and eliminates mess. This range includes an adjustable stand to hold the cartridges which is placed on the workbench with a digital timed dispenser so that each deposit set can be the same. Ideal for repeat shot syringe filling.

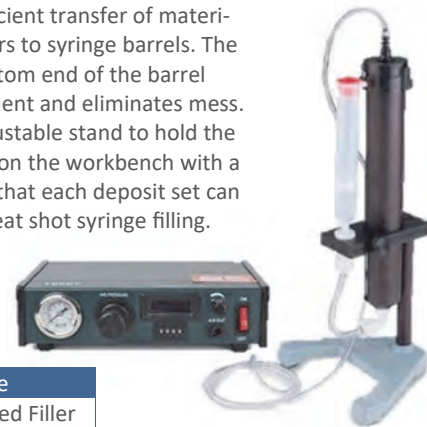

Part Code	Size	Type
1000-25D	2.5oz	Timed Filler
1000-6D	6oz	Timed Filler
1000-8D	8oz	Timed Filler
1000-10D	10oz	Timed Filler
1000-12D	12oz	Timed Filler
1000-20D	20oz	Timed Filler

**Pail Pump Filling Stations**

Manual pail pump to extract material from large pails. Suitable only for 5-gallon straight walled pails containing fluids such as grease, paste, silicone and other such materials. The hand lever pumps the fluid to bottom fill 2.5oz, 6oz, 8oz, 12oz, 20oz and 32oz size cartridges & syringe barrels in sizes 3cc to 55cc. An internal follower plate ensures that material is used.



Part Code	Size	Type
560092B	5 Gallon	Manual Pump
AD5-20LF	5 Gallon	Manual Pump

**Pneumatic Pump Filling Stations**

Pneumatic, ram driven pump with controller unit and valve for the transfer or pastes from large pails to cartridges and syringe barrels. Two sizes are available. Use with straight walled pails. The follower plate forces out the material without excessive waste. Converts to a high pressure for fast flow of high viscosity pastes, gels, sealants, silicones, grease.



Part Code	Size	Type
TS1400-22	5 Gallon	Pump, 22:1 Ratio
TS1400-43	5 Gallon	Pump, 43:1 Ratio
TS1400-46	5 Gallon	Pump, 46:1 Ratio
TS1400-55L	55 Gallon	Pump, 23:1 Ratio
TS1400-55H	55 Gallon	Pump, 46:1 Ratio

**Pressure Pot Filling Stations**

For low to medium viscosity liquids that require filling to bottles and open containers, pressure pot valve dispensing stations allow a repeat and consistent fill process. The tank is pressurised and a valve controller is set to deliver the exact required amount. Supplied as a complete system to include tank, air operated dispensing valve, valve bench stand and digital timed controller. All fittings, feed tubing and nozzles are included.



Part Code	Size	Type
1212-1215	0.5 Litre	0-75 PSI
1212-1251	1.0 Litre	0-75 PSI
1212-2220	2.0 Litre	0-75 PSI
1212-2230	3.0 Litre	0-75 PSI
1212-2250	5.0 Litre	0-75 PSI
1212-1262	7.6 Litre	0-100 PSI
1212-2210	10.0 Litre	0-75 PSI
1212-1263	11.5 Litre	0-100 PSI
1212-2216	16.0 Litre	0-75 PSI
1212-1265	19.0 Litre	0-100 PSI
1212-1230	30.0 Litre	0-100 PSI

**Pneumatic Pump Stations**

Pneumatic pail pump designed for extracting material from large 20 litre pails. Suitable only for 5-gallon straight walled pails containing fluids such as greases, pastes, silicone and other such materials. The follower plate pumps the fluid to bottom fill 2.5oz, 6oz, 8oz, 12oz, 20oz and 32oz size cartridges & syringe barrels in sizes 3cc to 500cc. An internal follower plate ensures that most material is used. Supplied with air operated valve and digital timed shot controller.



**Motor power: 400W**  
**Rotor displacement: 1.5, 3, 6cc**  
**Repeated precision: ± 2%**  
**Rated voltage: AC 220V**  
**Rated frequency: 50Hz**  
**Rated power: 500W**  
**Rated pressure: 0.6MPA**

Part Code	Size	Type
ADOMP-20	5 Gallon	Pump

## Techkit Cartridge Mix and Dispensing System

The Techkit is a compact and simple method of packaging two or three component resin systems into a 2 1/2, 6, 8, 12, 20 ounce or 1/10 gallon cartridge. The kit mechanically separates the base and hardener until they are ready to be used. An internal mixing head provides a thorough blend for all types of compounds. When the mixing is finished, the cartridge is placed into one of our applicator guns.

When the job has been completed, the package is disposed of: no clean up or physical contact with the resin. Cost savings are achieved by reducing labour and material waste. Reliability is increased with accurate compound ratios, complete mixing and proper application techniques. Three types of kits are available: Barrier, Injection and Barrier/Injection types.

### Barrier Type

For compounds with a volumetric ratio greater than 10 parts per 100. The catalyst and base are separated by an aluminium barrier formed over the mixing head.

### Injection Type

For compounds with a volumetric ratio of 10 parts or less per 100. The catalyst is contained inside the valved mixing rod while the base is in the cartridge.

### Barrier / Injection Type

For three component compounds, components of both Injection and Barrier are combined.



### Complete Techkits

Part	Size	Type	Cartridge	Plunger	Cap	Mix Head	Rod	Ram Rod
110-80	1/10 Gallon	Injection	TS110C	TS2P	TS4C	110-340	810-100A	600-080
110-81	1/10 Gallon	Barrier	TS110C	TS2P	TS4C	110-350	800-100	
110-81T	1/10 Gallon	Taped Barrier	TS110C	TS2P	TS4C	110-350	800-100	
250-60	2.5 Ounce	Injection	TS25C	TS1WP	TS2C	600-200	610-100A	600-080
250-61	2.5 Ounce	Barrier	TS25C	TS1WP	TS2C	600-310	600-100	
250-61T	2.5 Ounce	Taped Barrier	TS25C	TS1WP	TS2C	600-310	610-100	
250-80	2.5 Ounce	Injection	TS25C	TS1WP	TS2C	600-200	810-100A	600-080
250-81	2.5 Ounce	Barrier	TS25C	TS1WP	TS2C	600-310	800-100	
250-81T	2.5 Ounce	Taped Barrier	TS25C	TS1WP	TS2C	600-310	800-100	
600-60	6 Ounce	Injection	TS60C	TS1WP	TS2C	600-200	610-100A	600-080
600-61	6 Ounce	Barrier	TS60C	TS1WP	TS2C	600-310	600-100	
600-61-330	6 Ounce	Barrier	TS60C	TS1WP	TS2C	600-330	600-100	
600-61T	6 Ounce	Taped Barrier	TS60C	TS1WP	TS2C	600-310	600-100	
600-80	6 Ounce	Injection	TS60C	TS1WP	TS2C	600-200	810-100A	600-080
600-81	6 Ounce	Barrier	TS60C	TS1WP	TS2C	600-310	600-100	
600-81T	6 Ounce	Taped Barrier	TS60C	TS1WP	TS2C	600-310	600-100	
800-80	8 Ounce	Injection	TS80C	TS1WP	TS2C	600-200	810-100A	600-080
800-81	8 Ounce	Barrier	TS80C	TS1WP	TS2C	600-310	800-100	
800-81-330	8 Ounce	Barrier	TS80C	TS1WP	TS2C	600-330	800-100	
800-81T	8 Ounce	Taped Barrier	TS80C	TS1WP	TS2C	600-310	800-100	
200-80	20 Ounce	Injection	TS20C	TS20P	TS6C	600-360	810-100A	600-080
200-81	20 Ounce	Barrier	TS20C	TS20P	TS6C	600-370	800-100	
200-81T	20 Ounce	Taped Barrier	TS20C	TS20P	TS6C	600-370	800-100	

### Techkit Components - Mix Heads

Part Code	Description
110-340	1/10 Gallon Mix Head
110-350	1/10 Gallon Foiled Mix Head
600-200	Open Mix Head
600-300	Wheel Mix Head
600-310	Foiled Wheel Mix Head
600-320	Half Closed Circle Mix Head
600-330	Foiled Half Closed Circle Mix Head
600-360	20 Ounce Wheel Mix Head
600-370	20 Ounce Foiled Wheel Mix Head



### Techkit Components - Rods

Item	Part Code	Description
1	600-080	8" (203.2mm) Ram Rod
2	600-100	6" (152.4mm) Plugged Rod
3	610-100A	6" (152.4mm) Valved Rod with Piston
4	800-100	8" (203.2mm) Plugged Rod
5	810-100A	8" (203.2mm) Valve Rod with Piston





**Model TS6500 Automatic Techkit and Semkit Cartridge Mixer**

The TS6500 Series cartridge mixer provides full automatic mixing of two-component materials filled in a Techkit or Semkit cartridge kit. The feature rich TS6500 Series accommodates all standard size cartridge kits ranging from 2.5 oz (74ml) to 20 oz. (591ml) and is usable anywhere in the world with its accompanying tools, accessories and universal power supply.

**Key Features:**

- Universal power supply for worldwide use
- Automatic fluid level sensing device for all kit sizes– No need to set stroke length
- Automatically injects hardener into resin to provide uniform mixed material
- Robust, high torque motor to handle high viscosity material
- Safety features include safety enclosure, emergency stop button and two-hand start
- User programmable manual and automatic mixing cycle settings
- 10 programmable memories for storing and recalling most frequently used mix cycle
- Quick and easy to replace cartridge holder and plunger - No tool needed
- User friendly firmware for easy setup
- Robust and sturdy platform for heavy industrial used
- RoHS, WEEE compliance

Part Code	Description
TS6500CIM-6	Mixer for 2.5, 6, 8oz
TS6500CIM-RS-6	Mixer for 2.5, 6, 8oz Reduced Speed
TS6500CIM-SMR-6	Mixer for 2.5, 6, 8oz Steel Mix Rod
TS6500CIM-20	Mixer for 20oz
TS6500CIM-SMR-20	Mixer for 20oz Steel Mix Rod
CK6500-6	Conversion Kit for 2.5, 6, 8oz
CK6500-10	Conversion Kit for 10oz
CK6500-20	Conversion Kit for 20oz

**Specifications:**

<b>Size:</b>	398mm W x 538mm D x 1032mm H
<b>Weight:</b>	36kg
<b>Internal Voltage:</b>	120-230VAC, 50-60 Hz, 2 Amp
<b>Motor Speed:</b>	139 RPM
<b>Air Inlet:</b>	80 psi (5.5 Bar) Min.
<b>Stroke Speed:</b>	33 Strokes/minute (fully extended)
<b>Meets or exceeds:</b>	CE, cTUV-us
<b>Warranty:</b>	1 year

**Model 1088 Automatic Techkit and Semkit Cartridge Mixer**

The Model 1088 mixer provides complete automatic mixing of filled packages. Use of the mixer will minimise operator set up of the machine for different kit configurations, reduce worker fatigue, and assures the user a more thorough and consistent mix, kit to kit.

**Key Features:**

- Single switch adjustment to mix packages including:
  - 2.5oz with 6" dasher rod
  - 2.5oz with 8" dasher rod
  - 6oz with 6" dasher rod
  - 6oz with 8" dasher rod
  - 8oz with 8" dasher rod
- Automatic injection of catalyst (injection style kits)
- Guarding door to ensure operator safety during mixing
- Stroke counter for improved consistency and quality
- Fully pneumatic non-electrical operation
- Heavy duty motor to manage high viscosity chemicals

**Specifications:**

<b>Size:</b>	300mm W x 380mm x 1032mm H
<b>Weight:</b>	35kg
<b>Motor Speed:</b>	150 RPM
<b>Height Min/ Max:</b>	775 / 975mm
<b>Air Inlet:</b>	85 psi (5.9 Bar) to 95 psi (6.6 Bar)
<b>Air Rate Required:</b>	Min. 3.5 CFM
<b>Max. Working Stroke:</b>	250mm
<b>Max. Torque at Driver:</b>	29 Nm
<b>Meets or exceeds:</b>	CE
<b>Warranty:</b>	1 year



Part Code	Description
235154	Mixer for 2.5, 6, 8oz Standard
235197	Mixer for 20oz Standard
235181	Mixer for 2.5, 6, 8oz High Power
235190	Mixer for 20oz High Power

**Model 285 Techkit/ Semkit Cartridge Mixer**

The Model 285 Semkit uses a drive spindle that rotates the mixing rod while the operator strokes the cartridge vertically, permitting the rotating dasher to mix the materials. The bell timer alerts the operator when the mix cycle is completed. The mixer weighs less than 4.6kg and is easily portable.

**Key Features:**

- Semi-Automatic mix of Semkit/Techkits
- Easy to operate
- Provides consistent, uniform mixing
- Reduces time and effort for thorough mixing
- Bell timer signals completion of mix
- Totally portable

Part Code	Description
234535	Mixer, 220V AC
229340	Mixer, 110V AC
233500	Pneumatic Only

**Model 488 LW Techkit/ Semkit Cartridge Mixer**

Model 488 LW mixer is lightweight and designed to mix kits at dynamic point of use. Examples include ships, aircraft carriers, flight lines or maintenance bays. Configured for 20oz Semkit or Techkit cartridges. Pneumatic only.

**Specifications:**

<b>Weight:</b>	18kg
<b>Motor Speed:</b>	130 RPM
<b>Air Inlet:</b>	85-90 psi
<b>Meets or exceeds:</b>	CE
<b>Warranty:</b>	1 year

**Part Code**
**235260**

The mini mixer is a tool to mix all types of Semkit, Techkits on a drill with a 3/8 Inch chuck.

Part Code	Description
209941	Mini Mixer

**Specifications:**

<b>Weight:</b>	4.6kg
<b>Internal Voltage:</b>	110 or 220 VAC
<b>Motor Speed:</b>	130 RPM
<b>Stroke Speed:</b>	Manual Only
<b>Meets or exceeds:</b>	CE
<b>Warranty:</b>	1 year

## Aerospace Sealant Removal Scrapers and Smoothing Spatulas

Scraper tools are ideal for spreading, smoothing and removing sealants or adhesives. Approved for use in aerospace industry, tools are designed to prevent damage to delicate substrates. Spatulas made from glass filled Nylon. Smoothing tool made from Celcon or glass filled Nylon.

Aerospace Tools



Part Code	Description
TS1275-4	Scraper, Red Celcon
Length:	146.05mm
Width:	19.05mm
Thickness:	4.76mm



Part Code	Description
ADT21102Y	Scraper, Yellow Nylon
Length:	152.40mm
Width:	19.00mm
Thickness:	4.76mm



Part Code	Description
TS1275-4B	Scraper, Blue Celcon
Length:	152.40mm
Width:	19.00mm
Thickness:	4.76mm



Part Code	Description
234350	Scraper, Red Celcon
Length:	147.32mm
Width:	18.79mm
Thickness:	4.76mm



Part Code	Description
ADT411B90	Scraper, Red Celcon
Length:	228.60mm
Width:	6.35mm
Thickness:	5.55mm



Part Code	Description
ADT411B60	Scraper, Red Celcon
Length:	152.40mm
Width:	19.00mm
Thickness:	4.76mm



Part Code	Description
AD14758	Scraper, Brown Phenolic
Length:	190.50mm
Width:	25.40mm
Thickness:	4.76mm



Part Code	Description
AD14755	Scraper, Brown Phenolic
Length:	190.50mm
Width:	38.10mm
Thickness:	6.15mm



Part Code	Description
235073	Spreader, Blue Celcon
Length:	101.60mm
Width:	71.12mm
Thickness:	3.20mm



Part Code	Description
229395	Spreader, Bl. Nylon
Length:	76.20mm
Width:	76.20mm
Thickness:	3.20mm



Part Code	Description
235080	Scraper, Red Nylon
Length:	170.18mm
Width:	30.48mm/ 33.02mm
Thickness:	4.76mm



Part Code	Description
235079	Scraper, Red Nylon
Length:	175.26mm
Width:	30.48mm/ 20.32mm
Thickness:	4.76mm



Part Code	Description
235081	Scraper, Red Nylon
Length:	175.26mm
Width:	30.48mm/ 10.16mm
Thickness:	4.76mm



Part Code	Description
235076	Scraper, Red Celcon
Length:	187.96mm
Width:	86.36mm
Thickness:	4.76mm



Part Code	Description
235072	Scraper, Red Celcon
Length:	170.18mm
Width:	5.08mm/ 30.48mm
Thickness:	4.76mm



Part Code	Description
235075	Scraper, Red Celcon
Length:	167.64mm
Width:	48.26mm/ 30.48mm
Thickness:	4.76mm



Part Code	Description
235074	Scraper, Red Celcon
Length:	167.64mm
Width:	25.4mm/ 30.48mm
Thickness:	4.76mm



Part Code	Description
235073	Scraper, Red Celcon
Length:	167.64mm
Width:	12.7mm/ 30.48mm
Thickness:	4.76mm



Part Code	Description
235078	Scraper, Red Nylon
Length:	170.18mm
Width:	22.86mm/ 30.48mm
Thickness:	4.76mm



Part Code	Description
235077	Scraper, Red Nylon
Length:	170.18mm
Width:	5.08mm/ 30.48mm
Thickness:	4.76mm



Part Code	Description
ADT-T10C	Scraper, Red Celcon
Length:	127.0mm
Width:	25.40mm
Thickness:	4.76mm



Part Code	Description
ADT-T20C	Scraper, Red Celcon
Length:	127.0mm
Width:	50.80mm
Thickness:	4.76mm



Part Code	Description
ADT-8-RSC-RED	Scraper, Red Celcon
Length:	203.2mm
Width:	50.8mm/ 25.4mm
Thickness:	4.76mm



Part Code	Description
ADT-25C	Scraper, Red Celcon
Length:	127.0mm
Width:	6.35mm
Thickness:	4.76mm

### Aerospace Sealant Removal Scrapers and Smoothing Spatulas

Scraper tools are ideal for spreading, smoothing and removing sealants or adhesives. Approved for use in aerospace industry, tools are designed to prevent damage to delicate substrates. Spatulas made from glass filled Nylon. Smoothing tool made from Celcon or glass filled Nylon.



Part Code	Description
226241	Spatula, Orange Nylon

Length: 184.15mm  
Width: 7.11mm/ 9.65mm  
Thickness: 4.76mm

Part Code	Description
226242	Spatula, Orange Nylon

Length: 184.15mm  
Width: 4.75mm/ 7.14mm  
Thickness: 4.76mm



Part Code	Description
226243	Spatula, Orange Nylon

Length: 184.15mm  
Width: 15.0mm/ 9.40mm  
Thickness: 4.76mm



Part Code	Description
235037	Spatula, Orange Nylon

Length: 254.0mm  
Width: 7.11mm/ 9.65mm  
Thickness: 4.76mm



Part Code	Description
231349	Spatula, Black Nylon

Length: 238.0mm  
Width: 15.0mm/ 9.40mm  
Thickness: 4.76mm



Part Code	Description
AD-SR9	Spatula, Orange Nylon

Length: 228.6mm  
Width: 14.28mm/ 7.14mm  
Thickness: 4.76mm



Part Code	Description
1275-000-003	Spatula, Blue Nylon

Length: 182.9mm  
Width: 7.50mm/ No Head  
Thickness: 4.76mm



Part Code	Description
1275-000-002	Spatula, Blue Nylon

Length: 182.9mm  
Width: 9.70mm/ 4.90mm  
Thickness: 4.76mm



Part Code	Description
1275-000-003	Spatula, Blue Nylon

Length: 182.9mm  
Width: 9.70mm/ 12.70mm  
Thickness: 4.76mm



Part Code	Description
AD-SR1	Spatula, Orange Nylon

Length: 177.8mm  
Width: 9.52mm/ 4.76mm  
Thickness: 4.76mm



Part Code	Description
AD-SR4	Spatula, Orange Nylon

Length: 177.8mm  
Width: 9.52mm/ 12.70mm  
Thickness: 4.76mm



Part Code	Description
235078	Spatula, Brass

Length: 182.88mm  
Width: 9.70mm/ 4.90mm  
Thickness: 4.76mm



Part Code	Description
AD-SR5	Spatula, Orange Nylon

Length: 177.8mm  
Width: 6.35mm/ 11.12mm  
Thickness: 4.76mm



Part Code	Description
226244	Spatula Kit, Red Nylon

Length: 184.15mm  
Width 1: 7.11mm/ 9.65mm  
Width 2: 4.75mm/ 7.14mm  
Width 3: 9.65mm/ 12.70mm



Part Code	Description
AD-SR3K	Spatula Kit, Yellow Nylon

Length: 177.80mm  
Width 1: 3.17mm/ 7.15mm  
Width 2: 9.52mm/ 4.76mm  
Width 3: 9.52mm/ 12.70mm



Part Code	Description
TS1275-KP	Spatula Kit, Blue Nylon

Length: 182.90mm  
Width 1: 9.70mm/ 12.70mm  
Width 2: 9.70mm/ 4.90mm  
Width 3: 7.50mm/ No Head



Part Code	Description
AD14715	Acid Brushes

Length: 152.40mm  
Diameter: 9.52mm  
Bristle: Horsehair



Part Code	Description
AD14752	Sealant Roller Rubber

Length: 304.80mm  
Roller Width: 76.20mm  
Roller Dia.: 34.92mm



Part Code	Description
AD14750	Sealant Roller Nylon

Length: 304.80mm  
Roller Width: 50.80mm  
Roller Dia.: 31.75mm



Part Code	Description
AD16532	Sealant Cutter Tool

Diameter: 10.0mm  
Shank: 1/4" x 28



Part Code	Description
AD16530	Sealant Cutter Tool

Diameter: 21.0mm  
Shank: 1/4" x 28



## Two component manual cartridge dispensing

## 50ml/ 75ml Manual Dual Guns

Low cost, simple dual hand applicator guns for 50ml 1:1, 2:1, 4:1, 10:1, 10:1 oval shape as well as 75ml 1:1 ratio. Easy load and dispense. For low to medium viscosity materials. Light trigger.

**Material:** Nylon  
**Thrust:** 1.5kN Max.  
**Cartridge Sizes:** 50ml, 75ml  
**Holder Length:** 109mm  
**Weight:** 0.18kg  
**Force Ratio:** 7:1



Size/ Mix Ratio	Part Code
50ml, 1:1/ 2:1, Black	ABM-25MS
50ml, 1:1/ 2:1	ABM-25M1
50ml, 4:1	ABM-25M4
50ml, 10:1	ABM-25M10
50ml, 10:1, Oval Shape	ABM-25M10R
75ml, 1:1	ABM-75M1

## 50ml Manual Dual Gun

Powerful, simple hand applicator gun for 50ml 1:1 ratio dual cartridges. Metal body design. Side load and easy trigger dispense. For medium viscosity materials. Epoxy coated trigger.

**Material:** Nylon, Steel  
**Thrust:** 2.5kN Max.  
**Cartridge Sizes:** 50ml  
**Holder Length:** 105mm  
**Weight:** 0.32kg  
**Force Ratio:** 12:1



Size	Part Code
50ml, 1:1	CBM 25

## 50ml Manual Dual Gun

High performance, strong hand applicator gun for 50ml 1:1 and 2:1 ratio dual cartridges. Side load design. Easy trigger dispense. For low to medium viscosity materials. Light trigger.

**Material:** Nylon, Steel  
**Thrust:** 2.5kN Max.  
**Cartridge Sizes:** 50ml  
**Holder Length:** 181mm  
**Weight:** 0.41kg  
**Force Ratio:** 26:1



Size	Part Code
50ml, 1:1/ 2:1	H8 XM

## 50ml Manual Dual Gun

Light, simple dual hand applicator gun for all 50ml 1:1, 2:1, 4:1, 10:1. Options for S-Type oval shape as well as 75ml 1:1 ratio. Easy load and dispense. For low to medium viscosity materials. Light trigger.

**Material:** Nylon  
**Thrust:** 3.5kN Max.  
**Cartridge Sizes:** 50ml  
**Holder Length:** 125mm  
**Weight:** 0.21kg  
**Force Ratio:** 16:1



Size/ Mix Ratio	Part Code
50ml 1:1, 2:1, 4:1, 10:1	MPD50

## 50ml Multi Ratio Manual Dual Gun

Light, simple dual hand applicator gun for all 50ml 1:1, 2:1, 4:1, 10:1. Options for S-Type oval shape as well as 75ml 1:1 ratio. Easy load and dispense. For low to medium viscosity materials. Light trigger.

**Material:** ABS  
**Thrust:** 2.5kN Max.  
**Cartridge Sizes:** 50ml  
**Holder Length:** 109mm  
**Weight:** 0.24kg  
**Force Ratio:** 12:1



Size/ Mix Ratio	Part Code
50ml 1:1, 2:1, 4:1, 10:1	MR50

## 150ml Manual Dual Gun

Hand applicator gun for 150ml 1:1 ratio bi-mixer dual cartridges. Medium to high viscosity materials. Epoxy coated aluminium handle.

**Material:** Steel  
**Thrust:** 3.5kN Max.  
**Cartridge Sizes:** 150ml  
**Holder Length:** 129mm  
**Weight:** 1.0kg  
**Force Ratio:** 18:1



Size/ Mix Ratio	Part Code
150ml 1:1	PPM75

## 150ml / 300ml Manual Dual Gun

Hand applicator gun for 150ml 1:1 and 300ml 1:1, 2:1 ratio bi-mixer dual 2K cartridges. Slim metal body design. Side load and easy trigger dispense. For low to medium viscosity materials.

**Material:** Steel  
**Thrust:** 2.5kN Max.  
**Cartridge Sizes:** 150ml, 300ml  
**Holder Length:** 236mm  
**Weight:** 1.88kg  
**Force Ratio:** 10:1



Size	Part Code
150ml 1:1, 300ml 1:1/2:1	BG300-5

## 300ml Manual Dual Gun

Hand applicator gun for 300ml 1:1 ratio bi-mixer dual cartridges. Medium to high viscosity materials. Epoxy coated steel construction.

**Material:** Steel  
**Thrust:** 3.5kN Max.  
**Cartridge Sizes:** 300ml  
**Holder Length:** 236mm  
**Weight:** 1.52kg  
**Force Ratio:** 18:1



Size/ Mix Ratio	Part Code
300ml 1:1	PPM150

## 300ml Manual Dual Gun

Hand applicator gun for 300ml 1:1/ 2:1 and 600ml 1:1 ratio dual cartridges. Medium to high viscosity materials. Slim design.

**Material:** Steel  
**Thrust:** 3.5kN Max.  
**Cartridge Sizes:** 300ml/ 600ml  
**Holder Length:** 243mm  
**Weight:** 2.4kg  
**Force Ratio:** 20:1



Size/ Mix Ratio	Part Code
300ml 1:1/2:1, 600ml 1:1	BG600-4

### 200ml/400ml Multi Ratio Manual Dual Gun

Multi ratio hand applicator guns for 200ml and 400ml 1:1, 2:1, 4:1, 10:1 dual cartridges. High viscosity materials. Supplied with conversion kit for ratio change.

**Material:** Steel  
**Thrust:** 4.6kN Max.  
**Cartridge Sizes:** 200ml/ 400ml  
**Holder Length:** 233mm  
**Weight:** 2.19kg  
**Force Ratio:** 26:1



Size/ Mix Ratio	Part Code
200ml 1:1, 2:1, 4:1, 10:1	BG200-1
400ml 1:1, 2:1, 4:1, 10:1	BG400-1

### 200ml or 400ml Multi Ratio Manual Dual Guns

Multi ratio hand applicator gun for 200ml 1:1, 2:1, 4:1, 10:1 dual cartridges. Medium to high viscosity materials. With kit for ratio change.

**Material:** Steel  
**Thrust:** 3.5kN Max.  
**Cartridge Sizes:** 200ml/ 400ml  
**Holder Length:** 212mm  
**Weight:** 1.50kg  
**Force Ratio:** 18:1



Size/ Mix Ratio	Part Code
200ml 1:1, 2:1, 4:1, 10:1	VBM200MR
400ml 1:1, 2:1, 4:1, 10:1	VBM400MR

### 200ml Manual Dual Gun

Hand applicator gun for 200ml 1:1 ratio dual cartridges. Low to medium viscosity materials. Epoxy coated steel product.

**Material:** Steel  
**Thrust:** 2.5kN Max.  
**Cartridge Sizes:** 200ml  
**Holder Length:** 166mm  
**Weight:** 1.2kg  
**Force Ratio:** 18:1



Size/ Mix Ratio	Part Code
200ml 1:1	VBM100

### 200ml Manual Dual Gun

Hand applicator gun for 200ml 1:1 ratio dual cartridges. Medium to high viscosity materials. Epoxy coated steel product.

**Material:** Steel  
**Thrust:** 3.5kN Max.  
**Cartridge Sizes:** 200ml  
**Holder Length:** 164mm  
**Weight:** 1.25kg  
**Force Ratio:** 18:1



Size/ Mix Ratio	Part Code
200ml 1:1	RBM100

### 200ml Manual Dual Gun

Applicator gun for 200ml 1:1 ratio dual cartridges. For low viscosity materials. Epoxy coated steel product.

**Material:** Steel  
**Thrust:** 1.5kN Max.  
**Cartridge Sizes:** 200ml  
**Holder Length:** 236mm  
**Weight:** 1.0kg  
**Force Ratio:** 10:1



Size/ Mix Ratio	Part Code
200ml 1:1	VBM200

## Two component manual cartridge dispensing

### 200ml Manual Dual Gun

Hand applicator gun for 200ml 1:1 and 2:1 ratio dual cartridges. High viscosity materials. Epoxy coated steel product.

**Material:** Steel  
**Thrust:** 4.6kN Max.  
**Cartridge Sizes:** 200ml  
**Holder Length:** 243mm  
**Weight:** 1.66kg  
**Force Ratio:** 26:1



Size/ Mix Ratio	Part Code
200ml 1:1, 2:1	BG200-4

### 300ml / 600ml Manual Dual Gun

Multi ratio hand applicator for 300ml 1:1, 2:1 and 600ml 1:1, 2:1, 4:1 dual cartridges. Medium to high viscosity materials. With conversion kit for ratio change.

**Material:** Steel  
**Thrust:** 4.6kN Max.  
**Cartridge Sizes:** 300ml/ 600ml  
**Holder Length:** 293mm  
**Weight:** 2.58kg



Size/ Mix Ratio	Part Code
300ml 1:1, 2:1, 600ml 1:1, 2:1, 4:1	BG3600-1

### 150ml / 300ml / 600ml Manual Dual Guns

Hand applicator guns for 150ml, 300ml and 600ml dual cartridges. Easy Medium to high viscosity materials. With conversion kit for ratio change.

**Material:** Steel  
**Thrust:** 3.5kN Max.  
**Cartridge Sizes:** 300ml/ 600ml  
**Holder Length:** 293mm  
**Weight:** 2.40kg  
**Force Ratio:** 18:1



Size/ Mix Ratio	Part Code
300ml 1:1, 2:1, 150ml 1:1	BG300-7
300ml 1:1, 2:1, 600ml 1:1, 2:1, 10:1	BG300-1

### 200ml Manual Dual Gun

Hand applicator gun for 200ml 10:1 ratio dual cartridges. Low to medium viscosity materials. Epoxy coated steel product.

**Material:** Steel  
**Thrust:** 4.5kN Max.  
**Cartridge Sizes:** 200ml  
**Holder Length:** 177mm  
**Weight:** 1.58kg  
**Force Ratio:** 26:1



Size/ Mix Ratio	Part Code
200ml 10:1	BG200-XSP

### 200ml Multi Ratio Manual Dual Gun

Hand applicator gun for 200ml 1:1, 2:1, 4:1, 10:1 ratio dual cartridges. High viscosity materials. Epoxy coated steel product.

**Material:** Steel  
**Thrust:** 4.5kN Max.  
**Cartridge Sizes:** 400ml  
**Holder Length:** 211mm  
**Weight:** 1.6kg  
**Force Ratio:** 25:1



Size/ Mix Ratio	Part Code
200ml 1:1, 2:1, 4:1, 10:1	VBMR200X



## Two component manual cartridge dispensing

### 400ml Multi Ratio Manual Gun

Multi ratio gun for use with 400ml 1:1, 2:1, 4:1, 10:1 ratio dual cartridges. Medium to high viscosity materials. With conversion kit for ratio change.

**Material:** Steel  
**Thrust:** 3.5kN Max.  
**Cartridge Sizes:** 200ml  
**Holder Length:** 200mm  
**Weight:** 1.7kg  
**Force Ratio:** 18:1



Size/ Mix Ratio	Part Code
400ml 1:1, 2:1, 4:1, 10:1	VBM400MR

### 400ml Manual Dual Guns

Hand applicators for 400ml 1:1, 2:1, 4:1, 10:1 ratio dual cartridges. High viscosity materials. Epoxy coated steel product.

**Material:** Steel  
**Thrust:** 3.5kN Max.  
**Cartridge Sizes:** 200ml  
**Holder Length:** 200mm  
**Weight:** 1.7kg  
**Force Ratio:** 18:1



Size / Mix Ratio	Part Code
400ml 1:1	VBM400MRX-1
400ml 2:1	VBM400MRX-2
400ml 4:1	VBM400MRX-4
400ml 10:1	VBM400MRX-10

### 400ml Manual Dual Gun

Hand applicator gun for use with 400ml 1:1 ratio bi-mixer dual cartridges. High viscosity materials. Epoxy coated steel product.

**Material:** Steel  
**Thrust:** 4.5kN Max.  
**Cartridge Sizes:** 400ml  
**Holder Length:** 211mm  
**Weight:** 1.6kg  
**Force Ratio:** 25:1



Size/ Mix Ratio	Part Code
400ml 1:1	VBM200X

### 600ml Multi Ratio Manual Dual Gun

Multi ratio applicators for 600ml 1:1, 2:1, 4:1 ratio dual cartridges. For medium to high viscosity materials. With conversion kit for ratio change.

**Material:** Steel  
**Thrust:** 4.5kN Max.  
**Cartridge Sizes:** 400ml  
**Holder Length:** 217mm  
**Weight:** 1.6kg  
**Force Ratio:** 25:1



Size/ Mix Ratio	Part Code
600ml 1:1, 2:1, 4:1	VBM600

### 600ml Multi Ratio Manual Dual Gun

Hand applicator gun for 1200ml 1:1, 2:1 ratio dual cartridges. Medium to high viscosity materials. Robust steel product.

**Material:** Steel  
**Thrust:** 4.5kN Max.  
**Cartridge Sizes:** 1200ml  
**Holder Length:** 177mm  
**Weight:** 2.57kg  
**Force Ratio:** 26:1



Size/ Mix Ratio	Part Code
1200ml 1:1, 2:1	BG1200-1

### 300ml / 600ml Manual Dual Gun

Hand applicator gun for 300ml 1:1, 2:1, 600ml 1:1, 2:1 ratio dual cartridges. For medium to high viscosity materials. Steel frame.

**Material:** Steel  
**Thrust:** 4.5kN Max.  
**Cartridge Sizes:** 400ml  
**Holder Length:** 211mm  
**Weight:** 1.6kg  
**Force Ratio:** 25:1



Size/ Mix Ratio	Part Code
300ml/ 600ml 1:1, 2:1	BG600-1

### 750ml Manual Dual Gun

Hand applicator gun for 750ml 10:1 ratio dual cartridges. Medium to high viscosity materials. Hammer finished alloy handle.

**Material:** Steel  
**Thrust:** 3.5kN Max.  
**Cartridge Sizes:** 750ml  
**Holder Length:** 245mm  
**Weight:** 1.9kg  
**Force Ratio:** 26:1



Size/ Mix Ratio	Part Code
750ml 10:1	BG750-1

### 375ml/ 450ml / 600ml Manual Dual Gun

Hand applicator gun for 375ml, 450ml, 600ml 1:1, 2:1, 4:1 ratio dual cartridges. Low to medium viscosity materials. Epoxy coated steel.

**Material:** Steel  
**Thrust:** 2.5kN Max.  
**Cartridge Sizes:** 375, 450, 600ml  
**Holder Length:** 200mm  
**Weight:** 1.7kg  
**Force Ratio:** 12:1



Size/ Mix Ratio	Part Code
375ml, 450ml, 600ml, 1:1, 2:1, 4:1	PPM300LVMR

### 750ml / 900ml / 1200ml Manual Dual Gun

Hand applicator gun for 750ml, 900ml, 1200ml 1:1, 2:1, 4:1 ratio dual cartridges. Medium to high viscosity materials. Epoxy coated steel.

**Material:** Steel  
**Thrust:** 4.5kN Max.  
**Cartridge Sizes:** 750, 900, 1200ml  
**Holder Length:** 230mm  
**Weight:** 2.1kg  
**Force Ratio:** 25:1



Size/ Mix Ratio	Part Code
750ml, 900ml, 1200ml, 1:1, 2:1, 4:1	PPM600X

### 825ml / 1500ml Manual Dual Gun

Hand applicator gun for 825ml, 1500ml 1:1, 10:1 ratio dual cartridges. Medium to high viscosity materials. Epoxy coated steel.

**Material:** Steel  
**Thrust:** 4.5kN Max.  
**Cartridge Sizes:** 825, 1500ml  
**Holder Length:** 234mm  
**Weight:** 1.7kg  
**Force Ratio:** 25:1



Size/ Mix Ratio	Part Code
825ml, 1500ml, 1:1, 10:1	PPM300X



## Two component manual cartridge dispensing

### 200ml /400ml Manual Dual Guns

Hand applicator guns for 200ml, 400ml 1:1, 2:1, 4:1, 10:1 ratio dual cartridges. Medium to high viscosity. Robust steel and aluminium.

**Material:** Steel  
**Thrust:** 200ml 4.5kN. 400ml 6.4kN  
**Cartridge Sizes:** 200, 400ml  
**Holder Length:** 177mm  
**Weight:** 1.35kg/ 1.85kg  
**Force Ratio:** 26:1



Size/ Mix Ratio	Part Code
200ml, 1:1/ 2:1	DM200-01
200ml, 4:1	DM200-04
200ml, 10:1	DM200-10
400ml, 1:1/ 2:1	DM400-01
400ml, 4:1	DM400-04
400ml, 10:1	DM400-10

### 380ml Manual Dual Gun

Hand applicator gun for 380ml 5:1, 10:1 ratio dual cartridges. Medium to high viscosity materials. Lightweight nylon and steel product.

**Material:** Steel  
**Thrust:** 5kN Max.  
**Cartridge Sizes:** 380ml  
**Holder Length:** 222mm  
**Weight:** 1.0kg  
**Force Ratio:** 26:1



Size/ Mix Ratio	Part Code
380ml 5:1, 10:1	H285SM

### 345ml / 350ml Manual Dual Gun

Hand applicator guns for 345ml/ 350ml 10:1 ratio dual cartridges. Medium to high viscosity materials. Lightweight nylon and steel.

**Material:** Steel  
**Thrust:** 5kN Max.  
**Cartridge Sizes:** 345, 350ml  
**Holder Length:** 264mm  
**Weight:** 0.90kg  
**Force Ratio:** 26:1



Size/ Mix Ratio	Part Code
345ml/ 350ml, 10:1	H260M

### 200ml Manual Dual Guns

Hand applicator guns for 200ml 1:1, 2:1, 4:1, 10:1 ratio dual cartridges. Low to medium viscosity materials. Lightweight nylon and steel product.

**Material:** Nylon, Steel  
**Thrust:** 2.5kN Max.  
**Cartridge Size:** 200ml  
**Holder Length:** 157mm  
**Weight:** 1.07kg  
**Force Ratio:** 26:1



Size/ Mix Ratio	Part Code
200ml, 1:1/ 2:1	H236M
200ml, 4:1/ 10:1	H236 M4-10

### 200ml Manual Dual Gun

Hand applicator guns for 600ml, 620ml 1:1 ratio dual cartridges. Medium to high viscosity materials. Lightweight nylon and steel product.

**Material:** Nylon, Steel  
**Thrust:** 5kN Max.  
**Cartridge Sizes:** 600, 620ml  
**Holder Length:** 231mm  
**Weight:** 1.2kg  
**Force Ratio:** 26:1



Size/ Mix Ratio	Part Code
200ml, 1:1/ 2:1	H288 N

### 200ml Manual Dual Gun

Hand applicator gun for 200ml 1:1 ratio dual cartridges. Medium viscosity materials. Super lightweight nylon and steel product.

**Material:** Nylon, Steel  
**Thrust:** 3kN Max.  
**Cartridge Size:** 200ml  
**Holder Length:** 194mm  
**Weight:** 0.82kg  
**Force Ratio:** 18:1



Size/ Mix Ratio	Part Code
200ml, 1:1	H248

### 600ml Manual Dual Gun

Hand applicator gun for 600ml 1:1 ratio dual cartridges. Medium viscosity materials. Lightweight nylon and steel product.

**Material:** Nylon, Steel  
**Thrust:** 5kN Max.  
**Cartridge Sizes:** 600ml  
**Holder Length:** 231mm  
**Weight:** 1.2kg  
**Force Ratio:** 26:1



Size/ Mix Ratio	Part Code
600ml, 1:1	H293

### 330ml Manual Dual Gun

Hand applicator gun for 330ml 10:1 ratio dual cartridges. Medium to high viscosity materials. Super lightweight nylon and steel product.

**Material:** Nylon, Steel  
**Thrust:** 5kN Max.  
**Cartridge Size:** 330ml  
**Holder Length:** 250mm  
**Weight:** 0.80kg  
**Force Ratio:** 26:1



Size/ Mix Ratio	Part Code
330ml, 10:1	H297MN

### 450ml Multi Ratio Manual Dual Gun

Hand applicator gun for 450ml 2:1 ratio dual cartridges. Medium to high viscosity materials. Lightweight nylon and steel product.

**Material:** Nylon, Steel  
**Thrust:** 5kN Max.  
**Cartridge Sizes:** 450ml  
**Holder Length:** 228mm  
**Weight:** 1.22kg  
**Force Ratio:** 26:1



Size/ Mix Ratio	Part Code
450ml, 2:1	H293PM

### 385ml Manual Dual Gun

Hand applicator for use with 385ml 3:1 ratio dual cartridges. High viscosity materials. Lightweight nylon and steel product.

**Material:** Steel  
**Thrust:** 5kN Max.  
**Cartridge Sizes:** 385ml  
**Holder Length:** 187mm  
**Weight:** 1.22kg  
**Force Ratio:** 26:1



Size/ Mix Ratio	Part Code
385ml 3:1	H244S

## Two component manual cartridge dispensing

### 385ml Manual Dual Gun

Hand applicator gun for 900ml 2:1 ratio dual cartridges. High viscosity materials. Heavy duty and steel frame with nylon trigger.

**Material:** Steel  
**Thrust:** 5kN Max.  
**Cartridge Sizes:** 385ml  
**Holder Length:** 235mm  
**Weight:** 2.08kg  
**Force Ratio:** 26:1



Size/ Mix Ratio	Part Code
385ml 3:1	H244S

### Dual 310ml Cartridge Manual Dual Gun

Hand applicator gun for 2 separate 310ml aluminium or plastic cartridges without a static mixer. Low to medium viscosity. Epoxy coated steel.

**Material:** Steel  
**Thrust:** 3.5kN Max.  
**Cartridge Sizes:** 310ml  
**Holder Length:** 222mm  
**Weight:** 1.2kg  
**Force Ratio:** 18:1



Size/ Mix Ratio	Part Code
2 x 310ml, 1:1	CCM310

### 385ml Manual Dual Gun

Hand applicator gun for 385ml 3:1 ratio bi-mixer dual cartridges. Medium to high viscosity materials. Lightweight nylon and steel product.

**Material:** Steel  
**Thrust:** 3.5kN Max.  
**Cartridge Sizes:** 385ml  
**Holder Length:** 327mm  
**Weight:** 1.20kg  
**Force Ratio:** 18:1



Size/ Mix Ratio	Part Code
385ml, 3:1	RBM385

### 585ml Manual Dual Gun

Hand applicator gun for 585ml 3:1 ratio dual cartridges. Medium to high viscosity materials. Lightweight nylon and steel product.

**Material:** Nylon, Steel  
**Thrust:** 4.5kN Max.  
**Cartridge Sizes:** 150, 300, 330ml  
**Holder Length:** 224mm  
**Weight:** 1.1kg  
**Force Ratio:** 25:1



Size/ Mix Ratio	Part Code
585ml, 3:1	RBM585

### 380ml Coaxial Cartridge Manual Gun

Hand applicator gun for 380ml 1:1, 2:1, 5:1, 10:1 ratio coaxial dual cartridges. Medium to high viscosity materials. Epoxy coated steel.

**Material:** Nylon, Steel  
**Thrust:** 3.5kN Max.  
**Cartridge Sizes:** 380ml  
**Holder Length:** 181mm  
**Weight:** 1.1kg  
**Force Ratio:** 18:1



Size/ Mix Ratio	Part Code
380ml, 1:1	380X/1
380ml, 2:1	380X/2
380ml, 5:1	380X/5
380ml, 10:1	380X/10

### Coaxial Cartridge Manual Gun

Hand applicator gun for 150ml, 220ml, 300ml, 330ml 1:1, 10:1 ratio coaxial dual cartridges. Medium to high viscosity materials. Epoxy coated steel.

**Material:** Steel  
**Thrust:** 3.5kN Max.  
**Cartridge Sizes:** 150, 220, 300, 320ml  
**Holder Length:** 222mm  
**Weight:** 0.88kg  
**Force Ratio:** 18:1



Size/ Mix Ratio	Part Code
150ml, 220ml, 300ml, 330ml 1:1/10:1	CCM310

### Coaxial Cartridge Manual Gun

Hand applicator gun for 150ml, 300ml, 330ml 1:1 and 10:1 ratio coaxial dual cartridges. High viscosity materials. Epoxy coated steel.

**Material:** Nylon, Steel  
**Thrust:** 4.5kN Max.  
**Cartridge Sizes:** 150, 300, 330ml  
**Holder Length:** 224mm  
**Weight:** 1.1kg  
**Force Ratio:** 25:1



Size/ Mix Ratio	Part Code
150ml, 300ml, 330ml 1:1/10:1	CCM310HP

### Coaxial Cartridge Manual Gun

Hand applicator gun for 380ml 3M FPI 1 Foam coaxial dual cartridges. Low to medium viscosity materials. Epoxy coated steel.

**Material:** Steel  
**Thrust:** 3.5kN Max.  
**Cartridge Sizes:** 380ml  
**Holder Length:** 181mm  
**Weight:** 1.3kg  
**Force Ratio:** 18:1



Size/ Mix Ratio	Part Code
380ml, 5:1	NB385

### 200ml Manual Dual Guns

Hand applicator gun for 200ml 1:1, 2:1, 10:1 ratio dual cartridges. Low to medium viscosity materials. Lightweight plastic.

**Material:** Nylon  
**Thrust:** 1.25kN Max.  
**Cartridge Sizes:** 200ml  
**Holder Length:** 166mm  
**Weight:** 1.1kg  
**Force Ratio:** 12:1



Size/ Mix Ratio	Part Code
200ml, 1:1	AD200-1FU
200ml, 2:1	AD200-2FU
200ml, 10:1	AD200-10FU

### 400ml Manual Dual Guns

Hand applicator gun for 400ml 1:1, 2:1, 10:1 ratio dual cartridges. Low to medium viscosity materials. Lightweight plastic.

**Material:** Nylon  
**Thrust:** 1.25kN Max.  
**Cartridge Sizes:** 400ml  
**Holder Length:** 205mm  
**Weight:** 1.1kg  
**Force Ratio:** 12:1



Size/ Mix Ratio	Part Code
400ml, 1:1	AD400-1F
400ml, 2:1	AD400-2F
400ml, 10:1	AD400-10F



## Two component pneumatic cartridge dispensing

### 50ml Pneumatic Dual Guns

Applicator gun for 50ml 1:1, 2:1, 3:1 ratio dual cartridges. Hinged front load. Low to medium viscosity materials. Adjustable flow. Airflow 1.

**Material:** Aluminium  
**Thrust:** 1.1kN Max.  
**Cartridge Sizes:** 50ml  
**Holder Length:** 105mm  
**Weight:** 1.9kg  
**Max. Pressure:** 75 PSI



Size/ Mix Ratio	Part Code
50ml, 1:1	ADCBA-25D
50ml, 2:1	ADCBA-25D2
50ml, 3:1	ADCBA-25D3

### 150ml Pneumatic Dual Gun

Applicator gun for 150ml 1:1 ratio dual cartridges. Top loading. For low to medium viscosity materials. Adjustable flow.

**Material:** Nylon, Steel  
**Thrust:** 2.2kN Max.  
**Cartridge Size:** 150ml  
**Frame Length:** 132mm  
**Weight:** 1.6kg  
**Max. Pressure:** 100 PSI



Size/ Mix Ratio	Part Code
150ml, 1:1	PPA75HP

### 50ml Pneumatic Dual Guns

Applicator gun for 50ml 1:1, 2:1, 4:1, 10:1 ratio dual cartridges. Screw cap front. Low to medium viscosity materials. Adjustable flow. Airflow 2.

**Material:** Aluminium  
**Thrust:** 0.70kN Max.  
**Cartridge Sizes:** 50ml  
**Frame Length:** 216mm  
**Weight:** 2.2kg  
**Max. Pressure:** 50 PSI



Size/ Mix Ratio	Part Code
50ml, 1:1	CBA-50
50ml, 2:1	CBA-50-2
50ml, 4:1	CBA-50-4
50ml, 10:1	CBA-50-10

### 200ml Pneumatic Dual Guns

Applicator guns for 200ml 1:1, 2:1, 4:1, 10:1 ratio dual cartridges. Top load. Low to medium viscosity materials. Adjustable flow.

**Material:** Aluminium/ Steel  
**Thrust:** 2.2kN Max.  
**Cartridge Sizes:** 200ml  
**Holder Length:** 207mm  
**Weight:** 1.66kg  
**Max. Pressure:** 100 PSI



Size/ Mix Ratio	Part Code
200ml, 1:1/ 2:1	DP200-70-01
200ml, 4:1	DP200-70-04
200ml, 10:1	DP200-70-10

### 50ml Multi Ratio Pneumatic Dual Gun

Applicator gun for 50ml 1:1, 2:1, 4:1, 10:1 ratio dual cartridges. Hinge load. Low to medium viscosity materials. Adjustable flow.

**Material:** Nylon, Steel  
**Thrust:** 1.3kN Max.  
**Cartridge Sizes:** 50ml  
**Frame Length:** 303mm  
**Weight:** 0.73kg  
**Max. Pressure:** 100 PSI



Size/ Mix Ratio	Part Code
50ml, 1:1, 2:1, 4:1, 10:1	EDS408M

### 200ml Multi Ratio Pneumatic Dual Gun

Applicator gun for 200ml 1:1, 2:1, 4:1, 10:1 ratio dual cartridges. Side load. Low to medium viscosity materials. Adjustable flow.

**Material:** Nylon, Steel  
**Thrust:** 2.2kN Max.  
**Cartridge Sizes:** 200ml  
**Frame Length:** 172mm  
**Weight:** 1.7kg  
**Max. Pressure:** 100 PSI



Size/ Mix Ratio	Part Code
200ml 1:1, 2:1, 4:1, 10:1	VBA200BMR

### 50ml Pneumatic Dual Gun

Applicator gun for 50ml 10:1 ratio dual cartridges. Hinge load. Low to medium viscosity. Dedicated 10:1 version only. Adjustable flow.

**Material:** Nylon, Steel  
**Thrust:** 1.3kN Max.  
**Cartridge Sizes:** 50ml  
**Frame Length:** 184mm  
**Weight:** 0.73kg  
**Max. Pressure:** 100 PSI



Size/ Mix Ratio	Part Code
50ml, 10:1	EDS408M-10

### 200ml Multi Ratio Pneumatic Dual Gun

Applicator gun for 200ml 1:1, 2:1, 4:1, 10:1 ratio dual cartridges. Top load. Low to medium viscosity materials. Adjustable flow.

**Material:** Steel  
**Thrust:** 2.5kN Max.  
**Cartridge Sizes:** 200ml  
**Holder Length:** 207mm  
**Weight:** 2.60kg  
**Max. Pressure:** 100 PSI



Size/ Mix Ratio	Part Code
200ml, 1:1/ 2:1/ 4:1/ 10:1	CG200-1

### 50ml Pneumatic Dual Gun

Applicator gun for 50ml 4:1, 10:1 ratio dual cartridges. Hinge load. For low to medium viscosity materials. Adjustable flow.

**Material:** Nylon, Steel  
**Thrust:** 1.3kN Max.  
**Cartridge Sizes:** 50ml  
**Frame Length:** 344mm  
**Weight:** 0.73kg  
**Max. Pressure:** 100 PSI



Size/ Mix Ratio	Part Code
50ml 4:1, 10:1	EDS408M-4

### 200ml Pneumatic Dual Gun

Applicator gun for 200ml 1:1 ratio dual cartridges. Top loading. For low to medium viscosity materials. Adjustable flow.

**Material:** Nylon, Steel  
**Thrust:** 2.2kN Max.  
**Cartridge Sizes:** 200ml  
**Frame Length:** 172mm  
**Weight:** 1.7kg  
**Max. Pressure:** 100 PSI



Size/ Mix Ratio	Part Code
200ml, 1:1	VBA100HP



## Two component pneumatic cartridge dispensing

### 200ml / 250ml / 300ml Pneumatic Dual Gun

Applicator gun for 200ml, 250ml, 300ml 1:1, 2:1 ratio dual cartridges. Top load. Low to medium viscosity materials. Adjustable flow.

**Material:** Aluminium/ Steel  
**Thrust:** 2.2kN Max.  
**Cartridge Sizes:** 200, 250, 300ml  
**Frame Length:** 249mm  
**Weight:** 1.94kg  
**Max. Pressure:** 100 PSI



Size/ Mix Ratio	Part Code
200ml, 250ml, 300ml, 1:1/ 2:1	PPA150B-3

### 300ml / 600ml Pneumatic Dual Gun

Applicator gun for use with 600ml 1:1, 2:1, 4:1 ratio, 300ml 1:1, 2:1 ratio dual cartridges. Top load. Low to medium viscosity. Adjustable flow.

**Material:** Steel  
**Thrust:** 4kN Max.  
**Cartridge Sizes:** 600ml  
**Holder Length:** 235mm  
**Weight:** 2.60kg  
**Max. Pressure:** 100 PSI



Size/ Mix Ratio	Part Code
600ml, 1:1/ 2:1/ 4:1, 300ml 1:1/ 2:1	CG600-1

### 200ml / 250ml / 300ml Pneumatic Dual Gun

Applicator gun for 200ml, 250ml, 300ml 1:1, 2:1 ratio dual cartridges. Top load. Low to medium viscosity materials. Adjustable flow.

**Material:** Aluminium/ Steel  
**Thrust:** 2.2kN Max.  
**Cartridge Sizes:** 200, 250, 300ml  
**Holder Length:** 249mm  
**Weight:** 1.9kg  
**Max. Pressure:** 100 PSI



Size/ Mix Ratio	Part Code
200ml, 250ml, 300ml, 1:1/ 2:1	PPA150B-1

### 300ml / 600ml Pneumatic Dual Gun

Applicator gun for use with 600ml 1:1, 2:1 ratio, 300ml 1:1, 2:1 ratio dual cartridges. Top load. Very high

**Material:** Steel  
**Thrust:** 5.5kN Max.  
**Cartridge Sizes:** 600ml/300ml  
**Frame Length:** 269mm  
**Weight:** 6.35kg  
**Max. Pressure:** 100 PSI



Size/ Mix Ratio	Part Code
600ml 1:1, 2:1, 300ml 1:1, 2:1	CG600-5

### 300ml / 150ml Pneumatic Dual Gun

Applicator gun for 300ml 1:1, 2:1 ratio, 150ml 1:1 ratio dual cartridges. Top load. For low to medium viscosity materials. Adjustable flow.

**Material:** Steel  
**Thrust:** 2.2kN Max.  
**Cartridge Sizes:** 300ml, 150ml  
**Holder Length:** 270mm  
**Weight:** 3.17kg  
**Max. Pressure:** 100 PSI



Size/ Mix Ratio	Part Code
300ml, 1:1/ 2:1, 150ml 1:1	CG300-1

### 300ml / 600ml Pneumatic Dual Gun

Applicator gun for 600ml 1:1, 2:1, 4:1 ratio, 300ml 1:1 ratio cartridges. High power. Top load. Medium to high viscosity. Adjustable flow.

**Material:** Steel  
**Thrust:** 5kN Max.  
**Cartridge Sizes:** 600ml/300ml  
**Holder Length:** 235mm  
**Weight:** 2.60kg  
**Max. Pressure:** 100 PSI



Size/ Mix Ratio	Part Code
600ml, 1:1/ 2:1/ 4:1, 300ml 1:1	CG600-4

### 300ml Pneumatic Dual Gun

Applicator gun for 300ml 1:1 ratio dual cartridges. Top load. For low to medium viscosity materials. Adjustable flow.

**Material:** Steel  
**Thrust:** 2.2kN Max.  
**Cartridge Sizes:** 300ml  
**Holder Length:** 235mm  
**Weight:** 1.90kg  
**Max. Pressure:** 100 PSI



Size/ Mix Ratio	Part Code
300ml, 1:1	PPA150HP

### 400ml Pneumatic Dual Gun

Applicator gun for 400ml 1:1 ratio dual cartridges. Top load. Medium to high viscosity materials. Adjustable flow.

**Material:** Nylon, Aluminium  
**Thrust:** 4kN Max.  
**Cartridge Sizes:** 400ml  
**Holder Length:** 203mm  
**Weight:** 2.6kg  
**Max. Pressure:** 100 PSI



Size/ Mix Ratio	Part Code
400ml, 1:1	TS483XM

### 300ml Pneumatic Dual Gun

Applicator gun for 300ml 1:1, 2:1 ratio dual cartridges. Top load. For low to medium viscosity materials. Adjustable flow.

**Material:** Steel  
**Thrust:** 2.2kN Max.  
**Cartridge Sizes:** 300ml  
**Holder Length:** 249mm  
**Weight:** 1.90kg  
**Max. Pressure:** 100 PSI



Size/ Mix Ratio	Part Code
300ml, 1:1, 2:1	PPA150BMR

### 400ml Pneumatic Dual Guns

Applicator gun for 400ml 1:1, 2:1, 4:1, 10:1 ratio dual cartridges. Top load. For low to medium viscosity materials. Adjustable flow.

**Material:** Aluminium/ Steel  
**Thrust:** 3.2kN Max.  
**Cartridge Sizes:** 400ml  
**Holder Length:** 246mm  
**Weight:** 2.18kg  
**Max. Pressure:** 100 PSI



Size/ Mix Ratio	Part Code
400ml, 1:1/ 2:1	DP400-85-01
400ml 4:1	DP400-85-04
400ml 10:1	DP400-85-10

## Two component pneumatic cartridge dispensing

### 400ml Pneumatic Dual Guns

Applicator guns for 400ml 1:1, 2:1, 4:1, 10:1 ratio dual cartridges. Top load. Medium to high viscosity materials. High power. Adjustable flow.

**Material:** Aluminium/ Steel  
**Thrust:** 4.5kN Max.  
**Cartridge Sizes:** 400ml  
**Holder Length:** 246mm  
**Weight:** 2.41kg  
**Max. Pressure:** 100 PSI



Size/ Mix Ratio	Part Code
400ml, 1:1/ 2:1	DP400-100-01
400ml 4:1	DP400-100-04
400ml 10:1	DP400-100-10

### 600ml Pneumatic Dual Gun

Applicator gun for 600ml 1:1 ratio dual cartridges. Top load. Medium viscosity materials. Adjustable flow.

**Material:** Aluminium/ Steel  
**Thrust:** 4kN Max.  
**Cartridge Sizes:** 600ml  
**Holder Length:** 270mm  
**Weight:** 2.50kg  
**Max. Pressure:** 100 PSI



Size/ Mix Ratio	Part Code
600ml, 1:1	TS488XM

### 400ml Pneumatic Dual Gun

Applicator gun for 400ml 1:1, 2:1, 4:1, 10:1 ratio dual cartridges. Side load. Low to medium viscosity materials. Adjustable flow.

**Material:** Steel  
**Thrust:** 5kN Max.  
**Cartridge Sizes:** 400ml  
**Holder Length:** 249mm  
**Weight:** 3.17kg  
**Max. Pressure:** 100 PSI



Size/ Mix Ratio	Part Code
400ml, 1:1/ 2:1/ 4:1/ 10:1	CG400-1

### 600ml Pneumatic Dual Gun

Applicator gun for 600ml 1:1 ratio dual cartridges. Top load. Medium viscosity materials. Adjustable flow control.

**Material:** Aluminium/ Steel  
**Thrust:** 4kN Max.  
**Cartridge Sizes:** 600ml  
**Holder Length:** 235mm  
**Weight:** 2.60kg  
**Max. Pressure:** 100 PSI



Size/ Mix Ratio	Part Code
600ml, 1:1	TS493XT

### 400ml Pneumatic Dual Gun

Applicator guns for 400ml 1:1, 2:1, 4:1, 10:1 ratio dual cartridges. Side load. Medium to high viscosity materials. High power. Adjustable flow.

**Material:** Aluminium/ Steel  
**Thrust:** 5kN Max.  
**Cartridge Sizes:** 400ml  
**Frame Length:** 249mm  
**Weight:** 1.94kg  
**Max. Pressure:** 100 PSI



Size/ Mix Ratio	Part Code
400ml, 1:1/ 2:1/ 4:1/ 10:1	CG400-2

### 600ml / 1200ml / 1500ml Pneumatic Dual Gun

Applicator gun for 1500ml 1:1, 2:1, 10:1 ratio, 1200ml 1:1, 2:1, 600ml 1:1, 4:1 ratio. Top load. Medium to high viscosity. Adjustable flow.

**Material:** Steel  
**Thrust:** 5kN Max.  
**Cartridge Sizes:** 400ml  
**Holder Length:** 249mm  
**Weight:** 3.17kg  
**Max. Pressure:** 100 PSI



Size/ Mix Ratio	Part Code
1500ml, 1200ml, 600ml	CG600-3

### 400ml Pneumatic Dual Gun

Applicator gun for 400ml 1:1 ratio dual cartridges. Top load. Low to medium viscosity materials. Adjustable flow.

**Material:** Aluminium/ Steel  
**Thrust:** 2.70kN Max.  
**Cartridge Sizes:** 400ml  
**Holder Length:** 189mm  
**Weight:** 2.6kg  
**Max. Pressure:** 100 PSI



Size/ Mix Ratio	Part Code
400ml, 1:1	TS483LXM

### 365ml / 385ml / 585ml Pneumatic Dual Gun

Applicator gun for 365ml, 385ml, 585ml 3:1 ratio dual cartridges. Top load. Medium viscosity materials.. Adjustable flow.

**Material:** Nylon, Steel  
**Thrust:** 3.05kN Max.  
**Cartridge Sizes:** 365, 385, 585ml  
**Holder Length:** 278mm  
**Weight:** 4kg  
**Max. Pressure:** 100 PSI



Size/ Mix Ratio	Part Code
365ml, 385ml, 585ml 3:1	TS444KX

### 400ml Pneumatic Dual Gun

Applicator gun for 400ml 1:1, 2:1, 4:1, 10:1 ratio dual cartridges. Side load. Low to medium viscosity materials. Adjustable flow.

**Material:** Nylon, Steel  
**Thrust:** 2.2kN Max.  
**Cartridge Sizes:** 400ml  
**Frame Length:** 203mm  
**Weight:** 2.2kg  
**Max. Pressure:** 100 PSI



Size/ Mix Ratio	Part Code
400ml 1:1, 2:1, 4:1, 10:1	VBA400BMR

### 825ml Pneumatic Dual Gun

Applicator gun for 825ml 10:1 ratio dual cartridges. Top loading. For high viscosity materials. Adjustable flow.

**Material:** Nylon, Steel  
**Thrust:** 5kN Max.  
**Cartridge Sizes:** 825ml  
**Frame Length:** 236mm  
**Weight:** 3.3kg  
**Max. Pressure:** 100 PSI



Size/ Mix Ratio	Part Code
825ml, 10:1	PPA750



## Two component battery cartridge dispensing

### 50ml Battery Cordless Dual Gun

Applicator for 50ml 1:1/2:1, 4:1, 10:1 ratio dual cartridges. Front load. Low to medium viscosity materials. Adjustable flow. 10.8v battery 1.5Ah Li-Ion. 5mm/sec.

**Material:** Aluminium/Nylon  
**Thrust:** 2.5kN Max.  
**Cartridge Sizes:** 50ml  
**Holder Length:** 115mm  
**Weight:** 1.60kg  
**Voltage:** 10.8v 1.5 Ah



Size/ Mix Ratio	Part Code
50ml, 1:1/ 2:1	ADCBE-50
50ml, 4:1	ADCBE-50-4
50ml, 10:1	ADCBE-50-10

### 400ml Battery Cordless Dual Gun

Applicator for 400ml 1:1/2:1, 4:1, 10:1 ratio dual cartridges. Top load. Medium to high viscosity. Adjustable flow. 18v battery 2.0Ah Li-Ion. 5mm/sec.

**Material:** Steel/Nylon  
**Thrust:** 5kN Max.  
**Cartridge Sizes:** 400ml  
**Holder Length:** 200mm  
**Weight:** 3.50kg  
**Voltage:** 18v 2.0 Ah



Size/ Mix Ratio	Part Code
400ml, 1:1	B983M
400ml, 2:1	B983M21
400ml, 4:1	B938M
400ml, 10:1	B978M

### 380ml Battery Cordless Coaxial Gun

Applicator guns for 380ml 10:1 ratio coaxial cartridges. Top load. Low to medium viscosity. Adjustable flow. 18v battery 2.0Ah Li-Ion. 7mm/sec.

**Material:** Steel/Nylon  
**Thrust:** 2.5kN Max.  
**Cartridge Sizes:** 380ml  
**Holder Length:** 204mm  
**Weight:** 1.82kg  
**Voltage:** 10.v 1.5 Ah



Size/ Mix Ratio	Part Code
380ml, 10:1	EP380C

### 400ml Battery Cordless Dual Gun

Gun for 400ml 1:1, 2:1, 4:1, 10:1 ratio 2K cartridges. Side load design. Medium to high viscosity. Adjust flow. 18v battery 2.0Ah Li-Ion. 5mm/sec.

**Material:** Steel/Nylon  
**Thrust:** 4.45kN Max.  
**Cartridge Sizes:** 400ml  
**Frame Length:** 203mm  
**Weight:** 3.80kg  
**Voltage:** 18v 2.0 Ah



Size/ Mix Ratio	Part Code
400ml, 1:1, 2:1, 4:1, 10:1	VBM400MR

### 380ml Battery Cordless Coaxial Gun

Applicator gun for 380ml 10:1 ratio coaxial cartridges. Top load. Low to medium viscosity. Adjustable flow. 18v battery 2.0Ah Li-Ion. 5mm/sec.

**Material:** Steel/Nylon  
**Thrust:** 2.75kN Max.  
**Cartridge Sizes:** 380ml  
**Holder Length:** 204mm  
**Weight:** 3.30kg  
**Voltage:** 18v 2.0 Ah



Size/ Mix Ratio	Part Code
380ml, 10:1	B985M

### 450ml Battery Cordless Dual Gun

Applicator for 450ml 2:1 ratio dual cartridges. Top load. Medium to high viscosity. Adjustable flow control. 18v battery 2.0Ah Li-Ion. 5mm/sec.

**Material:** Steel/Nylon  
**Thrust:** 4.45kN Max.  
**Cartridge Sizes:** 450ml  
**Holder Length:** 229mm  
**Weight:** 3.50kg  
**Voltage:** 18v 2.0 Ah



Size/ Mix Ratio	Part Code
450ml, 2:1	B959M

### 350ml Battery Cordless Dual Gun

Applicator guns for 350ml 10:1 ratio dual cartridges. Side load. Low to medium viscosity. Adjustable flow. 18v battery 2.0Ah Li-Ion. 5mm/sec.

**Material:** Steel/Nylon  
**Thrust:** 2.8kN Max.  
**Cartridge Sizes:** 350ml  
**Holder Length:** 189mm  
**Weight:** 3.50kg  
**Voltage:** 18v 2.0 Ah



Size/ Mix Ratio	Part Code
350ml, 10:1	B960M

### 600ml Pneumatic Dual Gun

Applicator for 600ml 1:1 ratio dual cartridges. Top load. Medium to high viscosity. Adjustable flow. 18v battery 2.0Ah Li-Ion. 5mm/sec.

**Material:** Steel/Nylon  
**Thrust:** 4.73kN Max.  
**Cartridge Sizes:** 600ml  
**Holder Length:** 234mm  
**Weight:** 3.60kg  
**Voltage:** 18v 2.0 Ah



Size/ Mix Ratio	Part Code
600ml, 1:1	B988M

### 365ml / 385ml / 585ml Battery Cordless Dual Gun

Applicator for 365ml, 385ml, 585ml 3:1 ratio cartridges. Top load. Low to medium viscosity. Adjustable flow. 18v battery 2.0Ah Li-Ion. 5mm/sec.

**Material:** Steel/Nylon  
**Thrust:** 2.7kN Max.  
**Cartridge Sizes:** 365/385/585ml  
**Holder Length:** 265mm  
**Weight:** 3.50kg  
**Voltage:** 18v 2.0 Ah



Size/ Mix Ratio	Part Code
365ml, 385ml, 585ml 3:1	B944K

### 600ml Pneumatic Dual Gun

Applicator for 600ml 1:1 ratio 2K dual cartridges. Top load. Medium to high viscosity. Adjustable flow. 18v battery 2.0Ah Li-Ion. 5mm/sec.

**Material:** Steel/Nylon  
**Thrust:** 5.0kN Max.  
**Cartridge Sizes:** 600ml  
**Frame Length:** 195mm  
**Weight:** 3.80kg  
**Voltage:** 18v 2.0 Ah



Size/ Mix Ratio	Part Code
600ml, 1:1	VBM600-1



### A System Dual Cartridges

Industry standard small cartridge with bayonet twist-on attachment of mixer nozzle. In 50ml and 75ml sizes with 1:1, 2:1, 4:1 and 10:1 mix ratios. Pistons are vented to allow easy insertion to eliminate air entrapment or lip seal with O-ring edge. Supplied in complete sets including pistons and tip cap seal. These cartridges are for use with "MA", "MAQ" and "MAHQ" mix nozzles where they twist-on. Use with manual, air powered or battery rechargeable type applicator guns.

**Material:** Polypro  
**Colour:** White  
**Cartridge Size:** 50ml, 75ml  
**Details:** Silicone-Free  
**Max. Pressure:** 100 PSI

Part Code	Ratio	Capacity	Material	Piston Style
451000	1:1	50ml	PP White	Self Venting
451000-02	1:1	50ml	PP White	EPDM O-ring
452013	2:1	50ml	PP White	Self Venting
452013-02	2:1	50ml	PP White	EPDM O-ring
454000	4:1	50ml	PP White	EPDM O-ring
454010	10:1	50ml	PP White	EPDM O-ring
475000	1:1	75ml	PP White	Self Venting



### A System Manual Dual Cartridge Assembly

Manual small cartridge with bayonet twist-on attachment of mixer nozzle. 25ml 1:1 mix ratio. Pistons are vented or lip seal with O-ring edge. Supplied in complete sets including rod, pistons and tip cap seal. These cartridges are for use with "MA", "MAQ" and "MAHQ" mix nozzles where they twist-on.

**Material:** Polypro  
**Colour:** White  
**Cartridge Size:** 25ml  
**Details:** Silicone-Free



Part Code	Ratio	Capacity	Material	Piston Style	Piston Colour
251000A-01	1:1	25ml	PP White	Self Venting	Grey/ Blue
251000A-02	1:1	25ml	PP White	EPDM O-ring	White/ Black

### A System Bayonet Static Mixer Nozzles

High density bayonet static mixer nozzles for use with A Series twin 50ml cartridges. Stepped at the outlet end for controlled dispensing direct or by using our luer lock tip adapters for higher precision. These mixer nozzles are suitable for most two-component materials. They are constructed of high grade polypropylene. All products are industrial grade and silicone free plastics. "L" versions have luer outlets to accept a needle tip.

Part Code	Ratio	ID	Element	Outlet	Length	Colour	Volume
MA3.0-07S	1:1/2:1	3mm	7	Tapered	34mm	White	0.24ml
MA3.0-13S	1:1/2:1	3mm	13	Tapered	51mm	White	0.36ml
MA3.0-17S	1:1/2:1	3mm	17	Tapered	62mm	White	0.34ml
MA4.0-13S	1:1/2:1	4mm	13	Tapered	66mm	White	0.60ml
MA4.0-17S	1:1/2:1	4mm	17	Tapered	82mm	White	0.75ml
MA4.0-17D	1:1/2:1	4mm	17	Straight	78mm	White	0.75ml
MA5.4-07S	1:1/2:1	5.4mm	7	Stepped	56mm	White	0.80ml
MA5.4-13S	1:1/2:1	5.4mm	13	Stepped	85mm	White	1.36ml
MA5.3-13D	1:1/2:1	5.4mm	13	Straight	79mm	White	1.36ml
MA5.4-17S	1:1/2:1	5.4mm	17	Stepped	104mm	White	1.68ml
MA5.4-21S	1:1/2:1	5.4mm	21	Stepped	124mm	White	2.01ml
MA6.3-12S	1:1/2:1	6.3mm	12	Stepped	97mm	White	2.08ml
MA6.3-17S	1:1/2:1	6.3mm	17	Stepped	128mm	White	2.94ml
MA6.3-21S	1:1/2:1	6.3mm	21	Stepped	153mm	White	3.57ml
MA6.3-21L	1:1/2:1	6.3mm	21	Luer	151mm	White	3.33ml
MAQ05-16L	1:1/2:1	5.3mm	16	Luer	83mm	Green	1.30ml
MAQ05-24L	1:1/2:1	5.3mm	24	Luer	115mm	Green	1.90ml
MAHX04-17S	4:1/10:1	4.0mm	17	Tapered	81.6mm	Orange	0.75ml
MAHX05-17T	4:1/10:1	5.0mm	17	Stepped	104mm	Orange	1.68ml



## Two component cartridges and mixer nozzles



### B System Manual Dual Cartridges

The B system small capacity cartridges offer advantages over the original A system by utilizing separated outlet ports to that prevent cross-contamination and allow for efficient resealing of the cartridge. The range is further complimented with options for the piston sealing arrangement and materials. Polypropylene bodies. Supplied as complete sets.

Part Code	Ratio	Capacity	Material	Plunger	Type
250001B-01	1:1	25ml	PP White	Vented	Manual Assembly
250001B-02	1:1	25ml	PP White	EPDM O-ring	Manual Assembly
116647	1:1	25ml	PP White	Natural	Manual Assembly
116924	1:1	25ml	PP White	Black	Manual Assembly
116925	1:1	25ml	PP White	Yellow	Manual Assembly
116926	1:1	25ml	PP White	Blue	Manual Assembly
116927	1:1	25ml	PP Black	Black	Manual Assembly
116649	1:1	25ml	PA White	Natural	Manual Assembly
116923	1:1	25ml	PA Black	Black	Manual Assembly



### B System Dual Cartridges

B System cartridge sets for use with manual, pneumatic and battery powered applicator guns. Oval shape are the S-Type cartridges. All other types have the standard rectangular top shape.

Part Code	Ratio	Capacity	Material	Piston Style
112511	1:1	50ml	PP White	Self Venting
116347	1:1	50ml	PP White	EPDM O-ring
116357	1:1	50ml	PA White	Self Venting
116358	1:1	50ml	PA White	Lip Seal
114099	2:1	50ml	PP White	Self Venting
116342	2:1	50ml	PP White	Lip Seal
116354	2:1	50ml	PA White	Self Venting
116356	2:1	50ml	PA White	Lip Seal
116421	4:1	50ml	PP White	Self Venting
116422	4:1	50ml	PBT Natural	Self Venting
116423	10:1	50ml	PP White	Self Venting
116424	10:1	50ml	PBT Natural	Self Venting
116373	10:1 Oval	50ml	PBT Natural	Self Venting
116805	10:1 Oval	50ml	PBT Natural	EPDM O-ring
116449	10:1 Oval	75ml	PBT Natural	EPDM O-ring



### B System Static Mixer Nozzles

High density cap top static mixer nozzles for use with B Series twin 50ml dual cartridges. Suitable for most two-component materials. Constructed of high grade polypropylene. Industrial grade and silicone free materials.

Part Code	Ratio	ID	Element	Outlet	Length	Colour	Volume
MBH03-12S	1:1/2:1	3.2mm	12	Tapered	64mm	White	0.49ml
MBH03-12D	1:1/2:1	3.2mm	12	Straight	58mm	White	0.49ml
MBH03-16S	1:1/2:1	3.2mm	16	Tapered	76mm	White	0.59ml
MBH03-16L	1:1/2:1	3.2mm	16	Luer	76mm	White	0.63ml
MBH03-16D	1:1/2:1	3.2mm	16	Straight	71mm	White	0.63ml
MBH04-12D	1:1/2:1	4.2mm	12	Straight	70mm	White	0.84ml
MBH04-16S	1:1/2:1	4.2mm	16	Tapered	96mm	White	1.04ml
MBH04-16D	1:1/2:1	4.2mm	16	Straight	87mm	White	1.04ml
MBH05-06T	1:1/2:1	5.4mm	6	Stepped	59.3mm	White	0.94ml
MBH05-12D	1:1/2:1	5.4mm	12	Straight	82.5mm	White	1.52ml
MBH05-14D	1:1/2:1	5.4mm	14	Straight	112mm	White	1.91ml
MBH05-16T	1:1/2:1	5.4mm	16	Stepped	112mm	White	1.91ml
MBH05-20T	1:1/2:1	5.4mm	20	Stepped	133mm	White	2.29ml
MBH06-11D	1:1/2:1	6.5mm	11	Straight	88.5mm	White	2.28ml
MBH06-16T	1:1/2:1	6.5mm	16	Stepped	131mm	White	3.14ml
MBH06-20T	1:1/2:1	6.5mm	20	Stepped	157mm	White	3.76ml
MBHX03-16S	4:1/10:1	3.2mm	16	Tapered	77mm	Orange	0.60ml
MBHX04-16S	4:1/10:1	4.2mm	16	Tapered	96mm	Orange	1.05ml
MBHX05-16T	4:1/10:1	5.4mm	16	Stepped	111mm	Orange	1.91ml
MBHX05-20T	4:1/10:1	5.4mm	20	Stepped	133mm	Orange	2.07ml
MBHX06-16T	4:1/10:1	6.5mm	16	Stepped	131mm	Orange	3.04ml
MBHX06-20T	4:1/10:1	6.5mm	20	Stepped	157mm	Orange	3.79ml
MBQ05-16L	1:1/2:1	5.3mm	16	Luer	91mm	Green	1.88ml
MBQ05-24L	1:1/2:1	5.3mm	24	Luer	122mm	Green	2.60ml
MBQX05-16L	4:1/10:1	5.3mm	16	Luer	91mm	Orange	1.72ml
MBQX05-24L	4:1/10:1	5.3mm	24	Luer	122mm	Orange	2.37ml



### K System Manual Dual Syringes

The K-System meets the growing demand for reliable, safe, easy to use selection of dual dispensers for 2-K adhesives. Thanks to a range of mixing ratios, materials and colors, the K-System is suitable both for industry as well as DIY users. Its modular concept offers a broad choice of mixers and attachable accessories. Please note that 3ml version comes with plunger and mix nozzle. All other versions allow you to select plungers separately.

Part Code	Ratio	Capacity	Material	Piston Style	Plunger
116436	1:1	2.5ml	PP White	Lip Seal	103128
116437	1:1	2.5ml	PP White	EPDM O-ring	103128
301634	1:1	3ml	PP Clear	Lip Seal	Included
116438	1:1	5ml	PP White	Lip Seal	113403
116439	1:1	5ml	PP White	EPDM O-ring	113403
116440	1:1	10ml	PP White	Lip Seal	113401
116441	1:1	10ml	PP White	EPDM O-ring	113401
116442	10:1	10ml	PP White	Lip Seal	113371
116435	10:1	10ml	PP White	EPDM O-ring	113371
116571	10:1	10ml	PBT White	Lip Seal	113371



### K System Static Mixer Nozzles

High density cap top static mixer nozzles for use with K Series twin dual syringes. Suitable for most two-component materials. Constructed of high grade polypropylene. Industrial grade and silicone free materials.

Part Code	Ratio	ID	Element	Outlet	Length	Colour	Volume
114252	1:1	2.5mm	8	Straight	33.4mm	White	0.14ml
114246	1:1	2.5mm	8	Tapered	39.7mm	White	0.19ml
114253	1:1	2.5mm	12	Straight	46.2mm	White	0.23ml
114249	1:1	2.5mm	12	Tapered	49.7mm	White	0.23ml
115686	1:1	2.5mm	16	Tapered	59.7mm	White	0.27ml
114243	1:1	3.2mm	12	Straight	56.0mm	White	0.39ml
114250	1:1	3.2mm	12	Tapered	61.0mm	White	0.39ml
114251	1:1	3.2mm	16	Tapered	74.0mm	White	0.49ml
114260	10:1	2.5mm	8	Straight	36.2mm	Orange	0.19ml
114255	10:1	2.5mm	8	Tapered	39.7mm	Orange	0.19ml
114261	10:1	2.5mm	12	Straight	46.2mm	Orange	0.23ml
114256	10:1	2.5mm	12	Tapered	49.7mm	Orange	0.23ml
114257	10:1	2.5mm	16	Tapered	59.7mm	Orange	0.27ml
114262	10:1	3.2mm	12	Straight	56.0mm	Orange	0.39ml
114258	10:1	3.2mm	12	Tapered	61.0mm	Orange	0.39ml
114259	10:1	3.2mm	16	Tapered	74.0mm	Orange	0.49ml



### C System Dual Cartridges and Mixer Nozzles

The C system industrial cartridge is a long established proven design with a range of dispensing ratios available. The complete range of static mixing nozzles are listed below, all featuring a bell mouth nose interface that is fixed in leak free using the cartridge locking cap. Cartridge sizes of 200ml and 400ml in 4 mix ratios. Mix nozzles white element for 1:1/2:1 and orange for 4:1/10:1 or green square Quadro type.

Part Code	Ratio	Capacity	Material	Piston Style	Part Code	Ratios	ID	EL.	Length	Colour	Volume
422026	1:1	200ml	PP White	Self Venting	MC03-08	1:1/2:1	3.0mm	8	38mm	White	0.19ml
422001	2:1	200ml	PP White	Self Venting	MC05-18	1:1/2:1	5.0mm	18	122mm	White	2.10ml
422401	4:1	200ml	PP White	Self Venting	MC05-24	1:1/2:1	5.0mm	24	150mm	White	2.30ml
422033	10:1	200ml	PP White	Self Venting	MC06-18	1:1/2:1	6.0mm	18	150mm	White	3.60ml
400011	1:1	400ml	PP White	Self Venting	MC06-24	1:1/2:1	6.0mm	24	187mm	White	4.20ml
400021	2:1	400ml	PP White	Self Venting	MC06-32	1:1/2:1	6.0mm	32	234mm	White	5.00ml
400041	4:1	400ml	PP White	Self Venting	MC08-18	1:1/2:1	8.0mm	18	178mm	White	6.70ml
400101	10:1	400ml	PP White	Self Venting	MC08-24	1:1/2:1	8.0mm	24	225mm	White	8.50ml
600011	1:1	600ml	PP White	Self Venting	MC08-32	1:1/2:1	8.0mm	32	287mm	White	10.9ml
					MC10-18	1:1/2:1	10.0mm	18	215mm	White	12.3ml
					MC10-24	1:1/2:1	10.0mm	24	277mm	White	14.6ml
					MC10-32	1:1/2:1	10.0mm	32	352mm	White	17.7ml
					MC13-12	1:1/2:1	13.0mm	12	170mm	White	14.7ml
					MC13-24	1:1/2:1	13.0mm	24	294mm	White	27.3ml
					MC13-32	1:1/2:1	13.0mm	32	379mm	White	35.7ml
					MCHX08-18	4:1/10:1	8.0mm	18	183mm	Orange	6.40ml
					MCHX08-24	4:1/10:1	8.0mm	24	231mm	Orange	9.30ml
					MCHX10-12	4:1/10:1	10.0mm	12	157mm	Orange	9.60ml
					MCHX10-18	4:1/10:1	10.0mm	18	216mm	Orange	11.9ml
					MCHX10-24	4:1/10:1	10.0mm	24	276mm	Orange	16.2ml
					MCHX13-12	4:1/10:1	13.0mm	12	192mm	Orange	11.6ml
					MCHX15-12	4:1/10:1	15.0mm	12	196mm	Orange	27.0ml





## Two component cartridges and mixer nozzles



### C System Bell Mouth Quadro Mixer Nozzles MCQ Series

Bell Mouth Quadro Static mixers for 1:1, 2:1, ratio C System cartridges. Green mix elements, square shape natural polypro body and bell mouth housing. Use with the C-System 200ml, 400ml and 600ml dual cartridges.

Part Code	Ratios	ID	No.	Length	Volume
MCQ05-24L	1:1/2:1	5.3mm	24	127mm	3.46ml
MCQ07-24T	1:1/2:1	7.5mm	24	130mm	6.19ml
MCQ08-24T	1:1/2:1	8.7mm	24	147mm	8.44ml
MCQ08-32T	1:1/2:1	8.7mm	32	186mm	10.37ml
MCQ10-24T	1:1/2:1	10.7mm	24	172mm	14.04ml
MCQ10-32T	1:1/2:1	10.7mm	32	220mm	18.45ml



### C System Screw Thread Quadro Mixer Nozzles MGQ Series

Threaded Quadro Static mixers for 1:1, 2:1, ratio C System cartridges. Green mix elements, square shape natural polypro body and screw thread housing. Use with the C-System 200ml, 400ml and 600ml dual cartridges.

Part Code	Ratios	ID	No.	Length	Volume
MGQ08-18T	1:1/2:1/4:1/10:1	8.7mm	18	129mm	6.70ml
MGQ08-20D	1:1/2:1/4:1/10:1	8.7mm	20	142mm	7.57ml
MGQ08-20T	1:1/2:1/4:1/10:1	8.7mm	20	142mm	7.34ml
MGQ08-24D	1:1/2:1/4:1/10:1	8.7mm	24	161mm	8.61ml
MGQ08-24T	1:1/2:1/4:1/10:1	8.7mm	24	161mm	8.76ml
MGQ10-16D	1:1/2:1/4:1/10:1	10.7mm	16	158mm	12.69ml
MGQ10-19D	1:1/2:1/4:1/10:1	10.7mm	19	158mm	12.15ml
MGQ10-24D	1:1/2:1/4:1/10:1	10.7mm	24	187mm	14.49ml



### C System Screw Thread Mixer Nozzles MGH Series

Mixer helix with screw connection for C System cartridges. For 1:1, 2:1, ratio C System cartridges. Please note these can also be used with 4:1 and 10:1 ratio cartridges.

Part Code	Ratios	ID	No.	Length	Volume
MGH08-06S	1:1/2:1/4:1/10:1	8.0mm	6	109mm	3.68ml
MGH1008-12	1:1/2:1/4:1/10:1	8.0mm	12	217mm	10.3ml
MGH1008-18	1:1/2:1/4:1/10:1	8.0mm	18	217mm	9.99ml



### F System Dual Cartridges and Mixer Nozzles

The F system industrial cartridge is the latest technology for 200ml and 400ml side by side dispensing. Available in four different dispensing ratios from 1:1 through to 10:1. Using port outlet technology, cross contamination is kept to a minimum allowing for simple and reliable re-sealing of part used product. The complete range of static mixing nozzles are listed below the cartridges, all featuring matching port profiles.

Part Code	Ratio	Capacity	Material	Piston Style
AF200-01-10-01	1:1	210ml	PP White	Self Venting
AF200-02-10-01	2:1	215ml	PP White	Self Venting
AF200-04-10-01	4:1	225ml	PP White	Self Venting
AF200-10-10-01	10:1	250ml	PP White	Self Venting
AF400-01-10-01	1:1	395ml	PP White	Self Venting
AF400-02-10-01	2:1	400ml	PP White	Self Venting
AF400-04-10-01	4:1	415ml	PP White	Self Venting
AF400-10-10-01	10:1	490ml	PP White	Self Venting
AD1500-01-10-01	1:1	1500ml	PP White	Self Venting



Part Code	Ratios	ID	EL	Length	Colour	Volume
MFH06-18T	1:1/2:1	6.0mm	18	156mm	White	4.36ml
MFH06-24T	1:1/2:1	6.0mm	24	194mm	White	5.40ml
MFH06-32T	1:1/2:1	6.0mm	32	245mm	White	6.65ml
MFH08-18T	1:1/2:1	8.0mm	18	187mm	White	7.40ml
MFH08-24T	1:1/2:1	8.0mm	24	234mm	White	9.30ml
MFH08-32T	1:1/2:1	8.0mm	32	297mm	White	11.85ml
MFH10-18T	1:1/2:1	10.0mm	18	224mm	White	13.09ml
MFH10-24T	1:1/2:1	10.0mm	24	283mm	White	16.89ml
MFH10-32T	1:1/2:1	10.0mm	32	362mm	White	21.94ml
MFHX06-18T	4:1/10:1	6.0mm	18	156mm	Orange	4.16ml
MFHX06-24T	4:1/10:1	6.0mm	24	194mm	Orange	5.20ml
MFHX06-32T	4:1/10:1	6.0mm	32	245mm	Orange	6.56ml
MFHX08-18T	4:1/10:1	8.0mm	18	187mm	Orange	7.28ml
MFHX08-24T	4:1/10:1	8.0mm	24	234mm	Orange	9.14ml
MFHX08-32T	4:1/10:1	8.0mm	32	296mm	Orange	11.55ml
MFHX10-18T	4:1/10:1	10.0mm	18	224mm	Orange	12.96ml
MFHX10-24T	4:1/10:1	10.0mm	24	283mm	Orange	16.70ml
MFHX10-32T	4:1/10:1	10.0mm	32	363mm	Orange	21.22ml



### F System Cap Quadro Mixer Nozzles MFQ Series

Mixer helix with dual hole connection for F System cartridges. For 1, 2:1, 4:1 and 10:1 ratio F System cartridges. White top mixers for 1:1/2:1 ratio, orange top for 4:1/10:1 ratio. Quadro square bodied mixer nozzles. All mixers have green elements. Parts with "T" have a stepped tip outlet. Parts with "L" have a luer tip.

Part Code	Ratios	ID	EL	Length	Colour	Volume
MFQ05-16L	1:1/2:1	5.3mm	16	100mm	White	2.9ml
MFQ05-24L	1:1/2:1	5.3mm	24	132mm	White	3.52ml
MFQ07-24T	1:1/2:1	7.5mm	24	137mm	White	6.11ml
MFQ08-24T	1:1/2:1	8.7mm	24	155mm	White	8.69ml
MFQ10-24T	1:1/2:1	10.7mm	24	181mm	White	14.75ml
MFQX05-16L	4:1/10:1	5.3mm	16	101mm	Orange	3.07ml
MFQX05-24L	4:1/10:1	5.3mm	24	132mm	Orange	3.69ml
MFQX07-24T	4:1/10:1	7.5mm	24	137mm	Orange	6.28ml
MFQX08-24T	4:1/10:1	8.7mm	24	155mm	Orange	8.86ml
MFQX10-24T	4:1/10:1	10.7mm	24	181mm	Orange	14.92ml



### Mixpac Cartridge Converter Fittings

Fitting adapters that convert the B-System cartridges to accept K-System mixers and F-System cartridges to accept B-System mixers.



Part Code	Item	Description	Mix Ratio
128201	IBK 001-10	Interface Converter B- to K- System PP Natural	1:1/2:1
128202	IBKX 001-10	Interface Converter B- to K- System PP Orange	4:1/10:1
116803	IFB 001-10	Interface Converter F- to B- System PP Natural	1:1/2:1
116804	IFBX 001-10	Interface Converter F- to B- System PP Orange	4:1/10:1

### J System Dual Cartridges and Mixer Nozzles

The J system industrial cartridge is a long established proven design with a range of dispensing ratios available. The complete range of static mixing nozzles are listed below, all featuring a bell mouth nose interface that is fixed in leak free using the cartridge locking cap. Cartridge sizes from 235ml to 400ml size. Mix nozzles white element for 1:1/2:1 and orange for 4:1/10:1 or green square Quadro type

Part Code	Ratio	Capacity	Material	Piston Style
J-235-10	10:1	235ml	PP White	Self Venting
J-350-10	10:1	350ml	PP White	Self Venting
J-600-1	1:1	600ml	PP White	Self Venting
J-825-10	10:1	825ml	PP White	Self Venting
J-1500-1	1:1	1500ml	PP White	Self Venting

Part Code	Ratios	ID	EL	Length	Colour	Volume
MC03-08	1:1/2:1	3.0mm	8	38mm	White	0.19ml
MC05-18	1:1/2:1	5.0mm	18	122mm	White	2.10ml
MC05-24	1:1/2:1	5.0mm	24	150mm	White	2.30ml
MC06-18	1:1/2:1	6.0mm	18	150mm	White	3.60ml
MC06-24	1:1/2:1	6.0mm	24	187mm	White	4.20ml
MC06-32	1:1/2:1	6.0mm	32	234mm	White	5.00ml
MC08-18	1:1/2:1	8.0mm	18	178mm	White	6.70ml
MC08-24	1:1/2:1	8.0mm	24	225mm	White	8.50ml
MC08-32	1:1/2:1	8.0mm <td 32	287mm	White	10.9ml	
MC10-18	1:1/2:1	10.0mm	18	215mm	White	12.3ml
MC10-24	1:1/2:1	10.0mm	24	277mm	White	14.6ml
MC10-32	1:1/2:1	10.0mm	32	352mm	White	17.7ml
MC13-12	1:1/2:1	13.0mm	12	170mm	White	14.7ml
MC13-24	1:1/2:1	13.0mm	24	294mm	White	27.3ml
MC13-32	1:1/2:1	13.0mm	32	379mm	White	35.7ml
MCHX08-18	4:1/10:1	8.0mm	18	183mm	Orange	6.40ml
MCHX08-24	4:1/10:1	8.0mm	24	231mm	Orange	9.30ml
MCHX10-12	4:1/10:1	10.0mm	12	157mm	Orange	9.60ml
MCHX10-18	4:1/10:1	10.0mm	18	216mm	Orange	11.9ml
MCHX10-24	4:1/10:1	10.0mm	24	276mm	Orange	16.2ml
MCHX13-12	4:1/10:1	13.0mm	12	192mm	Orange	11.6ml
MCHX15-12	4:1/10:1	15.0mm	12	196mm	Orange	27.0ml



## Two component machine mixer nozzles

## Bell Mouth Machine Mixer Nozzles MS Series

Bell Mouth static mixers for bulk mixing machines. Yellow mix elements, round cylinder shape natural polypro body and bell mouth housing. Use with high pressure machines. Housing diameter of 16.7mm.

Part Code	Article	ID	Element	Outlet	Length	Style	Max Pressure
MS05-24T	102503	5.0mm	24	1.5mm	149mm	Stepped	33 Bar
MS05-32T	102504	5.0mm	32	1.5mm	188mm	Stepped	33 Bar
MS06-24T	102505	6.4mm	24	1.8mm	186mm	Stepped	30 Bar
MS06-32T	102506	6.4mm	32	1.8mm	235mm	Stepped	30 Bar
MS06-48T	102507	6.4mm	48	2.4mm	334mm	Stepped	30 Bar
MS06-56L	102509	6.4mm	56	4.5mm	378mm	Luer	30 Bar
MS06-56D	102508	6.4mm	56	4.5mm	378mm	Straight	30 Bar
MS08-24T	102510	8.0mm	24	2.4mm	223mm	Stepped	27 Bar
MS08-32T	102511	8.0mm	32	2.4mm	289mm	Stepped	27 Bar
MS10-18T	102513	10.0mm	18	3.0mm	214mm	Stepped	22 Bar
MS10-24T	102514	10.0mm	24	3.0mm	276mm	Stepped	22 Bar
MS10-32T	102515	10.0mm	32	3.0mm	355mm	Stepped	22 Bar
MS13-12G	113743	13.0mm	12	10mm	159mm	Thread	17 Bar
MS13-18G	102517	13.0mm	18	10mm	223mm	Thread	17 Bar
MS13-24T	102518	13.0mm	24	4.0mm	293mm	Stepped	17 Bar
MS13-32T	102520	13.0mm	32	4.0mm	378mm	Stepped	17 Bar



## Bell Mouth Machine Mixer Nozzles ME Series

Bell Mouth static mixers for bulk mixing machines. Blue mix elements, round cylinder shape natural polypro body and bell mouth housing. Use with high pressure machines. Housing diameter of 15.9mm.

Part Code	Article	ID	Element	Outlet	Length	Style	Max Pressure
ME05-24T	102448	5.0mm	24	1.5mm	149mm	Stepped	33 Bar
ME05-32T	102449	5.0mm	32	1.5mm	188mm	Stepped	33 Bar
ME06-24T	102450	6.4mm	24	1.8mm	186mm	Stepped	30 Bar
ME06-32T	102451	6.4mm	32	1.8mm	235mm	Stepped	30 Bar
ME06-48T	102452	6.4mm	48	2.4mm	334mm	Stepped	30 Bar
ME08-24T	102453	8.0mm	24	2.4mm	223mm	Stepped	27 Bar
ME08-32T	102454	8.0mm	32	2.4mm	289mm	Stepped	27 Bar
ME10-24T	102456	10.0mm	24	3.0mm	276mm	Stepped	22 Bar
ME10-32T	102457	10.0mm	32	3.0mm	355mm	Stepped	22 Bar
ME13-24T	102459	13.0mm	24	4.0mm	293mm	Stepped	17 Bar
ME13-32T	102461	13.0mm	32	4.0mm	378mm	Stepped	17 Bar



## F Interface Machine Mixer Nozzles MEF Series

F-Interface static mixers for bulk mixing machines. Blue mix elements, round cylinder shape natural polypro body and F system blue housing. Use with high pressure machines. Housing diameter of 15.9mm. For 1:1 and 2:1 mix ratios.

Part Code	Article	ID	Element	Outlet	Length	Style	Max Pressure
MEF06-24T	110591	6.4mm	24	1.8mm	195mm	Stepped	30 Bar
MEF06-32T	111666	6.4mm	32	1.8mm	245mm	Stepped	30 Bar
MEF08-24T	110592	8.0mm	24	2.4mm	235mm	Stepped	27 Bar
MEF08-32T	102463	8.0mm	32	2.4mm	299mm	Stepped	27 Bar
MEF10-24T	102464	10.0mm	24	3.0mm	280mm	Stepped	22 Bar
MEF10-32T	102465	10.0mm	32	3.0mm	360mm	Stepped	22 Bar
MEF13-18T	114327	13.0mm	18	4.0mm	235mm	Stepped	17 Bar
MEF13-24T	114330	13.0mm	24	4.0mm	296mm	Stepped	17 Bar



## F Interface Machine Mixer Nozzles MEFX Series

F-Interface static mixers for bulk mixing machines. Blue mix elements, round cylinder shape natural polypro body and F system orange housing. Use with high pressure machines. Housing diameter of 15.9mm. For 4:1 and 10:1 mix ratios.

Part Code	Article	ID	Element	Outlet	Length	Style	Max Pressure
MEFX06-18T	110737	6.4mm	18	1.8mm	157mm	Stepped	30 Bar
MEFX08-18T	110738	8.0mm	18	2.4mm	184mm	Stepped	27 Bar
MEFX10-18T	110971	9.9mm	18	3.0mm	222mm	Stepped	22 Bar
MEFX13-18T	114331	13.0mm	18	4.0mm	235mm	Stepped	17 Bar
MEFX13-24T	114326	13.0mm	24	4.0mm	296mm	Stepped	17 Bar



**Important:** For health and safety reasons, Statomix SH Series safety shrouds must be used at all times with machine mixers.



### Bell Mouth Rotary Machine Mixer Nozzles MR Series

Bell Mouth static mixers for bulk mixing machines dispensing low viscosity reactive resins. Green mix elements, round cylinder shape natural polypropylene body and bell mouth housing. Use with high pressure machines. Housing diameter of 16.7mm.

Part Code	Article	ID	Element	Outlet	Length	Style	Max Pressure
MSR06-12T	102499	6.4mm	12	1.8mm	112mm	Stepped	30 Bar
MSR08-12T	102500	8.0mm	12	2.4mm	130mm	Stepped	27 Bar
MSR10-12T	102501	10.0mm	12	3.0mm	155mm	Stepped	22 Bar
MSR13-12T	102502	13.0mm	18	4.0mm	197mm	Stepped	17 Bar



### Statomix Shrouds Industrial for MS Mixers

High quality safety shrouds for Statomix type MS mixers used on bulk dispensing machines. High pressures, which are associated with dispensing equipment, require the use of safety shrouds. For safety reasons, shrouds must be used at all times. Supplied each.

Part Code	Article	Description	ID	OD	Length
SH08-24-14	114337	Aluminium alloy, anodized, nut across flats 27mm (1 1/16"), optional fitting 7/8"-14 UNC thread	12.2mm	16.0mm	215mm
SH08-32-14	114342	Aluminium alloy, anodized, nut across flats 27mm (1 1/16"), optional fitting 7/8"-14 UNC thread	12.2mm	16.0mm	279mm
SH10-24-14	114338	Aluminium alloy, anodized, nut across flats 27mm (1 1/16"), optional fitting 7/8"-14 UNC thread	14.2mm	19.0mm	266mm
SH10-32-14	114343	Aluminium alloy, anodized, nut across flats 27mm (1 1/16"), optional fitting 7/8"-14 UNC thread	14.2mm	19.0mm	342mm
SH13-24-14	114367	Aluminium alloy, anodized, nut across flats 27mm (1 1/16"), optional fitting 7/8"-14 UNC thread	17.2mm	23.0mm	281mm
SH13-32-14	114369	Aluminium alloy, anodized, nut across flats 27mm (1 1/16"), optional fitting 7/8"-14 UNC thread	17.2mm	23.0mm	366mm
SH10-44-14	114345	Aluminium alloy, anodized, nut across flats 27mm (1 1/16"), optional fitting 7/8"-14 UNC thread. For MS Combo mixer nozzle	14.2mm	19.0mm	401mm
SH13-44-14	114346	Aluminium alloy, anodized, nut across flats 27mm (1 1/16"), optional fitting 7/8"-14 UNC thread. For MS Combo mixer nozzle	17.2mm	23.0mm	503mm



### Statomix Shrouds Industrial for ME Mixers

High quality safety shrouds for Statomix type ME mixers used on bulk dispensing machines. High pressures, which are associated with dispensing equipment, require the use of safety shrouds. For safety reasons, shrouds must be used at all times. Supplied each.

Part Code	Article	Description	ID	OD	Length
SH05-24-09	114351	Aluminium alloy, anodized, nut across flats 27mm (1 1/16"), optional fitting 7/8"-9 UNC thread	8.2mm	11.5mm	146mm
SH05-32-09	114356	Aluminium alloy, anodized, nut across flats 27mm (1 1/16"), optional fitting 7/8"-9 UNC thread	8.2mm	11.5mm	185mm
SH06-24-09	114352	Aluminium alloy, anodized, nut across flats 27mm (1 1/16"), optional fitting 7/8"-9 UNC thread	10.2mm	14.0mm	180mm
SH06-32-09	114357	Aluminium alloy, anodized, nut across flats 27mm (1 1/16"), optional fitting 7/8"-9 UNC thread	10.2mm	14.0mm	229mm
SH06-48-09	114349	Aluminium alloy, anodized, nut across flats 27mm (1 1/16"), optional fitting 7/8"-9 UNC thread	10.7mm	15.0mm	329mm
SH06-56-09	114365	Aluminium alloy, anodized, nut across flats 27mm (1 1/16"), optional fitting 7/8"-9 UNC thread	10.7mm	15.0mm	384mm
SH08-24-09	114353	Aluminium alloy, anodized, nut across flats 27mm (1 1/16"), optional fitting 7/8"-9 UNC thread	12.2mm	16.0mm	215mm
SH08-32-09	114358	Aluminium alloy, anodized, nut across flats 27mm (1 1/16"), optional fitting 7/8"-9 UNC thread	12.2mm	16.0mm	279mm
SH10-24-09	114354	Aluminium alloy, anodized, nut across flats 27mm (1 1/16"), optional fitting 7/8"-9 UNC thread	14.2mm	19.0mm	266mm
SH10-32-09	114349	Aluminium alloy, anodized, nut across flats 27mm (1 1/16"), optional fitting 7/8"-9 UNC thread	14.2mm	19.0mm	342mm
SH13-24-09	114366	Aluminium alloy, anodized, nut across flats 27mm (1 1/16"), optional fitting 7/8"-9 UNC thread	17.2mm	23.0mm	281mm
SH13-32-09	114368	Aluminium alloy, anodized, nut across flats 27mm (1 1/16"), optional fitting 7/8"-9 UNC thread	17.2mm	23.0mm	366mm
SH10-44-09	114362	Aluminium alloy, anodized, nut across flats 27mm (1 1/16"), optional fitting 7/8"-9 UNC thread	14.2mm	19.0mm	401mm
SH13-44-09	114364	Aluminium alloy, anodized, nut across flats 27mm (1 1/16"), optional fitting 7/8"-9 UNC thread	17.2mm	23.0mm	503mm



## Two component machine mixer nozzles and shrouds



### Statomix Shrouds Industrial for MEF Mixers

High quality safety shrouds for Statomix type MEF mixers used on bulk dispensing machines. High pressures, which are associated with dispensing equipment, require the use of safety shrouds. For safety reasons, shrouds must be used at all times. Supplied each.

Part Code	Article	Description	ID	OD	Length
SH06-18MF	114376	Aluminium alloy, anodized, nut across flats 36mm (1 7/16"), optional fitting TR 32x6 double thread	10.2mm	14.0mm	148mm
SH06-24MF	114375	Aluminium alloy, anodized, nut across flats 36mm (1 7/16"), optional fitting TR 32x6 double thread	10.2mm	14.0mm	186mm
SH06-32MF	114733	Aluminium alloy, anodized, nut across flats 36mm (1 7/16"), optional fitting TR 32x6 double thread	10.2mm	14.0mm	237mm
SH08-18MF	114382	Aluminium alloy, anodized, nut across flats 36mm (1 7/16"), optional fitting TR 32x6 double thread	12.2mm	16.0mm	180mm
SH08-24MF	114377	Aluminium alloy, anodized, nut across flats 36mm (1 7/16"), optional fitting TR 32x6 double thread	12.2mm	16.0mm	224mm
SH08-32MF	114378	Aluminium alloy, anodized, nut across flats 36mm (1 7/16"), optional fitting TR 32x6 double thread	12.2mm	16.0mm	287mm
SH10-18MF	114379	Aluminium alloy, anodized, nut across flats 36mm (1 7/16"), optional fitting TR 32x6 double thread	14.2mm	19.0mm	214mm
SH10-24MF	114380	Aluminium alloy, anodized, nut across flats 36mm (1 7/16"), optional fitting TR 32x6 double thread	14.2mm	19.0mm	274mm
SH10-32MF	114381	Aluminium alloy, anodized, nut across flats 36mm (1 7/16"), optional fitting TR 32x6 double thread	14.2mm	19.0mm	353mm
SH13-18MF	116074	Aluminium alloy, anodized, nut across flats 36mm (1 7/16"), optional fitting TR 32x6 double thread	17.2mm	23.0mm	221mm
SH13-24MF	116072	Aluminium alloy, anodized, nut across flats 36mm (1 7/16"), optional fitting TR 32x6 double thread	17.2mm	23.0mm	282mm



**Important: For health and safety reasons, Statomix SH Series safety shrouds must be used at all times with machine mixers.**

### Pneumatic 50ml Dual Cartridge Retainer System

This device fits to any air-powered benchtop dispenser with vacuum suckback. For use with 50ml dual component cartridges in mix ratios of 1:1, 2:1, 4:1 and 10:1 (\* roundback oval version). Provides steady control either by hand or when attached to a robot. Lightweight (425g) yet robust. Works to a maximum of 100 PSI.

Part Code	Ratio	Length	Width	Materials
ADV-50-11	1:1	160mm	54mm	Stainless Steel/ Aluminium
ADV-50-21	2:1	160mm	54mm	Stainless Steel/ Aluminium
ADV-50-41	4:1	160mm	54mm	Stainless Steel/ Aluminium
ADV-50-101	10:1 *	160mm	54mm	Stainless Steel/ Aluminium



### Mix Nozzle and Dual Cartridge Accessories

Mixer nozzle luer lock tip converter fittings. Threads to mixer allowing tip attachment.



Part Code	Size	Colour
LA05-00	5mm	White
LA06-08	6-8mm	Grey
LA10-00	10mm	Black

Retaining nut for static mixer nozzles onto dual cartridges up to 13mm diameter.



Part Code	Size	Colour
UM10-PA	<10mm	Clear
UM13-PA	<13mm	Clear

Ribbon spreader nozzle for 1.5" wide bead from 3/8" x 20 or 24 element static mixers.



Part Code	Width	Mixer Series	Mixer ID
BSDQ08-38	38mm	MCQ, MF, MFQX	8
BSD08-50	50mm	MH, MHX	8
BSD10-25	25mm	MCH, MCHX	10
BSD10-40	40mm	MCH, MCHX	10
BSD13-50	50mm	MCH, MCHX	13
TS10-ET	2.5mm	MFH, MFHX	10
TC10-ET	2.5mm	MFH, MFHX	10

Fittings and accessories are supplied in sealed packs of (10) pieces. Bulk quantities available on request.

### Analog Timed Shot Peristaltic Pump

Air-free benchtop dispensers for applying low viscosity liquids and adhesives such as Cyanoacrylate, UV cure adhesives, solvents, etc. Does not require compressed air to operate, action on the PTFE tube creates force to draw the liquid directly from the bottle. Supplied with PTFE tubing in a range of diameters and an electric wand with button or foot switch. Adjustable timers for shot size control. 110V versions available on request. These machines are ideal for CA applications or most liquids up to a viscosity of 10,000 cps.



Forward Timer: 0.01-99 Second  
 Reverse Timer: 0.01-99 Second  
 Min. Dot Size: 0.0001cc/ml  
 Dimensions: 192x182x07mm  
 Weight: 3.70kg  
 Cycle Rate: 0.001-99 Second  
 Voltage: 220V AC

Type	Part Code
Peristaltic Pump, Analog	DISP5500

Air-free benchtop dispenser with digital LED display. All dispensers are CE approved with 1 Year Warranty.



Forward Timer: 0.01-99 Second  
 Reverse Timer: 0.01-99 Second  
 Min. Dot Size: 0.0001cc/ml  
 Dimensions: 180x171x82mm  
 Weight: 2.85kg  
 Cycle Rate: 0.001-99 Second  
 Voltage: 220V AC

Type	Part Code
Peristaltic Pump, Digital	DISP5600

### PTFE Tubing for Peristaltic Pumps

Flexible PTFE Teflon tubing for use with air-free peristaltic pump dispensers. Easy to cut - supplied by the 10 metre length. Silicone-free.

Part Code	Gauge	ID	OD	Length	Colour
TT-10G	10	2.69mm	3.29mm	10 Metre	White
TT-11G	11	2.41mm	3.01mm	10 Metre	White
TT-12G	12	2.16mm	2.76mm	10 Metre	White
TT-13G	13	1.93mm	2.53mm	10 Metre	White
TT-14G	14	1.68mm	2.28mm	10 Metre	White
TT-15G	15	1.50mm	2.10mm	10 Metre	White
TT-16G	16	1.34mm	1.94mm	10 Metre	White
TT-17G	17	1.19mm	1.79mm	10 Metre	White
TT-18G	18	1.07mm	1.67mm	10 Metre	White
TT-19G	19	0.96mm	1.56mm	10 Metre	White
TT-20G	20	0.86mm	1.46mm	10 Metre	White
TT-21G	21	0.81mm	1.31mm	10 Metre	White
TT-22G	22	0.71mm	1.21mm	10 Metre	White
TT-23G	23	0.66mm	1.16mm	10 Metre	White
TT-10G	24	0.56mm	1.06mm	10 Metre	White
TT-10G	26	0.46mm	0.86mm	10 Metre	White
TT-10G	28	0.38mm	0.78mm	10 Metre	White
TT-10G	30	0.30mm	0.70mm	10 Metre	White



### Accessories for Peristaltic Pump

All pumps use an electric hand wand to make the deposit as standard but optional foot pedals are available. Replacement parts available.

Type	Part Code
Peristaltic Pump, Finger Wand	800-EFP
Replacement Wand Nozzle End	800EFP-END
Replacement Foot Switch	800-FSP



### Vacuum Pickup Tools

Vacuum pick & place pencils for hand placement of small components. Connect to regulated air supply or use TS350 bench dispenser. Soft silicone suction cups will not scratch or damage sensitive surfaces, equipment or parts. Can be used in temperatures from -55° C to 230° C.



Part Code	Description
TS8120	Manual Vacuum Pickup Tool
VPPE511-LF	Electric Vacuum Pickup Tool
VPP803-LF	Manual Vacuum Pickup Tool
TS1208	ESD Safe Vacuum Pickup Tool
VACKIT	Mixed Kit of Vac Rubber Cups
560046-NH	Pen for VPPE511-LF
560046	Pen for VPP803-LF



## Dispensing bottles and pens

### Luer Lock Bottles

Dispensing bottles with luer-lock caps accept all precision tips. Simple twist-on and twist-off tip attachment. Flexible plastic bottles to apply liquids and gels. These products are supplied in sealed packs and can be used with adhesives and other assembly fluids. Use a tip cap to seal off the bottle cap.

Size	Material	Type	Bottle & Cap	Bottle only	Cap only
1/4oz - 7.5ml	LDPE/ Nylon	Cylinder Style	AD25BC	AD25B	AD25C
1/2oz - 15ml	LDPE/ Nylon	Boston Round	AD50BC	AD50B	AD50C
3/4oz - 20ml	LDPE/ Nylon	Flat Shape	AD75BC	AD75B	AD75C
1oz - 30ml	LDPE/ Nylon	Concertina	AD1BC	n/a	n/a
1oz - 30ml	LDPE/ Nylon	Boston Round	AD1BCB	AD1B	AD1C
2oz - 60ml	LDPE/ Nylon	Boston Round	AD2BC	AD2B	AD2C
2oz - 60ml	LDPE/ Nylon	ESD Safe	AD2BC-ESD	n/a	n/a
4oz - 120ml	MDPE/ Nylon	Cylinder Style	AD4BC	AD4B	AD4C
4oz - 120ml	LDPE/ Nylon	Boston Round	AD4BC-LD	AD4B-LD	AD2C
8oz - 240ml	MDPE/ Nylon	Cylinder Style	AD8BC	AD8B	AD8C



### Touch Pump Bottles and Brushes

Touch-Pump Bottles provide an economic, clean & safe method of conveniently presenting a small reservoir of solvent, cleaner or alcohol. Fluid-ready for dipping a brush or wipe for an assembly, production or laboratory purpose. Ideal for PCB soldering operations & clean rooms. Prevents wasteful evaporation & contamination. Stainless steel lid & pump components for long life.

Part Code	Size	Type
5606026	100ml Touch Pump	Bottle Assembly
5606027	200ml Touch Pump	Bottle Assembly
5606029	260ml Touch Pump	Bottle Assembly
5701272	1/4" Wide Soft 6" Long	Brush
5701274	1/4" Wide Hard 6" Long	Brush
345BR	1/4" Wide Soft 3.25" Long	Brush
346BR	1/4" Wide Soft 6" Long	Brush
347BR	3/4" Wide Soft 6" Long	Brush
348BR	3/8" Wide Soft 6" Long	Brush
349BR	1/2" Wide Soft 6" Long	Brush
350BR	9/16" Wide Soft 6" Long	Brush
5701273	3/8" Wide Soft	Brush



### Spring Loaded Acrylic Nib Dispensing Pens

Liquid is placed into the pen body, a spring loaded cap is attached. When the nib is pressed against a surface, liquid flows. Lift nib from surface to instantly stop flow. Use with most watery liquids including fluxes, primers, activators, etc.



Size	Material	Pen and Cap
10ml	Plastic Body	FV-0100
10ml	ESD Aluminium	FV-0200
10ml	Aluminium	FPA-10
45ml	Plastic Body	FV-0600

Part Code	Material	Nib Type
381-8425-AC	Acrylic	Chisel
381-8425-AB	Acrylic	Bullet
381-8425-AP	Acrylic	Point
381-8425-PC	Polyester	Chisel
381-600-PB	Polyester	Blunt (FV-0600)

Replacement acrylic or polyester nibs for spring loaded pens and bottles. They push into the cap assembly.

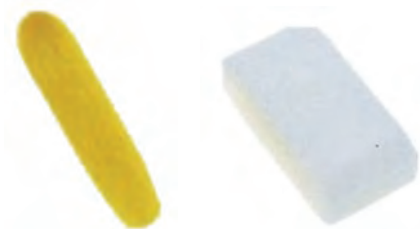

### Spring Loaded Acrylic Nib Dispensing Bottles

Liquid is placed into the bottle body, a spring loaded cap is attached. When the nib is pressed against a surface, liquid flows. Lift nib from surface to instantly stop flow. Use with most watery liquids including fluxes, primers, activators, etc.

Size	Material	Bottle & Cap	Cap only
2oz	Clear Plastic	FV-0300	n/a
2oz	ESD Aluminium	FV-0400	n/a
4oz	Clear Plastic	FV-0500	FV-0500-CAP



Precision valves will dispense accurate deposits with liquid fed under pressure from syringe barrels, cartridges or pressure pots. Valves operate with minimal maintenance, ensuring clean and accurate dispensing whether used by hand, to feed parts on a production line or if fixed onto an XYZ robot. Hand lever, air operated or motor driven valves.

### Manual Hand Operated Needle Valve

Hand held needle valve for precise beads applications of low to medium viscosity fluids. The hand lever opens the needle allowing fluids to flow; when it is released the needle closes. Doesn't require the use of a time/pressure dispenser. Direct fluid feed from a pressure pot, cartridge reservoir or syringe. Low cost solution for making controlled beads.

**Length:** 150mm  
**Width:** 18mm  
**Max Pressure:** 60psi  
**Viscosity:** 1-30k cps  
**Inlet:** 6mm OD  
**Outlet:** Male Luer  
**Wetted Parts:** Steel, Aluminium

#### Hand Operated Applicator

Part Code	Type
ADL2030	Boxed, with clear tubing

**Typical Applications:** UV cure, primers, solvents, inks, lubricants, resins.



### Manual Hand Operated Needle Valve

Hand held needle valve for precise beads applications of low to medium viscosity fluids. The hand lever opens the needle allowing fluids to flow; when it is released the needle closes. Doesn't require the use of a time/pressure dispenser. Direct fluid feed from a pressure pot, cartridge reservoir or syringe. Low cost solution for making controlled beads.

**Length:** 150mm  
**Width:** 22mm  
**Max Pressure:** 100psi  
**Viscosity:** 1-40k cps  
**Inlet:** 6mm OD  
**Outlet:** Male Luer  
**Wetted Parts:** Steel, Aluminium

#### Hand Operated Applicator

Part Code	Type
ADL2035	Boxed, with clear tubing

**Typical Applications:** UV cure, primers, solvents, inks, lubricants, resins.



### Manual Hand Operated Needle Valve

Hand held needle valve for precise beads applications of low to medium viscosity fluids. The hand lever opens the needle allowing fluids to flow; when it is released the needle closes. Doesn't require the use of a time/pressure dispenser. Direct fluid feed from a pressure pot, cartridge reservoir or syringe. Low cost solution for making controlled beads.

**Length:** 159mm  
**Width:** 25mm  
**Max Pressure:** 60psi  
**Viscosity:** 1-25k cps  
**Inlet:** 6mm OD  
**Outlet:** Male Luer  
**Wetted Parts:** Steel, Aluminium

#### Hand Operated Applicator

Part Code	Type
ADL2020	Boxed, with clear tubing

**Typical Applications:** UV cure, primers, solvents, inks, lubricants, resins.



### Manual Hand Operated Diaphragm Valve

Hand operated diaphragm valves for low to medium viscosity fluids such as cyanoacrylates, solvents, inks, UV cure, anaerobic, primers and activators. Takes a direct feed of fluid from a syringe, cartridge or pressure pot. UHMW/ Teflon for Cyanoacrylates, Delrin for UV cure.

**Length:** 99.1mm  
**Width:** 26.9mm  
**Max Pressure:** 100psi  
**Viscosity:** 1-50k cps  
**Inlet:** Female Luer  
**Outlet:** Male Luer  
**Wetted Parts:** UHMW/ Teflon/ Delrin

**Typical Applications:** UV cure, Cyanoacrylates, solvents, threadlockers, glues, inks.

Part Code	Wetted Parts
TS5623HU	UHMW
TS5623HD	Delrin
TS5623HT	Teflon

#### Hand Operated Applicator



### Manual Hand Operated Diaphragm Valve

Hand operated diaphragm disc valve for the application of low to medium viscosity fluids such as cyanoacrylates, solvents, inks, UV cure, anaerobic, primers and activators. Takes a direct feed of fluid from a syringe, cartridge or pressure pot.

**Length:** 159mm  
**Width:** 45mm  
**Max Pressure:** 50psi  
**Viscosity:** 1-5k cps  
**Inlet:** 1/8" Thread  
**Outlet:** Male Luer  
**Wetted Parts:** PTFE

**Typical Applications:** UV cure, Cyanoacrylates, solvents, threadlockers, glues, inks.

#### Hand Operated Applicator

Part Code	Wetted Parts
ADL-200CAM	Teflon



Manual Hand Operated Pinch Tube Valve

Hand operated valve for applying low to medium viscosity fluids as cyanoacrylates, solvents, UV cure, anaerobic, primer and activators. Maintenance free replaceable tubes. Takes a direct feed of fluid from a syringe, cartridge or pressure pot.



**Typical Applications:** UV, Cyanoacrylates, solvents, threadlockers, glues, inks.

**Length:** 122.4mm  
**Width:** 36.3mm  
**Max Pressure:** 60psi  
**Viscosity:** 1-45k cps  
**Inlet:** Female Luer  
**Outlet:** Male Luer  
**Wetted Parts:** Polyethylene

Part Code	Type
TS1201	Full boxed kit, clear/ black fluid lines
TS1201-1	Valve only, white tube, no fluid lines
TS1201-2	Valve only, black tube, no fluid lines

Hand Operated Applicator



Replacement Pinch Tubes for TS1201 Hand Valve

Replacement pinch tubes for the TS1201 manual valves. Easy to replace, these tubes are supplied in packs of 10. Either natural for most materials or black opaque for when dispensing UV cure adhesives. TS1201 pinch tubes are the longer version below.



Part Code	Type
1201-000-004PK	Natural, PE, 0.100" ID, Male to Female Luer
1201-000-005PK	Natural, PE, 0.100" ID, Male to Male Luer
1201-000-006PK	Natural, PE, 0.070" ID, Male to Female Luer
1201-006-000PK	Natural, PU, 0.125" ID, Male to Female Luer
1201-000-004BPK	Black, PE, 0.100" ID, Male to Female Luer

Manual Hand Operated Pinch Tube Wand

This manual dispensing wand has a flexible silicone pinch tube and is excellent for solder masks and other flowable materials. We do not recommend using it with cyanoacrylate (CA) glues however. The wand requires 50 psi or less to dispense fluids. The front of the wand has a luer lock female fitting, allowing use of any size dispensing tip.



**Typical Applications:** Solder mask, anaerobics, glues, inks.

**Length:** 170.9mm  
**Width:** 16.0mm  
**Max Pressure:** 50psi  
**Viscosity:** 1-40k cps  
**Inlet:** Female Luer  
**Outlet:** Male Luer  
**Wetted Parts:** Polyethylene

Part Code	Type
ADMPW	Full boxed kit, clear pinch tube, luer fitting
AD1013R	Pinch tube replacement, clear (per ft)
AD2601-4L	White needle adapter luer fitting

Hand Operated Applicator

Air Operated Pinch Tube Valve

Air operated pinch tube valve. Operates from a dispenser/ controller for timed deposits or beads of most low to medium viscosity fluids. For UV Cure, cyanoacrylates, threadlocker, glue, epoxy, solvents and activators. Single acting valve - air open and spring

**Typical Applications:** Cyanoacrylates, UV cure, Anaerobics, 2-part epoxies, solvents, glues.



**Length:** 83mm  
**Width:** 40mm  
**Max Pressure:** 60psi  
**Viscosity:** 1-45k cps  
**Inlet:** Female Luer  
**Outlet:** Male Luer  
**Wetted Parts:** Polyethylene

Part Code	Type
TS1212	Full boxed kit, clear/ black fluid lines

Air Operated Applicator



Replacement Pinch Tubes for TS1212 Air Operated Valve

Replacement pinch tubes for the TS1212 manual valves. Easy to replace, these tubes are supplied in packs of 10. Either natural for most materials or black opaque for when dispensing UV cure adhesives. TS1212 pinch tubes are the shorter version below.



Part Code	Type
1212-004-002PK	Natural, PE, 0.100" ID, Male to Female Luer
1212-004-200PK	Natural, PU, 0.125" ID, Male to Male Luer
1212-004-000PK	Natural, PE, 0.070" ID, Male to Female Luer
1212-004-100PK	Natural, PU, 0.125" ID, Male to Female Luer
1212-004-003PK	Natural, PU, 0.100" ID, Male to Female Luer
1212-004-002BPK	Black, PE, 0.100" ID, Male to Female Luer
1212-004-100BPK	Black, PE, 0.125" ID, Male to Female Luer



**Air Operated TS Series Diaphragm Valves**

Air operated diaphragm valves for use with most low to medium viscosity fluids. Use UHMW and Teflon for Cyanoacrylates, solvents, primers, inks. Use Delrin for UV cure and anaerobic. Use the stainless steel version for lacquer's. Low maintenance design. Single acting valve - air open and spring close. Use with pressure pots and digital controllers for a complete system.

**Typical Applications:** UV cure, Cyanoacrylates, solvents, anaerobics, glues, inks.

Length: 76.0mm  
 Width: 27.0mm  
 Max Pressure: 100psi  
 Viscosity: 1-50k cps  
 Inlet: 1/8" NPT  
 Outlet: 1/4-28 UNF  
 Wetted Parts: PTFE, UHMW, Delrin, S/S

Part Code	Wetted Parts
TS5620HU	UHMW
TS5621HD	Delrin Black
TS5622VU	UHMW
AD5622VT	Teflon PTFE
TS5622VT	Teflon PTFE
TS5622VD	Delrin Black
TS5622-DVD	Stainless Steel



Use with TS550R  
Smart Controller



[Air Operated Applicators](#)

**Air Operated ADV Series Diaphragm Valves**

Air operated diaphragm valve for use with most low to medium viscosity fluids. With UHMW or Teflon wetted parts for Cyanoacrylates, solvents, primers, inks. Low maintenance design. Single acting valve - air open and spring close. Use with pressure pots and digital controllers for a complete system.

**Typical Applications:** UV cure, Cyanoacrylates, solvents, anaerobics, glues, inks.

Length: 79.0mm  
 Width: 26.9mm  
 Max Pressure: 100psi  
 Viscosity: 1-50k cps  
 Inlet: 1/8" NPT  
 Outlet: 1/4-28 UNF  
 Wetted Parts: PTFE, UHMW

Part Code	Wetted Parts
ADV62	UHMW
AD5622VT	PTFE



Use with TS550R  
Smart Controller

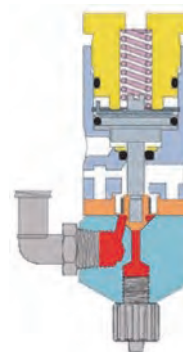

[Air Operated Applicator](#)

**Air Operated ADV Series Micro Diaphragm Valve**

Air operated diaphragm valve for use with most low to medium viscosity fluids. With UHMW wetted parts for solvents, UV adhesive, primers, inks. Low maintenance design. Single acting valve - air open and spring close. Use with pressure pots and digital controllers for a complete system.

**Typical Applications:** UV cure, single part epoxies, solvents, anaerobics, glues, inks.

Length: 63.2mm  
 Width: 18.9mm  
 Max Pressure: 100psi  
 Viscosity: 1-50k cps  
 Inlet: Female Luer  
 Outlet: Male Luer  
 Wetted Parts: UHMW

Part Code	Wetted Parts
ADV12	UHMW



Use with TS550R  
Smart Controller

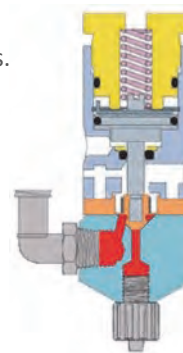

[Air Operated Applicator](#)

**Air Operated TS Series Diaphragm Valve with Disposable Feed Path**

Pneumatic operated diaphragm valve with replaceable polyethylene feed path. This ensures that reactive, curable and abrasive adhesives such as Cyanoacrylate and epoxies can be used and if required, the feed path assembly "wetted parts" can be replaced in seconds. This eliminates any major valve cleaning or maintenance. Single acting valve - air open and spring close used with digital controllers.

Length: 84.8mm  
 Width: 31.8mm  
 Max Pressure: 100psi  
 Viscosity: 1-50k cps  
 Inlet: Female Luer  
 Outlet: Male Luer  
 Wetted Parts: Acetal

Part Code	Type
TS5624DMP	DMP Valve
DMP-5624	Replacement Feed Paths



Use with TS550R  
Smart Controller



[Air Operated Applicator](#)

## Needle valves

### Air Operated TS Series Needle Valves

Needle valves for rapid micro dots of UV cure adhesives, inks and lubricants. Needle shut off point is close to the tip eliminating dead space and prevent drips. Stroke control for fine-tuning flow. Use these valves with any air operated dispenser and with any pressure pot feed system. Single acting valve - air open and spring close. Use with digital valve controllers.

**Typical Applications:** UV cure, glues, inks, primers, activators, solvents

**Length:** 112mm  
**Width:** 28mm  
**Weight:** 227g  
**Max Pressure:** 300psi  
**Viscosity:** 1-100k cps  
**Inlet:** 1/8" NPT  
**Wetted Parts:** S/S, Aluminium,

Part Code	Type
TS5420	Standard Type, Aluminium Body
TS5420SS	Standard Type, Stainless Steel Body
TS5440	Microshot Type, Aluminium Body
TS5440-SS	Microshot Type, Stainless Steel Body



Use with TS550R Smart Controller

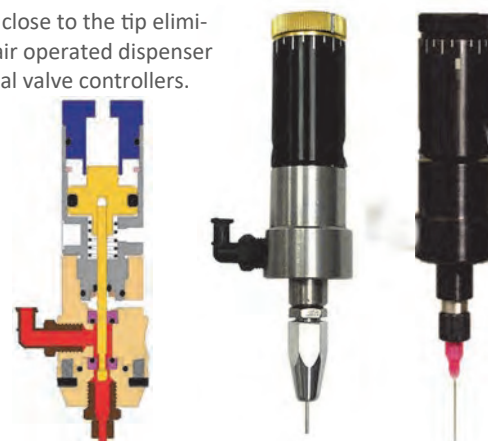

[Air Operated Applicators](#)

### Air Operated ADV Series Needle Valve

Needle valves for rapid micro dots of UV cure adhesives, inks and lubricants. Needle shut off point is close to the tip eliminating dead space and prevent drips. Stroke control for fine-tuning flow. Use these valves with any air operated dispenser and with any pressure pot feed system. Single acting valve - air open and spring close. Use with digital valve controllers.

**Typical Applications:** UV cure, glues, inks, primers, activators, solvents

**Length:** 130.1mm  
**Width:** 26.9mm  
**Weight:** 320g  
**Max Pressure:** 100psi  
**Viscosity:** 1-50k cps  
**Inlet:** 1/8" NPT  
**Wetted Parts:** S/S, Aluminium, Acetal

Part Code	Type
ADV51MD	Standard Type, Stainless Steel Body



Use with TS550R Smart Controller

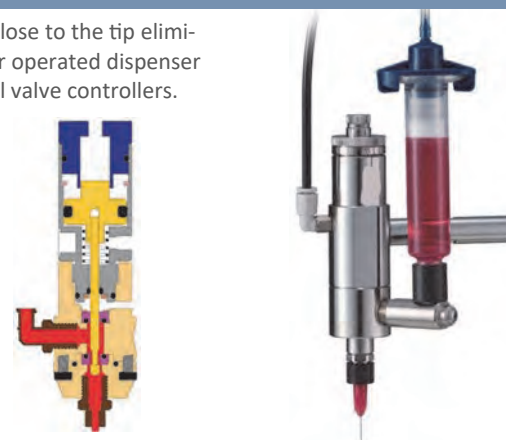

[Air Operated Applicators](#)

### Air Operated ADG Series Needle Valve

Precision high pressure needle dispensing valve with aluminium body. Single acting, requires just air pressure pulse to open and it spring closes. Use with digital controller. Adjustable flow control. Highly accurate and compact dispense valve. Single acting air opening/ spring close.

**Typical Applications:** UV cure, glues, inks, primers, activators, solvents

**Length:** 109mm  
**Width:** 25mm  
**Weight:** 215g  
**Max Pressure:** 200psi  
**Viscosity:** 1-100k cps  
**Wetted Parts:** Aluminium, Acetal

Part Code	Wetted Parts
ADG25	Type 304 Stainless Steel



Use with TS550R Smart Controller

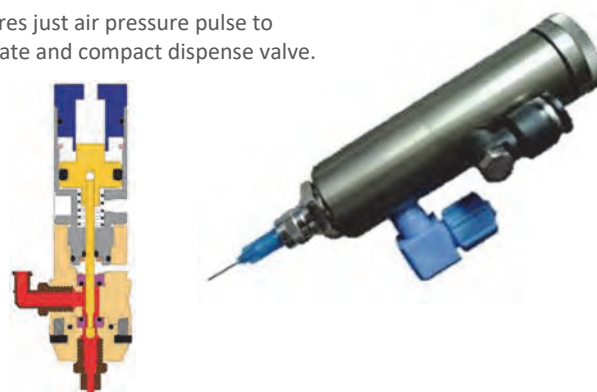

[Air Operated Applicator](#)

### Air Operated ADG Series Needle Valve

Precision high flow needle dispensing valve with aluminium body. Double acting, requires air pressure pulse to open and air pressure to close. Use with double acting valve controller. Adjustable flow control. Higher flow rates.

**Typical Applications:** UV cure, silicone oil, solvents, inks

**Length:** 157mm  
**Width:** 24mm  
**Weight:** 250g  
**Max Pressure:** 100psi  
**Viscosity:** 1-60k cps  
**Wetted Parts:** Stainless Steel

Part Code	Wetted Parts
ADV740	Type 304 Stainless Steel



Use with VCE1195 double Controller



[Air Operated Applicator](#)

### TS Series Air Operated Spool Valves

Air operated spool valves for use with medium to high viscosity materials such as silicones, sealants, RTVs, pastes, gels and glues. TS5322 for materials 5,000 to 1 million cps, max fluid pressure 500psi. TS941 for 5,000 to 3 million cps and max fluid pressure of 2500psi. Use with digital valve controller. Single acting valve - air open and spring close or double acting air open/ air close.

**Typical Applications:** Silicone RTV, Sealant, Mastic, UV Cure, Grease, Gels, Pastes, Solder Mask, Gasketing.

**Part ID:** TS5322/ TS941  
**Length:** 102mm/ 119mm  
**Width:** 25mm/ 38mm  
**Weight:** 141g/ 726g  
**Max Pressure:** 500/ 2500psi  
**Viscosity:** 5k-1000k/ 5k-3000k cps  
**Wetted Parts:** Delrin, Stainless Steel

Part Code	Body Type	Inlet
TS5322	Aluminium	1/8"
TS5322D	Delrin	1/8"
TS941	Stainless Steel	3/8"
TS941A	Stainless Steel	1/4"



Use with TS550R  
Smart Controller



[Air Operated Applicators](#)

### ADV Series Air Operated Piston Valve

Air operated piston valve for use with medium to high viscosity materials such as silicones, sealants, RTVs, pastes, gels and glues. UHMW wetted parts for material compatibility and long term work life. Use with digital valve controller. Single acting valve - air open and spring close. Suck-back action to reduce drips.

**Typical Applications:** Silicone RTV, Sealant, UV Cure, Grease, Gels, Pastes, Solder Mask, Gasketing.

**Length:** 141.0mm  
**Width:** 28.5mm  
**Weight:** 379g  
**Max Pressure:** 200psi  
**Viscosity:** 1k-500k cps  
**Inlet:** 1/8" NPT  
**Outlet:** 1/4" NPT  
**Wetted Parts:** UHMW

Part Code	Wetted Parts
ADV35DA	UHMW

[Air Operated Applicator](#)



Use with TS550R  
Smart Controller



### ADV Series Air Operated High Pressure Piston Valve

Air operated high pressure piston valve for use with medium to high viscosity materials such as silicones, sealants, RTVs, pastes, gels and glues. Stainless steel wetted parts. Use with digital valve controller. Single acting valve - air open and spring close. Suck-back action to reduce drips.

**Typical Applications:** Silicone RTV, Sealant, UV Cure, Grease, Gels, Pastes, Solder Mask, Gasketing.

**Length:** 119.4mm  
**Width:** 38.1mm  
**Weight:** 728g  
**Max Pressure:** 1720psi  
**Viscosity:** 5k-2000k cps  
**Inlet:** 3/8" NPT  
**Outlet:** 1/4" NPT  
**Wetted Parts:** Stainless Steel

Part Code	Wetted Parts
ADV46	Stainless Steel

[Air Operated Applicator](#)



Use with TS550R  
Smart Controller

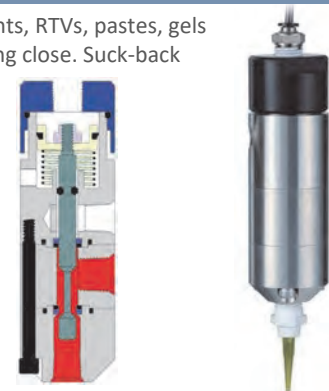

### ADV Series Air Operated Rotary Valve

Air operated rotary valve for use with medium to high viscosity materials such as silicones, sealants, RTVs, pastes, gels and PVA. Stainless steel wetted parts. Use with digital valve controller. Single acting valve - air open and spring close. Suck-back action to reduce drips.

**Typical Applications:** Silicone RTV, Sealant, UV Cure, Grease, Gels, Pastes, Solder Mask, Gasketing.

**Length:** 74.1mm  
**Width:** 68.0mm  
**Weight:** 300g  
**Max Pressure:** 1720psi  
**Viscosity:** 5k-150k cps  
**Inlet:** 3/8" NPT  
**Outlet:** 1/4" NPT  
**Wetted Parts:** Stainless Steel

Part Code	Wetted Parts
ADV65	Stainless Steel

[Air Operated Applicator](#)



Use with TS550R  
Smart Controller





Motor Driven DMP Auger Rotary Valve

Disposable Material Path (DMP) valve uses a feed screw for easy maintenance and reliable dispensing. Feed screw made of Delrin, for use with two-compound and UV pastes. Auger valve technology for the highest repeatability. With 6, 8 or 16 pitch screw pitch size. Use with TS570R digital controller. Feed material from syringe barrel or cartridge reservoir.

**Typical Applications:** Solder paste, SMA, Epoxy, UV cure.

Part Code	Type
TS5000DMP-DCX	DMP Valve Boxed Fixed Collar
DMP6-10	6 Pitch Insert Red Fixed Collar
DMP6R-10	6 Pitch Insert Red Rotating Collar
DMP8-10	8 Pitch Insert Black Fixed Collar
DMP8R-10	8 Pitch Insert Red Rotating Collar
DMP16-10	16 Pitch Insert Red Fixed Collar
DMP16R-10	16 Pitch Insert Red Rotating Collar

**Length:** 149.4mm  
**Width:** 39.6mm  
**Max Pressure:** 30psi  
**Viscosity:** 30k-1 Million cps  
**Inlet:** Female Luer  
**Outlet:** Male Luer  
**Wetted Parts:** Delrin

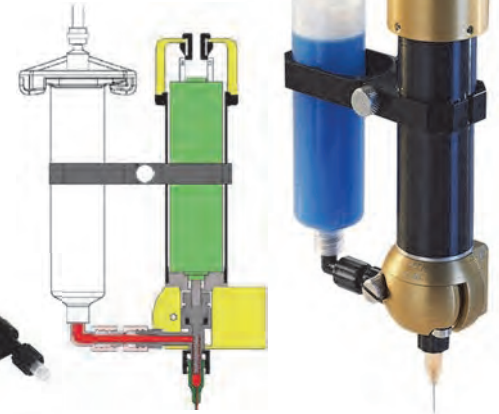

Use with TS570R Smart Controller

Motor Driven Applicator

Motor Driven IMP Auger Rotary Valve

Uses a feed screw (auger) to dispense fluid with a rotary displacement action, allowing ultra-precise control of the dispensing process. Modular design allows quick easy replacement of the feed screw/chamber cartridge assembly without removing the valve from the machine. Valve cartridge can be interchanged to use with TS5000DMP feed screw inserts. Available in 3 choices of feed screw sizes (16-pitch, 8-pitch and high output 8-pitch), all made of precision hardened tool steel.

**Typical Applications:** Solder paste, SMA, Epoxy, UV adhesive, Heat Sink.

Part Code	Type
TS7000-16	IMP Valve 16 Pitch
TS7000-8	IMP Valve 8 Pitch
TS7000-8HO	IMP Valve 8 Pitch, High Output
TS7000E-16	IMP Valve 16 Pitch, Encoder
TS7000E-8	IMP Valve 8 Pitch, Encoder
TS7000E-8HO	IMP Valve 8 Pitch, Encoder, High

**Length:** 172.2mm  
**Width:** 54mm  
**Max Pressure:** 30psi  
**Viscosity:** 30k-1.3 Million cps  
**Inlet:** Female Luer  
**Outlet:** Male Luer  
**Wetted Parts:** Hardened Steel

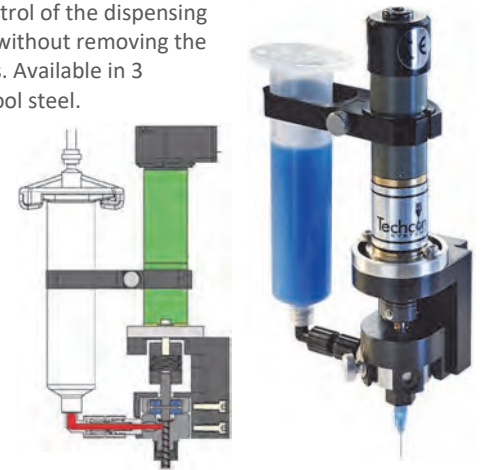

Use with TS570R Smart Controller

Motor Driven Applicator

Positive Displacement PC Pump

The TS8100 Series Positive Displacement Pump is a continuously volumetric dispense pump based on Progressive Cavity (PC) technology. The pump is designed to dispense a wide range of fluids, from low viscosity coatings to high viscosity greases. Due to the PC Pumps unique dispensing technology, accuracy and repeatability of  $\pm 1\%$  is achievable.

**Typical Applications:** Solder paste, SMA, Epoxy, UV adhesive, Heat Sink, Flux.

Part Code	Type
TS8100-100	PC Pump Small Shot Range
TS8100-200	PC Pump Mid Shot Range
TS8100-300	PC Pump Large Shot Range

**Length:** 205mm  
**Width:** 34mm  
**Max Pressure:** 30psi  
**Viscosity:** 1cps-300k

Motor Driven Applicator

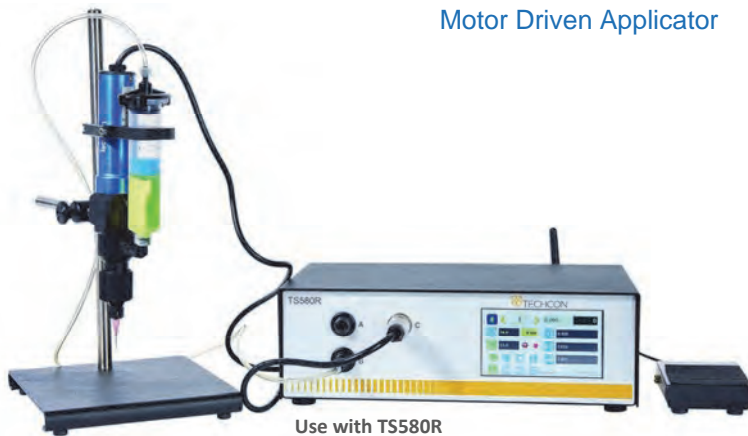

Use with TS580R Smart Controller



**Non Contact Precision Spray Valves**

Spray Valves are designed for precise spray applications of low viscosity materials. Total control of the spray cycle is provided by adjustable fluid flow and precise control of pre-spray, atomizing air and post-spray with the TS560R Valve Controller. Normal maintenance is simple and downtime is virtually eliminated with only one seal to replace.

**Economy Spray Valve - TS5520**

The Spray Valves are designed for precise spray applications of low viscosity materials. An external stroke control makes it easy for the operator to fine-tune fluid flow. Total control of the spray cycle is provided by adjustable fluid flow and precise control of pre-spray, atomizing air and post spray with the TS500R Multi-Purpose Digital Controller. Maintenance is made simple by the elimination of troublesome spring loaded needle packings. Downtime is virtually eliminated with only one seal to replace during normal maintenance.

**The valve is shipped with:**

- Luer fluid inlet fitting
- Mounting bracket kit
- Valve air hoses
- Luer lock fluid line
- Fluid inlet fittings

**Features**

- Consistent spray coverage
- No overspray
- Positive shut-off
- Adjustable flow control

**Specifications**

<b>Fluid Inlet Port:</b>	1/8" NPT female
<b>Fluid Outlet Port:</b>	Spray Cap
<b>Aux Air Inlet Port:</b>	10-32 UNF
<b>Activation Pressure:</b>	70 psi (4.8bar) Min
<b>Max Fluid Pressure:</b>	100 psi (6.9bar)
<b>Mounting Port:</b>	1/4-20 UNC-2B
<b>Viscosity Range:</b>	1-1 000cps
<b>Wetted Parts:</b>	303 SS, Teflon®, Aluminium
<b>Operating Frequency:</b>	400+ cycles/min

Part Code	Type
TS5520	Spray Valve



**Typical Applications:** Fine mist of low viscosity fluids such as: conformal coating, solvent, oil, etc.

**High Performance Spray Valve - TS5540**

An external stroke control makes it easy for the operator to fine-tune fluid control. Total control of the spray valve is provided by adjustable fluid flow and precise control of pre-spray, atomizing air and post spray with the TS550R digital controller. Downtime is virtually eliminated with only one seal to replace during normal maintenance.

The TS5440 spray valve with FDA compliant 303 stainless steel construction in both air cylinder and fluid housing. A field replaceable Delrin seat provides positive shut off and very long life cycles. The compact design allows for easy integration into automated applications. Two nozzle types are made available, cone (R) for round patterns and fan (F) for elliptical spray patterns. Both versions are available in 3 nozzles sizes.

**The valve is shipped with:**

- Luer fluid inlet fitting
- Mounting bracket kit
- Valve air hoses
- Luer lock fluid line
- Fluid inlet fittings

**Features**

- Consistent spray coverage
- No overspray
- Positive shut-off
- Adjustable flow control

**Specifications**

<b>Fluid Inlet Port:</b>	1/8" NPT female
<b>Fluid Outlet Port:</b>	Spray Cap
<b>Aux Air Inlet Port:</b>	10-32 UNF
<b>Activation Pressure:</b>	70 psi (4.8bar) Min
<b>Max Fluid Pressure:</b>	100 psi (6.9bar)
<b>Mounting Port:</b>	1/4-20 UNC-2B
<b>Viscosity Range:</b>	1-5 000cps
<b>Wetted Parts:</b>	303 SS, Teflon®, Delrin®
<b>Operating Frequency:</b>	400+ cycles/min



**Typical Applications:** Fine mist of low viscosity fluids such as: conformal coating, solvent, oil, etc.



Part Code	Nozzle Orifice	Min. Dia. Spray Pattern
TS5540-014R	0.014" - 0.36mm	0.17" - 4.32mm
TS5540-028R	0.028" - 0.71mm	0.20" - 5.08mm
TS5540-046R	0.046" - 1.17mm	0.25" - 6.35mm

Part Code	Nozzle Orifice	Min. Dia. Spray Pattern
TS5540-014F	0.014" - 0.36mm	0.50" - 12.70mm
TS5540-028F	0.028" - 0.71mm	0.65" - 16.51mm
TS5540-046F	0.046" - 1.17mm	1.00" - 24.40mm

**Nozzles Only**

Opening Diameter	Cone Nozzle	Fan Nozzle
0.014" - 0.36mm	RNC014	FNC014
0.028" - 0.71mm	RNC028	FNC028
0.046" - 1.17mm	RNC046	FNC046

**Cone Round**

**Fan Oval**

**TS5540-MS Microshot Spray Valve**

The TS5540-MS spray valve is designed to spray low viscosity materials through disposable dispensing tips. Spray patterns range from 0.18" - 0.60" (4.6mm-15mm) in diameter.

Part Code	Type
TS5540-MS	Micro Spray Valve





Non Contact Precision Spray Valve

Spray Valves are designed for precise spray applications of low viscosity materials. Total control of the spray cycle is provided by adjustable fluid flow and precise control of pre-spray, atomizing air and post-spray with the TS560R Valve Controller. Normal maintenance is simple and downtime is virtually eliminated with only one seal to replace. The nozzle on this valve is 0.046" diameter cone shape.

**Typical Applications:** Fine mist of low viscosity fluids such as: conformal coating, solvent, oil, etc.

**Specifications**

L x W	105.6mm x 26.9mm
Weight:	294g
Fluid Inlet Port:	1/8" NPT female
Fluid Outlet Port:	Spray Cap
Activation Pressure:	70 psi (4.8bar) Min
Max Fluid Pressure:	100 psi (6.9bar)
Mounting Port:	M6
Viscosity Range:	1-1000cps
Wetted Parts:	303 SS, Teflon®, Aluminium
Operating Frequency:	400+ cycles/min

Part Code	Type
ADV91	Spray Valve



Use with TS560R Smart Controller

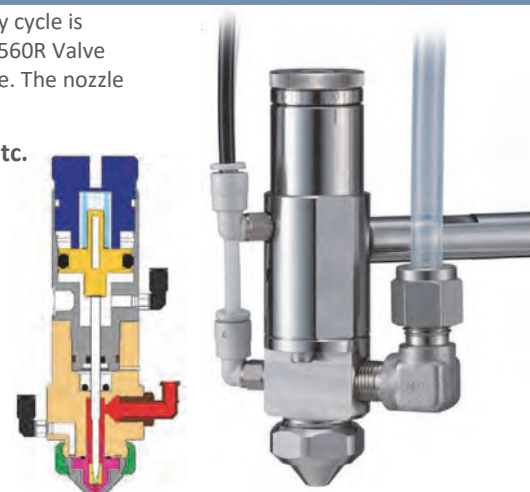

Non Contact Microshot Precision Spray Valve

Ultra micro-shot spray valve model ADV97MS used micro pressure to achieve stable spray patterns of 3 to 20mm diameter. Use standard luer lock needle tips of 0.10mm to 0.33mm ID on this valve.

**Typical Applications:** Fine mist of low viscosity fluids such as: conformal coating, solvent, oil, etc.

**Specifications**

L x W:	131.1mm x 26.9mm
Weight:	308g
Fluid Inlet Port:	1/8" NPT female
Fluid Outlet Port:	Spray Cap with Needle
Activation Pressure:	70 psi (4.8bar) Min
Max Fluid Pressure:	100 psi (6.9bar)
Mounting Port:	M6
Viscosity Range:	1-1 000cps
Wetted Parts:	303 SS, Teflon®, Aluminium
Operating Frequency:	400+ cycles/min

Part Code	Type
ADV91	Spray Valve



Use with TS560R



Non Contact Precision Coating Spray Valve

Precision coating valve for the application of conformal coatings, liquid flux, solvents and paints. Ideal for coating onto PCBs and other products that require precision dispensing. Consistent coating performance without overspray or splash.

**Typical Applications:** Low viscosity fluids such as: conformal coating, solvent, oil, etc.

**Specifications**

L x W:	136.3mm x 26.9mm
Weight:	312g
Fluid Inlet Port:	1/8" NPT female
Fluid Outlet Port:	Spray Spout Nozzle
Activation Pressure:	70 psi (4.8bar) Min
Max Fluid Pressure:	100 psi (6.9bar)
Mounting Port:	M6
Viscosity Range:	1-100cps
Wetted Parts:	303 SS, Teflon®, Aluminium
Operating Frequency:	400+ cycles/min

Part Code	Type
ADV70	Coating Valve



Use with D500R Multi Controller



Non Contact Precision Coating Spray Valve

Narrow strip spraying valve for conformal coatings and other low viscosity materials. Line coating in narrow spaces down to 2mm wide spray. With stroke adjustment for fine tuning.

**Specifications**

L x W:	136.3mm x 26.9mm
Weight:	312g
Fluid Inlet Port:	1/8" NPT female
Fluid Outlet Port:	Spray Spout Nozzle
Activation Pressure:	70 psi (4.8bar) Min
Max Fluid Pressure:	100 psi (6.9bar)
Mounting Port:	M6
Viscosity Range:	1-100cps
Wetted Parts:	303 SS, Teflon®, Aluminium
Operating Frequency:	400+ cycles/min

Part Code	Type
ADV91CD	Coating Valve



Use with D500R Multi Controller

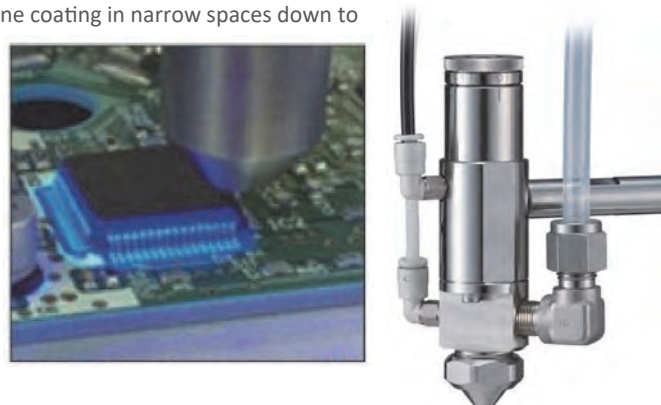



### Dual Component Epoxy Dispensing Valve

Stainless steel double air activated dispense valve for mixing two part materials such Part A and Part B are fed under pressure to the valve, it delivers them into the static mixer nozzle where they are mixed. This valve mixes ratio 1:1 ratio only.

**Typical Applications:** Epoxies, polyurethanes, potting materials, doming resins.

#### Specifications

<b>Mix Ratio:</b>	1:1
<b>Minimum Shot Size:</b>	0.01ml/ cc
<b>L x W</b>	115mm x 42mm
<b>Weight:</b>	618g
<b>Fluid Inlet Port:</b>	1/8" NPT female
<b>Fluid Outlet Ports:</b>	Static Mixer Nozzle
<b>Activation Pressure:</b>	>70 psi (4.8bar) Min
<b>Max Fluid Pressure:</b>	100 psi (6.9bar)
<b>Viscosity Range:</b>	1-1000cps
<b>Wetted Parts:</b>	304 SS, Aluminium

#### Features

- Consistent deposits
- Accurate mixing
- Positive shut-off
- Adjustable flow control

Part Code	Wetted Parts
ADH3242AB1	304 Stainless Steel

Use with VCE1195 double Controller



### Dual Component Epoxy Dispensing Valve

Stainless steel double air activated dispense valve for mixing two part materials . Part A and Part B are fed under pressure to the valve, it delivers them into the static mixer nozzle where they are mixed. This valve mixes ratios up to 3:1 - adjustable.

**Typical Applications:** Epoxies, polyurethanes, potting materials, doming resins.

#### Specifications

<b>Mix Ratio:</b>	<3:1
<b>Minimum Shot Size:</b>	0.01ml/ cc
<b>L x W</b>	115mm x 42mm
<b>Weight:</b>	618g
<b>Fluid Inlet Port:</b>	1/8" NPT female
<b>Fluid Outlet Ports:</b>	Static Mixer Nozzle
<b>Activation Pressure:</b>	>70 psi (4.8bar) Min
<b>Max Fluid Pressure:</b>	100 psi (6.9bar)
<b>Viscosity Range:</b>	1-1000cps
<b>Wetted Parts:</b>	304 SS, Aluminium

#### Features

- Consistent deposits
- Accurate mixing
- Positive shut-off
- Adjustable flow control

Part Code	Wetted Parts
ADH3242AB2	304 Stainless Steel

Use with VCE1195 double Controller



### Dual Component Epoxy Dispensing Valve

Stainless steel double air activated dispense valve for mixing two part materials. Part A and Part B are fed under pressure to the valve, into the static mixer nozzle where they are mixed. This valve mixes ratios 2:1 or under - adjustable.

**Typical Applications:** Epoxies, polyurethanes, potting materials, doming resins.

#### Specifications

<b>Mix Ratio:</b>	< 2:1
<b>Minimum Shot Size:</b>	0.01ml/ cc
<b>L x W</b>	160mm x 40mm
<b>Weight:</b>	233g
<b>Fluid Inlet Port:</b>	1/8" NPT female
<b>Fluid Outlet Ports:</b>	Static Mixer Nozzle
<b>Activation Pressure:</b>	>70 psi (4.8bar) Min
<b>Max Fluid Pressure:</b>	100 psi (6.9bar)
<b>Viscosity Range:</b>	1-2000cps
<b>Wetted Parts:</b>	304 SS, Aluminium

#### Features

- Consistent deposits
- Accurate mixing
- Positive shut-off
- Adjustable flow control

Part Code	Wetted Parts
ADH1919AB1	304 Stainless Steel

Use with VCE1195 double Controller



### VCE1195 4-Way Double Acting Valve Controller

The VC1195N is a 4-way valve controller that can be used to control one or two valves simultaneously. The controller is suitable for dual component valves. The valve controller provides a continuous "valve-off" state and remains in this mode until a signal is received to switch to "valve-on" mode when the footswitch is pressed or used with a robot to control the operation. When the timer is selected, a momentary pulse will activate the timer to open the valve for a programmed period and then close the valve automatically.

#### Specifications

<b>W x D x H:</b>	266 x 210 x 72mm
<b>Weight:</b>	1.92kg
<b>Activation Pressure:</b>	70 psi (4.8bar) Min
<b>Max Fluid Pressure:</b>	100 psi (6.9bar)
<b>Timer Tolerance:</b>	+/- 0.001%

#### Features

- Timed or Continuous
- Foot pedal or Robot
- Positive shut-off
- Adjustable timer control

Part Code	Type
VCE1195N	220V AC
VC1195A	110V AC



Non Contact Jet Valve TS9000 System with Controller



The TS9000 Series Jet Tech is a Piezoelectric driven, non contact dispense valve capable of handling fluid viscosities to 2 million Cps. Jet Tech offers a fast jetting action producing hundreds of accurate deposits less than one second. Every component of the valve was designed to the highest tolerances and manufactured to the strictest degree of precision insuring world class accuracy and repeatability in drop-to-drop dispensing volume.

Jet Tech's compact size and modular design aids integration into robotic systems. The valve features fully adjustable parameter settings, allowing the operator to change the jetting properties for different fluid types and optimize the process for repeatable dispensing. A variety of nozzles shape and sizes along with different tappet configurations provides a wide spectrum of output jet deposits.

**Key Features**

- Non contact Jetting technology
- Accurate and precise dispensing
- Extremely high speed, up to 1000Hz
- Repeatable drop size as small as 2 nl
- Jet Fluid from 7K to 2 million Cps
- Small modular design
- Easy and fast cleaning
- Field replaceable spare parts
- Low total cost of ownership

Jet Tech's compact size and modular design aids integration into robotic systems. The valve features fully adjustable parameter settings, allowing the operator to change the jetting properties for different fluid types and optimize the process for repeatable dispensing. A variety of nozzles shape and sizes along with different tappet configurations provides a wide spectrum of output jet deposits.

**The Jet Tech system is shipped with the following items:**

- Valve
- Controller
- Cables (sensor, actuator, power cable)
- Nozzle tools

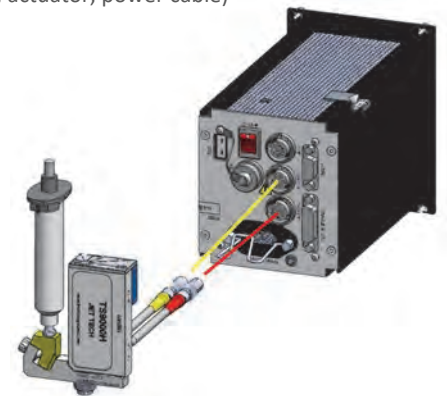

**Specifications**

Size Valve:	W x L x H: 115mm x 39.5mm x 12mm
Size Controller:	W x L x H: 101.6mm x 295mm x 128.4mm
Weight Valve:	258g
Weight Controller:	1.6kg
Minimum Shot Size:	2 nl
Viscosity Range:	7K to 2000K Cps
Fluid Pressure Range:	1 to 116 psi(0.1 to 8.0bar)
Nozzle Orifice Dia Range:	0.0028" to 0.016"(0.07mm to 0.40mm)
Max. Dispense Frequency:	1000 Hz
Power Connection:	10 sets internally; unlimited externally
Standard Interface:	RS232; 25V/ 5V PLC
Operating Temperature:	10 to 50°C

**Typical Applications..:** Jetting silver epoxies for die bonding processes, Jetting silicone phosphor in the LED assembly process, Jetting under-fill in micro-electronic package applications on PCBA, Jetting micro dots of UV adhesive in medical device applications

**Part Number Ordering** - For the complete Jet Tech Valve System 4 part numbers are required for ordering purposes – Jet Tech valve/controller, supply unit option, tappet option and the nozzle insert option. TS9000SYS-H is the part number for the main system. This part number consists of:  
 - Jet Tech Valve (Electrical section) and Jet Controller

The Supply Unit is the fluid housing assembly that includes the fluid housing, tappet seal, tappet bearing, washer, fluid inlet fitting and syringe bracket.



Select One

Part Code	Type
7504-0170-1	Supply Unit Assembly for 10cc
7504-0170-2	Supply Unit Assembly for 30/55cc
7504-0170-3	Supply Unit Assembly for 5cc
7504-0170-4	Supply Unit Assembly for 3cc

The connection between the tappet and the piezo is established by means of a lever. This lever transmits the distention and contraction of the piezo of the tappet, which in consequence continuously moves up and down and pushes the fluid to be dispensed through the orifice of the nozzle. Since the tappet is considered as a wearing part, regular maintenance of the tappet is mandatory. If the tappet is not cleaned or greased at regular intervals, the accuracy of the dispense process will decrease. The table below shows available sizes of the tappet for the TS9000H Jet Tech valve.



Select One

Part Code	Type
7504-0150-1	Tappet TTF4 Tungsten Carbide 0.4mm
7504-0150-2	Tappet TTF5 Tungsten Carbide 0.5mm
7504-0150-3	Tappet TTF6 Tungsten Carbide 0.6mm
7504-0150-4	Tappet TTF7 Tungsten Carbide 0.7mm
7504-0150-5	Tappet TTF10 Tungsten Carbide 1.0mm
7504-0150-6	Tappet TTF15 Tungsten Carbide 1.5mm

The nozzle insert determines the drop size. The smaller the nozzle insert orifice – the smaller the drop size. Consult us to select the right nozzle insert.

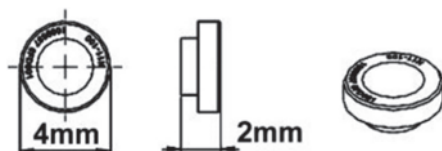

Select One

Part Code	Type
7504-0160-1	Nozzle Insert N11-70, 0.07mmØ
7504-0160-2	Nozzle Insert N11-100, 0.10mmØ
7504-0160-3	Nozzle Insert N11-120, 0.12mmØ
7504-0160-4	Nozzle Insert N11-150, 0.15mmØ
7504-0160-5	Nozzle Insert N11-200, 0.20mmØ
7504-0160-6	Nozzle Insert N14-300, 0.30mmØ
7504-0160-7	Nozzle Insert N14-400, 0.40mmØ

### Non Contact Piezo Jet Valve TS9800



#### The Fastest Non Contact Jet Valve Dispensing System

The smart jet valve delivers ultra-fast and high precision dispensing results for a wide range of adhesives and viscosities. The high speed piezo actuator enables the valve to dispense as fast as 1500 Hz continuously with up to 2000 Hz maximum burst and produce micro shot as small as 0.5 nL.

TS9800 series jet valve compact size and modular design aids integration into robotic systems. The valve features fully adjustable parameter settings, allowing the operator to change the jetting properties for different fluid types and optimize the process for repeatable dispensing. Every component of the valve was designed to the highest tolerances and manufactured to the strictest degree of precision insuring world class accuracy and repeatability in drop-to-drop dispensing volume.

#### Key Features

- Fast dispense frequency, up to 1500 Hz continuous, up to 2000 Hz max burst for higher throughput
- Micro shot size as small as 0.5 nL for small component applications
- Capable of jetting low to high viscosity fluid
- Localized fluid housing heater for better viscosity stabilization and dispensing (optional)
- Touch screen user-friendly interface for easy setup
- Parameters can be adjusted remotely

#### The valve is shipped with the following items:

- 30 CC Syringe Bracket
- 10 CC Syringe adapters
- Luer fluid inlet fitting

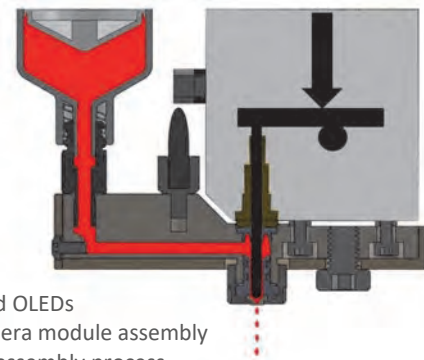

Part Code	Type
TS9800-TT15-H	Jet Valve, TT1.5, with Heater, w/o Nozzle
TS9800-TT7-H	Jet Valve, TT0.7, with Heater, w/o Nozzle
TS9800-TT15-NH	Jet Valve, TT1.5, without Heater or Nozzle
TS9800-TT7-NH	Jet Valve, TT0.7, without Heater or Nozzle

#### Specifications

Size Valve:	(mm) W x D x H: 16 x 69.3 x 124.8
Size Controller:	(mm) W x D x H: 137 x 181 x 126
Weight Valve:	258 g
Weight Controller:	2.11kg
Max Fluid Pressure:	6.9 bar
Nozzle Orifice Dia. Range:	0.05 mm to 0.40mm
Parameter sets Memory:	50 sets internally; unlimited ext.
Standard Interface:	DB15, RS-232, Ethernet, USB
Operating Temperature:	10 °C – 50 °C
Power Connection:	110/240 VAC; 50/60 Hz
Wetted Part:	304SS, Carbide, EPDM, TEFLON®
Certification:	TUV, KC, PSE, NRTL, CE

#### Typical Applications

##### Electronics

- Edge sealing, end sealing of LCDs and OLEDs
- Die bonding, Frame bonding for camera module assembly
- Jetting silicone phosphor in the LED assembly process
- Jetting under-fill in micro-electronic PCBA LED Assembly
- Jetting silicone phosphor
- Jetting under-fill for flip chip LEDs
- Jetting conformal coating

##### Medical Device & Life Science

- Jetting UV adhesives for bonding
- Jetting sealant for gasketing
- Jetting reagents to test strips

##### Medical Assembly

- Jetting UV sealant for gasketing
- Jetting greases for lubrication
- Jetting ink for marking

### TS980 Jet Valve Controller

TS980 smart controller features an intuitive touchscreen user interface for easy setup and operation. Dispensing parameters can be quickly dialed-in on the touchscreen. Industry 4.0 compliant for remote access and control over Ethernet networks, allowing users to monitor, record data and make precise parameter adjustments from a remote location. Modular design characteristics such as external power source provide lower-cost system maintenance.

#### Specifications

Controller Size (inches) W x D x H:	5.40 x 7.13 x 4.96
Controller Size (mm) W x D x H:	137 x 181 x 126
Controller Weight:	2110g
Max Fluid Pressure:	6.9 bar
Certification:	TUV, KC PSE, NRTL, CE

Part Code	Type
TS980	Jet Valve Controller



TS980 Jet Controller



## Jet Tech Hot Melt Valve - TS9300HM Series

TS9300HM Hot Melt Jet Tech Valve Series are easy to clean valves that provide jetting temperatures up to 150°C while keeping the jet actuator below 55°C.

### The TS9300HM Valve Series features:

- An easily replaceable single diaphragm which eliminates dynamic fluid seals common in other jet valves.
- An isolated jetting mechanism that ensures fluids are contamination-free.
- Dual temperature controllers for the jet and the heater which allow the nozzle to be heated to optimum jetting temperatures while keeping the PUR fluid at reduced temperatures.
- Line speeds up to 100mm/sec and nozzle sizes from 64 to 400 µm.
- Designed For Quick And Easy Cleaning

The diaphragm design enables you to exchange syringes quickly and requires minimal cleaning. To eliminate having to clean residual PUR between the syringe and the jet, the TS9300HM has a thermal jacket surrounding the high-temperature feed tube so the syringe can easily be removed with the feed tube attached. The valve also includes a disposable feed tube so only the nozzle plate and diaphragm are in contact with the fluid for quick and easy cleaning.

### TS930 Standalone Controller

The stand-alone TS930 Controller is available to help program the TS9300HM Hot Melt Jet Valve. The TS930 Controller has dual independent temperature controllers and dual independent power supplies for the jet and the heater along with precision air regulators and gauges to fine-tune the jetting parameters. Six independent recipes can be input easily and stored using the fully programmable front panel on the TS930. Recipes can be triggered via a digital I/O connection for easy robot integration.

### TS9300HM Hot Melt Jet Valve applications include:

- Securely bonding components to circuit boards to protect against vibration.
- Seal the housing of mobile devices to protect from moisture.

### Part Numbers For The TS9300HM Series Hot Melt Jet Valve Series:

- TS9300HM-SCD Hot Melt Jet valve with Silicone Carbide Diaphragm (nozzle not included)
- TS9300HM-SSD Hot Melt Jet valve with Silicone Stainless Steel Diaphragm (nozzle not included)
- TS9300HM-VCD Hot Melt Jet valve with Viton Carbide Diaphragm (nozzle not included)
- TS930 Controller

### Specifications

Size Width:	61.6mm (2.43")
Size Depth:	113.3mm (4.46")
Size Height:	191.1mm (7.52")
Weight:	0.91kg (2 lb)
Speed:	Up to 200Hz Continuous Duty
Syringe Capacity:	30cc
Viscosity Range:	Up to 7K Mpa.s (cps) @ 100°C
Fluid Pressure:	0.50 Mpa (75 PSI) Max.
Carbide Nozzle Sizes:	64µm, 75µm, 100µm, 125µm, 150µm, 200µm, 300µm, 400µm
Nozzle Heater:	Heating up to 150°C Max
Fluid Heater:	Heating up to 150°C Max.
Jet Pressure:	0.2 Mpa (30 PSI) Min. 0.5 Mpa (75 PSI) Max.
Controller Interface:	LCD Display w/ Interface, RS-232
Input / Output:	TTL level triggers

### The TS9300HM Series Hot Melt Jet Tech Valve is available in the following configurations:

- TS9300HM-SCD - Hot Melt Jet Valve with Silicone Carbide Diaphragm (nozzle not included)
- TS9300HM-SSD - Hot Melt Jet valve with Silicone Stainless Steel Diaphragm (nozzle not included)
- TS9300HM-VCD - Hot Melt Jet valve with Viton Carbide Diaphragm (nozzle not included)
- TS930 - Controller

### The TS9300HM Hot Melt Jet Tech Valve can be used in wide range of applications:

- Bonding components onto circuit board to protect against vibration
- Sealing mobile device housings to protect from moisture.



### Key Features

- Hot melt dispensing up to 150°C
- No fluid seals to clean or replace
- Disposable feed tube for easy cleanup
- Separate nozzle and fluid heater
- Outstanding repeatability
- Viscosity range up to 7K cps at 100°C
- Tungsten carbide nozzle for long life
- Quick and simple maintenance



TS9200D Jet Controller

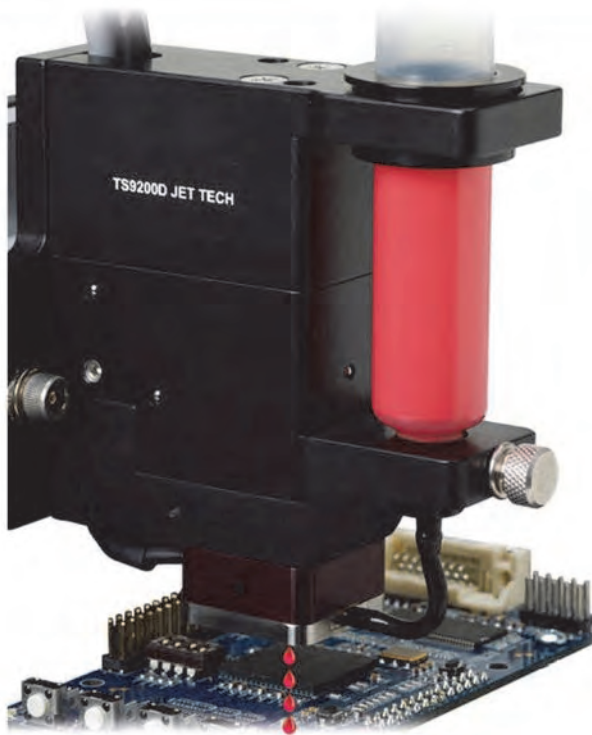

**Non Contact Jet Valve TS9200D**

**Specifications**

<b>Width:</b>	50.8mm
<b>Depth:</b>	93.8mm
<b>Height:</b>	88.9mm
<b>Weight:</b>	348g
<b>Speed:</b>	Up to 300Hz Continuous Duty
<b>Syringe Capacity:</b>	5cc, 10cc, 30cc, 55cc
<b>Minimum Shot Size:</b>	10nl
<b>Viscosity Range:</b>	1k to 400k Cps.
<b>Fluid Pressure:</b>	40 PSI
<b>Jet Pressure:</b>	35 PSI to 70 PSI
<b>Operating Temperature:</b>	10 to 50°C

Part Code	Type
TS9200D-125E	Jet Valve EPDM Diaphragm, 125µm Nozzle
TS9200D-150E	Jet Valve EPDM Diaphragm, 150µm Nozzle
TS9200D-200E	Jet Valve EPDM Diaphragm, 200µm Nozzle
TS9200D-125S	Jet Valve Silicone Diaphragm, 125µm Nozzle
TS9200D-150S	Jet Valve Silicone Diaphragm, 150µm Nozzle
TS9200D-200S	Jet Valve Silicone Diaphragm, 200µm Nozzle

**Jet Tech**

The TS9200D Jet Tech is a non-contact dispense valve capable of jetting fluid viscosities to 400,000 Cps. Jet Tech offers a fast jetting action producing hundreds of precise droplets in less than one second. 300 drops/sec continuous duty. 50% increase in throughput over conventional Jet valves.

Simple to clean – only 2 parts contact the fluid. Conventional Jet valves can have as many as 8 parts requiring cleaning. With only two parts to clean, cleaning the TS9200D takes only minutes and there is no need to remove the Jet valve from the robot. A diaphragm and nozzle plate can be installed immediately without the need to carefully calibrate the Jet valve saving valuable production time and no special off-line cleaner is required.

The TS9200D generates a very high drop velocity allowing a wide range of fluids and applications. In addition, the drop velocity can be easily changed to help fine tune the process and achieve a high process capability and wide process window.

The advanced electronic drive provides power when required and reduces power when idle. The internal air flow cools the jet body so it runs cool even during high-speed, continuous operation. The integral nozzle heater heats only the fluid in the nozzle plate and is thermally isolated from the jet body.

Its easy to integrate – In combination with the standalone TS920 controller, a single trigger line is all that is needed to start dispensing complex programs.

**Typical Applications**

Jetting silver epoxies for die bonding processes, Jetting silicone phosphor in the LED assembly process, Jetting under-fill in micro-electronic package applications on PCBA, Jetting micro dots of UV adhesive in medical device applications.

**Key Features**

- Non contact Jetting technology
- Accurate and precise dispensing
- High speed, up 300 drops/sec
- Repeatable drop size as small as 10 nl
- Jet fluid up to 400K Cps
- No fluid seals to clean or replace
- Integral heater with minimal fluid heated
- Quick and simple setup
- Low total cost of ownership

**Typical Applications:** Silver Epoxies, Silicone Phosphor, Under-Fill, UV Cure.

**TS920 Jet Valve Controller**

The TS920 is a smart controller for the TS9200D Jet Tech valve. It is designed with a powerful single board computer and LCD display. Dispensing parameters needed to control the TS9200D Jet Tech valve can be easily set from the front panel keys. Recipes - six independent dispensing recipes can be programmed using the front panel keys or using the Jet Tech Software and downloaded into memory. Once programmed, the Jet valve can be triggered manually, from a host robot, or from a PC using the RS-232 interface.

**Specifications**

<b>Size:</b>	(WxDxH): 254mm x 323.3mm x 152.4mm. Weight : 3.2kg
<b>Speed:</b>	Up to 300Hz Continuous Duty
<b>Refill Time:</b>	0.1ms resolution - Dwell Time: 0.1ms resolution
<b>Number of Drops:</b>	1 to 1 Million Programmable
<b>Recipes:</b>	6 Independent, Manual or Remote
<b>Nozzle Heater:</b>	Heating to 70°C, PID Control, Auto-tuning, Shut off timer
<b>1st Drop Compensation:</b>	2 levels with program. time interval
<b>Controller Interface:</b>	RS-232 & LCD Display with Keypad
<b>Input/Output:</b>	TTL Level Triggers
<b>Operating Temp:</b>	10 to 50°C
<b>Input Power:</b>	100, 115, 230 VAC

Part Code	Type
TS920	Jet Valve Controller

**TS9200D Jet Controller**

## TS560 Series Smart Valve Controllers



A series of smart valve controllers: the TS550R, TS560R, TS570R and TS580R that will control precision valves. Equipped with a universal power supply, the smart valve controllers are fully “plug-and-play” and can be used immediately anywhere in the world.

Controllers feature an intuitive touchscreen interface for easy setup and operation. Dispensing parameters can be precisely configured directly on the touch screen or remotely through the networking options. The smart valve controllers are equipped with Ethernet and WiFi interfaces to allow users to configure the exact parameters and monitor and control the process from anywhere in the world, complying with Smart Factory requirements on Industry 4.0.

Additional advance features include digital timer to provide accurate and repeatable spray time, and a digital pressure regulator with dual-unit display to allow precise pressure control. The friendly user interface provides an option to program up to 50 varied, sequenced or individual shots. These systems have a user programmable “purge,” “timed” dispense cycle settings and a “teach mode” for determining the dispensing time.

Integration into semi-automatic and automatic machinery is made easy with the I/O interface connector that can be used to initiate and stop the dispense cycle with feedback to the host machine for the next cycle. A low-pressure warning feature is also included to help maintain uninterrupted dispensing.

### Specifications:

<b>Parameters:</b>	<b>Part Number</b>	<b>Description</b>
	TS550R	Pneumatic Valve Controller
	TS560R	Spray Valve Controller
	TS570R	Auger Valve Controller
	TS580R	PC Pump Controller
<b>Size:</b>	290mm x 211mm x 99mm	
<b>Weight:</b>	3.1kg	
<b>Pressure:</b>	0-100 PSI	
<b>Display:</b>	Touch Screen	
<b>Timing Range:</b>	0.008 – 99.9 seconds	
<b>Time Tolerance:</b>	+/- 0.001%	
<b>Input Voltage:</b>	100 – 240 VAC	
<b>Cycle Rate:</b>	900/minute	
<b>Cycle Modes:</b>	Timed, Interrupt, Teach, Purge	
<b>Connectivity:</b>	Ethernet, Wi-Fi	
<b>Certification:</b>	CE, TUV-GS	

### Accessories:

#### Fluid reservoirs

The controller can be used in combination with the TS2220, TS2250, TS1258, TS22100LS pressure tanks.

#### Fittings

Suitable for use with all luer lock, barbed and compression fittings.

#### Fluid Lines

Suitable for use with tubing, fluid lines and accessories.

#### Dispensing Tips

Suitable for use with our luer lock tip series.

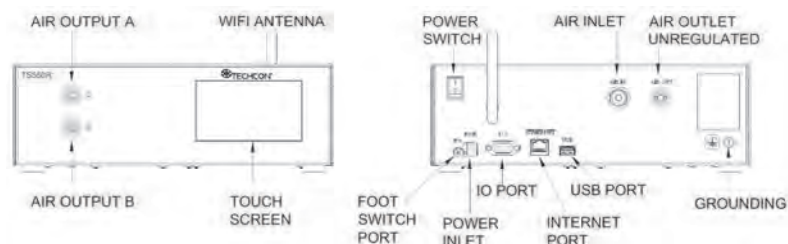

TS580R - PC Pump Controller

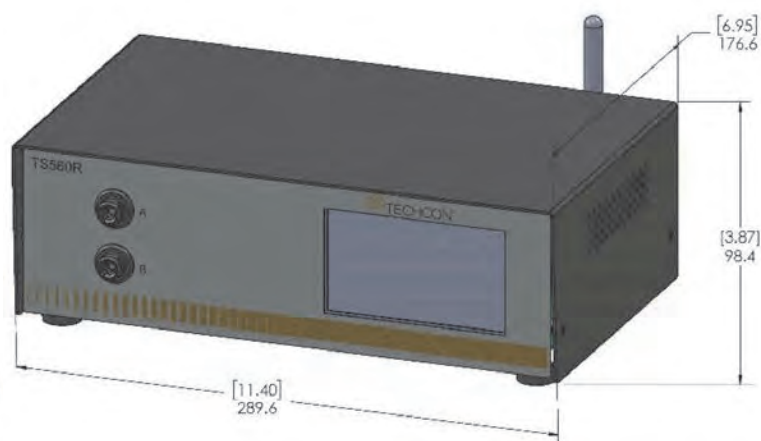

TS570R Setup Screen

Part Code	For Valves
TS550R	Pinch Valves, Needle Valves, Diaphragm Valves, Spool Valves
TS560R	Spray Valves
TS570R	Auger Motor Driven Valves
TS580R	PC Pump Valves

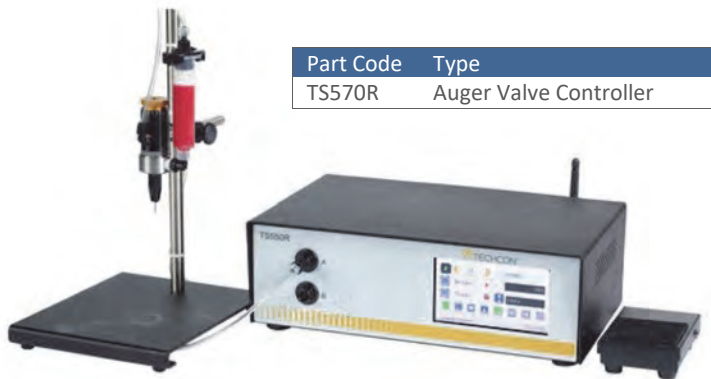

**Valve Controllers**

Part Code	Type
TS570R	Auger Valve Controller

The **TS570R** Smart Auger Valve Controller is capable of controlling all pneumatic valve series including: TS1212 Pinch Tube Valve, TS941/TS5322 Spool Valve, TS5420/TS5440 Needle Valves and TS5620/TS5622 Diaphragm Valves.

**Typical Applications**

Control diaphragm valve for bonding application, control mini-spool valve for form-in place gasket, pinch valve for epoxy resins and control needle valve for precision filling process.

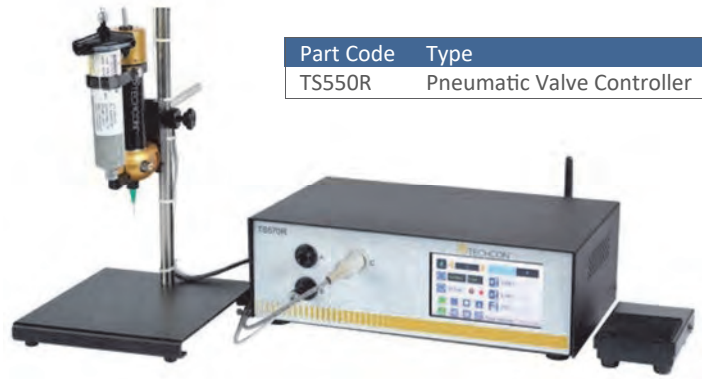

Part Code	Type
TS550R	Pneumatic Valve Controller

The **TS550R** Smart Valve Controller is capable of controlling all TS5000 and TS7000 Auger Valves.

**Typical Applications**

Control auger valves for Solder paste dispensing, encapsulation and potting applications.



Part Code	Type
TS560R	Spray Valve Controller

The **TS560R** Smart Spray Valve Controller is capable of controlling all precision TS5520 and TS5540 Spray Valves.

**Typical Applications**

Control spray valves for conformal coating, lubrication and marking applications.

**Key Features**

- Touch Screen interface for easy setup and operation
- Industry 4.0 for "Smart Factory" integration
- Universal power supply for worldwide use
- Digital pressure regulator for precise control
- Digital timing control for repeatable output

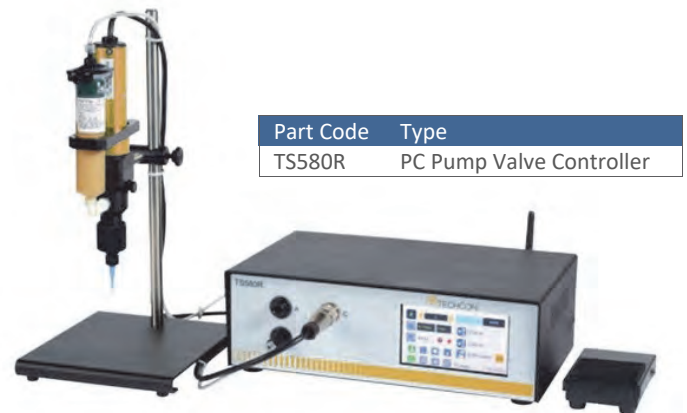
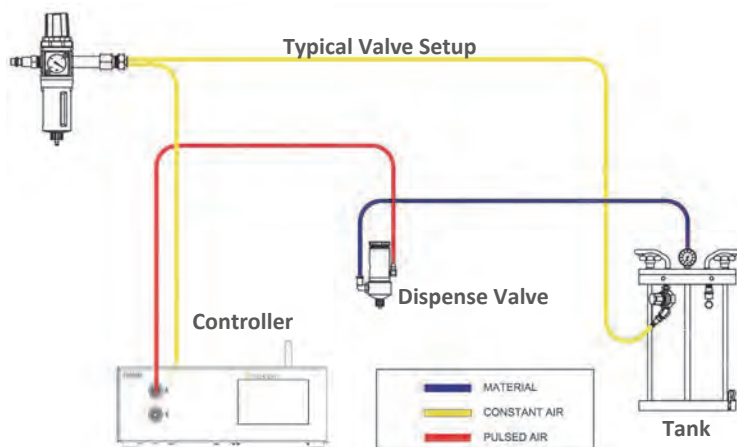

Part Code	Type
TS580R	PC Pump Valve Controller

The **TS580R** Smart PC Pump Controller is capable of controlling all TS8100 series PC Pumps.

**Typical Applications**

Underfilling PCBA components, encapsulation & potting applications, applying lubrication on automotive parts, and dispensing pastes and flux.



The **VC1195N** is a 4-way valve controller for one or two valves simultaneously. Also for all double-acting valves where air is used to open and then air to close the piston.

**Specifications**

W x D x H: 266 x 210 x 72mm  
 Weight: 1.92kg  
 Activation Pressure: 70 psi (4.8bar) Min  
 Max Fluid Pressure: 100 psi (6.9bar)  
 Timer Tolerance: +/- 0.001%

Part Code	Type
VCE1195N	220V AC
VC1195A	110V AC

## Pressure tanks

### Pressure Pot Tanks

#### Specifications: 5 Liter

Size: 383mm H, 254mm W  
 Chamber: 280mm H, 155mm W  
 Weight: 9.5kg  
 Pressure: 100 PSI Maximum  
 Volume: 5 Liters  
 Materials: Anodised Aluminium  
 Certification: CE

Part Code	Type
TS1258	5 Liter Tank



The pressure pot tank is designed to accommodate low to medium viscosity fluid including solvents, adhesives, as well as Cyanoacrylates and UVs. The fluid feed line is located in the centre of the lid for a direct and continuous feed path from the reservoir to the dispensing valve. For reactive adhesives such as Cyanoacrylates, the glue bottle is placed directly inside. Used with flexible feed tubing or luer lock fluid lines.

Available with stainless steel chambers or aluminium and in a range of sizes. Some versions have low level electric sensors for non-reactive liquids. Standard tanks are high pressure (0-75 PSI or 0-100 PSI). Use low pressure versions (0-15 PSI) for watery liquids only. All tanks are CE approved and supplied with user guides.

#### Specifications: 1.8 Liter

Size: 318mm H, 190mm W  
 Chamber: 165mm H, 121mm W  
 Weight: 4.7kg  
 Pressure: 70 PSI Maximum  
 Volume: 1.8 Liters  
 Materials: Brushed Aluminium  
 Certification: CE

Part Code	Type
TS1254	1.8 Liter Tank



#### Specifications: 2 Litre

Size: 300mm H, 210mm W  
 Chamber: 285mm H, 207mm W  
 Weight: 3kg  
 Pressure: 75 PSI Maximum  
 Volume: 2 Litres  
 Materials: Stainless Steel, Aluminium  
 Certification: CE

Part Code	Type
TS2220	2 Litre Tank 0-75 PSI
TS2220LS	2 Litre Tank 0-75 PSI , Level Sensor
TS2215	2 Litre Tank 0-15 PSI



#### Specifications: 3 Litre

Size: 350mm H, 180mm W  
 Chamber: 230mm H, 130mm W  
 Weight: 3.5kg  
 Pressure: 100 PSI Maximum  
 Volume: 3 Litres  
 Materials: 304 Stainless Steel  
 Certification: CE

Part Code	Type
AD8203	3 Litre Tank



#### Specifications: 4 Litre

Size: 235mm H, 160mm W  
 Chamber: 230mm H, 150mm W  
 Weight: 6kg  
 Pressure: 100 PSI Maximum  
 Volume: 5 Litres  
 Materials: 304 Stainless Steel  
 Certification: CE

Part Code	Type
AD8204	4 Litre Tank



#### Specifications: 5 Litre

Size: 370mm H, 270mm W  
 Chamber: 355mm H, 267mm W  
 Weight: 5kg  
 Pressure: 75 PSI Maximum  
 Volume: 5 Litres  
 Materials: Stainless Steel, Aluminium  
 Certification: CE

Part Code	Type
TS2250	5 Litre Tank 0-75 PSI
TS2250LS	5 Litre Tank 0-75 PSI, Level
TS2515	5 Litre Tank 0-15 PSI



#### Specifications: 10 Litre

Size: 415mm H, 310mm W  
 Chamber: 400mm H, 307mm W  
 Weight: 7kg  
 Pressure: 70 PSI Maximum  
 Volume: 10 Litres  
 Materials: Stainless Steel, Aluminium  
 Certification: CE

Part Code	Type
TS22100	10 Litre Tank 0-75 PSI
TS22100LS	10 Litre Tank 0-75 PSI, Level
TS2210015	10 Litre Tank 0-15 PSI



#### Specifications: 16 Litre

Size: 495mm H, 365mm W  
 Chamber: 480mm H, 362mm W  
 Weight: 12kg  
 Pressure: 45 PSI Maximum  
 Volume: 16 Litres  
 Materials: Stainless Steel, Aluminium  
 Certification: CE

Part Code	Type
TS2216	16 Litre Tank 0-45 PSI
TS2216LS	16 Litre Tank 0-45 PSI, Level
TS2615	16 Litre Tank 0-15 PSI



#### Specifications: 30 Litre

Size: 424mm H, 316mm W  
 Chamber: 410mm H, 310mm W  
 Weight: 25kg  
 Pressure: 100 PSI Maximum  
 Volume: 30 Litres  
 Materials: 304 Stainless Steel  
 Certification: CE

Part Code	Type
AD8230	30 Litre Tank



**Lightweight Pressure Tanks**

The pressure pot tank is designed to accommodate low to medium viscosity fluid including solvents, adhesives, as well as Cyanoacrylates and UVs.

The fluid feed line is located in the centre of the lid for a direct and continuous feed path from the reservoir to the dispensing valve. For reactive adhesives such as Cyanoacrylates, the glue bottle is placed directly inside. Used with flexible feed tubing or luer lock fluid lines.



**Specifications: 1 Liter**  
**Size:** 317mm H, 158mm W  
**Chamber:** 244mm H, 95mm W  
**Weight:** 2.1kg  
**Pressure:** 60 PSI Maximum  
**Volume:** 1 Litre  
**Materials:** Anodised Aluminium  
**Certification:** CE

Part Code	Type
TS1251	1 Liter Tank



**Specifications: 500 Gram**  
**Size:** 254mm H, 133mm W  
**Chamber:** 181mm H, 82mm W  
**Weight:** 1.0kg  
**Pressure:** 60 PSI Maximum  
**Volume:** 500 Gram  
**Materials:** Anodised Aluminium  
**Certification:** CE

Part Code	Type
TS1205	500 Gram Tank



**Specifications: 1 Liter**  
**Size:** 273mm H, 158mm W  
**Chamber:** 203mm H, 121mm W  
**Weight:** 2.54kg  
**Pressure:** 60 PSI Maximum  
**Volume:** 1 Litre  
**Materials:** Anodised Aluminium  
**Certification:** CE

Part Code	Type
TS1251W	1 Liter Tank Wide

**High Pressure Tanks**

Type 304 stainless steel pressure pots with adjustable regulators. Safety relief valve set at 100 PSI. Easy opening to pour in liquid. Suitable for use with many liquids. Supplied with fluid lines and connector fittings. Feeds a consistent supply of liquid to any dispensing valve.

Part Code	Size	Volume	Weight	Pressure	Material
TS1260	1 Gallon	3.8 Liter	3.5kg	0-100 PSI	Stainless Steel
TS1262	2 Gallon	7.6 Liter	6.5kg	0-100 PSI	Stainless Steel
TS1263	3 Gallon	11.5 Liter	8.5kg	0-100 PSI	Stainless Steel
TS1265	5 Gallon	19 Liter	12.5kg	0-100 PSI	Stainless Steel

**Cartridge Retainer Systems**

Retainers with sleeve, air cap and airline hose for use with Techcon and Semco cartridges as well as pre-filled sealant tubes. Safe for use to 100 PSI. Ideal for use with high viscosity pastes and gels as well as for low viscosity watery liquids to feed materials to dispensing valves.



Volume	Weight	Pressure	Material
AD-6OZ	6 Ounce	177ml/cc	0.2kg
AD-8OZ	8 Ounce	237ml/cc	0.3kg
ADL-1211M	10 Ounce	310ml/cc	0.4kg
AD-120OZ	12 Ounce	355ml/cc	0.5kg
TS918-20CSR	20 Ounce	591ml/cc	0.9kg
TS918-32CS	32 Ounce	960ml/cc	1.1kg

Slotted body retainer sleeves. Supplied with standard air-cap & hose. Optional regulator cap ordered separately.

Part Code	Size	Volume	Weight	Pressure	Material
TS918-25CS	2.5 Ounce	75ml/75cc	0.2kg	100 PSI Max.	Anodised Aluminium
TS918-60CS	6 Ounce	177ml/cc	0.2kg	100 PSI Max.	Anodised Aluminium
TS918-80CS	8 Ounce	237ml/cc	0.3kg	100 PSI Max.	Anodised Aluminium
TS918-120CS	12 Ounce	355ml/cc	0.3kg	100 PSI Max.	Anodised Aluminium
5601377	Optional Regulator Air Cap		0.2kg	100 PSI Max.	Nylon, Brass, PE



Retainers for use with 310ml, 10oz or 1/10 gallon silicone and sealant adhesive caulking tubes.

Part Code	Size	Volume	Weight	Pressure	Material
ADL-1211M	10 Ounce	310ml/cc	0.4kg	100 PSI Max.	Anodised Steel Standard
ADL-1211MMS	10 Ounce	310ml/cc	0.4kg	100 PSI Max.	Anodised Steel Slotted
580091A	10 Ounce	310ml/cc	0.2kg	100 PSI Max.	Nylon Lightweight
TS918-110CS	10 Ounce	310ml/cc	0.4kg	100 PSI Max.	Anodised Aluminium





## Luer Lock Fluid Line Tubing

High pressure male and female luer lock fluid lines for safe and leak free transfer of liquids, adhesives solvents and other fluids from pressure pots to dispensing valves. Available in a range of lengths and colours. Small bore fluid lines for low to medium viscosity liquids. All tubing is industrial grade safe and silicone free.



### Luer Lock Fluid Lines:

Part Code	Length	ID	Connection	Colour	Material
TSD126-312PK	12 Inch	2.54mm	Female/Male	Natural	Polyethylene
TSD126-312BPK	18 Inch	2.54mm	Female/Male	Black	Polyethylene
TSD126-118PK	18 Inch	2.54mm	Male/Open	Natural	Polyethylene
TSD126-218PK	18 Inch	2.54mm	Female/Open	Natural	Polyethylene
TSD126-318PK	18 Inch	2.54mm	Female/Male	Natural	Polyethylene
TSD126-418PK	18 Inch	2.54mm	Female/Fem	Natural	Polyethylene
TSD126-324BPK	24 Inch	2.54mm	Female/Male	Black	Polyethylene
TSD126-124PK	24 Inch	2.54mm	Male/Open	Natural	Polyethylene
TSD126-224PK	24 Inch	2.54mm	Female/Open	Natural	Polyethylene
TSD126-324PK	24 Inch	2.54mm	Female/Open	Natural	Polyethylene
TSD126-424PK	24 Inch	2.54mm	Female/Fem	Natural	Polyethylene
TSD126-524PK	24 Inch	2.54mm	Male/Male	Natural	Polyethylene
TSD126-336BPK	36 Inch	2.54mm	Female/Male	Black	Polyethylene
TSD126-136BPK	36 Inch	2.54mm	Male/Open	Natural	Polyethylene
TSD126-236BPK	36 Inch	2.54mm	Female/Open	Natural	Polyethylene
TSD126-336BPK	36 Inch	2.54mm	Female/Male	Natural	Polyethylene
TSD126-436BPK	36 Inch	2.54mm	Female/Fem	Natural	Polyethylene
TSD126-360BPK	60 Inch	2.54mm	Female/Male	Black	Polyethylene

### Key Features

- Twist-Lock quick attachment
- Can be "daisy-chained" to increase length
- High pressure rated to 100 PSI
- Super flexible tubing
- Small bore diameter not intrusive

## Flexible Feed Tubing

High pressure flexible feed tubing for safe and leak free transfer of liquids, adhesives solvents and other fluids from pressure pots to dispensing valves. Available in a wide range of lengths and colours. Use feed tubing for more viscous fluids. All tubing is industrial grade safe and silicone free.



### Flexible Feed Tubing:

Part Code	Length	ID / OD	Connection	Colour	Material
TSD1099-11	10 ft.	1/8" - 1/4"	Open	Natural	Polyurethane
TSD1099-12	10 ft.	1/8" - 3/16"	Open	Natural	Polyurethane
TSD1099-24	10 ft.	1/8" - 1/4"	Open	Natural	Polyethylene
TSD1099-25	10 ft.	1/8" - 1/4"	Open	Black	Polyethylene
TSD1099-23	10 ft.	1/4" - 3/8"	Open	Natural	Polyethylene
TSD1099-22	10 ft.	1/4" - 3/8"	Open	Black	Polyethylene
TSD1099-45	10 ft.	4mm - 6mm	Open	Natural	Polyethylene
TSD1099-46	10 ft.	4mm - 6mm	Open	Black	Polyethylene
TSD1099-67	1000mm	4mm - 6mm	Open	White	PTFE

### Key Features

- Cut to order length as required
- Use with barb or compression fittings
- High pressure rated to 100 PSI
- Allows higher material flow
- Medical approved materials

## Stainless Steel Rigid Tubing

Super high pressure rigid stainless steel feed tubing for safe and leak free transfer of liquids, adhesives solvents and other fluids from pressure pots to dispensing valves. Available in a wide range of lengths. Type 304 high grade material. All tubing is industrial grade safe and silicone free.



Part Code	Gage Size	Length	ID / OD	Material
SST5	5	2 x 1 Metre	4.50mm / 5.50mm	Type 304 Stainless Steel
SST6	6	2 x 1 Metre	4.04mm / 4.98mm	Type 304 Stainless Steel
SST7	7	2 x 1 Metre	3.66mm / 4.49mm	Type 304 Stainless Steel
SST8	8	2 x 1 Metre	3.28mm / 4.04mm	Type 304 Stainless Steel
SST9	9	2 x 1 Metre	2.87mm / 3.69mm	Type 304 Stainless Steel
SST10	10	2 x 1 Metre	2.50mm / 3.30mm	Type 304 Stainless Steel
SST11	11	2 x 1 Metre	2.30mm / 2.95mm	Type 304 Stainless Steel
SST12	12	2 x 1 Metre	2.18mm / 2.77mm	Type 304 Stainless Steel
SST13	13	2 x 1 Metre	1.94mm / 2.40mm	Type 304 Stainless Steel
SST14	14	2 x 1 Metre	1.64mm / 2.10mm	Type 304 Stainless Steel
SST15	15	2 x 1 Metre	1.38mm / 1.84mm	Type 304 Stainless Steel
SST16	16	2 x 1 Metre	1.20mm / 1.65mm	Type 304 Stainless Steel
SST17	17	2 x 1 Metre	1.09mm / 1.50mm	Type 304 Stainless Steel
SST18	18	2 x 1 Metre	0.91mm / 1.25mm	Type 304 Stainless Steel
SST19	19	2 x 1 Metre	0.70mm / 1.10mm	Type 304 Stainless Steel
SST20	20	2 x 1 Metre	0.60mm / 0.90mm	Type 304 Stainless Steel
SST21	21	2 x 1 Metre	0.51mm / 0.81mm	Type 304 Stainless Steel
SST22	22	2 x 1 Metre	0.40mm / 0.71mm	Type 304 Stainless Steel
SST23	23	2 x 1 Metre	0.34mm / 0.63mm	Type 304 Stainless Steel
SST24	24	2 x 1 Metre	0.31mm / 0.56mm	Type 304 Stainless Steel
SST25	25	2 x 1 Metre	0.26mm / 0.51mm	Type 304 Stainless Steel

**Male Luer Lock to Thread Fittings**

Luer lock fittings offer a quick and secure attachment for simple twist-on and twist-off. Safe for use under pressure for leak free dispensing. High quality luer lock fittings for use with metering valves, pressure pots, cartridges and syringe equipment. Industrial grade safe and silicone free.

Part Code	Inlet	Outlet	Colour	Material
TSD931-7	1/4" NPT Male Thread	Male Luer	White	Polypropylene
TSD931-14	1/4" NPT Male Thread	Male Luer	Black	Polypropylene
TSD931-7C	1/4" NPT Male Thread	Male Luer	Clear	Polypropylene
TSD931-7N	1/4" NPT Male Thread	Male Luer	Clear	Nylon
TSD931-7M	1/4" NPT Male Thread	Male Luer	Silver	Nickel Plated Brass
TSD931-6	1/8" NPT Male Thread	Male Luer	White	Polypropylene
TSD931-57N	1/8" NPT Male Thread	Male Luer	White	Nylon
TSD931-57	1/8" NPT Male Thread	Male Luer	Black	Nylon
TSD931-57M	1/8" NPT Male Thread	Male Luer	Silver	Nickel Plated Brass
TSD931-26C	10-32" Male Thread	Male Luer	Clear	Polypropylene
TSD931-26M	10-32" Male Thread	Male Luer	Silver	Nickel Plated Brass
TSD931-1032S	10-32" Male Thread	Male Luer	Silver	Stainless Steel
TSD931-26BM	10-32" Female Thread	Male Luer	Silver	Nickel Plated Brass
TSD931-26SM	10-32" Female Thread	Male Luer	Silver	Stainless Steel
TSD931-49C	1/4-28" Male Thread	Male Luer	Clear	Polypropylene
TSD931-49	1/4-28" Male Thread	Male Luer	White	Nylon
TSD931-49B	1/4-28" Male Thread	Male Luer	Silver	Nickel Plated Brass
TSD931-49BS	1/4-28" Male Thread	Male Luer	Silver	Nickel Plated Brass
TSD931-91	1/4-28" Male Thread	Male Luer	Black	Delrin
TSD931-8	1/4-32" Male Thread	Male Luer	White	Celcon
TSD931-22	1/4-32" Male Thread	Male Luer	Black	Acetal
TSD931-8B	1/4-32" Male Thread	Male Luer	Silver	Nickel Plated Brass
TSD931-8SS	1/4-32" Male Thread	Male Luer	Silver	Stainless Steel
TSD931-1418MM	1/4-18" Male Thread	Male Luer	Silver	Nickel Plated Brass
TSD931-1418MM	1/4-18" Male Thread	Male Luer	Silver	Stainless Steel
TSD931-5	5/16-28" Male Thread	Male Luer	White	Acetal
TSD931-32	5/16-28" Male Thread	Male Luer	Black	Delrin
TSD931-1	5/16-28" Male Thread	Male Luer	Silver	Nickel Plated Brass
TSD931-M56B	M5 6mm Male Thread	Male Luer	Silver	Nickel Plated Brass
TSD931-M56S	M5 6mm Male Thread	Male Luer	Silver	Stainless Steel

**Female Luer Lock to Thread Fittings**

Part Code	Inlet	Outlet	Colour	Material
TSD931-15	1/4" NPT Male Thread	Female Luer	Black	Polypropylene
TSD931-15C	1/4" NPT Male Thread	Female Luer	Clear	Polypropylene
TSD931-15NPB	1/4" NPT Male Thread	Female Luer	Silver	Nickel Plated Brass
TSD931-15SS	1/4" NPT Male Thread	Female Luer	Silver	Stainless Steel
TSD931-61P	1/8" NPT Male Thread	Female Luer	Clear	Polypropylene
TSD931-54	1/8" NPT Male Thread	Female Luer	Black	Nylon
AD931-16M	1/8" NPT Male Thread	Female Luer	Silver	Nickel Plated Brass
TSD931-54SS	1/8" NPT Male Thread	Female Luer	Silver	Stainless Steel
TSD931-75PK	1/8" NPT Male Thread Elbow	Female Luer	Black	Polypropylene
TSD931-54PE	1/8" NPT Male Thread Elbow	Female Luer	White	Nylon
TSD931-54PP	1/8" NPT Male Thread Elbow	Female Luer	Clear	Polypropylene
TSD931-30	10-32" Male Thread	Female Luer	Clear	Polypropylene
TSD931-30N	10-32" Male Thread	Female Luer	Clear	Nylon
TSD931-26MF	10-32" Male Thread	Female Luer	Silver	Nickel Plated Brass
TSD931-26MS	10-32" Male Thread	Female Luer	Silver	Stainless Steel
TSD931-26MFB	10-32" Female Thread	Female Luer	Silver	Nickel Plated Brass
TSD931-26MFS	10-32" Female Thread	Female Luer	Silver	Stainless Steel
TSD931-23	1/4-28" Male Thread	Female Luer	Clear	Polypropylene
TSD931-23N	1/4-28" Male Thread	Female Luer	Clear	Nylon
AD931-49M	1/4-28" Male Thread	Female Luer	Silver	Nickel Plated Brass
AD931-49SS	1/4-28" Male Thread	Female Luer	Silver	Stainless Steel
TSD931-9	1/4-32" Male Thread	Female Luer	Black	Celcon
TSD931-31	1/4-32" Male Thread	Female Luer	Silver	Nickel Plated Brass
TSD931-49SS	1/4-32" Male Thread	Female Luer	Silver	Stainless Steel
TSD931-1418M	1/4-18" Male Thread	Female Luer	Silver	Nickel Plated Brass
TSD931-1418MSS	1/4-18" Male Thread	Female Luer	Silver	Stainless Steel
TSD931-M56	M5 6mm Male Thread	Female Luer	Silver	Nickel Plated Brass
TSD931-M56SS	M5 6mm Male Thread	Female Luer	Silver	Stainless Steel
TSD931-M610M	M6 10mm Male Thread	Female Luer	Silver	Nickel Plated Brass
TSD931-M610S	M6 10mm Male Thread	Female Luer	Silver	Stainless Steel
TSD931-M810M	M8 10mm Male Thread	Female Luer	Silver	Nickel Plated Brass



## Male Luer Lock to Barbed Fittings

Luer lock fittings offer a quick and secure attachment for simple twist-on and twist-off. Safe for use under pressure for leak free dispensing. High quality luer lock fittings for use with metering valves, pressure pots, cartridges and syringe equipment. Industrial grade safe and silicone free.

Part Code	Inlet	Outlet	Colour	Material
TSD931-16	0.130" OD Barb	Male Luer	Natural	Acetal
TSD931-17	0.170" OD Barb	Male Luer	Natural	Acetal
TSD931-17PP	0.170" OD Barb	Male Luer	Clear	Polypropylene
TSD931-17AA	0.170" OD Barb	Male Luer	White	Nylon
TSD931-17AB	1/8" OD Barb	Male Luer	Clear	Polypropylene
TSD931-28B	1/8" OD Barb	Male Luer	Silver	Nickel Plated Brass
TSD931-28D	1/8" OD Barb	Male Luer	Silver	Stainless Steel
TSD931-17AE	1/4" OD Barb	Male Luer	Clear	Polypropylene
TSD931-28ST	1/4" OD Barb	Male Luer	Silver	Stainless Steel
TSD931-17AP	1/16" OD Barb	Male Luer	Clear	Polypropylene
TSD931-28G	1/16" OD Barb	Male Luer	Silver	Nickel Plated Brass
TSD931-17PZ	3/16" OD Barb	Male Luer	Clear	Polypropylene
TSD931-28B	3/16" OD Barb	Male Luer	Clear	Nickel Plated Brass
TSD931-17AC	3/32" OD Barb	Male Luer	Clear	Polypropylene
TSD931-17AD	5/32" OD Barb	Male Luer	Clear	Polypropylene
TSD931-1632ML	1/16-3/32" OD Barb	Male Luer	Silver	Nickel Plated Brass
TSD931-1632MS	1/16-3/32" OD Barb	Male Luer	Silver	Stainless Steel
TSD931-14516M	1/4-5/16" OD Barb	Male Luer	Silver	Nickel Plated Brass
TSD931-14516S	1/4-5/16" OD Barb	Male Luer	Silver	Stainless Steel
TSD931-18316M	1/8-3/16" OD Barb	Male Luer	Silver	Nickel Plated Brass
TSD931-18316S	1/8-3/16" OD Barb	Male Luer	Silver	Stainless Steel
TSD931-15MB	1.5mm OD Barb	Male Luer	Silver	Nickel Plated Brass
TSD931-20MB	2.0mm OD Barb	Male Luer	Silver	Nickel Plated Brass
TSD931-35MB	3.5mm OD Barb	Male Luer	Silver	Nickel Plated Brass
TSD931-40MB	4.0mm OD Barb	Male Luer	Silver	Nickel Plated Brass
TSD931-40MS	4.0mm OD Barb	Male Luer	Silver	Stainless Steel
TSD931-50MB	5.0mm OD Barb	Male Luer	Silver	Nickel Plated Brass
TSD931-50MS	5.0mm OD Barb	Male Luer	Silver	Stainless Steel
TSD931-60MB	6.0mm OD Barb	Male Luer	Silver	Nickel Plated Brass
TSD931-60MS	6.0mm OD Barb	Male Luer	Silver	Stainless Steel
TSD931-80MB	8.0mm OD Barb	Male Luer	Silver	Nickel Plated Brass
TSD931-80MS	8.0mm OD Barb	Male Luer	Silver	Stainless Steel
TSD931-10MB	10mm OD Barb	Male Luer	Silver	Nickel Plated Brass



## Female Luer Lock to Barbed Fittings

Part Code	Inlet	Outlet	Colour	Material
TSD931-10	0.100" OD Barb	Female Luer	Natural	Acetal
TSD931-12	0.130" OD Barb	Female Luer	Natural	Acetal
TSD931-13	0.170" OD Barb	Female Luer	Natural	Acetal
TSD931-13C	0.170" OD Barb	Female Luer	Clear	Polypropylene
TSD931-17PR	1/16" OD Barb	Female Luer	Clear	Polypropylene
TSD931-28R	1/16" OD Barb	Female Luer	Silver	Nickel Plated Brass
TSD931-17PT	3/16" OD Barb	Female Luer	Clear	Polypropylene
TSD931-17PQ	3/32" OD Barb	Female Luer	Clear	Polypropylene
TSD931-17PS	5/32" OD Barb	Female Luer	Clear	Polypropylene
TSD931-17PL	1/8" OD Barb	Female Luer	Clear	Polypropylene
TSD931-17PN	1/8" OD Barb	Female Luer	White	Nylon
TSD931-17PA	1/4" OD Barb	Female Luer	Clear	Polypropylene
TSD931-1632MB	1/16-3/32" OD Barb	Female Luer	Silver	Nickel Plated Brass
TSD931-1632SS	1/16-3/32" OD Barb	Female Luer	Silver	Stainless Steel
TSD931-14516FL	1/4-5/16" OD Barb	Female Luer	Silver	Nickel Plated Brass
TSD931-18316M	1/8-3/16" OD Barb	Female Luer	Silver	Nickel Plated Brass
TSD931-28MS	1/8-3/16" OD Barb	Female Luer	Silver	Stainless Steel
TSD931-122M	1.5mm OD Barb	Female Luer	Silver	Nickel Plated Brass
TSD931-282M	2.0mm OD Barb	Female Luer	Silver	Nickel Plated Brass
TSD931-385M	3.5mm OD Barb	Female Luer	Silver	Nickel Plated Brass
TSD931-284M	4.0mm OD Barb	Female Luer	Silver	Nickel Plated Brass
TSD931-284SS	4.0mm OD Barb	Female Luer	Silver	Stainless Steel
TSD931-M65B	5.0mm OD Barb	Female Luer	Silver	Nickel Plated Brass
TSD931-285SS	5.0mm OD Barb	Female Luer	Silver	Stainless Steel
TSD931-286M	6.0mm OD Barb	Female Luer	Silver	Nickel Plated Brass
TSD931-286SS	6.0mm OD Barb	Female Luer	Silver	Stainless Steel
TSD931-287M	7.0mm OD Barb	Female Luer	Silver	Nickel Plated Brass
TSD931-288M	8.0mm OD Barb	Female Luer	Silver	Nickel Plated Brass
TSD931-288SS	8.0mm OD Barb	Female Luer	Silver	Nickel Plated Brass
TSD931-281M	10mm OD Barb	Female Luer	Silver	Nickel Plated Brass





**Luer to Luer Transfer Fittings**

Precision luer to luer fittings and tee pieces. Safe for use under pressure for leak free dispensing. High quality luer lock fittings for use with metering valves, pressure pots, cartridges and syringe equipment. Industrial grade safe and silicone free.

Part Code	Inlet	Outlet	Colour	Material
TSD931-28	Female Luer Straight	Female Luer	Clear	Polypropylene
TSD931-28N	Female Luer Straight	Female Luer	Clear	Nylon
TSD931-28NPB	Female Luer Straight	Female Luer	Silver	Nickel Plated Brass
TSD931-28SS	Female Luer Straight	Female Luer	Silver	Stainless Steel
TSD931-77	Female Luer Straight	Male Luer	Clear	Polypropylene
TSD931-82C	Female Luer Straight	Male Luer	Clear	Nylon
TSD931-82CP	Female Luer Straight	Male Luer	Clear	Polycarbonate
TSD931-76	Female Luer Straight	Male Luer	Silver	Nickel Plated Brass
TSD931-76SS	Female Luer Straight	Male Luer	Silver	Stainless Steel
TSD931-28A	Female Luer Elbow	Female Luer	Clear	Polypropylene
TSD931-28N	Female Luer Elbow	Female Luer	White	Nylon
TSD931-81B	Female Luer Elbow	Male Luer	Black	Nylon
TSD931-87	Female Luer Tee	2 x Female Luer	Clear	Nylon
TSD931-552M	Male Luer Tee	2 x Female Luer	Silver	Nickel Plated Brass
TSD931-553M	Male Luer Tee	2 x Female Luer	Silver	Nickel Plated Brass
TSD931-554M	Female Luer Tee	2 x Male Luer	Silver	Nickel Plated Brass
TSD931-88	Female Luer Tee	2 x Male Luer	Silver	Stainless Steel

**Luer Lock Stopcock Fittings**

Luer lock and barbed stopcocks for fluid transfer. Safe for use under pressure for leak free dispensing. High quality luer lock fittings for use with metering valves, pressure pots, cartridges and syringe equipment. Industrial grade safe and silicone free.

Part Code	Inlet	Outlet	Colour	Material
TSD931-42	Female Luer Straight 1 Way	Male Luer	Clear	Polycarbonate
TSD931-42B	Female Luer Straight 1 Way	Male Luer	Black	PVDF
TSD931-42ML	Female Luer Straight 1 Way	Male Luer	Silver	Nickel Plated Brass
TSD931-6021HP	Female Luer Straight 1 Way	Male Luer	Silver	Nickel Plated Brass
TSD931-6021R	Female Luer Straight 1 Way	Male Luer	Silver	Nickel Plated Brass
TSD931-42SS	Female Luer Straight 1 Way	Male Luer	Silver	Stainless Steel
TSD931-6020	Female Luer Straight 1 Way	Female Luer	Silver	Stainless Steel
TSD931-6023	Male Luer Straight 1 Way	Male Luer	Silver	Nickel Plated Brass
TSD931-6029	6mm OD Barb Straight 1 Way	Male Luer	Silver	Nickel Plated Brass
TSD931-6030	8mm OD Barb Straight 1 Way	Male Luer	Silver	Nickel Plated Brass
TSD931-6041	M5 Thread Straight 1 Way	Female Luer	Silver	Nickel Plated Brass
TSD931-43	Female Luer Tee 3 Way	Male Luer	Clear	Polycarbonate
TSD931-6001T	Female Luer Tee 3 Way	M/F Luer	Silver	Nickel Plated Brass
TSD931-6002	Female Luer Tee 3 Way	Female Luer	Silver	Nickel Plated Brass
TSD931-6017T	Female Luer Tee 3 Way	Female Luer	Silver	Nickel Plated Brass
TSD931-6017TF	Male Luer Tee 3 Way	Female Luer	Silver	Nickel Plated Brass
TSD931-6055	Female Luer Tee 3 Way	Male Luer	Silver	Nickel Plated Brass
TSD931-6056	Male Luer Tee 3 Way	Female Luer	Silver	Nickel Plated Brass
TSD931-6011HP	Female Luer Tee 3 Way	M/F Luer	Silver	Nickel Plated Brass
TSD931-6011TF	Male Luer Tee 3 Way	M/F Luer	Silver	Nickel Plated Brass
TSD931-6017SS	Male Luer Tee 3 Way	Female Luer	Silver	Stainless Steel
TSD931-6014T	Female Luer Tee 3 Way	Male Luer	Silver	Nickel Plated Brass
TSD931-6011SS	Female Luer Tee 3 Way	M/F Luer	Silver	Stainless Steel
TSD931-6010T	Female Luer Tee 3 Way	M Luer/ Barb	Silver	Nickel Plated Brass
TSD931-444	Female Luer Tee 4 Way	M/F Luer	Clear	Polycarbonate

**Manifold Fittings**

Manifold fittings for fluid and air transfer. Safe for use under pressure for leak free dispensing. High quality luer lock fittings for use with metering valves, pressure pots, cartridges and syringe equipment. Industrial grade safe and silicone free.

Part Code	Inlet	Outlet	Colour	Material
TS918-46	1/4" NPT Female or Luer	4 x Male Luer or 1/8"	Black	Delrin
AD2250-4	1/8" NPT Female Thread	4 x 1/8" NPT Thread	Black	Delrin
560540-1/4	1/4" OD Tube Fitting	2 x 1/4" OD Tube	White	Nylon
560540	3/8" OD Tube Fitting	2 x 3/8" OD Tube	White	Nylon
560542-1/4	1/4" OD Tube Fitting	4 x 1/4" OD Tube	White	Nylon
560542	3/8" OD Tube Fitting	4 x 3/8" OD Tube	White	Nylon
560543-1/4	1/4" OD Tube Fitting	6 x 1/4" OD Tube	White	Nylon
560543	3/8" OD Tube Fitting	6 x 3/8" OD Tube	White	Nylon
560057	Air Manifold Quick Connect	4 x Quick Connect	White	Nylon
TS98-6SS	1/4" NPT Female Thread	6 x 1/8" NPT Thread	Silver	Stainless Steel



## Fluid fittings

### Thread to Barbed Fittings

Precision thread fittings to barbed tube connection. Safe for use under pressure for leak free dispensing. High quality luer lock fittings for use with metering valves, pressure pots, cartridges and syringe equipment. Industrial grade safe and silicone free.

Part Code	Inlet	Outlet	Colour	Material
TSD933-1	1/8" NPT Male Thread Elbow	1/4" OD Barb	Clear	Polypropylene
TSD933-2	1/8" NPT Male Thread Elbow	3/8" OD Barb	Clear	Polypropylene
TSD933-3	1/4" NPT Male Thread Elbow	1/4" OD Barb	Clear	Polypropylene
TSD933-4	1/4" NPT Male Thread Elbow	3/8" OD Barb	Clear	Polypropylene
TSD933-5	1/4" NPT Male Thread Elbow	1/2" OD Barb	Clear	Polypropylene
TSD933-6	3/8" NPT Male Thread Elbow	1/4" OD Barb	Clear	Polypropylene
TSD933-7	3/8" NPT Male Thread Elbow	3/8" OD Barb	Clear	Polypropylene
TSD933-8	1/8" NPT Male Thread Elbow	3/8" OD Barb	White	Nylon
TSD933-9	1/8" NPT Male Thread Elbow	5/16" OD Barb	White	Nylon
TSD933-10	1/4" NPT Male Thread Elbow	1/8" OD Barb	White	Nylon
TSD933-11	1/4" NPT Male Thread Elbow	3/16" OD Barb	White	Nylon
TSD933-12	1/4" NPT Male Thread Elbow	1/4" OD Barb	White	Nylon
TSD933-13	1/4" NPT Male Thread Elbow	3/8" OD Barb	White	Nylon
TSD933-14	3/8" NPT Male Thread Elbow	1/4 OD Barb	White	Nylon
TSD933-15	3/8" NPT Male Thread Elbow	3/8 OD Barb	White	Nylon
TSD931-56	1/4" NPT Male Thread Straight	1/8" OD Barb	Clear	Polyethylene
TSD931-56PP	1/4" NPT Male Thread Straight	1/8" OD Barb	Clear	Polypropylene
TSD931-55N	1/4" NPT Male Thread Straight	1/4" OD Barb	Clear	Polyethylene
TSD931-55PP	1/4" NPT Male Thread Straight	1/4" OD Barb	Clear	Polypropylene
TSD931-55	1/4" NPT Male Thread Straight	1/4" OD Barb	Black	Nylon
TSD931-59PP	1/4" NPT Male Thread Straight	3/8" OD Barb	Clear	Polypropylene
TSD931-62PP	1/4" NPT Male Thread Straight	3/16" OD Barb	Clear	Polypropylene



### Thread to Thread Fittings

Precision thread fittings for fluid or air transfer connection. Safe for use under pressure for leak free dispensing. High quality luer lock fittings for use with metering valves, pressure pots, cartridges and syringe equipment. Industrial grade safe and silicone free.

Part Code	Inlet Thread	Outlet Thread	Colour	Material
TSD918-3	1/4" NPT Male Elbow	1/4" Female	Natural	Polypropylene
TSD918-3B	1/4" NPT Male Elbow	1/4" Female	Silver	Nickel Plated Brass
TSD930-6S	1/4" NPT Male Elbow	1/4" Female	Silver	Stainless Steel
TSD918-99B	1/4" NPT Male Elbow	1/4" Male	Silver	Stainless Steel
TSD931-27M	3/8" NPT Male Elbow	3/8" Male	Silver	Stainless Steel
TSD934-49	1/8" NPT Male Straight	1/8" Male	Natural	Nylon
TSD934-51	1/8" NPT Male Straight	1/8" Male	Silver	Stainless Steel
AD931-721SS	1/4" NPT Female Straight	1/4" Female	Silver	Stainless Steel
TSD931-77R	1/4" NPT Female Straight	1/8" Female	Silver	Stainless Steel
TSD934-48	1/4" NPT Male Straight	1/8" Female	Natural	Nylon
TSD934-45	1/4" NPT Male Straight	1/4" Male	Natural	Nylon
TSD934-50	1/4" NPT Male Straight	1/4" Male	Natural	Polypropylene
AD931-45SS	1/4" NPT Male Straight	1/4" Male	Silver	Stainless Steel
TSD934-46	3/8" NPT Male Straight	1/4" Female	Natural	Nylon
TSD934-47	3/8" NPT Male Straight	3/8" Female	Natural	Nylon
TSD934-55	3/8" NPT Male Straight	3/8" Female	Silver	Stainless Steel



### Thread to Compression Fittings

Part Code	Inlet Thread	Outlet	Colour	Material
TSD1002-18	1/8" NPT Male Straight	1/4" OD Tube	Black	Polypropylene
TSD1002-18W	1/8" NPT Male Straight	1/4" OD Tube	White	Polypropylene
TSD1002-17	1/8" NPT Male Straight	3/8" OD Tube	Black	Polypropylene
TSD1002-19	1/4" NPT Male Straight	1/4" OD Tube	Black	Polypropylene
TSD1002-19SS	1/4" NPT Male Straight	1/4" OD Tube	Silver	Stainless Steel
TSD1455-5	1/4" NPT Male Straight	3/8" OD Tube	Black	Polypropylene
TSD1455-5P	1/4" NPT Male Straight	3/8" OD Tube	White	Polypropylene
TSD1002-38M	1/4" NPT Male Straight	3/8" OD Tube	Silver	Stainless Steel
TSD1002-06M	1/4" NPT Male Straight	6mm OD Tube	Silver	Stainless Steel
TSD1002-20	3/8" NPT Male Straight	3/8" OD Tube	Black	Polypropylene
TSD1003-17P	3/8" NPT Male Straight	5/8" OD Tube	White	Polypropylene
TSD1003-17P	3/8" NPT Male Straight	5/8" OD Tube	White	Polypropylene
TSD1003-16P	1/8" NPT Male Elbow	1/4" OD Tube	Natural	Polypropylene
TSD1003-16SS	1/8" NPT Male Elbow	1/4" OD Tube	Silver	Stainless Steel
TSD1003-17K	1/4" NPT Male Elbow	1/4" OD Tube	Natural	Polypropylene
TSD1566-5B	1/4" NPT Male Elbow	3/8" OD Tube	White	Polypropylene
TSD1003-18P	3/8" NPT Male Elbow	3/8" OD Tube	White	Polypropylene



**Fume Recirculatory Systems**

Fume and particle filtration systems for a safe working environment when handling adhesives, glues, aerosols, soldering systems and solvents. Removal and reduction of fumes, vapours, mists, particles and dust via a series of filters to make the working environment more pleasant.

The **BVX-103** fume filtration unit uses a 760mm long flexible arm to clean solvent and glue fumes through a series of filters to provide clean air. Pre-gas volume.

**Suction:** 1250 Pa (5"WC)  
**Flow Rate:** 85m<sup>3</sup>/hr (HEPA)  
**Noise Level:** <55 dB (A)  
**Size H/W/D:** 300 x 231 x 289mm  
**Power Supply:** 100-240VAC 50/60 Hz  
**Power :** 85 Watt  
**Weight:** 9 kg  
**Warranty:** 1 Year CE Certified



The **BVX-101** fume filtration unit uses a flexible 760mm long arm to clean soldering fumes through a series of filters to provide clean air. Pre-Hepa-gas volume.

**Suction:** 1250 Pa (5"WC)  
**Flow Rate:** 85m<sup>3</sup>/hr (HEPA)  
**Noise Level:** <55 dB (A)  
**Size H/W/D:** 300 x 231 x 289mm  
**Power Supply:** 100-240VAC 50/60 Hz  
**Power :** 85 Watt  
**Weight:** 9 kg  
**Warranty:** 1 Year CE Certified



The **BVX-203** fume filtration unit uses 2 760mm long flexible arms to clean solvent and glue fumes through a series of filters to provide clean air. Pre-gas volume.

**Suction:** 850 Pa (5"WC)  
**Flow Rate:** 2x75m<sup>3</sup>/h (45 cfm)  
**Noise Level:** <55 dB (A)  
**Size H/W/D:** 508 x 254 x 388mm  
**Power Supply:** 100-240VAC 50/60 Hz  
**Power :** 85 Watt  
**Weight:** 9 kg  
**Warranty:** 1 Year CE Certified



The **BVX-201** fume filtration unit uses 2 760mm long flexible arms to clean soldering fumes through a series of filters to provide clean air. Pre-Hepa-gas volume.

**Suction:** 850 Pa (5"WC)  
**Flow Rate:** 2x75m<sup>3</sup>/h (45 cfm)  
**Noise Level:** <55 dB (A)  
**Size H/W/D:** 508 x 254 x 388mm  
**Power Supply:** 100-240VAC 50/60 Hz  
**Power :** 85 Watt  
**Weight:** 9 kg  
**Warranty:** 1 Year CE Certified



The **A300S** fume filtration booth draws solvent and glue fumes through a series of filters to provide clean air. Charcoal filter. A3 size. Easy wipe clip on sides.

**Air Volume:** 325 m<sup>3</sup>/hr  
**Flow Rate:** 0.50 m/sec  
**Noise Level:** <59 dB (A)  
**Size H/W/D:** 385 x 510 x 350mm  
**Power Supply:** 110 or 220V AC Option  
**Power :** 85 Watt  
**Weight:** 12 kg  
**Warranty:** 2 Year CE Certified

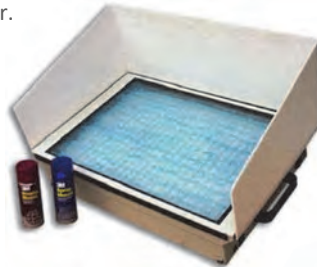

The **A260S** fume filtration booth draws solvent and glue fumes through a series of filters to provide clean air. Charcoal filter. B3 size. Easy wipe clip on sides.

**Air Volume:** 610 m<sup>3</sup>/hr  
**Flow Rate:** 0.50 m/sec  
**Noise Level:** <61 dB (A)  
**Size H/W/D:** 495 x 610 x 490mm  
**Power Supply:** 110 or 220V AC Option  
**Power :** 85 Watt  
**Weight:** 27 kg  
**Warranty:** 2 Year CE Certified



The **A200S** fume filtration booth draws solvent and glue fumes through a series of filters to provide clean air. Charcoal filter. A2 size. Easy wipe clip on sides.

**Air Volume:** 325 m<sup>3</sup>/hr  
**Flow Rate:** 0.50 m/sec  
**Noise Level:** <59 dB (A)  
**Size H/W/D:** 385 x 510 x 350mm  
**Power Supply:** 110 or 220V AC Option  
**Power :** 85 Watt  
**Weight:** 43 kg  
**Warranty:** 2 Year CE Certified

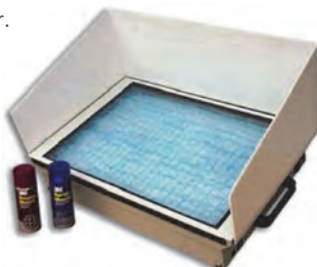

The **T660H-C** fume filtration booth draws solvent and glue fumes through a series of filters to provide clean air. Charcoal filter. A2 size. Metal sides. Glass shield.

**Air Volume:** 3255 m<sup>3</sup>/hr  
**Flow Rate:** 0.50 m/sec  
**Noise Level:** <59 dB (A)  
**Size H/W/D:** 660 x 680 x 450mm  
**Power Supply:** 110 or 220V AC Option  
**Power :** 85 Watt  
**Weight:** 35 kg  
**Warranty:** 2 Year CE Certified



The **A100H** fume filtration booth draws solvent and glue fumes through a series of filters to provide clean air. Charcoal filter. A1 size. Metal sides.

**Air Volume:** 650 m<sup>3</sup>/hr  
**Flow Rate:** 0.50 m/sec  
**Noise Level:** <61 dB (A)  
**Size H/W/D:** 740 x 960 x 620mm  
**Power Supply:** 110 or 220V AC Option  
**Power :** 85 Watt  
**Weight:** 35 kg  
**Warranty:** 2 Year CE Certified



The **T930H-C** fume filtration booth draws solvent and glue fumes through a series of filters to provide clean air. Charcoal filter. Large size. Metal sides.

**Air Volume:** 355 m<sup>3</sup>/hr  
**Flow Rate:** 0.50 m/sec  
**Noise Level:** <61 dB (A)  
**Size H/W/D:** 800 x 960 x 620mm  
**Power Supply:** 110 or 220V AC Option  
**Power :** 85 Watt  
**Weight:** 35 kg  
**Warranty:** 2 Year CE Certified





## Fume extraction

### Fume Extraction Ducted Systems

Fume and particle extraction systems for a safe working environment when handling adhesives, glues, aerosols, soldering systems and solvents. Removal and reduction of fumes, vapours, mists, particles and dust via filters to an outside vent or window via flexible ducting pipe.

The **A300S-D** fume filtration booth draws solvent and glue fumes through filters and duct to provide clean air. Carbon filter. A3 size. Folding Sides.

**Air Volume:** 355 m<sup>3</sup>/hr  
**Flow Rate:** 0.60 m/sec  
**Noise Level:** <58 dB (A)  
**Size H/W/D:** 390 x 505 x 430mm  
**Power Supply:** 110 or 220V AC Option  
**Power :** 85 Watt  
**Weight:** 21 kg  
**Warranty:** 2 Year CE Certified



The **A200H-D** fume filtration booth draws solvent and glue fumes through filters and duct to provide clean air. Carbon filter. A2 size. Metal sides.

**Air Volume:** 355 m<sup>3</sup>/hr  
**Flow Rate:** 0.60 m/sec  
**Noise Level:** <58 dB (A)  
**Size H/W/D:** 525 x 670 x 450mm  
**Power Supply:** 110 or 220V AC Option  
**Power :** 85 Watt  
**Weight:** 56 kg  
**Warranty:** 2 Year CE Certified



The **T500S-D** fume filtration booth draws solvent and glue fumes through filters and duct to provide clean air. Carbon filter. A3 size. Hard sides.

**Air Volume:** 355 m<sup>3</sup>/hr  
**Flow Rate:** 0.60 m/sec  
**Noise Level:** <58 dB (A)  
**Size H/W/D:** 390 x 505 x 430mm  
**Power Supply:** 110 or 220V AC Option  
**Power :** 85 Watt  
**Weight:** 23 kg  
**Warranty:** 2 Year CE Certified



The **T660H-D** fume filtration booth draws solvent and glue fumes through filters and duct to provide clean air. Carbon filter. A2 size. Metal sides.

**Air Volume:** 355 m<sup>3</sup>/hr  
**Flow Rate:** 0.60 m/sec  
**Noise Level:** <58 dB (A)  
**Size H/W/D:** 525 x 670 x 450mm  
**Power Supply:** 110 or 220V AC Option  
**Power :** 85 Watt  
**Weight:** 56 kg  
**Warranty:** 2 Year CE Certified



The **A100H-D** fume filtration booth draws solvent and glue fumes through filters and duct to provide clean air. Carbon filter. A1 size. Hard sides.

**Air Volume:** 710 m<sup>3</sup>/hr  
**Flow Rate:** 0.60 m/sec  
**Noise Level:** <58 dB (A)  
**Size H/W/D:** 960 x 960 x 620mm  
**Power Supply:** 115 or 220V AC Option  
**Power :** 85 Watt  
**Weight:** 125 kg  
**Warranty:** 2 Year CE Certified



The **T930H-D** fume filtration booth draws solvent and glue fumes through filters and duct to provide clean air. Carbon filter. A1 size. Hard sides.

**Air Volume:** 710 m<sup>3</sup>/hr  
**Flow Rate:** 0.60 m/sec  
**Noise Level:** <58 dB (A)  
**Size H/W/D:** 960 x 960 x 620mm  
**Power Supply:** 115 or 220V AC Option  
**Power :** 85 Watt  
**Weight:** 125 kg  
**Warranty:** 2 Year CE Certified



The **DWS24-G** fume filtration booth draws solvent and glue fumes through the base and duct to provide clean air. Carbon filter. Downflow cabinet. Hard sides.

**Air Volume:** 246 m<sup>3</sup>/hr  
**Flow Rate:** 0.40 m/sec  
**Noise Level:** <52 dB (A)  
**Size H/W/D:** 800 x 610 x 580mm  
**Power Supply:** 110 or 220V AC Option  
**Power :** 85 Watt  
**Weight:** 60 kg  
**Warranty:** 2 Year CE Certified



The **DWS36-G** fume filtration booth draws solvent and glue fumes through the base and duct to provide clean air. Carbon filter. Downflow cabinet. Hard sides.

**Air Volume:** 493 m<sup>3</sup>/hr  
**Flow Rate:** 0.40 m/sec  
**Noise Level:** <52 dB (A)  
**Size H/W/D:** 800 x 915 x 580mm  
**Power Supply:** 110 or 220V AC Option  
**Power :** 85 Watt  
**Weight:** 60 kg  
**Warranty:** 2 Year CE Certified



The **DWS48-G** fume filtration booth draws solvent and glue fumes through the base and duct to provide clean air. Carbon filter. Downflow cabinet. Hard sides.

**Air Volume:** 246 m<sup>3</sup>/hr  
**Flow Rate:** 0.40 m/sec  
**Noise Level:** <52 dB (A)  
**Size H/W/D:** 800 x 1220 x 580mm  
**Power Supply:** 110 or 220V AC Option  
**Power :** 85 Watt  
**Weight:** 60 kg  
**Warranty:** 2 Year CE Certified

















The **AD-SS34S** is a chemical, solvent, glue, fuel & adhesive vented storage cabinet. Electronic airflow monitoring system. Safe storage for vapours.

**Air Volume:** 205-305 m<sup>3</sup>/hr  
**Flow Rate:** 0.40 m/sec  
**Noise Level:** <52 dB (A)  
**Size H/W/D:** 740 x 864 x 508mm  
**Power Supply:** 110 or 220V AC Option  
**Power :** 85 Watt  
**Weight:** 55 kg  
**Warranty:** 2 Year CE Certified

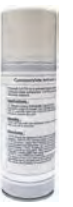

**Cyanoacrylate Instant Adhesives**

Industrial grade Cyanoacrylate adhesives for bonding rubber, plastics, metal, fabric, card, etc. Instant bond. Single part adhesives. Supplied with TDS/MSDS. Long shelf life with batch codes. In 50g or 500g bottle sizes. UK blended materials.

Low Viscosity		Medium Viscosity		High Viscosity		Gel Tube																															
Colour: Translucent Viscosity: 20 cps Max Gap Fill: 0.101mm Temp. Range: -55 to 82 C Fixture Time: < 5 sec @ 20 Strength: 5 to 28 N/mm <sup>2</sup>		Colour: Translucent Viscosity: 120 cps Max Gap Fill: 0.127mm Temp. Range: -55 to 82 C Fixture Time: < 8 sec @ 20 Strength: 5 to 28 N/mm <sup>2</sup>		Colour: Translucent Viscosity: 1500 cps Max Gap Fill: 0.20mm Temp. Range: -50 to 80 C Fixture Time: 5-60 sec @ 20 Strength: 21 N/mm <sup>2</sup>		Colour: Translucent Viscosity: 50,000 cps Max Gap Fill: 0.254mm Temp. Range: -55 to 82 C Fixture Time: < 90 sec @ 20 Strength: 5 to 28 N/mm <sup>2</sup>																															
<table border="1"> <thead> <tr><th>Size</th><th>Part Code</th></tr> </thead> <tbody> <tr><td>50G</td><td>GB06-50</td></tr> <tr><td>500G</td><td>GB06-500</td></tr> </tbody> </table>	Size	Part Code	50G	GB06-50	500G	GB06-500		<table border="1"> <thead> <tr><th>Size</th><th>Part Code</th></tr> </thead> <tbody> <tr><td>50G</td><td>GB01-50</td></tr> <tr><td>500G</td><td>GB01-500</td></tr> </tbody> </table>	Size	Part Code	50G	GB01-50	500G	GB01-500		<table border="1"> <thead> <tr><th>Size</th><th>Part Code</th></tr> </thead> <tbody> <tr><td>50G</td><td>GB16-50</td></tr> <tr><td>500G</td><td>GB16-500</td></tr> </tbody> </table>	Size	Part Code	50G	GB16-50	500G	GB16-500		<table border="1"> <thead> <tr><th>Size</th><th>Part Code</th></tr> </thead> <tbody> <tr><td>20G</td><td>GB44-20</td></tr> </tbody> </table>	Size	Part Code	20G	GB44-20									
Size	Part Code																																				
50G	GB06-50																																				
500G	GB06-500																																				
Size	Part Code																																				
50G	GB01-50																																				
500G	GB01-500																																				
Size	Part Code																																				
50G	GB16-50																																				
500G	GB16-500																																				
Size	Part Code																																				
20G	GB44-20																																				
Colour: Black Viscosity: 300 cps Max Gap Fill: 0.15 mm Temp. Range: -50 to 82 C Fixture Time: < 90 sec @ 20 Strength: 15 to 30 N/mm <sup>2</sup>		Colour: Black Viscosity: 1500 cps Max Gap Fill: 0.25 mm Temp. Range: -55 to 82 C Fixture Time: < 90 sec @ 20 Strength: 15 to 30 N/mm <sup>2</sup>		Colour: Black Viscosity: 50,000 cps Max Gap Fill: 0.50 mm Temp. Range: -55 to 82 C Fixture Time: < 100 sec @ 20 Strength: 15 to 30 N/mm <sup>2</sup>		Colour: Translucent Viscosity: 3-5 cps Max Gap Fill: 0.05mm Temp. Range: -50 to 80 C Fixture Time: < 5 sec @ 20 Strength: 5 to 28 N/mm <sup>2</sup>																															
<table border="1"> <thead> <tr><th>Size</th><th>Part Code</th></tr> </thead> <tbody> <tr><td>50G</td><td>GB80-50</td></tr> <tr><td>500G</td><td>GB80-500</td></tr> </tbody> </table>	Size	Part Code	50G	GB80-50	500G	GB80-500		<table border="1"> <thead> <tr><th>Size</th><th>Part Code</th></tr> </thead> <tbody> <tr><td>50G</td><td>GB4310-50</td></tr> <tr><td>500G</td><td>GB4310-500</td></tr> </tbody> </table>	Size	Part Code	50G	GB4310-50	500G	GB4310-500		<table border="1"> <thead> <tr><th>Size</th><th>Part Code</th></tr> </thead> <tbody> <tr><td>50G</td><td>GB4326-50</td></tr> <tr><td>500G</td><td>GB4326-500</td></tr> </tbody> </table>	Size	Part Code	50G	GB4326-50	500G	GB4326-500		<table border="1"> <thead> <tr><th>Size</th><th>Part Code</th></tr> </thead> <tbody> <tr><td>50G</td><td>GB4308-50</td></tr> <tr><td>500G</td><td>GB4308-500</td></tr> </tbody> </table>	Size	Part Code	50G	GB4308-50	500G	GB4308-500							
Size	Part Code																																				
50G	GB80-50																																				
500G	GB80-500																																				
Size	Part Code																																				
50G	GB4310-50																																				
500G	GB4310-500																																				
Size	Part Code																																				
50G	GB4326-50																																				
500G	GB4326-500																																				
Size	Part Code																																				
50G	GB4308-50																																				
500G	GB4308-500																																				
Colour: Translucent Viscosity: 120 cps Max Gap Fill: 0.15mm Temp. Range: -50 to 80 C Fixture Time: < 8 sec @ 20 Strength: 5 to 28 N/mm <sup>2</sup>		Colour: Translucent Viscosity: 1000/1500 cps Max Gap Fill: 0.2mm Temp. Range: -55 to 82 C Fixture Time: 20-60 sec @ 20 Strength: 5 to 28 N/mm <sup>2</sup>		Colour: Translucent Viscosity: 70 cps Max Gap Fill: 0.2mm Temp. Range: -55 to 125 Fixture Time: 10 sec @ 20 Strength: 5 to 28 N/mm <sup>2</sup>		Colour: Translucent Viscosity: 3 cps Max Gap Fill: 0.1mm Temp. Range: -55 to 125 Fixture Time: 5 sec @ 20 Strength: 5 to 28 N/mm <sup>2</sup>																															
<table border="1"> <thead> <tr><th>Size</th><th>Part Code</th></tr> </thead> <tbody> <tr><td>50G</td><td>GB4360-50</td></tr> <tr><td>500G</td><td>GB4360-500</td></tr> </tbody> </table>	Size	Part Code	50G	GB4360-50	500G	GB4360-500		<table border="1"> <thead> <tr><th>Size</th><th>Part Code</th></tr> </thead> <tbody> <tr><td>50G</td><td>GB4303-50</td></tr> <tr><td>500G</td><td>GB4303-500</td></tr> </tbody> </table>	Size	Part Code	50G	GB4303-50	500G	GB4303-500		<table border="1"> <thead> <tr><th>Size</th><th>Part Code</th></tr> </thead> <tbody> <tr><td>50G</td><td>GB4344-50</td></tr> <tr><td>500G</td><td>GB4344-500</td></tr> </tbody> </table>	Size	Part Code	50G	GB4344-50	500G	GB4344-500		<table border="1"> <thead> <tr><th>Size</th><th>Part Code</th></tr> </thead> <tbody> <tr><td>50G</td><td>GB4393-50</td></tr> <tr><td>500G</td><td>GB4393-500</td></tr> </tbody> </table>	Size	Part Code	50G	GB4393-50	500G	GB4393-500							
Size	Part Code																																				
50G	GB4360-50																																				
500G	GB4360-500																																				
Size	Part Code																																				
50G	GB4303-50																																				
500G	GB4303-500																																				
Size	Part Code																																				
50G	GB4344-50																																				
500G	GB4344-500																																				
Size	Part Code																																				
50G	GB4393-50																																				
500G	GB4393-500																																				
Colour: Translucent Viscosity: 125 cps Max Gap Fill: 0.2mm Temp. Range: -55 to 125 Fixture Time: 10 sec @ 20 Strength: 5 to 28 N/mm <sup>2</sup>		Colour: Translucent Viscosity: 1 cps Size: 200ml		Colour: Translucent Viscosity: 1 cps Size: 1000ml		Colour: Translucent Viscosity: 1 cps Size: 50ml/ 1000ml																															
<table border="1"> <thead> <tr><th>Size</th><th>Part Code</th></tr> </thead> <tbody> <tr><td>50G</td><td>GB4396-50</td></tr> <tr><td>500G</td><td>GB4396-500</td></tr> </tbody> </table>	Size	Part Code	50G	GB4396-50	500G	GB4396-500		<table border="1"> <thead> <tr><th>Type</th><th>Part Code</th></tr> </thead> <tbody> <tr><td>General</td><td>AC200S</td></tr> <tr><td>Plastic</td><td>AC780S</td></tr> <tr><td>Wood</td><td>AC750S</td></tr> </tbody> </table>	Type	Part Code	General	AC200S	Plastic	AC780S	Wood	AC750S		<table border="1"> <thead> <tr><th>Type</th><th>Part Code</th></tr> </thead> <tbody> <tr><td>General</td><td>AC200L</td></tr> <tr><td>Plastic</td><td>AC780L</td></tr> <tr><td>Wood</td><td>AC750L</td></tr> <tr><td>Acetone</td><td>AC760L</td></tr> </tbody> </table>	Type	Part Code	General	AC200L	Plastic	AC780L	Wood	AC750L	Acetone	AC760L		<table border="1"> <thead> <tr><th>Size</th><th>Part Code</th></tr> </thead> <tbody> <tr><td>50ML</td><td>BD50</td></tr> <tr><td>1000ML</td><td>DB1000</td></tr> </tbody> </table>	Size	Part Code	50ML	BD50	1000ML	DB1000	
Size	Part Code																																				
50G	GB4396-50																																				
500G	GB4396-500																																				
Type	Part Code																																				
General	AC200S																																				
Plastic	AC780S																																				
Wood	AC750S																																				
Type	Part Code																																				
General	AC200L																																				
Plastic	AC780L																																				
Wood	AC750L																																				
Acetone	AC760L																																				
Size	Part Code																																				
50ML	BD50																																				
1000ML	DB1000																																				

Threadlocker Anaerobic Adhesives

Anaerobic sealants adhesives are single component materials that cure by the presence of metal and the absence of air. When both conditions are met anaerobic adhesives form a tough, durable polymer providing total contact between the two surfaces, resulting in a vibration and leak-proof assembly.

<p><b>Low Strength Screwlocker</b></p> <p>Colour: Purple                  Viscosity: 1,200-1,500 cps                  Temp. Range: -50 to 150 C                  Fixture Time: &lt; 15 mins @ 20                  Full Cure: 24 Hours @ 20</p> <table border="1"> <thead> <tr> <th>Size</th> <th>Part Code</th> </tr> </thead> <tbody> <tr> <td>10ml</td> <td>A02-10</td> </tr> <tr> <td>50ml</td> <td>A02-50</td> </tr> <tr> <td>250ml</td> <td>A02-250</td> </tr> </tbody> </table> 	Size	Part Code	10ml	A02-10	50ml	A02-50	250ml	A02-250	<p><b>Mid Strength Screwlocker</b></p> <p>Colour: Blue                  Viscosity: 1,200-1,500 cps                  Temp. Range: -50 to 150 C                  Fixture Time: 10mins @ 20                  Full Cure: 24 Hours @ 20</p> <table border="1"> <thead> <tr> <th>Size</th> <th>Part Code</th> </tr> </thead> <tbody> <tr> <td>10ml</td> <td>A03-10</td> </tr> <tr> <td>50ml</td> <td>A03-50</td> </tr> <tr> <td>250ml</td> <td>A03-250</td> </tr> </tbody> </table> 	Size	Part Code	10ml	A03-10	50ml	A03-50	250ml	A03-250	<p><b>High Strength Threadlock</b></p> <p>Colour: Red                  Viscosity: 400-600 cps                  Temp. Range: -54 to 150 C                  Fixture Time: 15mins @ 20                  Full Cure: 24 Hours @ 20</p> <table border="1"> <thead> <tr> <th>Size</th> <th>Part Code</th> </tr> </thead> <tbody> <tr> <td>10ml</td> <td>A06-10</td> </tr> <tr> <td>50ml</td> <td>A06-50</td> </tr> <tr> <td>250ml</td> <td>A06-250</td> </tr> </tbody> </table> 	Size	Part Code	10ml	A06-10	50ml	A06-50	250ml	A06-250	<p><b>Low Viscosity Studlocker</b></p> <p>Colour: Green                  Viscosity: 500 cps                  Temp. Range: -50 to 150 C                  Fixture Time: 15mins @ 20                  Full Cure: 24 Hours @ 20</p> <table border="1"> <thead> <tr> <th>Size</th> <th>Part Code</th> </tr> </thead> <tbody> <tr> <td>10ml</td> <td>A05-10</td> </tr> <tr> <td>50ml</td> <td>A05-50</td> </tr> <tr> <td>250ml</td> <td>A05-250</td> </tr> </tbody> </table> 	Size	Part Code	10ml	A05-10	50ml	A05-50	250ml	A05-250
Size	Part Code																																		
10ml	A02-10																																		
50ml	A02-50																																		
250ml	A02-250																																		
Size	Part Code																																		
10ml	A03-10																																		
50ml	A03-50																																		
250ml	A03-250																																		
Size	Part Code																																		
10ml	A06-10																																		
50ml	A06-50																																		
250ml	A06-250																																		
Size	Part Code																																		
10ml	A05-10																																		
50ml	A05-50																																		
250ml	A05-250																																		
<p><b>High Viscosity Threadlock</b></p> <p>Colour: Red                  Viscosity: 5,000 cps                  Temp. Range: -50 to 150 C                  Fix Time: 15-30mins @ 20                  Full Cure: 24 Hours @ 20</p> <table border="1"> <thead> <tr> <th>Size</th> <th>Part Code</th> </tr> </thead> <tbody> <tr> <td>10ml</td> <td>A07-10</td> </tr> <tr> <td>50ml</td> <td>A07-50</td> </tr> <tr> <td>250ml</td> <td>A07-250</td> </tr> </tbody> </table> 	Size	Part Code	10ml	A07-10	50ml	A07-50	250ml	A07-250	<p><b>Fast Cure Nutlocker</b></p> <p>Colour: Blue                  Viscosity: 2,000 cps                  Temp. Range: -50 to 150 C                  Fixture Time: 10mins @ 20                  Full Cure: 24 Hours @ 20</p> <table border="1"> <thead> <tr> <th>Size</th> <th>Part Code</th> </tr> </thead> <tbody> <tr> <td>10ml</td> <td>A08-10</td> </tr> <tr> <td>50ml</td> <td>A08-50</td> </tr> <tr> <td>250ml</td> <td>A08-250</td> </tr> </tbody> </table> 	Size	Part Code	10ml	A08-10	50ml	A08-50	250ml	A08-250	<p><b>High Strength Retainer</b></p> <p>Colour: Green                  Viscosity: 7,000 cps                  Temp. Range: -50 to 150 C                  Fixture Time: 20mins @ 20                  Full Cure: 24 Hours @ 20</p> <table border="1"> <thead> <tr> <th>Size</th> <th>Part Code</th> </tr> </thead> <tbody> <tr> <td>10ml</td> <td>A11-10</td> </tr> <tr> <td>50ml</td> <td>A11-50</td> </tr> <tr> <td>250ml</td> <td>A11-250</td> </tr> </tbody> </table> 	Size	Part Code	10ml	A11-10	50ml	A11-50	250ml	A11-250	<p><b>Mid Strength Retainer</b></p> <p>Colour: Yellow                  Viscosity: 1,500 cps                  Temp. Range: -50 to 150 C                  Fixture Time: 10mins @ 20                  Full Cure: 24 Hours @ 20</p> <table border="1"> <thead> <tr> <th>Size</th> <th>Part Code</th> </tr> </thead> <tbody> <tr> <td>10ml</td> <td>A14-10</td> </tr> <tr> <td>50ml</td> <td>A14-50</td> </tr> <tr> <td>250ml</td> <td>A14-250</td> </tr> </tbody> </table> 	Size	Part Code	10ml	A14-10	50ml	A14-50	250ml	A14-250
Size	Part Code																																		
10ml	A07-10																																		
50ml	A07-50																																		
250ml	A07-250																																		
Size	Part Code																																		
10ml	A08-10																																		
50ml	A08-50																																		
250ml	A08-250																																		
Size	Part Code																																		
10ml	A11-10																																		
50ml	A11-50																																		
250ml	A11-250																																		
Size	Part Code																																		
10ml	A14-10																																		
50ml	A14-50																																		
250ml	A14-250																																		
<p><b>Low Viscosity Retainer</b></p> <p>Colour: Green                  Viscosity: 150 cps                  Temp. Range: -50 to 200 C                  Fixture Time: 15mins @ 20                  Full Cure: 24 Hours @ 20</p> <table border="1"> <thead> <tr> <th>Size</th> <th>Part Code</th> </tr> </thead> <tbody> <tr> <td>10ml</td> <td>A01-10</td> </tr> <tr> <td>50ml</td> <td>A01-50</td> </tr> <tr> <td>250ml</td> <td>A01-250</td> </tr> </tbody> </table> 	Size	Part Code	10ml	A01-10	50ml	A01-50	250ml	A01-250	<p><b>Penetrating Threadlock</b></p> <p>Colour: Green                  Viscosity: 2,500 cps                  Temp. Range: -50 to 200 C                  Fixture Time: 15mins @ 20                  Full Cure: 24 Hours @ 20</p> <table border="1"> <thead> <tr> <th>Size</th> <th>Part Code</th> </tr> </thead> <tbody> <tr> <td>10ml</td> <td>A90-10</td> </tr> <tr> <td>50ml</td> <td>A90-50</td> </tr> <tr> <td>250ml</td> <td>A90-250</td> </tr> </tbody> </table> 	Size	Part Code	10ml	A90-10	50ml	A90-50	250ml	A90-250	<p><b>High Strength Retainer</b></p> <p>Colour: Green                  Viscosity: 500 cps                  Temp. Range: -50 to 150 C                  Fixture Time: 15mins @ 20                  Full Cure: 24 Hours @ 20</p> <table border="1"> <thead> <tr> <th>Size</th> <th>Part Code</th> </tr> </thead> <tbody> <tr> <td>10ml</td> <td>A48-10</td> </tr> <tr> <td>50ml</td> <td>A48-50</td> </tr> <tr> <td>250ml</td> <td>A48-250</td> </tr> </tbody> </table> 	Size	Part Code	10ml	A48-10	50ml	A48-50	250ml	A48-250	<p><b>High Temp Gasket Maker</b></p> <p>Colour: Red                  Viscosity: 2,500 cps                  Temp. Range: -54 to 200 C                  Fixture Time: 120mins @ 20                  Full Cure: 24 Hours @ 20</p> <table border="1"> <thead> <tr> <th>Size</th> <th>Part Code</th> </tr> </thead> <tbody> <tr> <td>10ml</td> <td>G10-10</td> </tr> <tr> <td>50ml</td> <td>G10-50</td> </tr> <tr> <td>250ml</td> <td>G10-250</td> </tr> </tbody> </table> 	Size	Part Code	10ml	G10-10	50ml	G10-50	250ml	G10-250
Size	Part Code																																		
10ml	A01-10																																		
50ml	A01-50																																		
250ml	A01-250																																		
Size	Part Code																																		
10ml	A90-10																																		
50ml	A90-50																																		
250ml	A90-250																																		
Size	Part Code																																		
10ml	A48-10																																		
50ml	A48-50																																		
250ml	A48-250																																		
Size	Part Code																																		
10ml	G10-10																																		
50ml	G10-50																																		
250ml	G10-250																																		
<p><b>High Viscosity Gasket</b></p> <p>Colour: Orange                  Viscosity: 10,000 cps                  Temp. Range: -50 to 150 C                  Fixture Time: 60mins @ 20                  Full Cure: 24 Hours @ 20</p> <table border="1"> <thead> <tr> <th>Size</th> <th>Part Code</th> </tr> </thead> <tbody> <tr> <td>10ml</td> <td>G74-10</td> </tr> <tr> <td>50ml</td> <td>G74-50</td> </tr> <tr> <td>250ml</td> <td>G74-250</td> </tr> </tbody> </table> 	Size	Part Code	10ml	G74-10	50ml	G74-50	250ml	G74-250	<p><b>Hydraulic Thread Sealant</b></p> <p>Colour: Brown                  Viscosity: 2,000 cps                  Temp. Range: -50 to 150 C                  Fixture Time: 60 mins @ 20                  Full Cure: 24 Hours @ 20</p> <table border="1"> <thead> <tr> <th>Size</th> <th>Part Code</th> </tr> </thead> <tbody> <tr> <td>10ml</td> <td>H42-10</td> </tr> <tr> <td>50ml</td> <td>H42-50</td> </tr> <tr> <td>250ml</td> <td>H42-250</td> </tr> </tbody> </table> 	Size	Part Code	10ml	H42-10	50ml	H42-50	250ml	H42-250	<p><b>High Temp Pipe Sealant</b></p> <p>Colour: White                  Viscosity: 50,000 cps                  Temp. Range: -50 to 200 C                  Fixture Time: 75 mins @ 20                  Full Cure: 24 Hours @ 20</p> <table border="1"> <thead> <tr> <th>Size</th> <th>Part Code</th> </tr> </thead> <tbody> <tr> <td>10ml</td> <td>P72-10</td> </tr> <tr> <td>50ml</td> <td>P72-50</td> </tr> <tr> <td>250ml</td> <td>P72-250</td> </tr> </tbody> </table> 	Size	Part Code	10ml	P72-10	50ml	P72-50	250ml	P72-250	<p><b>Fast Cure Pipe Sealant</b></p> <p>Colour: Yellow                  Viscosity: 100,000 cps                  Temp. Range: -50 to 150 C                  Fixture Time: 30 mins @ 20                  Full Cure: 24 Hours @ 20</p> <table border="1"> <thead> <tr> <th>Size</th> <th>Part Code</th> </tr> </thead> <tbody> <tr> <td>10ml</td> <td>P77-10</td> </tr> <tr> <td>50ml</td> <td>P77-50</td> </tr> <tr> <td>250ml</td> <td>P77-250</td> </tr> </tbody> </table> 	Size	Part Code	10ml	P77-10	50ml	P77-50	250ml	P77-250
Size	Part Code																																		
10ml	G74-10																																		
50ml	G74-50																																		
250ml	G74-250																																		
Size	Part Code																																		
10ml	H42-10																																		
50ml	H42-50																																		
250ml	H42-250																																		
Size	Part Code																																		
10ml	P72-10																																		
50ml	P72-50																																		
250ml	P72-250																																		
Size	Part Code																																		
10ml	P77-10																																		
50ml	P77-50																																		
250ml	P77-250																																		









This accomplished range of anaerobics contains thread-lockers, thread-sealers, retainers and pipe-sealants. The word "anaerobic" means without air which explains the primary cure mechanism of this group of adhesives. An anaerobic adhesive is a single part adhesive that cures or polymerizes when deprived of oxygen.

Anaerobics are designed to lock and seal metal components and fasteners and are available in a range of thicknesses, from thin water to a heavy paste. The use of primers will significantly reduce the fix times. For controlled dispensing of these products, use our timed syringe dispensers, metering valves, controllers and pressure pots.



### UV Cure Adhesives

Industrial UV curing adhesives are single component and cure upon exposure to ultra violet light. These UV resins form high strength, crystal clear and environmentally resistant bonds to glass, metal and a variety of plastics. ISO 9001 International Quality Standard. In 20ml, 50ml, 250ml or 1 litre sized bottles.

General Purpose UV		Glass & Plastic UV		Glass & Plastic UV		Glass to Metal UV																													
Colour: Translucent Viscosity: 500 cps Substrates: Plastics/Metals Temp. Range: -40 to 120C Fixture Time: On demand Shore Hardness: 60D		Colour: Translucent Viscosity: 100 cps Substrates: Glass/Plastics Temp. Range: -40 to 120C Fixture Time: On demand Shore Hardness: 75D		Colour: Translucent Viscosity: 2,000 cps Substrates: Glass/Plastics Temp. Range: -40 to 120C Fixture Time: On demand Shore Hardness: 75D		Colour: Translucent Viscosity: 6,000 cps Substrates: Glass/Metals Temp. Range: -40 to 120C Fixture Time: On demand Shore Hardness: 72D																													
<table border="1"> <thead> <tr><th>Size</th><th>Part Code</th></tr> </thead> <tbody> <tr><td>50ml</td><td>UV01-50</td></tr> <tr><td>250ml</td><td>UV01-250</td></tr> <tr><td>1000ml</td><td>UV01-1000</td></tr> </tbody> </table> 	Size	Part Code	50ml	UV01-50	250ml	UV01-250	1000ml	UV01-1000	<table border="1"> <thead> <tr><th>Size</th><th>Part Code</th></tr> </thead> <tbody> <tr><td>50ml</td><td>040116</td></tr> <tr><td>250ml</td><td>040116-1</td></tr> <tr><td>1000ml</td><td>040116-2</td></tr> </tbody> </table> 	Size	Part Code	50ml	040116	250ml	040116-1	1000ml	040116-2	<table border="1"> <thead> <tr><th>Size</th><th>Part Code</th></tr> </thead> <tbody> <tr><td>50ml</td><td>UV3088</td></tr> <tr><td>250ml</td><td>UV3088-1</td></tr> <tr><td>1000ml</td><td>UB3088-2</td></tr> </tbody> </table> 	Size	Part Code	50ml	UV3088	250ml	UV3088-1	1000ml	UB3088-2	<table border="1"> <thead> <tr><th>Size</th><th>Part Code</th></tr> </thead> <tbody> <tr><td>50ml</td><td>040111</td></tr> <tr><td>250ml</td><td>040111-1</td></tr> <tr><td>1000ml</td><td>040111-2</td></tr> </tbody> </table> 	Size	Part Code	50ml	040111	250ml	040111-1	1000ml	040111-2
Size	Part Code																																		
50ml	UV01-50																																		
250ml	UV01-250																																		
1000ml	UV01-1000																																		
Size	Part Code																																		
50ml	040116																																		
250ml	040116-1																																		
1000ml	040116-2																																		
Size	Part Code																																		
50ml	UV3088																																		
250ml	UV3088-1																																		
1000ml	UB3088-2																																		
Size	Part Code																																		
50ml	040111																																		
250ml	040111-1																																		
1000ml	040111-2																																		
Plastic to Metal UV		Plastic Bonding UV		Doming Resin UV		Cordless UV Light																													
Colour: Translucent Viscosity: 750 cps Substrates: Plastics/Metals Temp. Range: -40 to 120C Fixture Time: On demand Shore Hardness: 68D		Colour: Translucent Viscosity: 500 cps Substrates: Plastics Temp. Range: -40 to 120C Fixture Time: On demand Shore Hardness: 60D		Colour: Translucent Viscosity: 1,750 cps Substrates: Plastics Temp. Range: -40 to 120C Fixture Time: On demand Shore Hardness: 65D		Type: LED Power: 1 Watt Output: 395nm Construction: Aluminium Dims: 97mm x 22mm Weight: 74g																													
<table border="1"> <thead> <tr><th>Size</th><th>Part Code</th></tr> </thead> <tbody> <tr><td>50ml</td><td>120908HS</td></tr> <tr><td>250ml</td><td>120908HS-1</td></tr> <tr><td>1000ml</td><td>120908HS-2</td></tr> </tbody> </table> 	Size	Part Code	50ml	120908HS	250ml	120908HS-1	1000ml	120908HS-2	<table border="1"> <thead> <tr><th>Size</th><th>Part Code</th></tr> </thead> <tbody> <tr><td>50ml</td><td>UV4006</td></tr> <tr><td>250ml</td><td>UV4006-1</td></tr> <tr><td>1000ml</td><td>UV4006-2</td></tr> </tbody> </table> 	Size	Part Code	50ml	UV4006	250ml	UV4006-1	1000ml	UV4006-2	<table border="1"> <thead> <tr><th>Size</th><th>Part Code</th></tr> </thead> <tbody> <tr><td>50ml</td><td>0810-50</td></tr> <tr><td>250ml</td><td>0810-250</td></tr> <tr><td>1000ml</td><td>0810-1K</td></tr> </tbody> </table> 	Size	Part Code	50ml	0810-50	250ml	0810-250	1000ml	0810-1K	<table border="1"> <thead> <tr><th>Power</th><th>Part Code</th></tr> </thead> <tbody> <tr><td>1 Watt</td><td>TS85UV</td></tr> </tbody> </table> 	Power	Part Code	1 Watt	TS85UV				
Size	Part Code																																		
50ml	120908HS																																		
250ml	120908HS-1																																		
1000ml	120908HS-2																																		
Size	Part Code																																		
50ml	UV4006																																		
250ml	UV4006-1																																		
1000ml	UV4006-2																																		
Size	Part Code																																		
50ml	0810-50																																		
250ml	0810-250																																		
1000ml	0810-1K																																		
Power	Part Code																																		
1 Watt	TS85UV																																		

### Epoxy Resins and Polyurethanes

Epoxy resins, polyurethanes, potting compounds, silicones, doming resins & adhesives. Solvent free to provide excellent adhesion. To bond or repair a wide range of materials. Two component adhesives for use in Automotive Repair, Equine Hoof Care, Bovine Block Bonding, Boat & Caravan Repair, Concrete Repair, General Bonding & Multi Repair for Industrial applications.

Fast Cure Epoxy Resin		Fast Cure Plastic Repair		Semi Rigid Plastic Repair		Rigid Plastic Repair															
Material: Epoxy Colour: Clear Mix Ratio: 1:1 Volume: 25ml, 50ml Full Cure: < 5 Mins		Material: Polyurethane Colour: Black Mix Ratio: 1:1 Volume: 50ml Full Cure: < 1 Mins		Material: Polyurethane Colour: Black Mix Ratio: 1:1 Volume: 50ml Full Cure: < 1 Mins		Material: Polyurethane Colour: Black Mix Ratio: 1:1 Volume: 50ml Full Cure: < 5 Mins															
<table border="1"> <thead> <tr><th>Size</th><th>Part Code</th></tr> </thead> <tbody> <tr><td>25ml</td><td>EP95-25</td></tr> <tr><td>50ml</td><td>EP95-50</td></tr> </tbody> </table> 	Size	Part Code	25ml	EP95-25	50ml	EP95-50	<table border="1"> <thead> <tr><th>Size</th><th>Part Code</th></tr> </thead> <tbody> <tr><td>50ml</td><td>EP2001</td></tr> </tbody> </table> 	Size	Part Code	50ml	EP2001	<table border="1"> <thead> <tr><th>Size</th><th>Part Code</th></tr> </thead> <tbody> <tr><td>50ml</td><td>EP2005</td></tr> </tbody> </table> 	Size	Part Code	50ml	EP2005	<table border="1"> <thead> <tr><th>Size</th><th>Part Code</th></tr> </thead> <tbody> <tr><td>50ml</td><td>EP2005-5</td></tr> </tbody> </table> 	Size	Part Code	50ml	EP2005-5
Size	Part Code																				
25ml	EP95-25																				
50ml	EP95-50																				
Size	Part Code																				
50ml	EP2001																				
Size	Part Code																				
50ml	EP2005																				
Size	Part Code																				
50ml	EP2005-5																				
Metal to Metal PU		Marine Repair PU		Marine Repair PU		Concrete Repair PU															
Material: Polyurethane Colour: Black Mix Ratio: 1:1 Volume: 50ml Full Cure: < 20/ 60Min		Material: Polyurethane Colour: White Mix Ratio: 1:1 Volume: 50ml Full Cure: < 10 Mins		Material: Polyurethane Colour: White Mix Ratio: 1:1 Volume: 50ml Full Cure: < 10 Mins		Material: Polyurethane Colour: Grey Mix Ratio: 1:1 Volume: 50ml Full Cure: < 30 Mins															
<table border="1"> <thead> <tr><th>Type</th><th>Part Code</th></tr> </thead> <tbody> <tr><td>20min</td><td>EP4001</td></tr> <tr><td>60min</td><td>EP4002</td></tr> </tbody> </table> 	Type	Part Code	20min	EP4001	60min	EP4002	<table border="1"> <thead> <tr><th>Size</th><th>Part Code</th></tr> </thead> <tbody> <tr><td>50ml</td><td>EP5001</td></tr> </tbody> </table> 	Size	Part Code	50ml	EP5001	<table border="1"> <thead> <tr><th>Size</th><th>Part Code</th></tr> </thead> <tbody> <tr><td>50ml</td><td>EP6001</td></tr> </tbody> </table> 	Size	Part Code	50ml	EP6001	<table border="1"> <thead> <tr><th>Size</th><th>Part Code</th></tr> </thead> <tbody> <tr><td>50ml</td><td>EP8001</td></tr> </tbody> </table> 	Size	Part Code	50ml	EP8001
Type	Part Code																				
20min	EP4001																				
60min	EP4002																				
Size	Part Code																				
50ml	EP5001																				
Size	Part Code																				
50ml	EP6001																				
Size	Part Code																				
50ml	EP8001																				

We also supply Silicone RTVs, Grease, Copper Paste, Lubricants and many other chemicals pre-filled in syringe barrels, cartridges or bottles to order. Please specify the material required and we can quote for ready-to-use components filled, labelled with batch code, shelf life and safety data.

**Adhesive Dispensing Ltd  
Unit 55 Alston Drive  
Bradwell Abbey  
Milton Keynes, Bucks, MK13 9HB, UK**

**Tel. +44 (0) 1908 686660  
Fax. +44 (0) 1908 686836  
[sales@adhesivedispensing.co.uk](mailto:sales@adhesivedispensing.co.uk)  
[www.adhesivedispensing.co.uk](http://www.adhesivedispensing.co.uk)**

Version 01-001