

**CIRRUS PILOT**  
**FLIGHT OPERATIONS MANUAL**



PLANE GENIUS™

# Flight Operations Manual



## NOTE

Procedures in this publication are derived from procedures in the FAA Approved Airplane Flight Manual (AFM) Revision A7. Cirrus Design has attempted to ensure that the data contained agrees with the data in the AFM. If there is any disagreement, ***the Airplane Flight Manual is the final authority.***

# Table of Contents

<b>Section 1 - Introduction .....</b>	<b>1-1</b>
General .....	1-1
Single Pilot Resource Management .....	1-1
Checklist Philosophy .....	1-2
Classification of Checklists .....	1-3
Reference Materials .....	1-3
Terms and Abbreviations .....	1-4
Contact Information .....	1-5
<b>Section 2 - Limitations .....</b>	<b>2-1</b>
General .....	2-1
<b>Section 3 - Standard Operating Procedures .....</b>	<b>3-1</b>
General .....	3-1
Checklist Completion for Normal Procedures .....	3-2
Preflight .....	3-4
Documentation .....	3-4
Equipment .....	3-4
Procedure (Flow Pattern) .....	3-5
Before Engine Start .....	3-16
Passenger Flight Briefing .....	3-16
Procedure (Do-List) .....	3-17
Engine Start .....	3-18
Procedure (Do-List) .....	3-18
Before Taxi .....	3-22
Procedure (Flow Pattern) .....	3-23
Avionics Configuration .....	3-23
Taxi-Out .....	3-24
Procedure (Flow Pattern) .....	3-25
Before Takeoff .....	3-26
Procedure (Do-List) .....	3-26
Take-Off .....	3-30
Sample Takeoff Briefing .....	3-30
Procedures (Flow Pattern) .....	3-30
En Route Climb .....	3-36
Procedure (Flow Pattern) .....	3-37
Avionics Configuration .....	3-38
Cruise .....	3-40

# Table of Contents

Procedure (Flow Pattern) .....	3-41
Avionics Configuration.....	3-42
Descent.....	3-44
Procedure (Flow Pattern) .....	3-45
Avionics Configuration.....	3-45
Before Landing / Traffic Pattern .....	3-46
Procedure (Flow Pattern) .....	3-47
Avionics Configuration.....	3-47
Approach.....	3-50
Stabilized Approach Criteria .....	3-50
Procedures .....	3-52
Go-Around .....	3-64
Procedure (Memory).....	3-65
Landing .....	3-66
After Landing.....	3-68
Procedure (Flow Pattern) .....	3-69
Arrival/Engine Shutdown.....	3-70
Procedure (Flow Pattern) .....	3-71
<b>Section 4 - Maneuvers.....</b>	<b>4-1</b>
General .....	4-1
Steep turns.....	4-1
Execution.....	4-1
Maneuvering during Slow Flight.....	4-2
Execution.....	4-2
Recovery .....	4-2
Power off Stalls .....	4-3
Execution.....	4-3
Recovery .....	4-3
Power on Stalls .....	4-4
Execution.....	4-4
Recovery .....	4-4
Autopilot Stall Recognition .....	4-5
AP Stall Recognition (Power Off) .....	4-5
Autopilot Stall Recognition (Cont).....	4-6
AP Stall Recognition (Power On) .....	4-6

# *Table of Contents*

<b>Section 5 - Emergency and Abnormal Procedures .....</b>	<b>5-1</b>
General .....	5-1
Checklist Completion for Abnormal Procedures.....	5-1
Checklist Completion for Emergency Procedures.....	5-1
<b>Section 6 - Performance .....</b>	<b>6-1</b>
General .....	6-1
<b>Section 7 - Supplementary Information .....</b>	<b>7-1</b>
General .....	7-1
Pilot Qualification and Training .....	7-2
Training .....	7-2
Medical Certificates .....	7-4
Takeoff and Landing Wind Proficiency.....	7-4
Takeoff, Enroute and Landing Minimums.....	7-5
Currency Requirements .....	7-6
Pilot Duty Considerations.....	7-7
Duty Time and Rest.....	7-7
Physiological .....	7-7
Aircraft Maintenance .....	7-8
Grounding of Aircraft .....	7-8
Flight Planning .....	7-9
Weather Assessment .....	7-9
Fuel Requirements .....	7-10
Minimum Runway Length.....	7-10
Noise Abatement.....	7-10
Weather .....	7-11
Overview .....	7-11
Hazards to Flight .....	7-11
Current Observations .....	7-12
Forecasted Weather.....	7-12
NOTAMS .....	7-12
Thunderstorm Flying .....	7-13
Temperature Minimums .....	7-13
Operations in Icing Conditions .....	7-14
In-Flight Considerations .....	7-15
Turns after Takeoff.....	7-15
Weather Status.....	7-15

# ***Table of Contents***

Aircraft Systems Status .....	7-15
Pilot Status .....	7-15
Situational Awareness .....	7-15
Supplemental Oxygen .....	7-16
Flight Safety .....	7-17
Sterile Cabin .....	7-17
Smoking.....	7-17
International Border Operations .....	7-18
Preflight .....	7-18
Personal Documentation .....	7-18
Aircraft Documentation .....	7-18
Crossing the United States and Canadian Border.....	7-19
Incident and Accident Procedures .....	7-20
Emergency Landing.....	7-20
Aircraft Incident and Accident Notification .....	7-20
NTSB Field Office.....	7-20
Aircraft Incident and Accident Report .....	7-21

# Section 1 - Introduction

## General

Procedures in this publication are derived from procedures in the FAA Approved Airplane Flight Manual (AFM). Cirrus Design has attempted to ensure that the data contained agrees with the data in the AFM. If there is any disagreement, ***the Airplane Flight Manual is the final authority.***

## Single Pilot Resource Management

Single Pilot Resource Management (SRM) is the art and science of managing all the resources available to a single-pilot to ensure that the successful outcome of the flight is never in doubt.

The majority of Cirrus aircraft operations are conducted single-pilot. The work load associated with flying the aircraft, configuring and monitoring avionics, communicating with air traffic control, and decision making can be overwhelming at times. The following SRM procedures have been adapted from cockpit procedures common to dual pilot transport category aircraft.

General aviation pilots have a great deal of latitude on how to manage and operate aircraft. To ensure the highest levels of safety it is strongly recommended that these single pilot operating procedures be incorporated into the operation of the aircraft.

### ***Priority of Tasks***

The following is a list of priorities that apply to any situation encountered in flight. Pilots must adhere to these priorities during every flight.

#### 1. Maintain Aircraft Control

The number one priority of the pilot is to maintain aircraft control. Pilots should maintain a high level of vigilance during periods of high and low workload to ensure aircraft control is always maintained.

## 2. Navigation

Once aircraft control is assured, pilots should set and verify the avionics are correctly configured for navigation. This task includes programming GPS units and the PFD. Use of the autopilot may assist the pilot with accomplishing these tasks. Pilots should closely monitor flight parameters while programming various avionics equipment.

## 3. Communication

Communication is an important task in the aircraft but follows aircraft control and navigation as a priority. Communicate intentions and relay instructions clearly to ATC/CTAF while maintaining aircraft control.

• Note •

Using Standard Operating Procedures will aid the pilot in timely completion of required tasks and allow the pilot to maintain high levels of situational awareness.

## Checklist Philosophy

When used properly, checklists enhance safety of flight by confirming the aircraft is appropriately configured for the flight condition. At the same time, checklists expedite the completion of procedures that are necessary to transition to subsequent phases of flight.

The electronic checklist in the MFD should be used anytime the MFD is running. Use of electronic checklists will help keep the cockpit organized and functional. Use a paper checklist whenever the MFD electronic checklists are not available.



## Classification of Checklists

All checklist procedures can be assigned one of three classifications:

- Normal: Procedures used during normal flight operations. Normal checklists can be found in the Normal Procedures section of the POH.
- Abnormal: Procedures used in response to system failures and malfunctions that, while not immediately threatening, may affect safety of flight if not addressed. Abnormal checklists can be found in the Abnormal Procedures section in the POH.
- Emergency: Procedures used in response to system failures and malfunctions that are an immediate threat to the safety of flight. Emergencies require immediate action by the flight crew to ensure a safe outcome. Emergency checklists can be found in the Emergency Procedures section of the POH.

## Reference Materials

The following references supplement the content of this publication:

- Federal Aviation Regulations (FARs) or governing regulations, as applicable,
- Aeronautical Information Manual (AIM),
- FAA Approved Airplane Flight Manual and Pilot's Operating Handbook,
- Advisory Circulars,
- Cirrus Design Training Guide,
- Cirrus Design Envelop of Safety,
- Avionics Pilot Guides and Manuals.

## Terms and Abbreviations

The following terms and abbreviations will be referenced in this manual.

AP	Autopilot
ATC	Air Traffic Control
DA	Decision Altitude
ETA	Estimated Time of Arrival
ETE	Estimated Time Enroute
FAA	Federal Aviation Administration
FAF	Final Approach Fix
FITS	FAA Industry Training Standards
GNS	Global Navigation System
GPS	Global Position System
GS	Glideslope
IAF	Initial Approach Fix
IAP	Instrument Approach Procedure
LNAV	Lateral Navigation
LPV	Localizer Performance with Vertical Guidance
MAP	Missed Approach Point
MDA	Minimum Descent Altitude
MFD	Multi Function Display
NAS	National Airspace System
PFD	Primary Flight Display
PIC	Pilot in Command
SRM	Single Pilot Resource Management
VNAV	Vertical Navigation
VTF	Vectors to Final
WAAS	Wide Area Augmentation System

## Contact Information

Air Safety Hotline.....	218-788-3400
CIRRUS Standardized Instructor Program.....	218-788-3845
	<a href="mailto:csip@cirrusdesign.com">csip@cirrusdesign.com</a>
Flight Standards and Operations.....	866-733-6273
	<a href="mailto:pilotsworld@cirrusdesign.com">pilotsworld@cirrusdesign.com</a>
Maintenance Hotline.....	800-279-4322
	<a href="mailto:fieldservice@cirrusdesign.com">fieldservice@cirrusdesign.com</a>
Sales Department .....	888-750-9927
	<a href="mailto:info@cirrusdesign.com">info@cirrusdesign.com</a>
Factory Transition Training/Cirrus Concierge.....	218-788-3352
	<a href="mailto:concierge@cirrusdesign.com">concierge@cirrusdesign.com</a>

Intentionally Left Blank

## Section 2 - Limitations

### General

The Limitations Section of the Pilot's Operating Handbook (POH) is the official document approved by the Federal Aviation Administration. It provides operating limitations, instrument markings, basic placards required by regulation, and standard systems and equipment required for safe operation. For amended operating limitations for airplanes equipped with optional equipment, refer to Section 9 - Supplements of the Pilot's Operating Handbook.

Compliance with the operating limitations in Pilot's Operating Handbook is required by Federal Aviation Regulations.

Intentionally Left Blank

# Section 3 - Standard Operating Procedures

## General

The Standard Operating Procedures section describes the recommended procedures when operating a Cirrus aircraft during visual and instrument conditions. This information should serve as a framework for aircraft and avionics management. These standard operating procedures were developed and are used by pilots at Cirrus Design. The procedures outlined are considered the best operating practices while flying Cirrus aircraft; however, these procedures may not be inclusive to all variables encountered in the national airspace system. Cirrus pilots are encouraged to follow the procedures outlined in this manual and use their best judgment when handling non standard situations.

Utilizing these standard operating procedures will enhance the situational awareness of the pilot in both single pilot and crew situations and allow for timely completion of tasks in the aircraft. Adhering to these procedures will help the pilot take full advantage of the aircraft's capabilities while maintaining a high level of safety.

• Note •

Procedures in this publication are derived from procedures in the FAA Approved Airplane Flight Manual (AFM). Cirrus Design has attempted to ensure that the data contained agrees with the data in the AFM. If there is any disagreement, ***the Airplane Flight Manual is the final authority.***

## Checklist Completion for Normal Procedures

Normal procedure checklists can be completed as a flow pattern or a do-list. The appropriate method for checklist completion for each normal procedure is indicated in the procedures section for each phase of flight.

**Do-List:** A do-list checklist is executed by reading the checklist item and selecting the appropriate condition of the item. Do-lists are used when procedure sequence and/or item condition is critical to completion of the procedure and when ample time exists for completion of the checklist.

**Flow Pattern:** The term “flow pattern” refers to a logical path through the cockpit that the pilot will move along during the execution of the checklist. Flow patterns use a “do and verify” approach to checklist completion. The items and their conditions are memorized and executed without immediate reference to the written checklist. Following completion of the flow pattern, the checklist is referenced as soon as time and workload permit to ensure procedure completion.

*When used properly, flow patterns allow timely configuration of the aircraft for the appropriate flight condition. Flow patterns are used when procedure sequence and aircraft condition is not critical and there is an operational advantage to executing the checklist items in a timely manner.*



Intentionally Left Blank

## Preflight

The preflight inspection should be completed as a flow pattern when the pilot is familiar with the aircraft preflight inspection checklist. Always refer to the aircraft checklist after the flow to verify all items have been completed.

## Documentation

The following documents must be in the aircraft for the flight:

- Certificate of Airworthiness,
- Registration,
- FAA Approved Airplane Flight Manual and Pilot's Operating Handbook, including weight and balance,
- Radio station license for international operations,
- Appropriate avionics publications.

## Equipment

The following equipment should be carried in the aircraft when appropriate:

- Survival kit (appropriate to the climate and conditions),
- Approved flotation devices for flights outside glide distance to land,
- Supplemental oxygen system for high altitude operations,
- Chocks, tie downs, extra oil, tow bar, engine and airplane covers.

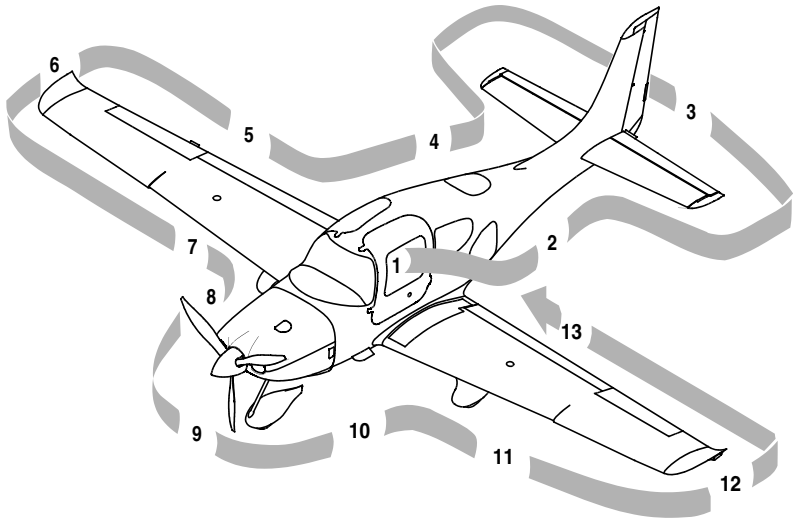

## Procedure (Flow Pattern)

1. Cabin
  - a. Required Documents.....On Board  
*Ensure Airworthiness Certificate is visible to occupants, Registration Certificate, Pilot's Operating Handbook and Aircraft Weight and Balance are on board the aircraft.*
  - b. Avionics Power Switch.....OFF
  - c. Bat 2 Master Switch .....ON
  - d. PFD .....Verify ON  
*Verify on and alignment process beginning.*
  - e. Avionics Cooling Fan..... Audible  
*Listen for cooling fan operation.*
  - f. Voltmeter ..... 23-25 Volts  
*Verify with voltmeter located in the upper left hand corner of the PFD (volts will be displayed any time voltage is below 25 volts) or analog voltmeter if installed.*

- g. Flap Position Light ..... OUT  
*Verify flap position light is not illuminated to ensure isolation diode is functioning properly.*
- h. Bat 1 Master Switch..... ON
- i. Lights ..... Check Operation  
*Verify operation of required interior (overhead, instrument and panel lights) and exterior (navigation, landing and anti-collision lights).*
- j. Stall Warning ..... Test  
*Test stall warning system by applying suction to the stall warning system inlet and noting the warning horn sounds.*
- k. Fuel Quantity ..... Check  
*Ensure fuel quantity is sufficient for planned flight and corresponds to fuel amount in tanks and on MFD.*
- l. Fuel Selector ..... Select Fullest Tank  
*Switch fuel selector to the fullest tank. Maximum fuel imbalance: 7.5 (SR20), 10 gal (SR22).*
- m. Flaps..... 100%, Check Lights ON  
*Visually verify down and ensure light corresponds with flap setting.*
- n. Oil Annunciator ..... ON
- o. Bat 1 and 2 Master Switches..... OFF  
*Ensure both battery switches are turned off. Battery master 2 may be left on if engine start is pending to maintain PFD alignment.*
- p. Alternate Static Source..... NORMAL  
*Visually verify alternate static source located near pilot's right knee, above circuit breaker panel is in the NORMAL position.*
- q. Circuit Breakers ..... IN  
*Ensure all circuit breakers are in and none are in re-settable (tripped) condition.*

- r. Fire Extinguisher ..... Charged and Available  
*Inspect extinguisher and ensure pin and safety wire are in tact. There is no gauge to measure quantity.*
  - s. Emergency Egress Hammer ..... Available  
*Hammer should be stowed securely inside lid of the arm rest between the front seats.*
  - t. CAPS Handle ..... Pin Removed  
*Remove safety pin and stow for remainder of flight. Be sure to replace CAPS cover after pin removal as it is a required placard.*
2. Left Fuselage
- a. COM 1 Antenna..... Condition and Attachment  
*Visually check condition of antenna and surrounding area of fuselage.*
  - b. Wing/Fuselage Fairing..... Check  
*Visually inspect the wing root fairing for attachment along upper and lower surfaces of wing root.*
  - c. COM 2 Antenna..... Condition and Attachment  
*Visually inspect the wing root fairing for attachment along upper and lower surfaces of wing root.*
  - d. Baggage Door ..... Closed and Secure  
*Physically check for locked and secured door and ensure keys are removed.*
  - e. Static Button ..... Check for Blockage  
*Ensure removal of static covers if used and check for any blockage within static port openings.*
  - f. Parachute Cover ..... Sealed and Secured  
*Visually inspect area on top rear of fuselage directly behind rear top window for any cracks.*
3. Empennage
- a. Tie Down Rope..... Remove  
*Visually verify tail tie down is removed and stowed.*

- b. Horizontal and Vertical Stabilizers .....Condition  
*Inspect leading edges and top of vertical stabilizer for any abnormalities. Ensure the clear tape covering inspection hole on outer tip of elevator, inside of elevator horn is intact.*
  - c. Elevator and Tab ..... Condition and Movement  
*Check elevator for range of motion. Inspect tab on left side of elevator for condition. Visually inspect counter weight inside elevator horn for security. Check all hinges, bolts and cotter pins.*
  - d. Rudder ..... Freedom and Movement  
*Inspect for full range of motion. Inspect all hinges, bolts and cotter pins from the left side of the rudder. Visually inspect counter weight inside top leading edge of rudder horn for security.*
  - e. Rudder Trim Tab .....Condition and Security
  - f. Attachment Hinges, Bolts and Cotter Pins ..... Secure  
*Verify all moveable control surfaces are secure and all bolts and cotter pins are in place.*
4. Right Fuselage
- a. Static Button ..... Check for Blockage  
*Ensure removal of static covers and check for any blockage within static port openings.*
  - b. Wing/Fuselage Fairings ..... Check  
*Visually inspect the wing root fairing for attachment along upper and lower surfaces of wing root.*
5. Right Wing Trailing Edge
- a. Flaps and Rub Strip (if installed) .....Condition and Security  
*Inspect flap hinges, bolts and cotter pins for security and verify a small amount of movement when flaps are in an extended position. Visually inspect rub strip for abnormal chaffing.*
  - b. Aileron and Tab ..... Condition and Movement  
*Verify full deflection of right aileron and ensure opposite deflection of left aileron. Inspect control assemblies located*

*near the leading edge of outboard and inboard aileron. Inspect the security of the bolt located under the inboard edge of the aileron.*

- c. Aileron Gap Seal (SR22)..... Security  
*Visually inspect the aileron gap seal for attachment along the entire surface.*
  - d. Hinges, Actuation Arm, Bolts and Cotter Pins..... Security  
*Verify all moveable control surfaces are secure and all bolts and cotter pins are in place.*
6. Right Wing Tip
- a. Tip ..... Attachment  
*Ensure all screws are in place on upper and lower surfaces. Visually inspect for damage to leading edge, trailing edge, and wing tip.*
  - b. Strobe, Nav Light and Lens ..... Condition and Security  
*Inspect for security of lights and lighting covers. Strobe lights are required for all flight operations. Navigation lights are required for all night operations*
  - c. Fuel Vent (underside) ..... Unobstructed  
*Verify there are no obstructions to the fuel vent.*
7. Right Wing Forward and Main Gear
- a. Leading Edge and Stall Strips ..... Condition  
*Inspect leading edge for any abnormalities. Ensure both stall strips are secured.*
  - b. Fuel Cap ..... Check Quantity and Secure  
*Visually check fuel is at desired amount and the fuel cap is secured and locking tab is facing rearward. Lock fuel caps as desired.*
  - c. Fuel Drains (2 underside) ..... Drain and Sample  
*Use a clear fuel strainer and sample fuel from the main tank and the collector tank. Visually check color for grade of fuel and inspect for contaminants. Ensure fuel drains do not leak*

*after taking sample. Do not use the same sample cup used to drain the TKS system.*

- d. Wheel Fairings..... Security, Accumulation of Debris  
*Physically ensure security of wheel pants. Check for and remove any debris in wheel pants (ice or slush may have formed during taxi).*
- e. Tire .....Condition, Inflation and Wear  
*Inspect tire for excessive wear to include flat spots, bald spots or visible tire chords. Ensure adequate tire inflation. Moving the aircraft may be necessary to visually inspect the entire tire for overall condition if excessive wear is suspected.*
- f. Wheel and Brakes .....Condition  
*Inspect the area directly surrounding the wheel for evidence of fluid leaks. Visually inspect brakes temperature sticker for evidence of overheating. (Center of blue inspection disc is white in a normal condition, dark gray when overheated.)*
- g. Chocks and Tie Down Ropes .....Remove  
*Ensure all wheel chocks and tie down ropes are removed and stowed.*
- h. Cabin Air Vent..... Unobstructed  
*Visually inspect air vent for debris or obstructions which could prevent fresh air flow to the cabin.*

8. Nose, Right Side

- a. Vortex Generator (SR22).....Condition  
*Inspect condition of vortex generator and ensure it has not been damaged.*
- b. Cowling..... Attachments Secure  
*Visually inspect each cam lock for secure fitting along top and side of cowls. Screws should be inspected along center bottom and directly behind spinner. Two screws behind the spinner will be removed to de-cowl or to add/remove winterization kits. It is imperative that these screws not be overlooked during preflight as severe cowl damage will result if engine is started without them in place.*



- c. Exhaust Pipe ..... Condition, Security and Clearance  
*SR20/SR22 - Ensure there is adequate clearance between lower cowling and exhaust pipes and verify they are secure with some movement. Inspect heat shield for security.*  
*SR22 Turbo - Ensure each tailpipe is secure by grasping the end of the tailpipe. Loose tailpipes should be serviced prior to flight. Do not fly an aircraft with loose tailpipes.*
  - d. Transponder Antenna .....Condition and Attachment  
*The transponder antenna is located under the engine cowl aft of the nose wheel strut attachment. Inspect and ensure secure.*
  - e. Gascolator (underside) ..... Drain for 3 Seconds, Sample  
*Use clear fuel strainer and drain for 3 seconds. Inspect fuel sample for contaminants and proper color. Ensure drain does not leak after taking sample.*
9. Nose Gear, Propeller and Spinner
- a. Tow Bar ..... Remove and Stow
  - b. Strut ..... Condition  
*Inspect strut and fairing for condition and security.*
  - c. Wheel Fairing ..... Security, Accumulation of Debris  
*Ensure fairing is not damaged and is attached securely.*
  - d. Wheel and Tire .....Condition, Inflation and Wear
  - e. Propeller ..... Condition  
*Inspect the propeller blades for smoothness and ensure there are no significant nicks in the blades. Check for any damage to the tips of each blade.*
  - f. Spinner ..... Condition, Security and Oil Leaks  
*Ensure spinner screws are secure, check for any oil on spinner, propeller blades or cowling.*

- g. Air Inlets..... Unobstructed  
*Verify air inlets are free of obstructions and ensure cowling screws are secured. If winterization kits are installed, check for security of the kit and screws.*
- h. Alternator .....Condition  
*SR20 - Physically verify security of alternator, electrical connections and belt.*  
*SR22 - Physically verify security of alternator and electrical connections.*

10. Nose Left Side

- a. Landing Light .....Condition  
*Verify landing light is intact and cover is secure with no cracks.*
- b. Engine Oil .....Check  
*Visually verify oil quantity, ensure oil cap is tightly secured and both latches on the oil door are locked.*  
*When opening oil door, do not let latches snap back against oil door as this may lead to paint chipping and cracking.*
- c. Cowling ..... Attachment Secure  
*Visually inspect each cam lock for secure fitting along top and side of cowls. Screws should be inspected along center bottom and directly behind spinner.*
- d. External Power .....Door Secure  
*Ensure cam lock is secured. Phillips head screw driver may be required to secure.*
- e. Vortex Generator (SR22) .....Condition  
*Inspect condition of vortex generator and ensure it has not been damaged.*
- f. Exhaust Pipes..... Condition, Security and Clearance  
*SR20/SR22 - Ensure there is adequate clearance between lower cowling and exhaust pipes and verify they are secure with some movement. Inspect heat shield for security.*

*SR22 Turbo - Ensure each tailpipe is secure by grasping the end of the tailpipe. Loose tailpipes should be serviced prior to flight. Do not fly an aircraft with loose tailpipes.*

11. Left Main Gear and Forward Wing

- a. Wheel Fairings..... Security, Accumulation of Debris  
*Physically ensure security of wheel pants. Check for debris in wheel pants (ice or slush may have formed during taxi).*
- b. Tire .....Condition, Inflation and Wear  
*Inspect tire for excessive wear to include flat spots, bald spots or visible tire chords. Ensure adequate tire inflation. Moving the aircraft may be necessary to visually inspect the entire tire for overall condition if excessive wear is suspected.*
- c. Wheels and Brakes .....Condition  
*Inspect the area directly surrounding the wheel for evidence of fluid leaks. Visually inspect brakes temperature sticker for evidence of overheating. (Center of blue inspection disc is white in a normal condition, dark gray when overheated.)*
- d. Chock and Tie Down Ropes..... Remove  
*Ensure all wheel chocks and tie down ropes are removed and stowed securely to prevent hazards to others.*
- e. Fuel Drains (2 underside)..... Drain and Sample  
*Use a clear fuel strainer and sample fuel from the main tank and the collector tank. Visually verify color for grade of fuel and inspect for contaminants. Ensure fuel drains do not leak after taking sample.*
- f. Cabin Air Vent.....Unobstructed  
*Visually inspect air vent for debris or obstructions which could prevent fresh air flow to the main cabin.*
- g. Fuel Cap..... Check Quantity and Secure  
*Visually verify fuel is at desired amount and that the fuel cap is secured and locking tab is facing rearward.*
- h. Leading Edge and Stall Strips.....Condition  
*Inspect leading edge for any abnormalities. Ensure both stall strips are secured.*

12. Left Wing Tip

- a. Fuel Vent (underside) ..... Unobstructed  
*Verify there are no obstructions to the fuel vent.*
- b. Pitot Mast (underside) .....Cover Removed, Tube Clear  
*Ensure cover removed and stowed, inspect tube inside and out for any obstructions.*
- c. Strobe, Nav Light and Lens .....Condition and Security  
*Inspect for security of lighting covers. Strobe lights are required for all flight operations. Navigation lights are required for night operations.*
- d. Tip.....Attachment  
*Ensure all screws are in place on upper and lower surfaces. Visually inspect for and damage to leading edge, trailing edge and wing tip.*

13. Left Wing Trailing Edge

- a. Flap and Rub Strip.....Condition and Security  
*Inspect flap hinges, bolts and cotter pins for security and verify a small amount of movement when flaps are in an extended position. Visually inspect rub strip for abnormal chaffing.*
- b. Aileron ..... Freedom of Movement  
*Verify full deflection of right aileron and ensure opposite deflection of left aileron. Inspect control assemblies located near the leading edge of outboard and inboard aileron. Inspect the security of the bolt located under the inboard edge of the aileron.*
- c. Aileron Gap Seal (SR22) ..... Security  
*Visually inspect the aileron gap seal attachment along the entire surface.*
- d. Hinges, Actuation Arm, Bolts and Cotter Pins ..... Secure  
*Verify all moveable control surfaces are secure and all bolts and cotter pins are in place.*

Intentionally Left Blank

## Before Engine Start

Complete the Before Starting Engine checklist as a Do-List to start the aircraft engine. Before starting the engine verify all preflight items are complete and all emergency equipment is on board and stored in the proper location. Remove the CAPS pin after all occupants have boarded the aircraft and are seated with seat belts fastened. Ensure seats are locked into position by verifying the control handle is in the full down position.

During engine start the aircraft should be positioned so that the propeller blast is not directed toward any aircraft, hangar, or person.

## Passenger Flight Briefing

The pilot should provide a safety briefing, referencing the Passenger Briefing Card, to all passengers prior to each flight. The briefing shall provide instructions in the event of a pilot incapacitation including the use of the CAPS, seat belts, exits, and any other safety equipment on the aircraft. The pilot should also discuss sterile cabin procedures and other information as necessary.

At a minimum, passengers should be briefed on the following items;

- CAPS,
- Smoking,
- Seatbelts,
- Doors,
- Emergency Exits/Egress Hammer,
- Use of Oxygen.

## Procedure (Do-List)

1. Preflight Inspection ..... COMPLETE  
*Verify preflight inspection has been completed and all items are completed.*
2. Emergency Equipment ..... ON BOARD  
*Verify all safety equipment required for flight is on board and in working/proper order. This may include, but is not limited to, personal flotation equipment, life raft, flash light, batteries, cold weather equipment, etc.*
3. Passengers ..... BRIEFED  
*Ensure all passengers have been briefed according to the Cirrus Aircraft Passenger Briefing Card and verify a briefing card is located in each seatback. See passenger briefing items listed in previous section.*
4. Seats, Seatbelts and Harnesses ..... ADJUST AND SECURE  
*Verify all seats, including seat backs and undercarriage is locked, belts and harnesses are securely adjusted and fastened for all occupants of the aircraft.*

**• Caution •**

Crew seats must be locked in position and control handles fully down before flight. Ensure seat belt harnesses are not twisted.

## Engine Start

The Engine Start checklist should be accomplished as a do-list. Select the proper engine start procedure based on outside air temperature and internal engine temperature.

If engine has been exposed to temperatures at or below 20°F (7°C) for a period of two hours or more, the use of an external pre-heater and external power is recommended. Failure to properly pre-heat a cold soaked engine may result in congealing within the engine, oil hoses, and oil cooler with subsequent loss of oil flow, possibly internal damage to the engine, and subsequent engine failure.

If the engine does not start during the first few attempts, or if the engine firing diminishes in strength, the spark plugs have probably frosted over. Preheat must be used before another start is attempted.

### Procedure (Do-List)

1. External Power (if applicable)..... CONNECT  
*If required, pilots may want to ensure power connection and brief assisting personnel on securing external power receptacle door.*

#### • WARNING •

If airplane will be started using external power, keep all personnel and power unit cables well clear of the propeller rotation plane.

2. Brakes ..... HOLD  
*Parking brake may be used; however, constant pressure should be applied at all times using toe brakes.*
3. Bat Master Switches ..... ON (check volts)  
*Voltage should read approximately 23-25 volts for battery starts.*
4. Strobe Lights ..... ON  
*Turn strobe lights on prior to engine start. For night operations, pilot may instead consider the use of navigation lights to avoid distracting others.*



5. Mixture ..... FULL RICH  
*Mixture lever should be in the full rich position for normal engine start.*
6. Power Lever ..... FULL FORWARD  
*Power lever will need to be in the full forward position in order to prime the engine.*
7. Fuel Pump ..... PRIME, then BOOST  
*SR20 - On first start of the day, especially under cool ambient conditions, holding Fuel Pump switch to PRIME for 2 seconds will improve starting.*  
*SR22 - Serials 0002-0278 before SB 22-73-01: On first start of the day, especially under cool ambient conditions, holding Fuel Pump Switch to PRIME for 30-60 seconds will improve starting.*  
*SR22 - Serials 0002-0278 after SB 22-73-01 and serials 0279 and subsequent: On first start of the day, especially under cool ambient conditions, holding Fuel Pump Switch to PRIME for 2 seconds will improve starting.*
8. Propeller Area ..... CLEAR  
*Visually clear the area around propeller and ensure area behind aircraft is clear and that no one is approaching the aircraft.*
9. Power Lever ..... OPEN ¼ INCH  
*Open power lever and maintain one hand on power lever.*
10. Ignition Switch ..... START  
*Hold key in Start position until positive engine start then release verifying key is in the BOTH position.*

• **Caution** •

Limit cranking to intervals of 20 seconds with a 20 second cooling period between cranks. This will improve battery and contactor life.

11. Power Lever .....RETARD (to maintain 1000 RPM)  
*Adjust the power lever as necessary to maintain engine smoothness and engine speed at 1000 RPM.*
- a. Oil Pressure ..... CHECK

**• Caution •**

After starting engine, if the oil gauge does not begin to show pressure within 30 seconds in warm weather and about 60 seconds in very cool weather, shut down engine and investigate cause. Lack of oil pressure indicates loss of lubrication, which can cause severe engine damage.

12. Mixture (SR22 Turbo) ..... Lean  
*Lean the mixture for maximum RPM rise shortly after engine start and leave the mixture lean during taxi until the run up.*  
*It is acceptable to lean the SR20 and SR22 using the same procedure described above for high altitude operations or if spark plug fouling is suspected.*

13. Alt Master Switches ..... ON  
*Turn on both alternator master switches after engine start.*

**• Caution •**

Alternators should be left OFF during engine starting to avoid high electrical loads.

14. Avionics Power Switch ..... ON  
*Turn on avionics power switch and verify all avionics power up.*

15. Engine Parameters ..... MONITOR  
*Monitor all engine parameters to include manifold pressure, engine speed, oil pressure and temperature, EGT's, and CHT's. If any system displays an abnormal indication, engine shutdown should be considered and the problem investigated.*

16. External Power (if applicable) ..... DISCONNECT  
*Verify external power is removed and external power door secured by the assisting personnel. Consider reducing power to idle while external power is disconnected to minimize propeller blast.*

*Carefully observe the process in case there is a need for engine shutdown.*

17. Amp Meter/Indication ..... CHECK

*Check the amperage output of both Alternators; Alt 1 should indicate a positive amperage and Alt 2 below 1700 RPM's will be 0. Check voltage of both batteries. Excessively high or low readings may indicate a problem and should be investigated.*

**Ice Protection System Preflight**

The following pre-flight procedures should be completed on aircraft with the TKS Ice Protection System installed. Complete this procedure monthly during periods of non-use or anytime use of the system may be necessary during flight. Flight into known icing is prohibited.

1. Battery Master Switch ..... ON

*Turn on the battery 1 master switch.*

2. Ice Protection Switch ..... MAXIMUM

*Turn the ice protection on and select the maximum position.*

3. Anti-Icing Fluid Quantity ..... CHECK FULL

*Check fluid quantity by visually inspecting tank quantity. Top off tank with approved fluids. De-ice fluid must meet DTD 406B including:*

- AVL (DTL 406B) – Aviation Laboratories,
- AL-5 (DTB 406B) – Canyon Industries,
- Dimax 80 (TKS-80) – Canyon Industries,
- TKS-Fluid (DTB 406B) – D.W. Davies & Co.

4. Fluid Vent (underside) ..... UNOBSTRUCTED

5. Porous Panels ..... Condition and Security

6. Porous Panels ..... Evidence of De-icing Fluid

*Run system until all panels are wetted by fluid.*

7. Slinger Ring ..... Evidence of De-icing Fluid

8. Ice Protection Switch ..... OFF

9. Battery Master Switch ..... OFF

## Before Taxi

Complete the Before Taxi checklist as a flow and reference the aircraft checklist to verify all items are complete. It is recommended to set up the required navigation equipment and communication frequencies for the intended flight at this time. Primary navigation should be set into GPS 1 and secondary or auxiliary navigation set into GPS 2 if needed. Set primary airborne frequencies into COM 1 and necessary ground frequencies into COM 2.

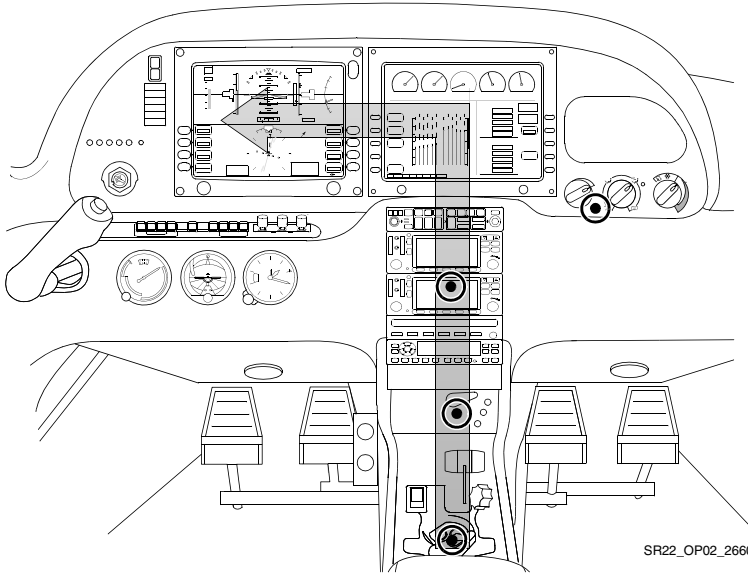

### Before Taxi Flow

## Procedure (Flow Pattern)

1. Flaps ..... UP (0%)  
*Visually verify flaps are in the 0% position and flap position light UP is illuminated.*
2. Radios/Avionics ..... AS REQUIRED  
*Ensure all radios and avionics are programmed, navigation frequencies identified, courses set and with required waypoints or flight plans loaded in GPS.*
3. Cabin Heat/Defrost ..... AS REQUIRED
4. Fuel Selector.....SWITCH TANK  
*Switch tank to ensure positive fuel flow from both fuel tanks.*

## Avionics Configuration

- Transponder - Verify transponder is in STBY mode. Set code if assigned,
- Autopilot - Verify the autopilot is in A/P RDY mode,
- GPS Units/Audio Panel - Confirm each GPS database is current. Construct flight plans and configure communications as required,
- MFD - Confirm database are current, set initial fuel, review MFD risk assessment pages and verify oil temperature and pressure are within parameters,
- PFD - Verify PFD is initialized and ready for taxi.

## Taxi-Out

A cause of brake failure is the creation of excessive heat through improper braking practices. Riding the brakes while taxiing causes a continuous build up of energy which may lead to excessive heat. Excessive heat causes warped brake rotors, damaged or glazed linings, damaged o-rings, and vaporized brake fluid. To avoid brake failure, observe the following operating and maintenance practices:

- Directional control should be maintained with rudder deflection supplemented with brake pressure as required,
- Use only as much power (throttle) as is necessary to achieve forward movement. 1000 RPM is enough to maintain forward movement under normal conditions,
- Avoid unnecessary high speed taxiing. High speed taxiing will result in excessive demands on the brakes, increased brake wear and the possibility of brake failure,
- Use the minimum necessary brake application to achieve directional control,
- Do not ride the brakes. Pilots should consciously remove pressure from the brakes while taxiing. Failure to do so results in excessive heat, premature brake wear, and increased possibility of brake failure,
- Refer to the Handling, Service and Maintenance section of the POH or the Maintenance manual for recommended maintenance and inspection intervals for brakes.

Maintain high levels of situational awareness during all movement on the airport surface to avoid a runway incursion accident. Minimize tasks such as reading checklists or folding maps while taxiing. Utilize the CMax airport diagram to aid in situational awareness.

### • **WARNING** •

Maximum continuous engine speed for taxiing is 1000 RPM on flat, smooth, hard surfaces. Power settings slightly above 1000 RPM are permissible to start motion, for turf, soft surfaces, and on inclines. Use minimum power to maintain taxi speed.

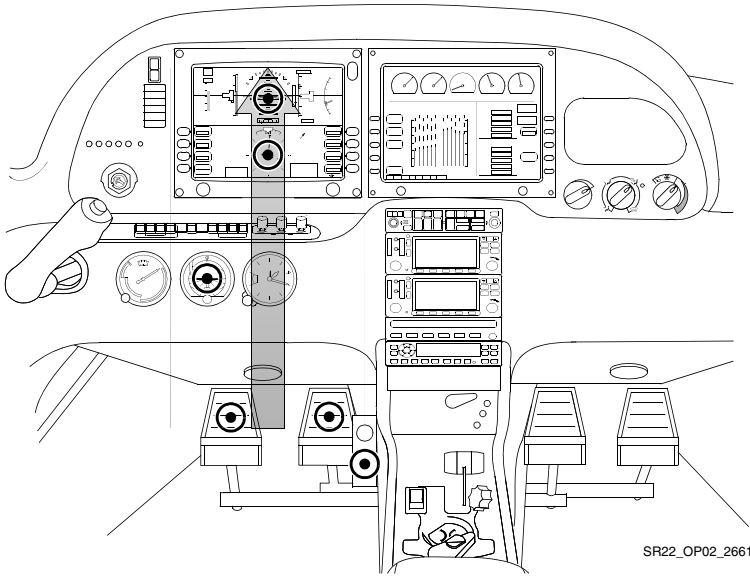

### Taxi-Out Flow

#### Procedure (Flow Pattern)

1. Parking Brake ..... DISENGAGE  
*Manually depress parking brake and ensure completely down.*
2. Brakes ..... CHECK  
*Upon initial movement verify both brakes are functioning by applying pressure.*
3. HSI Orientation ..... CHECK  
*Visually check HSI alignment with magnetic compass.*
4. Attitude Gyro ..... CHECK  
*Verify gyro is erect and horizon bars are set level.*
5. Turn Coordinator ..... CHECK  
*During turns on the ground, verify the turn indicator displays a turn in the direction of the turn and inclinometer displays a skid.*

## Before Takeoff

Complete the Before Takeoff checklist as a do-list. Complete the checklist prior to taking the active runway or an appropriate run up area prior to departure. The Before Takeoff checklist will ensure the aircraft is properly configured for takeoff. Run-up items are included in this checklist. Verify engine oil temperature reaches a minimum of 100° F prior to applying run up power settings. Verify all engine and electrical indications are normal prior to departure.

During cold weather operations, the engine should be properly warmed before takeoff. In most cases this is accomplished when the oil temperature has reached at least 100° F. In warm or hot weather, precautions should be taken to avoid overheating during prolonged ground engine operation. Additionally, long periods of idling may cause fouled spark plugs.

### Procedure (Do-List)

1. Doors .....LATCHED  
*Verify both top and bottom latch of each door is securely latched. Press firmly at each door latch position to determine the security of each door.*
2. CAPS Handle ..... Verify Pin REMOVED  
*Verify the CAPS pin is removed and stowed. Ensure cover placard is securely fastened.*
3. Seat Belts and Shoulder Harness ..... SECURE  
*Verify the security and placement of all seat belts and shoulder harnesses of each occupant. Also, verify all occupants are properly informed of seat belt requirements and operation.*
4. Fuel Quantity ..... CONFIRM  
*Confirm the fuel quantity is sufficient for the planned flight and fuel tank quantities are balanced.*
5. Fuel Selector ..... FULLEST TANK  
*Ensure the fuel selector is drawing fuel from the fullest tank.*
6. Fuel Pump (SR20/SR22) ..... ON  
Fuel Pump (SR22 Turbo) ..... LOW BOOST



7. Mixture ..... AS REQUIRED  
*SR20 - Set the mixture full rich for all altitudes.*  
*SR22 - Set the mixture full rich for sea level departures. Set mixture control lever for maximum power on takeoff for altitudes higher than sea level. Reference the Max Power Fuel Flow placard for proper mixture setting.*  
*SR22 Turbo - Set the mixture full rich for all altitudes.*
8. Flaps ..... SET 50% & CHECK  
*Select flaps to 50% and visually verify both flaps are in position prior to takeoff.*
9. Transponder ..... SET  
*Set assigned squawk code if one is given, otherwise, set the appropriate code.*
10. Autopilot ..... CHECK  
*Ensure autopilot modes HDG, ALT, VS, and NAV are tested in accordance with autopilot supplement in POH.*
11. Navigation Radios/GPS ..... Set for Takeoff  
*Verify radio frequencies are set, to include tower/departure frequencies. Check GPS flight plan for accuracy and correct initial waypoint.*
12. Cabin Heat/Defrost ..... AS REQUIRED  
*Set environmental controls as desired prior to takeoff.*  
*SR22 - Turn the air conditioner OFF for maximum performance takeoffs and climbs.*
13. Brakes ..... HOLD  
*Firmly hold brakes. Set the parking brake if assistance is required.*
14. Power Lever ..... 1700 RPM  
*Increase power lever to 1700 RPM for engine run-up. Ensure oil temperature is at least 100° F prior to increasing power.*

15. Alternator ..... CHECK

*Alternator will be checked by placing greater electrical loads and turning on additional equipment below.*

- a. Pitot Heat..... ON
- b. Navigation Lights ..... ON
- c. Landing Light ..... ON
- d. Annunciator Lights ..... CHECK

*Verify both ALT 1 and ALT 2 caution lights are extinguished and positive amps are indicated. If necessary, increase engine speed to extinguish ALT 2 caution light. ALT 2 caution light should go out below 2200 RPM.*

16. Voltage ..... CHECK

*Verify positive voltage outputs for both the Main and Essential Bus.*

17. Pitot Heat ..... AS REQUIRED

*Pitot heat should be turned ON prior to flight into IMC or flight into visible moisture and OAT of 40°F or less. Verify PITOT HEAT annunciator does not illuminate when pitot heat is turned on to ensure operation.*

18. Navigation Lights..... AS REQUIRED

*Select navigation lights ON for night operations.*

19. Landing Light ..... AS REQUIRED

*Select landing light ON. It is recommended to leave the landing light on while within 10NM of the departure airport.*

20. Magnetos ..... CHECK LEFT and RIGHT

- a. Ignition Switch ..... R, note RPM, then BOTH
- b. Ignition Switch ..... L, note RPM, then BOTH

*RPM drop must not exceed 150 RPM for either magneto. RPM differential must not exceed 75 RPM between magnetos. If there is a doubt concerning operation of the ignition system, RPM checks at higher engine speeds will usually confirm whether a deficiency exists. An absence of RPM drop may indicate faulty grounding of*

*one side of the ignition system or magneto timing set in advance of the specified setting.*

21. Engine Parameter ..... CHECK  
*Visually verify all engine parameters are in acceptable ranges. Check Oil pressure and temperature, RPM, manifold pressure, EGT and CHT.*
22. Power Lever ..... 1000 RPM
23. Flight Instruments, HSI and Altimeter ..... CHECK and SET  
*Set all flight instruments for initial course and altitude. Verify the HSI displays proper course and heading when checked with magnetic compass. Ensure local altimeter has been set and is within 75 feet of field elevation.*
24. Flight Controls ..... FREE & CORRECT  
*Check for full range of motion of the control yoke and control surface deflection corresponds to yoke deflection.*
25. Trim ..... SET for Takeoff  
*Set electric trim in the takeoff position as displayed on control yoke arm.*
26. Autopilot ..... DISCONNECT  
*Ensure PFD heading, altitude and vertical speed bugs are set and the autopilot is disconnected.*

## Take-Off

Reference the Takeoff checklist prior to departure. Complete a takeoff briefing to review the critical items prior to takeoff. A takeoff briefing allows the pilot to review the takeoff procedure and determine the actions necessary in the event of abnormal/emergency conditions during the takeoff roll and initial climb. At a minimum, a takeoff briefing should include the following items:

- Type of procedure used (normal, short, or soft),
- Takeoff distance required / runway distance available,
- $V_R$  and initial climb speed,
- Abnormality / engine failure before  $V_R$ ,
- Abnormality / engine failure after  $V_R$ .

### Sample Takeoff Briefing

This will be a \_\_\_\_\_ (normal, short, soft) takeoff from RWY \_\_\_\_\_ with a takeoff distance of \_\_\_\_\_ feet and \_\_\_\_\_ feet of runway available. Rotation speed is \_\_\_\_\_ KIAS. Initial heading after takeoff is \_\_\_\_\_ degrees to an altitude of \_\_\_\_\_ feet. Abort the takeoff for any engine failures/abnormalities prior to rotation. If the engine fails after rotation I will \_\_\_\_\_.

### Procedures (Flow Pattern)

#### *Normal Takeoff*

The recommended flap setting for a normal takeoff is 50%. Align the aircraft on the runway centerline and smoothly apply full power. It should take approximately 4 seconds to add full power. Slight brake pressure may be required for directional control early in the takeoff roll. Maintain directional control with rudder during the takeoff roll after sufficient rudder control is available. Check engine and airspeed indications early in the takeoff roll to ensure proper function. Discontinue the takeoff by reducing the power to idle and brakes as necessary for any abnormal engine or airspeed indications, sluggish acceleration, or rough engine. At  $V_R$  smoothly apply back pressure to the control yoke sufficient to rotate the aircraft. Pitch the aircraft for approximately  $7.5^\circ$  (SR20),  $10^\circ$  (SR22) to intercept  $V_X$  or  $V_Y$  as

appropriate. Maintain coordination with proper rudder input during the climb out.

1. Brakes ..... Release (steer with rudder)  
*Initially, a slight amount of differential braking may be required for directional control. As airspeed increases, both feet should be removed from toe brakes and directional control maintained with rudder inputs.*
2. Power Lever ..... FULL FORWARD  
*Smoothly increase power lever full forward for maximum takeoff power. Do not confuse any detents for a full power setting. Engine speed should be approximately 2700 RPM. Discontinue takeoff if any rough or sluggish acceleration is noted.*
3. Engine Parameters ..... CHECK  
*Monitor engine parameters during the takeoff roll. The engine monitoring page should be displayed on the MFD if possible. If any abnormal or questionable indications arise, consider aborting takeoff early in the takeoff roll.*
4. Elevator Control ..... ROTATE Smoothly at  $V_R$   
*As airspeed approaches  $V_R$ , smoothly and gradually apply back pressure to the control yoke to increase the angle of attack sufficient to rotate the aircraft.*  
 $V_R$  (SR20) 65 KIAS  
 $V_R$  (SR22) 70-73 KIAS
5. Flaps ..... UP  
*Retract the flaps after the following conditions have been met. Slight back pressure may be required after flap retraction*
  - SR20 - 85 KIAS,
  - SR22 - 80 KIAS,
  - Positive rate of climb,
  - Clear of terrain and obstacles.

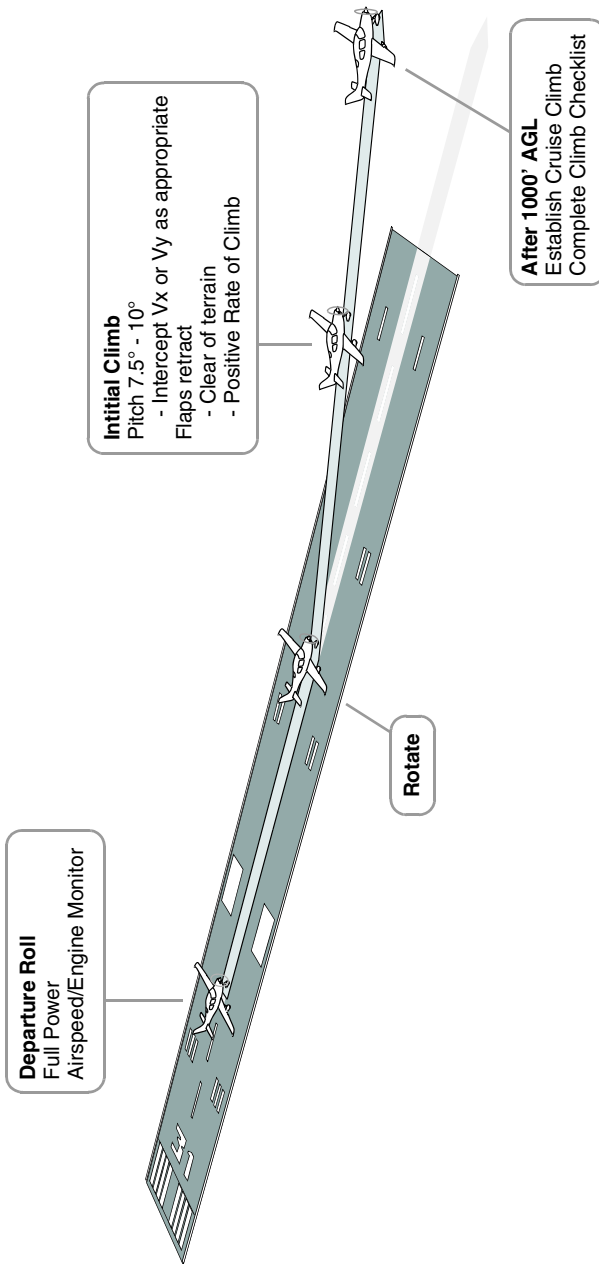

SR22\_OP02\_2662

Figure 3-1  
Take-Off Profile

### Short Field Takeoff

Use the short field technique to maximize takeoff performance and minimize takeoff ground roll. Set Flaps to 50% for a short field takeoff. Align the aircraft on the runway centerline as close as possible to the end of the runway. Apply sufficient brake pressure and smoothly apply full power. Check engine indications and ensure full power before releasing the brakes. Steer with rudder only to minimize the ground roll distance. Rotate the aircraft at  $V_R$  smoothly and pitch for the obstacle clearance speed if an obstacle is present. Pitch for  $V_Y$  after clearing obstacles.

1. Flaps ..... 50%  
*Set flaps to 50% and visually verify both flaps are in position prior to takeoff.*
2. Brakes ..... HOLD  
*Hold brakes firmly, do not allow the aircraft to roll.*
3. Power Lever ..... FULL FORWARD  
*Smoothly increase power lever full forward for maximum takeoff power. Do not confuse throttle detents for a full power setting. Engine speed should be approximately 2700 RPM.*
4. Mixture ..... SET  
*SR20 - Mixture full rich for all altitudes.  
SR22 - Set mixture per the Max Power Fuel placard to obtain maximum engine power for departures above sea level elevation.  
SR22 Turbo - Mixture full rich for all altitudes.*
5. Engine Parameters ..... CHECK  
*Check all engine parameters prior to releasing the brakes. The engine monitoring page should be displayed on the MFD if possible. If any abnormal or questionable indications arise, consider aborting takeoff.*
6. Brakes ..... RELEASE  
*Release the brakes and steer with rudder only. Sufficient rudder control should be available with full power.*

7. Elevator Control ..... ROTATE Smoothly at  $V_R$

*As airspeed approaches  $V_R$ , smoothly and gradually apply back pressure to the control yoke to increase the angle of attack sufficient for rotation.*

$V_R$  (SR20) - 65 KIAS

$V_R$  (SR22) - 70 KIAS

8. Airspeed at Obstacle..... Obstacle Clearance Speed

*Maintain the obstacle clearance speed with flaps at 50% until safely clear all obstacles.*

*SR20 obstacle clearance speed- 75 KIAS*

*SR22 obstacle clearance speed- 78 KIAS*

**Soft Field Takeoff**

Soft or rough field takeoffs are executed using 50% flaps. Add 20% to the takeoff ground roll distance for dry grass runways and 30% for wet grass. Ensure the quality of the runway is adequate to support the aircraft. Avoid runways with long grass, soggy soil and large ruts or holes. Higher power settings will be required to taxi on grass surfaces. Hold full back pressure on the control yoke while taxiing and during the initial takeoff roll to reduce the pressure on the nose wheel. Reduce the backpressure slightly once the nose wheel lifts off the ground. Hold the aircraft in a nose up attitude until the aircraft becomes airborne. Once airborne reduce back pressure as necessary to maintain in ground effect or within 20 feet of the surface. Accelerate the aircraft to  $V_X$  (for obstacles clearance) or  $V_Y$  before climbing out of ground effect.

**Cross Wind Technique**

Partially deflect the ailerons into the wind during a crosswind takeoff. Maintain directional with proper rudder input. Allow the aircraft to accelerate slightly higher than  $V_R$  prior to rotation. Lift the aircraft off the ground slightly quicker than a normal takeoff. Shortly after rotation, crab the aircraft into the wind to track the aircraft along the runway centerline. Maintain coordination during climb out with proper rudder input.



Intentionally Left Blank

## En Route Climb

Complete the Climb checklist as a flow when time and workload permit. Once clear of obstacles and terrain, normal climbs are performed flaps UP (0%) and full power at speeds 5 to 10 knots higher than best rate-of-climb speeds. These higher speeds give the best combination of performance, visibility and engine cooling. When desired and clear of obstacles, transition to cruise climb speed for increased engine cooling, visibility and passenger comfort.

For maximum rate of climb, use the best rate-of-climb speeds shown in the rate-of-climb chart in Section 5 of the POH. If an obstruction dictates the use of a steep climb angle, the best angle of climb speed should be used. Climbs at speeds lower than the best of rate climb speed should be of short duration to avoid engine cooling problems.

### • Caution •

Use caution when engaging the autopilot at low altitude due to the increased workload of programming the autopilot and potential for human errors. Pilots should hand fly the aircraft to a safe altitude and engage the autopilot if desired when time and workload permit. Consider setting the autopilot bugs prior to departure to reduce the amount of workload associated with setting up and engaging the autopilot.

Climb Speeds	SR20 (KIAS)	SR22 (KIAS)
Cruise Climb	95-105	110-120 (SR22 Turbo) 120-130
Best Rate, Sea Level	96	101
Best Rate, 10,000	91	95
Best Angle, Sea Level	81	78
Best Angle, 10,000	85	82

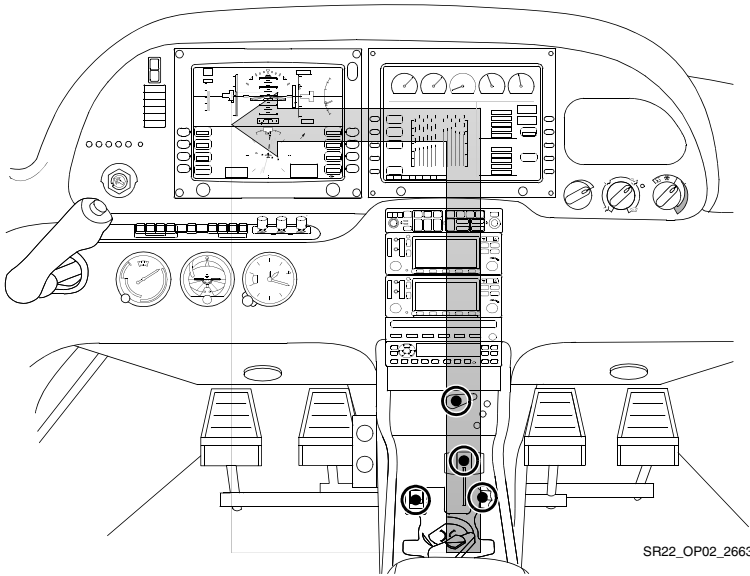

**En Route Climb Flow**

## Procedure (Flow Pattern)

1. Climb Power.....Set  
*Set climb power considering noise abatement procedures. Normal climbs are made with full power.*
2. Flaps ..... Verify UP  
*Verify flaps have been retracted to 0%. If not, verify below  $V_{FE}$  and ensure the following criterion has been met before retracting the flaps:*
  - SR20 - 85 KIAS,
  - SR22 - 80 KIAS,
  - Positive rate of climb,
  - Clear of terrain and obstacles.

3. Mixture ..... As Required
- SR20 - Set the mixture full rich for all altitudes.*
- SR22 - Lean mixture as required for altitude to maintain maximum climb power using the max power fuel flow chart near MFD.*
- SR22 Turbo - Climbs can be made at full power with the mixture set full rich or at an economy cruise climb. Lean the mixture to 17 - 17.6 GPH with the throttle full open to set up an economy cruise climb. Maintain an airspeed of 130 KIAS during an economy cruise climb.*
4. Engine Parameters ..... CHECK
- Check all engine parameters for any abnormal indications that may indicate impending engine problems.*
5. Fuel Pump (SR20/SR22) ..... OFF
- Select fuel pump OFF above 1000' AGL unless the takeoff was made with warm or hot fuel.*
- Fuel Pump (SR22 Turbo) ..... LOW BOOST
- Select LOW BOOST 30 minutes into cruise flight to reduce the likelihood of vapor lock, which may be due to a combination of warm fuel and high altitude. If vapor lock is suspected at altitudes above FL180 set the fuel pump to HIGH BOOST/PRIME until the warm fuel has time to cool.*
- Fuel boost should be left on during takeoff and for climb as required for vapor suppression with hot or warm fuel.*

## Avionics Configuration

- Autopilot - Set modes as desired past 400 AGL,
- MFD - Complete Climb Checklist, monitor Map for situational awareness,
- PFD - Monitor aircraft flight parameters and system status.

Intentionally Left Blank

## Cruise

Complete the Cruise checklist as a flow when time and workload permit. Allow the aircraft to accelerate to cruise speeds before setting the desired cruise power setting. Ensure adequate fuel reserves remain for the intended destination. Normal cruise power settings are between 65% - 85% power with mixture setting for best power or best economy.

For engine break-in, cruise at a minimum of 75% power until the engine has been operated for at least 25 hours or until oil consumption stabilizes. Operation at higher power will ensure proper seating of the rings, is applicable to new engines, and engines in service following cylinder replacement or top overhaul of one or more cylinders.

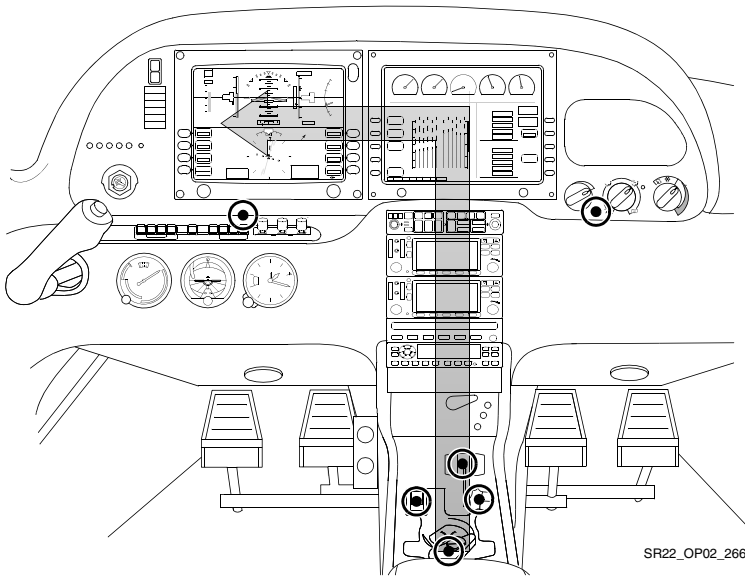

SR22\_OP02\_2664

### Cruise Flow

## Procedure (Flow Pattern)

1. Fuel Pump ..... OFF  
*The Fuel Pump may be used for vapor suppression in cruise. Vapor lock issues may be recognized by fluctuating EGT's, CHT's and fuel flows. Rough engine operation may also be experienced.*
2. Cruise Power..... SET  
*SR20/SR22 - Allow the aircraft to accelerate to cruise speeds before setting cruise power. Select the desired percent power considering range, endurance and desired performance for the intended flight. Reference the MFD Engine page and adjust the throttle to set the desired percent power.*  
*SR22 Turbo - Allow the aircraft to accelerate to cruise speeds before setting cruise power. Start setting cruise power by reducing the throttle to 2500 RPM with maximum manifold pressure.*
3. Mixture ..... LEAN as Required  
*SR20/SR22 - Use the Lean Assist feature on the MFD Engine page to set the mixture control for Best Power or Best Economy.*  
*SR22 Turbo - Set the fuel flow to 17-17.6 GPH by adjusting the mixture control after setting the throttle to 2500 RPM with maximum manifold pressure. The above conditions will set approximately 85% power. If a lower power setting is desired to increase range/endurance reduce the throttle to the desired percent power.*
4. Engine Parameters ..... MONITOR  
*Fuel BOOST must be used for switching from one tank to another. Failure to activate the Fuel Pump before transfer could result in delayed restart if the engine should quit due to fuel starvation.*
5. Fuel Flow and Balance ..... MONITOR  
*Check fuel flow gauge and ensure fuel balance is within 7.5 gallons (SR20), 10 gallons (SR22).*

## Avionics Configuration

- Autopilot - Ensure correct modes are engaged if desired,
- GPS 2 - Monitor for traffic. GPS 1 - Verify correct navigation information is set,
- MFD - Use Lean Assist to lean the mixture. Complete the Cruise Checklist,
- PFD - Monitor aircraft flight parameters and system status.



Intentionally Left Blank

## Descent

Descents should be planned during cruise considering the amount of altitude to lose, distance and time to destination, ATC restrictions, obstacle/terrain clearance, desired rate of descent, and engine care. Use the vertical navigation function of the GPS to assist descent planning. To manage workload, complete the descent checklist at the top of descent or at least 20 minutes from the destination. Set appropriate frequencies and review weather to determine the active runway. Verify GPS units are programed as desired for the arrival and approach into the airport.

Power should be used during descent to manage airspeed and maintain engine temperatures as desired. Maintain airspeed within the green arc if turbulence is expected or encountered during the descent. Use caution and avoid excessive maneuvering when airspeed is within the yellow arc during the descent. Complete the Descent checklist as a flow when time and workload permit upon initial descent to land. Reference the checklist to verify all items are complete once the flow has been completed.

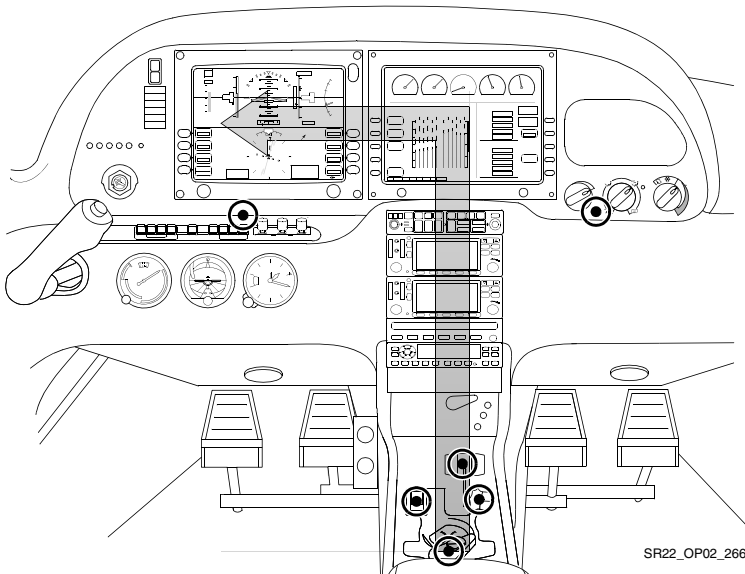

**Descent Flow**

## Procedure (Flow Pattern)

1. Altimeter..... SET  
*Verify the proper altimeter setting has been set into the PFD and in the standby altimeter.*
2. Cabin Heat/Defrost ..... AS REQUIRED
3. Landing Light .....ON  
*The landing light should be selected on for visibility to others at the top of the descent or within 10NM from the destination. If in IMC, consider leaving off to reduce light reflection in the cabin.*
4. Fuel System..... CHECK  
*Ensure fuel is balanced and selected to the fullest tank.*
5. Mixture ..... AS REQUIRED  
*SR20/SR22 - Consider altitude when setting mixture for descent. Full mixture settings at high altitudes may lead to engine roughness or flooding resulting in engine loss.*  
*SR22 Turbo - it is not necessary to adjust the mixture during the descent.*
6. Brake Pressure ..... CHECK  
*Apply pressure to each toe brake and ensure resistance is felt. Be sensitive for soft or mushy feeling in brakes as this could indicate a brake failure.*

## Avionics Configuration

- Autopilot - Set modes on autopilot for descent as desired,
- GPS 1 - Verify correct navigation information is set,
- MFD - Complete Descent Checklist, monitor Map for situational awareness,
- PFD - Set Altitude and VSI bugs for the descent. Monitor aircraft flight parameters and system status.

## Before Landing / Traffic Pattern

Complete the Before Landing checklist as a flow prior to entering the traffic pattern when time and workload permit. Slow the aircraft early enough to allow for an easy transition into the traffic flow and enough time to ensure the aircraft is configured for landing. The following profile describes a normal traffic pattern. Pilots should use this profile as a guide when entering the traffic pattern on the downwind leg and modify as appropriate for base entry or straight in approaches.

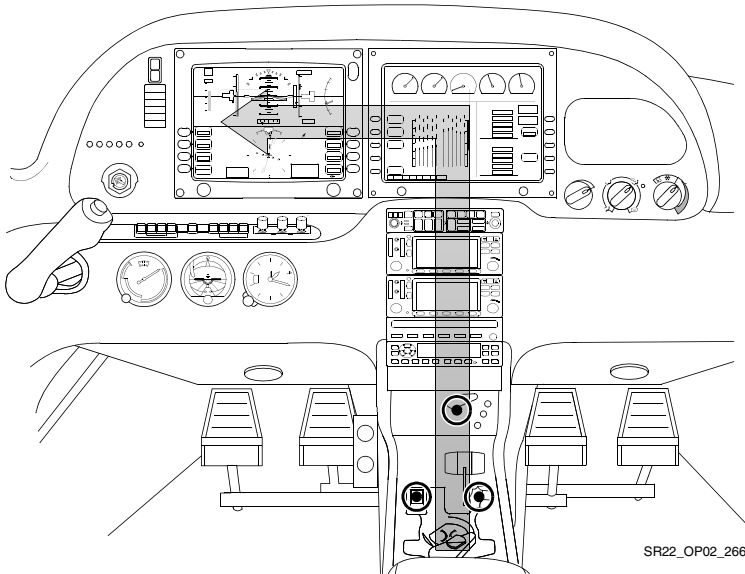

**Before Landing / Traffic Pattern Flow**

## Procedure (Flow Pattern)

1. Seat Belt and Shoulder Harness .....Secure  
*Ensure the seat belt and shoulder harness is secure for all occupants in the aircraft.*
2. Fuel Pump ..... BOOST
3. Mixture ..... AS REQUIRED  
*SR20 - Mixture full rich for all altitudes.  
SR22 - Mixture as required for altitude. Reference the max power fuel flow placard for mixture setting. Avoid rich mixture settings at high elevations.  
SR22 Turbo - Mixture full rich for all altitudes.*
4. Flaps ..... AS REQUIRED  
*Reference the Traffic Pattern Profile or Approach Profile for information on the appropriate use of flaps*
5. Autopilot ..... AS REQUIRED  
*It is recommended to disconnect the autopilot prior to entering the traffic pattern*

## Avionics Configuration

- Autopilot - Disengage the autopilot prior to entering the traffic pattern,
- MFD - Complete the Before Landing Checklist, monitor Map for situational awareness.

	SR20	SR22	SR22 Turbo
Downwind	50% / 20" MP	30% / 15" MP	50% / 15" MP
Abeam/Base	25% / 12" MP	15% / 12" MP	25% / 12" MP
Final	As Required	As Required	As Required

SR22\_OPO2\_2686

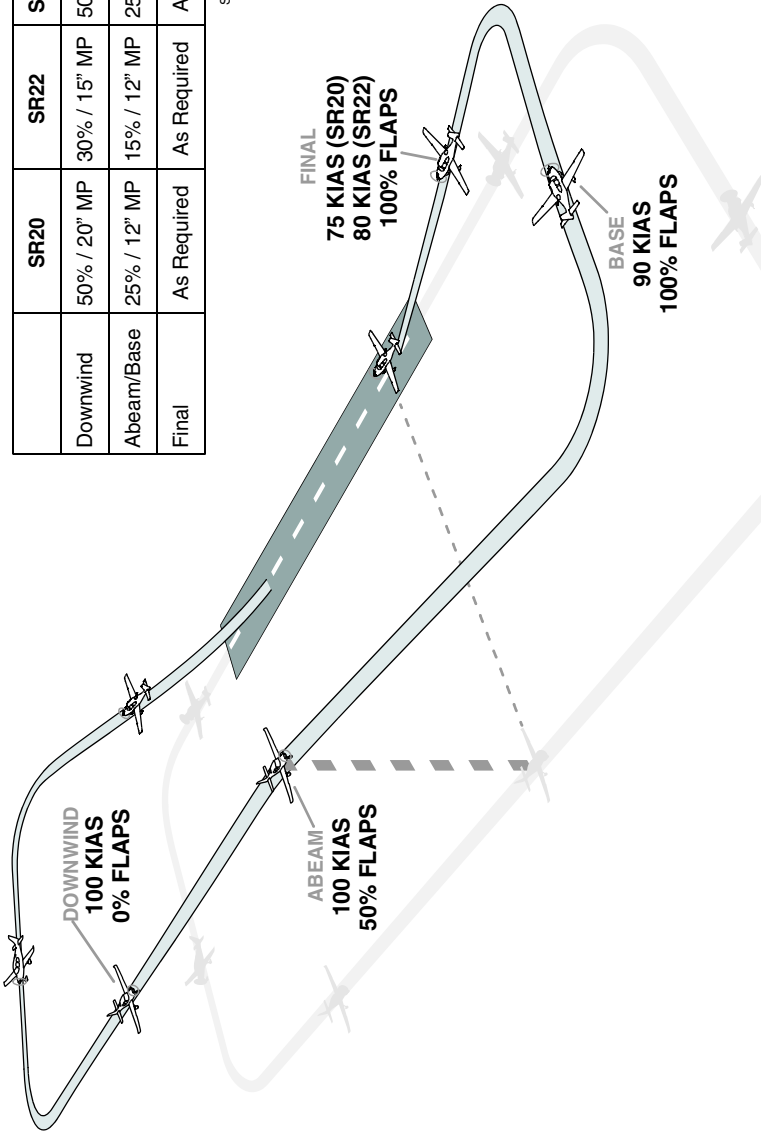

Figure 3-2  
Traffic Pattern Profile

Intentionally Left Blank

## Approach

The following Instrument Approach Procedures outline the operating procedures for executing precision, non precision, and GPS approaches. The information describes the best way to configure the aircraft for given instrument procedures, complete checklist items, and configure avionics in Cirrus aircraft. The purpose of this section is to supplement the information in the POH and provide greater guidance on the completion of various instrument procedures in the aircraft. The techniques outlined in this section may not be inclusive of all variables encountered in the national airspace system. Pilots should follow these standard procedures when applicable and exercise good judgment for non standard procedures.

To reduce workload during the descent and instrument approach procedure follow these recommendations.

- Obtain destination weather information as soon as possible to determine active runways and applicable approaches,
- Set up applicable COM and NAV frequencies prior to descent,
- Use the autopilot while briefing and preparing for the approach,
- Reduce unnecessary communications and distractions during the approach,
- Use the Descent and Before Landing flows outlined in this manual to complete checklist and avionics set up procedures, Always reference the checklist after the flow is complete,
- Brief the approach using the guidelines listed in this section.

### Stabilized Approach Criteria

A stabilized approach is critical to a safe, successful landing. A stabilized approach is characterized by a constant angle, constant rate of descent approach profile ending near the touchdown point. Stabilized approach criteria apply to all approaches including practice power off approaches.



### ***VFR Stabilized Approach Definition***

All briefings and appropriate checklists should be completed by 500' AGL in visual conditions.

A VFR approach is considered stabilized when all of the following criteria are achieved by 500' AGL:

- Proper airspeed,
- Correct flight path,
- Correct aircraft configuration for phase of flight,
- Appropriate power setting for aircraft configuration,
- Normal angle and rate of descent,
- Only minor corrections are required to correct deviations.

A go around must be executed if the above conditions are not met and the aircraft is not stabilized by 500' AGL.

### ***IFR Stabilized Approach Definition***

All briefings and appropriate checklists should be completed by 1000' AGL for instrument conditions.

An IFR Approach is considered stabilized when all of the following criteria are met from 1000' AGL and continues to touchdown:

- Proper airspeed,
- Correct flight path,
- Correct aircraft configuration for phase of flight,
- Appropriate power setting for aircraft configuration,
- Normal angle and rate of descent,
- Only minor corrections with pitch and power are required to correct airspeed and glide path deviations,
- Normal bracketing (+/- 5°) is used to correct for lateral navigation deviations.

Do not change flap configuration after crossing the FAF until the runway is in sight and landing is assured.

A missed approach must be executed if the above conditions are not maintained during an instrument approach.

## Procedures

Emphasis should be place on maintaining stability during the entire approach.

### ***Approach Briefing***

The purpose of an approach briefing is to prepare the pilot to execute an instrument approach procedure. Pilots should brief the instrument approach procedure when time and workload permits. Preferably, the approach should be briefed approximately 20 minutes prior to the IAF or start of vectors. The approach briefing should include the following items:

- Type of procedure and runway (e.g. ILS 35L),
- Transition to final (vectors or IAF),
- Applicable Nav and Com frequencies,
- DA/MDA,
- MAP and missed approach procedure.

### ***Sample Approach Briefing***

This will be a \_\_\_\_\_ (ILS, GPS...) approach to RWY\_\_\_\_\_ via the \_\_\_\_\_ transition (VTF or IAF). The proper navigation source (GPS, VLOC) for the approach is selected and the proper course is set in the HSI. Applicable approach frequencies are tuned and identified. Final approach speed is \_\_\_\_\_ KIAS with approach flaps (50%) set prior to the FAF. Call out 1000 feet, 500 feet and 100 feet above minimums. The minimum altitude for the approach is \_\_\_\_\_ feet. The missed approach procedure is climb to \_\_\_\_\_ altitude and turn left/right to the \_\_\_\_\_ fix and hold.

**Procedure - Precision Approach (See Figure 3-3)**

The following provides guidance for executing a precision approach using vectors to final or full procedure as the transition. The precision approach profile may be used for ILS, LPV, and LNAV/VNAV approaches or any approach that has lateral and vertical course guidance.

**Avionics Configuration**

Autopilot - If desired:

Approach Segment	Lateral Mode	Vertical Mode
Vector to final	HDG	As required
Cleared to IAF	GPSS	As required
Procedure turn outbound / course reversal	GPSS <sup>a</sup> and/or HDG	As required
Inbound to FAF	NAV APR	ALT
FAF inbound	NAV APR	GS
Missed approach	NA	NA

a. WAAS equipped aircraft may use the NAV GPSS mode to execute procedure turns or course reversals.

**GPS**

- Load the approach with the assigned transition (VTF or IAF),
- Verify all Flight Plan waypoints are correct including course reversals,
- Activate the approach at the start of vectors or when cleared direct to the IAF,
- Verify all approach frequencies are tuned and identified,
- Verify the navigation mode switches from GPS to VLOC on an ILS approach when inbound to FAF.

**MFD**

- Reference CMax for approach information and briefing,
- Reference the electronic checklist at the completion of the Descent and Before Landing flows.

**PFD**

- Set the Altitude bug for the DA once established inbound to FAF,
- Set the HDG bug for the wind correction heading once established inbound on the final approach course.

Approximate Power Settings	SR20	SR22	SR22 Turbo
Start of Vectors / Cleared to IAF	As required	As required	As required
Final Intercept	As required	As required	As required
1/2 Scale Below Glideslope	50% / 22" MP	30% / 15" MP	50% / 15" MP
FAF Inbound	25% / 12" MP	15% / 12" MP	25% / 12" MP
Missed Approach	Full Power	Full Power	Full Power

**Precision Approach Briefing Elements**

- Type of procedure and runway (e.g. ILS 31),
  - Transition to final (VTF or IAF),
  - Applicable Nav and Com frequencies,
  - DA/MDA,
  - MAP and missed approach procedure.
- Note •
- Set ALT bug to the DA prior to FAF,
  - Sync the HDG bug once established inbound, on the final approach course,
  - Execute a missed approach anytime the stabilized approach criteria outlined are not met.

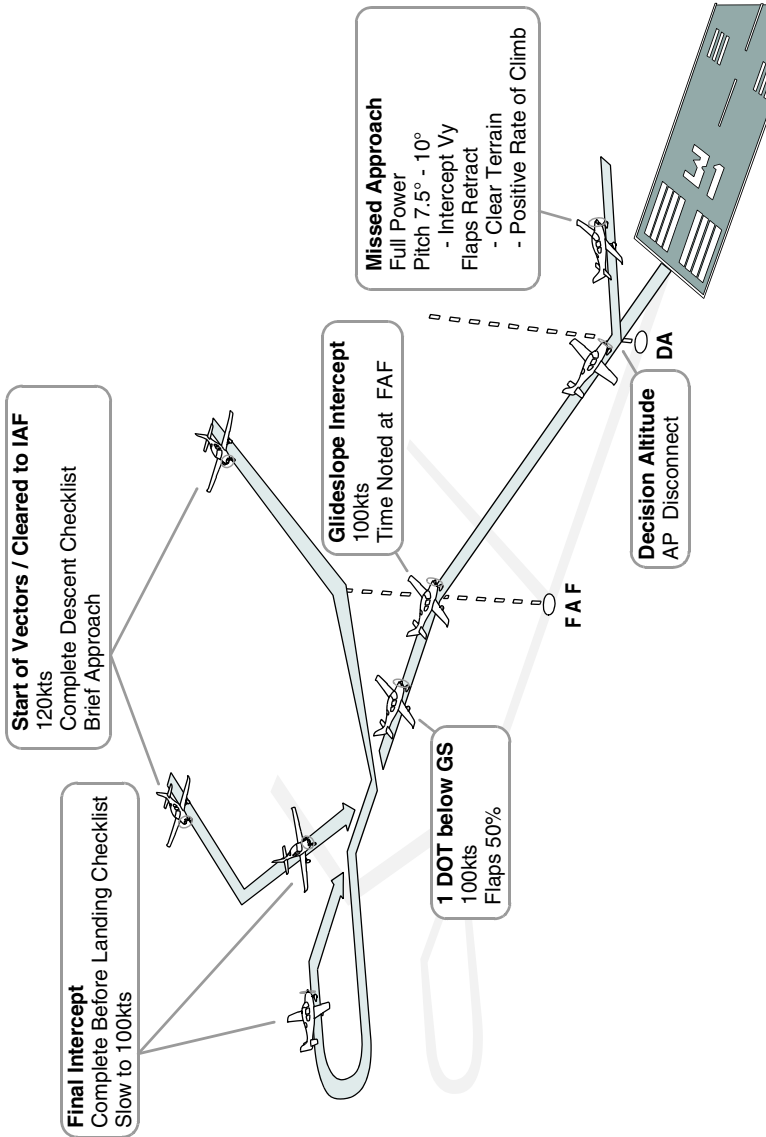

Figure 3-3  
Precision Approach Profile

Intentionally Left Blank

**Non Precision Approach Procedure (See Figure 3-4)**

The following provides guidance for executing a non precision approach using vectors to final or full procedure as the transition. The non precision profile may be used for VOR and GPS overlay approaches or any approach that has only lateral course guidance.

**Avionics Configuration**

Autopilot - If desired:

Approach Segment	Lateral Mode	Vertical Mode
Vector to final	HDG	As required
Cleared to IAF	GPSS	As required
Procedure turn outbound / course reversal	GPSS <sup>a</sup> and/or HDG	As required
Inbound to FAF	GPSS (GPS) NAV/APR (VOR/LOC)	ALT
FAF inbound	GPSS (GPS) NAV APR (VOR/LOC)	VS + ALT
Missed approach	NA	NA

a. WAAS equipped aircraft may use NAV GPSS mode to execute procedure turns or course reversals.

**GPS**

- Load the approach with the assigned transition (VTF or IAF),
- Verify all Flight Plan waypoints are correct including course reversals,
- Activate the approach at the start of vectors or when cleared direct to the IAF,
- Verify all approach frequencies are tuned and identified,
- Verify the navigation mode is set as required (GPS or VLOC).

**MFD**

- Reference CMax for approach information and briefing,
- Reference the electronic checklist at the completion of the Descent and Before Landing flows.

**PFD**

- Set Altitude bug for the MDA once established inbound to FAF,
- Set the HDG bug for the wind correction heading once established inbound on the final approach course.

Approximate Power Settings	SR20	SR22	SR22 Turbo
Start of Vectors / Cleared to IAF	As required	As required	As required
Final Intercept	As required	As required	As required
2 NM to FAF	50% / 22" MP	30% / 15" MP	50% / 15" MP
FAF Inbound	25% / 12" MP	15% / 12" MP	25% / 12" MP
Missed Approach	Full Power	Full Power	Full Power

**Non Precision Approach Briefing Elements**

- Type of procedure and runway (e.g. LOC 31),
  - Transition to final (VTF or IAF),
  - Applicable Nav and Com frequencies,
  - DA/MDA,
  - MAP and missed approach procedure.
- Note •
  - Set ALT bug to the MDA prior to FAF,
  - Sync the HDG bug once established inbound,
  - Execute a missed approach anytime the stabilized approach criteria outlined are not met.



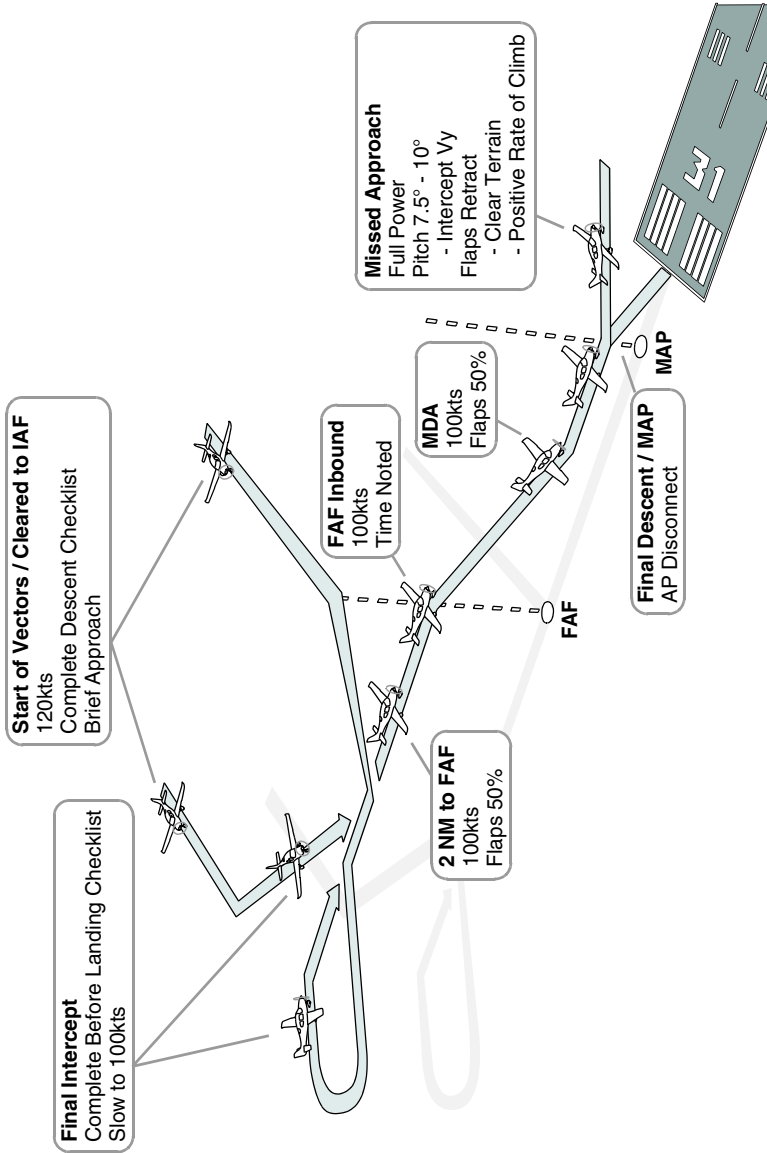

Figure 3-4  
Non Precision Approach Profile

Intentionally Left Blank

**GPS Approach Procedures (See Figure 3-5)**

The following provides guidance for executing a classic GPS approach using vectors to final or full procedure as the transition. Use this profile for executing a partial panel approach in the event of a PFD failure.

**Avionics Configuration**

Autopilot (if desired):

Approach Segment	Lateral Mode	Vertical Mode
Vector to final	HDG	As required
Cleared to IAF	GPSS	As required
Procedure turn outbound / course reversal	GPSS <sup>a</sup> and/or HDG	As required
Inbound to FAF	GPSS (GPS)	ALT
FAF inbound	GPSS (GPS)	VS + ALT <sup>b</sup>
Missed approach	NA	NA

a. WAAS equipped aircraft may use NAV GPSS mode to execute procedure turns or course reversals.

b. Altitude preselect may not be available in the event of a PFD failure. For complete PFD failures, pull both PFD circuit breakers to gain the use of vertical speed control on the autopilot. During partial panel operations use vertical speed control for climbs and descents and ALT hold to maintain altitude

**GPS**

- Load the approach with the assigned transition (VTF or IAF), Always select an IAF for partial panel approaches,
- Verify all waypoints are correct including course reversals,
- Activate the approach at the start of vectors or when cleared direct to the IAF,
- Verify all approach frequencies are tuned and identified,
- Verify the navigation mode is set as required (GPS or VLOC).

**MFD**

- Reference CMax for approach information and briefing,
- Reference the electronic checklist at the completion of the Descent and Before Landing checklist flows.

**PFD**

- Set Altitude bug for the MDA once established inbound to FAF,
- Set the HDG bug for the wind correction heading once established inbound on the final approach course.

Approximate Power Settings	SR20	SR22	SR22 Turbo
Start of Vectors / Cleared to IAF	As required	As required	As required
Final Intercept	As required	As required	As required
2 NM to FAF	50% / 22" MP	30% / 15" MP	50% / 15" MP
FAF Inbound	25% / 12" MP	15% / 12" MP	25% / 12" MP
Missed Approach	Full Power	Full Power	Full Power

**GPS Approach Briefing Elements**

- Type of procedure and runway (e.g. LOC 31),
- Transition to final (VTF or IAF),
- Applicable Nav and Com frequencies,
- DA/MDA,
- MAP and missed approach procedure.
- Note •
- Set ALT bug to the MDA prior to FAF,
- Sync the HDG bug once established inbound,
- Execute a missed approach anytime the stabilized approach criteria outlined are not met.

**• Caution •**

Proceed to VFR conditions in the unlikely event of a PFD failure. Execute an autopilot coupled approach if VFR conditions are not available. Start the approach at an IAF that does not require a procedure turn or course reversal.

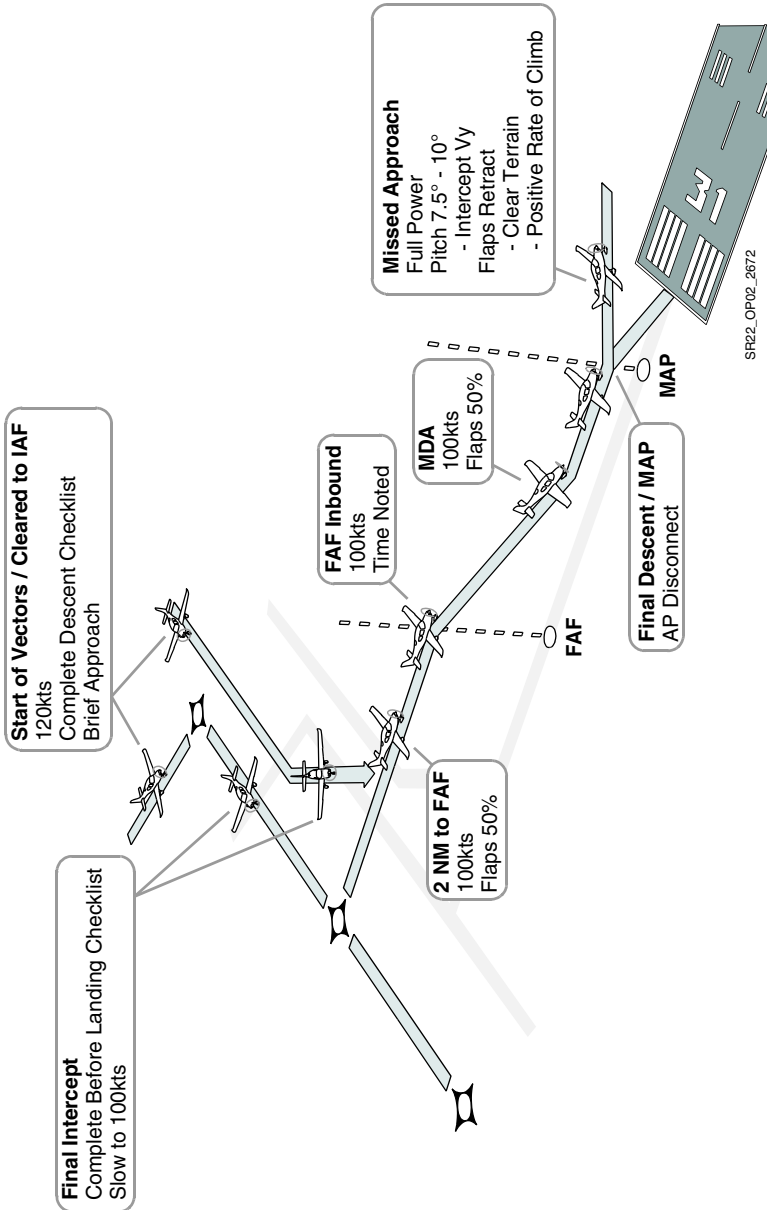

Figure 3-5  
GPS Approach Profile

## Go-Around

A go around should be executed anytime an approach does not meet the stabilized approach criteria outlined in this manual for instrument or visual conditions. A go around should be completed from memory since it is a time critical maneuver.

In addition to the stabilized approach criteria, execute a go around/missed approach for these conditions:

- Excessive ballooning during round out or flare,
- Excessive bouncing or porpoising,
- Landing beyond 1st third of the runway,
- Any condition when a safe landing is in question.

The first priority of executing a go around is to stop the aircraft's descent. Smoothly and promptly apply full power while simultaneously leveling the wings and pitching the aircraft to stop the descent. Maintain coordination while adding power by applying rudder pressure. Retract the flaps to 50%. Do not fully retract the flaps at this point in the go around because it may lead to excessive altitude loss.

Begin pitching for a climb attitude once the aircraft's descent rate has been stopped. Pitch for  $V_X$  if obstacle clearance is an issue. Pitch for  $V_Y$  for all other situations. Retract flaps to 0% once the aircraft is climbing, and clear of obstacles, and at 80kts (SR20), 85kts (SR22)

## Procedure (Memory)

1. Autopilot..... DISENGAGE  
*Disengage the Autopilot by depressing the AP DISC on the control yoke.*
2. Power Lever ..... FULL FORWARD  
*Increase power lever to the full forward position. Ensure full power is used and do not stop at any detents along power lever travel.*
3. Flaps ..... 50%  
*Select flaps to 50% to decrease drag and maintain maximum lift as a climb is initiated.*
4. Airspeed..... SEE BELOW  
*SR20 - 81 to 83 KIAS  
SR22 - 75 to 80 KIAS*
5. Flaps ..... UP  
*Verify flaps have been retracted to 0%. If not, ensure the following criteria is met before retracting the flaps:  
SR20 - 85 KIAS  
SR22 - 80 KIAS  
Positive rate of climb  
Clear of terrain and obstacles*

## Landing

Approach Speeds	SR20	SR22
100% Flaps	75 KIAS	80 KIAS
50% Flaps	80 KIAS	85 KIAS
0% Flaps	85 KIAS	90 KIAS
Short Field (100% Flaps)	75 KIAS	77 KIAS
Max Demonstrated Crosswind	21 KIAS	20 KIAS

### ***Normal Landing***

Normal landings should be made with 100% flaps. Final approach speeds should be adjusted to account for gusts exceeding 10 KTS by adding half of the gust factor. Reduce power smoothly and begin slowing from the final approach speed at a time that allows an easy transition from final descent to round out and flare with minimum floating or ballooning. Touch downs should be made on the main wheels first at speeds slightly above stall. Gently lower the nose wheel after the mains are on the ground.

### ***Short Field Landing***

Landings on short runways should be made with 100% flaps. Final approach speeds should be adjusted to account for wind gusts exceeding 10 KTS by adding half the gust factor. Progressively reduce power after clearing all approach obstacles. Proper airspeed and power control should result in an approach with minimal floating in ground effect and excessive sink rates during the approach. Touchdown should be made on the main wheels first. Immediately after touchdown, ensure power idle, lower the nose wheel and brake as required. To decrease stopping distances considers retracting the flaps and holding the control yoke full aft. Emphasis should be placed on the accuracy of the touchdown to ensure enough runway remains after touchdown to stop the aircraft.



### ***Soft Field Landing***

Cirrus aircraft are approved for landings on soft field or turf runways. Add 20% to the landing ground roll distance when landing on a dry grass runway and 60% when landing on a wet grass runway. Always ensure that the quality and condition of the runway surface is adequate to support the aircraft. Avoid turf runways with long grass, wet or soggy soil, large ruts or holes. A soft field approach is similar to and normal landing approach. Touchdowns should be made on the main wheels first. A soft touchdown will reduce the stress on the landing gear and make it easier to keep the nose wheel from digging into the turf and possible loss of directional control. Keep the nose wheel off the ground as long as possible by applying sufficient back pressure to the control yoke. A little power can be added immediately after touchdown to aid in keeping the nose wheel off the ground. Braking should be minimized. Excessive braking could lead to a loss of directional control on the runway. Higher power settings will be required to taxi on a soft field.

### ***Crosswind Landing***

Crosswind landings should be made with 100% flaps. It is recommended to crab the aircraft into the wind sufficient to track the aircraft along the extended centerline of the runway. Hold the crab until the beginning of the round out. At the start of the round out, enter a slip by applying rudder pressure to align the longitudinal axis of the aircraft with the runway and simultaneously apply aileron to keep the aircraft tracking the runway centerline. Touchdowns should be made on the upwind main landing gear first followed by the downwind main landing gear and nose gear. Hold aileron correction into the wind during the rollout and apply rudder as necessary to maintain directional control.

## After Landing

Complete the After Landing checklist as a flow after clearing the active runway. Ensure the pitot heat is turned off. The mixture can be leaned if desired. Set the mixture by leaning for max RPM rise.

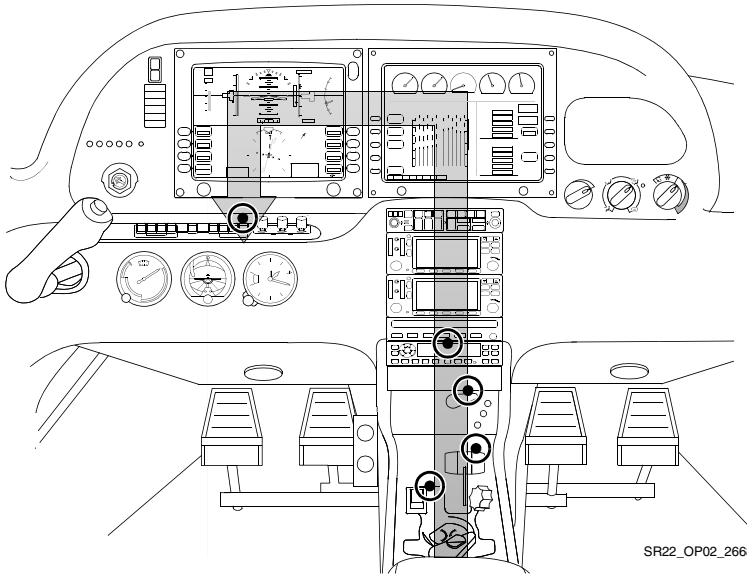

SR22\_OP02\_2668

### After Landing Flow

## Procedure (Flow Pattern)

1. Power Lever ..... 1000 RPM  
*Reduce power to 1000 RPM during taxi. Changes in engine speed should be used to accelerate or decelerate the aircraft along with minimal braking as necessary.*
2. Fuel Pump ..... OFF  
*Select Fuel Pump OFF after clearing runway.*
3. Flaps ..... UP  
*Select flaps to 0% (UP) after clearing runway.*
4. Transponder ..... STBY  
*Ensure transponder has automatically cycled to STBY. If not, select STBY manually.*
5. Lights ..... AS REQUIRED  
*Reduce external lighting once clearing the runway to the minimum required for safe/legal operation so as to avoid creating a hazard to others.*
6. Pitot Heat ..... OFF  
*Select Pitot Heat OFF to avoid overheating heating element.*

## Arrival/Engine Shutdown

Complete the shutdown checklist as a flow pattern. Verify with the checklist to ensure all items have been accomplished when completed with the flow. The avionics switch may be left on during engine shutdown. Notify maintenance personal immediately and do not move the propeller if a hot magneto is found during the shutdown process.

The aircraft should be parked on a ramp or in a hangar. If the aircraft is parked outside, it should be chocked and tied down if possible.

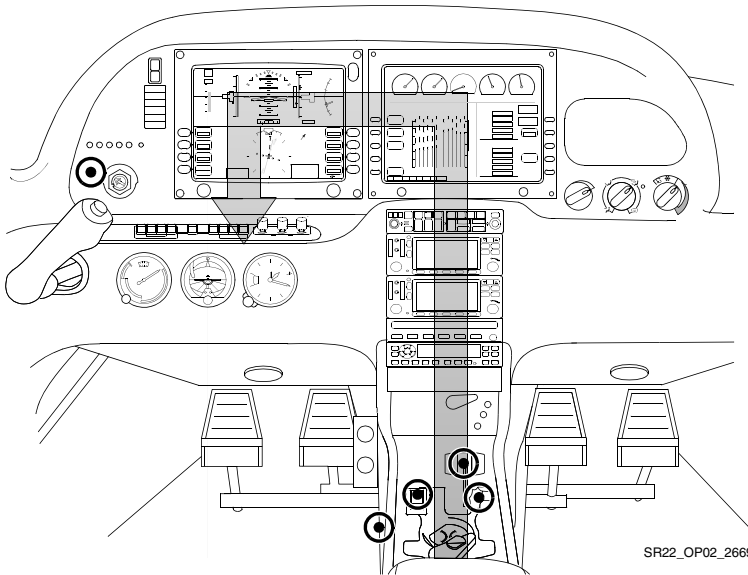

SR22\_OP02\_2669

**Arrival/Engine Shutdown Flow**

## Procedure (Flow Pattern)

1. Fuel Pump (if used) ..... OFF
2. Throttle..... IDLE
3. Ignition Switch..... CYCLE

### • Caution •

Note that the engine hesitates as the switch cycles through the OFF position. If the engine does not hesitate, one or both magnetos are not grounded. Prominently mark the propeller as being HOT, and contact maintenance personnel immediately.

4. Mixture .....CUTOFF  
*Reduce mixture control to the full CUTOFF position and ensure engine stops running. If the engine continues to run with the mixture at idle, ensure the boost pump is in the off position.*
5. All Switches ..... OFF  
*Turn off all remaining switches including the AC and fan if equipped.*
6. Magnetos ..... OFF  
*Turn off magnetos and remove key.*
7. ELT ..... TRANSMIT LIGHT OUT  
*After a hard landing, the ELT may be activated. If this is suspected, press the RESET button located below the CB panel near the floor by the pilot's right ankle.*
8. Chocks, Tie-downs, Pitot Cover ..... AS REQUIRED  
*Set parking brake if required, chock both main wheels, use tie downs under wings and tail if necessary. Place pitot cover and static covers if needed.*

Intentionally Left Blank

# Section 4 - Maneuvers

## General

The following maneuvers should be complete with a minimum recovery altitude of 1500' AGL. Follow these guidelines for set up and execution of the following maneuvers.

## Steep turns

Enter this maneuver at 120 KTS by smoothly banking the aircraft to 45° (Private) / 50° (Commercial) and simultaneously adding back pressure to maintain altitude. Maintain coordination with rudder. Additional power may be necessary to maintain airspeed. Continue the turn for 360 degrees. Start the roll out approximately 10 degrees before completing the full turn and simultaneously releasing backpressure. Reduce any power that was added during the maneuver.

## Execution

- Execute clearing turns,
- Airspeed 120 KIAS,
  - > SR20 - 60% Power / 21" MP (approximately),
  - > SR22 - 30% Power / 18" MP (approximately),
  - > SR22 Turbo - 50% Power / 18" MP (approximately).
- Bank Angle 45° (Private) or 50° (Commercial).

## Maneuvering during Slow Flight

Practice this maneuver with a variety of flap configurations while climbing, descending and turning. Enter the maneuver in level flight and smoothly reduce power. Maintain altitude while the aircraft slows to the desired airspeed and trim the aircraft. Add flaps as desired at  $V_{FE}$ . Add power as necessary to maintain the desired altitude. Maintain coordination throughout the maneuver with rudder control. Recover from this maneuver if a stall is encountered.

### Execution

- Execute clearing turns,
- Reduce power,
  - > SR20 - 20% Power / 15" MP (approximately),
  - > SR22 - 15% Power / 12" MP (approximately),
  - > SR22 Turbo - 25% Power / 12" MP (approximately).
- Flaps as desired (0% - 100%),
- Bank angle as desired (20° maximum),
- Airspeed - an airspeed at which any further increase in angle of attack, increase in load factor, or reduction in power would result in an immediate stall (current PTS standards).

### Recovery

- Reduce angle of attack and level wings,
- Apply full power,
- Flaps 50%,
- Accelerate to  $V_Y$ ,
- Flaps 0%,
  - > SR20 - 85 KTS,
  - > SR22 - 80 KTS.
- Clear of terrain and obstacles,
- Positive rate of climb.



## Power off Stalls

Practice this maneuver with varying flap configurations. Enter this maneuver from a level attitude by reducing the power and adding flaps as desired at  $V_{FE}$ . At 80 KTS establish a descent of approximately 500fpm, straight or turning. Once a stabilized descent is established, reduce power to idle and gradually increase pitch to a normal touchdown attitude ( $7.5^\circ$  approximately). Adjust pitch to reduce airspeed approximately 1 KTS / second. Recovery can be initiated at the incipient phase or full stall.

### Execution

- Execute clearing turns,
- Flaps as desired (0% - 100%),
- Establish glide or gliding turn,
  - > SR20 - 20% Power / 15" MP (approximately),
  - > SR22 - 15% Power / 12" MP (approximately),
  - > SR22 Turbo - 25% Power / 12" MP (approximately).
- Descent rate 500 fpm (approximately),
- $20^\circ$  max bank angle,
- Reduce throttle to idle and increase pitch to a normal landing attitude ( $5^\circ$  to  $7.5^\circ$ ) and induce a stall.

### Recovery

- Reduce angle of attack and level wings,
- Apply full power,
- Flaps 50%,
- Accelerate to  $V_Y$ ,
- Flaps 0%,
  - > SR20 - 85 KTS,
  - > SR22 - 80 KTS.
    - Clear of terrain and obstacles,
    - Positive rate of climb.

## Power on Stalls

Practice this maneuver with 0% and/or 50% flaps, straight and turning. Enter the maneuver from level flight by reducing power and adding flaps as desired at  $V_{FE}$ . Slow the aircraft to  $V_R$  while maintaining altitude. At  $V_R$  smoothly apply a minimum of 65% power and pitch the aircraft at an angle to induce a stall. Apply rudder to maintain coordination. Recover from this maneuver at the incipient phase or full stall.

### Execution

- Execute clearing turns,
- Flaps 0% or 50% as desired,
- Airspeed- slow to  $V_R$ ,
  - > SR20 - 20% Power / 15" MP (approximately),
  - > SR22 - 15% Power / 12" MP (approximately),
  - > SR22 Turbo - 25% Power / 12" MP (approximately).
- Bank angle as desired (20° maximum),
- Apply minimum 65% power,
- Increase pitch angle to induce stall (Maximum 25° pitch attitude).

### Recovery

- Reduce angle of attack and level wings,
- Verify full power,
- Accelerate to  $V_Y$ ,
- Flaps 0%,
  - > SR20- 85 KTS,
  - > SR22- 80 KTS.
- Clear of terrain and obstacles,
- Positive rate of climb.

## Autopilot Stall Recognition

The purpose of this maneuver is to identify the conditions when a stall with the autopilot engaged may occur, recognize the affects of an impending autopilot stall and learn the recovery procedure. Do not exceed any autopilot limitations during this maneuver. The maneuver is started by programming the autopilot for conditions it is not capable of maintaining (excessive climb rate, insufficient power...) This maneuver will not be executed to a full stall condition. Recovery will be initiated at by disconnecting the autopilot and following the stall recovery procedure.

### AP Stall Recognition (Power Off)

#### *Execution*

- Execute clearing turns,
- Flaps 50%,
- Engage HDG and ALT modes on the autopilot,
  - > SR20 - 20% Power / 15" MP (approximately),
  - > SR22 - 15% Power / 12" MP (approximately),
  - > SR22 Turbo - 25% Power / 12" MP (approximately).

• Note •

Autopilot will increase the angle of attack to maintain altitude sacrificing airspeed. Recovery will be performed at a speed no lower than  $1.2 V_S$ , as per the S-Tec autopilot limitation.

#### *Recovery*

- Disconnect autopilot,
- Reduce angle of attack and level wings,
- Apply full power,
- Accelerate to  $V_Y$
- Flaps 0%,
  - > SR20- 85 KTS,
  - > SR22- 80 KTS.
- Clear of terrain and obstacles,
- Positive rate of climb.

## Autopilot Stall Recognition (Cont)

### AP Stall Recognition (Power On)

#### *Execution*

- Execute clearing turns,
  - > SR20 - 25% Power / 11" MP (approximately),
  - > SR22 - 15% Power / 12" MP (approximately),
  - > SR22 Turbo - 25% Power / 12" MP (approximately).
- Flaps 0%,
- Engage HDG and VS with a 1600 FPM climb,
- Apply minimum 65% power.

• Note •

Autopilot will increase the angle of attack to increase altitude sacrificing airspeed. Recovery will be initiated at a speed no lower than 95 KIAS as per the S-Tec autopilot limitation.

#### *Recovery*

- Disconnect autopilot and simultaneously,
- Reduce angle of attack and level wings,
- Verify full power.

# Section 5 - Emergency and Abnormal Procedures

## General

Section 3 and 3A of the Pilot's Operating Handbook provide the procedures for handling emergency and abnormal system and/or flight conditions which, if followed, will maintain an acceptable level of airworthiness and reduce operational risk. The guidelines described in these sections are to be used when an emergency and/or abnormal condition exists and should be considered and applied as necessary.

### Checklist Completion for Abnormal Procedures

Completion of abnormal procedures should be done using the do-list method. The appropriate checklist should be directly referred to and each item should be completed in the order prescribed.

### Checklist Completion for Emergency Procedures

Emergency checklists should be completed from memory. The Emergency Procedures section of the POH identifies checklist items for emergency procedures that must be memorized. Execution of these procedures is considered time critical and is done without reference to a checklist. The checklist should only be referenced during an emergency if time permits.

Intentionally Left Blank

# Section 6 - Performance

## General

To determine what performance to expect from the airplane under various ambient and field conditions, Refer to Section 5 - Performance, of the Pilot's Operating Handbook. Performance data are presented for takeoff, climb, and cruise (including range & endurance).

Intentionally Left Blank



# Section 7 - Supplementary Information

## General

This section should be used as a supplement for the planning and execution of all flights in Cirrus aircraft. Although an excellent resource, this information will not guarantee a safe flight. Minimizing flight risk requires sound judgment and sensible operating practices. Safety of flight ultimately depends upon the decisions made by you, the pilot.

Safe flights should be conducted in accordance with regulations, ATC clearances, personal capabilities, and the aircraft operating limitations described in the FAA Approved Airplane Flight Manual and Pilot's Operating Handbook (POH). Procedures in this publication are derived from procedures in the FAA Approved Airplane Flight Manual (AFM). Cirrus Design has attempted to ensure that the data contained agrees with the data in the AFM. If there is any disagreement, ***the Airplane Flight Manual is the final authority***. For operations outside the United States, refer to the appropriate regulations for that country. This publication should be in the pilot's possession during all flight operations.

## Pilot Qualification and Training

The pilot in command of any Cirrus aircraft is responsible for its safe operation. It is recommended that all pilots operate in accordance with the policies and procedures prescribed within this publication. In no case does this document relieve the pilot in command from the responsibility of making safe decisions regarding the operation of the aircraft.

### Training

#### *Initial Training*

Cirrus pilots should satisfactorily complete the Cirrus Transition Training Course or the Cirrus Standardized Instructor Program (CSIP) course prior to acting as pilot in command of a Cirrus aircraft.

- Note •

Instrument rated pilots should complete an instrument proficiency check prior to flying in IMC.

#### *Recurrent Training*

Cirrus pilots should complete recurrent training at a Cirrus Standardized Training Center (CSTC) or with a Cirrus Standardized Instructor (CSI) under the guidance of the Cirrus Pilot Learning Plan. Recurrent training emphasizes aeronautical decision making, risk management, and airmanship, which leads to increased proficiency. The recurrent training program provides an opportunity to meet the requirements of a biennial flight review or instrument proficiency check.

- Note •

Instrument rated pilots should complete an instrument proficiency check every 6 months.

#### *Additional Training Resources*

##### *Pilot's World Magazine*

Pilot's World is a free online monthly proficiency program used to increase a pilot's knowledge, proficiency and safe utilization of a Cirrus aircraft. It is designed for pilots, with or without an instrument rating. Each month this program provides a Ground Segment and Flight

Segment that address important topics of value to all Cirrus pilots. Pilot's World is accessible at <http://www.cirrusdesign.com>.

### *Jeppesen Learning Center*

Jeppesen Learning Center is an online training resource used by Cirrus pilots before, during and after the initial transition training. The Jeppesen Learning Center includes approximately eight hours of online ground school and syllabi for six scenario-based flight workshops. A bookshelf containing publications specific to the aircraft and avionics along with additional information is included. Access to Jeppesen Internet Flight Planner is also provided. Cirrus and Jeppesen believe that this is the first time that such an integrated curriculum has been provided in a general aviation training program.

### *Cirrus Pilot Leaning Plan*

The Cirrus Pilot Leaning Plan provides guidance on the recurrent training events recommended by Cirrus Design. Following the guidance provided in the learning plan will help Cirrus pilots develop and maintain a high level of proficiency. This training, coupled with exercising sound judgement, will help ensure the safe completion of flight.

### *Cirrus Owners and Pilots Association*

Cirrus Owners and Pilots Association (COPA) is an organization that welcomes the membership of Cirrus owners, pilots and enthusiasts with an interest in aviation and particularly, Cirrus aircraft, issues and events. Three main training and safety related events provided by COPA are the Cirrus Pilot Proficiency Program (CPPP), the Critical Decision Making (CDM) course and the Partner In Command (PIC) course. The CPPP course is designed to expose Cirrus pilots issues they may encounter while operating their aircraft. Topics such as weather, accident review, advanced avionics, emergency procedures and engine management are discussed and applied during a CPPP course.

### *Critical Decision Making Course*

The Critical Decision Making course is typically presented in conjunction with a Cirrus Mobile Showroom Event and may take place at any number of cities throughout North America. The CDM course addresses issues related to aeronautical decision making as it relates to Cirrus pilots. The PIC course has been designed to give frequent

Cirrus passengers more knowledge regarding safety system operations in the unlikely event that the Pilot in Command should become incapacitated. Procedures include using basic radio communication and CAPS activation. The PIC course is provided by both Cirrus Design and COPA.

PIC, CPPP and CDM schedules and information can be found on the COPA website; [www.cirruspilots.org](http://www.cirruspilots.org)

## Medical Certificates

In order to exercise the privileges of a private pilot certificate the pilot must hold a third class medical certificate, which is valid for 24 months from the date of issue (36 months if the person is under 40.) In order to exercise the privileges of a commercial pilot certificate a pilot must hold and maintain a second-class medical certificate valid for 12 calendar months from the date of issue.

## Takeoff and Landing Wind Proficiency

A Cirrus pilot should not attempt to takeoff or land when the wind speed and crosswind component exceed the individual's capabilities.

### ***Non-Instrument Rated or Instrument Rated (Non-Proficient)***

- Day: Maximum 25 knots sustained and 15 knots crosswind.
- Night: Maximum 25 knots sustained and 10 knots crosswind.

### ***Instrument Rated (Proficient)***

- Day: Maximum 30 knots sustained and 15 knots crosswind.
- Night: Maximum 25 knots sustained and 15 knots crosswind.

### ***Instrument Rated (Proficient with Demonstrated Ability to Category I Minimums within 60 days)***

- Maximum 35 knots sustained and 20 knots crosswind or maximum demonstrated crosswind component.

When taking off or landing on ice-covered runways (braking action reported POOR), the crosswind component should not exceed 50% of the aircraft's demonstrated crosswind component. Takeoff and landing training should not to be conducted if the wind exceeds 25 knots or the gust factor exceeds 10 knots. Land into the wind whenever possible during normal operations. Where airport layout or the type of operation requires landing with a tailwind - for example, an ILS approach - up to

a 10 knot tailwind component is allowed per the Performance Section of the Pilot's Operating Handbook.

## Takeoff, Enroute and Landing Minimums

Cirrus pilots should not operate below the following minimum ceiling and flight visibility limitations:

### ***Non-Instrument Rated or Instrument Rated (Non-Proficient)***

A pilot should only operate when the ceiling and visibility are at least 3000 feet and 5 miles, respectively, during the day. For night operations the minimum ceiling and visibility should be at least 5000 feet and 10 miles, respectively.

### ***Instrument Rated (Proficient)***

A pilot who has fewer than 100 hours in a Cirrus aircraft should only operate in that aircraft type when the ceiling and visibility are at least 1000 feet and 3 miles, respectively.

For day operations, a pilot who has logged more than 100 hours in a Cirrus aircraft should only operate that aircraft type when the ceiling and visibility are at least 500 feet and 1 mile, respectively. For night operations, a pilot who has logged more than 100 hours in a Cirrus aircraft should only operate that aircraft type when the ceiling and visibility are at least 600 feet and 2 miles, respectively.

### ***Instrument Rated (Proficient with Demonstrated Ability to Category I Minimums within 60 days)***

- Note •

Initial Category I currency should be obtained with a CSTC instructor or a CSI.

A pilot who has logged fewer than 100 hours in a Cirrus aircraft should only operate when the ceiling and visibility are at least 500 feet and 1 mile, respectively. A pilot who has logged more than 100 hours in a Cirrus aircraft should only operate that aircraft type when the ceiling and visibility are at least 200 feet and 1/2 mile, respectively.

- Note •

Pilots should file an IFR flight plan any time the weather conditions are below 3000 feet and/or 5 miles visibility.

## Currency Requirements

### **VFR**

Cirrus pilots should maintain VFR currency by completing each of the following items in a Cirrus aircraft:

- The Cirrus Transition Training course,
- 3 takeoffs and 3 landings to a full stop within the previous 60 days,
- 10 hours as the PIC within the previous 60 days,
- The training events outlined in the Cirrus Pilot Learning Plan.

Cirrus pilots should fly with a CSTC instructor or with a CSI to meet the flight currency requirement if currency lapses. Completion of training events outlined in the Cirrus Pilot Learning Plan will also restore flight currency.

### **IFR**

Cirrus pilots should maintain IFR currency by completing each of the following items in a Cirrus aircraft:

- VFR currency requirements,
- an IPC with CSTC instructor or a CSI within the previous 6 months,
- 3 instrument approaches in actual or simulated instrument conditions within the previous 60 days.
- For Category I currency, demonstrate the ability to execute an instrument approach to Category I minimums within the previous 60 days.

• Note •

Initial Category I currency should be obtained with a CSTC instructor or a CSI.

# Pilot Duty Considerations

## Duty Time and Rest

Pilots should avoid a duty period greater than 14 hours including a maximum of 8 hours of flight instruction. A pilot should have a 10 hour rest period prior to flying the following day. Pilots should consider non-flight related working periods as duty time.

## Physiological

### *Intoxicants*

Pilots should not consume alcohol or other intoxicants within 12 hours prior to flying and should always consider the lasting effects of alcohol the following day.

### *Blood Donations*

A pilot should not operate an aircraft within 72 hours after a blood donation or transfusion due to temporary lowering of oxygen carrying capacity of blood following a blood donation or transfusion.

### *Scuba Diving*

A pilot or passenger who intends to fly after scuba diving should allow the body sufficient time to rid itself of excess nitrogen absorbed during the dive. The recommended wait times are as follows:

- Wait 12 hours - if flight will be below 8,000 feet pressure altitude and dive did not require a controlled ascent.
- Wait 24 hours - if flight will be above 8,000 feet pressure altitude or dive required a controlled ascent.

## **Aircraft Maintenance**

Cirrus aircraft owners and operators are to maintain their aircraft in accordance with the Instructions for Continued Airworthiness found in the Airplane Maintenance Manual. Aircraft maintenance should be completed at a Cirrus Authorized Service Center.

There is a worldwide network of Cirrus authorized professionals that are trained to maintain Cirrus aircraft. Cirrus Authorized Service Centers are available for regularly scheduled aircraft maintenance or needed repairs. A complete listing of service centers is available at <http://www.cirrusdesign.com>.

If a Cirrus aircraft is damaged or encounters mechanical difficulty that is hazardous to flight or ground operations away from home base, the pilot should land as soon as practical and not attempt to take off. The pilot should secure the aircraft and contact a Cirrus Authorized Service Center or call the Cirrus Hotline 800-279-4322. The purpose of this call is to assist the pilot in analyzing the problem and determining the best solution.

## **Grounding of Aircraft**

A Cirrus pilot or mechanic has the authority to ground an aircraft anytime it is determined to be not airworthy.



## Flight Planning

Pilots are encouraged to file VFR or IFR flight plans for all cross-country flights. Pilots should always plan an alternate, whether operating VFR or IFR.

The pilot should complete the following flight planning responsibilities: Determine the best route and altitude considering; winds aloft, freezing levels, cloud bases and tops, turbulence, terrain, airspace and TFRs.

- Determine alternate airport.
- Calculate fuel requirements.
- Verify aircraft is within weight and balance limitations.
- Calculate takeoff and landing distances. Verify runway lengths for intended airports.
- File flight plan.

## Weather Assessment

Pilots should determine if the weather conditions exceed their qualifications and capabilities. A decision should be made to postpone the flight if the weather is not acceptable. Flight planning should continue if the weather is acceptable.

• Note •

To facilitate flight planning, the U.S. Government provides a free Direct User Access Terminal Service (DUATS) for all licensed pilots at <http://www.duats.com>.

### ***IFR Alternate Airport Weather Requirements***

If from 1 hour before to 1 hour after the estimated time of arrival at the destination airport, the weather is forecast to be at least 2,000 foot ceilings and 3 mile visibilities, no alternate is required, though it is important to be familiar with the area if a diversion is required. If forecasted weather conditions are less than 2,000 feet and 3 miles, an alternate must be filed.

A pilot may only include an alternate airport in an IFR flight plan when appropriate weather reports or forecasts, or a combination of them, indicate that, at the estimated time of arrival at the alternate airport,

the ceiling and visibility at that airport will be at or above the following weather minima:

- For a precision approach procedure. Ceiling 600 feet and visibility 2 statute miles.
- For a Non-precision approach procedure. Ceiling 800 feet and visibility 2 statute miles.

If no instrument approach procedure has been published, the ceiling and visibility minima are those allowing descent from the MEA, approach and landing under basic VFR.

## **Fuel Requirements**

No person may operate an aircraft in IFR conditions unless there is enough fuel (considering weather reports, forecasts, and weather conditions) to:

- Complete the flight to the first airport of intended landing,
- Fly from that airport to the alternate airport,
- Fly after that for 45 minutes at normal cruising speed.

No person may begin a flight in an aircraft under VFR conditions unless (considering wind and forecast weather conditions) there is enough fuel to fly to the first point of intended landing and assuming normal cruising speed and at least an additional 45 minutes beyond that point in either day or night conditions.

## **Minimum Runway Length**

Cirrus pilots are encouraged to operate off a minimum runway length of 2,500 feet or twice the expected takeoff and /or landing distance, whichever is higher. Cirrus pilots should receive short field takeoff and landing instruction prior to operating at fields shorter than 2,500 ft.

## **Noise Abatement**

When operating out of noise sensitive airports pilots are encouraged to follow local noise abatement procedures and consider a power reduction during the climb if necessary and safe.

## Weather

A critical factor in a successful flight is the pilot's evaluation of weather conditions. Many weather related accidents could have been prevented during preflight if the pilot had thoroughly evaluated the weather conditions. The following weather resources will be useful for evaluating the weather:

Flight Service Station: ..... 800-WX-BRIEF

Aviation Weather Center ..... <http://www.aviationweather.gov>

Direct User Access Terminal Service (DUATS) ... <http://www.duats.com>

National Weather Service..... <http://www.nws.noaa.gov>

The go/no-go decision and the route to the intended destination greatly depend on the weather at the departure airport, along the route and destination. The pilot's ability to interpret and understand aviation weather is critical to the safety of flight. Follow the steps below when assessing the weather for every flight.

### Overview

The first step to understanding the weather conditions along the intended route is to assess the big picture. The pilot should become familiar with pressure systems, frontal systems, precipitation, areas of marginal VFR and IFR conditions, and areas of icing and turbulence. Weather products available include:

- Surface analysis chart,
- Weather radar,
- Satellite Imagery.

### Hazards to Flight

The second step is to identify any potential hazards for the intended flight. The pilot should become familiar with areas of marginal VFR and IFR conditions, convective activity, and areas of icing and turbulence. Weather products available include:

- Weather depiction chart,
- AIRMETs, SIGMETs and Convective SIGMETs,
- Weather radar,

- Pilot reports,
- Area forecast,
- Current and forecasted icing potential tools,
- <http://www.aviationweather.gov>.

## Current Observations

The third step is to become familiar with the current observations along the intended flight. Current weather observations within 50 miles of the departure, intended route and destination airport should be analyzed. Weather products available include:

- METARs,
- Pilot reports.

• Note •

Go to <http://adds.aviationweather.gov/java/> for an interactive weather tool.

## Forecasted Weather

The fourth step is to understand what the weather is expected to do during your flight. Evaluate the weather +/- 2 hours from your estimated time of arrival at the destination or planned alternate. Weather products available include:

- TAFs,
- Area forecast,
- Prognostic charts,
- Winds and temperature aloft,
- AIRMETs, SIGMETs and Convective SIGMETs.

## NOTAMS

The fifth step is to become aware of any NOTAMS that may affect the flight. Pay close attention to any TFRs that may interfere with your routing.

## Thunderstorm Flying

Never regard a thunderstorm lightly - even when radar observers report the echoes are of light intensity. Avoiding thunderstorms is the best policy. The following are some Do's and Don'ts of thunderstorm avoidance:

- Don't land or takeoff in the face of an approaching thunderstorm. A sudden gust front or low level turbulence could cause loss of control.
- Don't attempt to fly under a thunderstorm even if you can see through to the other side. Turbulence and wind shear under the storm could be disastrous.
- Don't trust the visual appearance to be a reliable indicator of the turbulence inside a thunderstorm.
- Avoid by at least 20 miles any thunderstorm identified as severe or giving an intense radar echo. This is especially true under the anvil of a large cumulonimbus.
- Circumnavigate the entire area if the area has 6/10 thunderstorm coverage.
- Remember that vivid and frequent lightning indicates the existence of a strong thunderstorm.

Regard as extremely hazardous any thunderstorm with tops 35,000 feet or higher, whether the top is visually sighted or determined by radar.

## Temperature Minimums

Flight training operations should not be undertaken when the outside air temperature falls below -20 Fahrenheit. Cirrus aircraft should be preheated if exposed to ground temperatures below 20 Fahrenheit for more than two hours. Do not operate the engine at speeds above 1700 RPM unless oil temperature is 75 Fahrenheit or higher and oil pressure is within specified limits of 30-60 PSI. When oil temperature has reached 100 Fahrenheit and oil pressure does not exceed 60 PSI at 2500 RPM, the engine has been warmed sufficiently to accept full rated power.

## Operations in Icing Conditions

### • **WARNING** •

Flight into known icing is prohibited.

A pilot should not take off in an aircraft that has frost, snow, or ice adhering to any external surface.

A pilot can expect icing when flying in visible moisture, such as rain, snow or clouds, and the temperature of the aircraft is below freezing. If icing is detected a pilot should turn on all available anti-icing equipment and do one of two things to exit the icing conditions; get out of the area of visible moisture or go to an altitude where the temperature is above freezing. The warmer altitude may not always be a lower altitude. Proper preflight action includes obtaining information on the freezing level. Report icing to ATC, and if operating IFR, request new routing or altitude if icing is encountered.

## **In-Flight Considerations**

### **Turns after Takeoff**

The recommended turn altitude after takeoff is 400 feet AGL, unless obstacle departure procedures or ATC instructions dictate otherwise. When cleared to Fly Runway Heading pilots should maintain the heading that corresponds with the extended centerline of the departure runway until otherwise directed by ATC. Drift correction should not be applied; i.e., Runway 04, with an actual magnetic heading of the runway centerline being 044 degrees, fly 044 degrees.

### **Weather Status**

Pilots should monitor the weather along the route and destination airport for deteriorating conditions using onboard weather resources and ground based weather resources. Enroute Flight Advisory Service, Flight Watch, is generally available on 122.0 anywhere in the contiguous United States. A diversion may be necessary if the weather deteriorates beyond the pilot's qualifications and/or capabilities.

### **Aircraft Systems Status**

Pilots should monitor the flight, engine and system parameters throughout the flight. Verify adequate fuel remains to reach the intended destination and switch fuel tanks as required to maintain an equal balance.

### **Pilot Status**

Pilots should monitor fatigue and stress levels during the flight. A diversion may be necessary if the pilot has any reason to believe the flight can not be safely completed.

### **Situational Awareness**

Pilots should maintain situational awareness throughout the entire flight using all available equipment and resources.

## Supplemental Oxygen

According to Title 14 CFR Part 91.211 no person may operate an aircraft-

1. At cabin pressure altitudes above 12,500 feet (MSL) up to and including 14,000 feet (MSL) unless the required minimum flight crew is provided with and uses supplemental oxygen for that part of the flight at those altitudes that is of more than 30 minutes duration;
2. At cabin pressure altitudes above 14,000 feet (MSL) unless the required minimum flight crew is provided with and uses supplemental oxygen during the entire flight time at those altitudes; and
3. At cabin pressure altitudes above 15,000 feet (MSL) unless each occupant of the aircraft is provided with supplemental oxygen.

• Note •

For optimal protection pilots are encouraged to use supplemental oxygen above 10,000 feet during the day and above 5,000 feet during the night.



## Flight Safety

In addition to the operating limitations specific to each aircraft type, the following actions are not recommended:

- Parachuting activities,
- Hand propped engine starts,
- Flight below 500' AGL except for takeoff and landing,
- Flight beyond the safe gliding distance of land.

• Note •

The pilot should ensure that adequate survival gear is readily accessible if flight beyond the safe gliding distance is required.

## Sterile Cabin

During sterile cabin operations all distractions such as XM radio, non-flight related materials and unnecessary communication with passengers should be minimized. A sterile cabin should be observed during departure, arrival and abnormal/emergency operations.

## Smoking

Smoking is prohibited inside or near aircraft and hangars. It is the responsibility of the pilot to ensure that their passengers comply with these restrictions.

# International Border Operations

## Preflight

- Appropriate charts and flight supplements

## Personal Documentation

- Pilot certificate,
- Medical certificate,
- Notarized letter authorizing children to fly (only if accompanied by one parent),
- Proof of citizenship,
- Passport,
- Birth certificate (original or certified true copy),
- Photo ID (required with birth certificate),
- Resident alien ID Card,
- Other Visa documentation as required,
- Restricted Radiotelephone Operator Permit.

## Aircraft Documentation

- Airworthiness certificate,
- Registration certificate (not temporary registration certificate),
- Operating limitations,
- Weight and balance information,
- Experimental Aircraft - Standardized Validation (for operations in Canada) or Special Flight Authorization (for operations in U.S.),
- Proof of liability insurance for the specific country,
- FAA Form 337 (U.S. aircraft only) or STC documentation if fuel tanks have been added compartments,
- Aircraft Radio Station License,
- Customs Form 339A: Annual User Fee Decal Request - Aircraft.

## Crossing the United States and Canadian Border

### *Departure*

- Give advance notification to Customs.
  - U.S. to Canada - contact CANPASS no less than two hours before and no more than 48 hours before arrival at 888-CANPASS or 888-226-7277.
  - Canada to U.S. - telephone Customs office at airport of entry no less than two hours and no more than 23 hours before arrival; enter ADCUS in Remarks block of flight plan form.
- File and activate a VFR or IFR flight plan.
- Advise Customs if any change in ETA at AOE via ATC/FSS while in flight, get badge number and name of Customs official that ATC/FSS is communicating with.

### *Arrival*

- Make first landing at an airport of entry (AOE).
- Taxi to Customs area on ramp.
- In the U.S. - Do not be early and no more than 15 minutes beyond your ETA; wait for Customs official to motion you out of aircraft.
- In Canada - if not met, find a telephone and call 888-CANPASS, follow directions from Customs official, obtain arrival report number.
- If inspected, present documentation as required, fill out any declaration forms and pay appropriate duties and taxes.
- Close your flight plan.

## Incident and Accident Procedures

The pilot shall immediately notify the nearest National Transportation Safety Board field office if an aircraft incident or accident occurs as defined in NTSB Part 830. The proper law enforcement agency and/or search and rescue shall be notified if necessary. The pilot should complete the Aircraft Accident and Incident Report, found in this section, after any accident or incident. The pilot should not discuss the circumstances with anyone not involved with the investigation.

### Emergency Landing

If a Cirrus aircraft makes an emergency landing at a site not designated as an airport, the pilot should not attempt to take off, but should immediately contact the proper authorities.

### Aircraft Incident and Accident Notification

An Aircraft Incident and Accident Report should be completed by the pilot any time a Cirrus aircraft sustains any damage or is involved in an accident or incident. The information may be useful in a future investigation. The report form is found in this manual.

### NTSB Field Office

Southeast - Atlanta .....	404-562-1666
Southeast - Miami.....	305-597-4610
North Central .....	630-377-8177
Northeast - Parsippany.....	973-334-6420
Northeast - Ashburn .....	571-223-3930
Central Mountain .....	303-373-3500
South Central.....	817-652-7800
Northwest .....	206-870-2200
Southwest.....	310-380-5660
Alaska.....	907-271-5001

## Aircraft Incident and Accident Report

Date of accident: \_\_\_\_\_ Time: \_\_\_\_\_

Pilot's Name: \_\_\_\_\_ Phone No: \_\_\_\_\_

Owner and/or Operator: \_\_\_\_\_

Aircraft Type: \_\_\_\_\_ N-No: \_\_\_\_\_

Type of Event (circle one):    Accident                  Incident                  Damage

Last point of departure: \_\_\_\_\_

Point of intended landing: \_\_\_\_\_

Position of aircraft in reference to an easily defined geographical point:

\_\_\_\_\_  
\_\_\_\_\_

Number of persons aboard: \_\_\_\_\_ Fatalities: \_\_\_\_\_ Injured: \_\_\_\_\_

Description of injuries: (if applicable): \_\_\_\_\_

\_\_\_\_\_  
\_\_\_\_\_

Names of passengers: \_\_\_\_\_

\_\_\_\_\_  
\_\_\_\_\_

Weather conditions (attach weather print-off if available):

Wind Direction: \_\_\_\_\_ Wind Velocity: \_\_\_\_\_

Visibility: \_\_\_\_\_ Sky Condition: \_\_\_\_\_

Temp/Dewpoint: \_\_\_\_\_ Altimeter Setting: \_\_\_\_\_

Other \_\_\_\_\_

Eye Witnesses:

Name

Phone Number

1. \_\_\_\_\_



2. \_\_\_\_\_

3. \_\_\_\_\_





The Envelope of Safety is only one of many considerations that should precede the decision to fly. As the Pilot in Command, you are responsible for the operation of the flight and ensuring that all levels of safety have been met, including those not addressed by this card.

QUALIFICATION	DAY		NIGHT		MAX WIND: T-O & LND
	DAY	NIGHT	DAY	NIGHT	
ALL VFR FLIGHTS NON-INSTRUMENT RATED -OR- INSTRUMENT RATED [NON-PROFICIENT]	 Operate at or Above 3000' Ceilings 5 SM Visibility	 Operate at or Above 5000' Ceilings 10 SM Visibility	25 KNOTS TOTAL SUSTAINED 15 KNOT CROSSWIND	25 KNOTS TOTAL SUSTAINED 10 KNOT CROSSWIND	DAY
INSTRUMENT RATED [PROFICIENT]	Less than 100 hours In Type	Greater than 100 hours In Type	Less than 100 hours In Type	Greater than 100 hours In Type	DAY
	Operate at or Above 1000' Ceilings 3 SM Visibility	Operate at or Above 500' Ceilings 1 SM Visibility	Operate at or Above 1000' Ceilings 3 SM Visibility	Operate at or Above 600' Ceilings 2 SM Visibility	NIGHT
INSTRUMENT RATED [PROFICIENT WITH DEMONSTRATED ABILITY TO CATT 1 MINIMUMS WITHIN 60 DAYS]	Less than 100 hours In Type	Greater than 100 hours In Type	Less than 100 hours In Type	Greater than 100 hours In Type	DAY
	Operate at or Above 500' Ceilings 1 SM Visibility	Operate at or Above 200' Ceilings 1/2 SM Visibility	Operate at or Above 500' Ceilings 1 SM Visibility	Operate at or Above 200' Ceilings 1/2 SM Visibility	NIGHT
Note: File IFR anytime the weather is below 3000/5 SM			35 KNOTS TOTAL SUSTAINED 20 KNOT CROSSWIND OR MAX DEMONSTRATED	35 KNOTS TOTAL SUSTAINED 20 KNOT CROSSWIND OR MAX DEMONSTRATED	

**ICING CONDITIONS:**  
FLIGHT INTO KNOWN ICING CONDITIONS IS PROHIBITED.

Minimum runway  
is 2.5 times the  
expected T-O or  
LND distance