



SunPorch Structures, Inc.
555 Lordship Blvd.
Stratford, CT 06615
800-221-2550
sales@sunporch.com

Lock in your order savings with \$100 deposit!

1) **YES!** Please lock-in my savings with a

MasterCard Visa Check Enclosed

_____ / _____
Card No.

____ / ____
Expiration date

3 Digit ID

Signature:

2) Upon receipt of your \$100 deposit, you will be mailed/emailed Order Confirmation documents from SunPorch.

3) Please **Sign & return** the Order Documents with _____

Upon receipt of signed documents and payment-in-full your order is finalized and scheduled for manufacturing. The factory will contact you to review final details. Finalized orders ship in 3-4 weeks, or...get FREE Factory Storage for delivery when you're ready
(Special Note: Call Customer Service to discuss final payment due date.)

Quote Summary:

Date:
Quote #:
PIN #:

Regular Price
Savings
Sale Price
Deposit to lock-in Sale Price:
Balance Due

View, Edit, Quote or Order Online:

www.sunporch.com/pin

Use PIN # below to get sale price online.

PIN # _____ ZIP Code: _____

Other Ways To Order:

Phone: 800-221-2550 Mail: SunPorch Structures, Inc.
555 Lordship Blvd.
Fax: 203-381-9059 Stratford, CT 06615



SunPorch Structures, Inc.
555 Lordship Blvd.
Stratford, CT 06615
800-221-2550
sales@sunporch.com

Date:
Quote #:
PIN #:

HERE'S THE PRICE QUOTE YOU REQUESTED!

Thank you for your interest in SunPorch.

If you need any further assistance with your project, please contact us today and a sales specialist will be happy to help you.



*Sincerely,
Dean Schwartz
General Manager*

NEED HELP? CONTACT US TODAY!
800-221-2550 • sales@sunporch.com • www.sunporch.com



SunPorch Structures, Inc.
 555 Lordship Blvd.
 Stratford, CT 06615
 800-221-2550
 sales@sunporch.com

Date:
Quote #:
PIN #:

Ship To:

Qty	Item Code	Description	Unit Price	Ext. Price
1	0621EZS	SunPorch Model EZS0621	\$12,780.00	\$12,780.00
	SFCWHI	Frame Color: White	\$0.00	\$0.00
	SRGCLR	Roof Glazing: Clear Polycarbonate	\$0.00	\$0.00
1	SDINC	Door (Included) - Location: F4 - Hinged: Right	\$0.00	\$0.00
1	0621EZS-S&H	Ship & Hand (CT Zip Code 06615)	\$845.00	\$845.00
1	WGD	White Glove Delivery Inside Your Garage	\$0.00	\$0.00
1	FACSTOR90	Factory Storage (up to 90 days)	\$270.00	\$270.00
			Regular Price:	\$13,895.00
-1	DSPMODEL	Save 25% - Now Thru Jan 20, 2015!	\$3,195.00	(\$3,195.00)
-1	D0621EZS-S&H	FREE Shipping - Now Thru Jan 20, 2015!	\$845.00	(\$845.00)
-1	DFACSTOR90	FREE Factory Storage (up to 90 days)	\$270.00	(\$270.00)
			Total Savings:	\$4,310.00
			Sub Total:	\$9,585.00
1	CTTAX	CT Sales Tax (6.35%)	\$608.65	\$608.65
			Sale Price:	\$10,193.65

Lock-in your order SAVINGS of \$4,310.00 with a \$100 Deposit now thru Jan 8, 2015

Balance Due of \$10,093.65 (Call Customer Service to discuss final payment due date).

Finalized orders can be shipped or get FREE Factory storage for delivery when you are ready.

NEED HELP?
 Planning • Measuring • Pricing
 800-221-2550 or
 sales@sunporch.com

Transform your deck or patio into a beautiful outdoor room!

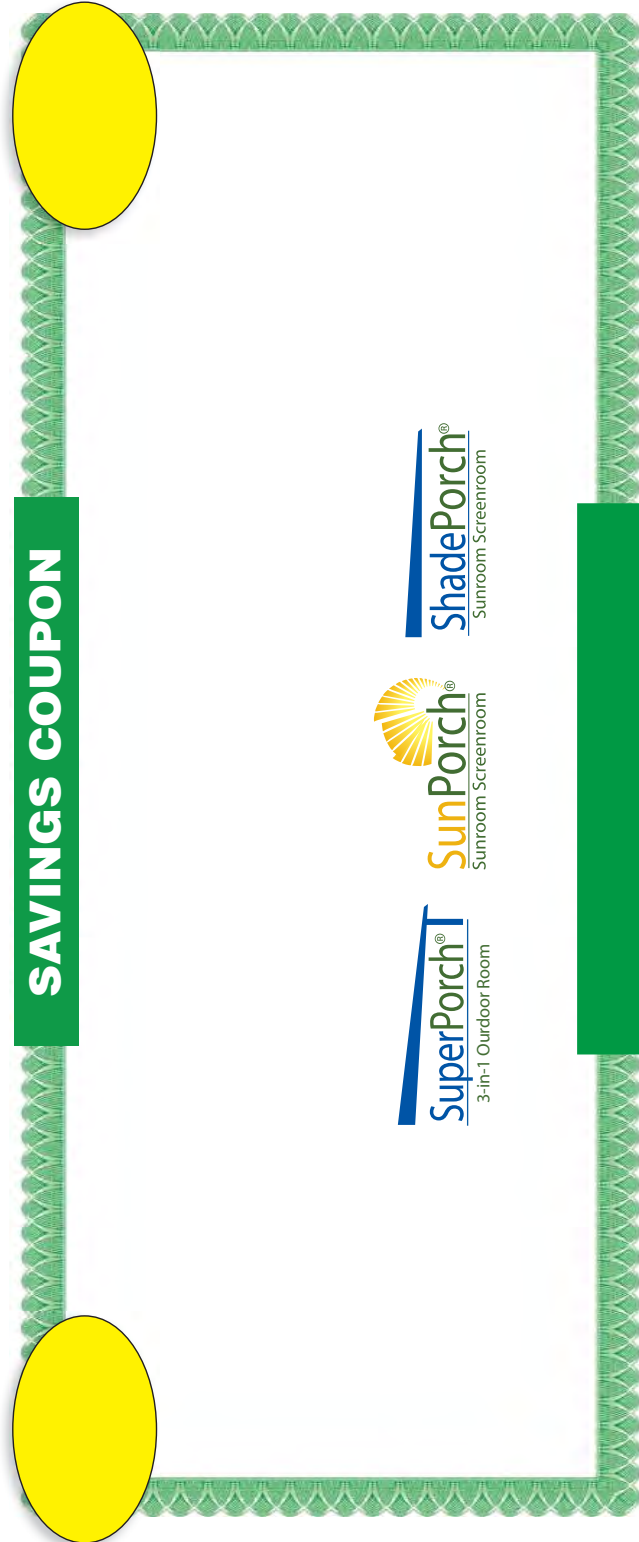

Upon payment in full, your order is shipped 3-4 weeks, or get Free Factory Storage for when you're ready!

Purchase now and get FREE factory storage for up to 90 days...take delivery when you're ready



- If you want to purchase now but aren't quite ready to take delivery... no problem! After your order is finalized and paid-in full, we'll Pack & Store your new sunroom here at the factory, for up to 90 days...FREE of Charge!
- This lets you order and lock-in your special savings now...while scheduling delivery at a later date
- You decide when you want to take delivery to fit your project schedule

11 Reasons Why You'll LOVE Your New Enclosed Outdoor Porch!



1 Floor to ceiling windows with screens goes from sunroom to screenroom in just seconds!



2 Spring starts sooner, Summer lasts longer, Fall is fantastic, Winter is warmer!



3 The patio furniture stays clean, dry and never gets put away!



4 No more annoying mosquitoes and bugs!



5 Rain and inclement weather will never cancel your plans!



6 Full view windows allow you to enjoy beautiful panoramic views & natural light.



7 Mounts on your existing patio or deck! No site prep. No permits. No taxes. (varies by locale)



8 Adds permanent beauty and value to your home!



9 ALL models are Building-Code Approved for snow loads and hurricane winds!



10 Ready-to-assemble, easy to install, maintenance-free, lasts a lifetime!



11 Proudly designed and manufactured at our factory in the USA for over 41 years.



Made In U.S.A.

41st
Anniversary
1974-2015



BBB
ACCREDITED
BUSINESS

10 YEAR
WARRANTY
MAINTENANCE FREE

CONTACT AN EXPERT TODAY!
800-221-2550
sales@sunporch.com

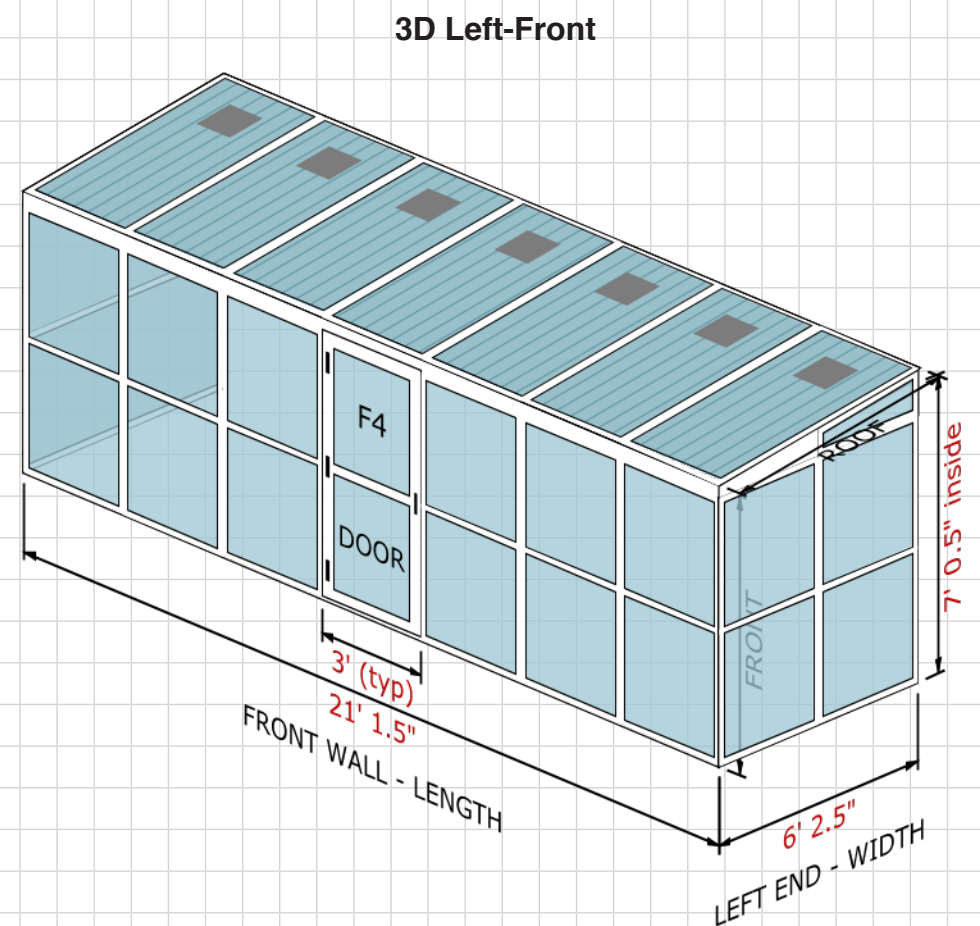
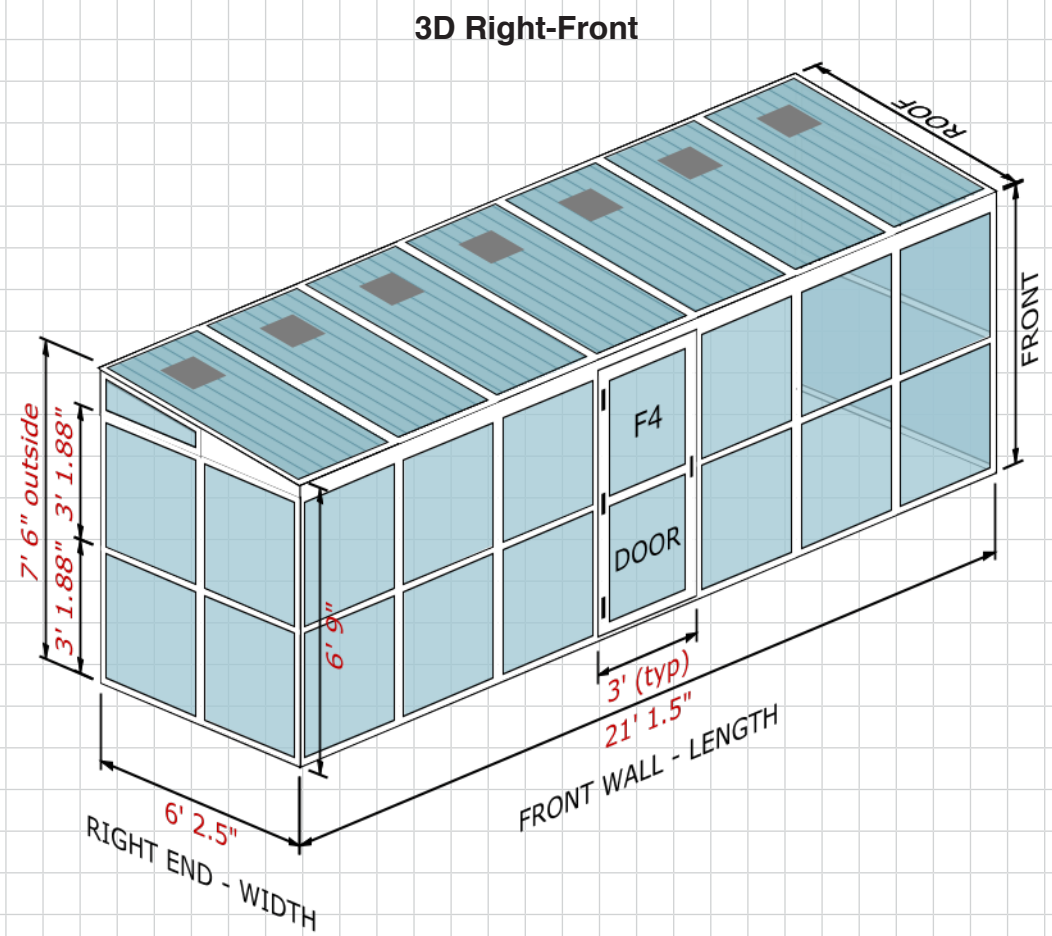

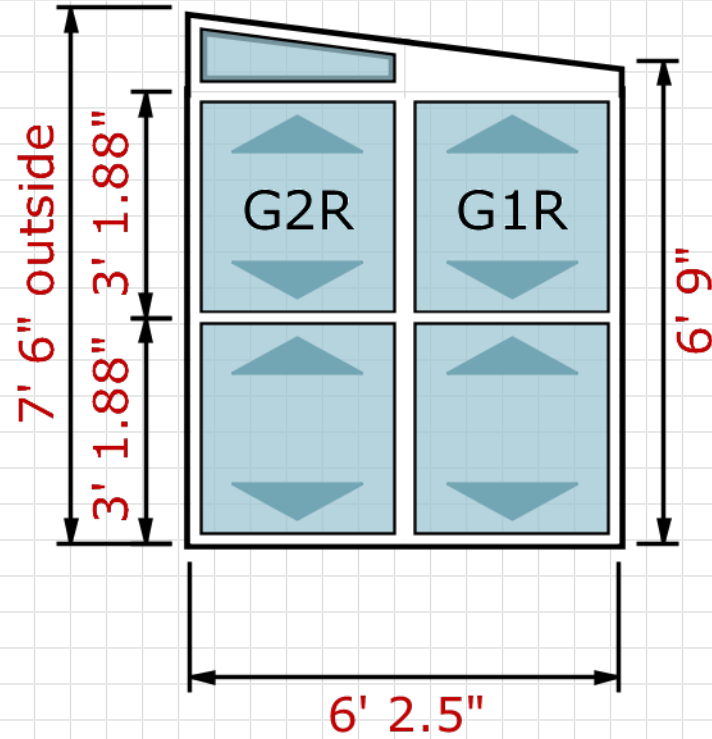
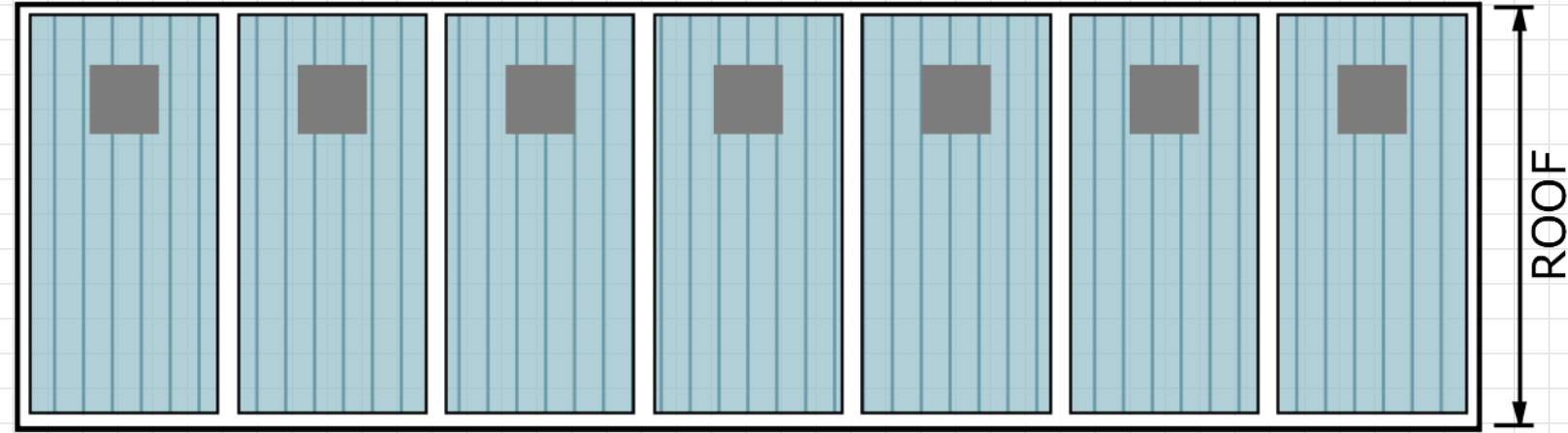
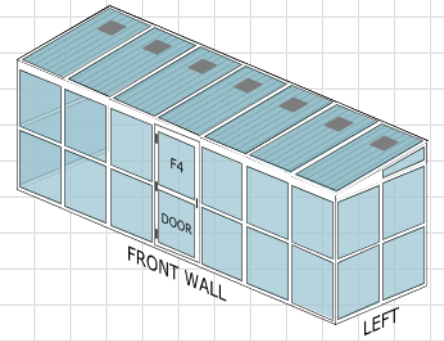
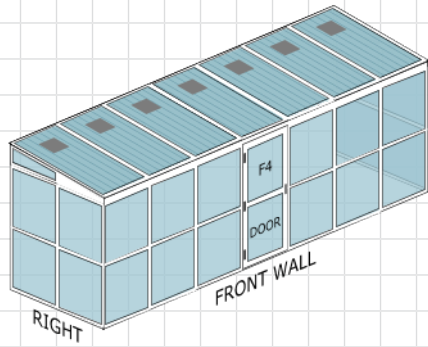

RIGHT END - WIDTH

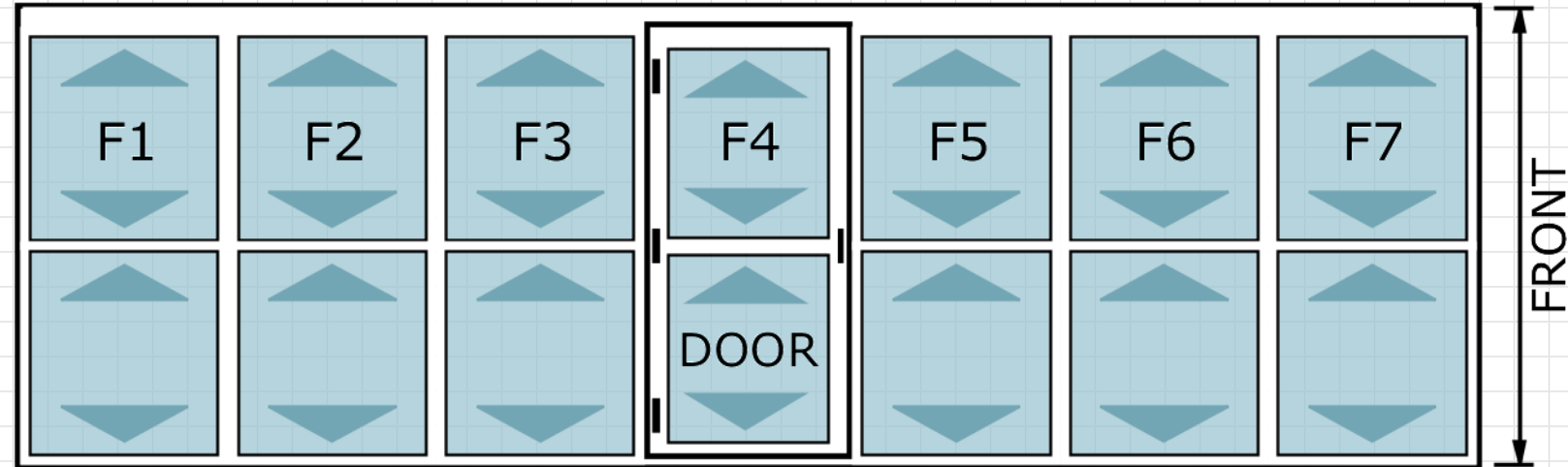

FRONT WALL - LENGTH

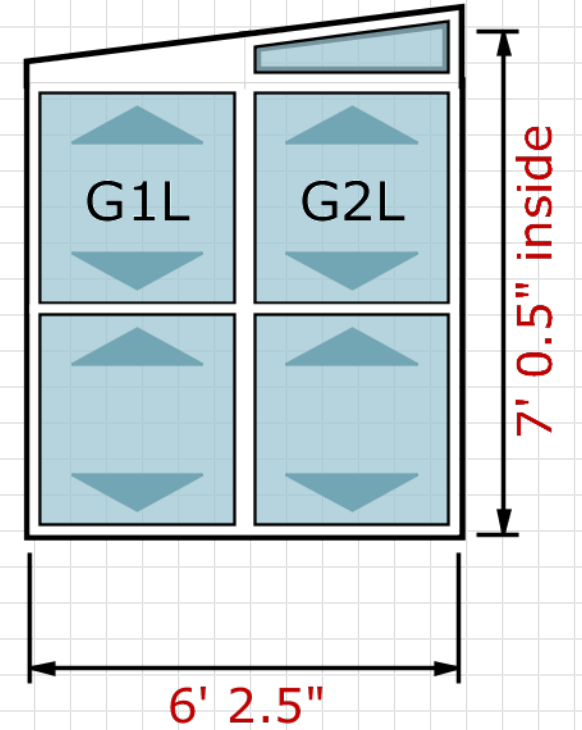

LEFT END - WIDTH

NOTE: Drawing not for construction.

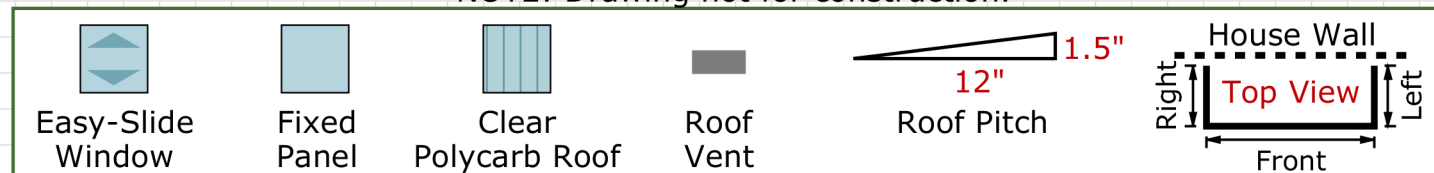

SunPorch Structures, Inc. 555 Lordship Blvd. Stratford, CT 06615			800-221-2550 sales@sunporch.com		
MODEL		DATE			
ORDER FOR					
SIZE	QUOTE #	PIN #		REV	
SCALE		REVISED			

WELCOME!

Customer Copy – Retain for your records



SunPorch Structures, Inc.
555 Lordship Blvd
Stratford, CT 06615

800-221-2550
203-381-9059 fax
sales@sunporch.com

Congratulations!

Thank you for your deposit and welcome to our SunPorch family! My name is Robin and I'm here to help you finalize and complete your order.

Robin Delvalle,
Business Manager

Here is my contact information:

203-557-2505 Phone (*rings at my desk*)
robin@sunporch.com (*email*)

Ordered By:

[Empty box for ordering information]

Order Summary:

Date:
Web Quote #:
Quote #:
Customer #:

Regular Price
Savings
Sale Price
Deposit (Non-Refundable)
Balance Due

How To Complete and Finalize Your Order:

Customer Copy – Retain for your records

Welcome

SunPorch Copy – Please sign & return

Order Confirmation
Order Diagram
Order Payment Form

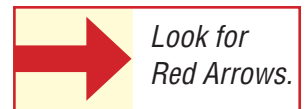

Once finalized, the factory will contact you with the scheduled ship date.
It can be delivered as scheduled, or you can choose FREE factory storage for up to 90 days.

Please allow 2-4 weeks from receipt of final payment for your shipment to arrive.

Order Confirmation

SunPorch Copy – Please sign & return



SunPorch Structures, Inc.
555 Lordship Blvd
Stratford, CT 06615

800-221-2550
203-381-9059 fax
sales@sunporch.com

Date:
Web Quote #:
Quote #:
Customer #:

Ordered By:

Ship To:

Order Summary

Qty	Item Code	Description	Unit Price	Ext. Price
1	SP3-1130	SuperPorch Model SP3-1130 - Solid Insulated Roof for Shade Protection - EasySlide 4 Track Vinyl Glazed Windows - 100% Window Panels & 50% Screen Panels - All Panels are Sliding Doors & Remove	\$13,820.00	\$13,820.00
	SFCWHI	Frame Color: White	\$0.00	\$0.00
1	CUSTOMITEM	Interior Wall F3-F4 Bays Model SP3	\$945.00	\$945.00
1	SP3-1130S&H	Ship & Hand (LA Zip Code 70737-6278)	\$1,095.00	\$1,095.00
			Regular Price:	\$15,860.00
-1	DSPMODEL	Save 25% - Now Thru Apr 21, 2015!	\$3,455.00	(\$3,455.00)
			Total Savings:	\$3,455.00
1	NOTAX	(Tax Applicable to CT Residents Only)	\$0.00	\$0.00
			Sale Price:	\$12,405.00

Lock-in your order SAVINGS of \$3,455.00 with a \$100 Deposit now thru May 19, 2015
Finalized orders can be shipped or get FREE Factory storage for delivery when you are ready.
Balance Due of \$12,305.00 (Call Customer Service to discuss final payment due date).

YES! My order is correct as per above.

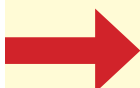

Signature _____ Date _____

Order Diagram

SunPorch Copy – Please sign & return

YES! My order is correct as per below.

Signature _____ Date _____

Web Quote #

Date:

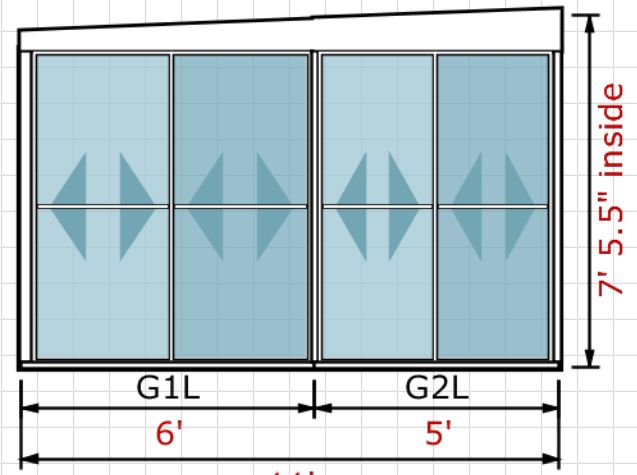
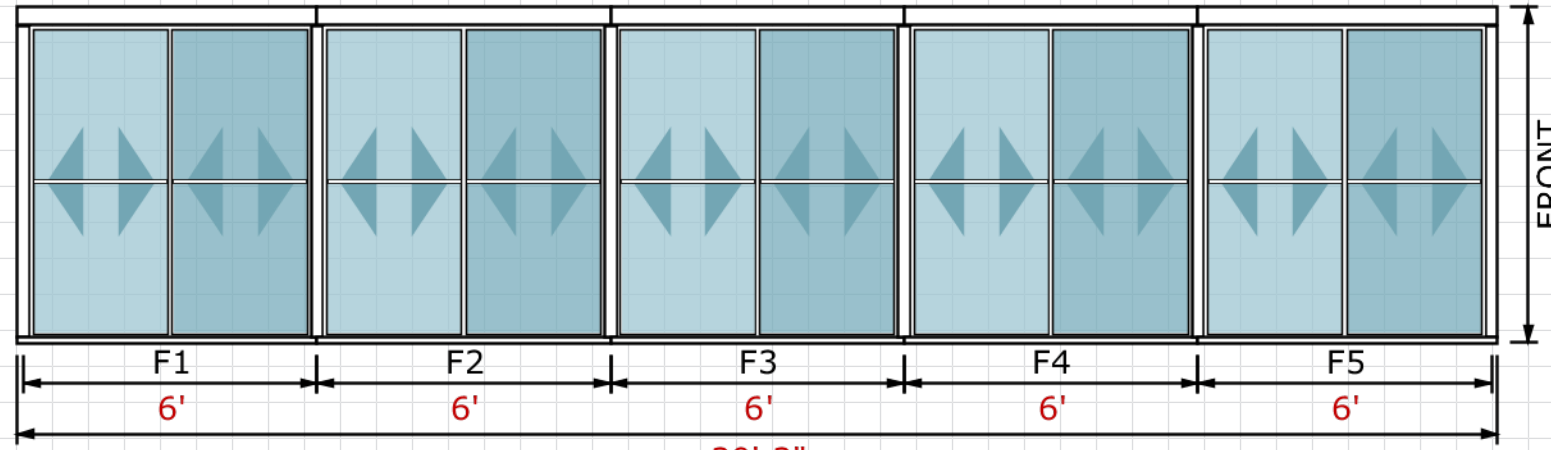
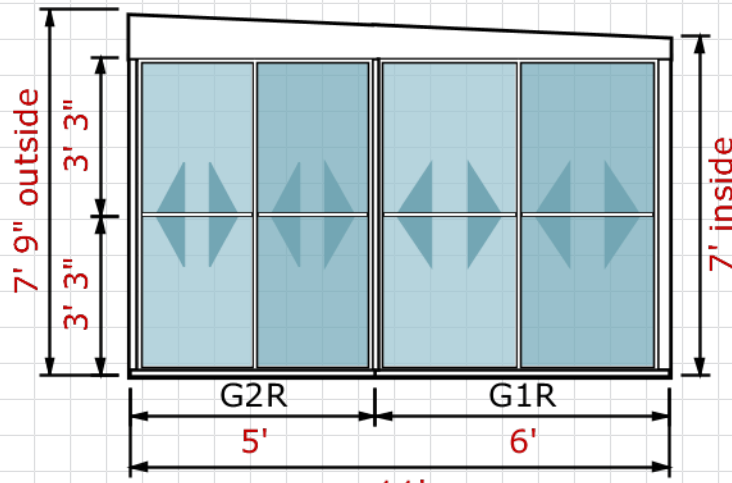
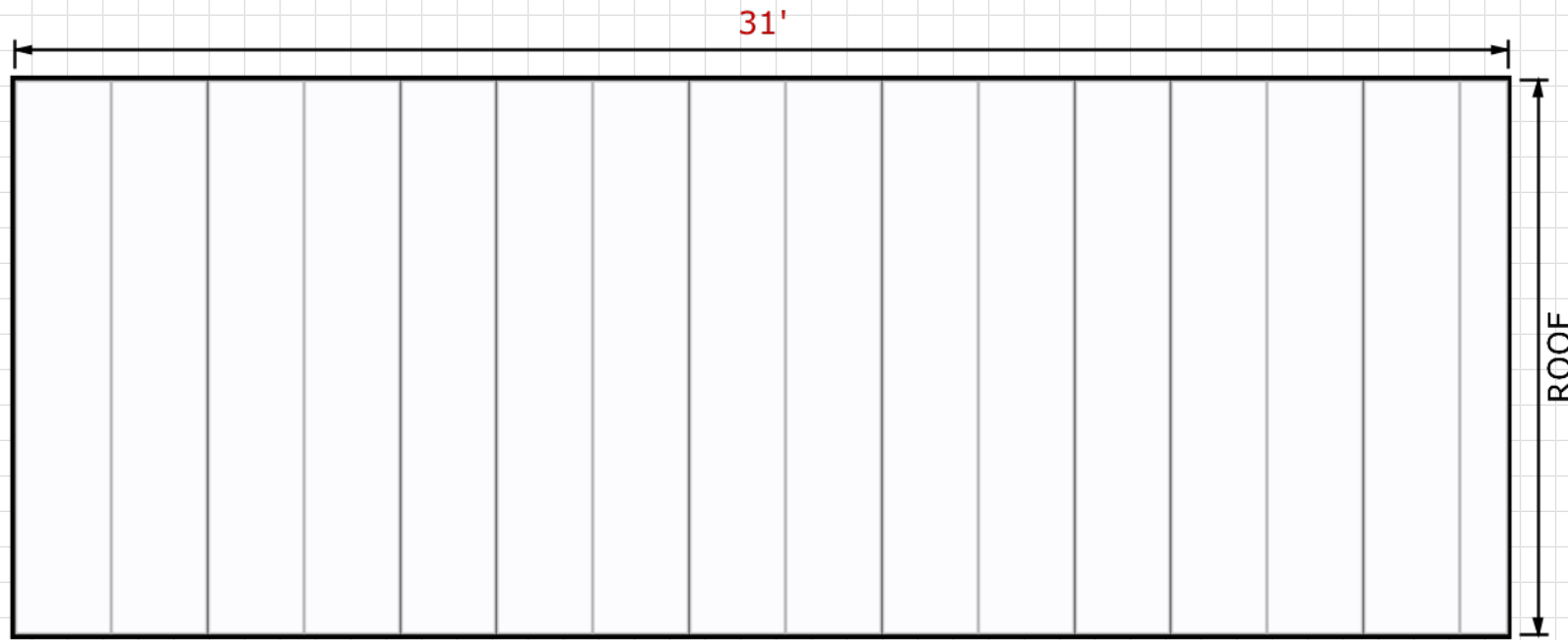
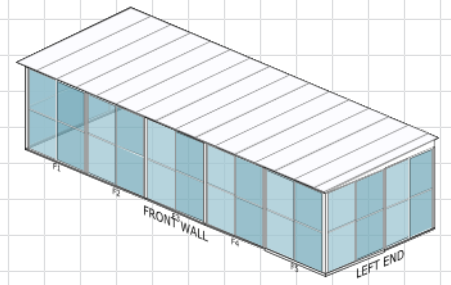
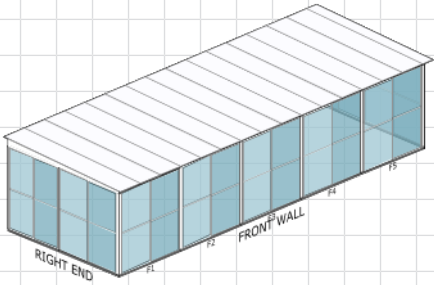

NOTE: Drawing not for construction.

Sliding Window	Sliding Win+Screen	Solid Roof	12" 1/2" Roof Pitch SuperPorch 3	House Wall Top View

SunPorch Structures, Inc. 800-221-2550
 555 Lordship Blvd 203-381-9059 fax
 Stratford, CT 06615 sales@sunporch.com

MODEL	DATE
ORDER FOR	
SIZE QUOTE #	CUSTOMER #
SCALE	REVISED

Order Payment Form

SunPorch Copy – Please sign & return



SunPorch Structures, Inc.
555 Lordship Blvd
Stratford, CT 06615

800-221-2550
203-381-9059 fax
sales@sunporch.com

Ordered By:

Blank space for ordering information.

Quote Summary:

Date:
Web Quote #:
Order #:
Customer #:

Sale Price
Deposit (Non-Refundable)
Balance Due

YES! I am ready to finalize my order and pay-in-full.

Method of Payment

Billing information (if different from Ordered By above)

Check Enclosed MasterCard Visa

Name _____

--	--	--	--	--	--	--	--	--	--	--	--	--	--	--	--	--	--	--	--

Address _____

City/State/Zip _____

Payment \$ _____

--	--	--	--

 /

--	--

--	--

Phone _____ Cell _____

 Signature _____
Date _____

Email _____

Refund Policies for Orders Paid-In-Full

SHIPPED ORDERS (within 15 days of shipment)

- Custom/Modified orders are non-refundable
- Standard orders 50% restocking fee
- Must be in sealed cartons
- Buyer responsible for inbound & outbound freight costs

UNSHIPPED ORDERS/FACTORY STORED ORDERS

- 50% cancellation fee

SHIPPED ACCESSORIES (within 15 days of shipment)

- 25% restocking fee
- Must be in sealed cartons
- Buyer responsible for inbound & outbound freight costs

Special Note Regarding Building Codes and Permits (varies by locale)

It is the sole responsibility of the homeowner to confirm building codes and permit requirements for your locale. SunPorch does not guarantee compliance. If required, SunPorch can provide basic engineering documents for an additional cost of \$295.

YES! I have reviewed the product specifications and order details for accuracy.
I hereby acknowledge and accept the terms of my order from SunPorch Structures Inc.

 Signature _____