



Vehicle History Report™

US \$44.99

2014 MITSUBISHI OUTLANDER SE

VIN: JA4AZ3A38EZ001690
4 DOOR WAGON/SPORT UTILITY
2.4L I4 F DOHC 16V GASOLINE
ALL WHEEL DRIVE
Original Window Sticker

Total loss vehicle

22 Service history records

2 Previous owners

Personal vehicle

Last owned in Colorado

124,724 Last reported odometer reading

CARFAX HAS THE MOST ACCIDENT & DAMAGE INFORMATION



This CARFAX Vehicle History Report is based only on information supplied to CARFAX and available as of 8/13/25 at 2:26:07 PM (CDT). Other information about this vehicle, including problems, may not have been reported to CARFAX. Use this report as one important tool, along with a vehicle inspection and test drive, to make a better decision about your next used car.



Accident / Damage History

Not all accidents / issues are reported to CARFAX

Event 1

02/26/2018

Accident reported: minor to moderate damage

- Involving front or side impact
- Airbags did not deploy

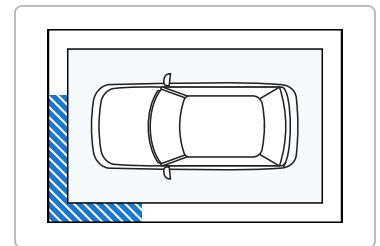
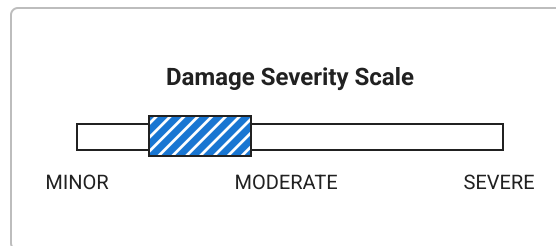

Event 2

06/14/2022

Damage reported: minor damage

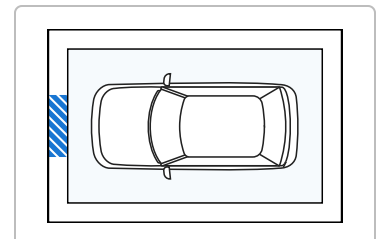
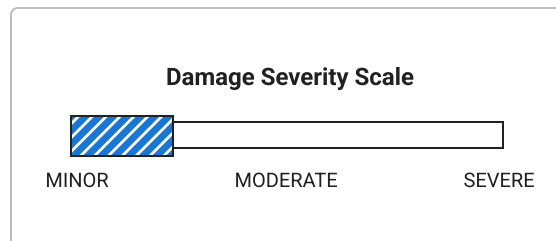

Event 3

06/17/2025

TOTAL LOSS VEHICLE

- Vehicle declared a total loss by an insurance company
- Non-collision damage reported

Event 4

06/25/2025

Hail damage reported: moderate damage

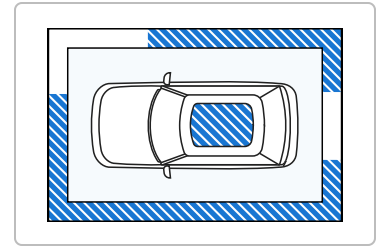
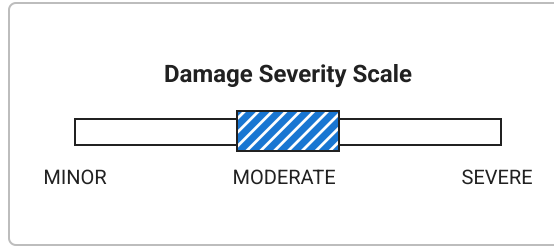

Recent Service Highlights

Key services performed in the last 12 months

Service & Comments	Service	Comments	View Details Links
Flashes	Antifreeze/coolant flushed/changed	04/21/2025	View Details >
 <div style="border: 1px solid blue; padding: 5px; display: inline-block;"> <p>This car has been recently serviced. That's a good thing!</p> </div>			



Additional History

Not all accidents / issues are reported to CARFAX





	Owner 1	Owner 2
Total Loss Total Loss Reported: 06/17/2025.	No Issues Reported	Total Loss Reported
Structural Damage CARFAX recommends that you have this vehicle inspected by a collision repair specialist.	No Issues Reported	No Issues Reported

Airbag Deployment No airbag deployment reported to CARFAX.	<input checked="" type="checkbox"/> No Issues Reported	<input checked="" type="checkbox"/> No Issues Reported
Odometer Check No indication of an odometer rollback.	<input checked="" type="checkbox"/> No Issues Indicated	<input checked="" type="checkbox"/> No Issues Indicated
Accident / Damage Accident reported: 02/26/2018. Damage reported: 06/14/2022. Hail damage reported: 06/25/2025.	Accident Reported	Damage Reported
Manufacturer Recall No open recalls reported to CARFAX.	<input checked="" type="checkbox"/> No Recalls Reported	<input checked="" type="checkbox"/> No Recalls Reported
Basic Warranty Original warranty estimated to have expired.	Warranty Expired	Warranty Expired









CARFAX Title History CARFAX guarantees the information in this section	Owner 1	Owner 2
Damage Brands Salvage Junk Rebuilt Fire Flood Hail Lemon	<input checked="" type="checkbox"/> Guaranteed No Problem	<input checked="" type="checkbox"/> Guaranteed No Problem
Odometer Brands Not Actual Mileage Exceeds Mechanical Limits	<input checked="" type="checkbox"/> Guaranteed No Problem	<input checked="" type="checkbox"/> Guaranteed No Problem
 GUARANTEED - None of these title problems were reported by a U.S. state Department of Motor Vehicles (DMV). If you find that any of these title problems were reported by a DMV and not included in this report, you may qualify. View Terms View Certificate		

CARFAX Ownership History The number of owners is estimated	Owner 1	Owner 2
Year purchased	2014	2019
Type of owner	Personal	Personal
Estimated length of ownership	4 yrs. 8 mo.	6 years
Owned in the following states/provinces	Colorado	Colorado
Estimated miles driven per year	11,382/yr	11,840/yr
Last reported odometer reading	54,670	124,724

CARFAX Detailed History		
 Owner 1 Purchased: 2014		Personal Vehicle 11,382 mi/yr

Date	Mileage	Source	Comments
04/22/2013		Mitsubishi Motors mitsubishicars.com	Vehicle manufactured - Copper exterior - Black interior Original Window Sticker
06/02/2013		Mitsubishi Motors mitsubishicars.com	Vehicle shipped to original dealer in Denver, CO
06/05/2013		Skyline Mitsubishi Denver, CO 303-465-5512 skylinemitsubishi.com ★ 4.4 / 5.0 199 Verified Reviews Customer Favorites ❤️ 3,690	Vehicle offered for sale
06/06/2013	6	Skyline Mitsubishi Denver, CO 303-465-5512 skylinemitsubishi.com ★ 4.4 / 5.0 199 Verified Reviews Customer Favorites ❤️ 3,690	 Vehicle serviced - Pre-delivery inspection completed - Vehicle washed/detailed
07/24/2013	12	Skyline Mitsubishi Denver, CO 303-465-5512 skylinemitsubishi.com ★ 4.4 / 5.0 199 Verified Reviews Customer Favorites ❤️ 3,690	 Vehicle serviced - Trim checked
08/12/2013		Skyline Mitsubishi Denver, CO 303-465-5512 skylinemitsubishi.com ★ 4.4 / 5.0 199 Verified Reviews Customer Favorites ❤️ 3,690	 Vehicle serviced - Trim checked
12/09/2013	85	O'Meara Ford Center Northglenn, CO 303-254-5000 omearaford.com ★ 4.4 / 5.0 321 Verified Reviews	 Vehicle serviced

 **2,682** Customer Favorites

12/17/2013		Skyline Mitsubishi Denver, CO 303-465-5512 skylinemitsubishi.com ★ 4.4 / 5.0 199 Verified Reviews  3,690 Customer Favorites	 Vehicle serviced - Trim checked
07/26/2014	97	Colorado Motor Vehicle Dept.	Vehicle purchase reported
08/01/2014	246	Skyline Mitsubishi Denver, CO 303-465-5512 skylinemitsubishi.com ★ 4.4 / 5.0 199 Verified Reviews  3,690 Customer Favorites	 Vehicle serviced - Electrical system checked
08/18/2014		Colorado Motor Vehicle Dept. Commerce City, CO Title #12W754417	Title issued or updated - First owner reported - Titled or registered as personal vehicle - Loan or lien reported
09/24/2014		Colorado Motor Vehicle Dept. Commerce City, CO Title #12W754417	Registration issued or renewed - Loan or lien reported
02/19/2015	8,545	Mitsubishi Motorcars mitsubishicars.com ★ 4.4 / 5.0 199 Verified Reviews  3,690 Customer Favorites	 Vehicle serviced - Oil and filter changed
10/30/2015		Colorado Motor Vehicle Dept. Commerce City, CO Title #12W754417	Registration issued or renewed - Loan or lien reported
11/11/2015	16,337	Skyline Mitsubishi Denver, CO 303-465-5512 skylinemitsubishi.com ★ 4.4 / 5.0 199 Verified Reviews  3,690 Customer Favorites	 Vehicle serviced - Maintenance inspection completed - Oil and filter changed - Tire condition and pressure checked

07/29/2016 24,988

Skyline Mitsubishi
Denver, CO
303-465-5512
skylinemitsubishi.com

★ 4.4 / 5.0

199 Verified Reviews

♥ 3,690 Customer Favorites



Vehicle serviced

- Maintenance inspection completed
- Oil and filter changed
- Tire condition and pressure checked

10/18/2016

Colorado
Motor Vehicle Dept.
Commerce City, CO
Title #12W754417

Registration issued or renewed

- Loan or lien reported

07/05/2017 35,707

Skyline Mitsubishi
Denver, CO
303-465-5512
skylinemitsubishi.com

★ 4.4 / 5.0

199 Verified Reviews

♥ 3,690 Customer Favorites



Vehicle serviced

- Maintenance inspection completed
- Oil and filter changed
- Tire condition and pressure checked

10/30/2017

Colorado
Motor Vehicle Dept.
Commerce City, CO
Title #12W754417

Registration issued or renewed

- Title or registration issued
- Loan or lien reported

02/26/2018

Damage Report



Accident reported: minor to moderate damage

- Involving front or side impact
- Damage to left front
- Damage to front
- Airbags did not deploy



Damage Severity Scale



Damage Location





FRONT

LEFT

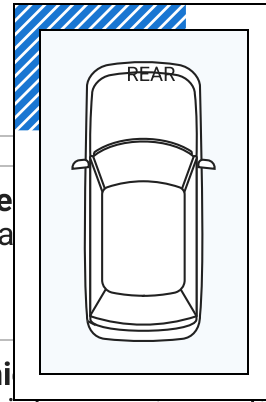
RIGHT

CARFAX HAS THE MOST ACCIDENT & DAMAGE INFORMATION







10/31/2018	Colorado Motor Vehicle Dept. Commerce City, CO Title #12W754417	Title - Loan	ued
03/29/2019	53,331 Skyline Mitsubishi Denver, CO 303-465-5512 skylinemitsubishi.com ★ 4.4 / 5.0 199 Verified Reviews ♥ 3,690 Customer Favorites	 Vehi	- Maintenance inspection completed - Oil and filter changed - Tire condition and pressure checked
03/30/2019	Dealer Inventory	Vehicle offered for sale	
04/16/2019	Skyline Mitsubishi Denver, CO 303-465-5512 skylinemitsubishi.com ★ 4.4 / 5.0 199 Verified Reviews ♥ 3,690 Customer Favorites	 Vehicle serviced	- Pre-delivery inspection completed - Electrical system checked - Fluids checked - Oil and filter changed - Windshield washer checked
05/02/2019	Skyline Mitsubishi Denver, CO 303-465-5512 skylinemitsubishi.com ★ 4.4 / 5.0 199 Verified Reviews ♥ 3,690 Customer Favorites	 Vehicle serviced	- Vehicle washed/detailed
06/15/2019	53,339 Skyline Mitsubishi Denver, CO 303-465-5512 skylinemitsubishi.com ★ 4.4 / 5.0 199 Verified Reviews ♥ 3,690 Customer Favorites	Vehicle sold	
06/15/2019	Colorado Motor Vehicle Dept.	Vehicle purchase reported	
07/12/2019	54,670 Skyline Mitsubishi Denver, CO 303-465-5512 skylinemitsubishi.com	 Vehicle serviced	

★ 4.4 / 5.0
199 Verified Reviews
♥ 3,690 Customer Favorites

Owner 2
Purchased: 2019

Personal Vehicle
11,840 mi/yr

Date	Mileage	Source	Comments
07/23/2019		Colorado Motor Vehicle Dept. Denver, CO Title #002139072	Registration issued or renewed - Title or registration issued - New owner reported - Loan or lien reported
10/18/2019	59,456	Skyline Mitsubishi Denver, CO 303-465-5512 skylinemitsubishi.com ★ 4.4 / 5.0 199 Verified Reviews ♥ 3,690 Customer Favorites	 Vehicle serviced - Maintenance inspection completed - Oil and filter changed - Tire condition and pressure checked
03/05/2020	65,858	Skyline Mitsubishi Denver, CO 303-465-5512 skylinemitsubishi.com ★ 4.4 / 5.0 199 Verified Reviews ♥ 3,690 Customer Favorites	 Vehicle serviced - Maintenance inspection completed - Oil and filter changed - Tire condition and pressure checked - Tires rotated
11/05/2020	77,437	Skyline Mitsubishi Denver, CO 303-465-5512 skylinemitsubishi.com ★ 4.4 / 5.0 199 Verified Reviews ♥ 3,690 Customer Favorites	 Vehicle serviced - Maintenance inspection completed - Oil and filter changed - Tire condition and pressure checked
12/17/2020	78,994	AutoMart USA Aurora, CO 303-438-4000 denverautomart.com ★ 4.2 / 5.0 38 Verified Reviews ♥ 1 Customer Favorite	 Vehicle serviced - Maintenance inspection completed
01/14/2021	80,350	Skyline Mitsubishi Denver, CO 303-465-5512 skylinemitsubishi.com	 Vehicle serviced - Maintenance inspection completed - Oil and filter changed - Tire condition and pressure checked

★ 4.4 / 5.0
199 Verified Reviews
♥ 3,690 Customer Favorites

- Tires rotated

02/08/2021 Colorado
Motor Vehicle Dept.
Denver, CO
Title #002139072

Registration issued or renewed
- Loan or lien reported

12/14/2021 101,234 Sumner Automotive
Repair
Milliken, CO
970-587-9322



Vehicle serviced

★ 5.0 / 5.0
16 Verified Reviews
♥ 22 Customer Favorites

01/31/2022 105,078 Colorado
Inspection Station

Passed emissions inspection

01/31/2022 Colorado
Motor Vehicle Dept.
Milliken, CO
Title #002139072

Registration issued or renewed
- Loan or lien reported
- Registration updated when owner moved the vehicle to a new location





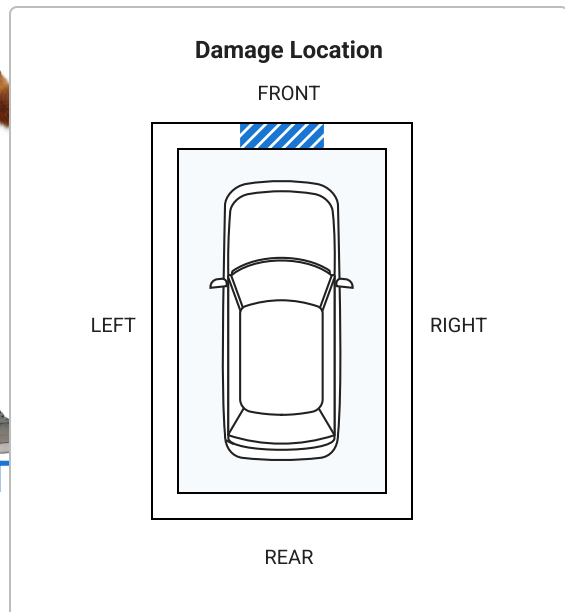
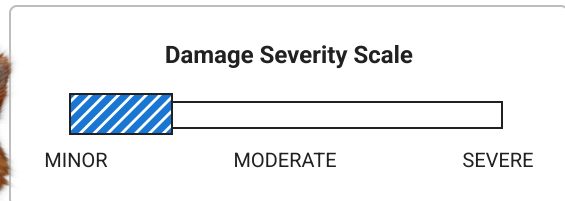

06/14/2022 Damage Report



Damage reported: minor damage
- Damage to front



**CARFAX HAS THE MOST
ACCIDENT & DAMAGE
INFORMATION**

07/15/2022 113,979	Sumner Automotive Repair Milliken, CO 970-587-9322 ★ 5.0 / 5.0 16 Verified Reviews ❤️ 22 Customer Favorites	 Vehicle serviced - A/C system checked - A/C system serviced - Refrigerant added for leak check checked
09/09/2022	Colorado Motor Vehicle Dept. Milliken, CO Title #002139072	Registration issued or renewed - Loan or lien reported
04/21/2025	Champa Auto Repair Denver, CO 720-518-1272 champaautorepair.com/ ★ 4.3 / 5.0 20 Verified Reviews ❤️ 1 Customer Favorite	 Vehicle serviced - Antifreeze/coolant flushed/changed
04/21/2025 124,724	Colorado Inspection Station	Passed emissions inspection
04/25/2025	Colorado Motor Vehicle Dept. Milliken, CO Title #002139072	Registration issued or renewed - Loan or lien reported
06/17/2025	Damage Report 	 TOTAL LOSS VEHICLE - Vehicle declared a total loss by an insurance company - Non-collision damage reported <div style="border: 1px solid blue; padding: 5px;"> <p>There are many reasons an insurance company will declare a vehicle a total loss. Have this vehicle inspected by a qualified technician before you buy. Learn More</p> </div>
06/25/2025	Damage Report	 Hail damage reported: moderate damage - Damage to front - Damage to left rear - Damage to right rear - Damage to roof - Damage to left front - Damage to left side - Damage to right side <div style="border: 1px solid gray; padding: 10px; text-align: center;"> <p>Damage Severity Scale</p>  </div>



MINOR MODERATE SEVERE

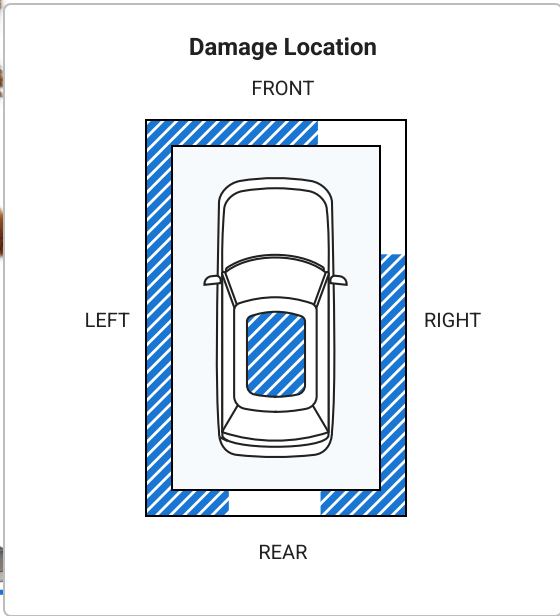

CARFAX HAS THE MOST ACCIDENT & DAMAGE INFORMATION

07/17/2025	Colorado Motor Vehicle Dept. Milliken, CO Title #013984279	Title issued or updated - Loan or lien reported
08/07/2025	Auto Auction	Vehicle sold

Have Questions? Consumers, please visit our Help Center at www.carfax.com. Dealers or Subscribers, please visit our Help Center at www.carfaxonline.com.



Glossary

Accident Indicator

CARFAX receives information about accidents in all 50 states, the District of Columbia and Canada.

Not every accident is reported to CARFAX. As details about the accident become available, those additional details are added to the CARFAX Vehicle History Report. CARFAX recommends that you have this vehicle inspected by a qualified mechanic.

- According to the National Safety Council, Injury Facts, 2021 edition, 5% of the 276 million registered vehicles in the U.S. were involved in an accident in 2019. Over 77% of these were considered minor or moderate.
- This CARFAX Vehicle History Report is based only on information supplied to CARFAX and available as of 8/13/25 at 2:26:07 PM (CDT). Other information about this vehicle, including problems, may not have been reported to CARFAX. Use this report as one important tool, along with a vehicle inspection and test drive, to make a better decision about your next used car.

Damage Indicator

Damage can be a result of many different types of events. Examples include contact with objects (other cars, trees, traffic signs, road debris, etc), vandalism, or weather-related events. Not every damage event is reported to CARFAX. As details about the damage event become available, those additional details are added to the CARFAX Vehicle History Report. CARFAX recommends that you have this vehicle inspected by a qualified mechanic.

- This CARFAX Vehicle History Report is based only on information supplied to CARFAX and available as of 8/13/25 at 2:26:07 PM (CDT). Other information about this vehicle, including problems, may not have been reported to CARFAX. Use this report as one important tool, along with a vehicle inspection and test drive, to make a better decision about your next used car.

Damage Severity

Damage events result in one of the following severity levels:

- **Minor:** Generally, minor damage is cosmetic (including dents or scratches), may only require reconditioning, and typically does not compromise a vehicle's operation and/or safety.
- **Moderate:** Moderate damage may affect multiple components of the vehicle and may impair the vehicle's operation and/or safety.
- **Severe:** Severe damage usually affects multiple components of the vehicle and is likely to compromise the vehicle's operation and/or safety.

CARFAX recommends getting a pre-purchase inspection at a certified collision repair facility.

First Owner

When the first owner(s) obtains a title from a Department of Motor Vehicles as proof of ownership.

New Owner Reported

When a vehicle is sold to a new owner, the Title must be transferred to the new owner(s) at a Department of Motor Vehicles.

Ownership History



CARFAX defines an owner as an individual or business that possesses and uses a vehicle. Not all title transactions represent changes in ownership. To provide estimated number of owners, CARFAX proprietary technology analyzes all the events in a vehicle history. Estimated ownership is available for vehicles manufactured after 1991 and titled solely in the US including Puerto Rico. Dealers sometimes opt to take ownership of a vehicle and are required to in the following states: Maine, Massachusetts, New Jersey, Ohio, Oklahoma, Pennsylvania and South Dakota. Please consider this as you review a vehicle's estimated ownership history.

Title Issued

A state issues a title to provide a vehicle owner with proof of ownership. Each title has a unique number. Each title or registration record on a CARFAX report does not necessarily indicate a change in ownership. In Canada, a registration and bill of sale are used as proof of ownership.

Total Loss Vehicle

An insurance or fleet company declares a vehicle a total loss when a claim exceeds approximately 75% of its pre-damage value or if the vehicle is stolen and not recovered. This damage threshold varies by company. These companies typically take possession and obtain the title. Not all total loss vehicles result in a DMV-reported branded title. This may occur when an insurance company's definition of a total loss is different than the state DMV's definition for a branded title or when the owner of the vehicle is a self-insured company, like a fleet or rental company.

Follow Us:  facebook.com/CARFAX  [@CARFAXinc](https://twitter.com/CARFAXinc)  [About CARFAX](#)

CARFAX DEPENDS ON ITS SOURCES FOR THE ACCURACY AND RELIABILITY OF ITS INFORMATION. THEREFORE, NO RESPONSIBILITY IS ASSUMED BY CARFAX OR ITS AGENTS FOR ERRORS OR OMISSIONS IN THIS REPORT. CARFAX FURTHER EXPRESSLY DISCLAIMS ALL WARRANTIES, EXPRESS OR IMPLIED, INCLUDING ANY IMPLIED WARRANTIES OF MERCHANTABILITY OR FITNESS FOR A PARTICULAR PURPOSE.

© 2025 CARFAX, Inc., part of S&P Global. All rights reserved.
8/13/25 2:26:07 PM (CDT)

I have reviewed and received a copy of the CARFAX Vehicle History Report for this 2014 MITSUBISHI OUTLANDER vehicle (VIN: JA4AZ3A38EZ001690), which is based on information supplied to CARFAX and available as of 8/13/25 at 3:26 PM (EDT).

Customer Signature

Date

Dealer Signature

Date